

FCC Test Report

Report No.: RF190806C06-2

FCC ID: 2AQYEFMP172

Test Model: F-01M

Received Date: Aug. 06, 2019

Test Date: Aug. 17 ~ Sep. 02, 2019

Issued Date: Sep. 10, 2019

Applicant: FUJITSU CONNECTED TECHNOLOGIES Ltd.

Address: Chuorinkan 7-10-1 Yamato, Kanagawa 242-0007, Japan

Issued By: Bureau Veritas Consumer Products Services (H.K.) Ltd., Taoyuan Branch
Lin Kou Laboratories

Lab Address: No. 47-2, 14th Ling, Chia Pau Vil., Lin Kou Dist., New Taipei City, Taiwan

Test Location: No.19, Hwa Ya 2nd Rd., Wen Hwa Vil., Kwei Shan Dist., Taoyuan City
33383, Taiwan

**FCC Registration /
Designation Number:** 788550 / TW0003



This report is for your exclusive use. Any copying or replication of this report to or for any other person or entity, or use of our name or trademark, is permitted only with our prior written permission. This report sets forth our findings solely with respect to the test samples identified herein. The results set forth in this report are not indicative or representative of the quality or characteristics of the lot from which a test sample was taken or any similar or identical product unless specifically and expressly noted. Our report includes all of the tests requested by you and the results thereof based upon the information that you provided to us. You have 60 days from date of issuance of this report to notify us of any material error or omission caused by our negligence, provided, however, that such notice shall be in writing and shall specifically address the issue you wish to raise. A failure to raise such issue within the prescribed time shall constitute your unqualified acceptance of the completeness of this report, the tests conducted and the correctness of the report contents. Unless specific mention, the uncertainty of measurement has been explicitly taken into account to declare the compliance or non-compliance to the specification. The report must not be used by the client to claim product certification, approval, or endorsement by TAF or any government agencies.

Table of Contents

Release Control Record	4
1 Certificate of Conformity	5
2 Summary of Test Results.....	6
2.1 Measurement Uncertainty.....	6
2.2 Modification Record	6
3 General Information	7
3.1 General Description of EUT	7
3.2 Description of Test Modes.....	8
3.2.1 Test Mode Applicability and Tested Channel Detail.....	9
3.3 Duty Cycle of Test Signal	10
3.4 Description of Support Units	11
3.4.1 Configuration of System under Test	11
3.5 General Description of Applied Standards.....	11
4 Test Types and Results.....	12
4.1 Radiated Emission and Bandedge Measurement	12
4.1.1 Limits of Radiated Emission and Bandedge Measurement	12
4.1.2 Test Instruments	13
4.1.3 Test Procedures.....	14
4.1.4 Deviation from Test Standard	14
4.1.5 Test Set Up	15
4.1.6 EUT Operating Conditions.....	16
4.1.7 Test Results	17
4.2 Conducted Emission Measurement.....	22
4.2.1 Limits of Conducted Emission Measurement	22
4.2.2 Test Instruments	22
4.2.3 Test Procedures.....	22
4.2.4 Deviation from Test Standard	23
4.2.5 Test Setup.....	23
4.2.6 EUT Operating Conditions.....	23
4.2.7 Test Results	24
4.3 6 dB Bandwidth Measurement.....	26
4.3.1 Limits of 6 dB Bandwidth Measurement.....	26
4.3.2 Test Setup.....	26
4.3.3 Test Instruments	26
4.3.4 Test Procedure	26
4.3.5 Deviation from Test Standard	26
4.3.6 EUT Operating Conditions.....	26
4.3.7 Test Results	27
4.4 Occupied Bandwidth Measurement.....	28
4.4.1 Test Setup.....	28
4.4.2 Test Instruments	28
4.4.3 Test Procedure	28
4.4.4 Deviation from Test Standard	28
4.4.5 EUT Operating Conditions.....	28
4.4.6 Test Results	29
4.5 Conducted Output Power Measurement	30
4.5.1 Limits of Conducted Output Power Measurement.....	30
4.5.2 Test Setup.....	30
4.5.3 Test Instruments	30
4.5.4 Test Procedures.....	30
4.5.5 Deviation from Test Standard	30
4.5.6 EUT Operating Conditions.....	30
4.5.7 Test Results	30

4.6	Power Spectral Density Measurement	31
4.6.1	Limits of Power Spectral Density Measurement.....	31
4.6.2	Test Setup.....	31
4.6.3	Test Instruments	31
4.6.4	Test Procedure	31
4.6.5	Deviation from Test Standard	31
4.6.6	EUT Operating Condition	31
4.6.7	Test Results	32
4.7	Conducted Out of Band Emission Measurement	33
4.7.1	Limits of Conducted Out of Band Emission Measurement.....	33
4.7.2	Test Setup.....	33
4.7.3	Test Instruments	33
4.7.4	Test Procedure	33
4.7.5	Deviation from Test Standard	33
4.7.6	EUT Operating Condition	33
4.7.7	Test Results	34
5	Pictures of Test Arrangements.....	36
	Appendix – Information of the Testing Laboratories	37

Release Control Record

Issue No.	Description	Date Issued
RF190806C06-2	Original Release	Sep. 10, 2019

1 Certificate of Conformity

Product: Feature Phone

Brand: FUJITSU

Test Model: F-01M

Sample Status: Engineering Sample

Applicant: FUJITSU CONNECTED TECHNOLOGIES Ltd.

Test Date: Aug. 17 ~ Sep. 02, 2019

Standards: 47 CFR FCC Part 15, Subpart C (Section 15.247)
ANSI C63.10:2013

The above equipment has been tested by **Bureau Veritas Consumer Products Services (H.K.) Ltd., Taoyuan Branch**, and found compliance with the requirement of the above standards. The test record, data evaluation & Equipment Under Test (EUT) configurations represented herein are true and accurate accounts of the measurements of the sample's RF characteristics under the conditions specified in this report.

Prepared by : Gina Liu, **Date:** Sep. 10, 2019
Gina Liu / Specialist

Approved by : Dylan Chiou, **Date:** Sep. 10, 2019
Dylan Chiou / Project Engineer

2 Summary of Test Results

47 CFR FCC Part 15, Subpart C (Section 15.247)			
FCC Clause	Test Item	Result	Remarks
15.207	AC Power Conducted Emission	Pass	Meet the requirement of limit. Minimum passing margin is -24.97 dB at 1.14312 MHz.
15.205 & 209	Radiated Emissions	Pass	Meet the requirement of limit. Minimum passing margin is -6.51 dB at 79.47 MHz.
15.247(d)	Band Edge Measurement	Pass	Meet the requirement of limit.
15.247(d)	Antenna Port Emission	Pass	Meet the requirement of limit.
15.247(a)(2)	6 dB Bandwidth	Pass	Meet the requirement of limit.
---	Occupied Bandwidth Measurement	Pass	Reference only
15.247(b)	Conducted Power	Pass	Meet the requirement of limit.
15.247(e)	Power Spectral Density	Pass	Meet the requirement of limit.
15.203	Antenna Requirement	Pass	No antenna connector is used.

Note: Determining compliance based on the results of the compliance measurement, not taking into account measurement instrumentation uncertainty.

2.1 Measurement Uncertainty

Where relevant, the following measurement uncertainty levels have been estimated for tests performed on the EUT as specified in CISPR 16-4-2:

Measurement	Frequency	Expanded Uncertainty (k=2) (\pm)
Conducted Emissions at mains ports	150 kHz ~ 30 MHz	2.44 dB
Radiated Emissions up to 1 GHz	9 kHz ~ 30 MHz	3.04 dB
	30 MHz ~ 200 MHz	2.93 dB
	200 MHz ~ 1000 MHz	2.95 dB
Radiated Emissions above 1 GHz	1 GHz ~ 18 GHz	2.26 dB
	18 GHz ~ 40 GHz	1.94 dB

2.2 Modification Record

There were no modifications required for compliance.

3 General Information

3.1 General Description of EUT

Product	Feature Phone
Brand	FUJITSU
Test Model	F-01M
Status of EUT	Engineering Sample
Power Supply Rating	5.0 Vdc (adapter or host equipment) 3.8 Vdc (Li-ion battery)
Modulation Type	GFSK
Transfer Rate	1 Mbps
Operating Frequency	2402 ~ 2480 MHz
Number of Channel	40
Output Power	1.268 mW
Antenna Type	Monopole antenna with -1.0 dBi gain
Antenna Connector	N/A
Accessory Device	Refer to Note as below
Data Cable Supplied	N/A

Note:

1. The EUT contains following accessory devices.

Product	Brand	Model	Description
Adapter (Optional)	FUJITSU LIMITED	FMV-AC346	I/P: 100-240 Vac, 50/60 Hz, 0.3 A O/P: 5 Vdc, 2 A
Battery	FUJITSU LIMITED	CA54310-0078	3.8 Vdc, 1500 mAh
Cradle	FUJITSU LIMITED	F49	O/P: 5 Vdc, 1.5 A

2. The above EUT information is declared by manufacturer and for more detailed features description, please refers to the manufacturer's specifications or User's Manual.

3.2 Description of Test Mdes

40 channels are provided to this EUT:

Channel	Freq. (MHz)	Channel	Freq. (MHz)	Channel	Freq. (MHz)	Channel	Freq. (MHz)
0	2402	10	2422	20	2442	30	2462
1	2404	11	2424	21	2444	31	2464
2	2406	12	2426	22	2446	32	2466
3	2408	13	2428	23	2448	33	2468
4	2410	14	2430	24	2450	34	2470
5	2412	15	2432	25	2452	35	2472
6	2414	16	2434	26	2454	36	2474
7	2416	17	2436	27	2456	37	2476
8	2418	18	2438	28	2458	38	2478
9	2420	19	2440	29	2460	39	2480

3.2.1 Test Mode Applicability and Tested Channel Detail

EUT Configure Mode	Applicable To				Description
	RE \geq 1G	RE<1G	PLC	APCM	
-	√	√	√	√	-

Where **RE \geq 1G**: Radiated Emission above 1 GHz **RE<1G**: Radiated Emission below 1 GHz
PLC: Power Line Conducted Emission **APCM**: Antenna Port Conducted Measurement

Note: The EUT had been pre-tested on the positioned of each 3 axis. The worst case was found when positioned on **X-plane**.
Note: “-” means no effect.

Radiated Emission Test (Above 1 GHz):

- Pre-Scan has been conducted to determine the worst-case mode from all possible combinations between available modulations, data rates and antenna ports (if EUT with antenna diversity architecture).
- Following channel(s) was (were) selected for the final test as listed below.

EUT Configure Mode	Available Channel	Tested Channel	Modulation Type	Data Rate (Mbps)
-	0 to 39	0, 19, 39	GFSK	1

Radiated Emission Test (Below 1 GHz):

- Pre-Scan has been conducted to determine the worst-case mode from all possible combinations between available modulations, data rates and antenna ports (if EUT with antenna diversity architecture).
- Following channel(s) was (were) selected for the final test as listed below.

EUT Configure Mode	Available Channel	Tested Channel	Modulation Type	Data Rate (Mbps)
-	0 to 39	0	GFSK	1

Power Line Conducted Emission Test:

- Pre-Scan has been conducted to determine the worst-case mode from all possible combinations between available modulations, data rates and antenna ports (if EUT with antenna diversity architecture).
- Following channel(s) was (were) selected for the final test as listed below.

EUT Configure Mode	Available Channel	Tested Channel	Modulation Type	Data Rate (Mbps)
-	0 to 39	0	GFSK	1

Antenna Port Conducted Measurement:

- This item includes all test value of each mode, but only includes spectrum plot of worst value of each mode.
- Pre-Scan has been conducted to determine the worst-case mode from all possible combinations between available modulations, data rates and antenna ports (if EUT with antenna diversity architecture).
- Following channel(s) was (were) selected for the final test as listed below.

EUT Configure Mode	Available Channel	Tested Channel	Modulation Type	Data Rate (Mbps)
-	0 to 39	0, 19, 39	GFSK	1

Test Condition:

Applicable To	Environmental Conditions	Input Power	Tested by
RE \geq 1G	25 deg. C, 65 % RH	120 Vac, 60 Hz	Thomas Wei
RE $<$ 1G	25 deg. C, 65 % RH	120 Vac, 60 Hz	Tim Chen
PLC	25 deg. C, 65 % RH	120 Vac, 60 Hz	Thomas Wei
APCM	25 deg. C, 65 % RH	3.8 Vdc	Getaz Yang

3.3 Duty Cycle of Test Signal

Duty cycle = $0.839/1.076 = 0.78$, Duty factor = $10 * \log(1/0.78) = 1.08$

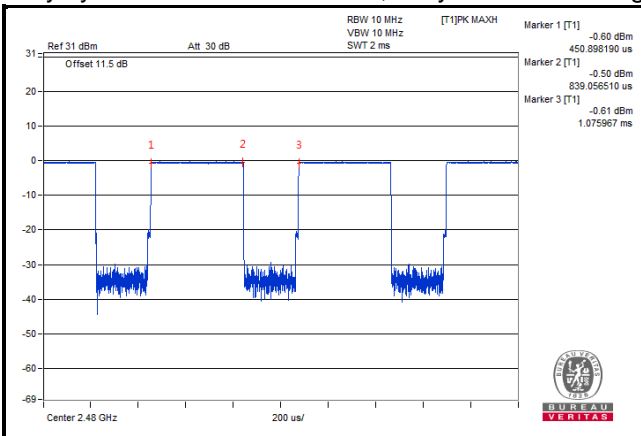

3.4 Description of Support Units

The EUT has been tested as an independent unit together with other necessary accessories or support units.

3.4.1 Configuration of System under Test

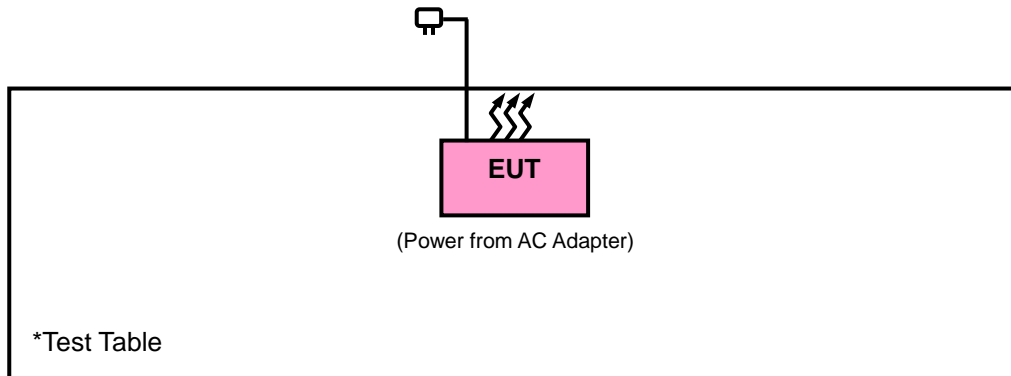

3.5 General Description of Applied Standards

The EUT is a RF Product. According to the specifications of the manufacturer, it must comply with the requirements of the following standards:

FCC Part 15, Subpart C (15.247)

KDB 558074 D01 15.247 Meas Guidance v05r02

ANSI C63.10-2013

All test items have been performed and recorded as per the above standards.

4 Test Types and Results

4.1 Radiated Emission and Bandedge Measurement

4.1.1 Limits of Radiated Emission and Bandedge Measurement

Radiated emissions which fall in the restricted bands must comply with the radiated emission limits specified as below table. Other emissions shall be at least 20 dB below the highest level of the desired power:

Frequencies (MHz)	Field Strength (microvolts/meter)	Measurement Distance (meters)
0.009 ~ 0.490	2400/F (kHz)	300
0.490 ~ 1.705	24000/F (kHz)	30
1.705 ~ 30.0	30	30
30 ~ 88	100	3
88 ~ 216	150	3
216 ~ 960	200	3
Above 960	500	3

Note:

1. The lower limit shall apply at the transition frequencies.
2. Emission level (dBuV/m) = 20 log Emission level (uV/m).
3. For frequencies above 1000 MHz, the field strength limits are based on average detector, however, the peak field strength of any emission shall not exceed the maximum permitted average limits, specified above by more than 20 dB under any condition of modulation.

4.1.2 Test Instruments

Description & Manufacturer	Model No.	Serial No.	Date of Calibration	Due Date of Calibration
Test Receiver Agilent	N9038A	MY51210203	Mar. 18, 2019	Mar. 17, 2020
Spectrum Analyzer Agilent	N9010A	MY52220314	Dec. 13, 2018	Dec. 12, 2019
Spectrum Analyzer ROHDE & SCHWARZ	FSU43	101261	Apr. 15, 2019	Apr. 14, 2020
HORN Antenna SCHWARZBECK	BBHA 9120D	9120D-969	Nov. 25, 2018	Nov. 24, 2019
BILOG Antenna SCHWARZBECK	VULB 9168	9168-472	Nov. 23, 2018	Nov. 22, 2019
Fixed Attenuator WORKEN	MDCS18N-10	MDCS18N-10-01	Apr. 15, 2019	Apr. 14, 2020
Loop Antenna	EM-6879	269	Sep. 07, 2018	Sep. 06, 2019
Preamplifier EMCI	EMC001340	980201	Oct. 12, 2018	Oct. 11, 2019
Bluetooth Tester	CBT	100946	Aug. 09, 2018	Aug. 08, 2020
Preamplifier EMCI	EMC 012645	980115	Oct. 12, 2018	Oct. 11, 2019
Preamplifier EMCI	EMC 330H	980112	Oct. 12, 2018	Oct. 11, 2019
Power Meter Anritsu	ML2495A	1012010	Sep. 05, 2018	Sep. 04, 2019
Power Sensor Anritsu	MA2411B	1315050	Sep. 04, 2018	Sep. 03, 2019
RF Coaxial Cable HUBER+SUHNNER	EMC104-SM-SM-8 000&3000	140811+170717	Oct. 12, 2018	Oct. 11, 2019
RF Coaxial Cable HUBER+SUHNNER	SUCOFLEX 104	EMC104-SM-SM-1 000(140807)	Oct. 12, 2018	Oct. 11, 2019
RF Coaxial Cable Worken	8D-FB	Cable-Ch10-01	Oct. 12, 2018	Oct. 11, 2019
Boresight Antenna Fixture	FBA-01	FBA-SIP01	NA	NA
Software BV ADT	E3 6.120103	NA	NA	NA
Antenna Tower MF	MFA-440H	NA	NA	NA
Turn Table MF	MFT-201SS	NA	NA	NA
Antenna Tower & Turn Table Controller MF	MF-7802	NA	NA	NA

Note: 1. The calibration interval of the above test instruments is 12 months and the calibrations are traceable to NML/ROC and NIST/USA.

2. The test was performed in HwaYa Chamber 10.

4.1.3 Test Procedures

For Radiated Emission below 30 MHz

- a. The EUT was placed on the top of a rotating table 0.8 meters above the ground at a 3 meter chamber room. The table was rotated 360 degrees to determine the position of the highest radiation.
- b. The EUT was set 3 meters away from the interference-receiving antenna, which was mounted on the top of a variable-height antenna tower.
- c. Parallel, perpendicular, and ground-parallel orientations of the antenna are set to make the measurement.
- d. For each suspected emission, the EUT was arranged to its worst case and the rotatable table was turned from 0 degrees to 360 degrees to find the maximum reading.
- e. The test-receiver system was set to Quasi-Peak Detect Function and Specified Bandwidth with Maximum Hold Mode.

Note:

1. The resolution bandwidth and video bandwidth of test receiver/spectrum analyzer is 9 kHz at frequency below 30 MHz.

For Radiated Emission above 30 MHz

- a. The EUT was placed on the top of a rotating table 0.8 meters (for 30 MHz ~ 1 GHz) / 1.5 meters (for above 1 GHz) above the ground at 3 meter chamber room for test. The table was rotated 360 degrees to determine the position of the highest radiation.
- b. The EUT was set 3 meters away from the interference-receiving antenna, which was mounted on the top of a variable-height antenna tower.
- c. The height of antenna is varied from one meter to four meters above the ground to determine the maximum value of the field strength. Both horizontal and vertical polarizations of the antenna are set to make the measurement.
- d. For each suspected emission, the EUT was arranged to its worst case and then the antenna was tuned to heights from 1 meter to 4 meters and the rotatable table was turned from 0 degrees to 360 degrees to find the maximum reading.
- e. The test-receiver system was set to quasi-peak detect function and specified bandwidth with maximum hold mode when the test frequency is below 1 GHz.
- f. The test-receiver system was set to peak and average detected function and specified bandwidth with maximum hold mode when the test frequency is above 1 GHz. If the peak reading value also meets average limit, measurement with the average detector is unnecessary.

Note:

1. The resolution bandwidth and video bandwidth of test receiver/spectrum analyzer is 120 kHz for Quasi-peak detection (QP) or Peak detection (PK) at frequency below 1 GHz.
2. The resolution bandwidth of test receiver/spectrum analyzer is 1 MHz and the video bandwidth is 3 MHz for Peak detection (PK) at frequency above 1 GHz.
3. The resolution bandwidth of test receiver/spectrum analyzer is 1 MHz and the video bandwidth is $\geq 1/T$ (Duty cycle < 98 %) or 10 Hz (Duty cycle \geq 98 %) for Average detection (AV) at frequency above 1 GHz. (RBW = 1 MHz, VBW = 3 kHz)
4. All modes of operation were investigated and the worst-case emissions are reported.

4.1.4 Deviation from Test Standard

No deviation.

4.1.5 Test Set Up

<Radiated Emission below 30 MHz>

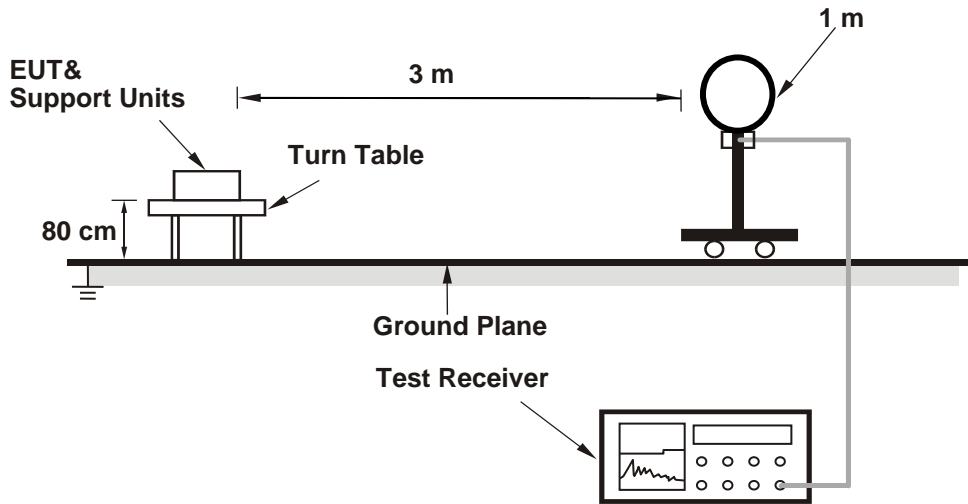

<Radiated Emission 30 MHz to 1 GHz>

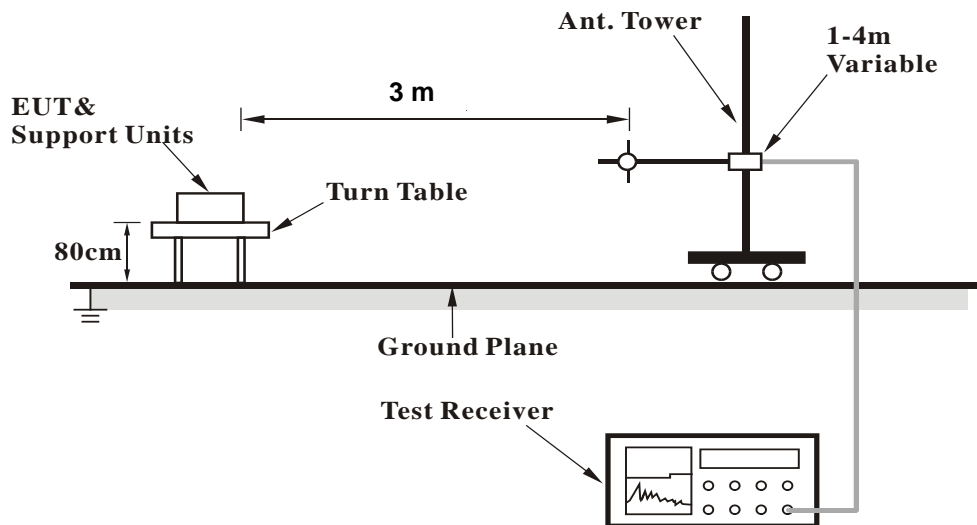

<Radiated Emission above 1 GHz>

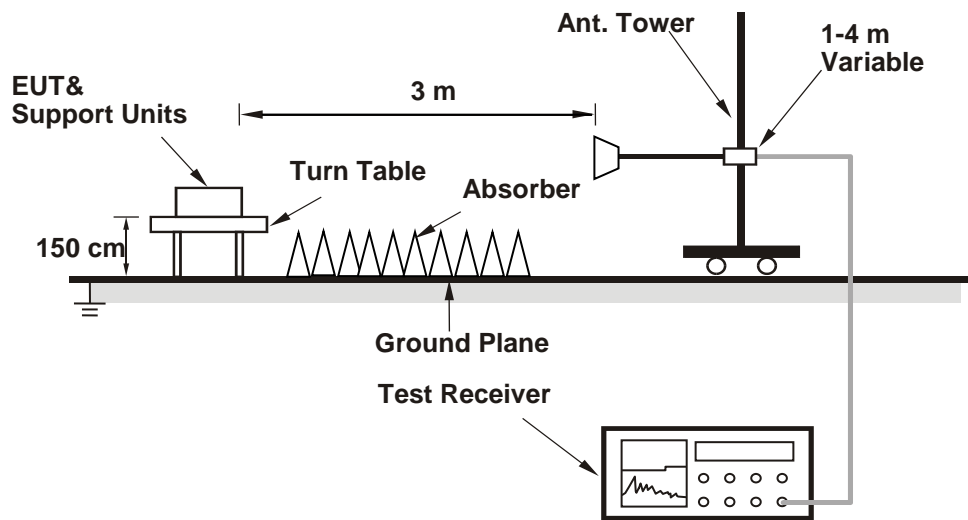

For the actual test configuration, please refer to the attached file (Test Setup Photo).

4.1.6 EUT Operating Conditions

- a. Placed the EUT on the testing table.
- b. Set the EUT under transmission condition continuously at specific channel frequency.

4.1.7 Test Results

Above 1 GHz Data:

EUT Test Condition		Measurement Detail	
Channel	Channel 0	Frequency Range	1 GHz ~ 25 GHz
Input Power	120 Vac, 60 Hz	Detector Function	Peak (PK) Average (AV)
Environmental Conditions	25 deg. C, 65 % RH	Tested By	Thomas Wei

Antenna Polarity & Test Distance: Horizontal at 3 m								
Frequency (MHz)	Emission Level (dBuV/m)	Read Level (dBuV)	Factor (dB/m)	Limit (dBuV/m)	Margin (dB)	Antenna Height (cm)	Table Angle (Degree)	Remark
2363.62	40.82	45.63	-4.81	54	-13.18	155	357	Average
2363.62	47.98	52.79	-4.81	74	-26.02	155	357	Peak
2402	96.54	101.54	-5			155	357	Average
2402	97.38	102.38	-5			155	357	Peak
4804	34.73	49.2	-14.47	54	-19.27	152	194	Average
4804	44.38	58.85	-14.47	74	-29.62	152	194	Peak
Antenna Polarity & Test Distance: Vertical at 3 m								
Frequency (MHz)	Emission Level (dBuV/m)	Read Level (dBuV)	Factor (dB/m)	Limit (dBuV/m)	Margin (dB)	Antenna Height (cm)	Table Angle (Degree)	Remark
2369.92	38.03	42.92	-4.89	54	-15.97	272	321	Average
2369.92	47.01	51.9	-4.89	74	-26.99	272	321	Peak
2402	88.02	93.02	-5			272	321	Average
2402	88.8	93.8	-5			272	321	Peak
4804	35.09	49.56	-14.47	54	-18.91	138	231	Average
4804	44.02	58.49	-14.47	74	-29.98	138	231	Peak

Remarks:

- Emission Level = Read Level + Factor
Margin value = Emission level – Limit value
- 2402 MHz: Fundamental frequency.
- The emission levels of other frequencies were very low against the limit.

EUT Test Condition		Measurement Detail	
Channel	Channel 19	Frequency Range	1 GHz ~ 25 GHz
Input Power	120 Vac, 60 Hz	Detector Function	Peak (PK) Average (AV)
Environmental Conditions	25 deg. C, 65 % RH	Tested By	Thomas Wei

Antenna Polarity & Test Distance: Horizontal at 3 m								
Frequency (MHz)	Emission Level (dBuV/m)	Read Level (dBuV)	Factor (dB/m)	Limit (dBuV/m)	Margin (dB)	Antenna Height (cm)	Table Angle (Degree)	Remark
2440	92.82	97.8	-4.98			127	357	Average
2440	93.66	98.64	-4.98			127	357	Peak
4880	35.15	49.23	-14.08	54	-18.85	147	233	Average
4880	44.98	59.06	-14.08	74	-29.02	147	233	Peak
Antenna Polarity & Test Distance: Vertical at 3 m								
Frequency (MHz)	Emission Level (dBuV/m)	Read Level (dBuV)	Factor (dB/m)	Limit (dBuV/m)	Margin (dB)	Antenna Height (cm)	Table Angle (Degree)	Remark
2440	85.48	90.46	-4.98			291	354	Average
2440	86.35	91.33	-4.98			291	354	Peak
4880	35.44	49.52	-14.08	54	-18.56	146	105	Average
4880	44.35	58.43	-14.08	74	-29.65	146	105	Peak

Remarks:

- Emission Level = Read Level + Factor
Margin value = Emission level – Limit value
- 2440 MHz: Fundamental frequency.
- The emission levels of other frequencies were very low against the limit.

EUT Test Condition		Measurement Detail	
Channel	Channel 39	Frequency Range	1 GHz ~ 25 GHz
Input Power	120 Vac, 60 Hz	Detector Function	Peak (PK) Average (AV)
Environmental Conditions	25 deg. C, 65 % RH	Tested By	Thomas Wei

Antenna Polarity & Test Distance: Horizontal at 3 m								
Frequency (MHz)	Emission Level (dBuV/m)	Read Level (dBuV)	Factor (dB/m)	Limit (dBuV/m)	Margin (dB)	Antenna Height (cm)	Table Angle (Degree)	Remark
2480	93.97	98.82	-4.85			129	357	Average
2480	94.78	99.63	-4.85			129	357	Peak
2484.48	37.79	42.64	-4.85	54	-16.21	129	357	Average
2484.48	47.02	51.87	-4.85	74	-26.98	129	357	Peak
4960	35.52	49.41	-13.89	54	-18.48	152	103	Average
4960	44.47	58.36	-13.89	74	-29.53	152	103	Peak
Antenna Polarity & Test Distance: Vertical at 3 m								
Frequency (MHz)	Emission Level (dBuV/m)	Read Level (dBuV)	Factor (dB/m)	Limit (dBuV/m)	Margin (dB)	Antenna Height (cm)	Table Angle (Degree)	Remark
2480	85.07	89.92	-4.85			267	322	Average
2480	85.84	90.69	-4.85			267	322	Peak
2486.16	37.82	42.67	-4.85	54	-16.18	267	322	Average
2486.16	47.03	51.88	-4.85	74	-26.97	267	322	Peak
4960	35.9	49.79	-13.89	54	-18.1	158	261	Average
4960	44.28	58.17	-13.89	74	-29.72	158	261	Peak

Remarks:

- Emission Level = Read Level + Factor
Margin value = Emission level – Limit value
- 2480 MHz: Fundamental frequency.
- The emission levels of other frequencies were very low against the limit.

9 kHz ~ 30 MHz Data:

The amplitude of spurious emissions attenuated more than 20 dB below the permissible value is not required to be report.

30 MHz ~ 1 GHz Worst-Case Data:

EUT Test Condition		Measurement Detail	
Channel	Channel 0	Frequency Range	30 MHz ~ 1 GHz
Input Power	120 Vac, 60 Hz	Detector Function	Peak (PK) Quasi-peak (QP)
Environmental Conditions	25 deg. C, 65 % RH	Tested By	Tim Chen

Horizontal

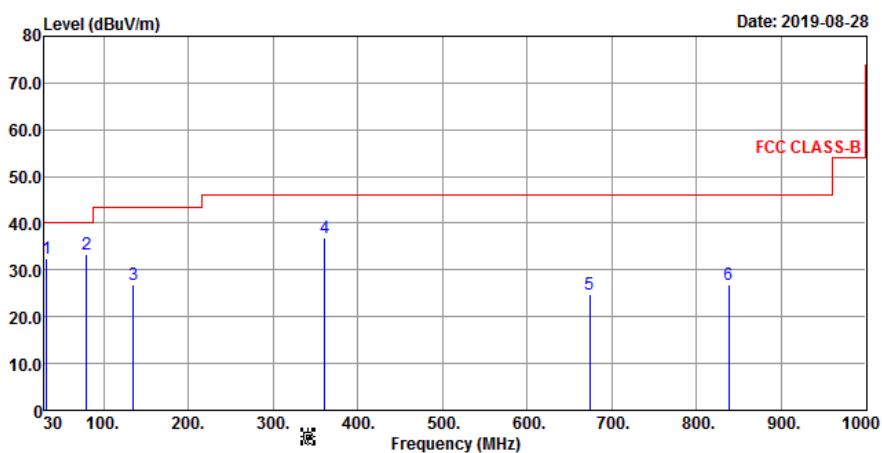

Vertical

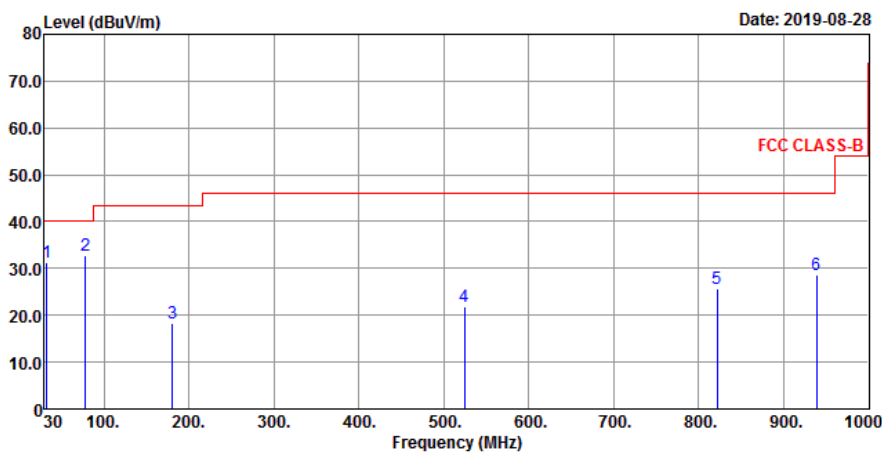

Antenna Polarity & Test Distance: Horizontal at 3 m

Frequency (MHz)	Emission Level (dBuV/m)	Read Level (dBuV)	Factor (dB/m)	Limit (dBuV/m)	Margin (dB)	Antenna Height (cm)	Table Angle (Degree)	Remark
32.91	32.4	50.17	-17.77	40	-7.6	168	231	Peak
79.47	33.49	54.85	-21.36	40	-6.51	202	131	Peak
134.76	26.76	45.01	-18.25	43.5	-16.74	219	177	Peak
360.77	36.93	51.7	-14.77	46	-9.07	184	159	Peak
674.08	24.75	31.91	-7.16	46	-21.25	166	338	Peak
838.01	26.99	31.27	-4.28	46	-19.01	207	101	Peak

Antenna Polarity & Test Distance: Vertical at 3 m

Frequency (MHz)	Emission Level (dBuV/m)	Read Level (dBuV)	Factor (dB/m)	Limit (dBuV/m)	Margin (dB)	Antenna Height (cm)	Table Angle (Degree)	Remark
32.91	31.24	49.01	-17.77	40	-8.76	106	134	Peak
78.5	32.69	54	-21.31	40	-7.31	107	119	Peak
180.35	18.29	36.73	-18.44	43.5	-25.21	106	303	Peak
524.7	21.87	31.79	-9.92	46	-24.13	112	221	Peak
821.52	25.73	30.63	-4.9	46	-20.27	118	25	Peak
938.89	28.53	31.31	-2.78	46	-17.47	139	341	Peak

Remarks:

- Emission Level = Read Level + Factor
Margin value = Emission level – Limit value
- The emission levels of other frequencies were very low against the limit.

4.2 Conducted Emission Measurement

4.2.1 Limits of Conducted Emission Measurement

Frequency (MHz)	Conducted Limit (dBuV)	
	Quasi-Peak	Average
0.15 - 0.5	66 - 56	56 - 46
0.50 - 5.0	56	46
5.0 - 30.0	60	50

- Note: 1. The lower limit shall apply at the transition frequencies.
 2. The limit decreases in line with the logarithm of the frequency in the range of 0.15 to 0.50 MHz.

4.2.2 Test Instruments

Description & Manufacturer	Model No.	Serial No.	Date of Calibration	Due Date of Calibration
Test Receiver ROHDE & SCHWARZ	ESCI	100613	Dec. 10, 2018	Dec. 09, 2019
RF signal cable Woken	5D-FB	Cable-cond1-01	Sep. 05, 2018	Sep. 04, 2019
LISN/AMN ROHDE & SCHWARZ (EUT)	ENV216	101826	Feb. 21, 2019	Feb. 20, 2020
LISN/AMN ROHDE & SCHWARZ (Peripheral)	ESH3-Z5	100311	Aug. 22, 2019	Aug. 21, 2020
Software ADT	BV ADT_Cond_ V7.3.7.4	NA	NA	NA

- Note: 1. The calibration interval of the above test instruments is 12 months and the calibrations are traceable to NML/ROC and NIST/USA.
 2. The test was performed in HwaYa Shielded Room 1.
 3. The VCCI Site Registration No. is C-12040.

4.2.3 Test Procedures

- a. The EUT was placed 0.4 meters from the conducting wall of the shielded room with EUT being connected to the power mains through a line impedance stabilization network (LISN). Other support units were connected to the power mains through another LISN. The two LISNs provide 50 ohm/50 uH of coupling impedance for the measuring instrument.
- b. Both lines of the power mains connected to the EUT were checked for maximum conducted interference.
- c. The frequency range from 150 kHz to 30 MHz was searched. Emission levels under (Limit – 20 dB) was not recorded.

Note: The resolution bandwidth and video bandwidth of test receiver is 9 kHz for quasi-peak detection (QP) and average detection (AV) at frequency 0.15 MHz - 30 MHz.

4.2.4 Deviation from Test Standard

No deviation.

4.2.5 Test Setup

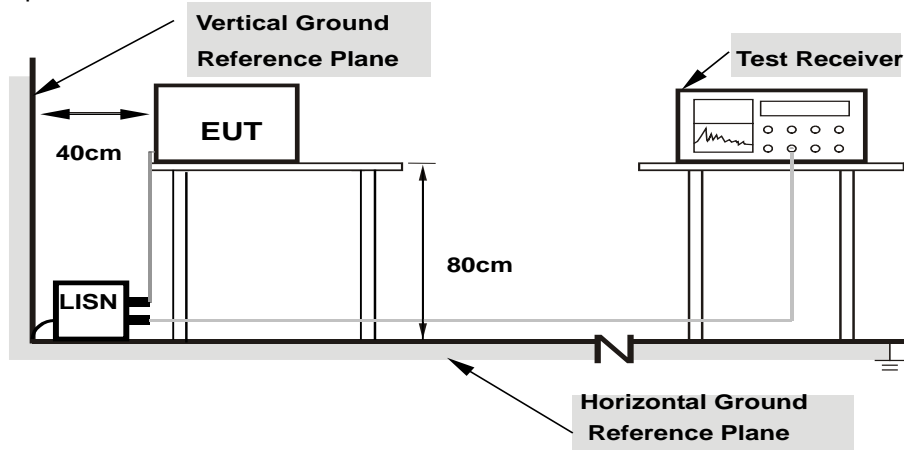

Note: 1.Support units were connected to second LISN.

2.Both of LISNs (AMN) are 80 cm from EUT and at least 80 from other units and other metal planes

4.2.6 EUT Operating Conditions

- Placed the EUT on the testing table.
- Set the EUT under transmission condition continuously at specific channel frequency.

4.2.7 Test Results

CONDUCTED WORST-CASE DATA

Frequency Range	150kHz ~ 30MHz	Detector Function & Resolution Bandwidth	Quasi-Peak (QP) / Average (AV), 9kHz
Input Power	120Vac, 60Hz	Environmental Conditions	25°C, 65%RH
Tested by	Thomas Wei	Test Date	2019/9/2

Phase Of Power : Line (L)										
No	Frequency (MHz)	Correction Factor (dB)	Reading Value (dBuV)		Emission Level (dBuV)		Limit (dBuV)		Margin (dB)	
			Q.P.	AV.	Q.P.	AV.	Q.P.	AV.	Q.P.	AV.
1	0.16955	9.69	28.29	16.78	37.98	26.47	64.98	54.98	-27.00	-28.51
2	0.18910	9.68	27.62	13.70	37.30	23.38	64.08	54.08	-26.78	-30.70
3	0.28663	9.68	20.76	9.18	30.44	18.86	60.62	50.62	-30.18	-31.76
4	0.56121	9.68	18.00	6.52	27.68	16.20	56.00	46.00	-28.32	-29.80
5	1.14312	9.67	18.55	11.36	28.22	21.03	56.00	46.00	-27.78	-24.97
6	13.00999	9.89	20.57	11.68	30.46	21.57	60.00	50.00	-29.54	-28.43

Remarks:

1. Q.P. and AV. are abbreviations of quasi-peak and average individually.
2. The emission levels of other frequencies were very low against the limit.
3. Margin value = Emission level – Limit value
4. Correction factor = Insertion loss + Cable loss
5. Emission Level = Correction Factor + Reading Value

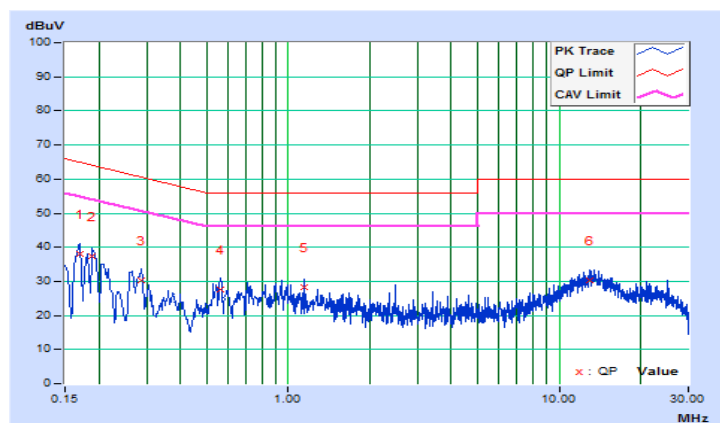

Frequency Range	150kHz ~ 30MHz	Detector Function & Resolution Bandwidth	Quasi-Peak (QP) / Average (AV), 9kHz
Input Power	120Vac, 60Hz	Environmental Conditions	25°C, 65%RH
Tested by	Thomas Wei	Test Date	2019/9/2

Phase Of Power : Neutral (N)										
No	Frequency (MHz)	Correction Factor (dB)	Reading Value (dBuV)		Emission Level (dBuV)		Limit (dBuV)		Margin (dB)	
			Q.P.	AV.	Q.P.	AV.	Q.P.	AV.	Q.P.	AV.
1	0.17737	9.66	24.75	13.14	34.41	22.80	64.61	54.61	-30.20	-31.81
2	0.20458	9.66	20.50	10.71	30.16	20.37	63.42	53.42	-33.26	-33.05
3	0.24775	9.66	20.69	11.72	30.35	21.38	61.83	51.83	-31.48	-30.45
4	0.27120	9.66	20.74	9.76	30.40	19.42	61.08	51.08	-30.68	-31.66
5	0.58010	9.65	18.22	10.69	27.87	20.34	56.00	46.00	-28.13	-25.66
6	14.46842	9.92	15.30	7.97	25.22	17.89	60.00	50.00	-34.78	-32.11

Remarks:

1. Q.P. and AV. are abbreviations of quasi-peak and average individually.
2. The emission levels of other frequencies were very low against the limit.
3. Margin value = Emission level – Limit value
4. Correction factor = Insertion loss + Cable loss
5. Emission Level = Correction Factor + Reading Value

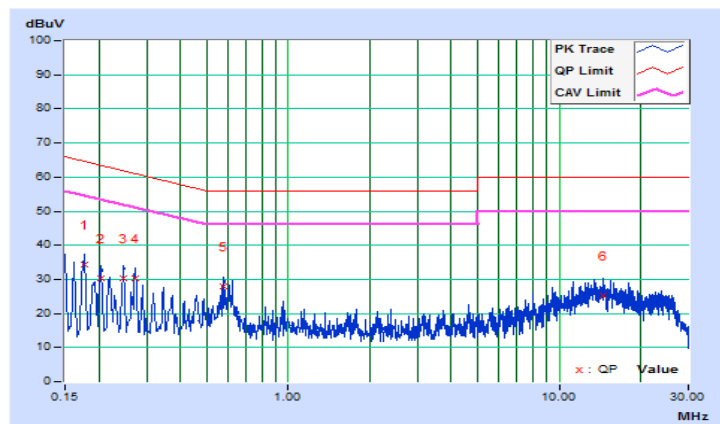

4.3 6 dB Bandwidth Measurement

4.3.1 Limits of 6 dB Bandwidth Measurement

The minimum of 6 dB Bandwidth Measurement is 0.5 MHz.

4.3.2 Test Setup

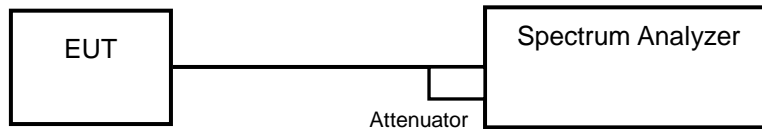

4.3.3 Test Instruments

Refer to section 4.1.2 to get information of above instrument.

4.3.4 Test Procedure

- a. Set resolution bandwidth (RBW) = 100 kHz
- b. Set the video bandwidth (VBW) $\geq 3 \times$ RBW, Detector = Peak.
- c. Trace mode = max hold.
- d. Sweep = auto couple.
- e. Measure the maximum width of the emission that is constrained by the frequencies associated with the two amplitude points (upper and lower) that are attenuated by 6 dB relative to the maximum level measured in the fundamental emission

4.3.5 Deviation from Test Standard

No deviation.

4.3.6 EUT Operating Conditions

The software provided by client to enable the EUT under transmission condition continuously at lowest, middle and highest channel frequencies individually.

4.3.7 Test Results

Channel	Frequency (MHz)	6 dB Bandwidth (MHz)	Minimum Limit (MHz)	Pass / Fail
0	2402	0.68	0.5	Pass
19	2440	0.68	0.5	Pass
39	2480	0.68	0.5	Pass

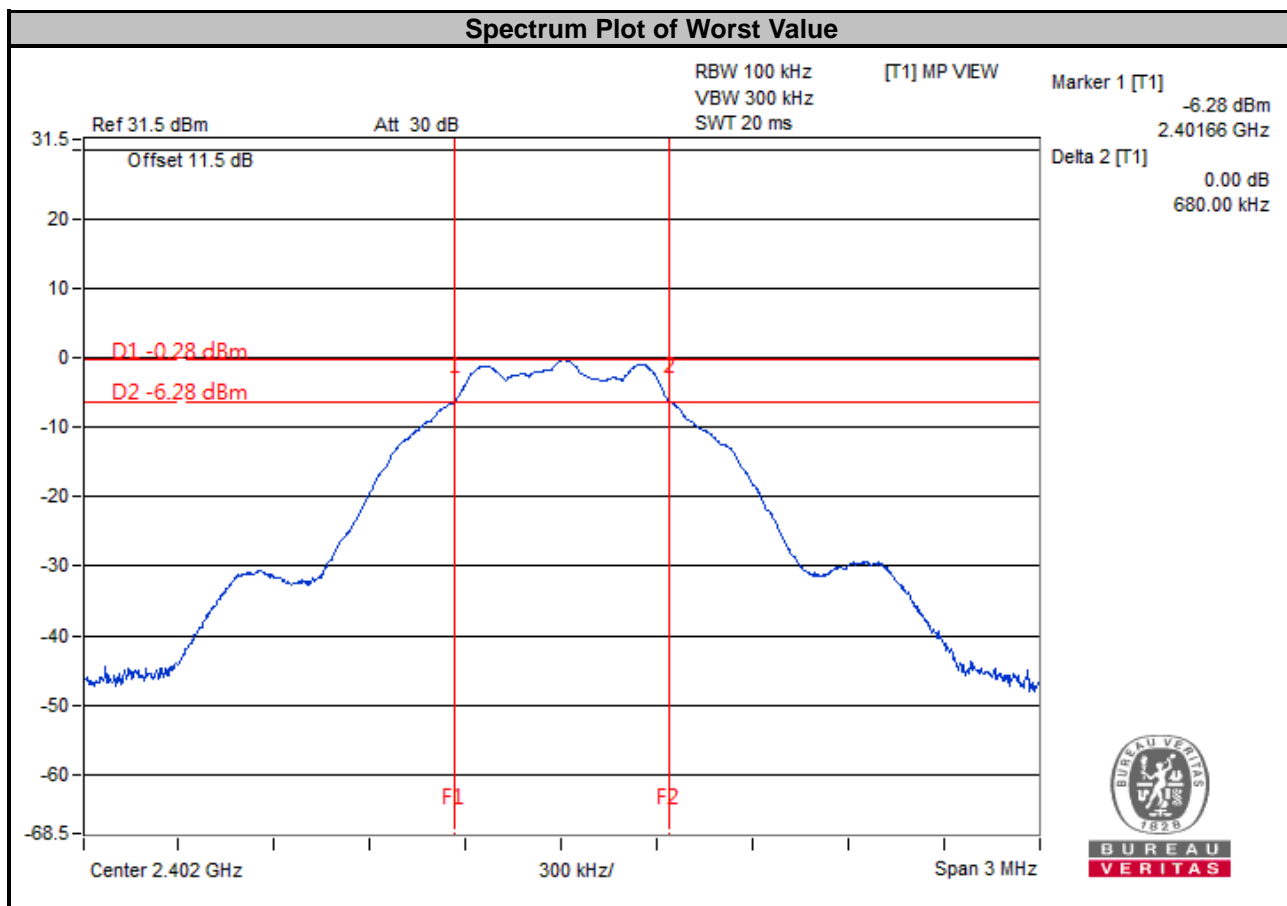

4.4 Occupied Bandwidth Measurement

4.4.1 Test Setup

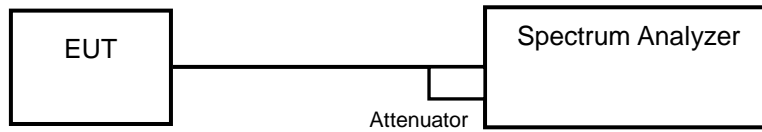

4.4.2 Test Instruments

Refer to section 4.1.2 to get information of above instrument.

4.4.3 Test Procedure

The transmitter output was connected to the spectrum analyzer through an attenuator. The bandwidth of the fundamental frequency was measured by spectrum analyzer with resolution bandwidth in the range of 1 % to 5 % of the anticipated emission bandwidth, and a video bandwidth at least 3x the resolution bandwidth and set the detector to PEAK. The width of a frequency band such that, below the lower and above the upper frequency limits, the mean powers emitted are each equal to a specified percentage 0.5 % of the total mean power of a given emission.

4.4.4 Deviation from Test Standard

No deviation.

4.4.5 EUT Operating Conditions

The software provided by client to enable the EUT under transmission condition continuously at lowest, middle and highest channel frequencies individually.

4.4.6 Test Results

Channel	Frequency (MHz)	Occupied Bandwidth (MHz)	Pass / Fail
0	2402	1.06	Pass
19	2440	1.24	Pass
39	2480	1.06	Pass

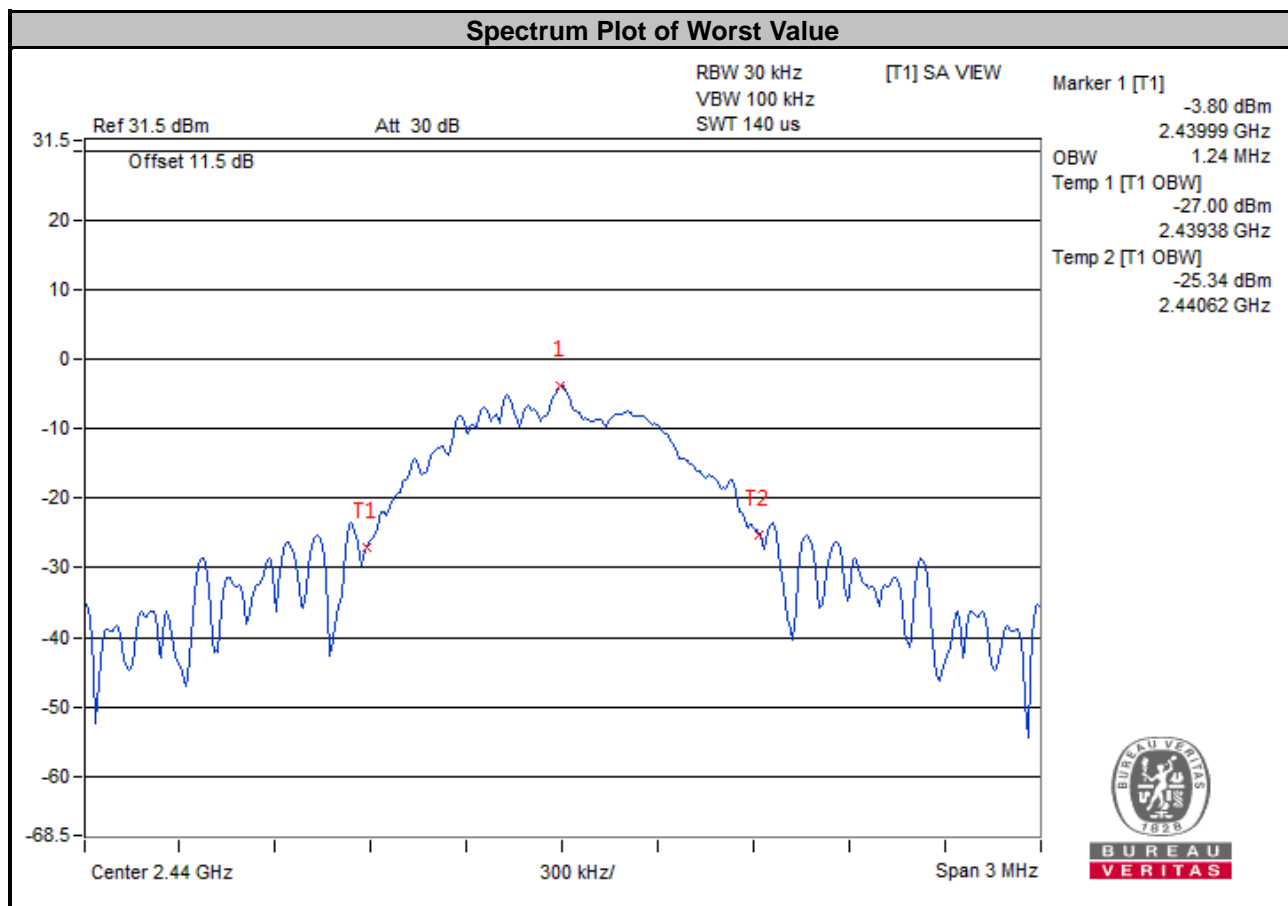

4.5 Conducted Output Power Measurement

4.5.1 Limits of Conducted Output Power Measurement

For systems using digital modulation in the 2400–2483.5 MHz bands: 1 Watt (30 dBm)

4.5.2 Test Setup

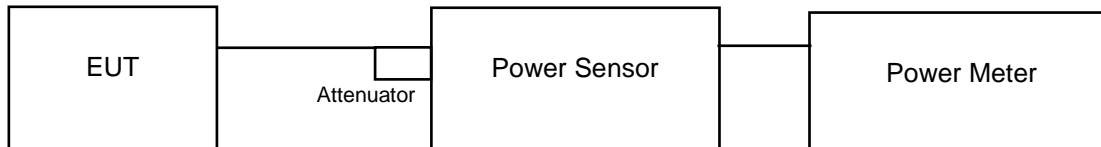

4.5.3 Test Instruments

Refer to section 4.1.2 to get information of above instrument.

4.5.4 Test Procedures

A peak power sensor was used on the output port of the EUT. A power meter was used to read the response of the peak power sensor. Record the power level.

4.5.5 Deviation from Test Standard

No deviation.

4.5.6 EUT Operating Conditions

The software provided by client to enable the EUT under transmission condition continuously at lowest, middle and highest channel frequencies individually.

4.5.7 Test Results

Channel	Frequency (MHz)	Peak Power (mW)	Peak Power (dBm)	Limit (dBm)	Pass / Fail
0	2402	1.219	0.86	30	Pass
19	2440	1.268	1.03	30	Pass
39	2480	1.135	0.55	30	Pass

4.6 Power Spectral Density Measurement

4.6.1 Limits of Power Spectral Density Measurement

The Maximum of Power Spectral Density Measurement is 8 dBm.

4.6.2 Test Setup

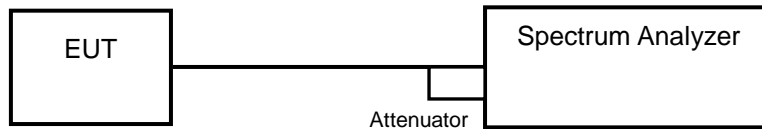

4.6.3 Test Instruments

Refer to section 4.1.2 to get information of above instrument.

4.6.4 Test Procedure

- a. Set analyzer center frequency to DTS channel center frequency.
- b. Set the span to 1.5 times the DTS bandwidth.
- c. Set the RBW to: $3 \text{ kHz} \leq \text{RBW} \leq 100 \text{ kHz}$.
- d. Set the VBW $\geq 3 \times \text{RBW}$.
- e. Detector = peak.
- f. Sweep time = auto couple.
- g. Trace mode = max hold.
- h. Allow trace to fully stabilize.
- i. Use the peak marker function to determine the maximum amplitude level within the RBW.

4.6.5 Deviation from Test Standard

No deviation.

4.6.6 EUT Operating Condition

The software provided by client to enable the EUT under transmission condition continuously at lowest, middle and highest channel frequencies individually.

4.6.7 Test Results

Channel	Frequency (MHz)	PSD (dBm/3 kHz)	Limit (dBm/3 kHz)	Pass / Fail
0	2402	-15.21	8	Pass
19	2440	-14.99	8	Pass
39	2480	-15.62	8	Pass

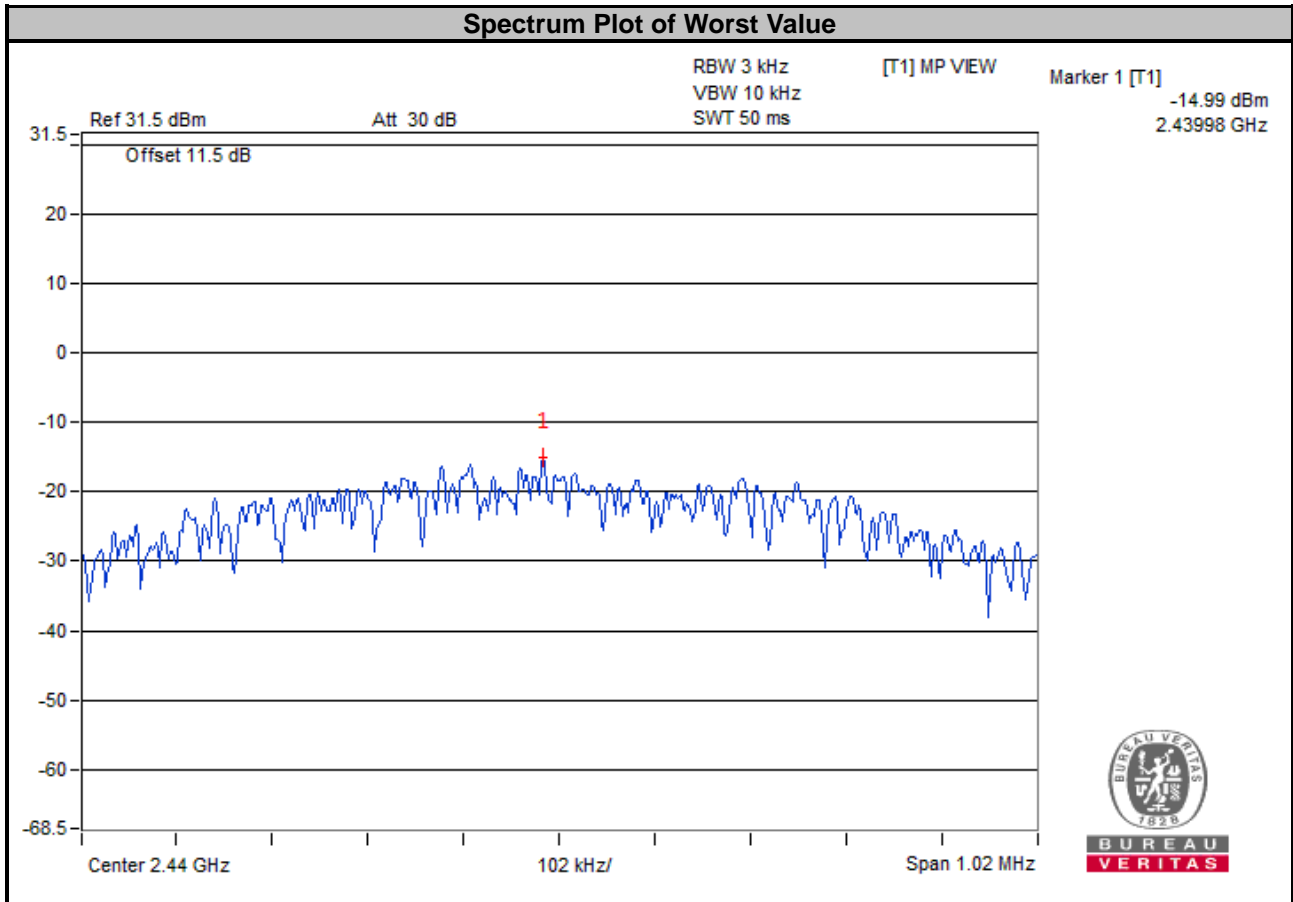

4.7 Conducted Out of Band Emission Measurement

4.7.1 Limits of Conducted Out of Band Emission Measurement

Below -20 dB of the highest emission level of operating band (in 100 kHz Resolution Bandwidth).

4.7.2 Test Setup

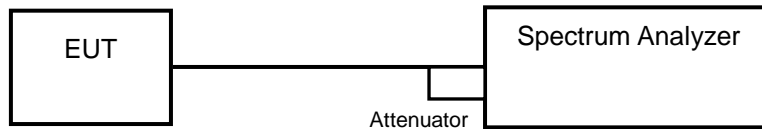

4.7.3 Test Instruments

Refer to section 4.1.2 to get information of above instrument.

4.7.4 Test Procedure

MEASUREMENT PROCEDURE REF

1. Set the RBW = 100 kHz.
2. Set the VBW \geq 300 kHz.
3. Detector = peak.
4. Sweep time = auto couple.
5. Trace mode = max hold.
6. Allow trace to fully stabilize.
7. Use the peak marker function to determine the maximum power level in any 100 kHz band segment within the fundamental EBW.

MEASUREMENT PROCEDURE OOB

1. Set RBW = 100 kHz.
2. Set VBW \geq 300 kHz.
3. Detector = peak.
4. Sweep = auto couple.
5. Trace Mode = max hold.
6. Allow trace to fully stabilize.
7. Use the peak marker function to determine the maximum amplitude level.

4.7.5 Deviation from Test Standard

No deviation.

4.7.6 EUT Operating Condition

The software provided by client to enable the EUT under transmission condition continuously at lowest, middle and highest channel frequencies individually.

4.7.7 Test Results

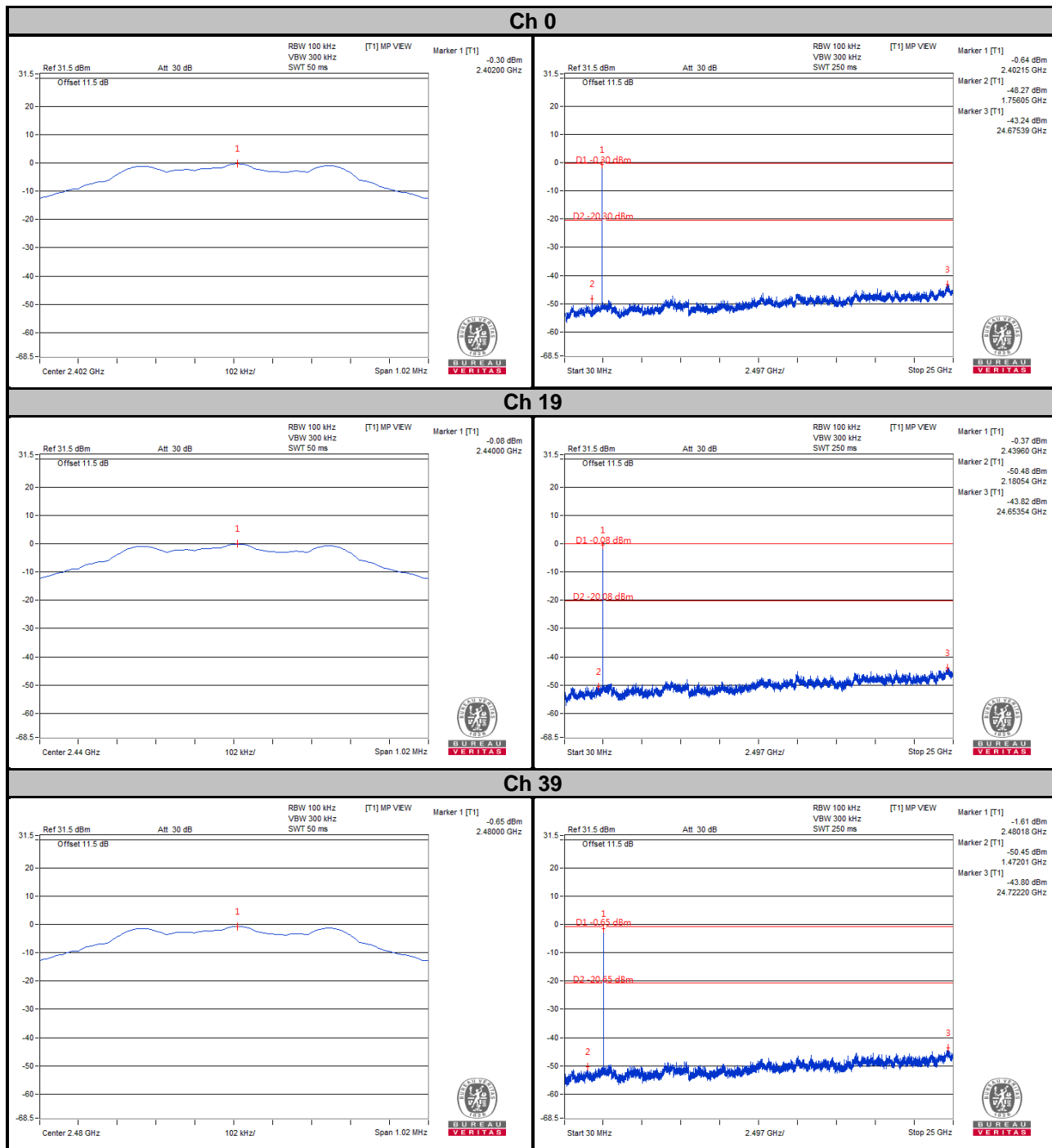

Ch 0 Band Edge

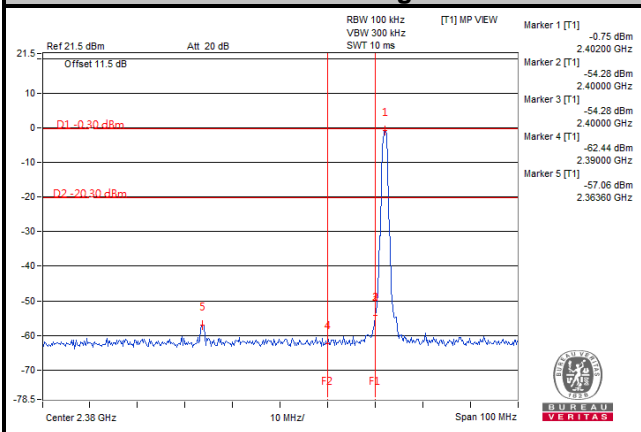

Ch 39 Band Edge

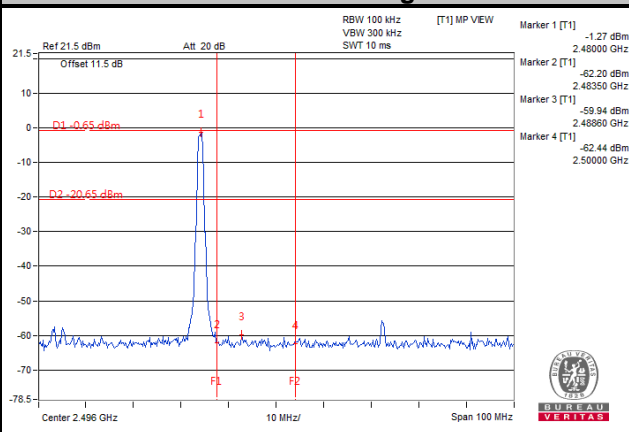

5 Pictures of Test Arrangements

Please refer to the attached file (Test Setup Photo).

Appendix – Information of the Testing Laboratories

We, Bureau Veritas Consumer Products Services (H.K.) Ltd., Taoyuan Branch, were founded in 1988 to provide our best service in EMC, Radio, Telecom and Safety consultation. Our laboratories are FCC recognized accredited test firms and accredited according to ISO/IEC 17025.

If you have any comments, please feel free to contact us at the following:

Lin Kou EMC/RF Lab

Tel: 886-2-26052180

Fax: 886-2-26051924

Hsin Chu EMC/RF/Telecom Lab

Tel: 886-3-6668565

Fax: 886-3-6668323

Hwa Ya EMC/RF/Safety Lab

Tel: 886-3-3183232

Fax: 886-3-3270892

Email: service.adt@tw.bureauveritas.com

Web Site: www.bureauveritas-adt.com

The address and road map of all our labs can be found in our web site also.

--- END ---