



FCC CERTIFICATION REPORT

Test Report No. : T190415E02-F
Applicant : FUJITSU CONNECTED TECHNOLOGIES Ltd.
Address : 1-1, Kamikodanaka 4-chome, Nakahara-ku, Kawasaki 211-8588,
 Japan
Manufacturer : FUJITSU CONNECTED TECHNOLOGIES Ltd.
Address : 1-1, Kamikodanaka 4-chome, Nakahara-ku, Kawasaki 211-8588,
 Japan

Equipment Under Test (EUT) :
Product Name : Smart Phone
Brand Name : FUJITSU
Model No. : 801FJ
Added Model(s) : N/A

Standards : FCC Part 15, Subpart B, Class B

Date of Receipt : Apr. 15th, 2019
Date of Test : Apr. 18th, 2019
Date of Issue : May 09th, 2019

Test Result :	PASS
----------------------	-------------

In the configuration tested, the EUT complied with the standards specified above.

Remarks :

This report details the results of the testing carried out on one sample, the results contained in this test report do not relate to other samples of the same product. The manufacturer should ensure that all products in series production are in conformity with the product sample detailed in this report.

This report may only be reproduced and distributed in full. If the product in this report is used in any configuration other than that detailed in the report, the manufacturer must ensure the new system complies with all relevant standards. Any mention of Compliance Certification Services Inc. Wugu Laboratory or testing done by Compliance Certification Services Inc. Wugu Laboratory in connection with distribution or use of the product described in this report must be approved by Compliance Certification Services Inc. Wugu Laboratory in writing.

Tested By:

Date:

May 09th, 2019

Frank Lin (Engineer)

Approved By:

Date:

May 09th, 2019

Hex Chiang (Supervisor)



Unless otherwise stated the results shown in this test report refer only to the sample(s) tested and such sample(s) are retained for 90 days only.

除非另有說明，此報告結果僅對測試之樣品負責，同時此樣品僅保留90天。本報告未經本公司書面許可，不可部份複製。

This document is issued by the Company subject to its General Conditions of Service printed overleaf, available on request or accessible at www.sgs.com/terms_and_conditions.htm and for electronic format documents, subject to Terms and Conditions for Electronic Documents at www.sgs.com/terms_e-document.htm. Attention is drawn to the limitation of liability, indemnification and jurisdiction issues defined therein. Any holder of this document is advised that information contained hereon reflects the Company's findings at the time of its intervention only and within the limits of Client's instructions, if any. The Company's sole responsibility is to its Client and this document does not exonerate parties to a transaction from exercising all their rights and obligations under the transaction documents. This document cannot be reproduced except in full, without prior written approval of the Company. Any unauthorized alteration, forgery or falsification of the content or appearance of this document is unlawful and offenders may be prosecuted to the fullest extent of the law.



Revision History

Report Number	Revision	Description	Issue Date
T190415E02-F	Rev.00	Initial creation of document	May 09th, 2019

Unless otherwise stated the results shown in this test report refer only to the sample(s) tested and such sample(s) are retained for 90 days only.

除非另有說明，此報告結果僅對測試之樣品負責，同時此樣品僅保留90天。本報告未經本公司書面許可，不可部份複製。

This document is issued by the Company subject to its General Conditions of Service printed overleaf, available on request or accessible at www.sgs.com/terms_and_conditions.htm and for electronic format documents, subject to Terms and Conditions for Electronic Documents at www.sgs.com/terms_e-document.htm. Attention is drawn to the limitation of liability, indemnification and jurisdiction issues defined therein. Any holder of this document is advised that information contained hereon reflects the Company's findings at the time of its intervention only and within the limits of Client's instructions, if any. The Company's sole responsibility is to its Client and this document does not exonerate parties to a transaction from exercising all their rights and obligations under the transaction documents. This document cannot be reproduced except in full, without prior written approval of the Company. Any unauthorized alteration, forgery or falsification of the content or appearance of this document is unlawful and offenders may be prosecuted to the fullest extent of the law.



Contents

1. GENERAL INFORMATION.....	4
1.1 APPLICANT & MANUFACTURER INFORMATION	4
1.2 GENERAL DESCRIPTION OF EUT	4
1.3 DETAILS OF EUT	4
1.4 OPERATION PROCEDURE	6
1.5 DESCRIPTION OF SUPPORT UNITS	6
1.6 MODIFICATION LIST	6
1.7 ACCESSORIES CABLE LIST	7
1.8 TEST SET-UP CONFIGURATION.....	7
1.9 MEASUREMENT PROCEDURE	8
1.10 STANDARDS APPLICABLE FOR TESTING.....	8
1.11 DECISION RULES OF RESULTS.....	9
1.12 SUMMARY OF RESULTS	9
1.13 REPORTING STATEMENTS OF CONFORMITY.....	9
2. EMISSION	10
2.1 TEST RESULTS	10
2.2 FREQUENCY RANGE.....	10
2.3 LIMITS OF CONDUCTED AND RADIATED EMISSION	10
2.3.1 LIMITS OF CONDUCTED EMISSION	10
2.3.2 LIMITS OF RADIATED EMISSIONS	11
2.4. TEST OF CONDUCTED EMISSION.....	12
2.4.1 TEST EQUIPMENTS	12
2.4.2 OPERATING ENVIRONMENT	12
2.4.3 MEASUREMENT LEVEL CALCULATION	12
2.4.4 MEASUREMENT DATA:.....	13
2.5 TEST OF RADIATED EMISSION.....	15
2.5.1 TEST EQUIPMENTS	15
2.5.2 OPERATING ENVIRONMENT	17
2.5.3 MEASUREMENT LEVEL CALCULATION	17
2.5.4 MEASUREMENT DATA.....	18
3. PHOTOGRAPHS OF TEST	22

Unless otherwise stated the results shown in this test report refer only to the sample(s) tested and such sample(s) are retained for 90 days only.

除非另有說明，此報告結果僅對測試之樣品負責，同時此樣品僅保留90天。本報告未經本公司書面許可，不可部份複製。

This document is issued by the Company subject to its General Conditions of Service printed overleaf, available on request or accessible at www.sgs.com/terms_and_conditions.htm and for electronic format documents, subject to Terms and Conditions for Electronic Documents at www.sgs.com/terms_e-document.htm. Attention is drawn to the limitation of liability, indemnification and jurisdiction issues defined therein. Any holder of this document is advised that information contained hereon reflects the Company's findings at the time of its intervention only and within the limits of Client's instructions, if any. The Company's sole responsibility is to its Client and this document does not exonerate parties to a transaction from exercising all their rights and obligations under the transaction documents. This document cannot be reproduced except in full, without prior written approval of the Company. Any unauthorized alteration, forgery or falsification of the content or appearance of this document is unlawful and offenders may be prosecuted to the fullest extent of the law.



1. General Information

1.1 Applicant & Manufacturer Information

Applicant : FUJITSU CONNECTED TECHNOLOGIES Ltd.
 Address of Applicant : 1-1, Kamikodanaka 4-chome, Nakahara-ku, Kawasaki
 211-8588, Japan
 Manufacturer : FUJITSU CONNECTED TECHNOLOGIES Ltd.
 Address of Manufacturer : 1-1, Kamikodanaka 4-chome, Nakahara-ku, Kawasaki
 211-8588, Japan

1.2 General Description of EUT

Product Name : Smart Phone
 Brand Name : FUJITSU
 Model No. : 801FJ
 Added Model(s) : N/A
 Model Difference : N/A

1.3 Details of EUT

Power Supply : AC 100~240V,50/60Hz
 Modes/Function : Mode 1. ADP + Earphone + WiFi Link+NFC OFF+
 BT Link + GPS/Glonass Link +
 SD Card + GSM : 1900 Link
 Mode 2. ADP + Earphone + WiFi Idle +NFC OFF+
 BT Idle + GPS/Glonass Idle +
 SD Card + GSM : 1900 Idle
 Mode 3. WiFi Link + NFC ON(Standalone) +
 BT Link + GPS/Glonass Link +
 SD Card + GSM : 1900 Single
 Mode 4. ADP + Earphone + WiFi Idle +NFC OFF+
 BT Idle + GPS/Glonass Idle +
 SD Card + WCDMA : BII Idle

Unless otherwise stated the results shown in this test report refer only to the sample(s) tested and such sample(s) are retained for 90 days only.

除非另有說明，此報告結果僅對測試之樣品負責，同時此樣品僅保留90天。本報告未經本公司書面許可，不可部份複製。

This document is issued by the Company subject to its General Conditions of Service printed overleaf, available on request or accessible at www.sgs.com/terms_and_conditions.htm and for electronic format documents, subject to Terms and Conditions for Electronic Documents at www.sgs.com/terms_e-document.htm. Attention is drawn to the limitation of liability, indemnification and jurisdiction issues defined therein. Any holder of this document is advised that information contained hereon reflects the Company's findings at the time of its intervention only and within the limits of Client's instructions, if any. The Company's sole responsibility is to its Client and this document does not exonerate parties to a transaction from exercising all their rights and obligations under the transaction documents. This document cannot be reproduced except in full, without prior written approval of the Company. Any unauthorized alteration, forgery or falsification of the content or appearance of this document is unlawful and offenders may be prosecuted to the fullest extent of the law.



- Mode 5. ADP + Earphone + WiFi Link+NFC OFF+
BT Link + GPS/Glonass Link +
SD Card + LTE : B2 Link
- Mode 6. ADP + Earphone+Camera Rear_1 REC+
WiFi Link + NFC OFF + BT Stand by +
GPS/Glonass Link + SD Card
- Mode 7. ADP + Earphone+Camera Rear_2 REC+
WiFi Link + NFC OFF + BT Stand by +
GPS/Glonass Link + SD Card
- Mode 8. ADP + Earphone+ Camera Front REC+
WiFi Link + NFC OFF + BT Stand by +
GPS/Glonass Link + SD Card
- Mode 9. WiFi Link + BT Link +GPS/Glonass Link+
Earphone + SD Card + USB Cable +
SD Write
- Mode 10. WiFi Link +BT Link+GPS/Glonass Link+
Earphone + SD Card + USB Cable +
SD Read

- Worst case : CE, Below / Above RE worst case :
Mode 5. ADP + Earphone + WiFi Link+NFC OFF+
BT Link + GPS/Glonass Link +
SD Card + LTE : B2 Link
- Highest operate description : >108 MHz
- Adapter : Model No.: SB-AC20-TCPD
Supplier : SoftBank SELECTION
I/P : AC 100-240V, 50-60Hz, 0.8A
O/P : DC 5V, 3A / DC 7V, 3A / DC 9V, 3A /
DC 12V, 2.25A
- Battery : Model No.: CA08723-1021
Supplier : FUJITSU CONNECTED TECHNOLOGIES LIMITED
3.85V, 3100mAh, 11.94Wh

Unless otherwise stated the results shown in this test report refer only to the sample(s) tested and such sample(s) are retained for 90 days only.

除非另有說明，此報告結果僅對測試之樣品負責，同時此樣品僅保留90天。本報告未經本公司書面許可，不可部份複製。

This document is issued by the Company subject to its General Conditions of Service printed overleaf, available on request or accessible at www.sgs.com/terms_and_conditions.htm and for electronic format documents, subject to Terms and Conditions for Electronic Documents at www.sgs.com/terms_e-document.htm. Attention is drawn to the limitation of liability, indemnification and jurisdiction issues defined therein. Any holder of this document is advised that information contained hereon reflects the Company's findings at the time of its intervention only and within the limits of Client's instructions, if any. The Company's sole responsibility is to its Client and this document does not exonerate parties to a transaction from exercising all their rights and obligations under the transaction documents. This document cannot be reproduced except in full, without prior written approval of the Company. Any unauthorized alteration, forgery or falsification of the content or appearance of this document is unlawful and offenders may be prosecuted to the fullest extent of the law.



1.4 Operation Procedure

Mode 5

1. Let EUT connect to Adapter & Earphone.
2. Turn on WiFi function of EUT and connect to AP.
Turn on Bluetooth function and connect to Speaker.
Turn off NFC function.
Turn on GPS function and connects with GPS simulator.
Plays 1KHz in SD Card
3. Turn on GSM and connect with CMW500 (LTE B2).
4. Start testing.

1.5 Description of Support Units

PRODUCT	MANUFACTURER	MODEL NO.	SERIAL NO.
SIM Card	R&S	N/A	N/A
Radio Communication Analyzer	R&S	CMW500	116875
Micro SD	Transcend	Micro SDHC (Class4)	N/A
Earphone	LENOVO	N/A	N/A
BT Speaker	SONY	SRS-BTV5	N/A
Wireless AP	D-Link	DIR-868L	R3X81D7000137
GPS Signal Generator	IFR	GPS-101	N/A

Support Equipment Used in Tested Cable

Cable Type	Core	Length	Shielding/Non-shielding
Earphone cable	N/A	1.5m	Non-shielding
USB cable	N/A	1m	Shielding

1.6 Modification List

No modification was made by Compliance Certification Services Inc. Wugu Laboratory.

Unless otherwise stated the results shown in this test report refer only to the sample(s) tested and such sample(s) are retained for 90 days only.

除非另有說明，此報告結果僅對測試之樣品負責，同時此樣品僅保留90天。本報告未經本公司書面許可，不可部份複製。

This document is issued by the Company subject to its General Conditions of Service printed overleaf, available on request or accessible at www.sgs.com/terms_and_conditions.htm and for electronic format documents, subject to Terms and Conditions for Electronic Documents at www.sgs.com/terms_e-document.htm. Attention is drawn to the limitation of liability, indemnification and jurisdiction issues defined therein. Any holder of this document is advised that information contained hereon reflects the Company's findings at the time of its intervention only and within the limits of Client's instructions, if any. The Company's sole responsibility is to its Client and this document does not exonerate parties to a transaction from exercising all their rights and obligations under the transaction documents. This document cannot be reproduced except in full, without prior written approval of the Company. Any unauthorized alteration, forgery or falsification of the content or appearance of this document is unlawful and offenders may be prosecuted to the fullest extent of the law.



1.7 Accessories Cable List

Cable Type	Core	Length	Shielding/Non-shielding
Adapter DC power cable	N/A	1.5m	Shielding

1.8 Test Set-Up Configuration

Mode 5

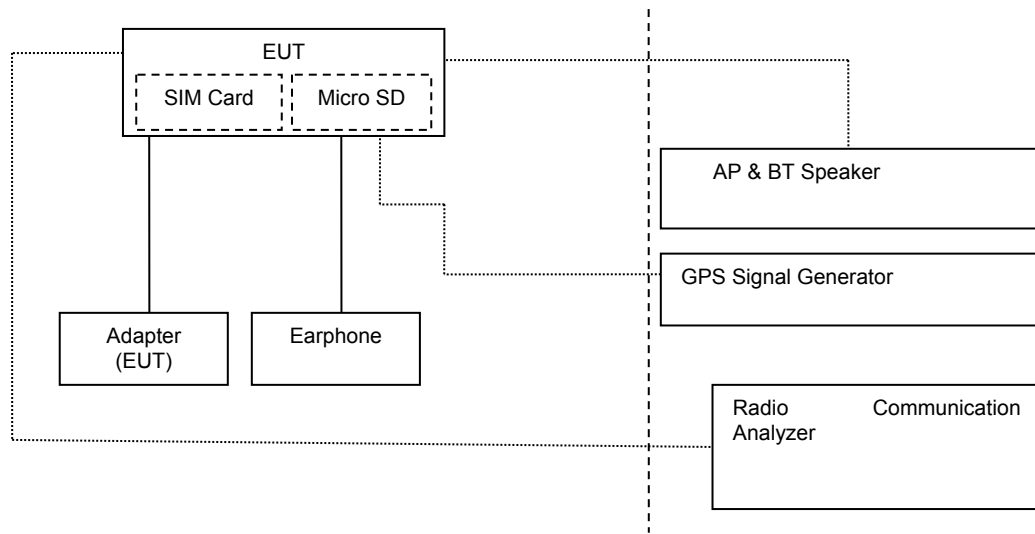

Unless otherwise stated the results shown in this test report refer only to the sample(s) tested and such sample(s) are retained for 90 days only.

除非另有說明，此報告結果僅對測試之樣品負責，同時此樣品僅保留90天。本報告未經本公司書面許可，不可部份複製。

This document is issued by the Company subject to its General Conditions of Service printed overleaf, available on request or accessible at www.sgs.com/terms_and_conditions.htm and for electronic format documents, subject to Terms and Conditions for Electronic Documents at www.sgs.com/terms_e-document.htm. Attention is drawn to the limitation of liability, indemnification and jurisdiction issues defined therein. Any holder of this document is advised that information contained hereon reflects the Company's findings at the time of its intervention only and within the limits of Client's instructions, if any. The Company's sole responsibility is to its Client and this document does not exonerate parties to a transaction from exercising all their rights and obligations under the transaction documents. This document cannot be reproduced except in full, without prior written approval of the Company. Any unauthorized alteration, forgery or falsification of the content or appearance of this document is unlawful and offenders may be prosecuted to the fullest extent of the law.



1.9 Measurement Procedure

Conducted Emission Testing was performed according to ANSI C63.4:2014 in a shielded room with peripherals placed on a table, 0.8m high over a metal floor. It was located more than required distance away from the shielded room wall.

Radiated Emission Testing was performed according to ANSI C63.4:2014 at the 3/10m semi-anechoic chamber. The EUT was placed on a 0.8m high table along with the peripherals. The turn table was placed 10m distance from the antenna. Cables were placed in a position to produce maximum emissions as determined by experimentation, and operation mode was selected for production of maximum emission.

The frequencies and amplitudes of maximum emission were measured at varying azimuths, antenna heights and antenna polarities. Maximum emission levels are then reported.

1.10 Standards Applicable for Testing

Tests to be carried out under FCC Part 15, Subpart B/CISPR 22

Test Standards	Status
FCC Part 15, Subpart B/ CISPR 22	Applicable
Deviation from Standard	No deviation

Unless otherwise stated the results shown in this test report refer only to the sample(s) tested and such sample(s) are retained for 90 days only.

除非另有說明，此報告結果僅對測試之樣品負責，同時此樣品僅保留90天。本報告未經本公司書面許可，不可部份複製。

This document is issued by the Company subject to its General Conditions of Service printed overleaf, available on request or accessible at www.sgs.com/terms_and_conditions.htm and for electronic format documents, subject to Terms and Conditions for Electronic Documents at www.sgs.com/terms_e-document.htm. Attention is drawn to the limitation of liability, indemnification and jurisdiction issues defined therein. Any holder of this document is advised that information contained hereon reflects the Company's findings at the time of its intervention only and within the limits of Client's instructions, if any. The Company's sole responsibility is to its Client and this document does not exonerate parties to a transaction from exercising all their rights and obligations under the transaction documents. This document cannot be reproduced except in full, without prior written approval of the Company. Any unauthorized alteration, forgery or falsification of the content or appearance of this document is unlawful and offenders may be prosecuted to the fullest extent of the law.



1.11 Decision Rules of Results

Reported measurement data comply with ANSI C63.4:2014

Determining compliance shall be based on the results of the compliance measurement, not taking into account measurement instrumentation uncertainty.

1.12 Summary of Results

Highest Emission					
Standard	Test Type	Result	Phase/Pol.	Frequency(MHz)	Margin(dB)
FCC Part 15 Subpart B Class B	Conducted Emission	PASS	Line	0.5140	-21.49 (AVG)
			Neutral	0.5140	-22.61 (AVG)
	Radiated Emission	PASS	Ver.	32.9100	-8.09 (QP)

1.13 Reporting Statements of Conformity

The conformity statement in this report is based solely on the test results, measurement uncertainty is excluded.

Unless otherwise stated the results shown in this test report refer only to the sample(s) tested and such sample(s) are retained for 90 days only.

除非另有說明，此報告結果僅對測試之樣品負責，同時此樣品僅保留90天。本報告未經本公司書面許可，不可部份複製。

This document is issued by the Company subject to its General Conditions of Service printed overleaf, available on request or accessible at www.sgs.com/terms_and_conditions.htm and for electronic format documents, subject to Terms and Conditions for Electronic Documents at www.sgs.com/terms_e-document.htm. Attention is drawn to the limitation of liability, indemnification and jurisdiction issues defined therein. Any holder of this document is advised that information contained hereon reflects the Company's findings at the time of its intervention only and within the limits of Client's instructions, if any. The Company's sole responsibility is to its Client and this document does not exonerate parties to a transaction from exercising all their rights and obligations under the transaction documents. This document cannot be reproduced except in full, without prior written approval of the Company. Any unauthorized alteration, forgery or falsification of the content or appearance of this document is unlawful and offenders may be prosecuted to the fullest extent of the law.



2. EMISSION

2.1 Test Results

	Results
Conducted Emission	Pass
Radiated Emission	Pass

2.2 Frequency Range

FCC Part 15, Subpart B:

Conducted Emission : 150 kHz - 30 MHz

Radiated Emission : See below table

Highest frequency generated or Upper frequency of measurement
used in the device or on which the range (MHz)
device operates or tunes (MHz)

Below 1.705	30
1.705 - 108	1000
108 - 500	2000
500 - 1000	5000
Above 1000	5th harmonic of the highest frequency or 40 GHz, whichever is lower

2.3 Limits of Conducted and Radiated Emission

2.3.1 Limits of Conducted Emission

FCC Part 15, Subpart B/CISPR 22:

FREQUENCY (MHz)	Class A (dBuV)		Class B (dBuV)	
	Quasi - peak	Average	Quasi - peak	Average
0.15 - 0.5	79	66	66 - 56	56 - 46
0.50 - 5.0	73	60	56	46
5.0 - 30.0	73	60	60	50

Note : (1) The lower limit shall apply at the transition frequencies.

(2) The limit decreases linearly with the logarithm of the frequency in the range 0.15 to 0.50 MHz.

(3) All emanation from a class A/B digital device or system, including any network of conductors and apparatus connected there to, shall not exceed the level of field strengths specified above.

Unless otherwise stated the results shown in this test report refer only to the sample(s) tested and such sample(s) are retained for 90 days only.

除非另有說明，此報告結果僅對測試之樣品負責，同時此樣品僅保留90天。本報告未經本公司書面許可，不可部份複製。

This document is issued by the Company subject to its General Conditions of Service printed overleaf, available on request or accessible at www.sgs.com/terms_and_conditions.htm and for electronic format documents, subject to Terms and Conditions for Electronic Documents at www.sgs.com/terms_e-document.htm. Attention is drawn to the limitation of liability, indemnification and jurisdiction issues defined therein. Any holder of this document is advised that information contained hereon reflects the Company's findings at the time of its intervention only and within the limits of Client's instructions, if any. The Company's sole responsibility is to its Client and this document does not exonerate parties to a transaction from exercising all their rights and obligations under the transaction documents. This document cannot be reproduced except in full, without prior written approval of the Company. Any unauthorized alteration, forgery or falsification of the content or appearance of this document is unlawful and offenders may be prosecuted to the fullest extent of the law.



2.3.2 Limits of Radiated Emissions

FCC Part 15, Subpart B Limit:

- Detector Function : Quasi – Peak

FREQUENCY (MHz)	Class A (at 10m)	Class B (at 3m)
	dBuV/m	dBuV/m
30~88	39	40
88~216	43.5	43.5
216~960	46.44	46
Above 960	49.54	54

- Detector Function : Peak , Average

FREQUENCY (MHz)	Class A (dBuV/m) (at 3m)		Class B (dBuV/m) (at 3m)	
	Peak	Average	Peak	Average
Above 1000	79.3	59.3	73.9	53.9

CISPR 22 Limit:

- Detector Function : Quasi – Peak

FREQUENCY (MHz)	Class A (at 10m)	Class B (at 10m)
	dBuV/m	dBuV/m
30-230	40	30
230-1000	47	37

NOTE 1 The lower limit shall apply at the transition frequency.

NOTE 2 Additional provisions may be required for cases where interference occurs.

FREQUENCY (GHz)	Class A (dBuV/m) (at 3m)		Class B (dBuV/m) (at 3m)	
	Average	Peak	Average	Peak
1~3	56	76	50	70
3~6	60	80	54	74

NOTE The lower limit applies at the transition frequency.

Unless otherwise stated the results shown in this test report refer only to the sample(s) tested and such sample(s) are retained for 90 days only.

除非另有說明，此報告結果僅對測試之樣品負責，同時此樣品僅保留90天。本報告未經本公司書面許可，不可部份複製。

This document is issued by the Company subject to its General Conditions of Service printed overleaf, available on request or accessible at www.sgs.com/terms_and_conditions.htm and for electronic format documents, subject to Terms and Conditions for Electronic Documents at www.sgs.com/terms_e-document.htm. Attention is drawn to the limitation of liability, indemnification and jurisdiction issues defined therein. Any holder of this document is advised that information contained hereon reflects the Company's findings at the time of its intervention only and within the limits of Client's instructions, if any. The Company's sole responsibility is to its Client and this document does not exonerate parties to a transaction from exercising all their rights and obligations under the transaction documents. This document cannot be reproduced except in full, without prior written approval of the Company. Any unauthorized alteration, forgery or falsification of the content or appearance of this document is unlawful and offenders may be prosecuted to the fullest extent of the law.



2.4. Test of Conducted Emission

2.4.1 Test Equipments

Conducted Emission Room #B					
Name of Equipment	Manufacturer	Model	Serial Number	Calibration Date	Calibration Due
Coaxial Cable	EMCI	CFD300-NL	CE2	May 02th, 2018	May 01th, 2019
DC LISN	Schwarzbeck	NNBM 8124	629	Mar. 08th, 2019	Mar. 07th, 2020
DC LISN	Schwarzbeck	NNBM 8124	628	Mar. 08th, 2019	Mar. 07th, 2020
EMI Test Receiver	R&S	ESCI	101073	Jul. 17th, 2018	Jul. 16th, 2019
ISN	TESEQ	ISN ST08	36290	Jun. 25th, 2018	Jun. 24th, 2019
ISN	FCC	FCC-TLISN-T8-02-09	100106	Sep. 18th, 2018	Sep. 17th, 2019
LISN	R&S	ENV216	101054	May 02th, 2018	May 01th, 2019
LISN	Schwarzbeck	NSLK8128	5012	Apr. 23th, 2018	Apr. 22th, 2019
Software	CCS-3A1-CE				
Compliance Certification Services Inc. (Wugu Laboratory) No.139, Wugong Rd., Wugu Dist., New Taipei City 24886, Taiwan (R.O.C.) Measurement Uncertainty of Conducted Emission Expanded uncertainty (K=2) of conducted emission is 2.96 dB					

2.4.2 Operating Environment

Temperature : 24 degree C

Humidity : 50 %RH

Atmospheric Pressure : 992 mBar

2.4.3 Measurement Level Calculation

Factor = LISN insertion loss + Cable loss

Measurement Level = Reading Level + Factor

Over (Margin) = Measurement Level – Limit

Unless otherwise stated the results shown in this test report refer only to the sample(s) tested and such sample(s) are retained for 90 days only.

除非另有說明，此報告結果僅對測試之樣品負責，同時此樣品僅保留90天。本報告未經本公司書面許可，不可部份複製。

This document is issued by the Company subject to its General Conditions of Service printed overleaf, available on request or accessible at www.sgs.com/terms_and_conditions.htm and for electronic format documents, subject to Terms and Conditions for Electronic Documents at www.sgs.com/terms_e-document.htm. Attention is drawn to the limitation of liability, indemnification and jurisdiction issues defined therein. Any holder of this document is advised that information contained hereon reflects the Company's findings at the time of its intervention only and within the limits of Client's instructions, if any. The Company's sole responsibility is to its Client and this document does not exonerate parties to a transaction from exercising all their rights and obligations under the transaction documents. This document cannot be reproduced except in full, without prior written approval of the Company. Any unauthorized alteration, forgery or falsification of the content or appearance of this document is unlawful and offenders may be prosecuted to the fullest extent of the law.



2.4.4 Measurement Data:

Model No.:801FJ

Mode_5_L

Test site:	10M Conduction	Date:	2019/4/18
Standard:	FCC Part 15 B Class B(QP)	Time:	16:57:47
Test item:	Conduction test	Temp.(°C)/Hum.(%):	24(°C)/50%
Mode:	5	Test Voltage:	AC 120V/60Hz
Description:			

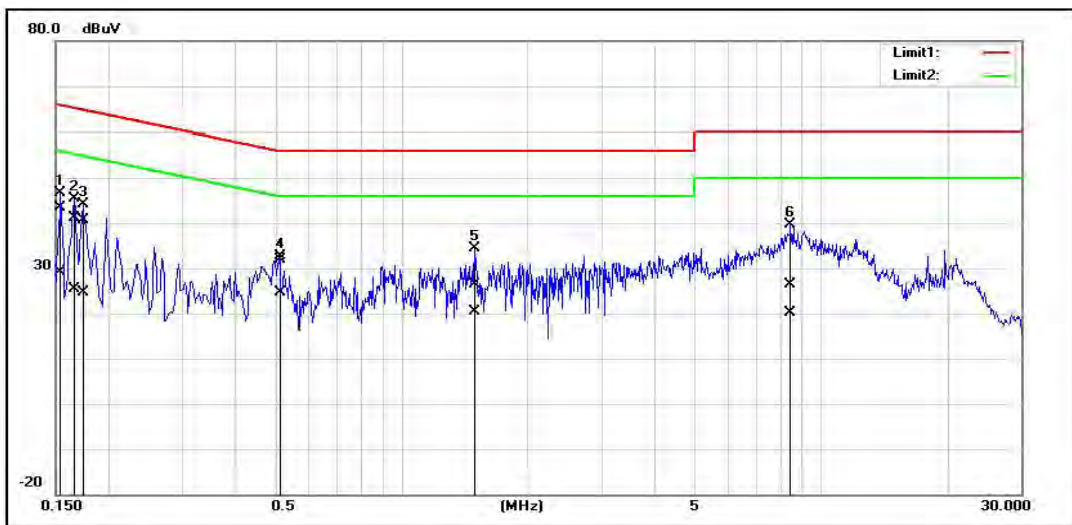

No.	Frequency (MHz)	QuasiPeak reading (dBuV)	Average reading (dBuV)	Correction factor (dB)	QuasiPeak result (dBuV)	Average result (dBuV)	QuasiPeak limit (dBuV)	Average limit (dBuV)	QuasiPeak margin (dB)	Average margin (dB)	Remark
1	0.1539	33.69	19.26	9.76	43.45	29.02	65.78	55.79	-22.33	-26.77	Pass
2	0.1660	31.48	15.61	9.76	41.24	25.37	65.15	55.16	-23.91	-29.79	Pass
3	0.1740	30.76	14.92	9.76	40.52	24.68	64.76	54.77	-24.24	-30.09	Pass
4*	0.5140	22.22	14.75	9.76	31.98	24.51	56.00	46.00	-24.02	-21.49	Pass
5	1.4980	16.58	10.49	9.78	26.36	20.27	56.00	46.00	-29.64	-25.73	Pass
6	8.4900	16.57	10.11	9.93	26.50	20.04	60.00	50.00	-33.50	-29.96	Pass

Unless otherwise stated the results shown in this test report refer only to the sample(s) tested and such sample(s) are retained for 90 days only.

除非另有說明，此報告結果僅對測試之樣品負責，同時此樣品僅保留90天。本報告未經本公司書面許可，不可部份複製。

This document is issued by the Company subject to its General Conditions of Service printed overleaf, available on request or accessible at www.sgs.com/terms_and_conditions.htm and for electronic format documents, subject to Terms and Conditions for Electronic Documents at www.sgs.com/terms_e-document.htm. Attention is drawn to the limitation of liability, indemnification and jurisdiction issues defined therein. Any holder of this document is advised that information contained hereon reflects the Company's findings at the time of its intervention only and within the limits of Client's instructions, if any. The Company's sole responsibility is to its Client and this document does not exonerate parties to a transaction from exercising all their rights and obligations under the transaction documents. This document cannot be reproduced except in full, without prior written approval of the Company. Any unauthorized alteration, forgery or falsification of the content or appearance of this document is unlawful and offenders may be prosecuted to the fullest extent of the law.



Mode_5_N

Test site:	10M Conduction	Date:	2019/4/18
Standard:	FCC Part 15 B Class B(QP)	Time:	16:58:56
Test item:	Conduction test	Temp.(°C)/Hum.(%):	24(°C)/50%
Mode:	5	Test Voltage:	AC 120V/60Hz
Description:			

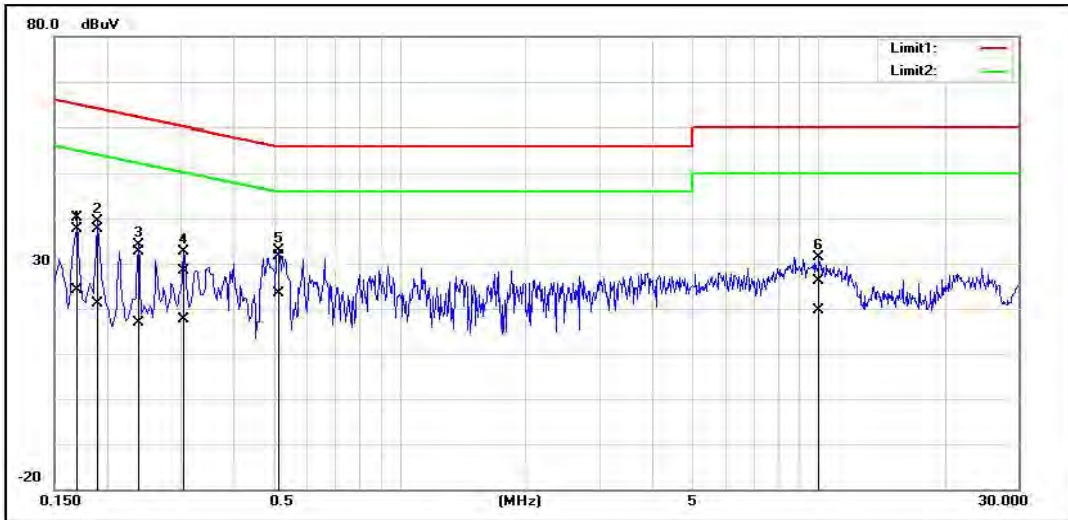

No.	Frequency (MHz)	QuasiPeak reading (dBuV)	Average reading (dBuV)	Correction factor (dB)	QuasiPeak result (dBuV)	Average result (dBuV)	QuasiPeak limit (dBuV)	Average limit (dBuV)	QuasiPeak margin (dB)	Average margin (dB)	Remark
1	0.1700	30.32	14.44	9.73	40.05	24.17	64.96	54.96	-24.91	-30.79	Pass
2	0.1900	27.91	11.45	9.73	37.64	21.18	64.03	54.04	-26.39	-32.86	Pass
3	0.2380	22.82	7.06	9.73	32.55	16.79	62.16	52.17	-29.61	-35.38	Pass
4	0.3060	18.65	7.85	9.74	28.39	17.59	60.08	50.08	-31.69	-32.49	Pass
5*	0.5140	21.77	13.65	9.74	31.51	23.39	56.00	46.00	-24.49	-22.61	Pass
6	10.0420	16.16	9.55	9.96	26.12	19.51	60.00	50.00	-33.88	-30.49	Pass

Unless otherwise stated the results shown in this test report refer only to the sample(s) tested and such sample(s) are retained for 90 days only.

除非另有說明，此報告結果僅對測試之樣品負責，同時此樣品僅保留90天。本報告未經本公司書面許可，不可部份複製。

This document is issued by the Company subject to its General Conditions of Service printed overleaf, available on request or accessible at www.sgs.com/terms_and_conditions.htm and for electronic format documents, subject to Terms and Conditions for Electronic Documents at www.sgs.com/terms_e-document.htm. Attention is drawn to the limitation of liability, indemnification and jurisdiction issues defined therein. Any holder of this document is advised that information contained hereon reflects the Company's findings at the time of its intervention only and within the limits of Client's instructions, if any. The Company's sole responsibility is to its Client and this document does not exonerate parties to a transaction from exercising all their rights and obligations under the transaction documents. This document cannot be reproduced except in full, without prior written approval of the Company. Any unauthorized alteration, forgery or falsification of the content or appearance of this document is unlawful and offenders may be prosecuted to the fullest extent of the law.



2.5 Test of Radiated Emission

2.5.1 Test Equipments

Below 1GHz

Radiated Emission 10m					
Name of Equipment	Manufacturer	Model	Serial Number	Calibration Date	Calibration Due
Bilog Antenna	TESEQ	CBL 6112D	31674	Mar. 06th, 2019	Mar. 05th, 2020
Bilog Antenna	TESEQ	CBL 6112D	31675	Mar. 22th, 2019	Mar. 21th, 2020
Coaxial Cable	Huber+Suhner	SUCOFLEX 104PEA	330029	May 02th, 2018	May 01th, 2019
Coaxial Cable	Huber+Suhner	SUCOFLEX 104PEA	329383	May 02th, 2018	May 01th, 2019
Coaxial Cable	Huber+Suhner	104PEA	33949/4PEA	May 02th, 2018	May 01th, 2019
Coaxial Cable	Huber+Suhner	104PEA	33948/4PEA	May 02th, 2018	May 01th, 2019
EMI Test Receiver	R&S	ESCI	100961	Jul. 04th, 2018	Jul. 03th, 2019
EMI Test Receiver	R&S	ESCI	100962	Jul. 10th, 2018	Jul. 09th, 2019
Horn Antenna	ETS LINDGREN	3116	00026370	Dec. 26th, 2018	Dec. 25th, 2019
Horn Antenna	EMCO	3117	00055167	Dec. 24th, 2018	Dec. 23th, 2019
Pre-Amplifier	HP	8447D	2944A07754	May 02th, 2018	May 01th, 2019
Pre-Amplifier	HP	8447D	2944A08150	May 02th, 2018	May 01th, 2019
Pre-Amplifier	EMCI	EMC051845	980040	May 02th, 2018	May 01th, 2019
Pre-Amplifier	MITEQ	AMF-6F-260400-40-8P	985646	Jun. 21th, 2018	Jun. 20th, 2019
Spectrum Analyzer	Agilent	E4446A	MY48250297	Aug. 30th, 2018	Aug. 29th, 2019
AC POWER SOURE	APE	AFC-130	991259	N.C.R	N.C.R
Antenna Tower	CCS	CC-A-1F	N/A	N.C.R	N.C.R
Antenna Tower	Sunol Sciences	TLT2	031010-5	N.C.R	N.C.R
Controller	Sunol Sciences	SC104V	031010-1	N.C.R	N.C.R
Controller	CCS	CC-C-1F	N/A	N.C.R	N.C.R
Turn Table	CCS	CC-T-1F	N/A	N.C.R	N.C.R
Software	EZ-EMC (CCS-3A1RE)				
Compliance Certification Services Inc. (Wugu Laboratory) No.139, Wugong Rd., Wugu Dist., New Taipei City 24886, Taiwan (R.O.C.) Measurement Uncertainty of Radiated Emission Expanded uncertainty of radiated emission is 4.45 dB. (30MHz ~ 200MHz) Expanded uncertainty of radiated emission is 4.80 dB. (200MHz ~ 1000MHz)					

Unless otherwise stated the results shown in this test report refer only to the sample(s) tested and such sample(s) are retained for 90 days only.

除非另有說明，此報告結果僅對測試之樣品負責，同時此樣品僅保留90天。本報告未經本公司書面許可，不可部份複製。

This document is issued by the Company subject to its General Conditions of Service printed overleaf, available on request or accessible at www.sgs.com/terms_and_conditions.htm and for electronic format documents, subject to Terms and Conditions for Electronic Documents at www.sgs.com/terms_e-document.htm. Attention is drawn to the limitation of liability, indemnification and jurisdiction issues defined therein. Any holder of this document is advised that information contained hereon reflects the Company's findings at the time of its intervention only and within the limits of Client's instructions, if any. The Company's sole responsibility is to its Client and this document does not exonerate parties to a transaction from exercising all their rights and obligations under the transaction documents. This document cannot be reproduced except in full, without prior written approval of the Company. Any unauthorized alteration, forgery or falsification of the content or appearance of this document is unlawful and offenders may be prosecuted to the fullest extent of the law.



Above 1GHz

Radiated Emission_10m					
Name of Equipment	Manufacturer	Model	Serial Number	Calibration Date	Calibration Due
Bilog Antenna	TESEQ	CBL 6112D	31674	Mar. 06th, 2019	Mar. 05th, 2020
Bilog Antenna	TESEQ	CBL 6112D	31675	Mar. 22th, 2019	Mar. 21th, 2020
Coaxial Cable	Huber+Suhner	SUCOFLEX 104PEA	330029	May 02th, 2018	May 01th, 2019
Coaxial Cable	Huber+Suhner	SUCOFLEX 104PEA	329383	May 02th, 2018	May 01th, 2019
Coaxial Cable	Huber+Suhner	104PEA	33949/4PEA	May 02th, 2018	May 01th, 2019
Coaxial Cable	Huber+Suhner	104PEA	33948/4PEA	May 02th, 2018	May 01th, 2019
EMI Test Receiver	R&S	ESCI	100961	Jul. 04th, 2018	Jul. 03th, 2019
EMI Test Receiver	R&S	ESCI	100962	Jul. 10th, 2018	Jul. 09th, 2019
Horn Antenna	ETS LINDGREN	3116	00026370	Dec. 26th, 2018	Dec. 25th, 2019
Horn Antenna	EMCO	3117	00055167	Dec. 24th, 2018	Dec. 23th, 2019
Pre-Amplifier	HP	8447D	2944A07754	May 02th, 2018	May 01th, 2019
Pre-Amplifier	HP	8447D	2944A08150	May 02th, 2018	May 01th, 2019
Pre-Amplifier	EMCI	EMC051845	980040	May 02th, 2018	May 01th, 2019
Pre-Amplifier	MITEQ	AMF-6F- 260400-40-8P	985646	Jun. 21th, 2018	Jun. 20th, 2019
Spectrum Analyzer	Agilent	E4446A	MY48250297	Aug. 30th, 2018	Aug. 29th, 2019
AC POWER SOURE	APE	AFC-130	991259	N.C.R	N.C.R
Antenna Tower	CCS	CC-A-1F	N/A	N.C.R	N.C.R
Antenna Tower	Sunol Sciences	TLT2	031010-5	N.C.R	N.C.R
Controller	Sunol Sciences	SC104V	031010-1	N.C.R	N.C.R
Controller	CCS	CC-C-1F	N/A	N.C.R	N.C.R
Turn Table	CCS	CC-T-1F	N/A	N.C.R	N.C.R
Software	EZ-EMC (CCS-3A1RE)				
Compliance Certification Services Inc. (Wugu Laboratory) No.139, Wugong Rd., Wugu Dist., New Taipei City 24886, Taiwan (R.O.C.) Measurement Uncertainty of Radiated Emission Expanded uncertainty of radiated emission is 4.80 dB. (1000MHz ~ 6000MHz) Expanded uncertainty of radiated emission is 5.25 dB. (6000MHz ~ 18000MHz) Expanded uncertainty of radiated emission is 3.93 dB. (18000MHz ~ 26000MHz) Expanded uncertainty of radiated emission is 3.97 dB. (26000MHz ~ 40000MHz)					

Unless otherwise stated the results shown in this test report refer only to the sample(s) tested and such sample(s) are retained for 90 days only.

除非另有說明，此報告結果僅對測試之樣品負責，同時此樣品僅保留90天。本報告未經本公司書面許可，不可部份複製。

This document is issued by the Company subject to its General Conditions of Service printed overleaf, available on request or accessible at www.sgs.com/terms_and_conditions.htm and for electronic format documents, subject to Terms and Conditions for Electronic Documents at www.sgs.com/terms_e-document.htm. Attention is drawn to the limitation of liability, indemnification and jurisdiction issues defined therein. Any holder of this document is advised that information contained hereon reflects the Company's findings at the time of its intervention only and within the limits of Client's instructions, if any. The Company's sole responsibility is to its Client and this document does not exonerate parties to a transaction from exercising all their rights and obligations under the transaction documents. This document cannot be reproduced except in full, without prior written approval of the Company. Any unauthorized alteration, forgery or falsification of the content or appearance of this document is unlawful and offenders may be prosecuted to the fullest extent of the law.



2.5.2 Operating Environment

Temperature : 26 degree C

Humidity : 60 %RH

Atmospheric Pressure : 996 mBar

2.5.3 Measurement Level Calculation

Correction Factor = Antenna Factor + Cable loss- Amplifier Gain

Measurement Level = Reading Level + Correction Factor

Over (Margin) = Measurement Level – Limit

Unless otherwise stated the results shown in this test report refer only to the sample(s) tested and such sample(s) are retained for 90 days only.

除非另有說明，此報告結果僅對測試之樣品負責，同時此樣品僅保留90天。本報告未經本公司書面許可，不可部份複製。

This document is issued by the Company subject to its General Conditions of Service printed overleaf, available on request or accessible at www.sgs.com/terms_and_conditions.htm and for electronic format documents, subject to Terms and Conditions for Electronic Documents at www.sgs.com/terms_e-document.htm. Attention is drawn to the limitation of liability, indemnification and jurisdiction issues defined therein. Any holder of this document is advised that information contained hereon reflects the Company's findings at the time of its intervention only and within the limits of Client's instructions, if any. The Company's sole responsibility is to its Client and this document does not exonerate parties to a transaction from exercising all their rights and obligations under the transaction documents. This document cannot be reproduced except in full, without prior written approval of the Company. Any unauthorized alteration, forgery or falsification of the content or appearance of this document is unlawful and offenders may be prosecuted to the fullest extent of the law.



2.5.4 Measurement Data

Below 1GHz

Model No.:801FJ

Mode_5_H

Test site:	10M Chamber	Ant.Polar.:	Horizontal
Standard:	FCC Part 15B Class B	Test Distance:	10m
Test item:	Radiation Test	Power:	AC 120V/60Hz
Temp.(°C)/Hum.(%RH):	26(°C)/60%RH	Date:2019/4/18	Time:21:35:07
Mode:	5		
Description:			

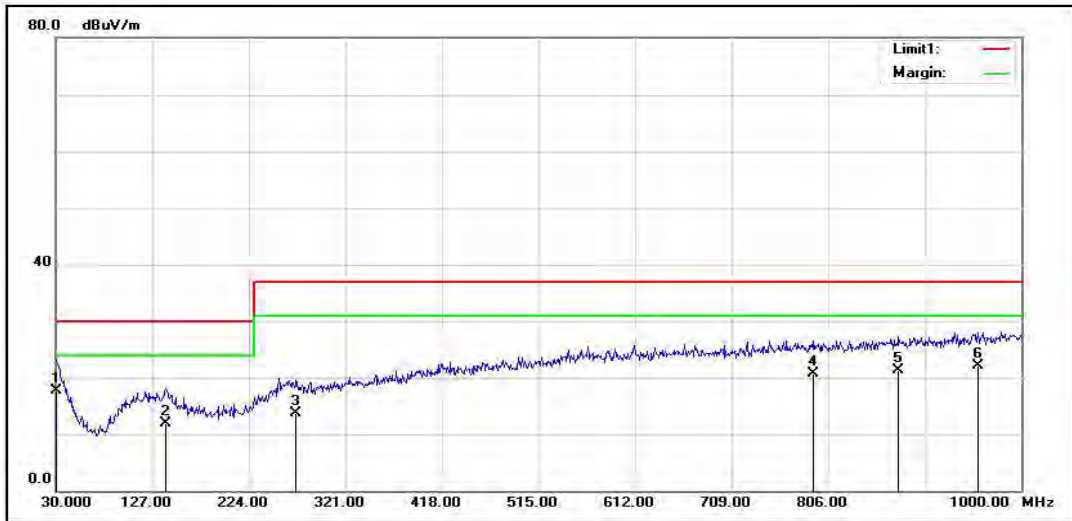

No.	Frequency (MHz)	Reading (dBuV)	Correct Factor(dB/m)	Result (dBuV/m)	Limit (dBuV/m)	Margin (dB)	Height (cm)	Degree (°)	Remark
1	30.9700	21.21	-3.57	17.64	30.00	-12.36	237	0	QP
2	140.5800	21.25	-9.25	12.00	30.00	-18.00	399	160	QP
3	271.5300	19.13	-5.52	13.61	37.00	-23.39	399	0	QP
4	791.4500	19.09	1.57	20.66	37.00	-16.34	164	0	QP
5	876.8100	18.75	2.63	21.38	37.00	-15.62	174	0	QP
6	956.3500	18.47	3.57	22.04	37.00	-14.96	294	0	QP

Unless otherwise stated the results shown in this test report refer only to the sample(s) tested and such sample(s) are retained for 90 days only.

除非另有說明，此報告結果僅對測試之樣品負責，同時此樣品僅保留90天。本報告未經本公司書面許可，不可部份複製。

This document is issued by the Company subject to its General Conditions of Service printed overleaf, available on request or accessible at www.sgs.com/terms_and_conditions.htm and for electronic format documents, subject to Terms and Conditions for Electronic Documents at www.sgs.com/terms_e-document.htm. Attention is drawn to the limitation of liability, indemnification and jurisdiction issues defined therein. Any holder of this document is advised that information contained hereon reflects the Company's findings at the time of its intervention only and within the limits of Client's instructions, if any. The Company's sole responsibility is to its Client and this document does not exonerate parties to a transaction from exercising all their rights and obligations under the transaction documents. This document cannot be reproduced except in full, without prior written approval of the Company. Any unauthorized alteration, forgery or falsification of the content or appearance of this document is unlawful and offenders may be prosecuted to the fullest extent of the law.



Mode_5_V

Test site:	10M Chamber	Ant.Polar.:	Vertical
Standard:	FCC Part 15B Class B	Test Distance:	10m
Test item:	Radiation Test	Power:	AC 120V/60Hz
Temp.(°C)/Hum.(%RH):	26(°C)/60%RH	Date: 2019/4/18	Time: 21:35:08
Mode:	5		
Description:			

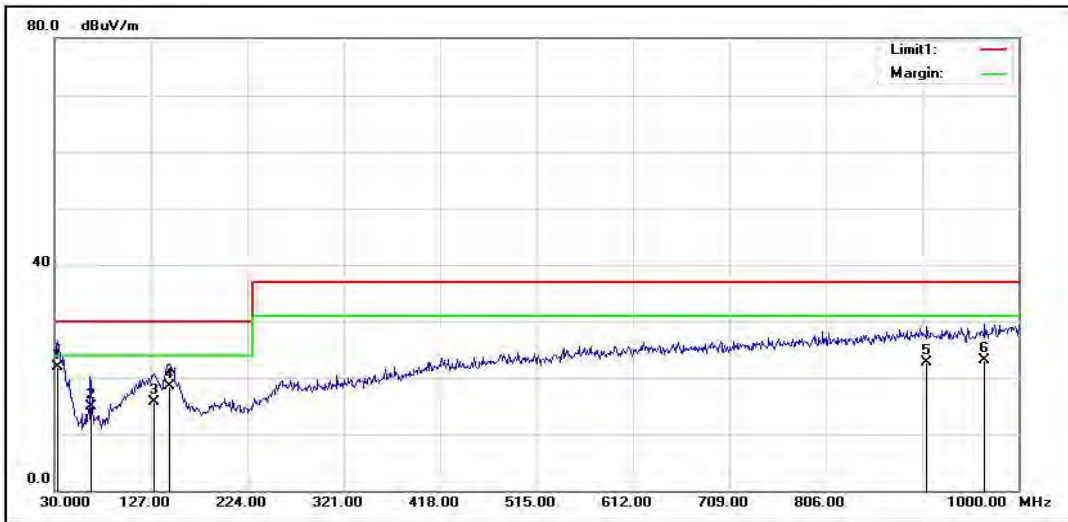

No.	Frequency (MHz)	Reading (dBuV)	Correct Factor(dB/m)	Result (dBuV/m)	Limit (dBuV/m)	Margin (dB)	Height (cm)	Degree (°)	Remark
1	32.9100	25.67	-3.76	21.91	30.00	-8.09	105	0	QP
2	66.5300	29.12	-14.15	14.97	30.00	-15.03	219	64	QP
3	129.9100	23.70	-7.92	15.78	30.00	-14.22	117	0	QP
4	145.4300	27.03	-8.54	18.49	30.00	-11.51	100	0	QP
5	907.8500	17.48	5.28	22.76	37.00	-14.24	219	0	QP
6	966.0500	17.03	5.99	23.02	37.00	-13.98	100	0	QP

Unless otherwise stated the results shown in this test report refer only to the sample(s) tested and such sample(s) are retained for 90 days only.

除非另有說明，此報告結果僅對測試之樣品負責，同時此樣品僅保留90天。本報告未經本公司書面許可，不可部份複製。

This document is issued by the Company subject to its General Conditions of Service printed overleaf, available on request or accessible at www.sgs.com/terms_and_conditions.htm and for electronic format documents, subject to Terms and Conditions for Electronic Documents at www.sgs.com/terms_e-document.htm. Attention is drawn to the limitation of liability, indemnification and jurisdiction issues defined therein. Any holder of this document is advised that information contained hereon reflects the Company's findings at the time of its intervention only and within the limits of Client's instructions, if any. The Company's sole responsibility is to its Client and this document does not exonerate parties to a transaction from exercising all their rights and obligations under the transaction documents. This document cannot be reproduced except in full, without prior written approval of the Company. Any unauthorized alteration, forgery or falsification of the content or appearance of this document is unlawful and offenders may be prosecuted to the fullest extent of the law.



Above 1GHz

Model No.:801FJ

Mode_5_H

Test site:	10M Chamber	Ant.Polar.:	Horizontal
Standard:	FCC Part 15B 3M Class B	Test Distance:	3m
Test item:	Radiation Test	Power:	AC 120V/60Hz
Temp.(°C)/Hum.(%RH):	26(°C)/60%RH	Date:2019/4/23	Time:18:21:45
Mode:	5		
Description:			

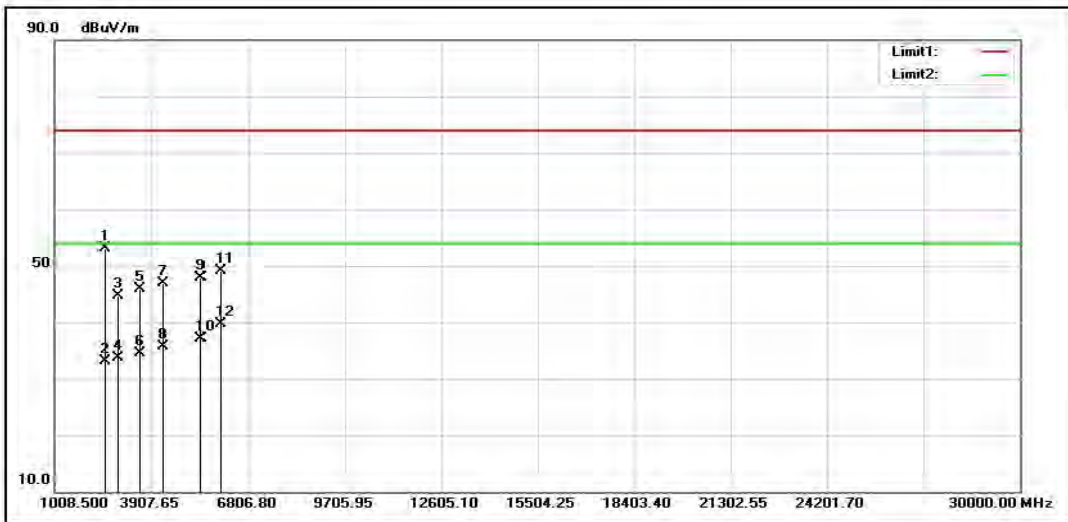

No.	Frequency (MHz)	Reading (dBuV)	Correct Factor(dB/m)	Result (dBuV/m)	Limit (dBuV/m)	Margin (dB)	Height (cm)	Degree (°)	Remark
1	2521.500	67.17	-14.02	53.15	74.00	-20.85	100	128	peak
2	2521.500	47.20	-14.02	33.18	54.00	-20.82	100	128	AVG
3	2921.000	57.54	-12.84	44.70	74.00	-29.30	100	167	peak
4	2921.000	46.61	-12.84	33.77	54.00	-20.23	100	167	AVG
5	3584.000	57.33	-11.44	45.89	74.00	-28.11	300	359	peak
6	3584.000	46.04	-11.44	34.60	54.00	-19.40	300	359	AVG
7	4272.500	56.93	-10.01	46.92	74.00	-27.08	100	358	peak
8	4272.500	45.67	-10.01	35.66	54.00	-18.34	100	358	AVG
9	5369.000	55.45	-7.56	47.89	74.00	-26.11	230	360	peak
10	5369.000	44.67	-7.56	37.11	54.00	-16.89	230	360	AVG
11	5938.500	54.71	-5.54	49.17	74.00	-24.83	202	360	peak
12	5938.500	45.18	-5.54	39.64	54.00	-14.36	202	360	AVG

Unless otherwise stated the results shown in this test report refer only to the sample(s) tested and such sample(s) are retained for 90 days only.

除非另有說明，此報告結果僅對測試之樣品負責，同時此樣品僅保留90天。本報告未經本公司書面許可，不可部份複製。

This document is issued by the Company subject to its General Conditions of Service printed overleaf, available on request or accessible at www.sgs.com/terms_and_conditions.htm and for electronic format documents, subject to Terms and Conditions for Electronic Documents at www.sgs.com/terms_e-document.htm. Attention is drawn to the limitation of liability, indemnification and jurisdiction issues defined therein. Any holder of this document is advised that information contained hereon reflects the Company's findings at the time of its intervention only and within the limits of Client's instructions, if any. The Company's sole responsibility is to its Client and this document does not exonerate parties to a transaction from exercising all their rights and obligations under the transaction documents. This document cannot be reproduced except in full, without prior written approval of the Company. Any unauthorized alteration, forgery or falsification of the content or appearance of this document is unlawful and offenders may be prosecuted to the fullest extent of the law.



Mode_5_V

Test site:	10M Chamber	Ant.Polar.:	Vertical
Standard:	FCC Part 15B 3M Class B	Test Distance:	3m
Test item:	Radiation Test	Power:	AC 120V/60Hz
Temp.(°C)/Hum.(%RH):	26(°C)/60%RH	Date:2019/4/23	Time:18:21:41
Mode:	5		
Description:			

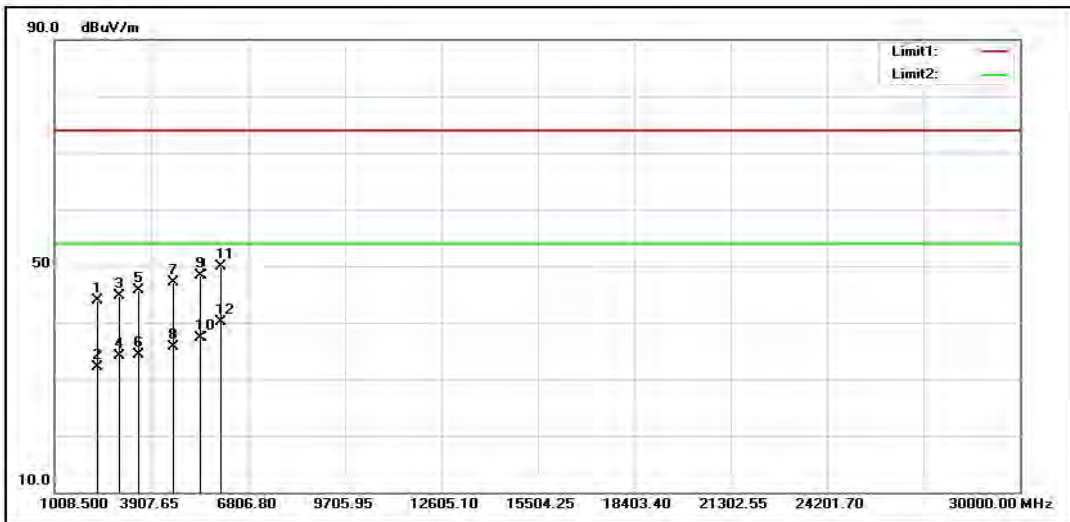

No.	Frequency (MHz)	Reading (dBuV)	Correct Factor(dB/m)	Result (dBuV/m)	Limit (dBuV/m)	Margin (dB)	Height (cm)	Degree (°)	Remark
1	2292.000	58.19	-14.35	43.84	74.00	-30.16	400	243	peak
2	2292.000	46.47	-14.35	32.12	54.00	-21.88	400	243	AVG
3	2929.500	57.59	-12.83	44.76	74.00	-29.24	200	360	peak
4	2929.500	47.02	-12.83	34.19	54.00	-19.81	200	360	AVG
5	3507.500	57.65	-11.91	45.74	74.00	-28.26	200	2	peak
6	3507.500	46.27	-11.91	34.36	54.00	-19.64	200	2	AVG
7	4570.000	56.16	-9.13	47.03	74.00	-26.97	100	360	peak
8	4570.000	44.78	-9.13	35.65	54.00	-18.35	100	360	AVG
9	5377.500	55.81	-7.55	48.26	74.00	-25.74	300	193	peak
10	5377.500	44.89	-7.55	37.34	54.00	-16.66	300	193	AVG
11	5989.500	55.13	-5.16	49.97	74.00	-24.03	400	359	peak
12	5989.500	45.28	-5.16	40.12	54.00	-13.88	400	359	AVG

Unless otherwise stated the results shown in this test report refer only to the sample(s) tested and such sample(s) are retained for 90 days only.

除非另有說明，此報告結果僅對測試之樣品負責，同時此樣品僅保留90天。本報告未經本公司書面許可，不可部份複製。

This document is issued by the Company subject to its General Conditions of Service printed overleaf, available on request or accessible at www.sgs.com/terms_and_conditions.htm and for electronic format documents, subject to Terms and Conditions for Electronic Documents at www.sgs.com/terms_e-document.htm. Attention is drawn to the limitation of liability, indemnification and jurisdiction issues defined therein. Any holder of this document is advised that information contained hereon reflects the Company's findings at the time of its intervention only and within the limits of Client's instructions, if any. The Company's sole responsibility is to its Client and this document does not exonerate parties to a transaction from exercising all their rights and obligations under the transaction documents. This document cannot be reproduced except in full, without prior written approval of the Company. Any unauthorized alteration, forgery or falsification of the content or appearance of this document is unlawful and offenders may be prosecuted to the fullest extent of the law.