

ELECTROMAGNETIC EMISSIONS COMPLIANCE REPORT

INTENTIONAL RADIATOR CERTIFICATION TO FCC PART 24 SUBPART E H REQUIREMENT

OF

Applicant: FUJITSU CONNECTED TECHNOLOGIES Ltd.
1-1, Kamikodanaka 4-chome, Nakahara-ku, Kawasaki 211-8588,
Japan

Product Name: Smart Phone

Brand Name: FUJITSU

Model No.: 801FJ

Model Difference: N/A

FCC ID: 2AQYEFMP170

Report Number: T190327W10-RP1

FCC Rule Part: 2 ,24E

Issue Date: May 9th, 2019

Date of Test: Mar. 27th, 2019~Apr. 18th, 2019

Date of EUT Received: Mar. 27th, 2019

Issued by: Compliance Certification Services Inc.Wugu Lab.
No.11, Wugong 6th Rd., Wugu Dist., New Taipei City 24891,
Taiwan. (R.O.C.)
service@ccsrf.com

The test Result was tested by Compliance Certification Services Inc. The test data, data evaluation, test procedures, and equipment configurations shown in this report were given in ANSI C63.26-2015 and compliance standards.

The test results of this report relate only to the tested sample (EUT) identified in this report
The test Report of full or partial shall not copy. Without written approval of Compliance Certification Services Inc. (Wugu Laboratory).

Tested By:



Jerry Lu / Sr. Engineer

Approved By:



Kevin Tsai / Deputy Manager



Unless otherwise stated the results shown in this test report refer only to the sample(s) tested and such sample(s) are retained for 90 days only.

除非另有說明，此報告結果僅對測試之樣品負責，同時此樣品僅保留90天。本報告未經本公司書面許可，不可部份複製。

This document is issued by the Company subject to its General Conditions of Service printed overleaf, available on request or accessible at www.sgs.com/terms_and_conditions.htm and for electronic format documents, subject to Terms and Conditions for Electronic Documents at www.sgs.com/terms_e-document.htm. Attention is drawn to the limitation of liability, indemnification and jurisdiction issues defined therein. Any holder of this document is advised that information contained hereon reflects the Company's findings at the time of its intervention only and within the limits of Client's instructions, if any. The Company's sole responsibility is to its Client and this document does not exonerate parties to a transaction from exercising all their rights and obligations under the transaction documents. This document cannot be reproduced except in full, without prior written approval of the Company. Any unauthorized alteration, forgery or falsification of the content or appearance of this document is unlawful and offenders may be prosecuted to the fullest extent of the law.

Revision History

Report Number	Revision	Description	Effected Page	Issue Date	Revised By
T190327W10-RP1	Rev.00	Initial creation of document	All	May 9th, 2019	Violetta Tang

Unless otherwise stated the results shown in this test report refer only to the sample(s) tested and such sample(s) are retained for 90 days only.

除非另有說明，此報告結果僅對測試之樣品負責，同時此樣品僅保留90天。本報告未經本公司書面許可，不可部份複製。

This document is issued by the Company subject to its General Conditions of Service printed overleaf, available on request or accessible at www.sgs.com/terms_and_conditions.htm and for electronic format documents, subject to Terms and Conditions for Electronic Documents at www.sgs.com/terms_e-document.htm. Attention is drawn to the limitation of liability, indemnification and jurisdiction issues defined therein. Any holder of this document is advised that information contained hereon reflects the Company's findings at the time of its intervention only and within the limits of Client's instructions, if any. The Company's sole responsibility is to its Client and this document does not exonerate parties to a transaction from exercising all their rights and obligations under the transaction documents. This document cannot be reproduced except in full, without prior written approval of the Company. Any unauthorized alteration, forgery or falsification of the content or appearance of this document is unlawful and offenders may be prosecuted to the fullest extent of the law.

Contents

1. GENERAL PRODUCT INFORMATION	4
2. SYSTEM TEST CONFIGURATION	7
3. SUMMARY OF TEST RESULTS	10
4. DESCRIPTION OF TEST MODES	11
5. MEASUREMENT UNCERTAINTY	14
6. RF CONDUCTED OUTPUT POWER MEASUREMENT	15
7. OCCUPIED BANDWIDTH MEASUREMENT	28
8. OUT OF BAND EMISSION AT ANTENNA TERMINALS	40
9. FIELD STRENGTH OF SPURIOUS RADIATION MEASUREMENT	59
10. FREQUENCY STABILITY MEASUREMENT	82
11. PEAK TO AVERAGE RATIO	87

Unless otherwise stated the results shown in this test report refer only to the sample(s) tested and such sample(s) are retained for 90 days only.

除非另有說明，此報告結果僅對測試之樣品負責，同時此樣品僅保留90天。本報告未經本公司書面許可，不可部份複製。

This document is issued by the Company subject to its General Conditions of Service printed overleaf, available on request or accessible at www.sgs.com/terms_and_conditions.htm and for electronic format documents, subject to Terms and Conditions for Electronic Documents at www.sgs.com/terms_e-document.htm. Attention is drawn to the limitation of liability, indemnification and jurisdiction issues defined therein. Any holder of this document is advised that information contained hereon reflects the Company's findings at the time of its intervention only and within the limits of Client's instructions, if any. The Company's sole responsibility is to its Client and this document does not exonerate parties to a transaction from exercising all their rights and obligations under the transaction documents. This document cannot be reproduced except in full, without prior written approval of the Company. Any unauthorized alteration, forgery or falsification of the content or appearance of this document is unlawful and offenders may be prosecuted to the fullest extent of the law.

1. GENERAL PRODUCT INFORMATION

1.1. Product Description

General:

Product Name:	Smart Phone	
Brand Name:	FUJITSU	
Model No.:	801FJ	
Model difference:	N/A	
Hardware Version:	V2.0.0	
Software Version:	V04R033A	
Power Supply:	3.85Vdc from Rechargeable Li-ion Battery or 5Vdc /7Vdc / 9Vdc /12Vdc from AC/DC Adapter	
	Battery:	Model No.: CA08723-1021, Supplier: FUJITSU CONNECTED TECHNOLOGIES LIMITED
	Adapter:	Model No.: SB-AC20-TCPD Supplier: SoftBank SELECTION
Antenna Designation:	$\lambda/4$ Monopole Antenna, Gain: -0.38dBi (GSM/GPRS 1900, WCDMA B2, LTE B2)	
IMEI:	353664100040357	

1.2. GSM / WCDMA / LTE: Cellular Phone Standards Frequency Range

Operating Frequency (MHz)		
GSM/GPRS 1900	1850.2	- 1909.8

Operating Frequency (MHz)		
WCDMA / HSPA+ Band II	1852.4	- 1907.6

LTE Band	BW (MHz)	Operation Frequency (MHz)	
2	1.4	1850.7	- 1909.3
	3	1851.5	- 1908.5
	5	1852.5	- 1907.5
	10	1855.0	- 1905.0
	15	1857.5	- 1902.5
	20	1860.0	- 1900.0

Unless otherwise stated the results shown in this test report refer only to the sample(s) tested and such sample(s) are retained for 90 days only.

除非另有說明，此報告結果僅對測試之樣品負責，同時此樣品僅保留90天。本報告未經本公司書面許可，不可部份複製。

This document is issued by the Company subject to its General Conditions of Service printed overleaf, available on request or accessible at www.sgs.com/terms_and_conditions.htm and for electronic format documents, subject to Terms and Conditions for Electronic Documents at www.sgs.com/terms_e-document.htm. Attention is drawn to the limitation of liability, indemnification and jurisdiction issues defined therein. Any holder of this document is advised that information contained hereon reflects the Company's findings at the time of its intervention only and within the limits of Client's instructions, if any. The Company's sole responsibility is to its Client and this document does not exonerate parties to a transaction from exercising all their rights and obligations under the transaction documents. This document cannot be reproduced except in full, without prior written approval of the Company. Any unauthorized alteration, forgery or falsification of the content or appearance of this document is unlawful and offenders may be prosecuted to the fullest extent of the law.

1.3. Type of Emission & Max ERP/EIRP Power Measurement Result:

	ERP / EIRP (dBm)		(W)	Type of Emission
GSM 1900	28.69	EIRP	0.740	245KGXW
GPRS 1900	28.69	EIRP	0.740	249KGXW

	ERP / EIRP (dBm)		(W)	Type of Emission
WCDMA Band II	23.06	EIRP	0.202	4M12F9W
HSDPA Band II	22.11	EIRP	0.163	4M12F9W
HSUPA Band II	22.09	EIRP	0.162	4M12F9W

LTE Band	BW	Modulation	ERP / EIRP (dBm)		(W)	Type of Emission
2	1.4	QPSK	22.57	EIRP	0.181	1M10G7D
		16QAM	21.44	EIRP	0.139	1M10D7W
2	3	QPSK	22.43	EIRP	0.175	2M70G7D
		16QAM	21.73	EIRP	0.149	2M70D7W
2	5	QPSK	22.39	EIRP	0.173	4M51G7D
		16QAM	21.34	EIRP	0.136	4M50D7W
2	10	QPSK	22.44	EIRP	0.175	8M99G7D
		16QAM	21.18	EIRP	0.131	8M96D7W
2	15	QPSK	22.40	EIRP	0.174	13M5G7D
		16QAM	21.42	EIRP	0.139	13M4D7W
2	20	QPSK	22.51	EIRP	0.178	17M9G7D
		16QAM	21.76	EIRP	0.150	17M9D7W

Unless otherwise stated the results shown in this test report refer only to the sample(s) tested and such sample(s) are retained for 90 days only.

除非另有說明，此報告結果僅對測試之樣品負責，同時此樣品僅保留90天。本報告未經本公司書面許可，不可部份複製。

This document is issued by the Company subject to its General Conditions of Service printed overleaf, available on request or accessible at www.sgs.com/terms_and_conditions.htm and for electronic format documents, subject to Terms and Conditions for Electronic Documents at www.sgs.com/terms_e-document.htm. Attention is drawn to the limitation of liability, indemnification and jurisdiction issues defined therein. Any holder of this document is advised that information contained hereon reflects the Company's findings at the time of its intervention only and within the limits of Client's instructions, if any. The Company's sole responsibility is to its Client and this document does not exonerate parties to a transaction from exercising all their rights and obligations under the transaction documents. This document cannot be reproduced except in full, without prior written approval of the Company. Any unauthorized alteration, forgery or falsification of the content or appearance of this document is unlawful and offenders may be prosecuted to the fullest extent of the law.

1.4. Test Methodology of Applied Standards

CC 47 CFR Part 2, 24

ANSI C63.26-2015

KDB971168 D01 Power Meas license Digital System v03

KDB941225 D01 SAR test for 3G devices v03r01 (SAR Measurement Procedures for 3G Devices, WCDMA / HSPA) was used for EUT and Base station setting.

KDB648474 D03 Wireless Chargers Battery Cover

TS 151 010-1 is used to set, and measure the output power.

Note: All test items have been performed and record as per the above standards.

1.5. Test Facility

Compliance Certification Services Inc. Wugu Lab. No.11, Wugong 6th Rd.,

Wugu Dist., New Taipei City 24891, Taiwan. (R.O.C.) (TAF code 1309)

FCC Designation number: TW1309

1.6. Special Accessories

No special accessories were used during testing.

1.7. Equipment Modifications

There were no modifications incorporated into the EUT.

Unless otherwise stated the results shown in this test report refer only to the sample(s) tested and such sample(s) are retained for 90 days only.

除非另有說明，此報告結果僅對測試之樣品負責，同時此樣品僅保留90天。本報告未經本公司書面許可，不可部份複製。

This document is issued by the Company subject to its General Conditions of Service printed overleaf, available on request or accessible at www.sgs.com/terms_and_conditions.htm and for electronic format documents, subject to Terms and Conditions for Electronic Documents at www.sgs.com/terms_e-document.htm. Attention is drawn to the limitation of liability, indemnification and jurisdiction issues defined therein. Any holder of this document is advised that information contained hereon reflects the Company's findings at the time of its intervention only and within the limits of Client's instructions, if any. The Company's sole responsibility is to its Client and this document does not exonerate parties to a transaction from exercising all their rights and obligations under the transaction documents. This document cannot be reproduced except in full, without prior written approval of the Company. Any unauthorized alteration, forgery or falsification of the content or appearance of this document is unlawful and offenders may be prosecuted to the fullest extent of the law.

2. SYSTEM TEST CONFIGURATION

2.1. EUT Configuration

The EUT configuration for testing is installed on RF field strength measurement to meet the Commissions requirement and operating in a manner which intends to maximize its emission characteristics in a continuous normal application.

2.2. EUT Exercise

The EUT (Transmitter) was operated in the continuous transmission mode employed with the simulator of the Base Station that fixates at test default channels to fix the Tx frequency which was for the purpose of the measurements.

2.3. Test Procedure

2.3.1 Conducted Measurement at Antenna Port

According to measurement procured ANSI C63.26-2015, the EUT is placed on a turn table which is 0.8 m above ground plane. A low loss of RF cable was used to connect the antenna port of EUT to measurement equipment.

2.3.2 Radiated Emissions (ERP/EIRP)

According to measurement procured ANSI C63.26-2015, The EUT is a placed on as turn table, for emission measurements below 1 GHz is 0.8 m above ground plane, for emission measurements above 1 GHz, the table height shall be 1.5 m. The turn table shall rotate 360 degrees to determine the position of maximum emission level. EUT is set 3m away from the receiving antenna which varied from 1m to 4m to find out the highest emission. And also, each emission was to be maximized by changing the polarization of receiving antenna both Horizontal and Vertical. In order to find out the max. emission, the relative positions of this hand-held transmitter (EUT) was rotated through three orthogonal axes and measurement procedures for electric field radiated emissions above 1 GHz the EUT measurement is to be made "while keeping the antenna in the 'cone of radiation' from that area and pointed at the area both in azimuth and elevation, with polarization oriented for maximum response." is still within the 3dB illumination BW of the measurement antenna according to the requirements in Section 8 and 13.

2.4. Measurement Results Explanation Example

For all conducted test items:

The offset level is set in the spectrum analyzer to compensate the RF cable loss and attenuation factor between EUT conducted port and spectrum analyzer. With the offset compensation, the spectrum analyzer reading level is exactly EUT RF output level.

Unless otherwise stated the results shown in this test report refer only to the sample(s) tested and such sample(s) are retained for 90 days only.

除非另有說明，此報告結果僅對測試之樣品負責，同時此樣品僅保留90天。本報告未經本公司書面許可，不可部份複製。

This document is issued by the Company subject to its General Conditions of Service printed overleaf, available on request or accessible at www.sgs.com/terms_and_conditions.htm and for electronic format documents, subject to Terms and Conditions for Electronic Documents at www.sgs.com/terms_e-document.htm. Attention is drawn to the limitation of liability, indemnification and jurisdiction issues defined therein. Any holder of this document is advised that information contained hereon reflects the Company's findings at the time of its intervention only and within the limits of Client's instructions, if any. The Company's sole responsibility is to its Client and this document does not exonerate parties to a transaction from exercising all their rights and obligations under the transaction documents. This document cannot be reproduced except in full, without prior written approval of the Company. Any unauthorized alteration, forgery or falsification of the content or appearance of this document is unlawful and offenders may be prosecuted to the fullest extent of the law.

Note:

The spectrum analyzer offset is derived from RF cable loss and attenuator factor.
Following shows an offset computation in physical test.

	RF cable loss (dB)	Attenuation factor(dB)	offset(dB)
Low Band (Below 1GHz)	0.2	14.8	15
High Band (Above 1 GHz)	0.5	14.5	15

2.5. Final Amplifier Voltage and Current Information:

Test Mode	DC voltage (V)	DC current (mA)
GSM 1900	3.85	348
WCDMA B2		364
LTE Band 2		461

Unless otherwise stated the results shown in this test report refer only to the sample(s) tested and such sample(s) are retained for 90 days only.

除非另有說明，此報告結果僅對測試之樣品負責，同時此樣品僅保留90天。本報告未經本公司書面許可，不可部份複製。

This document is issued by the Company subject to its General Conditions of Service printed overleaf, available on request or accessible at www.sgs.com/terms_and_conditions.htm and for electronic format documents, subject to Terms and Conditions for Electronic Documents at www.sgs.com/terms_e-document.htm. Attention is drawn to the limitation of liability, indemnification and jurisdiction issues defined therein. Any holder of this document is advised that information contained hereon reflects the Company's findings at the time of its intervention only and within the limits of Client's instructions, if any. The Company's sole responsibility is to its Client and this document does not exonerate parties to a transaction from exercising all their rights and obligations under the transaction documents. This document cannot be reproduced except in full, without prior written approval of the Company. Any unauthorized alteration, forgery or falsification of the content or appearance of this document is unlawful and offenders may be prosecuted to the fullest extent of the law.

2.6. Configuration of Tested System

Fig. 2-1 Configuration of Tested System (Fixed Channel-Conducted)

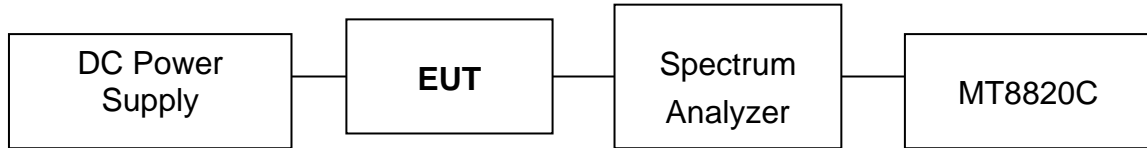

Fig. 2-2 Configuration of Tested System (Fixed Channel-Radiated)

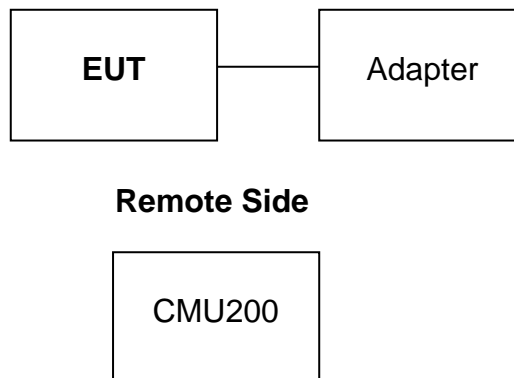

Table 2-1 Equipment Used in Tested System

Item	Equipment	Mfr/Brand	Model/ Type No.	Series No.	Data Cable	Power Cord
1.	Radio Communication Analyser	Anritsu	MT8820C	6201465317	shielded	Un-shielded
2.	DC Power Supply	Agilent	E3640A	KR93300208	N/A	Unshielded
3.	Digital Radio Communication Tester	R&S	CMU200	100535	shielded	Un-shielded

Unless otherwise stated the results shown in this test report refer only to the sample(s) tested and such sample(s) are retained for 90 days only.

除非另有說明，此報告結果僅對測試之樣品負責，同時此樣品僅保留90天。本報告未經本公司書面許可，不可部份複製。

This document is issued by the Company subject to its General Conditions of Service printed overleaf, available on request or accessible at www.sgs.com/terms_and_conditions.htm and for electronic format documents, subject to Terms and Conditions for Electronic Documents at www.sgs.com/terms_e-document.htm. Attention is drawn to the limitation of liability, indemnification and jurisdiction issues defined therein. Any holder of this document is advised that information contained hereon reflects the Company's findings at the time of its intervention only and within the limits of Client's instructions, if any. The Company's sole responsibility is to its Client and this document does not exonerate parties to a transaction from exercising all their rights and obligations under the transaction documents. This document cannot be reproduced except in full, without prior written approval of the Company. Any unauthorized alteration, forgery or falsification of the content or appearance of this document is unlawful and offenders may be prosecuted to the fullest extent of the law.

3. SUMMARY OF TEST RESULTS

FCC Rules	Description Of Test	Result
§2.1046(a)	RF Power Output	Compliant
§2.1046(a) §24.232(c)	ERP/ EIRP measurement	Compliant
§2.1049(h)	99% & 26dB Occupied Bandwidth	Compliant
§2.1051 §24.238(a)	Out of Band Emissions at Antenna Terminals and Band Edge / Emission mask requirements	Compliant
§2.1053 §24.238(a)	Field Strength of Spurious Radiation	Compliant
§24.232(d)	Peak to Average Ratio	Compliant
§2.1055(a)(1) §24.235	Frequency Stability	Compliant

Unless otherwise stated the results shown in this test report refer only to the sample(s) tested and such sample(s) are retained for 90 days only.

除非另有說明，此報告結果僅對測試之樣品負責，同時此樣品僅保留90天。本報告未經本公司書面許可，不可部份複製。

This document is issued by the Company subject to its General Conditions of Service printed overleaf, available on request or accessible at www.sgs.com/terms_and_conditions.htm and for electronic format documents, subject to Terms and Conditions for Electronic Documents at www.sgs.com/terms_e-document.htm. Attention is drawn to the limitation of liability, indemnification and jurisdiction issues defined therein. Any holder of this document is advised that information contained hereon reflects the Company's findings at the time of its intervention only and within the limits of Client's instructions, if any. The Company's sole responsibility is to its Client and this document does not exonerate parties to a transaction from exercising all their rights and obligations under the transaction documents. This document cannot be reproduced except in full, without prior written approval of the Company. Any unauthorized alteration, forgery or falsification of the content or appearance of this document is unlawful and offenders may be prosecuted to the fullest extent of the law.

4. DESCRIPTION OF TEST MODES

4.1. The Worst Test Modes and Channel Details

1. The EUT has been tested under operating condition.
2. Pre-Scan has been conducted to determine the worst-case mode from all possible combinations between available modulations, data rates, X(E1)Y(E2)Z(H) axis and antenna ports. The worst case was found as listed below. Following channel(s) was (were) selected for the final test as listed below:

BAND	ERP/EIRP	RADIATED EMISSION and Wireless charging Cover
GSM/GPRS 1900	E1-plan	E1-plan
WCDMA/HSPA Band II	E1-plan	E1-plan
LTE Band 2	E1-plan	E1-plan

Note: Additional emissions testing were performed per KDB 648474 D03 and reported herein and identified as WPC. Per KDB 648474 D03, spurious emissions measurement data was also investigated with the wireless charging battery cover.

Unless otherwise stated the results shown in this test report refer only to the sample(s) tested and such sample(s) are retained for 90 days only.

除非另有說明，此報告結果僅對測試之樣品負責，同時此樣品僅保留90天。本報告未經本公司書面許可，不可部份複製。

This document is issued by the Company subject to its General Conditions of Service printed overleaf, available on request or accessible at www.sgs.com/terms_and_conditions.htm and for electronic format documents, subject to Terms and Conditions for Electronic Documents at www.sgs.com/terms_e-document.htm. Attention is drawn to the limitation of liability, indemnification and jurisdiction issues defined therein. Any holder of this document is advised that information contained hereon reflects the Company's findings at the time of its intervention only and within the limits of Client's instructions, if any. The Company's sole responsibility is to its Client and this document does not exonerate parties to a transaction from exercising all their rights and obligations under the transaction documents. This document cannot be reproduced except in full, without prior written approval of the Company. Any unauthorized alteration, forgery or falsification of the content or appearance of this document is unlawful and offenders may be prosecuted to the fullest extent of the law.

GSM/GPRS MODE

TEST ITEM	AVAILABLE CHANNEL	TESTED CHANNEL	MODE
EIRP	512 to 810	512, 661, 810	GSM/GPRS 1900
FREQUENCY STABILITY	128 to 251 512 to 810	661	GPRS 1900
OCCUPIED BANDWIDTH	128 to 251 512 to 810	661	GSM/GPRS 1900
PEAK TO AVERAGE RATIO	128 to 251 512 to 810	512, 661, 810	GSM/GPRS 1900
BAND EDGE	128 to 251 512 to 810	512, 810	GSM/GPRS 1900
CONDCUDED EMISSION	128 to 251 512 to 810	512, 661, 810	GSM/GPRS 1900
RADIATED EMISSION	128 to 251 512 to 810	512, 661, 810	GPRS 1900

WCDMA/HSPA MODE

TEST ITEM	AVAILABLE CHANNEL	TESTED CHANNEL	MODE
EIRP	9262 to 9538	9262, 9400, 9583	WCDMA/HSPA Band II
FREQUENCY STABILITY	9262 to 9538	9400	WCDMA Band II
OCCUPIED BANDWIDTH	9262 to 9538	9262, 9400, 9583	WCDMA/HSPA Band II
PEAK TO AVERAGE RATIO	9262 to 9538	9262, 9400, 9583	WCDMA/HSPA Band II
BAND EDGE	9262 to 9538	9262, 9583	WCDMA Band II
CONDCUDED EMISSION	9262 to 9538	9262, 9400, 9583	WCDMA Band II
RADIATED EMISSION	9262 to 9538	9262, 9400, 9583	HSDPA Band II

Unless otherwise stated the results shown in this test report refer only to the sample(s) tested and such sample(s) are retained for 90 days only.

除非另有說明，此報告結果僅對測試之樣品負責，同時此樣品僅保留90天。本報告未經本公司書面許可，不可部份複製。

This document is issued by the Company subject to its General Conditions of Service printed overleaf, available on request or accessible at www.sgs.com/terms_and_conditions.htm and for electronic format documents, subject to Terms and Conditions for Electronic Documents at www.sgs.com/terms_e-document.htm. Attention is drawn to the limitation of liability, indemnification and jurisdiction issues defined therein. Any holder of this document is advised that information contained hereon reflects the Company's findings at the time of its intervention only and within the limits of Client's instructions, if any. The Company's sole responsibility is to its Client and this document does not exonerate parties to a transaction from exercising all their rights and obligations under the transaction documents. This document cannot be reproduced except in full, without prior written approval of the Company. Any unauthorized alteration, forgery or falsification of the content or appearance of this document is unlawful and offenders may be prosecuted to the fullest extent of the law.

LTE Band 2 MODE

TEST ITEM	AVAILABLE CHANNEL	TESTED CHANNEL	CHANNEL BANDWIDTH	MODULATION	MODE
EIRP	18607 to 19193	18607, 18900, 19193	1.4MHz	QPSK, 16QAM	1 RB/ 0,5 RB Offest
	18615 to 19185	18615, 18900, 19185	3MHz	QPSK, 16QAM	1 RB/ 0,14 RB Offest
	18625 to 19175	18625, 18900, 19175	5MHz	QPSK, 16QAM	1 RB/ 0,24 RB Offest
	18650 to 19150	18650, 18900, 19150	10MHz	QPSK, 16QAM	1 RB/ 0,49 RB Offest
	18675 to 19125	18675, 18900, 19125	15MHz	QPSK, 16QAM	1 RB/ 0,74 RB Offest
	18700 to 19100	18700, 18900, 19100	20MHz	QPSK, 16QAM	1 RB/ 0,99 RB Offest
FREQUENCY STABILITY	18650 to 19150	18900	10MHz	QPSK,	Full RB
OCCUPIED BANDWIDTH	18607 to 19193	18607, 18900, 19193	1.4MHz	QPSK, 16QAM	Full RB
	18615 to 19185	18615, 18900, 19185	3MHz	QPSK, 16QAM	Full RB
	18625 to 19175	18625, 18900, 19175	5MHz	QPSK, 16QAM	Full RB
	18650 to 19150	18650, 18900, 19150	10MHz	QPSK, 16QAM	Full RB
	18675 to 19125	18675, 18900, 19125	15MHz	QPSK, 16QAM	Full RB
	18700 to 19100	18700, 18900, 19100	20MHz	QPSK, 16QAM	Full RB
PEAK TO AVERAGE RATIO	18607 to 19193	18607, 18900, 19193	1.4MHz	16QAM	Full RB
	18615 to 19185	18615, 18900, 19185	3MHz	16QAM	Full RB
	18625 to 19175	18625, 18900, 19175	5MHz	16QAM	Full RB
	18650 to 19150	18650, 18900, 19150	10MHz	16QAM	Full RB
	18675 to 19125	18675, 18900, 19125	15MHz	16QAM	Full RB
	18700 to 19100	18700, 18900, 19100	20MHz	16QAM	Full RB
BAND EDGE	18607 to 19193	18607, 19193	1.4MHz	QPSK,	1 RB/ 0,5 RB Offes Full RB
	18615 to 19185	18615, 19185	3MHz	QPSK,	1 RB/ 0,14 RB Offest Full RB
	18625 to 19175	18625, 19175	5MHz	QPSK,	1 RB/ 0,24 RB Offest Full RB
	18650 to 19150	18650, 19150	10MHz	QPSK,	1 RB/ 0,49 RB Offest Full RB
	18675 to 19125	18675, 19125	15MHz	QPSK,	1 RB/ 0,74 RB Offest Full RB
	18700 to 19100	18700, 19100	20MHz	QPSK,	1 RB/ 0,99 RB Offest Full RB
CONDCUDED EMISSION	18607 to 19193	18607, 18900, 19193	1.4MHz	QPSK,	1 RB, 0 RB Offest
	18615 to 19185	18615, 18900, 19185	3MHz	QPSK,	1 RB, 0 RB Offest
	18625 to 19175	18625, 18900, 19175	5MHz	QPSK,	1 RB, 0 RB Offest
	18650 to 19150	18650, 18900, 19150	10MHz	QPSK,	1 RB, 0 RB Offest
	18675 to 19125	18675, 18900, 19125	15MHz	QPSK,	1 RB, 0 RB Offest
	18700 to 19100	18700, 18900, 19100	20MHz	QPSK,	1 RB, 0 RB Offest
RADIATED EMIS- SION	18625 to 19175	18625, 18900, 19175	3MHz	QPSK	1 RB, 14 RB Offest

Unless otherwise stated the results shown in this test report refer only to the sample(s) tested and such sample(s) are retained for 90 days only.

除非另有說明，此報告結果僅對測試之樣品負責，同時此樣品僅保留90天。本報告未經本公司書面許可，不可部份複製。

This document is issued by the Company subject to its General Conditions of Service printed overleaf, available on request or accessible at www.sgs.com/terms_and_conditions.htm and for electronic format documents, subject to Terms and Conditions for Electronic Documents at www.sgs.com/terms_e-document.htm. Attention is drawn to the limitation of liability, indemnification and jurisdiction issues defined therein. Any holder of this document is advised that information contained hereon reflects the Company's findings at the time of its intervention only and within the limits of Client's instructions, if any. The Company's sole responsibility is to its Client and this document does not exonerate parties to a transaction from exercising all their rights and obligations under the transaction documents. This document cannot be reproduced except in full, without prior written approval of the Company. Any unauthorized alteration, forgery or falsification of the content or appearance of this document is unlawful and offenders may be prosecuted to the fullest extent of the law.

5. MEASUREMENT UNCERTAINTY

Test Items	Uncertainty
RF Output Power	+/- 1.15 dB
99% Occupied Bandwidth	+/- 0.89%
Out of Band Emissions at Antenna Terminals and Band Edge	+/- 0.89 dB
Frequency Stability vs. Temperature	+/- 2.64 Hz
3M Semi Anechoic Chamber / 30M~200M	+/- 4.12 dB
3M Semi Anechoic Chamber / 200MHz ~ 1GHz	+/- 4.68
3M Semi Anechoic Chamber / 1GHz ~ 8GHz	+/- 5.18
3M Semi Anechoic Chamber / 8GHz ~ 18GHz	+/- 5.47
3M Semi Anechoic Chamber / 18GHz ~ 26GHz	+/- 3.81
3M Semi Anechoic Chamber / 26GHz ~ 40GHz	+/- 3.87

Note:

1. This uncertainty represents an expanded uncertainty expressed at approximately the 95% confidence level using a coverage factor of k=2.
2. ISO/IEC 17025 requires that an estimate of the measurement uncertainties associated with the emissions test results be included in the report.
3. The conformity assessment statement in this report is based solely on the test results, measurement uncertainty is excluded.

Unless otherwise stated the results shown in this test report refer only to the sample(s) tested and such sample(s) are retained for 90 days only.

除非另有說明，此報告結果僅對測試之樣品負責，同時此樣品僅保留90天。本報告未經本公司書面許可，不可部份複製。

This document is issued by the Company subject to its General Conditions of Service printed overleaf, available on request or accessible at www.sgs.com/terms_and_conditions.htm and for electronic format documents, subject to Terms and Conditions for Electronic Documents at www.sgs.com/terms_e-document.htm. Attention is drawn to the limitation of liability, indemnification and jurisdiction issues defined therein. Any holder of this document is advised that information contained hereon reflects the Company's findings at the time of its intervention only and within the limits of Client's instructions, if any. The Company's sole responsibility is to its Client and this document does not exonerate parties to a transaction from exercising all their rights and obligations under the transaction documents. This document cannot be reproduced except in full, without prior written approval of the Company. Any unauthorized alteration, forgery or falsification of the content or appearance of this document is unlawful and offenders may be prosecuted to the fullest extent of the law.

6. RF CONDUCTED OUTPUT POWER MEASUREMENT

6.1. Standard Applicable

A base station simulator was used to establish communication with the EUT. Its parameters were set to transmit the maximum power on the EUT. The measured power in the radio frequency on the transmitter output terminals.

ERP/EIRP LIMIT

According to FCC §2.1046

FCC 24.232(b) Mobile and portable stations are limited to 2 W EIRP.

6.2. Test Set-up

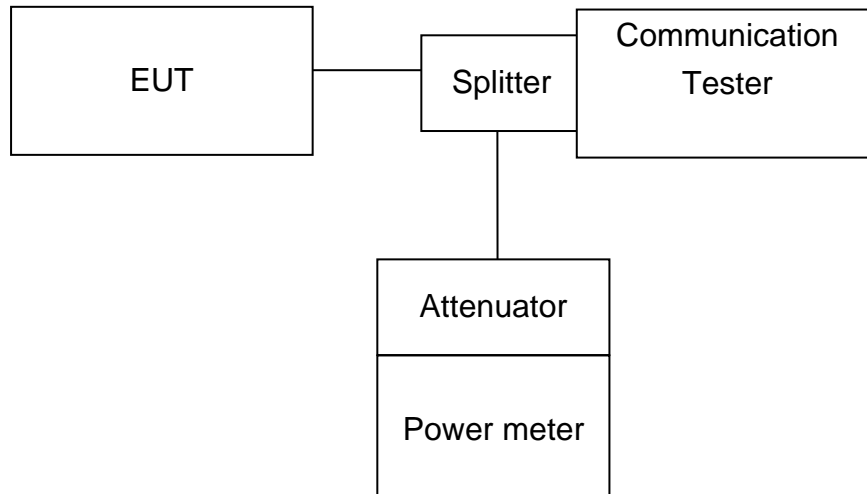

Note: Measurement setup for testing on Antenna connector

Unless otherwise stated the results shown in this test report refer only to the sample(s) tested and such sample(s) are retained for 90 days only.

除非另有說明，此報告結果僅對測試之樣品負責，同時此樣品僅保留90天。本報告未經本公司書面許可，不可部份複製。

This document is issued by the Company subject to its General Conditions of Service printed overleaf, available on request or accessible at www.sgs.com/terms_and_conditions.htm and for electronic format documents, subject to Terms and Conditions for Electronic Documents at www.sgs.com/terms_e-document.htm. Attention is drawn to the limitation of liability, indemnification and jurisdiction issues defined therein. Any holder of this document is advised that information contained hereon reflects the Company's findings at the time of its intervention only and within the limits of Client's instructions, if any. The Company's sole responsibility is to its Client and this document does not exonerate parties to a transaction from exercising all their rights and obligations under the transaction documents. This document cannot be reproduced except in full, without prior written approval of the Company. Any unauthorized alteration, forgery or falsification of the content or appearance of this document is unlawful and offenders may be prosecuted to the fullest extent of the law.

6.3. Measurement Procedure

The transmitter output was connected to a calibrated attenuator, the other end of which was connected to a power meter. Transmitter output was read off the power meter in dBm. The power output at the transmitter antenna port was determined by adding the value of the attenuator to the power meter reading. TS 151 010-1 is reference to conduct the test measurement of output power.

The Procedure of KDB941225 (SAR Measurement Procedures for 3G devices, (WCD-MA/HSPA) was used for EUT and Base station setting. RMC 12.2kps is used for this testing, and KDB 971168 D01 Power Meas License Digital System as the supplemental test methodology to adjust the proper setting obtaining the measurement results

All LTE bands conducted average power is obtained from the simulator telecommunication test set.

The following tests were conducted according to the test requirements outlined in section 6.2 of the 3GPP.

TEST PROCEDURE:

ANSI C63.26:2015

KDB 971168 Section 5.6

$$\text{ERP/EIRP} = \text{PMeas} + \text{GT-LC}$$

where: ERP/EIRP = effective or equivalent radiated power, respectively (expressed in the same units as PMeas, typically dBW or dBm);

PMeas = measured transmitter output power or PSD, in dBm or dBW;

GT = gain of the transmitting antenna, in dBd (ERP) or dBi (EIRP);

LC = signal attenuation in the connecting cable between the transmitter and antenna, in dB.2

For devices utilizing multiple antennas, KDB 662911 provides guidance for determining the effective array transmit antenna gain term to be used in the above equation.

Unless otherwise stated the results shown in this test report refer only to the sample(s) tested and such sample(s) are retained for 90 days only.

除非另有說明，此報告結果僅對測試之樣品負責，同時此樣品僅保留90天。本報告未經本公司書面許可，不可部份複製。

This document is issued by the Company subject to its General Conditions of Service printed overleaf, available on request or accessible at www.sgs.com/terms_and_conditions.htm and for electronic format documents, subject to Terms and Conditions for Electronic Documents at www.sgs.com/terms_e-document.htm. Attention is drawn to the limitation of liability, indemnification and jurisdiction issues defined therein. Any holder of this document is advised that information contained hereon reflects the Company's findings at the time of its intervention only and within the limits of Client's instructions, if any. The Company's sole responsibility is to its Client and this document does not exonerate parties to a transaction from exercising all their rights and obligations under the transaction documents. This document cannot be reproduced except in full, without prior written approval of the Company. Any unauthorized alteration, forgery or falsification of the content or appearance of this document is unlawful and offenders may be prosecuted to the fullest extent of the law.

6.4. Measurement Equipment Used

EQUIPMENT TYPE	MFR	MODEL NUMBER	SERIAL NUMBER	LAST CAL.	CAL DUE.
DC Power Supply	Agilent	E3640A	KR93300208	Aug. 15th, 2018	Aug. 14th, 2019
EXA Spectrum Analyzer	KEYSIGHT	N9010A	MY57120290	Feb. 13th, 2019	Feb. 12th, 2020
Radio Communication Analyzer	Anritsu	MT8815B	6200711454	Apr. 1st, 2019	Mar. 31th, 2020
Radio Communication Analyzer	Anritsu	MT8820C	6201465317	Jan. 16th, 2019	Jan. 15th, 2020
Splitter	RF-LAMBAD	RFLT2W1G18G	11-JSPD022-013	Feb. 26th, 2019	Feb. 25th, 2020
DC Block	Mini-Circuits	BLK-18-S+	31129(1)	Feb. 26th, 2019	Feb. 25th, 2020
Attenuator	Mini-Circuit	BW-S10W2+	1	Feb. 26th, 2019	Feb. 25th, 2020

6.5. Measurement Result

RF Conducted Output Power

GSM/GPRS/EDGE (GMSK; 8-PSK) Result:

EUT Mode	Freq. (MHz)	CH	Conducted Avg. Power (dBm)	Antenna Gain (dBi)	ERP (dBm)	EIRP (dBm)	Limit (dBm)	Margin (dB)
GSM 1900	1850.2	512	28.71	-0.38	26.18	28.33	33.00	-4.67
	1880.0	661	28.92	-0.38	26.39	28.54	33.00	-4.46
	1909.8	810	29.07	-0.38	26.54	28.69	33.00	-4.31
GPRS 1900	1850.2	512	28.71	-0.38	26.18	28.33	33.00	-4.67
	1880.0	661	28.92	-0.38	26.39	28.54	33.00	-4.46
	1909.8	810	29.07	-0.38	26.54	28.69	33.00	-4.31

Unless otherwise stated the results shown in this test report refer only to the sample(s) tested and such sample(s) are retained for 90 days only.

除非另有說明，此報告結果僅對測試之樣品負責，同時此樣品僅保留90天。本報告未經本公司書面許可，不可部份複製。

This document is issued by the Company subject to its General Conditions of Service printed overleaf, available on request or accessible at www.sgs.com/terms_and_conditions.htm and for electronic format documents, subject to Terms and Conditions for Electronic Documents at www.sgs.com/terms_e-document.htm. Attention is drawn to the limitation of liability, indemnification and jurisdiction issues defined therein. Any holder of this document is advised that information contained hereon reflects the Company's findings at the time of its intervention only and within the limits of Client's instructions, if any. The Company's sole responsibility is to its Client and this document does not exonerate parties to a transaction from exercising all their rights and obligations under the transaction documents. This document cannot be reproduced except in full, without prior written approval of the Company. Any unauthorized alteration, forgery or falsification of the content or appearance of this document is unlawful and offenders may be prosecuted to the fullest extent of the law.

EUT Mode	Frequency (MHz)	CH	Average Burst Power (1DN 1UP) Class 8 (dBm)	Average Burst Power (1DN 2UP) Class 10 (dBm)	Average Burst Power (1DN 3UP) Class 12 (dBm)	Average Burst Power (1DN 4UP) Class 12 (dBm)
GPRS 1900	1850.2	512	28.71	26.59	24.74	23.77
	1880.0	661	28.92	26.55	24.80	23.79
	1909.8	810	29.07	26.74	24.96	23.94

WCDMA MODE:

The following tests were completed according to the test requirements outlined in section 5.2 of the 3GPP TS34.121-1 specification. The EUT supports power Class 3, which has a nominal maximum output power of 24 dBm (+1.7/-3.7). RMC 12.2kps is used for this testing.

Results:

WCDMA/HSUPA/HSDPA Band II Result:

EUT Mode	Freq. (MHz)	CH	Conducted Avg. Power (dBm)	Antenna Gain (dBi)	ERP (dBm)	EIRP (dBm)	Limit (dBm)	Margin (dB)
WCDMA	1852.4	9262	23.16	-0.38	20.63	22.78	33.00	-10.22
	1880.0	9400	23.44	-0.38	20.91	23.06	33.00	-9.94
	1907.6	9538	23.30	-0.38	20.77	22.92	33.00	-10.08
HSDPA	1852.4	9262	22.49	-0.38	19.96	22.11	33.00	-10.89
	1880.0	9400	22.46	-0.38	19.93	22.08	33.00	-10.92
	1907.6	9538	22.49	-0.38	19.96	22.11	33.00	-10.89
HSUPA	1852.4	9262	22.45	-0.38	19.92	22.07	33.00	-10.93
	1880.0	9400	22.44	-0.38	19.91	22.06	33.00	-10.94
	1907.6	9538	22.47	-0.38	19.94	22.09	33.00	-10.91

Unless otherwise stated the results shown in this test report refer only to the sample(s) tested and such sample(s) are retained for 90 days only.

除非另有說明，此報告結果僅對測試之樣品負責，同時此樣品僅保留90天。本報告未經本公司書面許可，不可部份複製。

This document is issued by the Company subject to its General Conditions of Service printed overleaf, available on request or accessible at www.sgs.com/terms_and_conditions.htm and for electronic format documents, subject to Terms and Conditions for Electronic Documents at www.sgs.com/terms_e-document.htm. Attention is drawn to the limitation of liability, indemnification and jurisdiction issues defined therein. Any holder of this document is advised that information contained hereon reflects the Company's findings at the time of its intervention only and within the limits of Client's instructions, if any. The Company's sole responsibility is to its Client and this document does not exonerate parties to a transaction from exercising all their rights and obligations under the transaction documents. This document cannot be reproduced except in full, without prior written approval of the Company. Any unauthorized alteration, forgery or falsification of the content or appearance of this document is unlawful and offenders may be prosecuted to the fullest extent of the law.

LTE Result:

Antenna gain (dBi) -0.38

LTE Band 2_Uplink frequency band : 1850 to 1910 MHz									
BW (MHz)	UL Channel	Frequency (MHz)	Modulation	RB Size	RB Offset	Conducted Average (dBm)	EIRP Average (dBm)	EIRP Limit (dBm)	Margin (dB)
1.4	18607	1850.7	QPSK	1	0	22.68	22.30	33	-10.7
				1	5	22.70	22.32	33	-10.68
				3	2	22.95	22.57	33	-10.43
				6	0	21.67	21.29	33	-11.71
	18900	1880	QPSK	1	0	22.47	22.09	33	-10.91
				1	5	22.85	22.47	33	-10.53
				3	2	22.88	22.50	33	-10.5
				6	0	21.77	21.39	33	-11.61
	19193	1909.3	QPSK	1	0	22.78	22.40	33	-10.6
				1	5	22.80	22.42	33	-10.58
				3	2	22.81	22.43	33	-10.57
				6	0	21.77	21.39	33	-11.61
	18607	1850.7	16QAM	1	0	21.59	21.21	33	-11.79
				1	5	21.73	21.35	33	-11.65
				3	2	21.46	21.08	33	-11.92
				6	0	20.51	20.13	33	-12.87
	18900	1880	16QAM	1	0	21.55	21.17	33	-11.83
				1	5	21.64	21.26	33	-11.74
				3	2	21.82	21.44	33	-11.56
				6	0	20.90	20.52	33	-12.48
	19193	1909.3	16QAM	1	0	21.81	21.43	33	-11.57
				1	5	21.24	20.86	33	-12.14
				3	2	21.67	21.29	33	-11.71
				6	0	20.89	20.51	33	-12.49

Unless otherwise stated the results shown in this test report refer only to the sample(s) tested and such sample(s) are retained for 90 days only.

除非另有說明，此報告結果僅對測試之樣品負責，同時此樣品僅保留90天。本報告未經本公司書面許可，不可部份複製。

This document is issued by the Company subject to its General Conditions of Service printed overleaf, available on request or accessible at www.sgs.com/terms_and_conditions.htm and for electronic format documents, subject to Terms and Conditions for Electronic Documents at www.sgs.com/terms_e-document.htm. Attention is drawn to the limitation of liability, indemnification and jurisdiction issues defined therein. Any holder of this document is advised that information contained hereon reflects the Company's findings at the time of its intervention only and within the limits of Client's instructions, if any. The Company's sole responsibility is to its Client and this document does not exonerate parties to a transaction from exercising all their rights and obligations under the transaction documents. This document cannot be reproduced except in full, without prior written approval of the Company. Any unauthorized alteration, forgery or falsification of the content or appearance of this document is unlawful and offenders may be prosecuted to the fullest extent of the law.

Antenna gain (dBi) -0.38

LTE Band 2_Uplink frequency band : 1850 to 1910 MHz									
BW (MHz)	UL Channel	Frequency (MHz)	Modulation	RB Size	RB Offset	Conducted Average (dBm)	EIRP Average (dBm)	EIRP Limit (dBm)	Margin (dB)
3	18615	1851.5	QPSK	1	0	22.58	22.20	33	-10.8
				1	14	22.46	22.08	33	-10.92
				8	4	21.64	21.26	33	-11.74
				15	0	21.67	21.29	33	-11.71
	18900	1880	QPSK	1	0	22.55	22.17	33	-10.83
				1	14	22.61	22.23	33	-10.77
				8	4	21.81	21.43	33	-11.57
				15	0	21.71	21.33	33	-11.67
	19185	1908.5	QPSK	1	0	22.67	22.29	33	-10.71
				1	14	22.81	22.43	33	-10.57
				8	4	21.79	21.41	33	-11.59
				15	0	21.80	21.42	33	-11.58
	18615	1851.5	16QAM	1	0	21.17	20.79	33	-12.21
				1	14	21.52	21.14	33	-11.86
				8	4	20.83	20.45	33	-12.55
				15	0	20.89	20.51	33	-12.49
	18900	1880	16QAM	1	0	21.47	21.09	33	-11.91
				1	14	21.44	21.06	33	-11.94
				8	4	21.00	20.62	33	-12.38
				15	0	20.79	20.41	33	-12.59
	19185	1908.5	16QAM	1	0	21.36	20.98	33	-12.02
				1	14	22.11	21.73	33	-11.27
				8	4	21.04	20.66	33	-12.34
				15	0	20.93	20.55	33	-12.45

Unless otherwise stated the results shown in this test report refer only to the sample(s) tested and such sample(s) are retained for 90 days only.

除非另有說明，此報告結果僅對測試之樣品負責，同時此樣品僅保留90天。本報告未經本公司書面許可，不可部份複製。

This document is issued by the Company subject to its General Conditions of Service printed overleaf, available on request or accessible at www.sgs.com/terms_and_conditions.htm and for electronic format documents, subject to Terms and Conditions for Electronic Documents at www.sgs.com/terms_e-document.htm. Attention is drawn to the limitation of liability, indemnification and jurisdiction issues defined therein. Any holder of this document is advised that information contained hereon reflects the Company's findings at the time of its intervention only and within the limits of Client's instructions, if any. The Company's sole responsibility is to its Client and this document does not exonerate parties to a transaction from exercising all their rights and obligations under the transaction documents. This document cannot be reproduced except in full, without prior written approval of the Company. Any unauthorized alteration, forgery or falsification of the content or appearance of this document is unlawful and offenders may be prosecuted to the fullest extent of the law.

Antenna gain (dBi) -0.38

LTE Band 2_Uplink frequency band : 1850 to 1910 MHz									
BW (MHz)	UL Channel	Frequency (MHz)	Modulation	RB Size	RB Offset	Conducted Average (dBm)	EIRP Average (dBm)	EIRP Limit (dBm)	Margin (dB)
5	18625	1852.5	QPSK	1	0	22.24	21.86	33	-11.14
				1	24	22.33	21.95	33	-11.05
				12	6	21.63	21.25	33	-11.75
				25	0	21.67	21.29	33	-11.71
	18900	1880	QPSK	1	0	22.46	22.08	33	-10.92
				1	24	22.44	22.06	33	-10.94
				12	6	21.82	21.44	33	-11.56
				25	0	21.77	21.39	33	-11.61
	19175	1907.5	QPSK	1	0	22.37	21.99	33	-11.01
				1	24	22.77	22.39	33	-10.61
				12	6	21.93	21.55	33	-11.45
				25	0	21.76	21.38	33	-11.62
	18625	1852.5	16QAM	1	0	21.04	20.66	33	-12.34
				1	24	21.64	21.26	33	-11.74
				12	6	20.64	20.26	33	-12.74
				25	0	20.74	20.36	33	-12.64
	18900	1880	16QAM	1	0	21.31	20.93	33	-12.07
				1	24	21.72	21.34	33	-11.66
				12	6	20.89	20.51	33	-12.49
				25	0	20.95	20.57	33	-12.43
19175	1907.5	16QAM	1	0	21.55	21.17	33	-11.83	
			1	24	21.69	21.31	33	-11.69	
			12	6	21.05	20.67	33	-12.33	
			25	0	20.84	20.46	33	-12.54	

Unless otherwise stated the results shown in this test report refer only to the sample(s) tested and such sample(s) are retained for 90 days only.

除非另有說明，此報告結果僅對測試之樣品負責，同時此樣品僅保留90天。本報告未經本公司書面許可，不可部份複製。

This document is issued by the Company subject to its General Conditions of Service printed overleaf, available on request or accessible at www.sgs.com/terms_and_conditions.htm and for electronic format documents, subject to Terms and Conditions for Electronic Documents at www.sgs.com/terms_e-document.htm. Attention is drawn to the limitation of liability, indemnification and jurisdiction issues defined therein. Any holder of this document is advised that information contained hereon reflects the Company's findings at the time of its intervention only and within the limits of Client's instructions, if any. The Company's sole responsibility is to its Client and this document does not exonerate parties to a transaction from exercising all their rights and obligations under the transaction documents. This document cannot be reproduced except in full, without prior written approval of the Company. Any unauthorized alteration, forgery or falsification of the content or appearance of this document is unlawful and offenders may be prosecuted to the fullest extent of the law.

Antenna gain (dBi) -0.38

LTE Band 2_Uplink frequency band : 1850 to 1910 MHz									
BW (MHz)	UL Channel	Frequency (MHz)	Modulation	RB Size	RB Offset	Conducted Average (dBm)	EIRP Average (dBm)	EIRP Limit (dBm)	Margin (dB)
10	18650	1855	QPSK	1	0	22.37	21.99	33	-11.01
				1	49	22.49	22.11	33	-10.89
				25	12	21.64	21.26	33	-11.74
				50	0	21.63	21.25	33	-11.75
	18900	1880	QPSK	1	0	22.57	22.19	33	-10.81
				1	49	22.52	22.14	33	-10.86
				25	12	21.80	21.42	33	-11.58
				50	0	21.74	21.36	33	-11.64
	19150	1905	QPSK	1	0	22.62	22.24	33	-10.76
				1	49	22.82	22.44	33	-10.56
				25	12	21.77	21.39	33	-11.61
				50	0	21.78	21.40	33	-11.6
	18650	1855	16QAM	1	0	21.41	21.03	33	-11.97
				1	49	21.56	21.18	33	-11.82
				25	12	20.72	20.34	33	-12.66
				50	0	20.70	20.32	33	-12.68
	18900	1880	16QAM	1	0	21.48	21.10	33	-11.9
				1	49	21.02	20.64	33	-12.36
				25	12	20.95	20.57	33	-12.43
				50	0	20.85	20.47	33	-12.53
19150	1905	16QAM	1	0	21.42	21.04	33	-11.96	
			1	49	21.55	21.17	33	-11.83	
			25	12	20.85	20.47	33	-12.53	
			50	0	20.87	20.49	33	-12.51	

Unless otherwise stated the results shown in this test report refer only to the sample(s) tested and such sample(s) are retained for 90 days only.

除非另有說明，此報告結果僅對測試之樣品負責，同時此樣品僅保留90天。本報告未經本公司書面許可，不可部份複製。

This document is issued by the Company subject to its General Conditions of Service printed overleaf, available on request or accessible at www.sgs.com/terms_and_conditions.htm and for electronic format documents, subject to Terms and Conditions for Electronic Documents at www.sgs.com/terms_e-document.htm. Attention is drawn to the limitation of liability, indemnification and jurisdiction issues defined therein. Any holder of this document is advised that information contained hereon reflects the Company's findings at the time of its intervention only and within the limits of Client's instructions, if any. The Company's sole responsibility is to its Client and this document does not exonerate parties to a transaction from exercising all their rights and obligations under the transaction documents. This document cannot be reproduced except in full, without prior written approval of the Company. Any unauthorized alteration, forgery or falsification of the content or appearance of this document is unlawful and offenders may be prosecuted to the fullest extent of the law.

Antenna gain (dBi) -0.38

LTE Band 2_Uplink frequency band : 1850 to 1910 MHz									
BW (MHz)	UL Channel	Frequency (MHz)	Modulation	RB Size	RB Offset	Conducted Average (dBm)	EIRP Average (dBm)	EIRP Limit (dBm)	Margin (dB)
15	18675	1857.5	QPSK	1	0	22.59	22.21	33	-10.79
				1	74	22.72	22.34	33	-10.66
				36	18	21.74	21.36	33	-11.64
				75	0	21.68	21.30	33	-11.7
	18900	1880	QPSK	1	0	22.78	22.40	33	-10.6
				1	74	22.69	22.31	33	-10.69
				36	18	21.71	21.33	33	-11.67
				75	0	21.73	21.35	33	-11.65
	19125	1902.5	QPSK	1	0	22.77	22.39	33	-10.61
				1	74	22.73	22.35	33	-10.65
				36	18	21.82	21.44	33	-11.56
				75	0	21.77	21.39	33	-11.61
	18675	1857.5	16QAM	1	0	21.32	20.94	33	-12.06
				1	74	21.40	21.02	33	-11.98
				36	18	20.89	20.51	33	-12.49
				75	0	20.79	20.41	33	-12.59
	18900	1880	16QAM	1	0	21.56	21.18	33	-11.82
				1	74	21.80	21.42	33	-11.58
				36	18	20.74	20.36	33	-12.64
				75	0	20.79	20.41	33	-12.59
	19125	1902.5	16QAM	1	0	21.80	21.42	33	-11.58
				1	74	21.39	21.01	33	-11.99
				36	18	20.86	20.48	33	-12.52
				75	0	21.03	20.65	33	-12.35

Unless otherwise stated the results shown in this test report refer only to the sample(s) tested and such sample(s) are retained for 90 days only.

除非另有說明，此報告結果僅對測試之樣品負責，同時此樣品僅保留90天。本報告未經本公司書面許可，不可部份複製。

This document is issued by the Company subject to its General Conditions of Service printed overleaf, available on request or accessible at www.sgs.com/terms_and_conditions.htm and for electronic format documents, subject to Terms and Conditions for Electronic Documents at www.sgs.com/terms_e-document.htm. Attention is drawn to the limitation of liability, indemnification and jurisdiction issues defined therein. Any holder of this document is advised that information contained hereon reflects the Company's findings at the time of its intervention only and within the limits of Client's instructions, if any. The Company's sole responsibility is to its Client and this document does not exonerate parties to a transaction from exercising all their rights and obligations under the transaction documents. This document cannot be reproduced except in full, without prior written approval of the Company. Any unauthorized alteration, forgery or falsification of the content or appearance of this document is unlawful and offenders may be prosecuted to the fullest extent of the law.

Antenna gain (dBi) -0.38

LTE Band 2_Uplink frequency band : 1850 to 1910 MHz									
BW (MHz)	UL Channel	Frequency (MHz)	Modulation	RB Size	RB Offset	Conducted Average (dBm)	EIRP Average (dBm)	EIRP Limit (dBm)	Margin (dB)
20	18700	1860	QPSK	1	0	22.66	22.28	33	-10.72
				1	99	22.79	22.41	33	-10.59
				50	25	22.03	21.65	33	-11.35
				100	0	22.02	21.64	33	-11.36
	18900	1880	QPSK	1	0	22.70	22.32	33	-10.68
				1	99	22.89	22.51	33	-10.49
				50	25	22.07	21.69	33	-11.31
				100	0	21.92	21.54	33	-11.46
	19100	1900	QPSK	1	0	22.58	22.20	33	-10.8
				1	99	22.88	22.50	33	-10.5
				50	25	22.00	21.62	33	-11.38
				100	0	22.06	21.68	33	-11.32
	18700	1860	16QAM	1	0	22.02	21.64	33	-11.36
				1	99	21.82	21.44	33	-11.56
				50	25	21.09	20.71	33	-12.29
				100	0	21.00	20.62	33	-12.38
	18900	1880	16QAM	1	0	22.14	21.76	33	-11.24
				1	99	21.41	21.03	33	-11.97
				50	25	21.05	20.67	33	-12.33
				100	0	21.14	20.76	33	-12.24
19100	1900	16QAM	1	0	21.46	21.08	33	-11.92	
			1	99	22.12	21.74	33	-11.26	
			50	25	21.11	20.73	33	-12.27	
			100	0	20.97	20.59	33	-12.41	

Unless otherwise stated the results shown in this test report refer only to the sample(s) tested and such sample(s) are retained for 90 days only.

除非另有說明，此報告結果僅對測試之樣品負責，同時此樣品僅保留90天。本報告未經本公司書面許可，不可部份複製。

This document is issued by the Company subject to its General Conditions of Service printed overleaf, available on request or accessible at www.sgs.com/terms_and_conditions.htm and for electronic format documents, subject to Terms and Conditions for Electronic Documents at www.sgs.com/terms_e-document.htm. Attention is drawn to the limitation of liability, indemnification and jurisdiction issues defined therein. Any holder of this document is advised that information contained hereon reflects the Company's findings at the time of its intervention only and within the limits of Client's instructions, if any. The Company's sole responsibility is to its Client and this document does not exonerate parties to a transaction from exercising all their rights and obligations under the transaction documents. This document cannot be reproduced except in full, without prior written approval of the Company. Any unauthorized alteration, forgery or falsification of the content or appearance of this document is unlawful and offenders may be prosecuted to the fullest extent of the law.

HSDPA Release 6 MODE:

The following 4 Sub-Tests were completed according to the test requirements outlined in section 5.2A of the 3GPP TS34.121-1 V8.4.0 specification. All TX RMS power requirements for Power Class 3 were met according to table 5.2AA.5 and 5.2B.5 All UE channels and power ratio's are set according to table C10.1.4 & C11.1.3 in the 3GPP TS34.121-1 V8.4.0. RMC 12.2kps is used for this testing.

HSDPA SUB-TEST Setting

Table C.10.1.4: β values for transmitter characteristics tests with HS-DPCCH(FOR HSDPA)

Sub-test	β_c	β_d	β_d (SF)	β_c/β_d	β_{HS} (Note 1, Note 2)	CM (dB) (Note 3)	MPR (dB) (Note 3)	RMC (Kbps)
1	2/15	15/15	64	2/15	4/15	0.0	0.0	12.2
2	12/15 (Note 4)	15/15 (Note 4)	64	12/15 (Note 4)	24/15	1.0	0.0	12.2
3	15/15	8/15	64	15/8	30/15	1.5	0.5	12.2
4	15/15	4/15	64	15/4	30/15	1.5	0.5	12.2

Note: The recommended HSDPA MPRs are implemented as per following sub-tests.

Results:

Mode	Sub test	Avg. Power (dBm) Channel		
		9262.00	9400.00	9538.00
HSDPA II	1	22.49	22.46	22.49
	2	22.46	22.47	22.49
	3	21.96	21.90	21.92
	4	21.96	21.93	21.92

Unless otherwise stated the results shown in this test report refer only to the sample(s) tested and such sample(s) are retained for 90 days only.

除非另有說明，此報告結果僅對測試之樣品負責，同時此樣品僅保留90天。本報告未經本公司書面許可，不可部份複製。

This document is issued by the Company subject to its General Conditions of Service printed overleaf, available on request or accessible at www.sgs.com/terms_and_conditions.htm and for electronic format documents, subject to Terms and Conditions for Electronic Documents at www.sgs.com/terms_e-document.htm. Attention is drawn to the limitation of liability, indemnification and jurisdiction issues defined therein. Any holder of this document is advised that information contained hereon reflects the Company's findings at the time of its intervention only and within the limits of Client's instructions, if any. The Company's sole responsibility is to its Client and this document does not exonerate parties to a transaction from exercising all their rights and obligations under the transaction documents. This document cannot be reproduced except in full, without prior written approval of the Company. Any unauthorized alteration, forgery or falsification of the content or appearance of this document is unlawful and offenders may be prosecuted to the fullest extent of the law.

HSPA (HSDPA & HSUPA) Release 6 MODE

The following 5 Sub-Tests were completed according to the test requirements outlined in section 5.2A of the 3GPP TS34.121-1 V8.4.0 specification. All TX RMS power requirements for Power Class 3 were met according to table 5.2AA.5 and 5.2B.5 All UE channels and power ratio's are set according to table C11.1.3 in the 3GPP TS34.121-1 V8.4.0. RMC 12.2kps is used for this testing

HSPA SUB-TEST Setting

Table C.11.1.3: β values for transmitter characteristics tests with HS-DPCCH and E-DCH(FOR HSUPA)

Sub-test	β_c	β_d	β_d (SF)	β_c/β_d	β_{HS}	β_{ec}	β_{ed}	β_{ed} (SF)	β_{ed} (Code s)	CM (dB)	MPR (dB)	AG Index	E-TFCI	RMC (Kbps)
1	11/15 (Note 3)	15/15 (Note 3)	64	11/15 (Note 3)	22/15	209/225	1309/225	4	1	1.0	0.0	20	75	12.2
2	6/15	15/15	64	6/15	12/15	12/15	94/75	4	1	3.0	2.0	12	67	12.2
3	15/15	9/15	64	15/9	30/15	30/15	β_{ed1} : 47/15 β_{ed2} : 47/15	4 4	2	2.0	1.0	15	92	12.2
4	2/15	15/15	64	2/15	4/15	2/15	56/75	4	1	3.0	2.0	17	71	12.2
5	15/15 (Note 4)	15/15 (Note 4)	64	15/15 (Note 4)	30/15	24/15	134/15	4	1	1.0	0.0	21	81	12.2

Note: The recommended HSUPA MPRs are implemented as per following sub-tests.

Results:

Mode	Sub test	Avg. Power (dBm)		
		Channel		
		9262.00	9400.00	9538.00
HSUPA II	1	22.45	22.44	22.47
	2	20.49	20.47	20.45
	3	21.41	21.43	21.42
	4	20.41	20.46	20.44
	5	22.40	22.47	22.46

Unless otherwise stated the results shown in this test report refer only to the sample(s) tested and such sample(s) are retained for 90 days only.

除非另有說明，此報告結果僅對測試之樣品負責，同時此樣品僅保留90天。本報告未經本公司書面許可，不可部份複製。

This document is issued by the Company subject to its General Conditions of Service printed overleaf, available on request or accessible at www.sgs.com/terms_and_conditions.htm and for electronic format documents, subject to Terms and Conditions for Electronic Documents at www.sgs.com/terms_e-document.htm. Attention is drawn to the limitation of liability, indemnification and jurisdiction issues defined therein. Any holder of this document is advised that information contained hereon reflects the Company's findings at the time of its intervention only and within the limits of Client's instructions, if any. The Company's sole responsibility is to its Client and this document does not exonerate parties to a transaction from exercising all their rights and obligations under the transaction documents. This document cannot be reproduced except in full, without prior written approval of the Company. Any unauthorized alteration, forgery or falsification of the content or appearance of this document is unlawful and offenders may be prosecuted to the fullest extent of the law.

Minimum Communications Power Measurement

PCS 1900 band

PCL	0	1	2	3	4	5	6	7	8
Output power (dBm)	29.36	27.18	25.46	23.48	21.37	19.26	17.31	15.41	13.26

PCL	9	10	11	12	13	14	15
Output power (dBm)	11.52	9.43	7.38	5.42	3.24	1.52	-0.33

Note: The EUT output power was controlled by simulator. Set Communication Tester [MT8815B](#) PCL as above, and get the mobile phone output power reading.

WCDMA/HSDPA/HSUPA band II

The EUT output power was controlled by simulator. Set Communication Tester MT8815B function key "UE Power Control" and enter max rated power 24dBm. The EUT is going to be set to max output power to 24dBm. Then record the read (see page 15 for measurement data). The min. power was measures by a function key "minimum power" then record the read. It is -52.3dBm. The power variation can be 0.1dB step by setting.

Unless otherwise stated the results shown in this test report refer only to the sample(s) tested and such sample(s) are retained for 90 days only.

除非另有說明，此報告結果僅對測試之樣品負責，同時此樣品僅保留90天。本報告未經本公司書面許可，不可部份複製。

This document is issued by the Company subject to its General Conditions of Service printed overleaf, available on request or accessible at www.sgs.com/terms_and_conditions.htm and for electronic format documents, subject to Terms and Conditions for Electronic Documents at www.sgs.com/terms_e-document.htm. Attention is drawn to the limitation of liability, indemnification and jurisdiction issues defined therein. Any holder of this document is advised that information contained hereon reflects the Company's findings at the time of its intervention only and within the limits of Client's instructions, if any. The Company's sole responsibility is to its Client and this document does not exonerate parties to a transaction from exercising all their rights and obligations under the transaction documents. This document cannot be reproduced except in full, without prior written approval of the Company. Any unauthorized alteration, forgery or falsification of the content or appearance of this document is unlawful and offenders may be prosecuted to the fullest extent of the law.

7. OCCUPIED BANDWIDTH MEASUREMENT

7.1. Standard Applicable

The occupied bandwidth is the frequency bandwidth such that, below its lower and above its upper frequency limits, the mean powers radiated are each equal to 0.5 percent of the total mean power.

7.2. Test Set-up

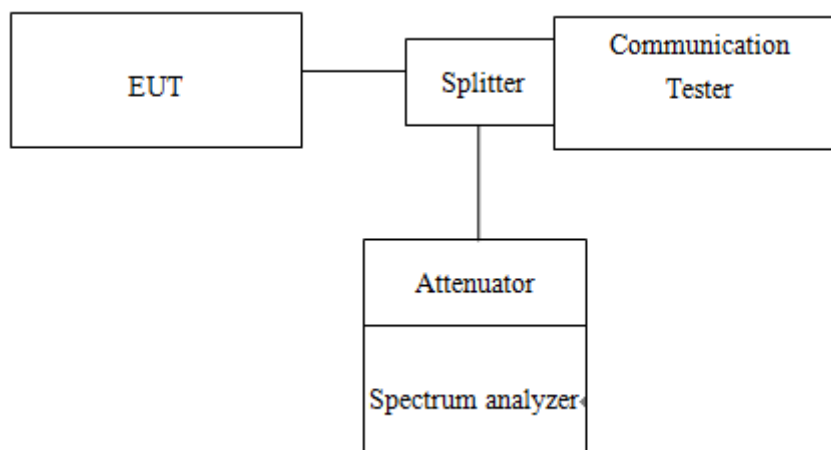

7.3. Measurement Procedure

99% &26dB Bandwidth with detector peak

The EUT's output RF connector was connected with a short cable to the spectrum analyzer, RBW was set to about 1% of emission BW, VBW= 3 times RBW, -26dBc display line was placed on the screen (or 26dB bandwidth), the occupied bandwidth is the delta frequency between the two points where the display line intersects the signal trace. Then set RBW to 99% bandwidth, RBW= 1%, VBW= 3 RBW, with span > 2 * Signal BW, set % Power = 99%.

99% Bandwidth with detector sample

The EUT's output RF connector was connected with a short cable to the spectrum analyzer, RBW was set to about 1% ~ 5% of emission BW, VBW= 3 times RBW, -20dBc display line was placed on the screen (or 20dB bandwidth). Set RBW to 99% bandwidth, RBW= 1% ~ 5%, VBW= 3 RBW, with span > 2 * Signal BW, set % Power = 99%.

Unless otherwise stated the results shown in this test report refer only to the sample(s) tested and such sample(s) are retained for 90 days only.

除非另有說明，此報告結果僅對測試之樣品負責，同時此樣品僅保留90天。本報告未經本公司書面許可，不可部份複製。

This document is issued by the Company subject to its General Conditions of Service printed overleaf, available on request or accessible at www.sgs.com/terms_and_conditions.htm and for electronic format documents, subject to Terms and Conditions for Electronic Documents at www.sgs.com/terms_e-document.htm. Attention is drawn to the limitation of liability, indemnification and jurisdiction issues defined therein. Any holder of this document is advised that information contained hereon reflects the Company's findings at the time of its intervention only and within the limits of Client's instructions, if any. The Company's sole responsibility is to its Client and this document does not exonerate parties to a transaction from exercising all their rights and obligations under the transaction documents. This document cannot be reproduced except in full, without prior written approval of the Company. Any unauthorized alteration, forgery or falsification of the content or appearance of this document is unlawful and offenders may be prosecuted to the fullest extent of the law.

7.4. Measurement Equipment Used

EQUIPMENT TYPE	MFR	MODEL NUMBER	SERIAL NUMBER	LAST CAL.	CAL DUE.
DC Power Supply	Agilent	E3640A	KR93300208	Aug. 15th, 2018	Aug. 14th, 2019
EXA Spectrum Analyzer	KEYSIGHT	N9010A	MY57120290	Feb. 13th, 2019	Feb. 12th, 2020
Radio Communication Analyser	Anritsu	MT8820C	6201465317	Jan. 16th, 2019	Jan. 15th, 2020
Thermostatic/Hrgrosatic Chamber	TAICHY	MHG-150LF	930619	Oct. 08th, 2018	Oct. 07th, 2019
Splitter	RF-LAMBAD	RFLT2W1G18G	11-JSPD022-013	Feb. 26th, 2019	Feb. 25th, 2020
DC Block	Mini-Circuits	BLK-18-S+	31129(1)	Feb. 26th, 2019	Feb. 25th, 2020
Attenuator	Mini-Circuit	BW-S10W2+	1	Feb. 26th, 2019	Feb. 25th, 2020
Radio Communication Analyser	Anritsu	MT8815B	6200711454	Apr. 1st, 2019	Mar. 31th, 2020

7.5. Measurement Result

Freq. (MHz)	CH	99% BW (MHz)		26 dB BW (MHz)	
		GSM 1900	GPRS 1900	GSM 1900	GPRS 1900
1850.2	512	0.24327	0.24791	0.321	0.318
1880.0	661	0.24323	0.24700	0.314	0.321
1909.8	810	0.24480	0.24897	0.313	0.320

Freq. (MHz)	CH	99% BW (MHz)			26 dB BW (MHz)		
		WCDMA II	HSDPA II	HSUPA II	WCDMA II	HSDPA II	HSUPA II
1852.40	9262	4.10730	4.10900	4.10900	4.683	4.655	4.672
1880.00	9400	4.10360	4.11070	4.11060	4.654	4.655	4.655
1907.60	9538	4.11880	4.11660	4.12250	4.664	4.679	4.670

Unless otherwise stated the results shown in this test report refer only to the sample(s) tested and such sample(s) are retained for 90 days only.

除非另有說明，此報告結果僅對測試之樣品負責，同時此樣品僅保留90天。本報告未經本公司書面許可，不可部份複製。

This document is issued by the Company subject to its General Conditions of Service printed overleaf, available on request or accessible at www.sgs.com/terms_and_conditions.htm and for electronic format documents, subject to Terms and Conditions for Electronic Documents at www.sgs.com/terms_e-document.htm. Attention is drawn to the limitation of liability, indemnification and jurisdiction issues defined therein. Any holder of this document is advised that information contained hereon reflects the Company's findings at the time of its intervention only and within the limits of Client's instructions, if any. The Company's sole responsibility is to its Client and this document does not exonerate parties to a transaction from exercising all their rights and obligations under the transaction documents. This document cannot be reproduced except in full, without prior written approval of the Company. Any unauthorized alteration, forgery or falsification of the content or appearance of this document is unlawful and offenders may be prosecuted to the fullest extent of the law.

LTE BAND 2 Channel bandwidth: 1.4MHz					
Freq. (MHz)	CH	99% BW (MHz)		26 dB BW (MHz)	
		QPSK	16QAM	QPSK	16QAM
1850.7	18607	1.0972	1.1002	1.295	1.286
1880.0	18900	1.0964	1.0975	1.291	1.295
1909.3	19193	1.0947	1.0969	1.276	1.291

LTE BAND 2 Channel bandwidth: 3MHz					
Freq. (MHz)	CH	99% BW (MHz)		26 dB BW (MHz)	
		QPSK	16QAM	QPSK	16QAM
1851.5	18615	2.6966	2.6985	2.978	2.993
1880.0	18900	2.6989	2.7040	2.988	2.991
1908.5	19185	2.7003	2.6987	2.978	2.980

LTE BAND 2 Channel bandwidth: 5MHz					
Freq. (MHz)	CH	99% BW (MHz)		26 dB BW (MHz)	
		QPSK	16QAM	QPSK	16QAM
1852.5	18625	4.4995	4.5030	4.998	4.994
1880.0	18900	4.4989	4.5025	5.023	4.956
1907.5	19175	4.5091	4.4969	5.037	4.957

LTE BAND 2 Channel bandwidth: 10MHz					
Freq. (MHz)	CH	99% BW (MHz)		26 dB BW (MHz)	
		QPSK	16QAM	QPSK	16QAM
1855.0	18650	8.9859	8.9548	9.891	9.794
1880.0	18900	8.9760	8.9523	9.878	9.745
1905.0	19150	8.9719	8.9586	9.906	9.762

LTE BAND 2 Channel bandwidth: 15MHz					
Freq. (MHz)	CH	99% BW (MHz)		26 dB BW (MHz)	
		QPSK	16QAM	QPSK	16QAM
1857.5	18675	13.395	13.393	14.471	14.414
1880.0	18900	13.448	13.440	14.742	14.593
1902.5	19125	13.453	13.413	14.584	14.417

LTE BAND 2 Channel bandwidth: 20MHz					
Freq. (MHz)	CH	99% BW (MHz)		26 dB BW (MHz)	
		QPSK	16QAM	QPSK	16QAM
1860.0	18700	17.862	17.897	19.399	19.349
1880.0	18900	17.921	17.924	19.275	19.309
1900.0	19100	17.874	17.873	19.337	19.322

Unless otherwise stated the results shown in this test report refer only to the sample(s) tested and such sample(s) are retained for 90 days only.

除非另有說明，此報告結果僅對測試之樣品負責，同時此樣品僅保留90天。本報告未經本公司書面許可，不可部份複製。

This document is issued by the Company subject to its General Conditions of Service printed overleaf, available on request or accessible at www.sgs.com/terms_and_conditions.htm and for electronic format documents, subject to Terms and Conditions for Electronic Documents at www.sgs.com/terms_e-document.htm. Attention is drawn to the limitation of liability, indemnification and jurisdiction issues defined therein. Any holder of this document is advised that information contained hereon reflects the Company's findings at the time of its intervention only and within the limits of Client's instructions, if any. The Company's sole responsibility is to its Client and this document does not exonerate parties to a transaction from exercising all their rights and obligations under the transaction documents. This document cannot be reproduced except in full, without prior written approval of the Company. Any unauthorized alteration, forgery or falsification of the content or appearance of this document is unlawful and offenders may be prosecuted to the fullest extent of the law.

WCDMA_B2_LowCH9262-1852.4

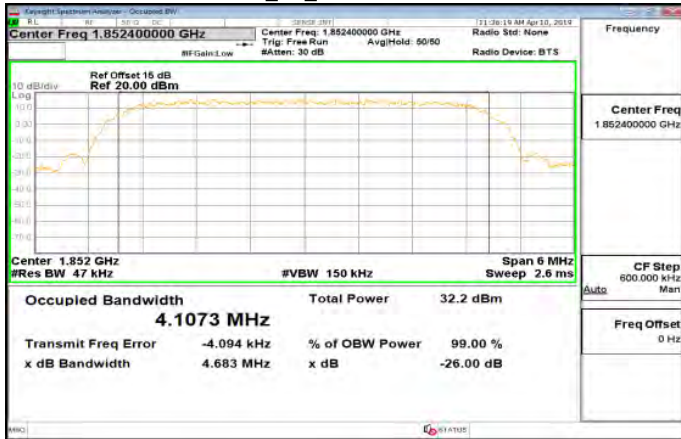

HSDPA_B2_LowCH9262-1852.4

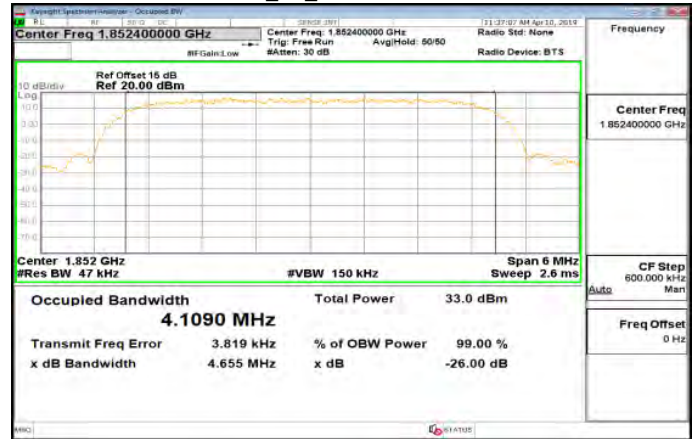

WCDMA_B2_MidCH9400-1880

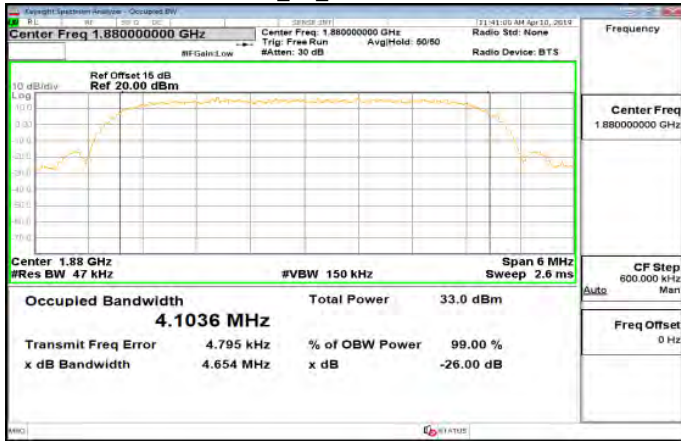

HSDPA_B2_MidCH9400-1880

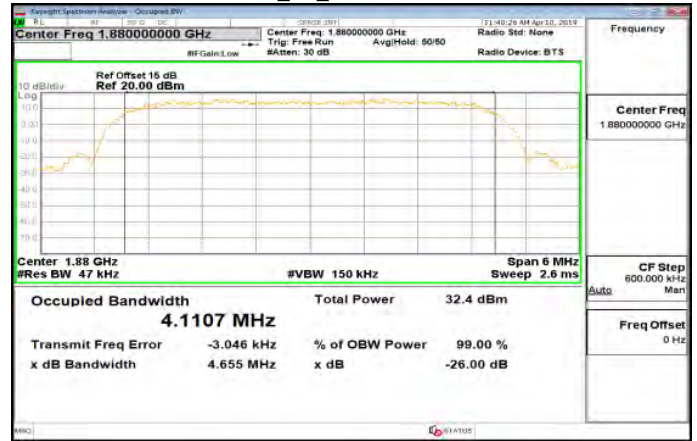

WCDMA_B2_HighCH9538-1907.6

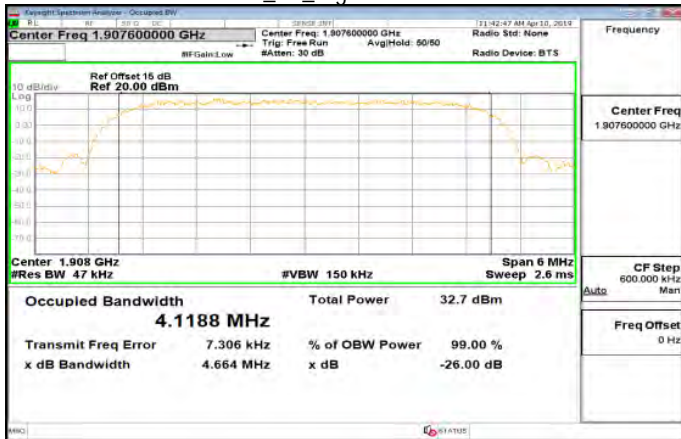

HSDPA_B2_HighCH9538-1907.6

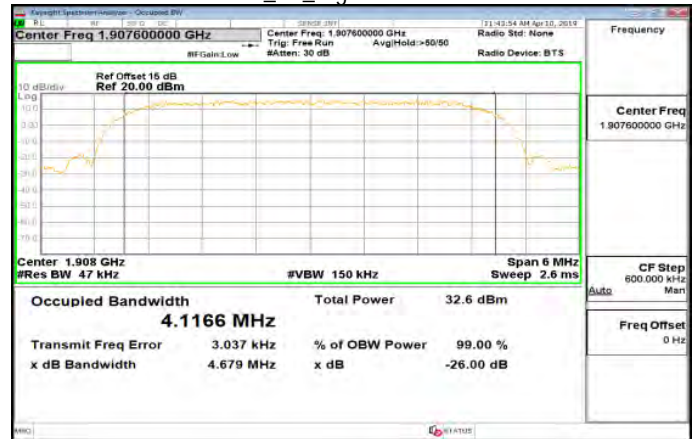

Unless otherwise stated the results shown in this test report refer only to the sample(s) tested and such sample(s) are retained for 90 days only.

除非另有說明，此報告結果僅對測試之樣品負責，同時此樣品僅保留90天。本報告未經本公司書面許可，不可部份複製。

This document is issued by the Company subject to its General Conditions of Service printed overleaf, available on request or accessible at www.sgs.com/terms_and_conditions.htm and for electronic format documents, subject to Terms and Conditions for Electronic Documents at www.sgs.com/terms_e-document.htm. Attention is drawn to the limitation of liability, indemnification and jurisdiction issues defined therein. Any holder of this document is advised that information contained hereon reflects the Company's findings at the time of its intervention only and within the limits of Client's instructions, if any. The Company's sole responsibility is to its Client and this document does not exonerate parties to a transaction from exercising all their rights and obligations under the transaction documents. This document cannot be reproduced except in full, without prior written approval of the Company. Any unauthorized alteration, forgery or falsification of the content or appearance of this document is unlawful and offenders may be prosecuted to the fullest extent of the law.

HSUPA_B2_LowCH9262-1852.4

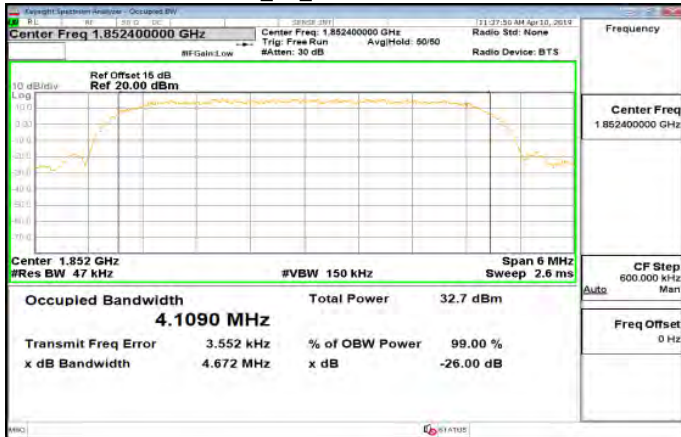

Band2_1_4MHz_QPSK_6_0_LowCH18607-1850.7

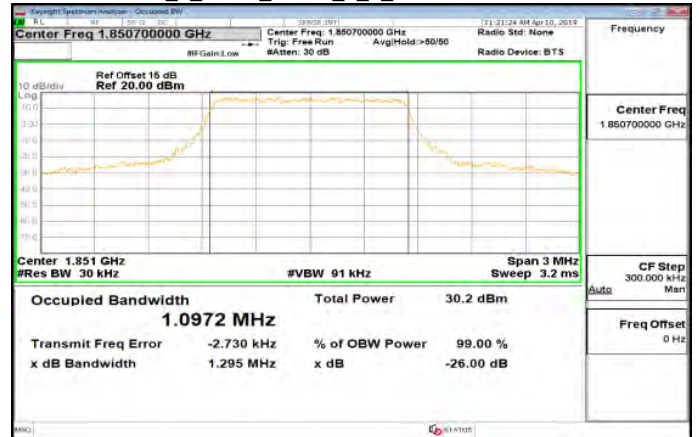

HSUPA_B2_MidCH9400-1880

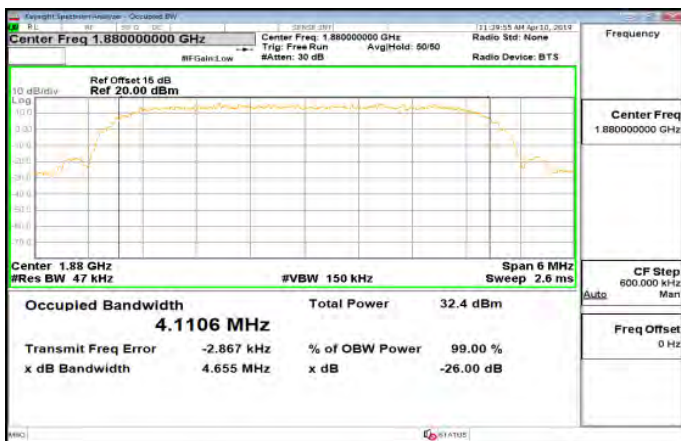

Band2_1_4MHz_QPSK_6_0_MidCH18900-1880

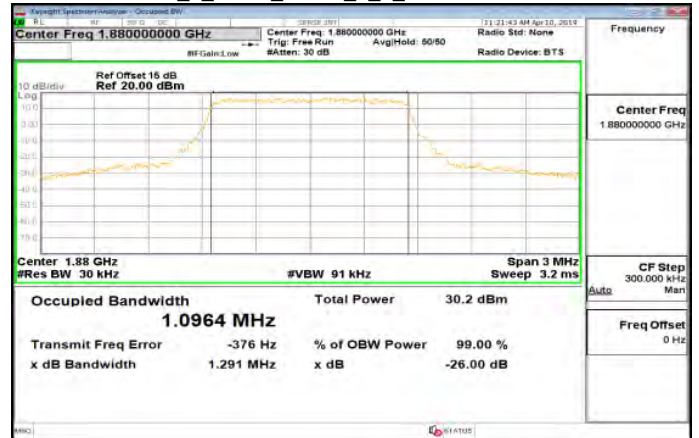

HSUPA_B2_HighCH9538-1907.6

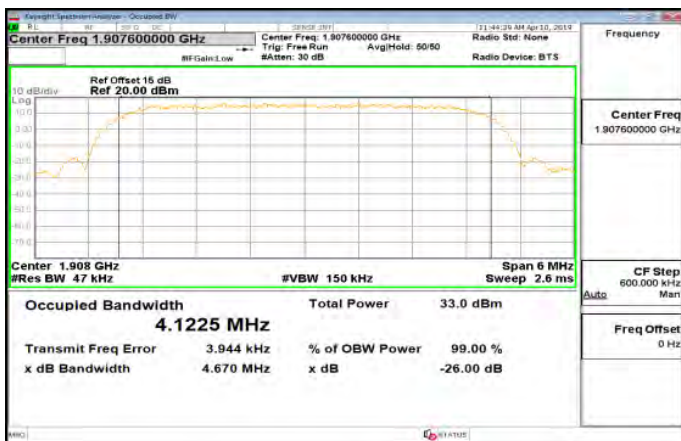

Band2_1_4MHz_QPSK_6_0_HighCH19193-1909.3

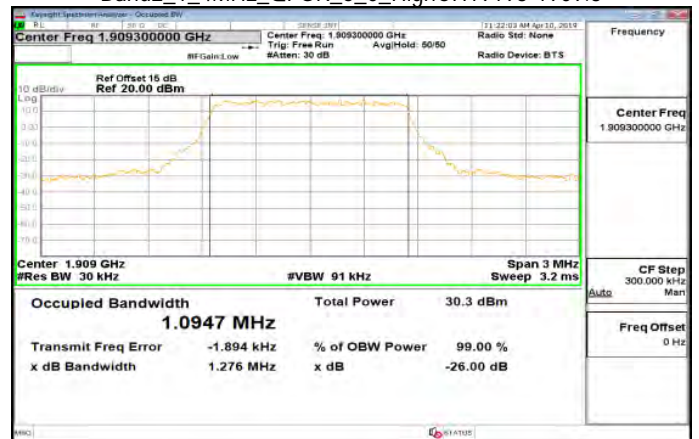

Unless otherwise stated the results shown in this test report refer only to the sample(s) tested and such sample(s) are retained for 90 days only.

除非另有說明，此報告結果僅對測試之樣品負責，同時此樣品僅保留90天。本報告未經本公司書面許可，不可部份複製。

This document is issued by the Company subject to its General Conditions of Service printed overleaf, available on request or accessible at www.sgs.com/terms_and_conditions.htm and for electronic format documents, subject to Terms and Conditions for Electronic Documents at www.sgs.com/terms_e-document.htm. Attention is drawn to the limitation of liability, indemnification and jurisdiction issues defined therein. Any holder of this document is advised that information contained hereon reflects the Company's findings at the time of its intervention only and within the limits of Client's instructions, if any. The Company's sole responsibility is to its Client and this document does not exonerate parties to a transaction from exercising all their rights and obligations under the transaction documents. This document cannot be reproduced except in full, without prior written approval of the Company. Any unauthorized alteration, forgery or falsification of the content or appearance of this document is unlawful and offenders may be prosecuted to the fullest extent of the law.

Band2_1_4MHz_16QAM_6_0_LowCH18607-1850.7

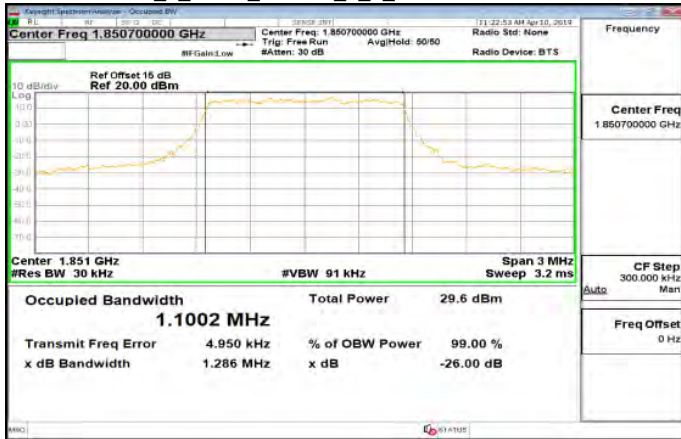

Band2_3MHz_QPSK_15_0_LowCH18615-1851.5

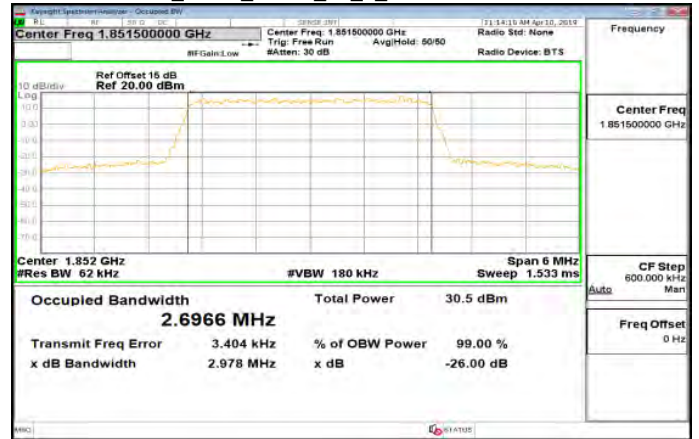

Band2_1_4MHz_16QAM_6_0_MidCH18900-1880

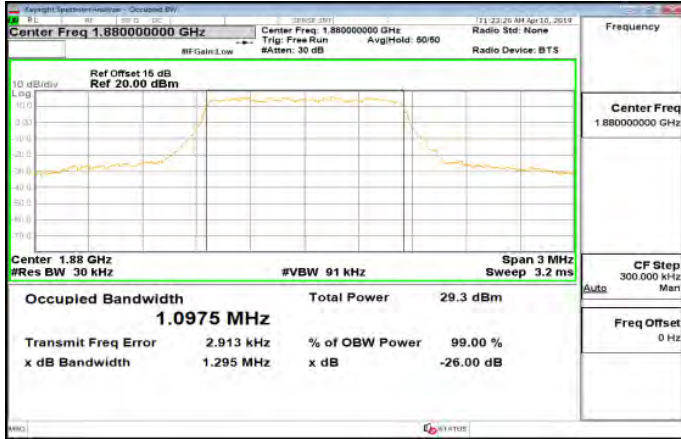

Band2_3MHz_QPSK_15_0_MidCH18900-1880

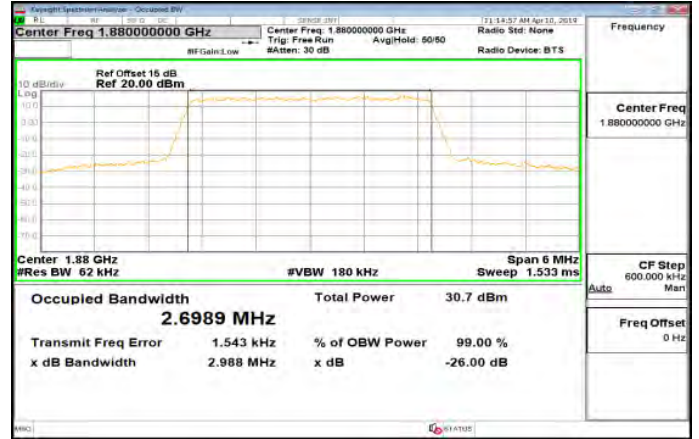

Band2_1_4MHz_16QAM_6_0_HighCH19193-1909.3

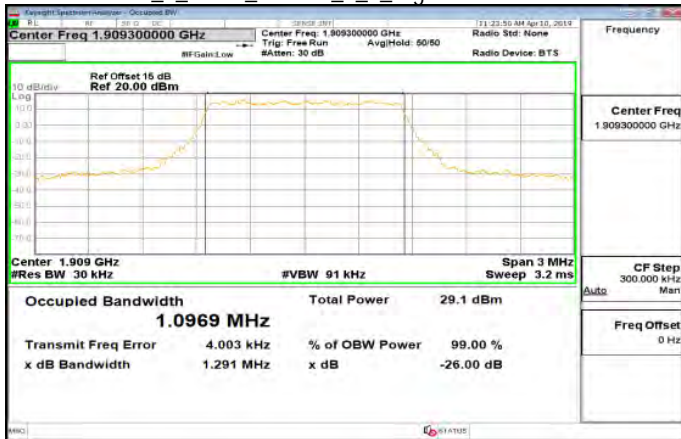

Band2_3MHz_QPSK_15_0_HighCH19185-1908.5

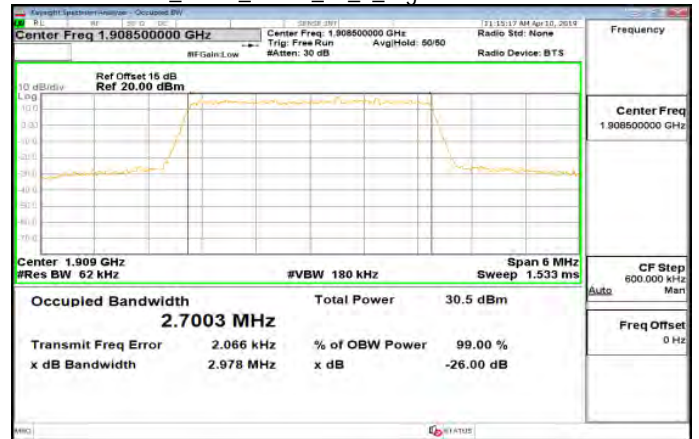

Unless otherwise stated the results shown in this test report refer only to the sample(s) tested and such sample(s) are retained for 90 days only.

除非另有說明，此報告結果僅對測試之樣品負責，同時此樣品僅保留90天。本報告未經本公司書面許可，不可部份複製。

This document is issued by the Company subject to its General Conditions of Service printed overleaf, available on request or accessible at www.sgs.com/terms_and_conditions.htm and for electronic format documents, subject to Terms and Conditions for Electronic Documents at www.sgs.com/terms_e-document.htm. Attention is drawn to the limitation of liability, indemnification and jurisdiction issues defined therein. Any holder of this document is advised that information contained hereon reflects the Company's findings at the time of its intervention only and within the limits of Client's instructions, if any. The Company's sole responsibility is to its Client and this document does not exonerate parties to a transaction from exercising all their rights and obligations under the transaction documents. This document cannot be reproduced except in full, without prior written approval of the Company. Any unauthorized alteration, forgery or falsification of the content or appearance of this document is unlawful and offenders may be prosecuted to the fullest extent of the law.

Band2_3MHz_16QAM_15_0_LowCH18615-1851.5

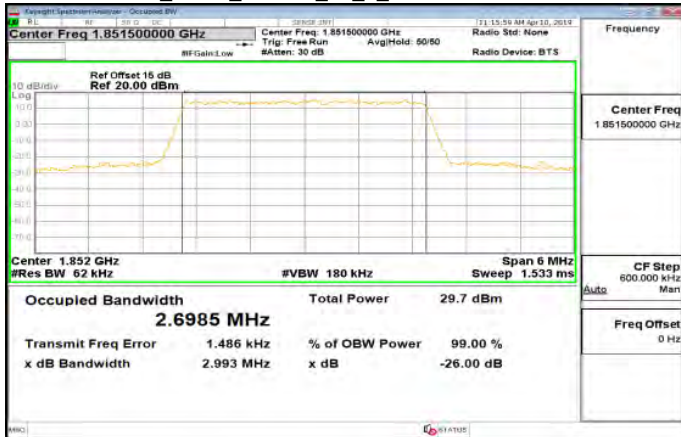

Band2_5MHz_QPSK_25_0_LowCH18625-1852.5

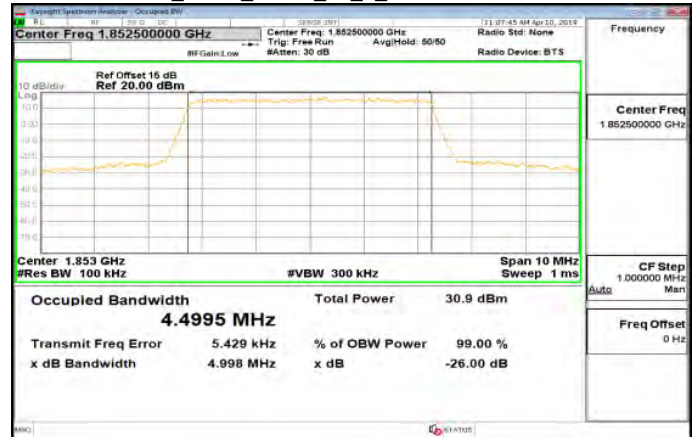

Band2_3MHz_16QAM_15_0_MidCH18900-1880

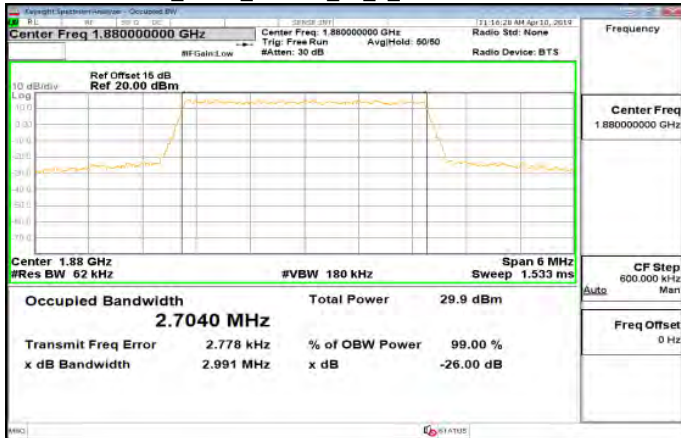

Band2_5MHz_QPSK_25_0_MidCH18900-1880

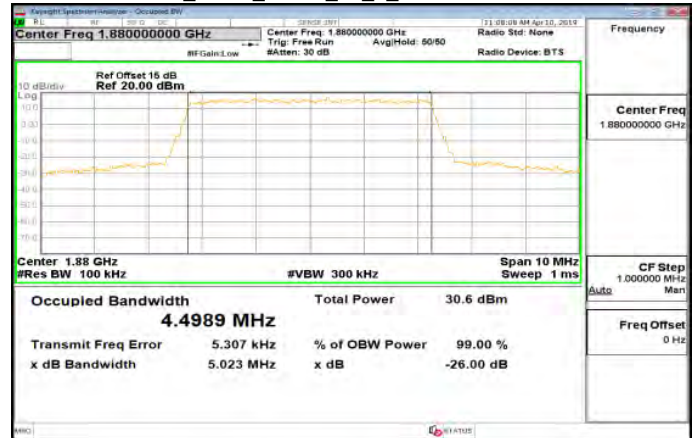

Band2_3MHz_16QAM_15_0_HighCH19185-1908.5

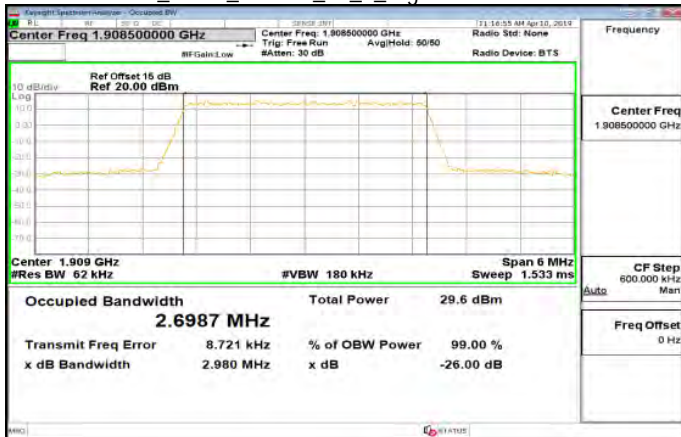

Band2_5MHz_QPSK_25_0_HighCH19175-1907.5

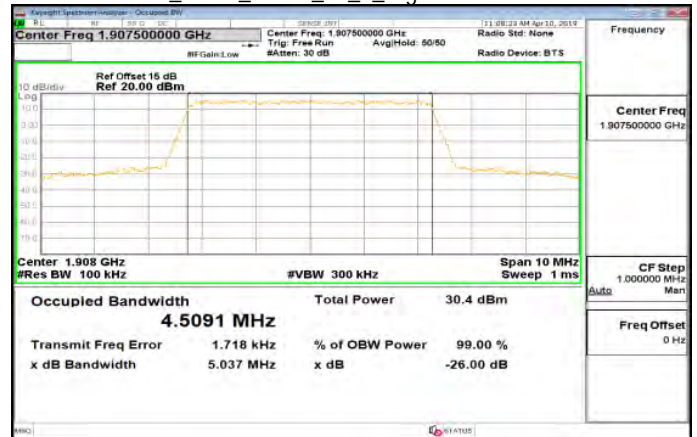

Unless otherwise stated the results shown in this test report refer only to the sample(s) tested and such sample(s) are retained for 90 days only.

除非另有說明，此報告結果僅對測試之樣品負責，同時此樣品僅保留90天。本報告未經本公司書面許可，不可部份複製。

This document is issued by the Company subject to its General Conditions of Service printed overleaf, available on request or accessible at www.sgs.com/terms_and_conditions.htm and for electronic format documents, subject to Terms and Conditions for Electronic Documents at www.sgs.com/terms_e-document.htm. Attention is drawn to the limitation of liability, indemnification and jurisdiction issues defined therein. Any holder of this document is advised that information contained hereon reflects the Company's findings at the time of its intervention only and within the limits of Client's instructions, if any. The Company's sole responsibility is to its Client and this document does not exonerate parties to a transaction from exercising all their rights and obligations under the transaction documents. This document cannot be reproduced except in full, without prior written approval of the Company. Any unauthorized alteration, forgery or falsification of the content or appearance of this document is unlawful and offenders may be prosecuted to the fullest extent of the law.

Band2_5MHz_16QAM_25_0_LowCH18625-1852.5

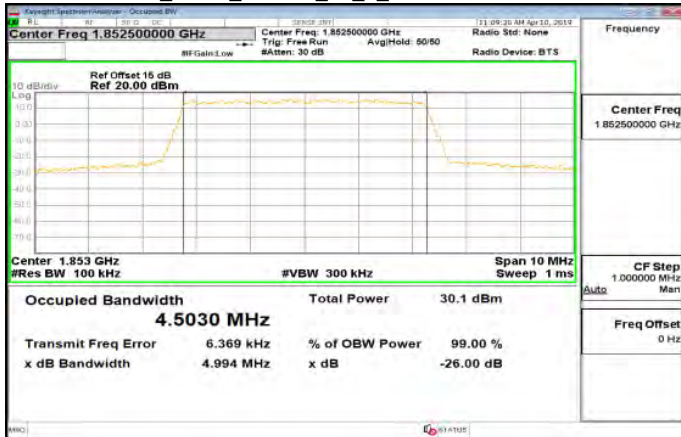

Band2_10MHz_QPSK_50_0_LowCH18650-1855

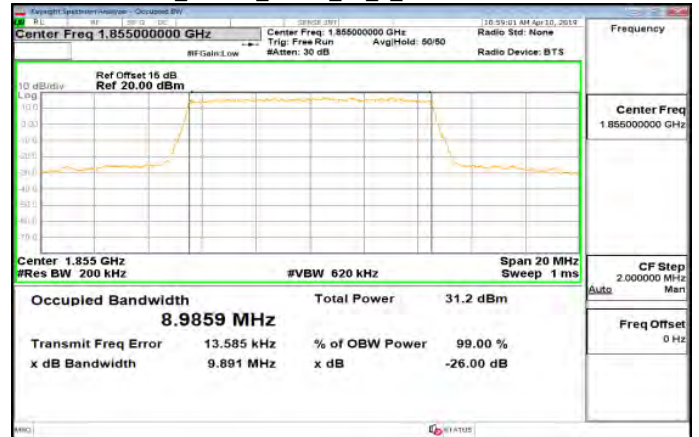

Band2_5MHz_16QAM_25_0_MidCH18900-1880

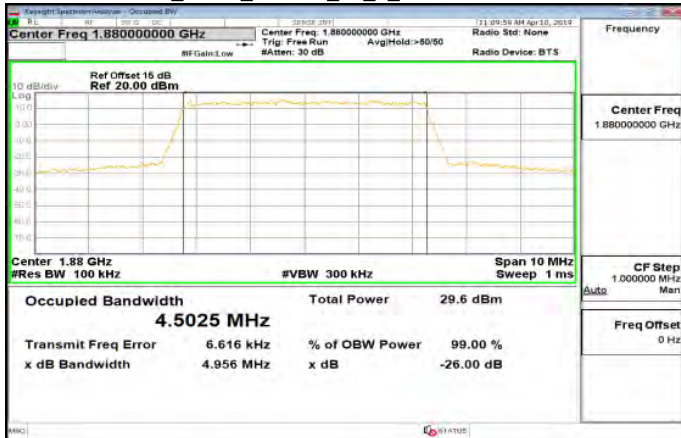

Band2_10MHz_QPSK_50_0_MidCH18900-1880

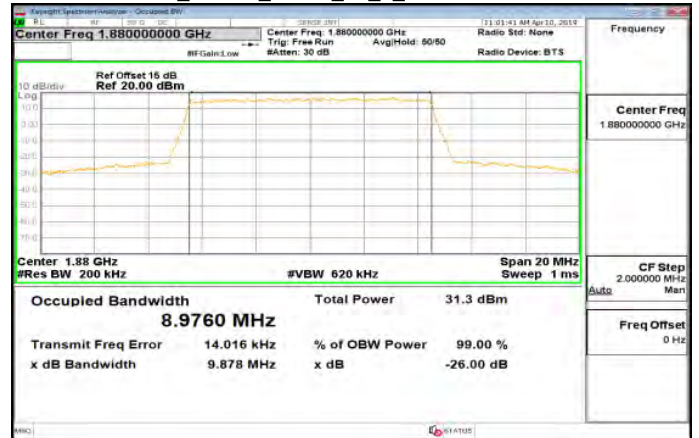

Band2_5MHz_16QAM_25_0_HighCH19175-1907.5

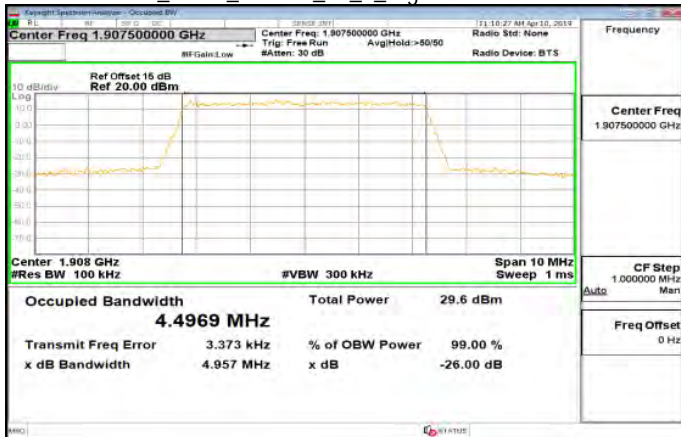

Band2_10MHz_QPSK_50_0_HighCH19150-1905

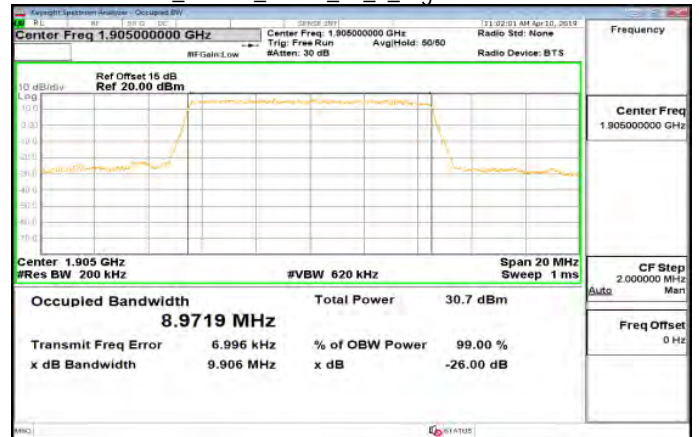

Unless otherwise stated the results shown in this test report refer only to the sample(s) tested and such sample(s) are retained for 90 days only.

除非另有說明，此報告結果僅對測試之樣品負責，同時此樣品僅保留90天。本報告未經本公司書面許可，不可部份複製。

This document is issued by the Company subject to its General Conditions of Service printed overleaf, available on request or accessible at www.sgs.com/terms_and_conditions.htm and for electronic format documents, subject to Terms and Conditions for Electronic Documents at www.sgs.com/terms_e-document.htm. Attention is drawn to the limitation of liability, indemnification and jurisdiction issues defined therein. Any holder of this document is advised that information contained hereon reflects the Company's findings at the time of its intervention only and within the limits of Client's instructions, if any. The Company's sole responsibility is to its Client and this document does not exonerate parties to a transaction from exercising all their rights and obligations under the transaction documents. This document cannot be reproduced except in full, without prior written approval of the Company. Any unauthorized alteration, forgery or falsification of the content or appearance of this document is unlawful and offenders may be prosecuted to the fullest extent of the law.

Band2_10MHz_16QAM_50_0_LowCH18650-1855

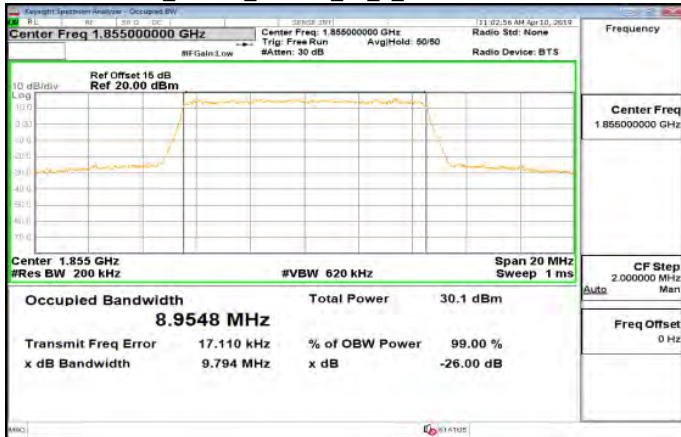

Band2_15MHz_QPSK_75_0_LowCH18675-1857.5

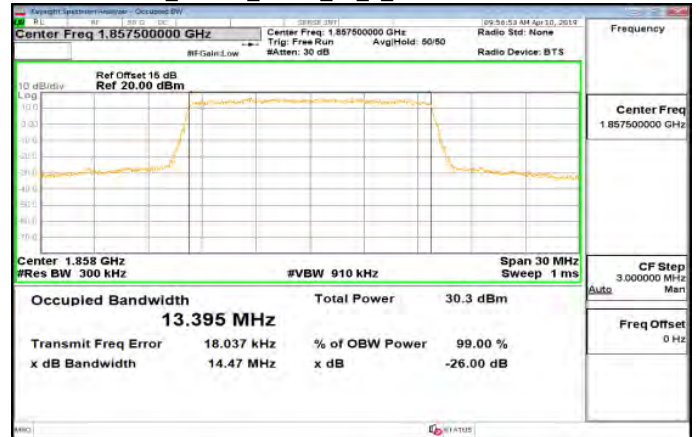

Band2_10MHz_16QAM_50_0_MidCH18900-1880

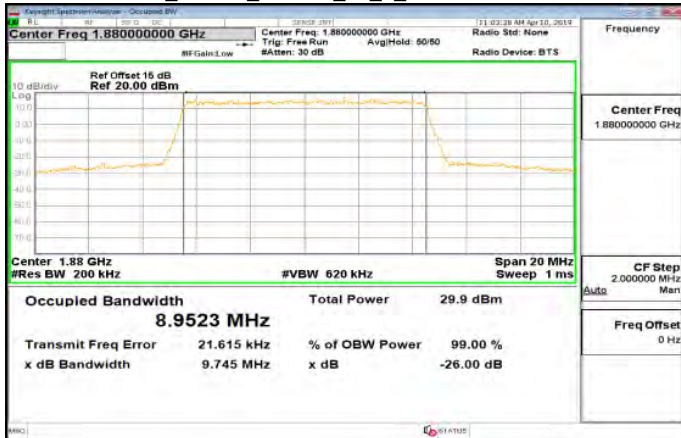

Band2_15MHz_QPSK_75_0_MidCH18900-1880

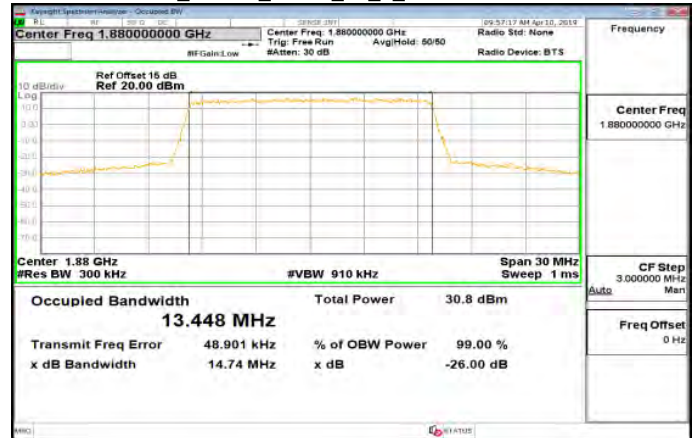

Band2_10MHz_16QAM_50_0_HighCH19150-1905

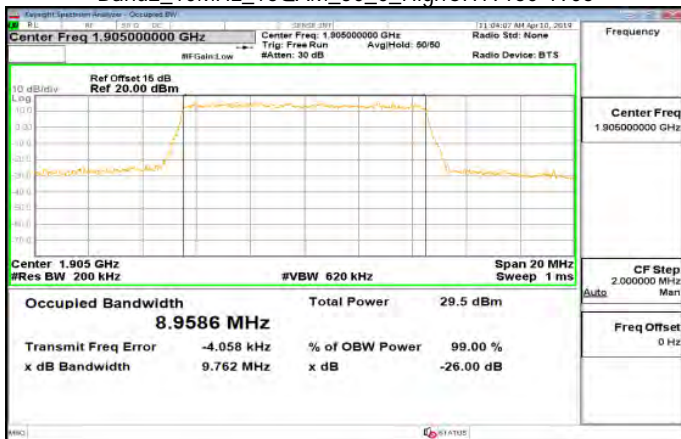

Band2_15MHz_QPSK_75_0_HighCH19125-1902.5

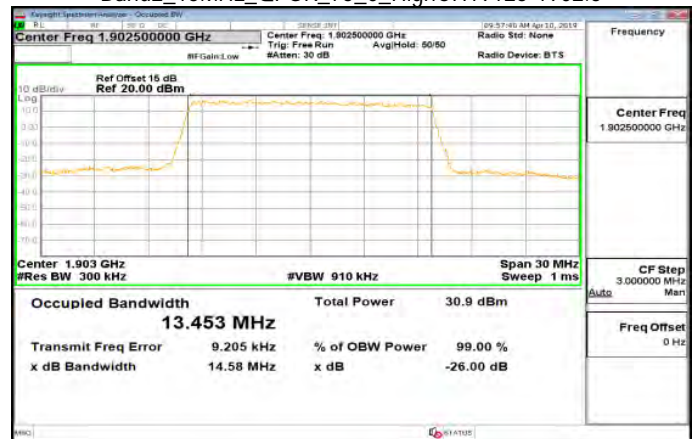

Unless otherwise stated the results shown in this test report refer only to the sample(s) tested and such sample(s) are retained for 90 days only.

除非另有說明，此報告結果僅對測試之樣品負責，同時此樣品僅保留90天。本報告未經本公司書面許可，不可部份複製。

This document is issued by the Company subject to its General Conditions of Service printed overleaf, available on request or accessible at www.sgs.com/terms_and_conditions.htm and for electronic format documents, subject to Terms and Conditions for Electronic Documents at www.sgs.com/terms_e-document.htm. Attention is drawn to the limitation of liability, indemnification and jurisdiction issues defined therein. Any holder of this document is advised that information contained hereon reflects the Company's findings at the time of its intervention only and within the limits of Client's instructions, if any. The Company's sole responsibility is to its Client and this document does not exonerate parties to a transaction from exercising all their rights and obligations under the transaction documents. This document cannot be reproduced except in full, without prior written approval of the Company. Any unauthorized alteration, forgery or falsification of the content or appearance of this document is unlawful and offenders may be prosecuted to the fullest extent of the law.

Band2_15MHz_16QAM_75_0_LowCH18675-1857.5

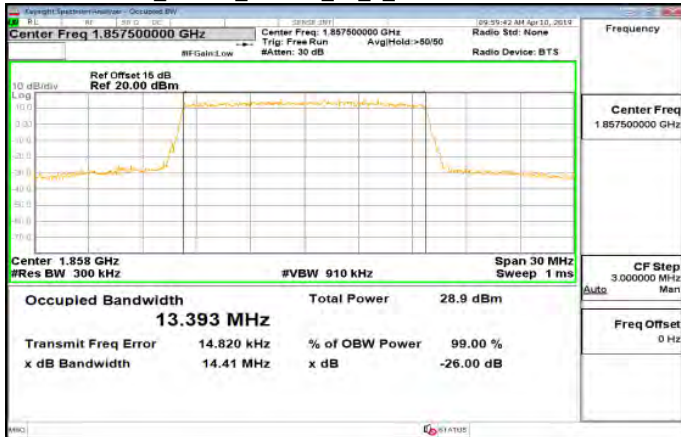

Band2_20MHz_QPSK_100_0_LowCH18700-1860

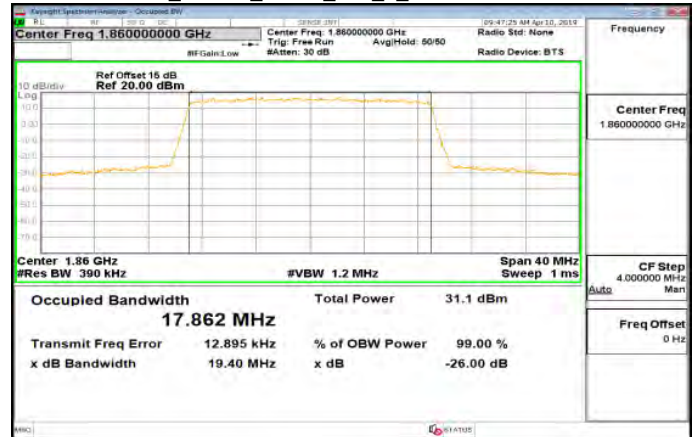

Band2_15MHz_16QAM_75_0_MidCH18900-1880

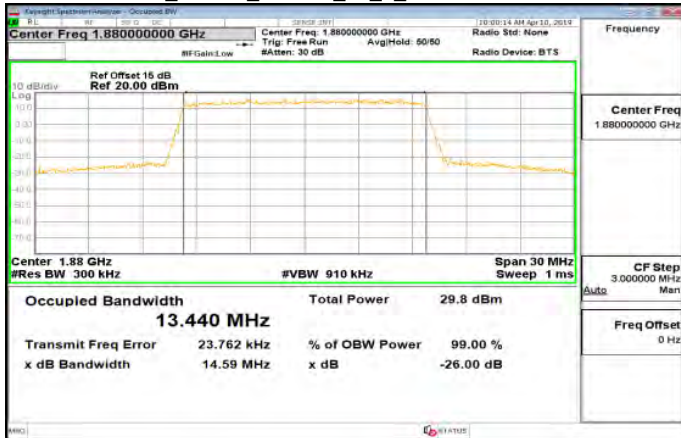

Band2_20MHz_QPSK_100_0_MidCH18900-1880

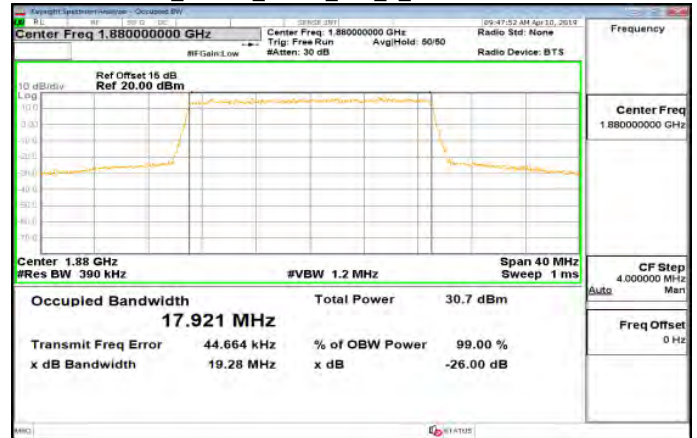

Band2_15MHz_16QAM_75_0_HighCH19125-1902.5

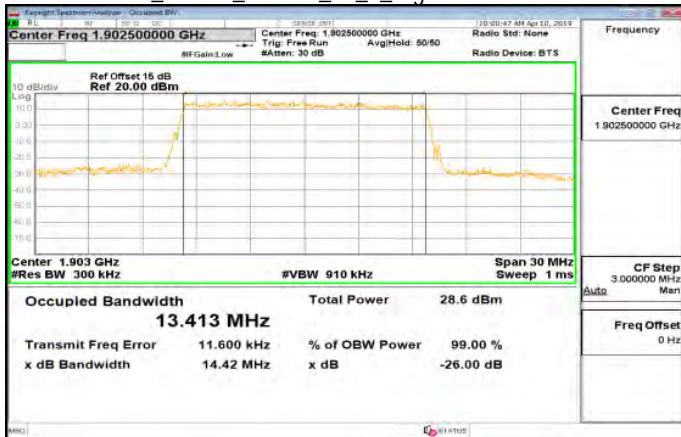

Band2_20MHz_QPSK_100_0_HighCH19100-1900

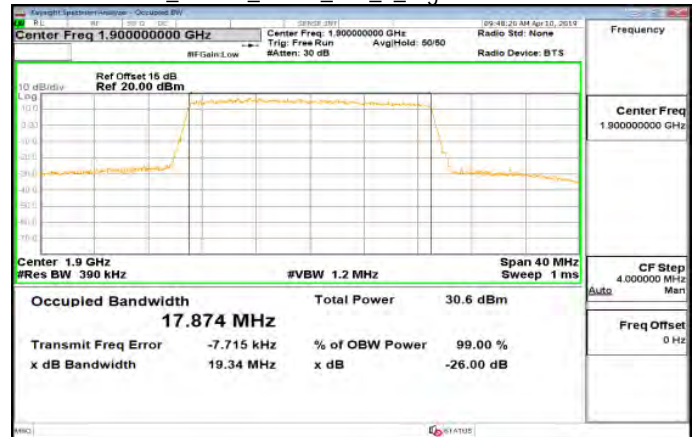

Unless otherwise stated the results shown in this test report refer only to the sample(s) tested and such sample(s) are retained for 90 days only.

除非另有說明，此報告結果僅對測試之樣品負責，同時此樣品僅保留90天。本報告未經本公司書面許可，不可部份複製。

This document is issued by the Company subject to its General Conditions of Service printed overleaf, available on request or accessible at www.sgs.com/terms_and_conditions.htm and for electronic format documents, subject to Terms and Conditions for Electronic Documents at www.sgs.com/terms_e-document.htm. Attention is drawn to the limitation of liability, indemnification and jurisdiction issues defined therein. Any holder of this document is advised that information contained hereon reflects the Company's findings at the time of its intervention only and within the limits of Client's instructions, if any. The Company's sole responsibility is to its Client and this document does not exonerate parties to a transaction from exercising all their rights and obligations under the transaction documents. This document cannot be reproduced except in full, without prior written approval of the Company. Any unauthorized alteration, forgery or falsification of the content or appearance of this document is unlawful and offenders may be prosecuted to the fullest extent of the law.

Band2_20MHz_16QAM_100_0_LowCH18700-1860

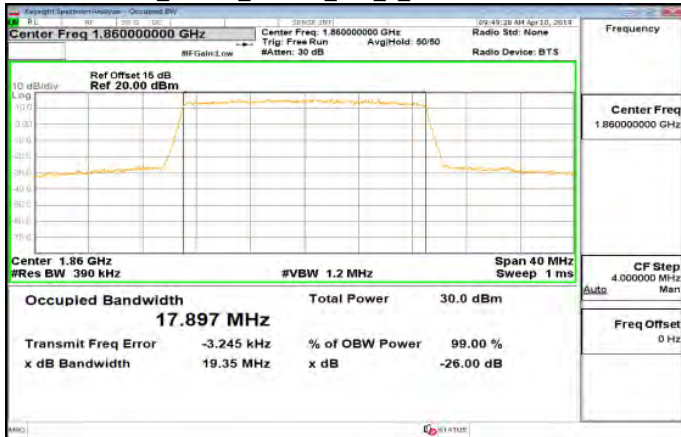

Band2_20MHz_16QAM_100_0_MidCH18900-1880

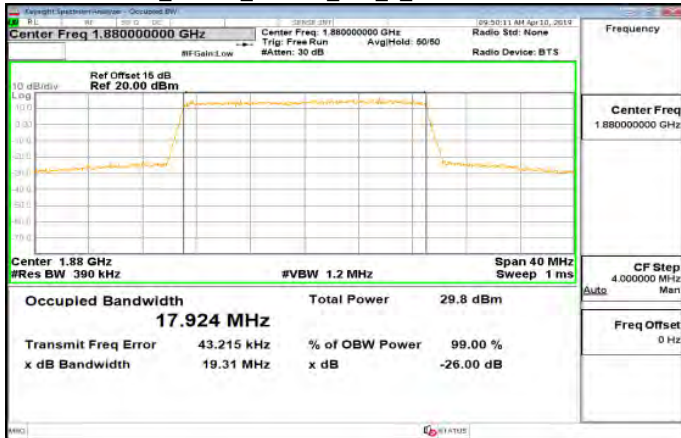

Band2_20MHz_16QAM_100_0_HighCH19100-1900

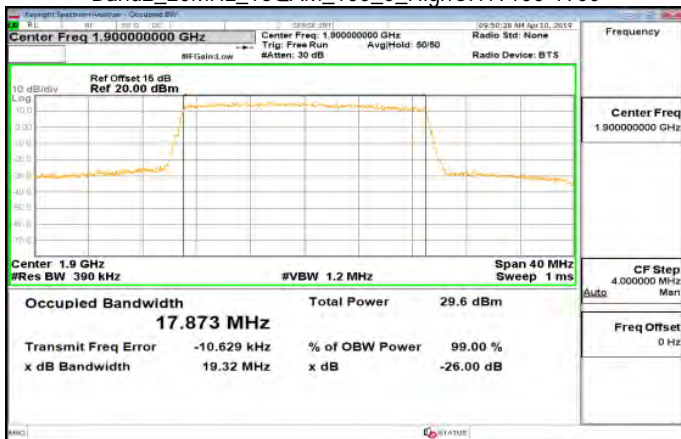

Unless otherwise stated the results shown in this test report refer only to the sample(s) tested and such sample(s) are retained for 90 days only.

除非另有說明，此報告結果僅對測試之樣品負責，同時此樣品僅保留90天。本報告未經本公司書面許可，不可部份複製。

This document is issued by the Company subject to its General Conditions of Service printed overleaf, available on request or accessible at www.sgs.com/terms_and_conditions.htm and for electronic format documents, subject to Terms and Conditions for Electronic Documents at www.sgs.com/terms_e-document.htm. Attention is drawn to the limitation of liability, indemnification and jurisdiction issues defined therein. Any holder of this document is advised that information contained hereon reflects the Company's findings at the time of its intervention only and within the limits of Client's instructions, if any. The Company's sole responsibility is to its Client and this document does not exonerate parties to a transaction from exercising all their rights and obligations under the transaction documents. This document cannot be reproduced except in full, without prior written approval of the Company. Any unauthorized alteration, forgery or falsification of the content or appearance of this document is unlawful and offenders may be prosecuted to the fullest extent of the law.

8. OUT OF BAND EMISSION AT ANTENNA TERMINALS

8.1. Standard Applicable

FCC §24.238(a), Out of band emissions. The power of any emission outside of the authorized operating frequency ranges must be attenuated below the transmitting power (P) by a factor of at least $43 + 10 \log(P)$ dB.

8.2. Test SET-UP

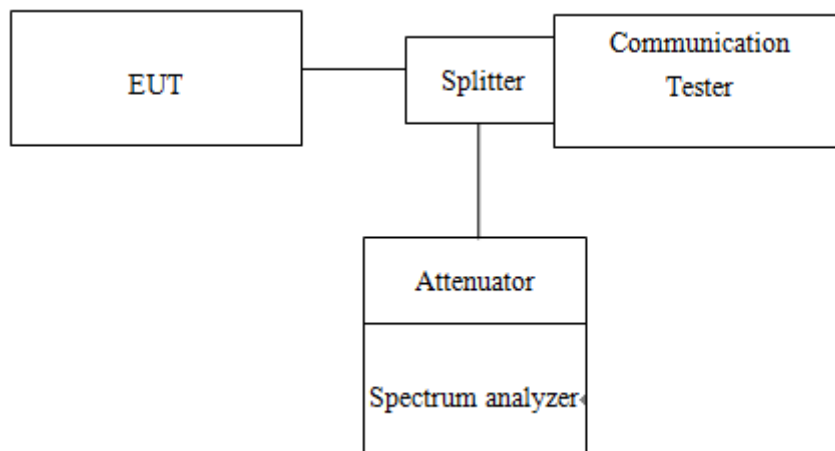

8.3. Measurement Procedure

Conducted Emission

The RF output of the transceiver was connected to a spectrum analyzer through appropriate attenuation. The resolution bandwidth of the spectrum analyzer was set at 1MHz, sufficient scans were taken to show the out of band Emissions if any up to 10th harmonic.

1. To connect Antenna Port of EUT to Spectrum.
2. Set RBW = 1MHz & VBW = 1MHz on Spectrum.
3. Allow trace to fully stabilize
4. Repeat above procedures until all default test channel measured were complete.

Band Edge

1. To connect Antenna Port of EUT to Spectrum.
2. The band edge of low and high channels for the highest RF powers was measured. Setting RBW $\geq 1\%$ EBW.
3. Allow trace to fully stabilize
4. Repeat above procedures until all default test channel measured were complete.

Unless otherwise stated the results shown in this test report refer only to the sample(s) tested and such sample(s) are retained for 90 days only.

除非另有說明，此報告結果僅對測試之樣品負責，同時此樣品僅保留90天。本報告未經本公司書面許可，不可部份複製。

This document is issued by the Company subject to its General Conditions of Service printed overleaf, available on request or accessible at www.sgs.com/terms_and_conditions.htm and for electronic format documents, subject to Terms and Conditions for Electronic Documents at www.sgs.com/terms_e-document.htm. Attention is drawn to the limitation of liability, indemnification and jurisdiction issues defined therein. Any holder of this document is advised that information contained hereon reflects the Company's findings at the time of its intervention only and within the limits of Client's instructions, if any. The Company's sole responsibility is to its Client and this document does not exonerate parties to a transaction from exercising all their rights and obligations under the transaction documents. This document cannot be reproduced except in full, without prior written approval of the Company. Any unauthorized alteration, forgery or falsification of the content or appearance of this document is unlawful and offenders may be prosecuted to the fullest extent of the law.

8.4. Measurement Equipment Used

EQUIPMENT TYPE	MFR	MODEL NUMBER	SERIAL NUMBER	LAST CAL.	CAL DUE.
DC Power Supply	Agilent	E3640A	KR93300208	Aug. 15th, 2018	Aug. 14th, 2019
EXA Spectrum Analyzer	KEYSIGHT	N9010A	MY57120290	Feb. 13th, 2019	Feb. 12th, 2020
Radio Communication Analyer	Anritsu	MT8820C	6201465317	Jan. 16th, 2019	Jan. 15th, 2020
Thermostatic/Hrgrosatic Chamber	TAICHY	MHG-150LF	930619	Oct. 08th, 2018	Oct. 07th, 2019
Splitter	RF-LAMBAD	RFLT2W1G18G	11-JSPD022-013	Feb. 26th, 2019	Feb. 25th, 2020
DC Block	Mini-Circuits	BLK-18-S+	31129(1)	Feb. 26th, 2019	Feb. 25th, 2020
Attenuator	Mini-Circuit	BW-S10W2+	1	Feb. 26th, 2019	Feb. 25th, 2020
Radio Communication Analyer	Anritsu	MT8815B	6200711454	Apr. 1st, 2019	Mar. 31th, 2020

8.5. Measurement Result:

Refer to next pages.

NOTE: The occurrence of the spike on the conducted emission is the signal of the fundamental emission.

Unless otherwise stated the results shown in this test report refer only to the sample(s) tested and such sample(s) are retained for 90 days only.

除非另有說明，此報告結果僅對測試之樣品負責，同時此樣品僅保留90天。本報告未經本公司書面許可，不可部份複製。

This document is issued by the Company subject to its General Conditions of Service printed overleaf, available on request or accessible at www.sgs.com/terms_and_conditions.htm and for electronic format documents, subject to Terms and Conditions for Electronic Documents at www.sgs.com/terms_e-document.htm. Attention is drawn to the limitation of liability, indemnification and jurisdiction issues defined therein. Any holder of this document is advised that information contained hereon reflects the Company's findings at the time of its intervention only and within the limits of Client's instructions, if any. The Company's sole responsibility is to its Client and this document does not exonerate parties to a transaction from exercising all their rights and obligations under the transaction documents. This document cannot be reproduced except in full, without prior written approval of the Company. Any unauthorized alteration, forgery or falsification of the content or appearance of this document is unlawful and offenders may be prosecuted to the fullest extent of the law.

Band Edge
GSM_1900MHz_LowCH512-1850.2

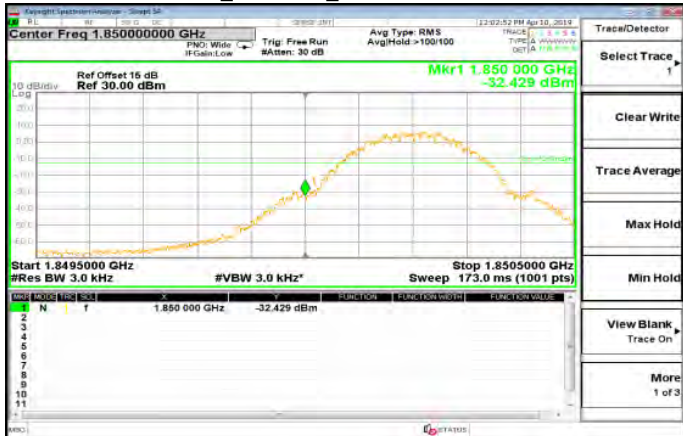

GPRS_1900MHz_HighCH810-1909.8

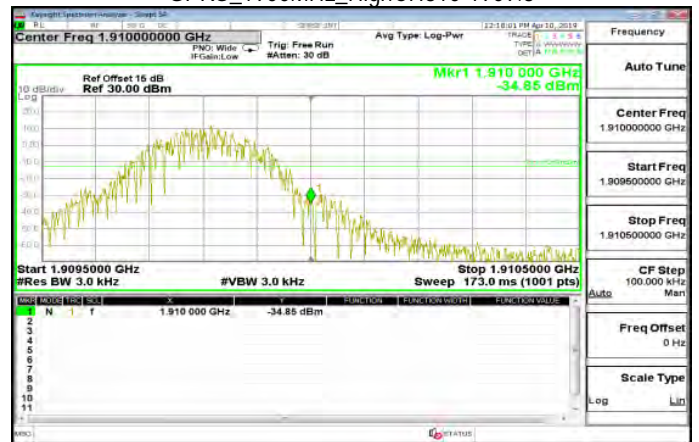

GSM_1900MHz_HighCH810-1909.8

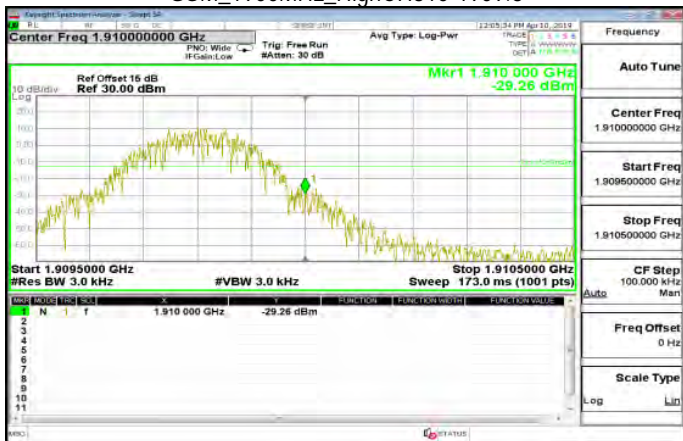

WCDMA_B2_LowCH9262-1852.4

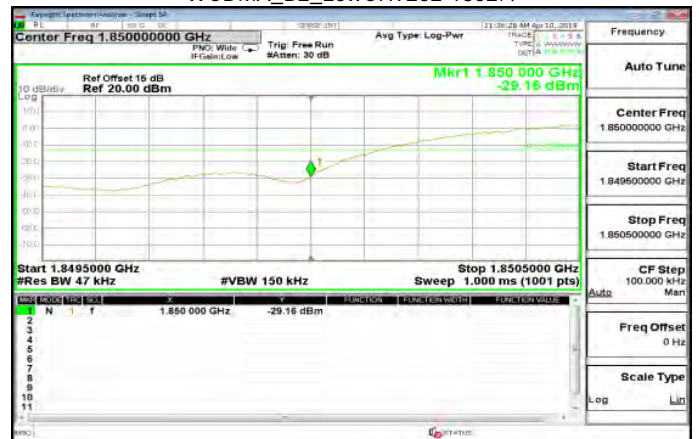

GPRS_1900MHz_LowCH512-1850.2

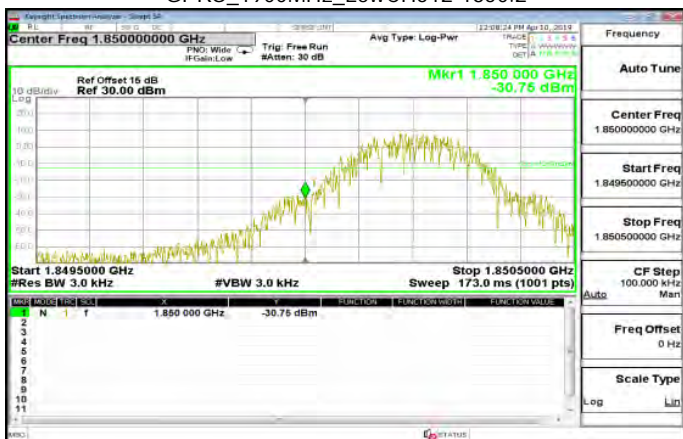

WCDMA_B2_HighCH9538-1907.6

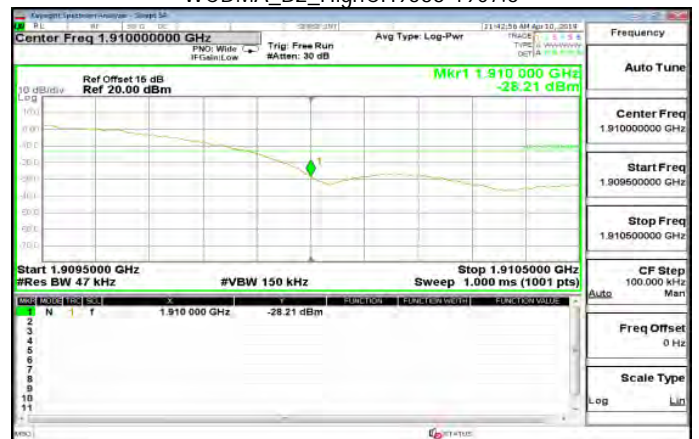

Unless otherwise stated the results shown in this test report refer only to the sample(s) tested and such sample(s) are retained for 90 days only.

除非另有說明，此報告結果僅對測試之樣品負責，同時此樣品僅保留90天。本報告未經本公司書面許可，不可部份複製。

This document is issued by the Company subject to its General Conditions of Service printed overleaf, available on request or accessible at www.sgs.com/terms_and_conditions.htm and for electronic format documents, subject to Terms and Conditions for Electronic Documents at www.sgs.com/terms_e-document.htm. Attention is drawn to the limitation of liability, indemnification and jurisdiction issues defined therein. Any holder of this document is advised that information contained hereon reflects the Company's findings at the time of its intervention only and within the limits of Client's instructions, if any. The Company's sole responsibility is to its Client and this document does not exonerate parties to a transaction from exercising all their rights and obligations under the transaction documents. This document cannot be reproduced except in full, without prior written approval of the Company. Any unauthorized alteration, forgery or falsification of the content or appearance of this document is unlawful and offenders may be prosecuted to the fullest extent of the law.

HSDPA_B2_LowCH9262-1852.4

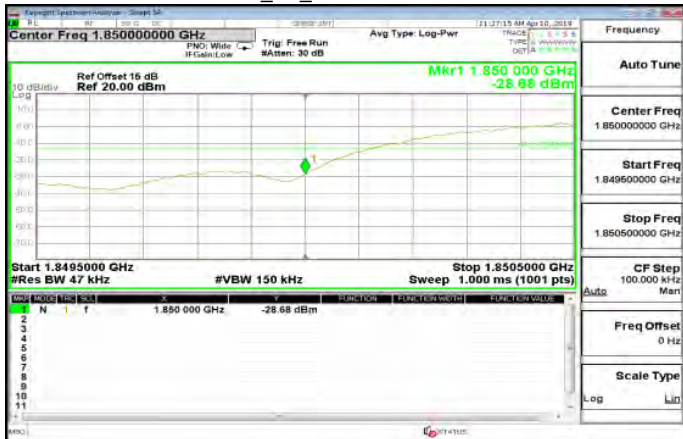

HSUPA_B2_HighCH9538-1907.6

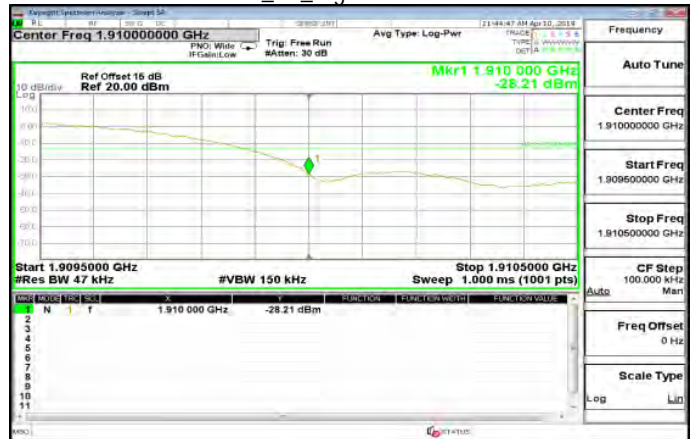

HSDPA_B2_HighCH9538-1907.6

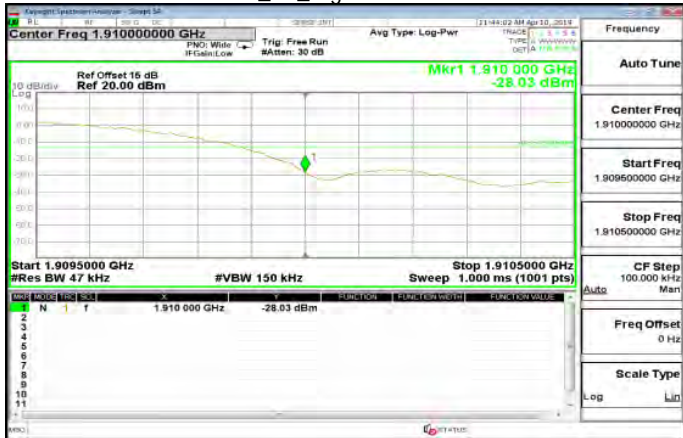

Band2_1_4MHz_QPSK_1_0_LowCH18607-1850.7

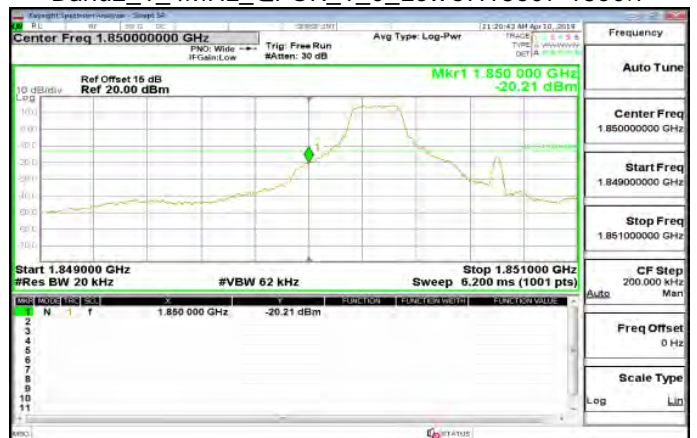

HSUPA_B2_LowCH9262-1852.4

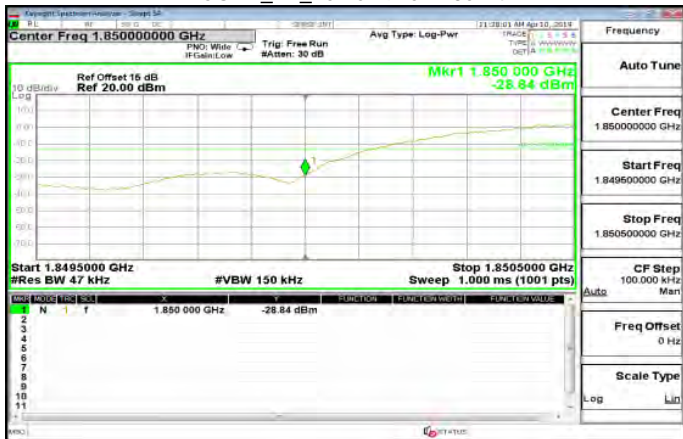

Band2_1_4MHz_QPSK_1_5_HighCH19193-1909.3

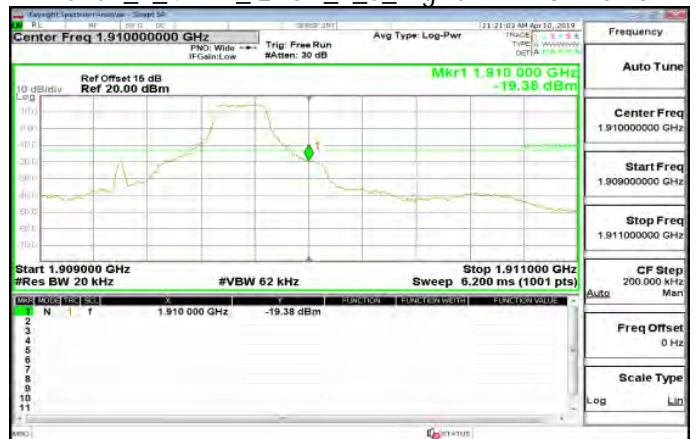

Unless otherwise stated the results shown in this test report refer only to the sample(s) tested and such sample(s) are retained for 90 days only.

除非另有說明，此報告結果僅對測試之樣品負責，同時此樣品僅保留90天。本報告未經本公司書面許可，不可部份複製。

This document is issued by the Company subject to its General Conditions of Service printed overleaf, available on request or accessible at www.sgs.com/terms_and_conditions.htm and for electronic format documents, subject to Terms and Conditions for Electronic Documents at www.sgs.com/terms_e-document.htm. Attention is drawn to the limitation of liability, indemnification and jurisdiction issues defined therein. Any holder of this document is advised that information contained hereon reflects the Company's findings at the time of its intervention only and within the limits of Client's instructions, if any. The Company's sole responsibility is to its Client and this document does not exonerate parties to a transaction from exercising all their rights and obligations under the transaction documents. This document cannot be reproduced except in full, without prior written approval of the Company. Any unauthorized alteration, forgery or falsification of the content or appearance of this document is unlawful and offenders may be prosecuted to the fullest extent of the law.

Band2_1_4MHz_QPSK_6_0_LowCH18607-1850.7



Band2_3MHz_QPSK_1_14_HighCH19185-1908.5

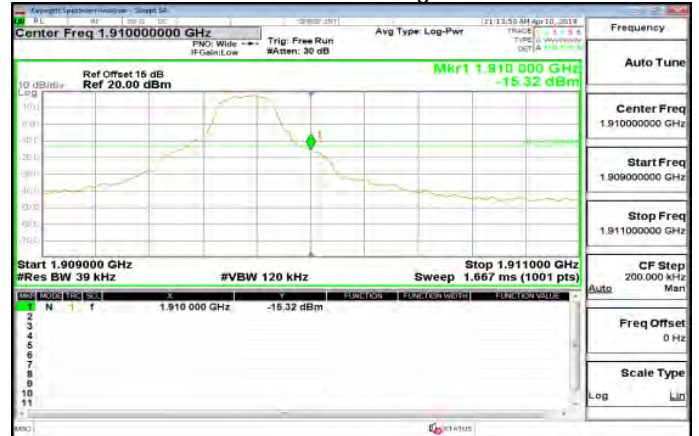

Band2_1_4MHz_QPSK_6_0_HighCH19193-1909.3

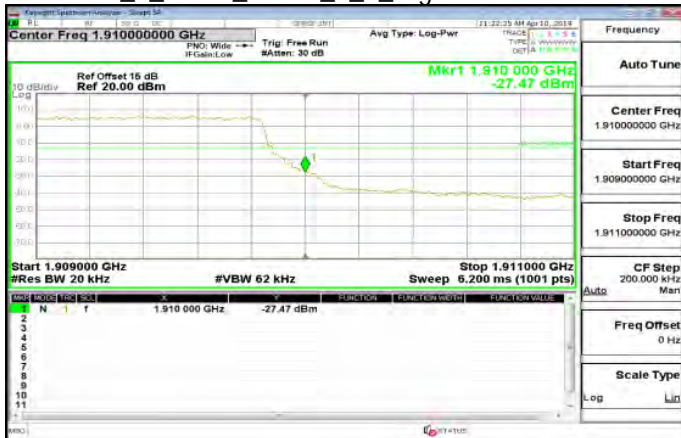

Band2_3MHz_QPSK_15_0_LowCH18615-1851.5

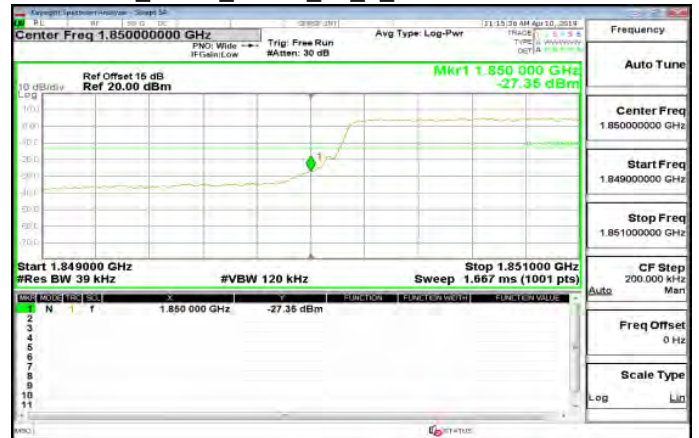

Band2_3MHz_QPSK_1_0_LowCH18615-1851.5



Band2_3MHz_QPSK_15_0_HighCH19185-1908.5



Unless otherwise stated the results shown in this test report refer only to the sample(s) tested and such sample(s) are retained for 90 days only. 除非另有說明，此報告結果僅對測試之樣品負責，同時此樣品僅保留90天。本報告未經本公司書面許可，不可部份複製。

This document is issued by the Company subject to its General Conditions of Service printed overleaf, available on request or accessible at www.sgs.com/terms_and_conditions.htm and for electronic format documents, subject to Terms and Conditions for Electronic Documents at www.sgs.com/terms_e-document.htm. Attention is drawn to the limitation of liability, indemnification and jurisdiction issues defined therein. Any holder of this document is advised that information contained hereon reflects the Company's findings at the time of its intervention only and within the limits of Client's instructions, if any. The Company's sole responsibility is to its Client and this document does not exonerate parties to a transaction from exercising all their rights and obligations under the transaction documents. This document cannot be reproduced except in full, without prior written approval of the Company. Any unauthorized alteration, forgery or falsification of the content or appearance of this document is unlawful and offenders may be prosecuted to the fullest extent of the law.

Band2_5MHz_QPSK_1_0_LowCH18625-1852.5

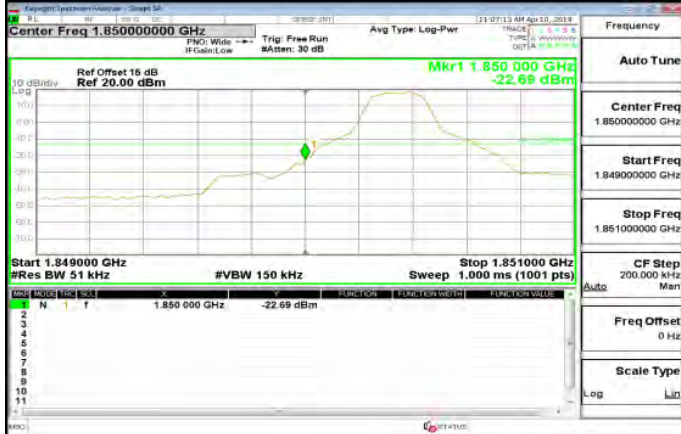

Band2_5MHz_QPSK_25_0_HighCH19175-1907.5

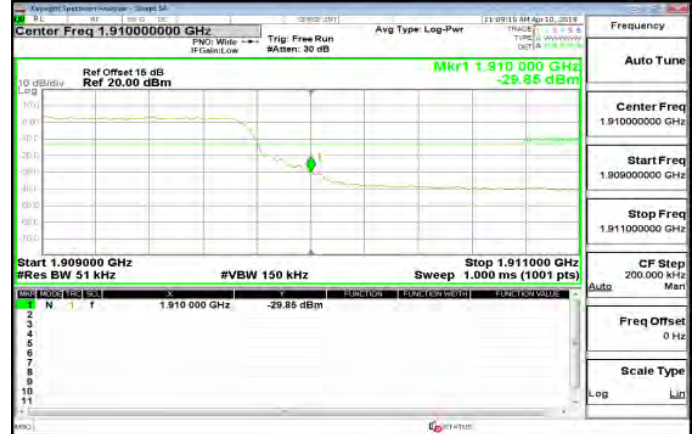

Band2_5MHz_QPSK_1_24_HighCH19175-1907.5

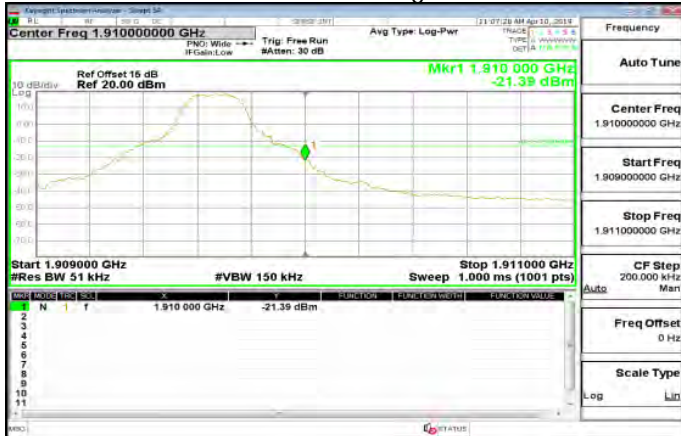

Band2_10MHz_QPSK_1_0_LowCH18650-1855



Band2_5MHz_QPSK_25_0_LowCH18625-1852.5

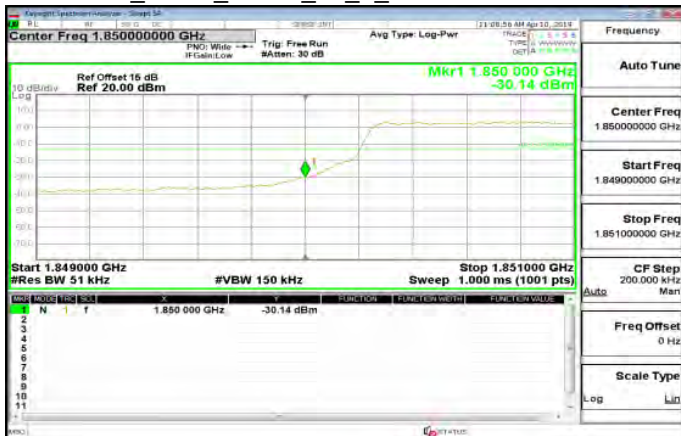

Band2_10MHz_QPSK_1_49_HighCH19150-1905

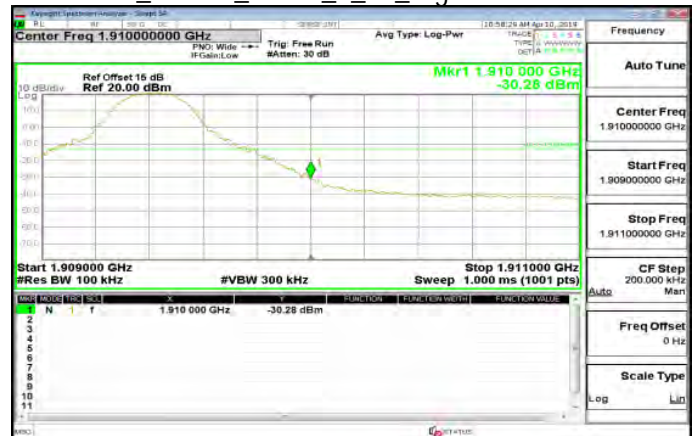

Unless otherwise stated the results shown in this test report refer only to the sample(s) tested and such sample(s) are retained for 90 days only.

除非另有說明，此報告結果僅對測試之樣品負責，同時此樣品僅保留90天。本報告未經本公司書面許可，不可部份複製。

This document is issued by the Company subject to its General Conditions of Service printed overleaf, available on request or accessible at www.sgs.com/terms_and_conditions.htm and for electronic format documents, subject to Terms and Conditions for Electronic Documents at www.sgs.com/terms_e-document.htm. Attention is drawn to the limitation of liability, indemnification and jurisdiction issues defined therein. Any holder of this document is advised that information contained hereon reflects the Company's findings at the time of its intervention only and within the limits of Client's instructions, if any. The Company's sole responsibility is to its Client and this document does not exonerate parties to a transaction from exercising all their rights and obligations under the transaction documents. This document cannot be reproduced except in full, without prior written approval of the Company. Any unauthorized alteration, forgery or falsification of the content or appearance of this document is unlawful and offenders may be prosecuted to the fullest extent of the law.

Band2_10MHz_QPSK_50_0_LowCH18650-1855

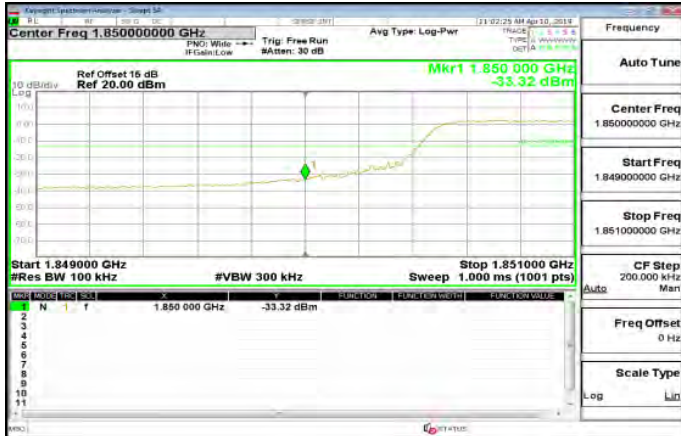

Band2_15MHz_QPSK_1_74_HighCH19125-1902.5

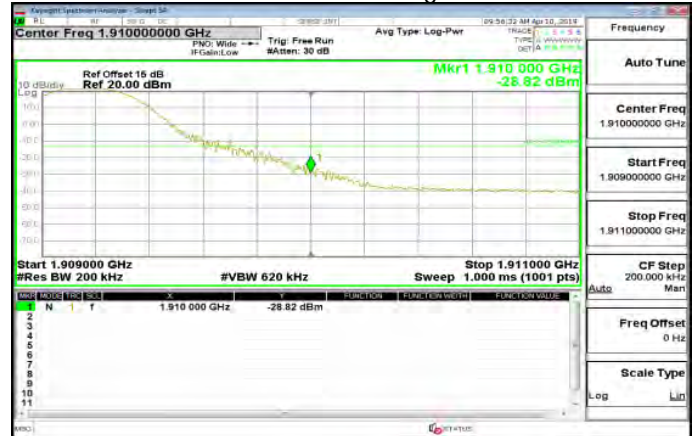

Band2_10MHz_QPSK_50_0_HighCH19150-1905

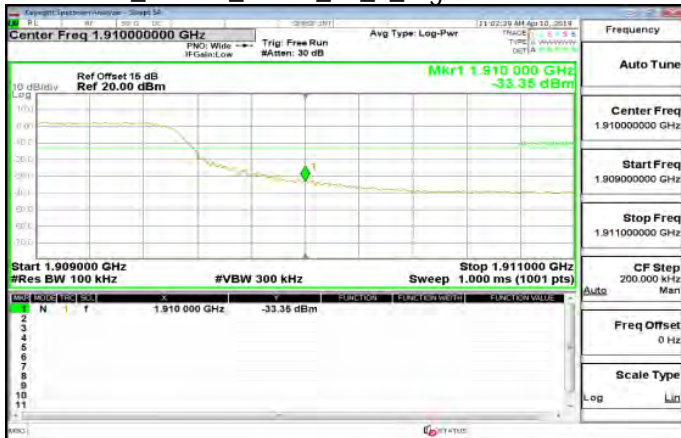

Band2_15MHz_QPSK_75_0_LowCH18675-1857.5

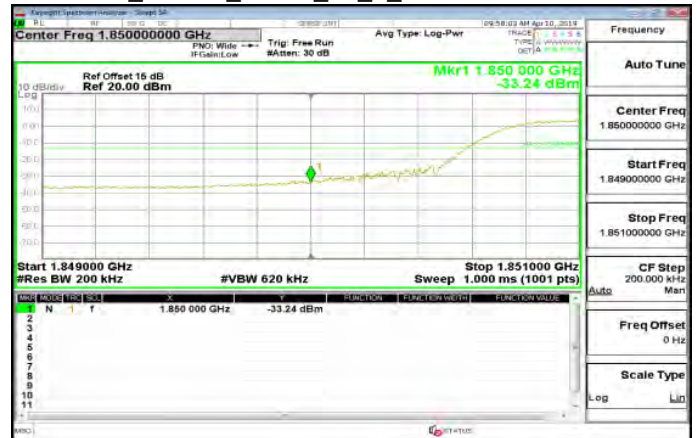

Band2_15MHz_QPSK_1_0_LowCH18675-1857.5

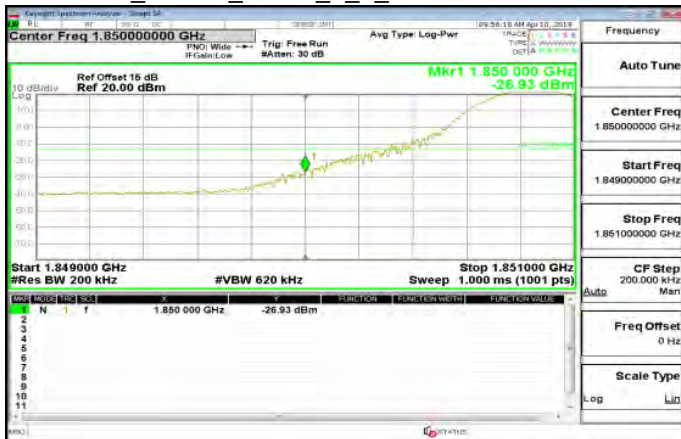

Band2_15MHz_QPSK_75_0_HighCH19125-1902.5



Unless otherwise stated the results shown in this test report refer only to the sample(s) tested and such sample(s) are retained for 90 days only.

除非另有說明，此報告結果僅對測試之樣品負責，同時此樣品僅保留90天。本報告未經本公司書面許可，不可部份複製。

This document is issued by the Company subject to its General Conditions of Service printed overleaf, available on request or accessible at www.sgs.com/terms_and_conditions.htm and for electronic format documents, subject to Terms and Conditions for Electronic Documents at www.sgs.com/terms_e-document.htm. Attention is drawn to the limitation of liability, indemnification and jurisdiction issues defined therein. Any holder of this document is advised that information contained hereon reflects the Company's findings at the time of its intervention only and within the limits of Client's instructions, if any. The Company's sole responsibility is to its Client and this document does not exonerate parties to a transaction from exercising all their rights and obligations under the transaction documents. This document cannot be reproduced except in full, without prior written approval of the Company. Any unauthorized alteration, forgery or falsification of the content or appearance of this document is unlawful and offenders may be prosecuted to the fullest extent of the law.

Band2_20MHz_QPSK_1_0_LowCH18700-1860

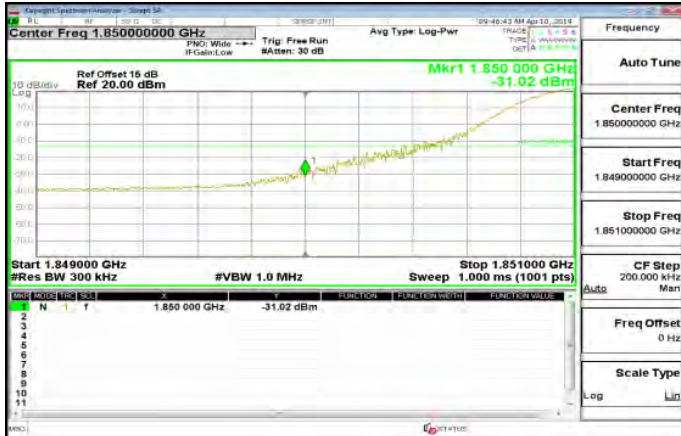

Band2_20MHz_QPSK_100_0_HighCH19100-1900

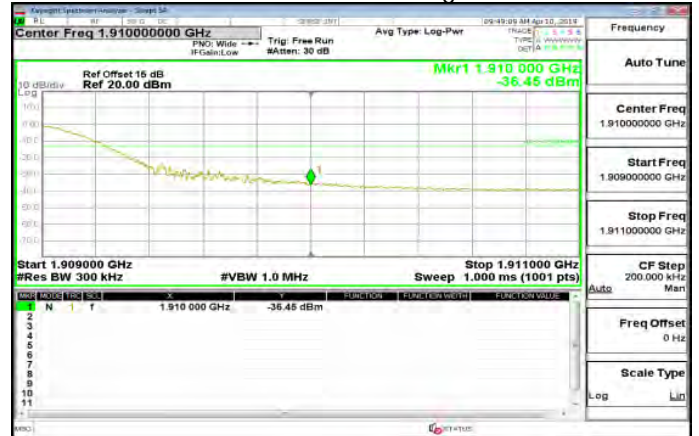

Band2_20MHz_QPSK_1_99_HighCH19100-1900



Band2_20MHz_QPSK_100_0_LowCH18700-1860



Unless otherwise stated the results shown in this test report refer only to the sample(s) tested and such sample(s) are retained for 90 days only.

除非另有說明，此報告結果僅對測試之樣品負責，同時此樣品僅保留90天。本報告未經本公司書面許可，不可部份複製。

This document is issued by the Company subject to its General Conditions of Service printed overleaf, available on request or accessible at www.sgs.com/terms_and_conditions.htm and for electronic format documents, subject to Terms and Conditions for Electronic Documents at www.sgs.com/terms_e-document.htm. Attention is drawn to the limitation of liability, indemnification and jurisdiction issues defined therein. Any holder of this document is advised that information contained hereon reflects the Company's findings at the time of its intervention only and within the limits of Client's instructions, if any. The Company's sole responsibility is to its Client and this document does not exonerate parties to a transaction from exercising all their rights and obligations under the transaction documents. This document cannot be reproduced except in full, without prior written approval of the Company. Any unauthorized alteration, forgery or falsification of the content or appearance of this document is unlawful and offenders may be prosecuted to the fullest extent of the law.

Out of Band Emission

30MHz-3GHz_GSM_1900MHz_LowCH512-1850.2

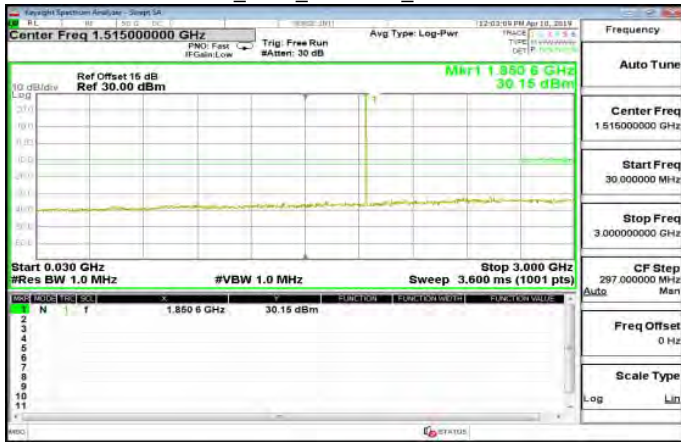

3GHz-10GHz_GSM_1900MHz_MidCH661-1880

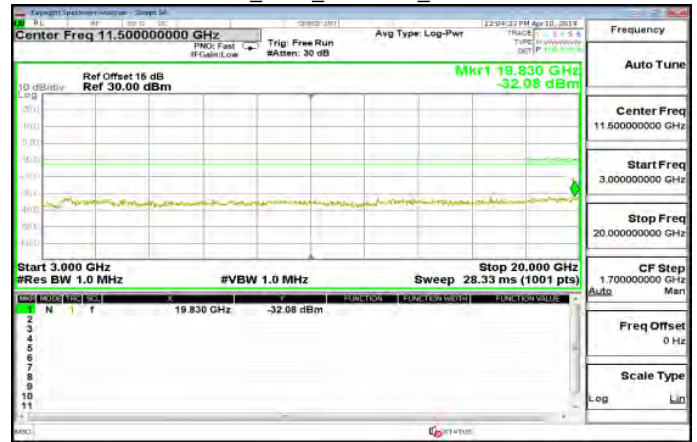

3GHz-10GHz_GSM_1900MHz_LowCH512-1850.2

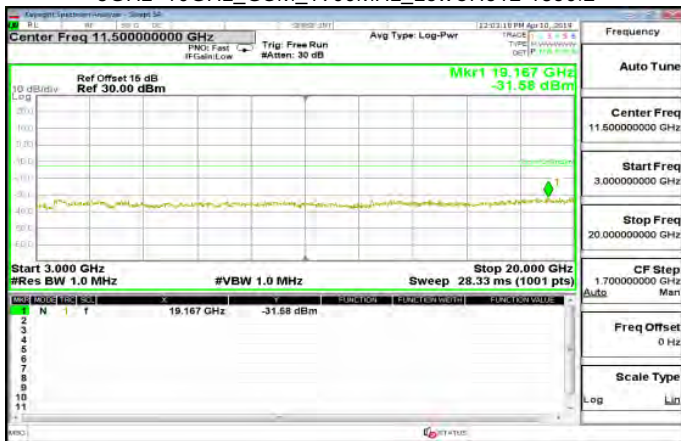

30MHz-3GHz_GSM_1900MHz_HighCH810-1909.8

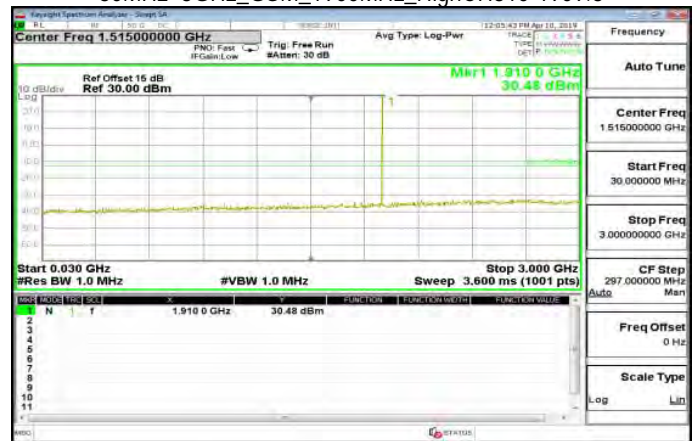

30MHz-3GHz_GSM_1900MHz_MidCH661-1880

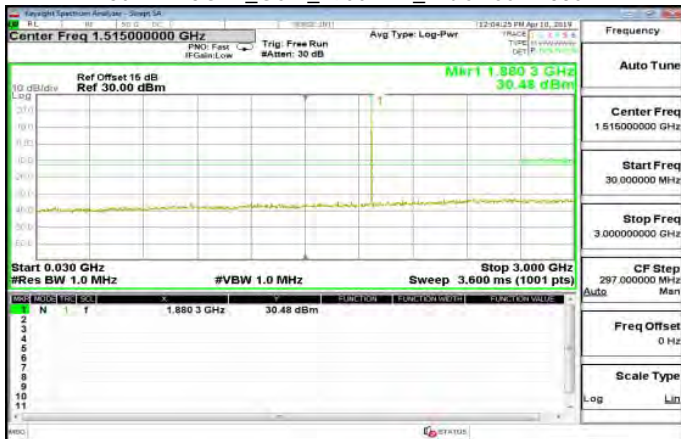

3GHz-10GHz_GSM_1900MHz_HighCH810-1909.8

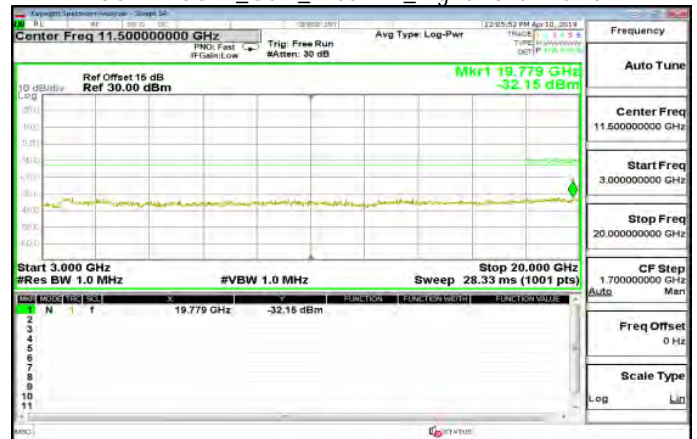

Unless otherwise stated the results shown in this test report refer only to the sample(s) tested and such sample(s) are retained for 90 days only.

除非另有說明，此報告結果僅對測試之樣品負責，同時此樣品僅保留90天。本報告未經本公司書面許可，不可部份複製。

This document is issued by the Company subject to its General Conditions of Service printed overleaf, available on request or accessible at www.sgs.com/terms_and_conditions.htm and for electronic format documents, subject to Terms and Conditions for Electronic Documents at www.sgs.com/terms_e-document.htm. Attention is drawn to the limitation of liability, indemnification and jurisdiction issues defined therein. Any holder of this document is advised that information contained hereon reflects the Company's findings at the time of its intervention only and within the limits of Client's instructions, if any. The Company's sole responsibility is to its Client and this document does not exonerate parties to a transaction from exercising all their rights and obligations under the transaction documents. This document cannot be reproduced except in full, without prior written approval of the Company. Any unauthorized alteration, forgery or falsification of the content or appearance of this document is unlawful and offenders may be prosecuted to the fullest extent of the law.

30MHz~3GHz_GPRS_1900MHz_LowCH512-1850.2



3GHz~10GHz_GPRS_1900MHz_MidCH661-1880

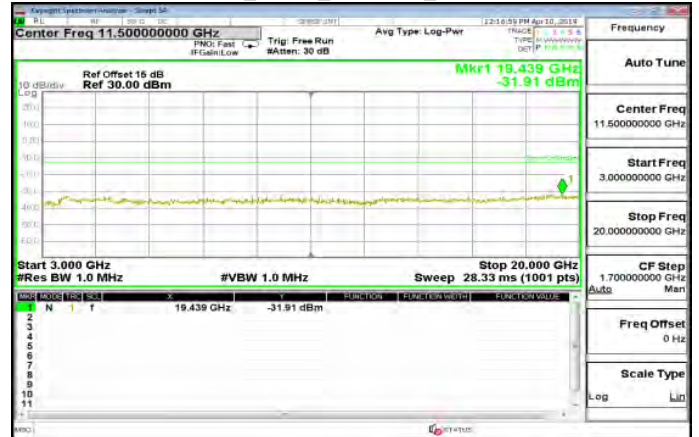

3GHz~10GHz_GPRS_1900MHz_LowCH512-1850.2

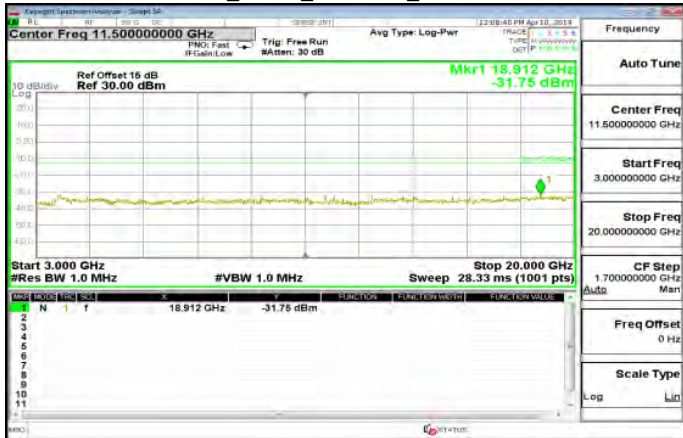

30MHz~3GHz_GPRS_1900MHz_HighCH810-1909.8

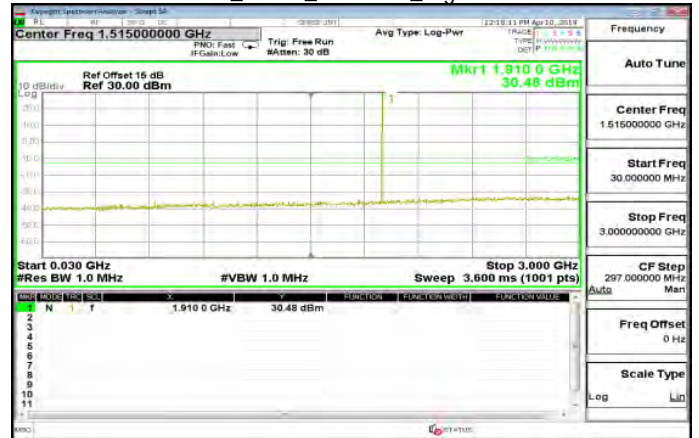

30MHz~3GHz_GPRS_1900MHz_MidCH661-1880

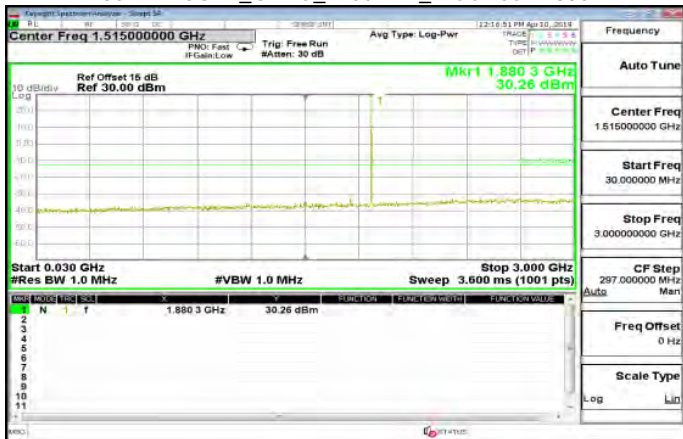

3GHz~10GHz_GPRS_1900MHz_HighCH810-1909.8

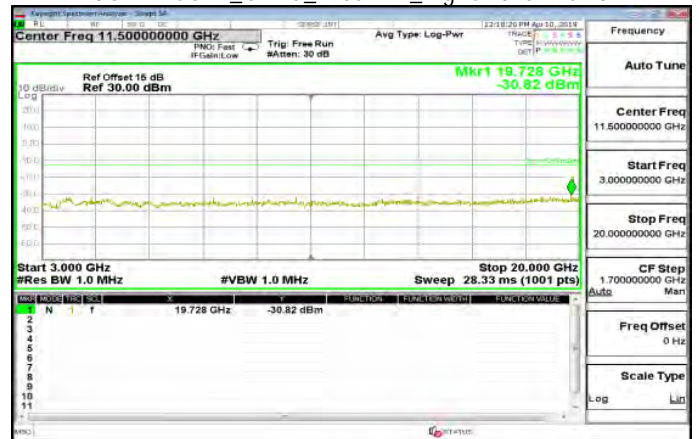

Unless otherwise stated the results shown in this test report refer only to the sample(s) tested and such sample(s) are retained for 90 days only.

除非另有說明，此報告結果僅對測試之樣品負責，同時此樣品僅保留90天。本報告未經本公司書面許可，不可部份複製。

This document is issued by the Company subject to its General Conditions of Service printed overleaf, available on request or accessible at www.sgs.com/terms_and_conditions.htm and for electronic format documents, subject to Terms and Conditions for Electronic Documents at www.sgs.com/terms_e-document.htm. Attention is drawn to the limitation of liability, indemnification and jurisdiction issues defined therein. Any holder of this document is advised that information contained hereon reflects the Company's findings at the time of its intervention only and within the limits of Client's instructions, if any. The Company's sole responsibility is to its Client and this document does not exonerate parties to a transaction from exercising all their rights and obligations under the transaction documents. This document cannot be reproduced except in full, without prior written approval of the Company. Any unauthorized alteration, forgery or falsification of the content or appearance of this document is unlawful and offenders may be prosecuted to the fullest extent of the law.

30MHz~3GHz_WCDMA_B2_LowCH9262-1852.4



3GHz~10GHz_WCDMA_B2_MidCH9400-1880



3GHz~10GHz_WCDMA_B2_LowCH9262-1852.4

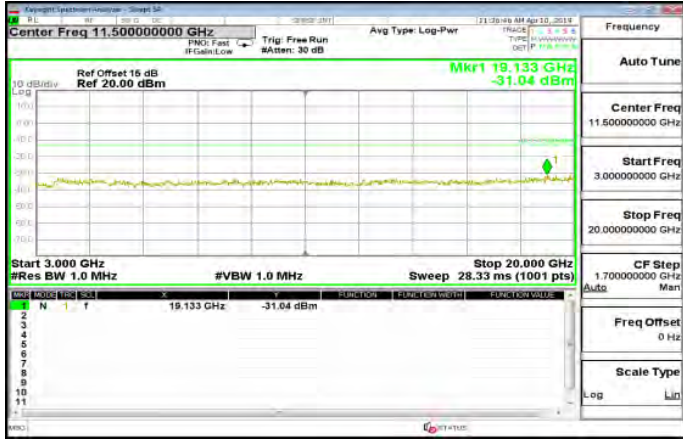

30MHz~3GHz_WCDMA_B2_HighCH9538-1907.6



30MHz~3GHz_WCDMA_B2_MidCH9400-1880



3GHz~10GHz_WCDMA_B2_HighCH9538-1907.6



Unless otherwise stated the results shown in this test report refer only to the sample(s) tested and such sample(s) are retained for 90 days only.

除非另有說明，此報告結果僅對測試之樣品負責，同時此樣品僅保留90天。本報告未經本公司書面許可，不可部份複製。

This document is issued by the Company subject to its General Conditions of Service printed overleaf, available on request or accessible at www.sgs.com/terms_and_conditions.htm and for electronic format documents, subject to Terms and Conditions for Electronic Documents at www.sgs.com/terms_e-document.htm. Attention is drawn to the limitation of liability, indemnification and jurisdiction issues defined therein. Any holder of this document is advised that information contained hereon reflects the Company's findings at the time of its intervention only and within the limits of Client's instructions, if any. The Company's sole responsibility is to its Client and this document does not exonerate parties to a transaction from exercising all their rights and obligations under the transaction documents. This document cannot be reproduced except in full, without prior written approval of the Company. Any unauthorized alteration, forgery or falsification of the content or appearance of this document is unlawful and offenders may be prosecuted to the fullest extent of the law.

30MHz-3GHz_HSDPA_B2_LowCH9262-1852.4



3GHz-10GHz_HSDPA_B2_MidCH9400-1880



3GHz-10GHz_HSDPA_B2_LowCH9262-1852.4

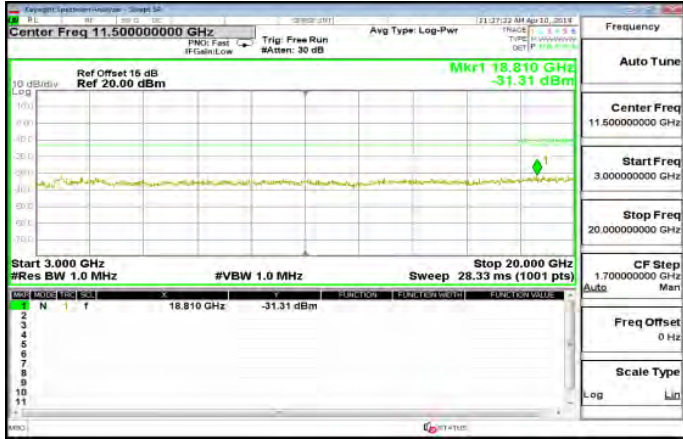

30MHz-3GHz_HSDPA_B2_HighCH9538-1907.6



30MHz-3GHz_HSDPA_B2_MidCH9400-1880



3GHz-10GHz_HSDPA_B2_HighCH9538-1907.6



Unless otherwise stated the results shown in this test report refer only to the sample(s) tested and such sample(s) are retained for 90 days only.

除非另有說明，此報告結果僅對測試之樣品負責，同時此樣品僅保留90天。本報告未經本公司書面許可，不可部份複製。

This document is issued by the Company subject to its General Conditions of Service printed overleaf, available on request or accessible at www.sgs.com/terms_and_conditions.htm and for electronic format documents, subject to Terms and Conditions for Electronic Documents at www.sgs.com/terms_e-document.htm. Attention is drawn to the limitation of liability, indemnification and jurisdiction issues defined therein. Any holder of this document is advised that information contained hereon reflects the Company's findings at the time of its intervention only and within the limits of Client's instructions, if any. The Company's sole responsibility is to its Client and this document does not exonerate parties to a transaction from exercising all their rights and obligations under the transaction documents. This document cannot be reproduced except in full, without prior written approval of the Company. Any unauthorized alteration, forgery or falsification of the content or appearance of this document is unlawful and offenders may be prosecuted to the fullest extent of the law.

30MHz-3GHz_HSUPA_B2_LowCH9262-1852.4



3GHz-10GHz_HSUPA_B2_MidCH9400-1880



3GHz-10GHz_HSUPA_B2_LowCH9262-1852.4

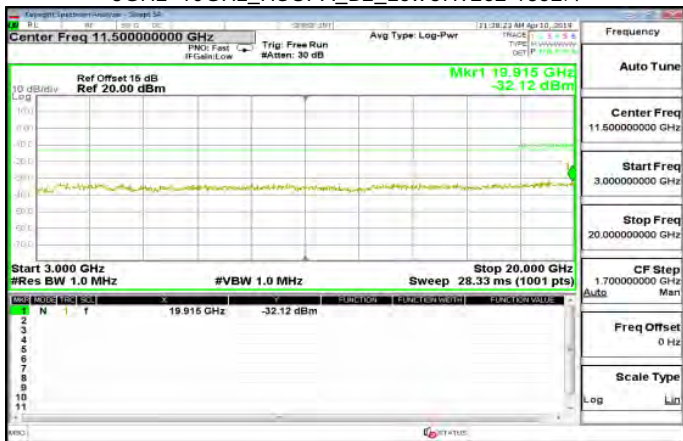

30MHz-3GHz_HSUPA_B2_HighCH9538-1907.6



30MHz-3GHz_HSUPA_B2_MidCH9400-1880



3GHz-10GHz_HSUPA_B2_HighCH9538-1907.6



Unless otherwise stated the results shown in this test report refer only to the sample(s) tested and such sample(s) are retained for 90 days only.

除非另有說明，此報告結果僅對測試之樣品負責，同時此樣品僅保留90天。本報告未經本公司書面許可，不可部份複製。

This document is issued by the Company subject to its General Conditions of Service printed overleaf, available on request or accessible at www.sgs.com/terms_and_conditions.htm and for electronic format documents, subject to Terms and Conditions for Electronic Documents at www.sgs.com/terms_e-document.htm. Attention is drawn to the limitation of liability, indemnification and jurisdiction issues defined therein. Any holder of this document is advised that information contained hereon reflects the Company's findings at the time of its intervention only and within the limits of Client's instructions, if any. The Company's sole responsibility is to its Client and this document does not exonerate parties to a transaction from exercising all their rights and obligations under the transaction documents. This document cannot be reproduced except in full, without prior written approval of the Company. Any unauthorized alteration, forgery or falsification of the content or appearance of this document is unlawful and offenders may be prosecuted to the fullest extent of the law.

30MHz-3GHz_Band2_1_4MHz_QPSK_1_0_LowCH18607-1850.7

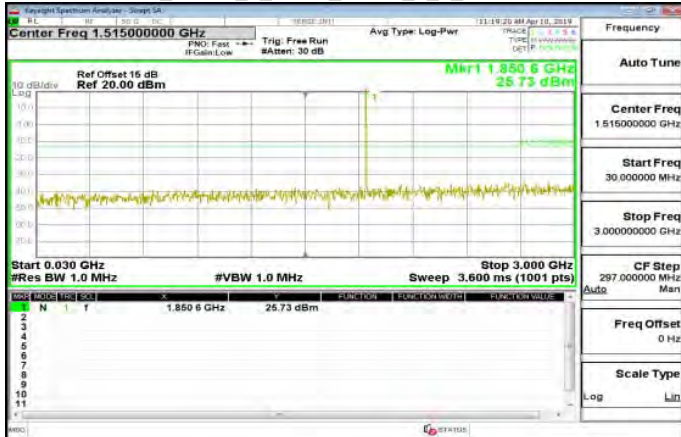

3GHz-10GHz_Band2_1_4MHz_QPSK_1_0_MidCH18900-1880



3GHz-10GHz_Band2_1_4MHz_QPSK_1_0_LowCH18607-1850.7



30MHz-3GHz_Band2_1_4MHz_QPSK_1_0_HighCH19193-1909.3



30MHz-3GHz_Band2_1_4MHz_QPSK_1_0_MidCH18900-1880



3GHz-10GHz_Band2_1_4MHz_QPSK_1_0_HighCH19193-1909.3

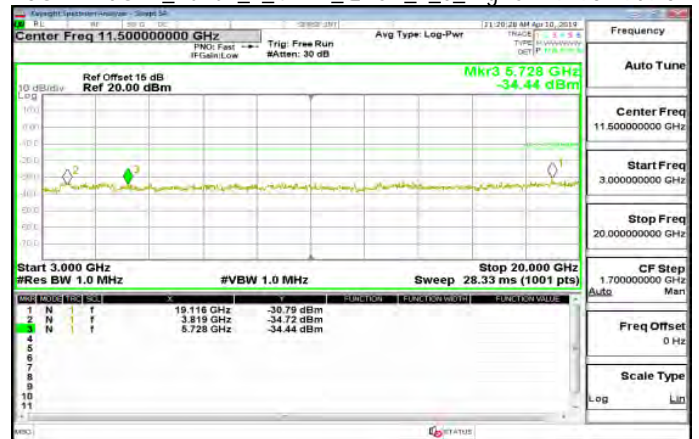

Unless otherwise stated the results shown in this test report refer only to the sample(s) tested and such sample(s) are retained for 90 days only.

除非另有說明，此報告結果僅對測試之樣品負責，同時此樣品僅保留90天。本報告未經本公司書面許可，不可部份複製。

This document is issued by the Company subject to its General Conditions of Service printed overleaf, available on request or accessible at www.sgs.com/terms_and_conditions.htm and for electronic format documents, subject to Terms and Conditions for Electronic Documents at www.sgs.com/terms_e-document.htm. Attention is drawn to the limitation of liability, indemnification and jurisdiction issues defined therein. Any holder of this document is advised that information contained hereon reflects the Company's findings at the time of its intervention only and within the limits of Client's instructions, if any. The Company's sole responsibility is to its Client and this document does not exonerate parties to a transaction from exercising all their rights and obligations under the transaction documents. This document cannot be reproduced except in full, without prior written approval of the Company. Any unauthorized alteration, forgery or falsification of the content or appearance of this document is unlawful and offenders may be prosecuted to the fullest extent of the law.

30MHz-3GHz_Band2_3MHz_QPSK_1_0_LowCH18615-1851.5



3GHz-10GHz_Band2_3MHz_QPSK_1_0_MidCH18900-1880



3GHz-10GHz_Band2_3MHz_QPSK_1_0_LowCH18615-1851.5



30MHz-3GHz_Band2_3MHz_QPSK_1_0_HighCH19185-1908.5



30MHz-3GHz_Band2_3MHz_QPSK_1_0_MidCH18900-1880



3GHz-10GHz_Band2_3MHz_QPSK_1_0_HighCH19185-1908.5



Unless otherwise stated the results shown in this test report refer only to the sample(s) tested and such sample(s) are retained for 90 days only.

除非另有說明，此報告結果僅對測試之樣品負責，同時此樣品僅保留90天。本報告未經本公司書面許可，不可部份複製。

This document is issued by the Company subject to its General Conditions of Service printed overleaf, available on request or accessible at www.sgs.com/terms_and_conditions.htm and for electronic format documents, subject to Terms and Conditions for Electronic Documents at www.sgs.com/terms_e-document.htm. Attention is drawn to the limitation of liability, indemnification and jurisdiction issues defined therein. Any holder of this document is advised that information contained hereon reflects the Company's findings at the time of its intervention only and within the limits of Client's instructions, if any. The Company's sole responsibility is to its Client and this document does not exonerate parties to a transaction from exercising all their rights and obligations under the transaction documents. This document cannot be reproduced except in full, without prior written approval of the Company. Any unauthorized alteration, forgery or falsification of the content or appearance of this document is unlawful and offenders may be prosecuted to the fullest extent of the law.

30MHz-3GHz_Band2_5MHz_QPSK_1_0_LowCH18625-1852.5



3GHz-10GHz_Band2_5MHz_QPSK_1_0_MidCH18900-1880



3GHz-10GHz_Band2_5MHz_QPSK_1_0_LowCH18625-1852.5

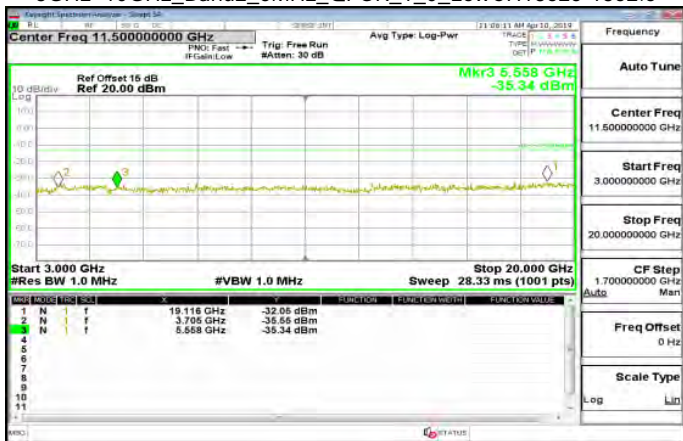

30MHz-3GHz_Band2_5MHz_QPSK_1_0_HighCH19175-1907.5



30MHz-3GHz_Band2_5MHz_QPSK_1_0_MidCH18900-1880



3GHz-10GHz_Band2_5MHz_QPSK_1_0_HighCH19175-1907.5

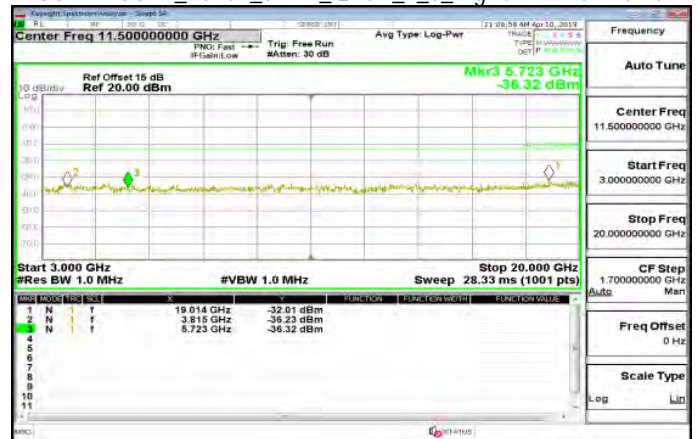

Unless otherwise stated the results shown in this test report refer only to the sample(s) tested and such sample(s) are retained for 90 days only.

除非另有說明，此報告結果僅對測試之樣品負責，同時此樣品僅保留90天。本報告未經本公司書面許可，不可部份複製。

This document is issued by the Company subject to its General Conditions of Service printed overleaf, available on request or accessible at www.sgs.com/terms_and_conditions.htm and for electronic format documents, subject to Terms and Conditions for Electronic Documents at www.sgs.com/terms_e-document.htm. Attention is drawn to the limitation of liability, indemnification and jurisdiction issues defined therein. Any holder of this document is advised that information contained hereon reflects the Company's findings at the time of its intervention only and within the limits of Client's instructions, if any. The Company's sole responsibility is to its Client and this document does not exonerate parties to a transaction from exercising all their rights and obligations under the transaction documents. This document cannot be reproduced except in full, without prior written approval of the Company. Any unauthorized alteration, forgery or falsification of the content or appearance of this document is unlawful and offenders may be prosecuted to the fullest extent of the law.

30MHz-3GHz_Band2_10MHz_QPSK_1_0_LowCH18650-1855



3GHz-10GHz_Band2_10MHz_QPSK_1_0_MidCH18900-1880



3GHz-10GHz_Band2_10MHz_QPSK_1_0_LowCH18650-1855

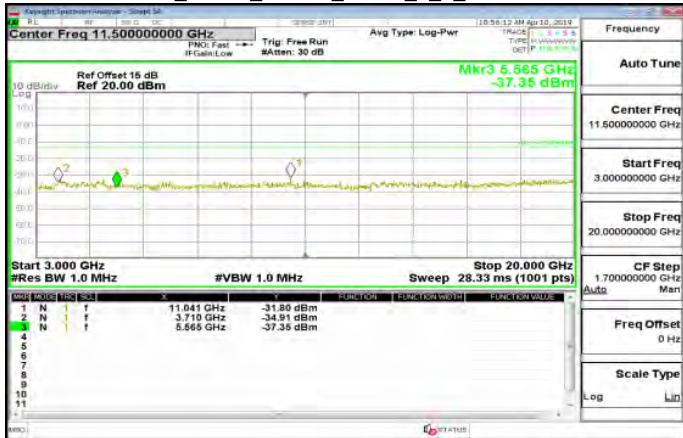

30MHz-3GHz_Band2_10MHz_QPSK_1_0_HighCH19150-1905



30MHz-3GHz_Band2_10MHz_QPSK_1_0_MidCH18900-1880



3GHz-10GHz_Band2_10MHz_QPSK_1_0_HighCH19150-1905

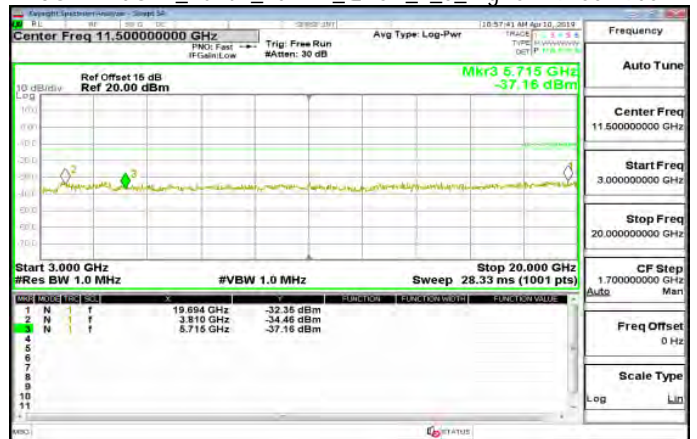

Unless otherwise stated the results shown in this test report refer only to the sample(s) tested and such sample(s) are retained for 90 days only. 除非另有說明，此報告結果僅對測試之樣品負責，同時此樣品僅保留90天。本報告未經本公司書面許可，不可部份複製。

This document is issued by the Company subject to its General Conditions of Service printed overleaf, available on request or accessible at www.sgs.com/terms_and_conditions.htm and for electronic format documents, subject to Terms and Conditions for Electronic Documents at www.sgs.com/terms_e-document.htm. Attention is drawn to the limitation of liability, indemnification and jurisdiction issues defined therein. Any holder of this document is advised that information contained hereon reflects the Company's findings at the time of its intervention only and within the limits of Client's instructions, if any. The Company's sole responsibility is to its Client and this document does not exonerate parties to a transaction from exercising all their rights and obligations under the transaction documents. This document cannot be reproduced except in full, without prior written approval of the Company. Any unauthorized alteration, forgery or falsification of the content or appearance of this document is unlawful and offenders may be prosecuted to the fullest extent of the law.

30MHz-3GHz_Band2_15MHz_QPSK_1_0_LowCH18675-1857.5



3GHz-10GHz_Band2_15MHz_QPSK_1_0_MidCH18900-1880



3GHz-10GHz_Band2_15MHz_QPSK_1_0_LowCH18675-1857.5



30MHz-3GHz_Band2_15MHz_QPSK_1_0_HighCH19125-1902.5

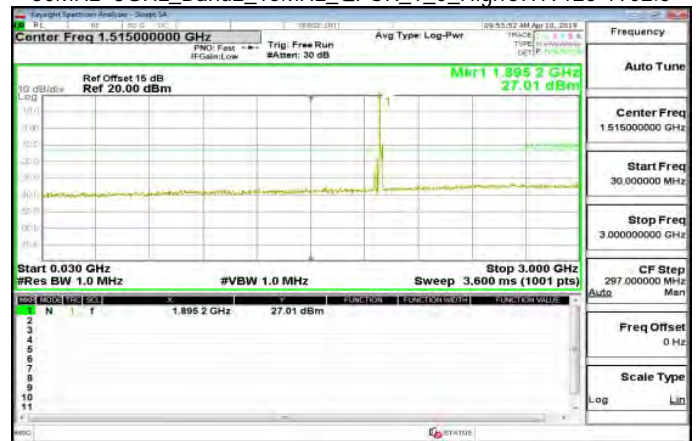

30MHz-3GHz_Band2_15MHz_QPSK_1_0_MidCH18900-1880



3GHz-10GHz_Band2_15MHz_QPSK_1_0_HighCH19125-1902.5



Unless otherwise stated the results shown in this test report refer only to the sample(s) tested and such sample(s) are retained for 90 days only. 除非另有說明，此報告結果僅對測試之樣品負責，同時此樣品僅保留90天。本報告未經本公司書面許可，不可部份複製。

This document is issued by the Company subject to its General Conditions of Service printed overleaf, available on request or accessible at www.sgs.com/terms_and_conditions.htm and for electronic format documents, subject to Terms and Conditions for Electronic Documents at www.sgs.com/terms_e-document.htm. Attention is drawn to the limitation of liability, indemnification and jurisdiction issues defined therein. Any holder of this document is advised that information contained hereon reflects the Company's findings at the time of its intervention only and within the limits of Client's instructions, if any. The Company's sole responsibility is to its Client and this document does not exonerate parties to a transaction from exercising all their rights and obligations under the transaction documents. This document cannot be reproduced except in full, without prior written approval of the Company. Any unauthorized alteration, forgery or falsification of the content or appearance of this document is unlawful and offenders may be prosecuted to the fullest extent of the law.

30MHz-3GHz_Band2_20MHz_QPSK_1_0_LowCH18700-1860



3GHz-10GHz_Band2_20MHz_QPSK_1_0_MidCH18900-1880

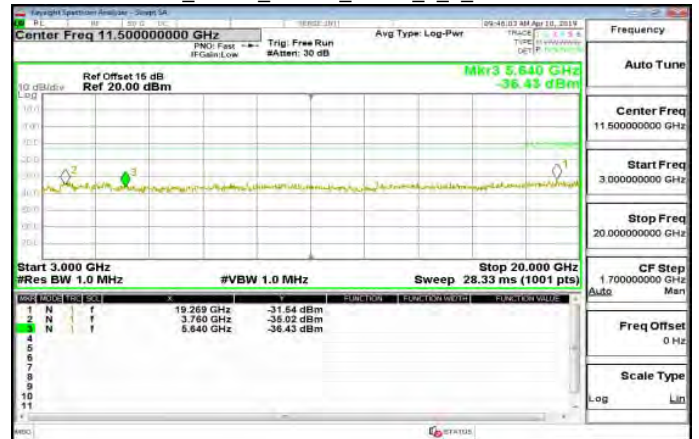

3GHz-10GHz_Band2_20MHz_QPSK_1_0_LowCH18700-1860

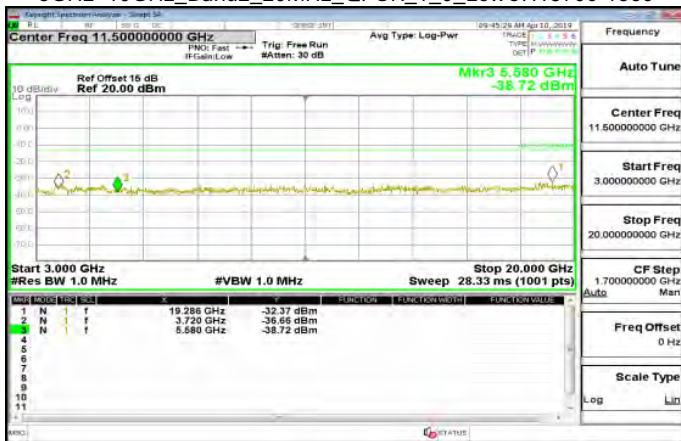

30MHz-3GHz_Band2_20MHz_QPSK_1_0_HighCH19100-1900



30MHz-3GHz_Band2_20MHz_QPSK_1_0_MidCH18900-1880



3GHz-10GHz_Band2_20MHz_QPSK_1_0_HighCH19100-1900

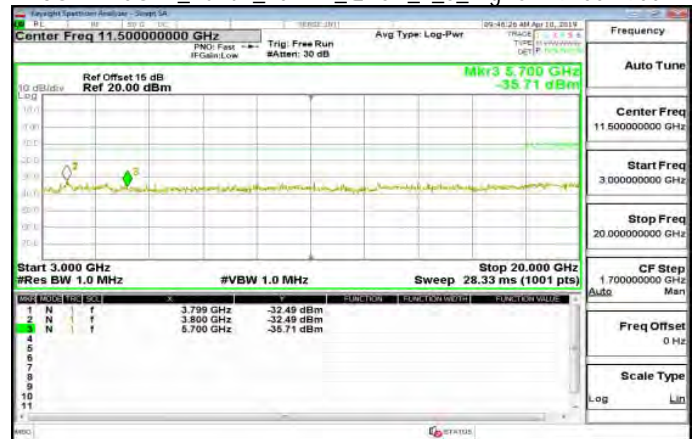

Unless otherwise stated the results shown in this test report refer only to the sample(s) tested and such sample(s) are retained for 90 days only.

除非另有說明，此報告結果僅對測試之樣品負責，同時此樣品僅保留90天。本報告未經本公司書面許可，不可部份複製。

This document is issued by the Company subject to its General Conditions of Service printed overleaf, available on request or accessible at www.sgs.com/terms_and_conditions.htm and for electronic format documents, subject to Terms and Conditions for Electronic Documents at www.sgs.com/terms_e-document.htm. Attention is drawn to the limitation of liability, indemnification and jurisdiction issues defined therein. Any holder of this document is advised that information contained hereon reflects the Company's findings at the time of its intervention only and within the limits of Client's instructions, if any. The Company's sole responsibility is to its Client and this document does not exonerate parties to a transaction from exercising all their rights and obligations under the transaction documents. This document cannot be reproduced except in full, without prior written approval of the Company. Any unauthorized alteration, forgery or falsification of the content or appearance of this document is unlawful and offenders may be prosecuted to the fullest extent of the law.

9. FIELD STRENGTH OF SPURIOUS RADIATION MEASUREMENT

9.1. Standard Applicable

According to FCC §2.1053,

FCC §24.238(a), the magnitude of each spurious and harmonic emission that can be detected when the equipment is operated under the conditions specified in the instruction manual and/or alignment procedure, shall not be less than $43 + 10 \log$ (mean output power in watts) dBc below the mean power output outside a license's frequency block (-13dBm).

Table 2 — Unwanted Emissions for Mobile, Portable and Low-Power Fixed Subscriber Equipment

Frequency (MHz)	Attenuation (dB)
<2200	$43 + 10 \log_{10}(p)$
2200 - 2288	$70 + 10 \log_{10}(p)$
2288 - 2292	$67 + 10 \log_{10}(p)$
2292 - 2296	$61 + 10 \log_{10}(p)$
2296 - 2300	$55 + 10 \log_{10}(p)$
2300 - 2305	$43 + 10 \log_{10}(p)$
2305 - 2320	$43 + 10 \log_{10}(p)$ ^{Note}
2320 - 2324	$55 + 10 \log_{10}(p)$
2324 - 2328	$61 + 10 \log_{10}(p)$
2328 - 2337	$67 + 10 \log_{10}(p)$
2337 - 2341	$61 + 10 \log_{10}(p)$
2341 - 2345	$55 + 10 \log_{10}(p)$
2345 - 2360	$43 + 10 \log_{10}(p)$ ^{Note}
2360 - 2365	$43 + 10 \log_{10}(p)$
2365 - 2395	$70 + 10 \log_{10}(p)$
>2395	$43 + 10 \log_{10}(p)$

Note: Measured at the edges of the highest and lowest frequency range(s) in which the equipment is designed to operate. See Section 1.2 for the permitted frequency ranges for various equipment types.

Unless otherwise stated the results shown in this test report refer only to the sample(s) tested and such sample(s) are retained for 90 days only.

除非另有說明，此報告結果僅對測試之樣品負責，同時此樣品僅保留90天。本報告未經本公司書面許可，不可部份複製。

This document is issued by the Company subject to its General Conditions of Service printed overleaf, available on request or accessible at www.sgs.com/terms_and_conditions.htm and for electronic format documents, subject to Terms and Conditions for Electronic Documents at www.sgs.com/terms_e-document.htm. Attention is drawn to the limitation of liability, indemnification and jurisdiction issues defined therein. Any holder of this document is advised that information contained hereon reflects the Company's findings at the time of its intervention only and within the limits of Client's instructions, if any. The Company's sole responsibility is to its Client and this document does not exonerate parties to a transaction from exercising all their rights and obligations under the transaction documents. This document cannot be reproduced except in full, without prior written approval of the Company. Any unauthorized alteration, forgery or falsification of the content or appearance of this document is unlawful and offenders may be prosecuted to the fullest extent of the law.

9.2. EUT Setup

Radiated Emission Test Set-Up, Frequency Below 1000MHz

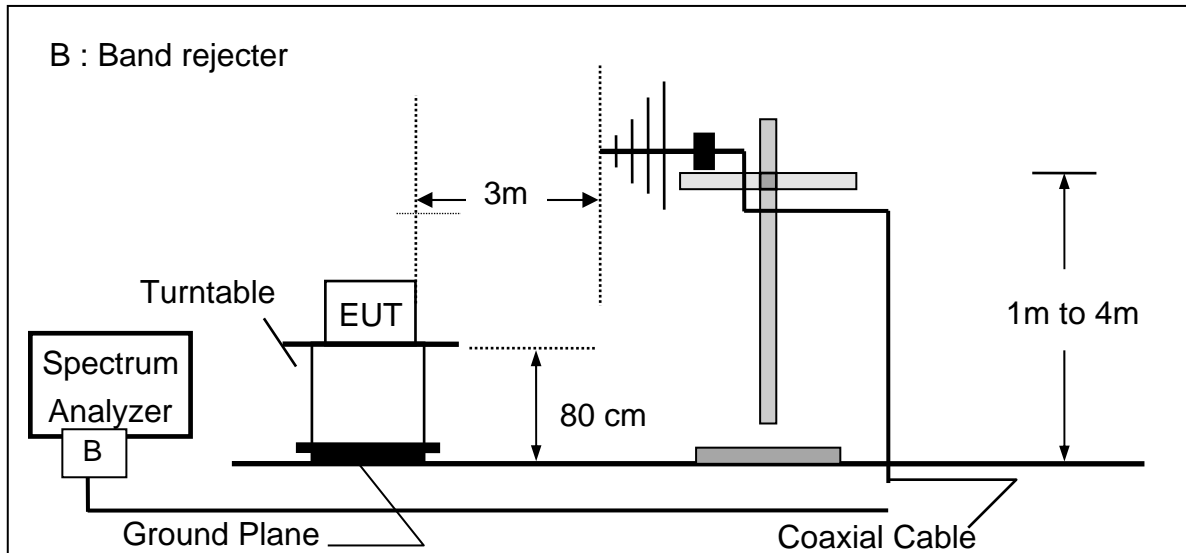

Radiated Emission Test Set-UP Frequency Over 1 GHz

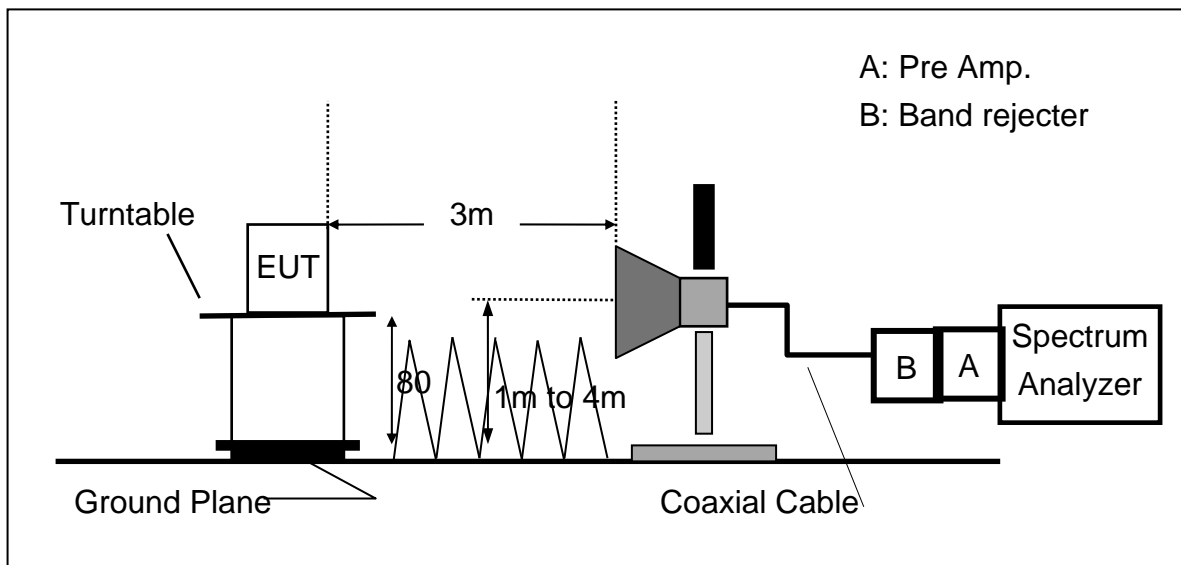

Unless otherwise stated the results shown in this test report refer only to the sample(s) tested and such sample(s) are retained for 90 days only.

除非另有說明，此報告結果僅對測試之樣品負責，同時此樣品僅保留90天。本報告未經本公司書面許可，不可部份複製。

This document is issued by the Company subject to its General Conditions of Service printed overleaf, available on request or accessible at www.sgs.com/terms_and_conditions.htm and for electronic format documents, subject to Terms and Conditions for Electronic Documents at www.sgs.com/terms_e-document.htm. Attention is drawn to the limitation of liability, indemnification and jurisdiction issues defined therein. Any holder of this document is advised that information contained hereon reflects the Company's findings at the time of its intervention only and within the limits of Client's instructions, if any. The Company's sole responsibility is to its Client and this document does not exonerate parties to a transaction from exercising all their rights and obligations under the transaction documents. This document cannot be reproduced except in full, without prior written approval of the Company. Any unauthorized alteration, forgery or falsification of the content or appearance of this document is unlawful and offenders may be prosecuted to the fullest extent of the law.

9.3. Measurement Procedure:

The EUT was placed on a non-conductive; the measurement antenna was placed at a distance of 3 meters from the EUT. During the tests, the antenna height and the EUT azimuth were varied in order to identify the maximum level of emissions from the EUT. This maximization process was repeated with the EUT positioned in each of its three orthogonal orientations.

The frequency range up to tenth harmonic was investigated for each of three fundamental frequencies (low, middle and high channels). Once spurious emission was identified, the power of the emission was determined using the substitution method.

The spurious emissions attenuation was calculated as the difference between radiated power at the fundamental frequency and the spurious emissions frequency.

ERP (dBm) = SG Level(dBm) + Antenna Gain(dBd) + Cable Loss(dB)

EIRP (dBm) = SG Level(dBm) + Antenna Gain(dBi) + Cable Loss(dB)

Unless otherwise stated the results shown in this test report refer only to the sample(s) tested and such sample(s) are retained for 90 days only.

除非另有說明，此報告結果僅對測試之樣品負責，同時此樣品僅保留90天。本報告未經本公司書面許可，不可部份複製。

This document is issued by the Company subject to its General Conditions of Service printed overleaf, available on request or accessible at www.sgs.com/terms_and_conditions.htm and for electronic format documents, subject to Terms and Conditions for Electronic Documents at www.sgs.com/terms_e-document.htm. Attention is drawn to the limitation of liability, indemnification and jurisdiction issues defined therein. Any holder of this document is advised that information contained hereon reflects the Company's findings at the time of its intervention only and within the limits of Client's instructions, if any. The Company's sole responsibility is to its Client and this document does not exonerate parties to a transaction from exercising all their rights and obligations under the transaction documents. This document cannot be reproduced except in full, without prior written approval of the Company. Any unauthorized alteration, forgery or falsification of the content or appearance of this document is unlawful and offenders may be prosecuted to the fullest extent of the law.

9.4. Measurement Equipment Used:

EQUIPMENT TYPE	MFR	MODEL NUMBER	SERIAL NUMBER	LAST CAL.	CAL DUE.
DC Power Supply	GWINSTEK	SPS-3610	GPE880163	Jan. 14th, 2019	Jan. 13th, 2020
PSA Series Spectrum Analyzer	Agilent	E4446A	MY46180323	May 31th, 2018	May 30th, 2019
Digital Thermo-Hygro Meter	WISEWIND	1206	D07	Jan. 30th, 2019	Jan. 29th, 2020
Pre-Amplifier	MITEQ	AMF-6F-260400-40-8P	985646	Feb. 26th, 2019	Feb. 25th, 2020
Pre-Amplifier	EMEC	EM330	60609	Feb. 26th, 2019	Feb. 25th, 2020
Pre-Amplifier	HP	8449B	3008A00965	Feb. 26th, 2019	Feb. 25th, 2020
Horn Antenna	Schwarzbeck	BBHA9170	184	Dec. 27th, 2018	Dec. 26th, 2019
Horn Antenna	ETS LINDGREN	3116	26370	Dec. 26th, 2018	Dec. 25th, 2019
Horn Antenna	SCHWARZBECK	BBHA 9120D	779	Mar. 09th, 2019	Mar. 08th, 2020
Bilog Antenna	Sunol Sciences	JB3	A030105	Jul. 13th, 2018	Jul. 12th, 2019
Bilog Antenna	Sunol Sciences	JB1	A052609	Mar. 06th, 2019	Mar. 05th, 2020
double Ridged Guide Horn Antenna	ETC	MCTD 1209	DRH13M02003	Aug. 20th, 2018	Aug. 19th, 2019
Loop Antenna	COM-POWER	AL-130	121051	Mar. 22th, 2019	Mar. 21th, 2020
Loop Antenna	ETS.LINDGREN	6502	148045	Oct. 08th, 2018	Oct. 07th, 2019
High Pass Filter	SOLVANG TECHNOLOGY INC.	ST115	9923	Feb. 26th, 2019	Feb. 25th, 2020
High Pass Filters	MICRO TRONICS	HPM13195	3	Feb. 26th, 2019	Feb. 25th, 2020

Unless otherwise stated the results shown in this test report refer only to the sample(s) tested and such sample(s) are retained for 90 days only.

除非另有說明，此報告結果僅對測試之樣品負責，同時此樣品僅保留90天。本報告未經本公司書面許可，不可部份複製。

This document is issued by the Company subject to its General Conditions of Service printed overleaf, available on request or accessible at www.sgs.com/terms_and_conditions.htm and for electronic format documents, subject to Terms and Conditions for Electronic Documents at www.sgs.com/terms_e-document.htm. Attention is drawn to the limitation of liability, indemnification and jurisdiction issues defined therein. Any holder of this document is advised that information contained hereon reflects the Company's findings at the time of its intervention only and within the limits of Client's instructions, if any. The Company's sole responsibility is to its Client and this document does not exonerate parties to a transaction from exercising all their rights and obligations under the transaction documents. This document cannot be reproduced except in full, without prior written approval of the Company. Any unauthorized alteration, forgery or falsification of the content or appearance of this document is unlawful and offenders may be prosecuted to the fullest extent of the law.

Band Reject Filters	MICRO TRONICS	BRM 50702	120	Feb. 26th, 2019	Feb. 25th, 2020
Digital Radio Communication Tester	R&S	CMU200	100535	Sep. 17th, 2018	Sep. 16th, 2019
Attenuator	Marvelous	MVE2213-10	RF80	Feb. 26th, 2019	Feb. 25th, 2020
Radio Communication Analyser	Anritsu	MT8815B	6200711454	Apr. 1st, 2019	Mar. 31th, 2020
Radio Communication Analyser	Anritsu	MT8820C	6201465317	Jan. 16th, 2019	Jan. 15th, 2020
Cable	HUBER SUHNER	SUCOFLEX 104PEA	25157	Feb. 26th, 2019	Feb. 25th, 2020
Cable	HUBER SUHNER	SUCOFLEX 104PEA	20995	Feb. 26th, 2019	Feb. 25th, 2020
Software	e3 V6.11-20180413				

Unless otherwise stated the results shown in this test report refer only to the sample(s) tested and such sample(s) are retained for 90 days only.

除非另有說明，此報告結果僅對測試之樣品負責，同時此樣品僅保留90天。本報告未經本公司書面許可，不可部份複製。

This document is issued by the Company subject to its General Conditions of Service printed overleaf, available on request or accessible at www.sgs.com/terms_and_conditions.htm and for electronic format documents, subject to Terms and Conditions for Electronic Documents at www.sgs.com/terms_e-document.htm. Attention is drawn to the limitation of liability, indemnification and jurisdiction issues defined therein. Any holder of this document is advised that information contained hereon reflects the Company's findings at the time of its intervention only and within the limits of Client's instructions, if any. The Company's sole responsibility is to its Client and this document does not exonerate parties to a transaction from exercising all their rights and obligations under the transaction documents. This document cannot be reproduced except in full, without prior written approval of the Company. Any unauthorized alteration, forgery or falsification of the content or appearance of this document is unlawful and offenders may be prosecuted to the fullest extent of the law.

9.5. Measurement Result:

Radiated Spurious Emission Measurement Result: GSM 1900 Mode

Operation Band	:GSM 1900	Test Date	:2019-04-12
Fundamental Frequency	:1850.2 MHz	Temp./Humi.	:21/53
Operation Mode	:Tx CH Low	Engineer	:Jerry
EUT Pol.	:E1 Plan	Measurement Antenna Pol.	:VERTICAL

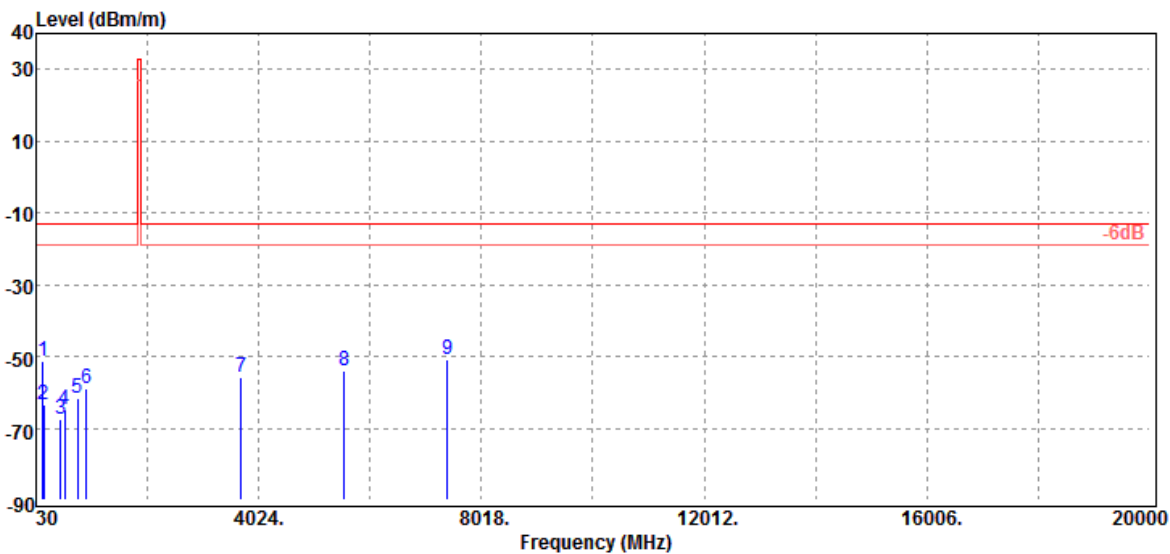

Freq. MHz	ERP/EIRP dBm	SG Output Level dBm	Antenna Gain dBd/dBi	Cable Loss dB	Limit dBm	Margin dB
146.40	-51.10	-42.60	-7.51	-1.00	-13.00	-38.10
172.59	-63.35	-57.08	-5.19	-1.08	-13.00	-50.35
474.26	-67.49	-63.34	-2.35	-1.81	-13.00	-54.49
548.95	-64.76	-61.58	-1.23	-1.95	-13.00	-51.76
773.99	-61.88	-58.12	-1.43	-2.34	-13.00	-48.88
932.10	-59.15	-55.26	-1.29	-2.59	-13.00	-46.15
3700.40	-55.71	-62.62	12.50	-5.72	-13.00	-42.71
5550.60	-53.84	-60.34	13.20	-6.94	-13.00	-40.84
7400.80	-51.02	-53.51	10.60	-8.19	-13.00	-38.02

Unless otherwise stated the results shown in this test report refer only to the sample(s) tested and such sample(s) are retained for 90 days only.

除非另有說明，此報告結果僅對測試之樣品負責，同時此樣品僅保留90天。本報告未經本公司書面許可，不可部份複製。

This document is issued by the Company subject to its General Conditions of Service printed overleaf, available on request or accessible at www.sgs.com/terms_and_conditions.htm and for electronic format documents, subject to Terms and Conditions for Electronic Documents at www.sgs.com/terms_e-document.htm. Attention is drawn to the limitation of liability, indemnification and jurisdiction issues defined therein. Any holder of this document is advised that information contained hereon reflects the Company's findings at the time of its intervention only and within the limits of Client's instructions, if any. The Company's sole responsibility is to its Client and this document does not exonerate parties to a transaction from exercising all their rights and obligations under the transaction documents. This document cannot be reproduced except in full, without prior written approval of the Company. Any unauthorized alteration, forgery or falsification of the content or appearance of this document is unlawful and offenders may be prosecuted to the fullest extent of the law.

Operation Band :GSM 1900
Fundamental Frequency :1850.2 MHz
Operation Mode :Tx CH Low
EUT Pol. :E1 Plan

Test Date :2019-04-12
Temp./Humi. :21/53
Engineer :Jerry
Measurement Antenna Pol. :HORIZONTAL

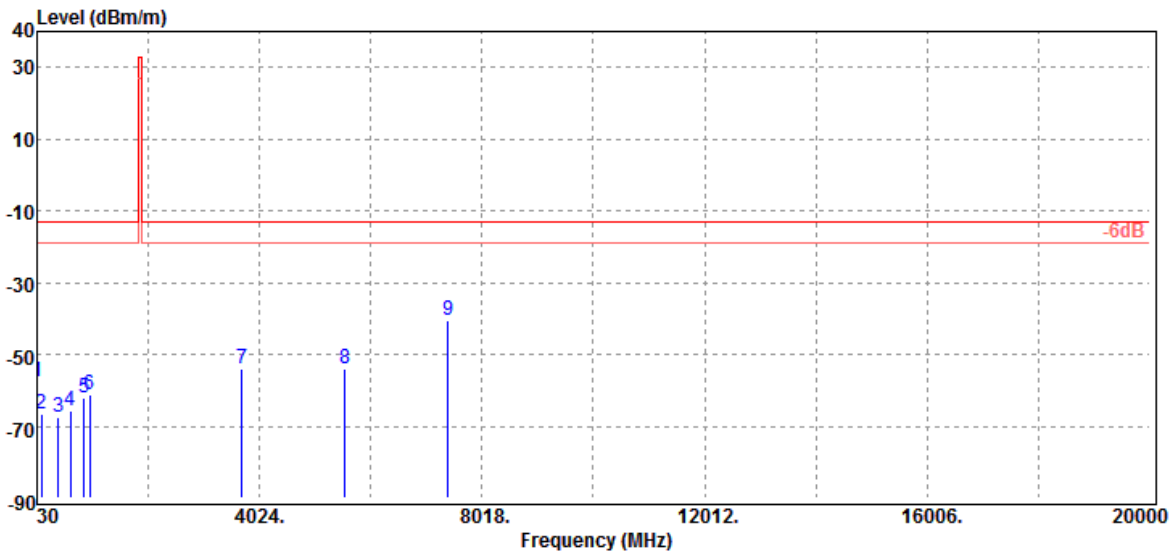

Freq. MHz	ERP/EIRP dBm	SG Output Level dBm	Antenna Gain dBd/dBi	Cable Loss dB	Limit dBm	Margin dB
30.00	-57.46	-26.96	-30.05	-0.45	-13.00	-44.46
102.75	-66.60	-56.86	-8.91	-0.83	-13.00	-53.60
418.00	-67.58	-64.03	-1.85	-1.70	-13.00	-54.58
636.25	-65.55	-61.77	-1.68	-2.11	-13.00	-52.55
878.75	-62.16	-58.40	-1.25	-2.51	-13.00	-49.16
972.84	-61.31	-57.36	-1.31	-2.64	-13.00	-48.31
3700.40	-53.98	-60.90	12.50	-5.72	-13.00	-40.98
5550.60	-53.99	-60.49	13.20	-6.94	-13.00	-40.99
7400.80	-40.49	-42.98	10.60	-8.19	-13.00	-27.49

Unless otherwise stated the results shown in this test report refer only to the sample(s) tested and such sample(s) are retained for 90 days only.

除非另有說明，此報告結果僅對測試之樣品負責，同時此樣品僅保留90天。本報告未經本公司書面許可，不可部份複製。

This document is issued by the Company subject to its General Conditions of Service printed overleaf, available on request or accessible at www.sgs.com/terms_and_conditions.htm and for electronic format documents, subject to Terms and Conditions for Electronic Documents at www.sgs.com/terms_e-document.htm. Attention is drawn to the limitation of liability, indemnification and jurisdiction issues defined therein. Any holder of this document is advised that information contained hereon reflects the Company's findings at the time of its intervention only and within the limits of Client's instructions, if any. The Company's sole responsibility is to its Client and this document does not exonerate parties to a transaction from exercising all their rights and obligations under the transaction documents. This document cannot be reproduced except in full, without prior written approval of the Company. Any unauthorized alteration, forgery or falsification of the content or appearance of this document is unlawful and offenders may be prosecuted to the fullest extent of the law.

Operation Band :GSM 1900
Fundamental Frequency :1880 MHz
Operation Mode :Tx CH Mid
EUT Pol. :E1 Plan

Test Date :2019-04-12
Temp./Humi. :21/53
Engineer :Jerry
Measurement Antenna Pol. :VERTICAL

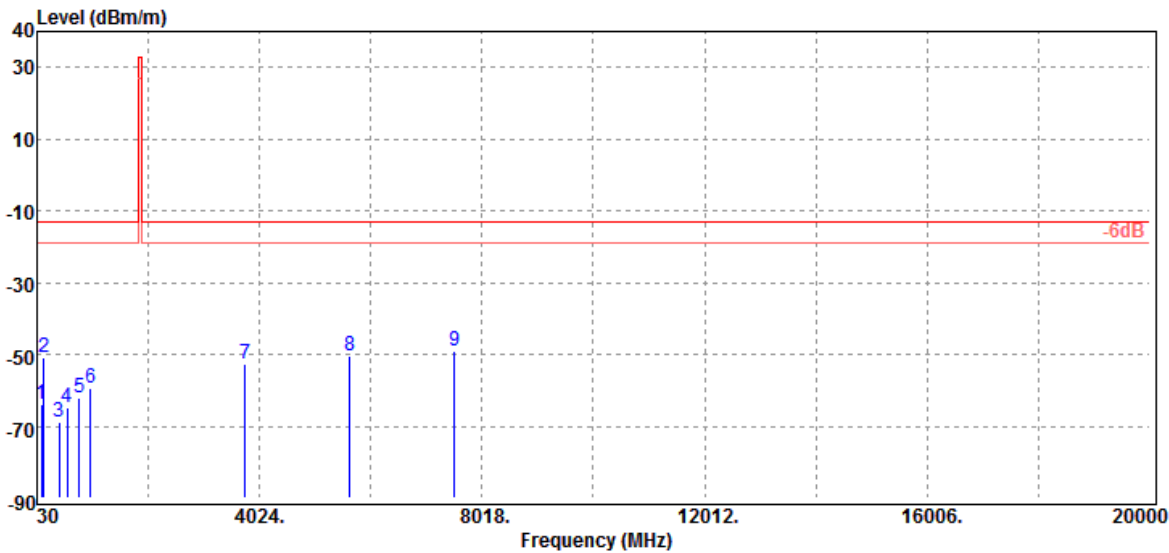

Freq. MHz	ERP/EIRP dBm	SG Output Level dBm	Antenna Gain dBd/dBi	Cable Loss dB	Limit dBm	Margin dB
115.36	-64.11	-52.76	-10.46	-0.88	-13.00	-51.11
146.40	-50.74	-42.24	-7.51	-1.00	-13.00	-37.74
429.64	-68.66	-65.09	-1.85	-1.72	-13.00	-55.66
565.44	-64.86	-61.51	-1.36	-1.99	-13.00	-51.86
786.60	-62.26	-58.59	-1.32	-2.35	-13.00	-49.26
993.21	-59.59	-55.54	-1.39	-2.67	-13.00	-46.59
3760.00	-52.55	-59.40	12.42	-5.69	-13.00	-39.55
5640.00	-50.41	-56.77	13.26	-7.11	-13.00	-37.41
7520.00	-49.06	-51.89	10.84	-8.12	-13.00	-36.06

Unless otherwise stated the results shown in this test report refer only to the sample(s) tested and such sample(s) are retained for 90 days only.

除非另有說明，此報告結果僅對測試之樣品負責，同時此樣品僅保留90天。本報告未經本公司書面許可，不可部份複製。

This document is issued by the Company subject to its General Conditions of Service printed overleaf, available on request or accessible at www.sgs.com/terms_and_conditions.htm and for electronic format documents, subject to Terms and Conditions for Electronic Documents at www.sgs.com/terms_e-document.htm. Attention is drawn to the limitation of liability, indemnification and jurisdiction issues defined therein. Any holder of this document is advised that information contained hereon reflects the Company's findings at the time of its intervention only and within the limits of Client's instructions, if any. The Company's sole responsibility is to its Client and this document does not exonerate parties to a transaction from exercising all their rights and obligations under the transaction documents. This document cannot be reproduced except in full, without prior written approval of the Company. Any unauthorized alteration, forgery or falsification of the content or appearance of this document is unlawful and offenders may be prosecuted to the fullest extent of the law.

Operation Band :GSM 1900
Fundamental Frequency :1880 MHz
Operation Mode :Tx CH Mid
EUT Pol. :E1 Plan

Test Date :2019-04-12
Temp./Humi. :21/53
Engineer :Jerry
Measurement Antenna Pol. :HORIZONTAL

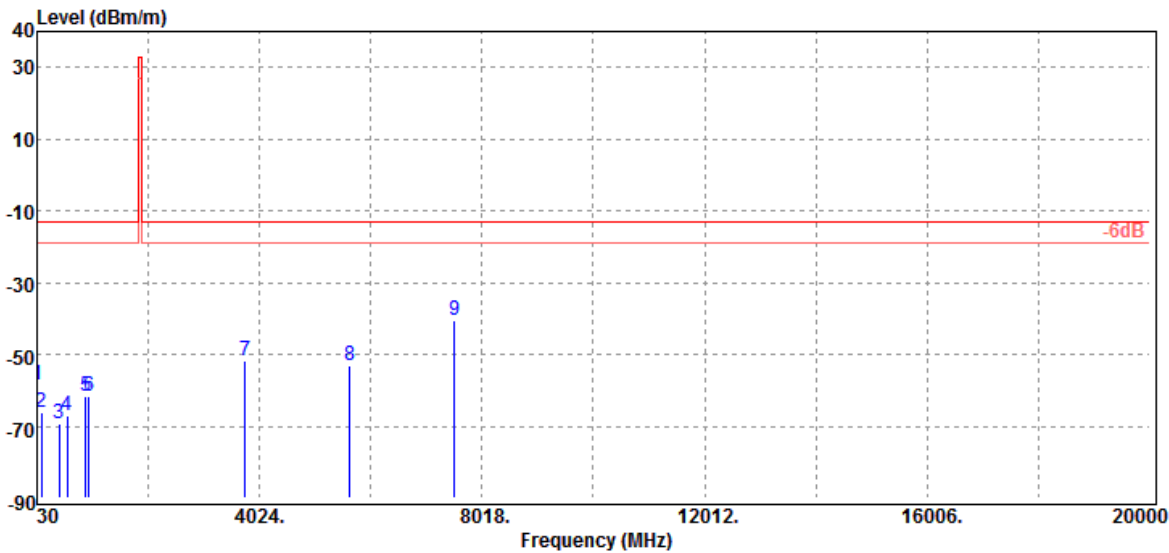

Freq. MHz	ERP/EIRP dBm	SG Output Level dBm	Antenna Gain dBd/dBi	Cable Loss dB	Limit dBm	Margin dB
30.00	-58.61	-28.11	-30.05	-0.45	-13.00	-45.61
102.75	-66.37	-56.63	-8.91	-0.83	-13.00	-53.37
432.55	-69.13	-65.50	-1.90	-1.72	-13.00	-56.13
573.20	-66.95	-63.49	-1.45	-2.01	-13.00	-53.95
900.09	-61.64	-57.85	-1.25	-2.54	-13.00	-48.64
968.96	-61.59	-57.69	-1.27	-2.64	-13.00	-48.59
3760.00	-51.74	-58.59	12.42	-5.69	-13.00	-38.74
5640.00	-52.99	-59.35	13.26	-7.11	-13.00	-39.99
7520.00	-40.48	-43.31	10.84	-8.12	-13.00	-27.48

Unless otherwise stated the results shown in this test report refer only to the sample(s) tested and such sample(s) are retained for 90 days only.

除非另有說明，此報告結果僅對測試之樣品負責，同時此樣品僅保留90天。本報告未經本公司書面許可，不可部份複製。

This document is issued by the Company subject to its General Conditions of Service printed overleaf, available on request or accessible at www.sgs.com/terms_and_conditions.htm and for electronic format documents, subject to Terms and Conditions for Electronic Documents at www.sgs.com/terms_e-document.htm. Attention is drawn to the limitation of liability, indemnification and jurisdiction issues defined therein. Any holder of this document is advised that information contained hereon reflects the Company's findings at the time of its intervention only and within the limits of Client's instructions, if any. The Company's sole responsibility is to its Client and this document does not exonerate parties to a transaction from exercising all their rights and obligations under the transaction documents. This document cannot be reproduced except in full, without prior written approval of the Company. Any unauthorized alteration, forgery or falsification of the content or appearance of this document is unlawful and offenders may be prosecuted to the fullest extent of the law.

Operation Band :GSM 1900
Fundamental Frequency :1909.8 MHz
Operation Mode :Tx CH High
EUT Pol. :E1 Plan

Test Date :2019-04-12
Temp./Humi. :21/53
Engineer :Jerry
Measurement Antenna Pol. :VERTICAL

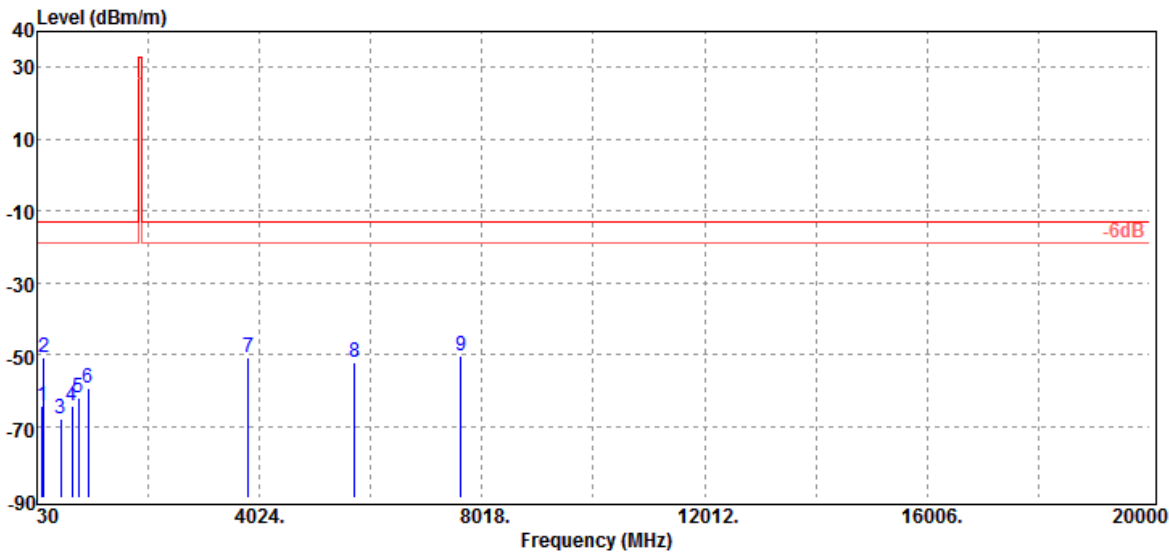

Freq. MHz	ERP/EIRP dBm	SG Output Level dBm	Antenna Gain dBd/dBi	Cable Loss dB	Limit dBm	Margin dB
122.15	-64.22	-52.75	-10.56	-0.91	-13.00	-51.22
146.40	-50.67	-42.16	-7.51	-1.00	-13.00	-37.67
458.74	-67.77	-63.94	-2.05	-1.78	-13.00	-54.77
655.65	-64.58	-60.81	-1.62	-2.15	-13.00	-51.58
778.84	-61.97	-58.18	-1.45	-2.34	-13.00	-48.97
951.50	-59.45	-55.65	-1.18	-2.62	-13.00	-46.45
3819.60	-50.95	-57.77	12.46	-5.76	-13.00	-37.95
5729.40	-52.07	-58.31	13.10	-7.04	-13.00	-39.07
7639.20	-50.19	-53.46	11.20	-8.23	-13.00	-37.19

Unless otherwise stated the results shown in this test report refer only to the sample(s) tested and such sample(s) are retained for 90 days only.

除非另有說明，此報告結果僅對測試之樣品負責，同時此樣品僅保留90天。本報告未經本公司書面許可，不可部份複製。

This document is issued by the Company subject to its General Conditions of Service printed overleaf, available on request or accessible at www.sgs.com/terms_and_conditions.htm and for electronic format documents, subject to Terms and Conditions for Electronic Documents at www.sgs.com/terms_e-document.htm. Attention is drawn to the limitation of liability, indemnification and jurisdiction issues defined therein. Any holder of this document is advised that information contained hereon reflects the Company's findings at the time of its intervention only and within the limits of Client's instructions, if any. The Company's sole responsibility is to its Client and this document does not exonerate parties to a transaction from exercising all their rights and obligations under the transaction documents. This document cannot be reproduced except in full, without prior written approval of the Company. Any unauthorized alteration, forgery or falsification of the content or appearance of this document is unlawful and offenders may be prosecuted to the fullest extent of the law.

Operation Band :GSM 1900
Fundamental Frequency :1909.8 MHz
Operation Mode :Tx CH High
EUT Pol. :E1 Plan

Test Date :2019-04-12
Temp./Humi. :21/53
Engineer :Jerry
Measurement Antenna Pol. :HORIZONTAL

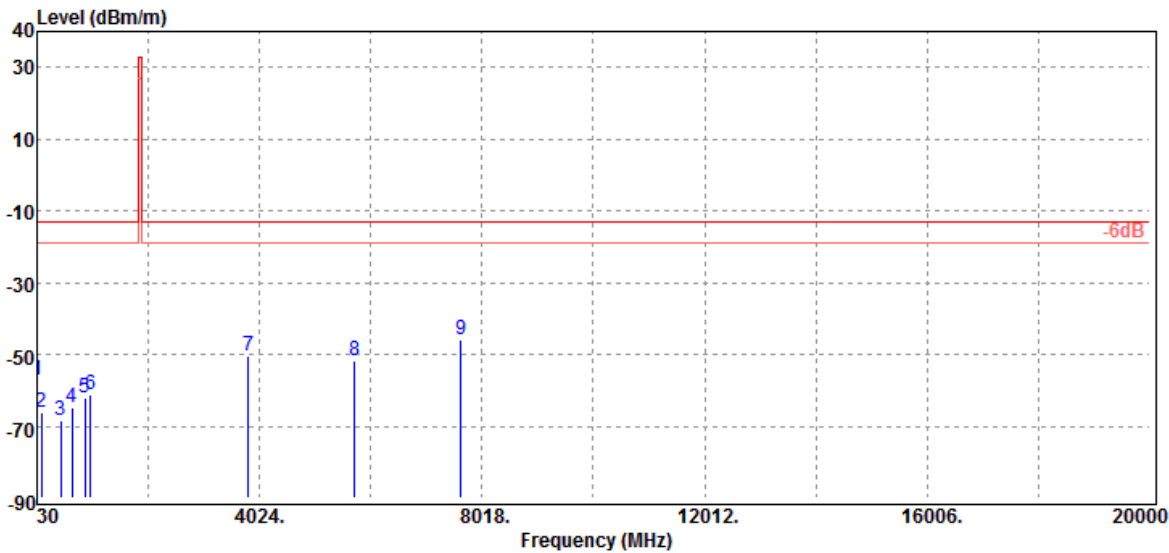

Freq. MHz	ERP/EIRP dBm	SG Output Level dBm	Antenna Gain dBd/dBi	Cable Loss dB	Limit dBm	Margin dB
30.00	-57.34	-26.84	-30.05	-0.45	-13.00	-44.34
102.75	-66.31	-56.57	-8.91	-0.83	-13.00	-53.31
451.95	-68.34	-64.52	-2.05	-1.76	-13.00	-55.34
652.74	-65.02	-61.22	-1.65	-2.15	-13.00	-52.02
886.51	-62.09	-58.32	-1.25	-2.52	-13.00	-49.09
988.36	-61.17	-57.09	-1.42	-2.66	-13.00	-48.17
3819.60	-50.40	-57.22	12.46	-5.76	-13.00	-37.40
5729.40	-51.91	-58.14	13.10	-7.04	-13.00	-38.91
7639.20	-46.00	-49.27	11.20	-8.23	-13.00	-33.00

Unless otherwise stated the results shown in this test report refer only to the sample(s) tested and such sample(s) are retained for 90 days only.

除非另有說明，此報告結果僅對測試之樣品負責，同時此樣品僅保留90天。本報告未經本公司書面許可，不可部份複製。

This document is issued by the Company subject to its General Conditions of Service printed overleaf, available on request or accessible at www.sgs.com/terms_and_conditions.htm and for electronic format documents, subject to Terms and Conditions for Electronic Documents at www.sgs.com/terms_e-document.htm. Attention is drawn to the limitation of liability, indemnification and jurisdiction issues defined therein. Any holder of this document is advised that information contained hereon reflects the Company's findings at the time of its intervention only and within the limits of Client's instructions, if any. The Company's sole responsibility is to its Client and this document does not exonerate parties to a transaction from exercising all their rights and obligations under the transaction documents. This document cannot be reproduced except in full, without prior written approval of the Company. Any unauthorized alteration, forgery or falsification of the content or appearance of this document is unlawful and offenders may be prosecuted to the fullest extent of the law.

Radiated Spurious Emission Measurement Result: WCDMA Band 2 Mode

Operation Band	:WCDMA B2	Test Date	:2019-04-12
Fundamental Frequency	:1852.4 MHz	Temp./Humi.	:21/53
Operation Mode	:Tx CH Low	Engineer	:Jerry
EUT Pol.	:E1 Plan	Measurement Antenna Pol.	:VERTICAL

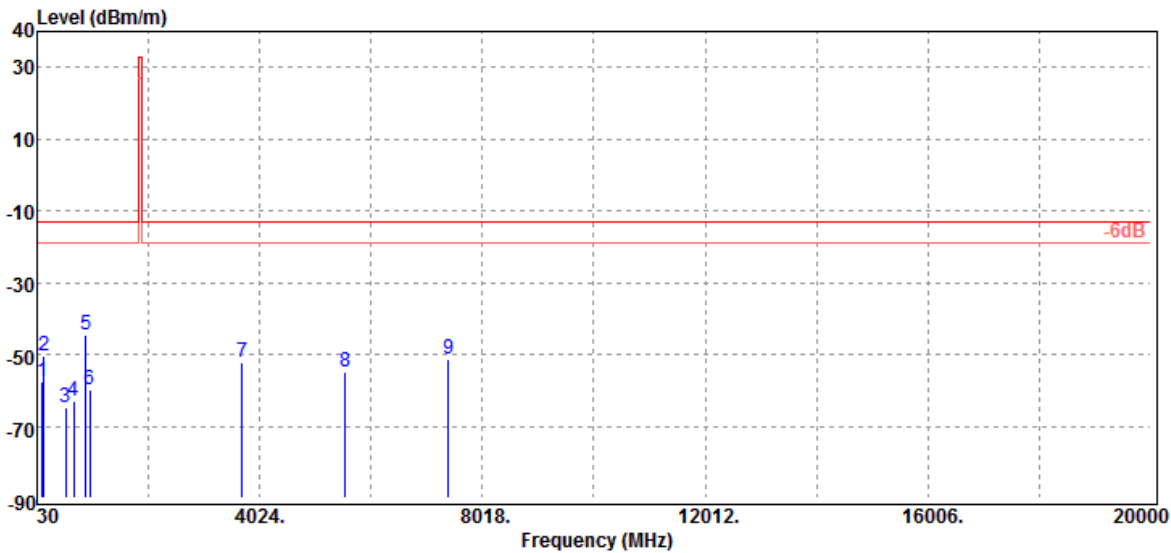

Freq. MHz	ERP/EIRP dBm	SG Output Level dBm	Antenna Gain dBd/dBi	Cable Loss dB	Limit dBm	Margin dB
122.15	-57.42	-45.95	-10.56	-0.91	-13.00	-44.42
148.34	-50.27	-41.96	-7.31	-1.00	-13.00	-37.27
546.04	-64.87	-61.76	-1.17	-1.94	-13.00	-51.87
691.54	-63.16	-59.60	-1.35	-2.22	-13.00	-50.16
904.94	-44.60	-40.80	-1.25	-2.55	-13.00	-31.60
973.81	-59.73	-55.76	-1.33	-2.64	-13.00	-46.73
3704.80	-52.11	-59.01	12.49	-5.72	-13.00	-39.11
5557.20	-54.93	-61.40	13.19	-6.95	-13.00	-41.93
7409.60	-51.30	-53.77	10.58	-8.19	-13.00	-38.30

Unless otherwise stated the results shown in this test report refer only to the sample(s) tested and such sample(s) are retained for 90 days only.

除非另有說明，此報告結果僅對測試之樣品負責，同時此樣品僅保留90天。本報告未經本公司書面許可，不可部份複製。

This document is issued by the Company subject to its General Conditions of Service printed overleaf, available on request or accessible at www.sgs.com/terms_and_conditions.htm and for electronic format documents, subject to Terms and Conditions for Electronic Documents at www.sgs.com/terms_e-document.htm. Attention is drawn to the limitation of liability, indemnification and jurisdiction issues defined therein. Any holder of this document is advised that information contained hereon reflects the Company's findings at the time of its intervention only and within the limits of Client's instructions, if any. The Company's sole responsibility is to its Client and this document does not exonerate parties to a transaction from exercising all their rights and obligations under the transaction documents. This document cannot be reproduced except in full, without prior written approval of the Company. Any unauthorized alteration, forgery or falsification of the content or appearance of this document is unlawful and offenders may be prosecuted to the fullest extent of the law.

Operation Band :WCDMA B2
Fundamental Frequency :1852.4 MHz
Operation Mode :Tx CH Low
EUT Pol. :E1 Plan

Test Date :2019-04-12
Temp./Humi. :21/53
Engineer :Jerry
Measurement Antenna Pol. :HORIZONTAL

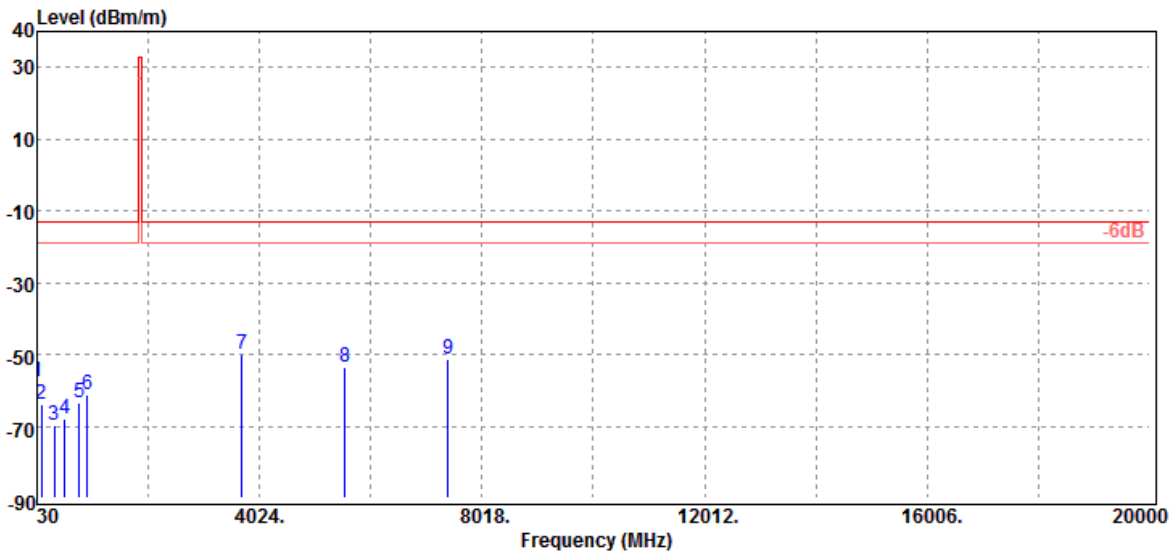

Freq. MHz	ERP/EIRP dBm	SG Output Level dBm	Antenna Gain dBd/dBi	Cable Loss dB	Limit dBm	Margin dB
30.00	-57.82	-27.32	-30.05	-0.45	-13.00	-44.82
102.75	-64.05	-54.31	-8.91	-0.83	-13.00	-51.05
340.40	-69.63	-66.65	-1.45	-1.53	-13.00	-56.63
531.49	-67.91	-64.66	-1.32	-1.92	-13.00	-54.91
781.75	-63.27	-59.51	-1.41	-2.35	-13.00	-50.27
939.86	-61.07	-57.22	-1.25	-2.60	-13.00	-48.07
3704.80	-49.96	-56.86	12.49	-5.72	-13.00	-36.96
5557.20	-53.74	-60.21	13.19	-6.95	-13.00	-40.74
7409.60	-51.52	-53.99	10.58	-8.19	-13.00	-38.52

Unless otherwise stated the results shown in this test report refer only to the sample(s) tested and such sample(s) are retained for 90 days only.

除非另有說明，此報告結果僅對測試之樣品負責，同時此樣品僅保留90天。本報告未經本公司書面許可，不可部份複製。

This document is issued by the Company subject to its General Conditions of Service printed overleaf, available on request or accessible at www.sgs.com/terms_and_conditions.htm and for electronic format documents, subject to Terms and Conditions for Electronic Documents at www.sgs.com/terms_e-document.htm. Attention is drawn to the limitation of liability, indemnification and jurisdiction issues defined therein. Any holder of this document is advised that information contained hereon reflects the Company's findings at the time of its intervention only and within the limits of Client's instructions, if any. The Company's sole responsibility is to its Client and this document does not exonerate parties to a transaction from exercising all their rights and obligations under the transaction documents. This document cannot be reproduced except in full, without prior written approval of the Company. Any unauthorized alteration, forgery or falsification of the content or appearance of this document is unlawful and offenders may be prosecuted to the fullest extent of the law.

Operation Band :WCDMA B2
Fundamental Frequency :1880 MHz
Operation Mode :Tx CH Mid
EUT Pol. :E1 Plan

Test Date :2019-04-12
Temp./Humi. :21/53
Engineer :Jerry
Measurement Antenna Pol. :VERTICAL

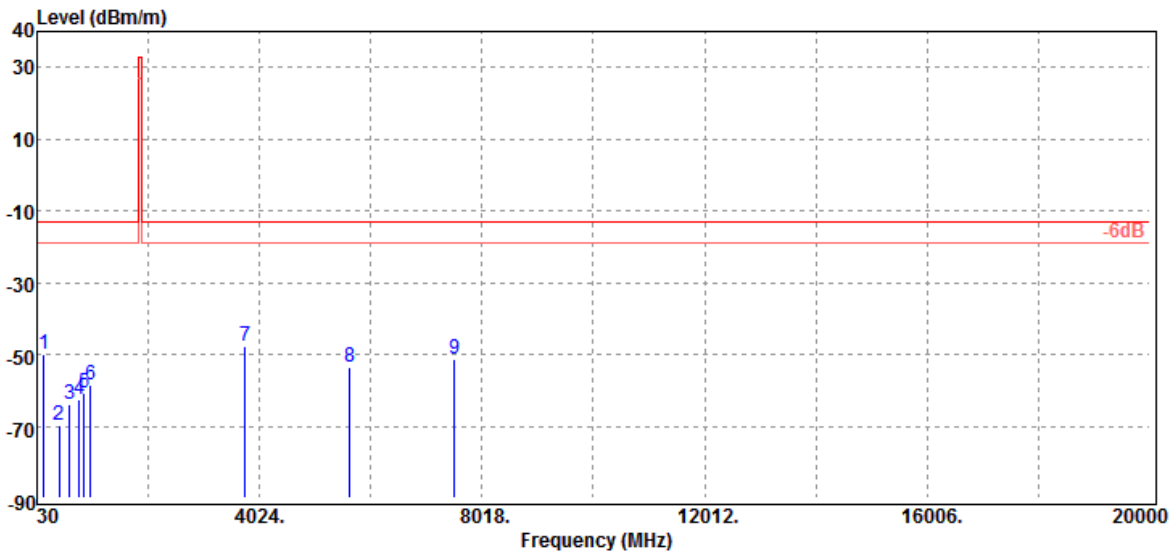

Freq. MHz	ERP/EIRP dBm	SG Output Level dBm	Antenna Gain dBd/dBi	Cable Loss dB	Limit dBm	Margin dB
146.40	-49.90	-41.40	-7.51	-1.00	-13.00	-36.90
434.49	-69.79	-66.13	-1.94	-1.73	-13.00	-56.79
618.79	-64.02	-60.61	-1.33	-2.08	-13.00	-51.02
786.60	-62.37	-58.71	-1.32	-2.35	-13.00	-49.37
870.99	-60.63	-56.89	-1.25	-2.49	-13.00	-47.63
997.09	-58.55	-54.48	-1.39	-2.68	-13.00	-45.55
3760.00	-47.64	-54.49	12.42	-5.69	-13.00	-34.64
5640.00	-53.70	-60.06	13.26	-7.11	-13.00	-40.70
7520.00	-51.47	-54.30	10.84	-8.12	-13.00	-38.47

Unless otherwise stated the results shown in this test report refer only to the sample(s) tested and such sample(s) are retained for 90 days only.

除非另有說明，此報告結果僅對測試之樣品負責，同時此樣品僅保留90天。本報告未經本公司書面許可，不可部份複製。

This document is issued by the Company subject to its General Conditions of Service printed overleaf, available on request or accessible at www.sgs.com/terms_and_conditions.htm and for electronic format documents, subject to Terms and Conditions for Electronic Documents at www.sgs.com/terms_e-document.htm. Attention is drawn to the limitation of liability, indemnification and jurisdiction issues defined therein. Any holder of this document is advised that information contained hereon reflects the Company's findings at the time of its intervention only and within the limits of Client's instructions, if any. The Company's sole responsibility is to its Client and this document does not exonerate parties to a transaction from exercising all their rights and obligations under the transaction documents. This document cannot be reproduced except in full, without prior written approval of the Company. Any unauthorized alteration, forgery or falsification of the content or appearance of this document is unlawful and offenders may be prosecuted to the fullest extent of the law.

Operation Band :WCDMA B2
Fundamental Frequency :1880 MHz
Operation Mode :Tx CH Mid
EUT Pol. :E1 Plan

Test Date :2019-04-12
Temp./Humi. :21/53
Engineer :Jerry
Measurement Antenna Pol. :HORIZONTAL

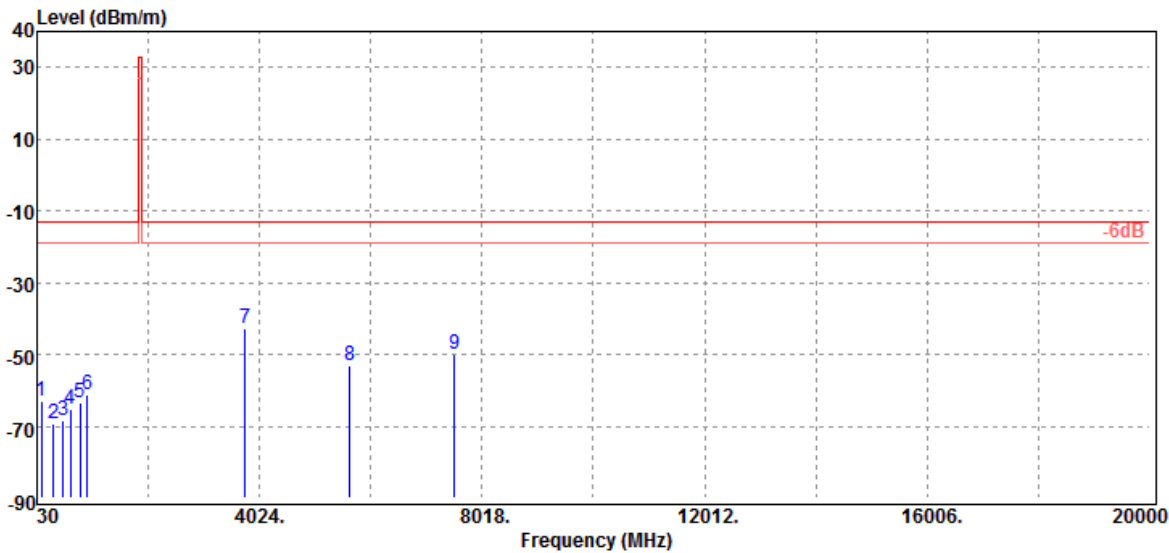

Freq. MHz	ERP/EIRP dBm	SG Output Level dBm	Antenna Gain dBd/dBi	Cable Loss dB	Limit dBm	Margin dB
102.75	-62.92	-53.18	-8.91	-0.83	-13.00	-49.92
330.70	-69.45	-66.30	-1.65	-1.51	-13.00	-56.45
492.69	-68.49	-64.50	-2.14	-1.85	-13.00	-55.49
631.40	-65.19	-61.51	-1.58	-2.10	-13.00	-52.19
796.30	-63.38	-59.76	-1.25	-2.37	-13.00	-50.38
938.89	-61.35	-57.48	-1.27	-2.60	-13.00	-48.35
3760.00	-42.71	-49.56	12.42	-5.69	-13.00	-29.71
5640.00	-53.29	-59.65	13.26	-7.11	-13.00	-40.29
7520.00	-49.90	-52.73	10.84	-8.12	-13.00	-36.90

Unless otherwise stated the results shown in this test report refer only to the sample(s) tested and such sample(s) are retained for 90 days only.

除非另有說明，此報告結果僅對測試之樣品負責，同時此樣品僅保留90天。本報告未經本公司書面許可，不可部份複製。

This document is issued by the Company subject to its General Conditions of Service printed overleaf, available on request or accessible at www.sgs.com/terms_and_conditions.htm and for electronic format documents, subject to Terms and Conditions for Electronic Documents at www.sgs.com/terms_e-document.htm. Attention is drawn to the limitation of liability, indemnification and jurisdiction issues defined therein. Any holder of this document is advised that information contained hereon reflects the Company's findings at the time of its intervention only and within the limits of Client's instructions, if any. The Company's sole responsibility is to its Client and this document does not exonerate parties to a transaction from exercising all their rights and obligations under the transaction documents. This document cannot be reproduced except in full, without prior written approval of the Company. Any unauthorized alteration, forgery or falsification of the content or appearance of this document is unlawful and offenders may be prosecuted to the fullest extent of the law.

Operation Band :WCDMA B2
Fundamental Frequency :1907.6 MHz
Operation Mode :Tx CH High
EUT Pol. :E1 Plan

Test Date :2019-04-12
Temp./Humi. :21/53
Engineer :Jerry
Measurement Antenna Pol. :VERTICAL

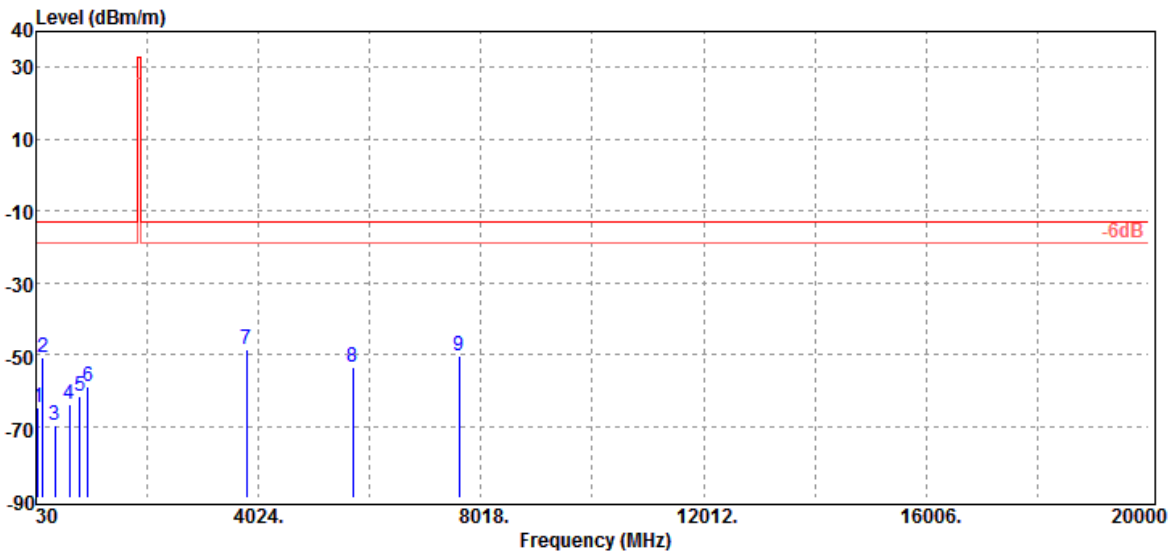

Freq. MHz	ERP/EIRP dBm	SG Output Level dBm	Antenna Gain dBd/dBi	Cable Loss dB	Limit dBm	Margin dB
65.89	-64.97	-54.24	-10.06	-0.67	-13.00	-51.97
146.40	-50.76	-42.26	-7.51	-1.00	-13.00	-37.76
371.44	-69.90	-66.58	-1.72	-1.60	-13.00	-56.90
636.25	-63.94	-60.16	-1.68	-2.11	-13.00	-50.94
815.70	-61.68	-57.80	-1.46	-2.41	-13.00	-48.68
956.35	-59.15	-55.28	-1.25	-2.62	-13.00	-46.15
3815.20	-48.53	-55.36	12.47	-5.76	-13.00	-35.53
5722.80	-53.38	-59.64	13.10	-7.02	-13.00	-40.38
7630.40	-50.45	-53.69	11.20	-8.23	-13.00	-37.45

Unless otherwise stated the results shown in this test report refer only to the sample(s) tested and such sample(s) are retained for 90 days only.

除非另有說明，此報告結果僅對測試之樣品負責，同時此樣品僅保留90天。本報告未經本公司書面許可，不可部份複製。

This document is issued by the Company subject to its General Conditions of Service printed overleaf, available on request or accessible at www.sgs.com/terms_and_conditions.htm and for electronic format documents, subject to Terms and Conditions for Electronic Documents at www.sgs.com/terms_e-document.htm. Attention is drawn to the limitation of liability, indemnification and jurisdiction issues defined therein. Any holder of this document is advised that information contained hereon reflects the Company's findings at the time of its intervention only and within the limits of Client's instructions, if any. The Company's sole responsibility is to its Client and this document does not exonerate parties to a transaction from exercising all their rights and obligations under the transaction documents. This document cannot be reproduced except in full, without prior written approval of the Company. Any unauthorized alteration, forgery or falsification of the content or appearance of this document is unlawful and offenders may be prosecuted to the fullest extent of the law.

Operation Band :WCDMA B2
Fundamental Frequency :1907.6 MHz
Operation Mode :Tx CH High
EUT Pol. :E1 Plan

Test Date :2019-04-12
Temp./Humi. :21/53
Engineer :Jerry
Measurement Antenna Pol. :HORIZONTAL

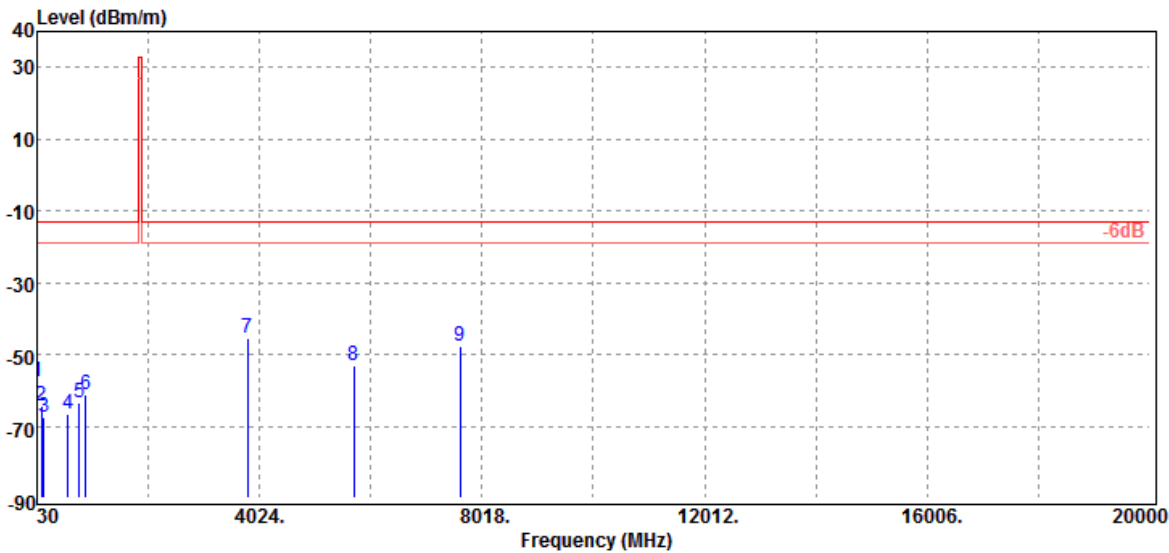

Freq. MHz	ERP/EIRP dBm	SG Output Level dBm	Antenna Gain dBd/dBi	Cable Loss dB	Limit dBm	Margin dB
30.00	-57.56	-27.06	-30.05	-0.45	-13.00	-44.56
102.75	-64.28	-54.54	-8.91	-0.83	-13.00	-51.28
154.16	-67.30	-59.46	-6.82	-1.02	-13.00	-54.30
584.84	-66.48	-63.29	-1.16	-2.04	-13.00	-53.48
789.51	-63.58	-59.96	-1.26	-2.35	-13.00	-50.58
904.94	-61.29	-57.49	-1.25	-2.55	-13.00	-48.29
3815.20	-45.29	-52.12	12.47	-5.76	-13.00	-32.29
5722.80	-53.11	-59.37	13.10	-7.02	-13.00	-40.11
7630.40	-47.91	-51.16	11.20	-8.23	-13.00	-34.91

Unless otherwise stated the results shown in this test report refer only to the sample(s) tested and such sample(s) are retained for 90 days only.

除非另有說明，此報告結果僅對測試之樣品負責，同時此樣品僅保留90天。本報告未經本公司書面許可，不可部份複製。

This document is issued by the Company subject to its General Conditions of Service printed overleaf, available on request or accessible at www.sgs.com/terms_and_conditions.htm and for electronic format documents, subject to Terms and Conditions for Electronic Documents at www.sgs.com/terms_e-document.htm. Attention is drawn to the limitation of liability, indemnification and jurisdiction issues defined therein. Any holder of this document is advised that information contained hereon reflects the Company's findings at the time of its intervention only and within the limits of Client's instructions, if any. The Company's sole responsibility is to its Client and this document does not exonerate parties to a transaction from exercising all their rights and obligations under the transaction documents. This document cannot be reproduced except in full, without prior written approval of the Company. Any unauthorized alteration, forgery or falsification of the content or appearance of this document is unlawful and offenders may be prosecuted to the fullest extent of the law.

Radiated Spurious Emission Measurement Result: LTE-Band 2 (The Worst Case)

Operation Band	:LTE B2 20 QPSK 1.50	Test Date	:2019-04-12
Fundamental Frequency	:1860 MHz	Temp./Humi.	:21/53
Operation Mode	:Tx CH Low	Engineer	:Jerry
EUT Pol.	:E1 Plan	Measurement Antenna Pol.	:VERTICAL

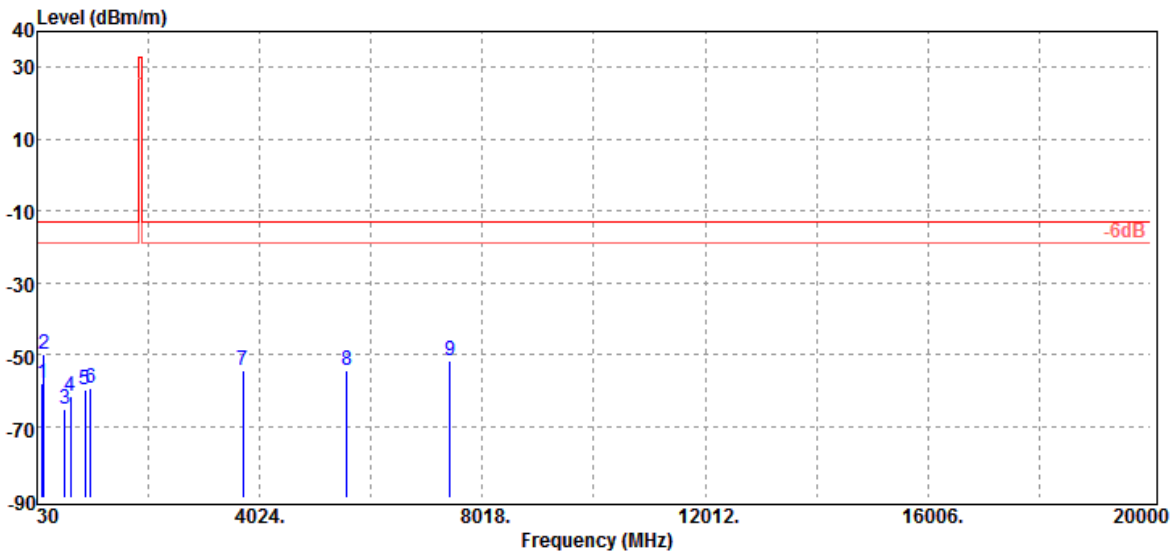

Freq. MHz	ERP/EIRP dBm	SG Output Level dBm	Antenna Gain dBd/dBi	Cable Loss dB	Limit dBm	Margin dB
122.15	-58.09	-46.61	-10.56	-0.91	-13.00	-45.09
148.34	-49.80	-41.48	-7.31	-1.00	-13.00	-36.80
524.70	-65.14	-61.87	-1.36	-1.91	-13.00	-52.14
636.25	-61.70	-57.92	-1.68	-2.11	-13.00	-48.70
893.30	-59.83	-56.05	-1.25	-2.53	-13.00	-46.83
992.24	-59.44	-55.37	-1.41	-2.67	-13.00	-46.44
3720.00	-54.61	-61.49	12.46	-5.71	-13.00	-41.61
5580.00	-54.44	-60.80	13.14	-7.01	-13.00	-41.44
7440.00	-51.94	-54.36	10.52	-8.18	-13.00	-38.94

Unless otherwise stated the results shown in this test report refer only to the sample(s) tested and such sample(s) are retained for 90 days only.

除非另有說明，此報告結果僅對測試之樣品負責，同時此樣品僅保留90天。本報告未經本公司書面許可，不可部份複製。

This document is issued by the Company subject to its General Conditions of Service printed overleaf, available on request or accessible at www.sgs.com/terms_and_conditions.htm and for electronic format documents, subject to Terms and Conditions for Electronic Documents at www.sgs.com/terms_e-document.htm. Attention is drawn to the limitation of liability, indemnification and jurisdiction issues defined therein. Any holder of this document is advised that information contained hereon reflects the Company's findings at the time of its intervention only and within the limits of Client's instructions, if any. The Company's sole responsibility is to its Client and this document does not exonerate parties to a transaction from exercising all their rights and obligations under the transaction documents. This document cannot be reproduced except in full, without prior written approval of the Company. Any unauthorized alteration, forgery or falsification of the content or appearance of this document is unlawful and offenders may be prosecuted to the fullest extent of the law.

Operation Band	:LTE B2 20 QPSK 1.50	Test Date	:2019-04-12
Fundamental Frequency	:1860 MHz	Temp./Humi.	:21/53
Operation Mode	:Tx CH Low	Engineer	:Jerry
EUT Pol.	:E1 Plan	Measurement Antenna Pol.	:HORIZONTAL

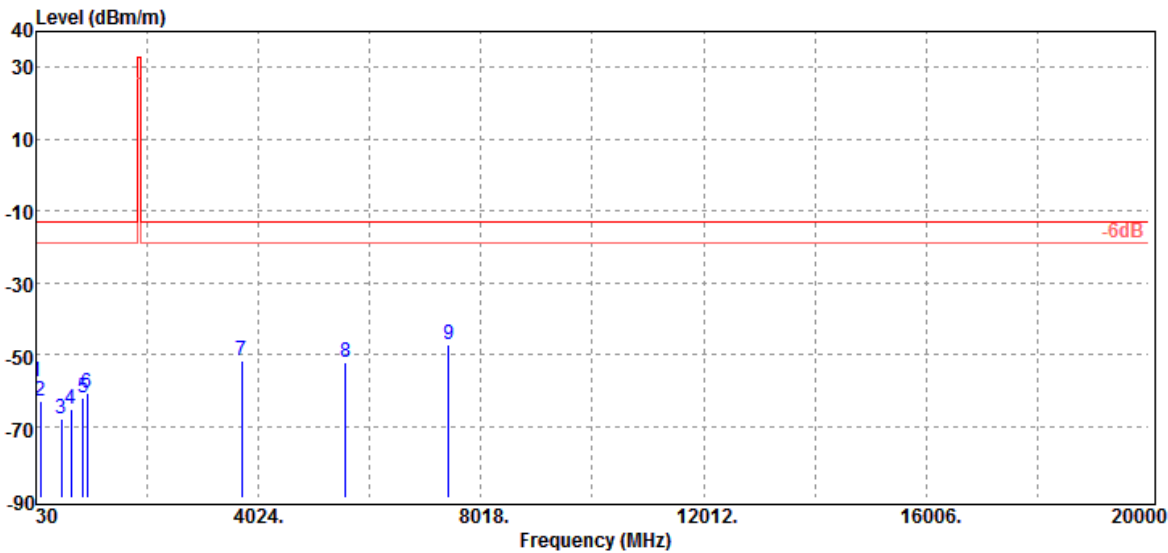

Freq. MHz	ERP/EIRP dBm	SG Output Level dBm	Antenna Gain dBd/dBi	Cable Loss dB	Limit dBm	Margin dB
30.00	-57.62	-27.12	-30.05	-0.45	-13.00	-44.62
102.75	-62.82	-53.08	-8.91	-0.83	-13.00	-49.82
488.81	-67.99	-63.88	-2.27	-1.84	-13.00	-54.99
652.74	-65.27	-61.47	-1.65	-2.15	-13.00	-52.27
875.84	-62.24	-58.49	-1.25	-2.50	-13.00	-49.24
954.41	-60.96	-57.10	-1.24	-2.62	-13.00	-47.96
3720.00	-51.93	-58.80	12.46	-5.71	-13.00	-38.93
5580.00	-52.33	-58.69	13.14	-7.01	-13.00	-39.33
7440.00	-47.29	-49.70	10.52	-8.18	-13.00	-34.29

Unless otherwise stated the results shown in this test report refer only to the sample(s) tested and such sample(s) are retained for 90 days only.

除非另有說明，此報告結果僅對測試之樣品負責，同時此樣品僅保留90天。本報告未經本公司書面許可，不可部份複製。

This document is issued by the Company subject to its General Conditions of Service printed overleaf, available on request or accessible at www.sgs.com/terms_and_conditions.htm and for electronic format documents, subject to Terms and Conditions for Electronic Documents at www.sgs.com/terms_e-document.htm. Attention is drawn to the limitation of liability, indemnification and jurisdiction issues defined therein. Any holder of this document is advised that information contained hereon reflects the Company's findings at the time of its intervention only and within the limits of Client's instructions, if any. The Company's sole responsibility is to its Client and this document does not exonerate parties to a transaction from exercising all their rights and obligations under the transaction documents. This document cannot be reproduced except in full, without prior written approval of the Company. Any unauthorized alteration, forgery or falsification of the content or appearance of this document is unlawful and offenders may be prosecuted to the fullest extent of the law.

Operation Band :LTE B2 20 QPSK 1.50
Fundamental Frequency :1880 MHz
Operation Mode :Tx CH Mid
EUT Pol. :E1 Plan

Test Date :2019-04-12
Temp./Humi. :21/53
Engineer :Jerry
Measurement Antenna Pol. :VERTICAL

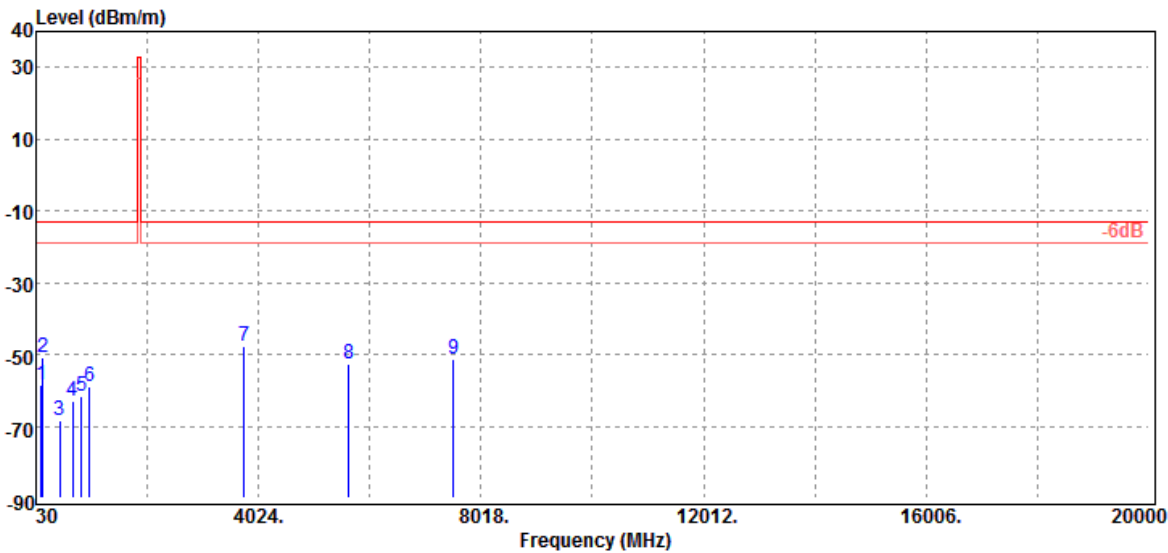

Freq. MHz	ERP/EIRP dBm	SG Output Level dBm	Antenna Gain dBd/dBi	Cable Loss dB	Limit dBm	Margin dB
121.18	-58.73	-47.22	-10.60	-0.91	-13.00	-45.73
146.40	-50.94	-42.44	-7.51	-1.00	-13.00	-37.94
458.74	-68.29	-64.46	-2.05	-1.78	-13.00	-55.29
689.60	-62.85	-59.29	-1.35	-2.21	-13.00	-49.85
842.86	-61.69	-57.84	-1.39	-2.46	-13.00	-48.69
998.06	-59.12	-55.03	-1.41	-2.68	-13.00	-46.12
3760.00	-47.78	-54.63	12.42	-5.69	-13.00	-34.78
5640.00	-52.64	-58.99	13.26	-7.11	-13.00	-39.64
7520.00	-51.42	-54.25	10.84	-8.12	-13.00	-38.42

Unless otherwise stated the results shown in this test report refer only to the sample(s) tested and such sample(s) are retained for 90 days only.

除非另有說明，此報告結果僅對測試之樣品負責，同時此樣品僅保留90天。本報告未經本公司書面許可，不可部份複製。

This document is issued by the Company subject to its General Conditions of Service printed overleaf, available on request or accessible at www.sgs.com/terms_and_conditions.htm and for electronic format documents, subject to Terms and Conditions for Electronic Documents at www.sgs.com/terms_e-document.htm. Attention is drawn to the limitation of liability, indemnification and jurisdiction issues defined therein. Any holder of this document is advised that information contained hereon reflects the Company's findings at the time of its intervention only and within the limits of Client's instructions, if any. The Company's sole responsibility is to its Client and this document does not exonerate parties to a transaction from exercising all their rights and obligations under the transaction documents. This document cannot be reproduced except in full, without prior written approval of the Company. Any unauthorized alteration, forgery or falsification of the content or appearance of this document is unlawful and offenders may be prosecuted to the fullest extent of the law.

Operation Band :LTE B2 20 QPSK 1.50
Fundamental Frequency :1880 MHz
Operation Mode :Tx CH Mid
EUT Pol. :E1 Plan

Test Date :2019-04-12
Temp./Humi. :21/53
Engineer :Jerry
Measurement Antenna Pol. :HORIZONTAL

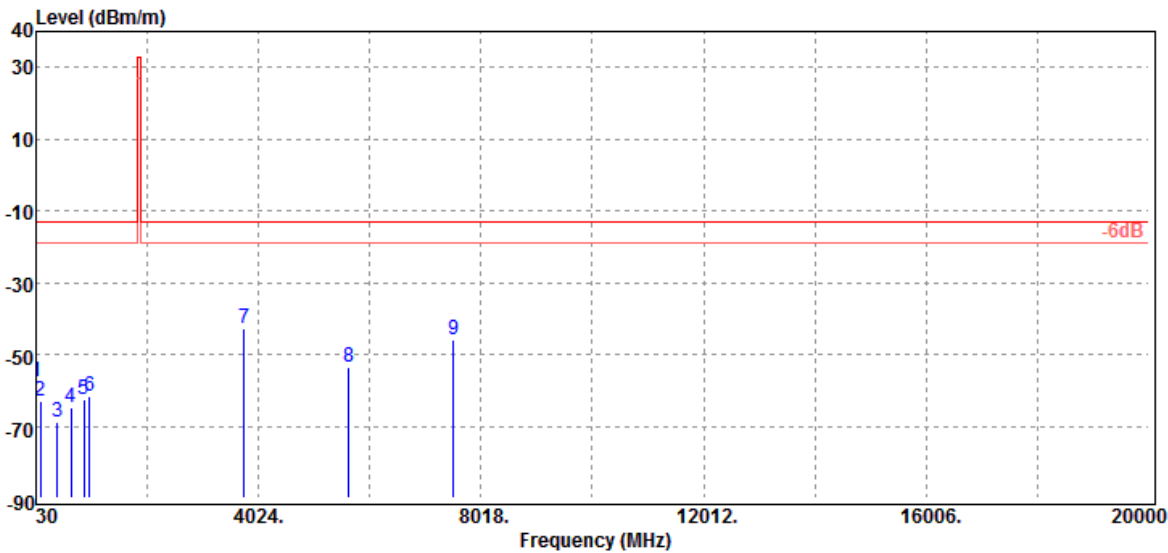

Freq. MHz	ERP/EIRP dBm	SG Output Level dBm	Antenna Gain dBd/dBi	Cable Loss dB	Limit dBm	Margin dB
30.00	-57.56	-27.06	-30.05	-0.45	-13.00	-44.56
102.75	-63.05	-53.31	-8.91	-0.83	-13.00	-50.05
419.94	-69.03	-65.48	-1.85	-1.70	-13.00	-56.03
663.41	-64.78	-61.16	-1.45	-2.17	-13.00	-51.78
885.54	-62.35	-58.58	-1.25	-2.52	-13.00	-49.35
988.36	-61.53	-57.46	-1.42	-2.66	-13.00	-48.53
3760.00	-42.88	-49.73	12.42	-5.69	-13.00	-29.88
5640.00	-53.70	-60.06	13.26	-7.11	-13.00	-40.70
7520.00	-45.79	-48.62	10.84	-8.12	-13.00	-32.79

Unless otherwise stated the results shown in this test report refer only to the sample(s) tested and such sample(s) are retained for 90 days only.

除非另有說明，此報告結果僅對測試之樣品負責，同時此樣品僅保留90天。本報告未經本公司書面許可，不可部份複製。

This document is issued by the Company subject to its General Conditions of Service printed overleaf, available on request or accessible at www.sgs.com/terms_and_conditions.htm and for electronic format documents, subject to Terms and Conditions for Electronic Documents at www.sgs.com/terms_e-document.htm. Attention is drawn to the limitation of liability, indemnification and jurisdiction issues defined therein. Any holder of this document is advised that information contained hereon reflects the Company's findings at the time of its intervention only and within the limits of Client's instructions, if any. The Company's sole responsibility is to its Client and this document does not exonerate parties to a transaction from exercising all their rights and obligations under the transaction documents. This document cannot be reproduced except in full, without prior written approval of the Company. Any unauthorized alteration, forgery or falsification of the content or appearance of this document is unlawful and offenders may be prosecuted to the fullest extent of the law.

Operation Band :LTE B2 20 QPSK 1.50
Fundamental Frequency :1900 MHz
Operation Mode :Tx CH High
EUT Pol. :E1 Plan

Test Date :2019-04-12
Temp./Humi. :21/53
Engineer :Jerry
Measurement Antenna Pol. :VERTICAL

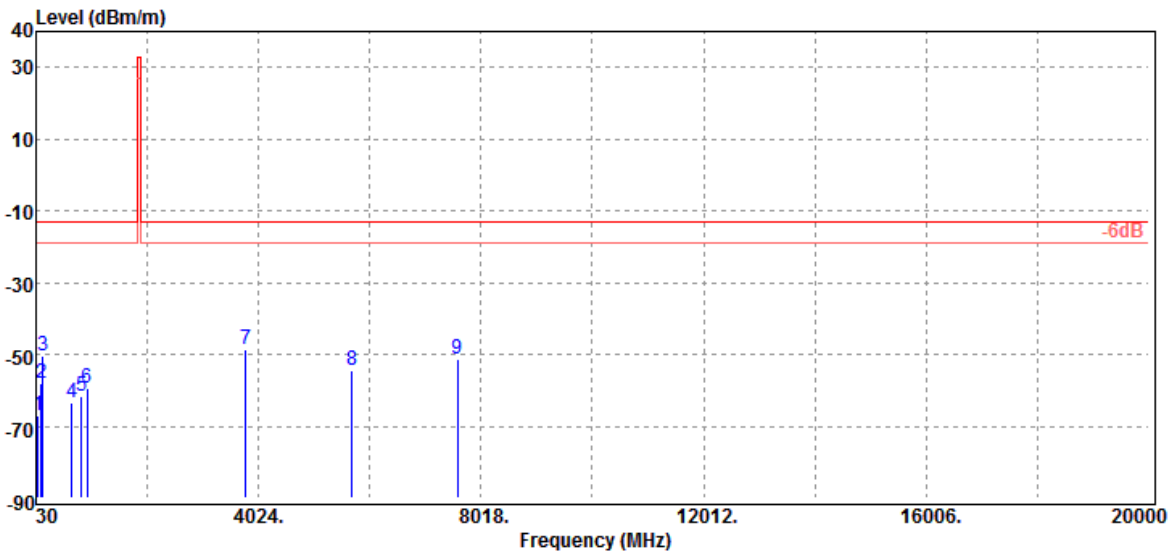

Freq. MHz	ERP/EIRP dBm	SG Output Level dBm	Antenna Gain dBd/dBi	Cable Loss dB	Limit dBm	Margin dB
66.86	-66.91	-56.28	-9.96	-0.68	-13.00	-53.91
122.15	-58.08	-46.60	-10.56	-0.91	-13.00	-45.08
148.34	-50.53	-42.21	-7.31	-1.00	-13.00	-37.53
679.90	-63.26	-59.81	-1.25	-2.20	-13.00	-50.26
846.74	-61.64	-57.82	-1.35	-2.46	-13.00	-48.64
951.50	-59.30	-55.50	-1.18	-2.62	-13.00	-46.30
3800.00	-48.42	-55.29	12.50	-5.76	-13.00	-35.42
5700.00	-54.61	-60.84	13.10	-7.05	-13.00	-41.61
7600.00	-51.11	-54.30	11.20	-8.24	-13.00	-38.11

Unless otherwise stated the results shown in this test report refer only to the sample(s) tested and such sample(s) are retained for 90 days only.

除非另有說明，此報告結果僅對測試之樣品負責，同時此樣品僅保留90天。本報告未經本公司書面許可，不可部份複製。

This document is issued by the Company subject to its General Conditions of Service printed overleaf, available on request or accessible at www.sgs.com/terms_and_conditions.htm and for electronic format documents, subject to Terms and Conditions for Electronic Documents at www.sgs.com/terms_e-document.htm. Attention is drawn to the limitation of liability, indemnification and jurisdiction issues defined therein. Any holder of this document is advised that information contained hereon reflects the Company's findings at the time of its intervention only and within the limits of Client's instructions, if any. The Company's sole responsibility is to its Client and this document does not exonerate parties to a transaction from exercising all their rights and obligations under the transaction documents. This document cannot be reproduced except in full, without prior written approval of the Company. Any unauthorized alteration, forgery or falsification of the content or appearance of this document is unlawful and offenders may be prosecuted to the fullest extent of the law.

Operation Band :LTE B2 20 QPSK 1.50
 Fundamental Frequency :1900 MHz
 Operation Mode :Tx CH High
 EUT Pol. :E1 Plan

Test Date :2019-04-12
 Temp./Humi. :21/53
 Engineer :Jerry
 Measurement Antenna Pol. :HORIZONTAL

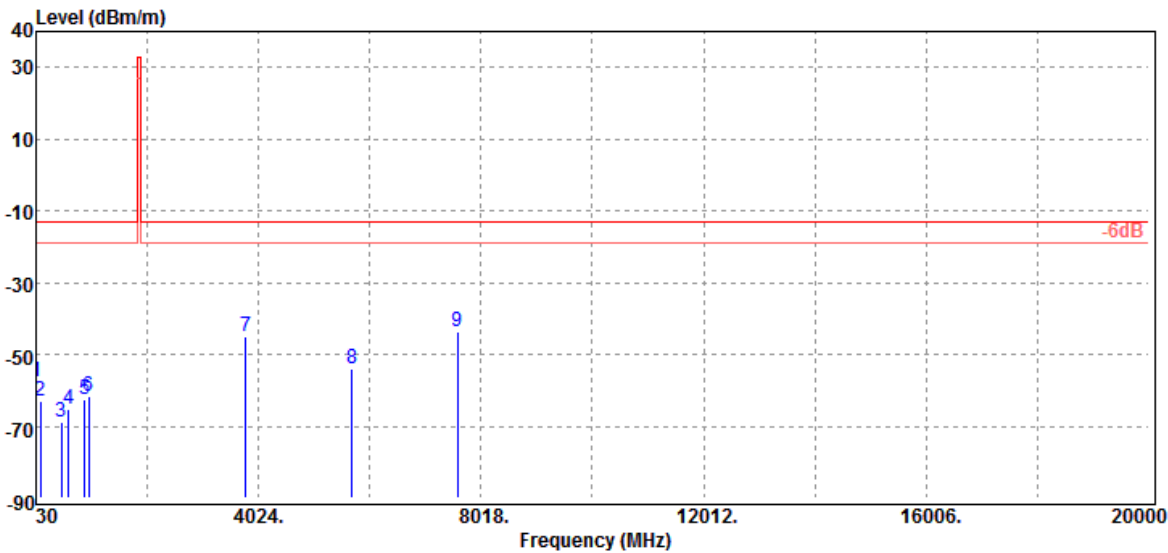

Freq. MHz	ERP/EIRP dBm	SG Output Level dBm	Antenna Gain dBd/dBi	Cable Loss dB	Limit dBm	Margin dB
30.00	-57.44	-26.94	-30.05	-0.45	-13.00	-44.44
102.75	-63.21	-53.47	-8.91	-0.83	-13.00	-50.21
479.11	-68.65	-64.40	-2.43	-1.82	-13.00	-55.65
619.76	-65.14	-61.71	-1.35	-2.08	-13.00	-52.14
904.94	-62.52	-58.72	-1.25	-2.55	-13.00	-49.52
983.51	-61.66	-57.66	-1.35	-2.65	-13.00	-48.66
3800.00	-45.18	-52.04	12.50	-5.76	-13.00	-32.18
5700.00	-54.23	-60.46	13.10	-7.05	-13.00	-41.23
7600.00	-43.75	-46.95	11.20	-8.24	-13.00	-30.75

Unless otherwise stated the results shown in this test report refer only to the sample(s) tested and such sample(s) are retained for 90 days only.

除非另有說明，此報告結果僅對測試之樣品負責，同時此樣品僅保留90天。本報告未經本公司書面許可，不可部份複製。

This document is issued by the Company subject to its General Conditions of Service printed overleaf, available on request or accessible at www.sgs.com/terms_and_conditions.htm and for electronic format documents, subject to Terms and Conditions for Electronic Documents at www.sgs.com/terms_e-document.htm. Attention is drawn to the limitation of liability, indemnification and jurisdiction issues defined therein. Any holder of this document is advised that information contained hereon reflects the Company's findings at the time of its intervention only and within the limits of Client's instructions, if any. The Company's sole responsibility is to its Client and this document does not exonerate parties to a transaction from exercising all their rights and obligations under the transaction documents. This document cannot be reproduced except in full, without prior written approval of the Company. Any unauthorized alteration, forgery or falsification of the content or appearance of this document is unlawful and offenders may be prosecuted to the fullest extent of the law.

10. FREQUENCY STABILITY MEASUREMENT

10.1. Standard Applicable

The frequency stability shall be sufficient to ensure that the fundamental emission stays within the authorized frequency block.

10.2. Test Set-up

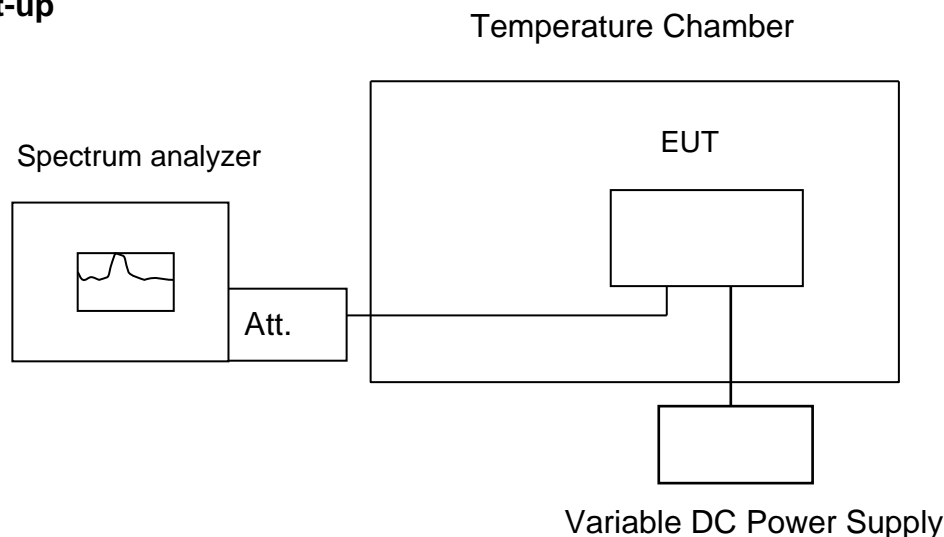

Note: Measurement setup for testing on Antenna connector

10.3. Measurement Procedure

The equipment under test was connected to an external AC or DC power supply and input rated voltage. RF output was connected to a frequency counter or spectrum analyzer via feed through attenuators. The EUT was placed inside the temperature chamber. Set the spectrum analyzer RBW low enough to obtain the desired frequency resolution and measure EUT 25°C operating frequency as reference frequency. Turn EUT off and set the chamber temperature to -30°C. After the temperature stabilized for approximately 30 minutes recorded the frequency. Repeat step measure with 10°C increased per stage until the highest temperature of +50°C reached.

Set chamber temperature to 25°C. Use a variable AC power supply / DC power source to power the EUT and set the voltage to rated voltage. Set the spectrum analyzer RBW low enough to obtain the desired frequency resolution and recorded the frequency.

Reduce the input voltage to specify extreme voltage variation (+/- 15%) and endpoint as declared by the manufacturer, record the maximum frequency change.

Unless otherwise stated the results shown in this test report refer only to the sample(s) tested and such sample(s) are retained for 90 days only.

除非另有說明，此報告結果僅對測試之樣品負責，同時此樣品僅保留90天。本報告未經本公司書面許可，不可部份複製。

This document is issued by the Company subject to its General Conditions of Service printed overleaf, available on request or accessible at www.sgs.com/terms_and_conditions.htm and for electronic format documents, subject to Terms and Conditions for Electronic Documents at www.sgs.com/terms_e-document.htm. Attention is drawn to the limitation of liability, indemnification and jurisdiction issues defined therein. Any holder of this document is advised that information contained hereon reflects the Company's findings at the time of its intervention only and within the limits of Client's instructions, if any. The Company's sole responsibility is to its Client and this document does not exonerate parties to a transaction from exercising all their rights and obligations under the transaction documents. This document cannot be reproduced except in full, without prior written approval of the Company. Any unauthorized alteration, forgery or falsification of the content or appearance of this document is unlawful and offenders may be prosecuted to the fullest extent of the law.

10.4. Measurement Equipment Used

EQUIPMENT TYPE	MFR	MODEL NUMBER	SERIAL NUMBER	LAST CAL.	CAL DUE.
DC Power Supply	Agilent	E3640A	KR93300208	Aug. 15th, 2018	Aug. 14th, 2019
EXA Spectrum Analyzer	KEYSIGHT	N9010A	MY57120290	Feb. 13th, 2019	Feb. 12th, 2020
Radio Communication Analyser	Anritsu	MT8820C	6201465317	Jan. 16th, 2019	Jan. 15th, 2020
Thermostatic/Hrgrosatic Chamber	TAICHY	MHG-150LF	930619	Oct. 08th, 2018	Oct. 07th, 2019
Splitter	RF-LAMBAD	RFLT2W1G18G	11-JSPD022-013	Feb. 26th, 2019	Feb. 25th, 2020
DC Block	Mini-Circuits	BLK-18-S+	31129(1)	Feb. 26th, 2019	Feb. 25th, 2020
Attenuator	Mini-Circuit	BW-S10W2+	1	Feb. 26th, 2019	Feb. 25th, 2020
Radio Communication Analyser	Anritsu	MT8815B	6200711454	Apr. 1st, 2019	Mar. 31th, 2020

Unless otherwise stated the results shown in this test report refer only to the sample(s) tested and such sample(s) are retained for 90 days only.

除非另有說明，此報告結果僅對測試之樣品負責，同時此樣品僅保留90天。本報告未經本公司書面許可，不可部份複製。

This document is issued by the Company subject to its General Conditions of Service printed overleaf, available on request or accessible at www.sgs.com/terms_and_conditions.htm and for electronic format documents, subject to Terms and Conditions for Electronic Documents at www.sgs.com/terms_e-document.htm. Attention is drawn to the limitation of liability, indemnification and jurisdiction issues defined therein. Any holder of this document is advised that information contained hereon reflects the Company's findings at the time of its intervention only and within the limits of Client's instructions, if any. The Company's sole responsibility is to its Client and this document does not exonerate parties to a transaction from exercising all their rights and obligations under the transaction documents. This document cannot be reproduced except in full, without prior written approval of the Company. Any unauthorized alteration, forgery or falsification of the content or appearance of this document is unlawful and offenders may be prosecuted to the fullest extent of the law.

10.5. Measurement Result

GPRS 1900 Mid Channel 1880 MHz				
Limit: +/- 2.5 ppm				
Vdc	Temp. (°C)	Freq. (MHz)	Delta (Hz)	Limit (Hz)
FREQUENCY ERROR vs. VOLTAGE				
4.24	20	1880.000003	3	4700
3.85	20	1879.999996	-4	4700
3.5	20	1880.000008	8	4700
2.95 (End point)	20	1879.999995	-5	4700
FREQUENCY ERROR vs. Temp.				
3.85	50	1880.000005	5	4700
3.85	40	1880.000001	1	4700
3.85	30	1879.999998	-2	4700
3.85	20	1880.000007	7	4700
3.85	10	1880.000006	6	4700
3.85	0	1880.000001	10	4700
3.85	-10	1880.000003	3	4700
3.85	-20	1879.999991	-9	4700
3.85	-30	1879.999998	-2	4700

Unless otherwise stated the results shown in this test report refer only to the sample(s) tested and such sample(s) are retained for 90 days only.

除非另有說明，此報告結果僅對測試之樣品負責，同時此樣品僅保留90天。本報告未經本公司書面許可，不可部份複製。

This document is issued by the Company subject to its General Conditions of Service printed overleaf, available on request or accessible at www.sgs.com/terms_and_conditions.htm and for electronic format documents, subject to Terms and Conditions for Electronic Documents at www.sgs.com/terms_e-document.htm. Attention is drawn to the limitation of liability, indemnification and jurisdiction issues defined therein. Any holder of this document is advised that information contained hereon reflects the Company's findings at the time of its intervention only and within the limits of Client's instructions, if any. The Company's sole responsibility is to its Client and this document does not exonerate parties to a transaction from exercising all their rights and obligations under the transaction documents. This document cannot be reproduced except in full, without prior written approval of the Company. Any unauthorized alteration, forgery or falsification of the content or appearance of this document is unlawful and offenders may be prosecuted to the fullest extent of the law.

WCDMA II Mid Channel 1880 MHz				
Limit: +/- 2.5 ppm				
Vdc	Temp. (°C)	Freq. (MHz)	Delta (Hz)	Limit (Hz)
FREQUENCY ERROR vs. VOLTAGE				
4.24	20	1879.999985	-15	4700
3.85	20	1879.999992	-8	4700
3.5	20	1880.000004	4	4700
2.95 (End point)	20	1879.999997	-3	4700
FREQUENCY ERROR vs. Temp.				
3.85	50	1879.999998	-2	4700
3.85	40	1880.000007	7	4700
3.85	30	1879.999994	-6	4700
3.85	20	1880.000003	3	4700
3.85	10	1880.000008	8	4700
3.85	0	1880.000011	11	4700
3.85	-10	1879.999992	-8	4700
3.85	-20	1880.000012	12	4700
3.85	-30	1880.000017	17	4700

Unless otherwise stated the results shown in this test report refer only to the sample(s) tested and such sample(s) are retained for 90 days only.

除非另有說明，此報告結果僅對測試之樣品負責，同時此樣品僅保留90天。本報告未經本公司書面許可，不可部份複製。

This document is issued by the Company subject to its General Conditions of Service printed overleaf, available on request or accessible at www.sgs.com/terms_and_conditions.htm and for electronic format documents, subject to Terms and Conditions for Electronic Documents at www.sgs.com/terms_e-document.htm. Attention is drawn to the limitation of liability, indemnification and jurisdiction issues defined therein. Any holder of this document is advised that information contained hereon reflects the Company's findings at the time of its intervention only and within the limits of Client's instructions, if any. The Company's sole responsibility is to its Client and this document does not exonerate parties to a transaction from exercising all their rights and obligations under the transaction documents. This document cannot be reproduced except in full, without prior written approval of the Company. Any unauthorized alteration, forgery or falsification of the content or appearance of this document is unlawful and offenders may be prosecuted to the fullest extent of the law.

Reference Freq.:		LTE B2 Mid Channel			1880 MHz 20M QPSK CH 18900
Power Supply Vdc	Temp. (°C)	Freq. (MHz)	Delta (Hz)	Limit = +/- 2.5 ppm (Hz)	
Freq. ERROR vs. VOLTAGE					
4.24	25	1880.000005	5	4700	
3.85	25	1879.999996	-4	4700	
3.5	25	1880.000003	3	4700	
2.95 (End Point)	25	1880.000006	6	4700	
Freq. ERROR vs. Temp.					
3.85	-30	1879.999985	-15	4700	
3.85	-20	1879.999992	-8	4700	
3.85	-10	1879.999994	-6	4700	
3.85	0	1880.000003	3	4700	
3.85	10	1880.000008	8	4700	
3.85	20	1879.999997	-3	4700	
3.85	30	1880.000010	10	4700	
3.85	40	1880.000002	2	4700	
3.85	50	1880.000007	7	4700	

Note: The battery is rated 3.85Vdc.

Unless otherwise stated the results shown in this test report refer only to the sample(s) tested and such sample(s) are retained for 90 days only.

除非另有說明，此報告結果僅對測試之樣品負責，同時此樣品僅保留90天。本報告未經本公司書面許可，不可部份複製。

This document is issued by the Company subject to its General Conditions of Service printed overleaf, available on request or accessible at www.sgs.com/terms_and_conditions.htm and for electronic format documents, subject to Terms and Conditions for Electronic Documents at www.sgs.com/terms_e-document.htm. Attention is drawn to the limitation of liability, indemnification and jurisdiction issues defined therein. Any holder of this document is advised that information contained hereon reflects the Company's findings at the time of its intervention only and within the limits of Client's instructions, if any. The Company's sole responsibility is to its Client and this document does not exonerate parties to a transaction from exercising all their rights and obligations under the transaction documents. This document cannot be reproduced except in full, without prior written approval of the Company. Any unauthorized alteration, forgery or falsification of the content or appearance of this document is unlawful and offenders may be prosecuted to the fullest extent of the law.

11. PEAK TO AVERAGE RATIO

11.1. Standard Applicable

The peak-to-average ratio (PAR) of the transmission may not exceed 13dB.

11.2. Test SET-UP

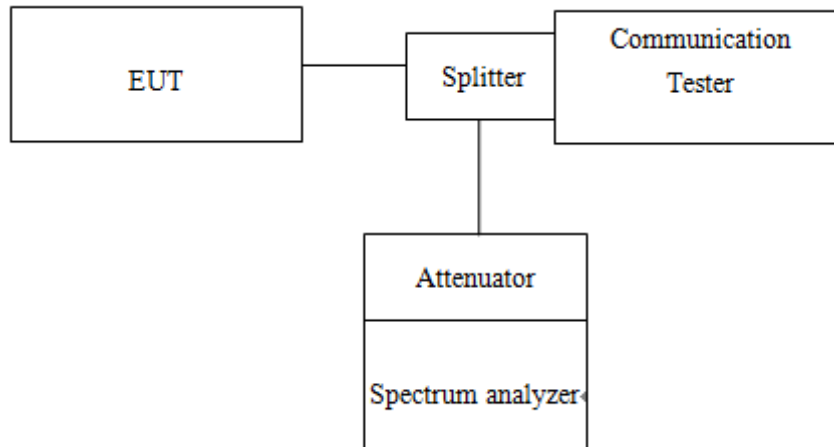

11.3. Measurement Procedure

1. KDB 971168 D01 is employed as the following procedure is proper adjusted accordingly:
2. Set resolution/measurement bandwidth \geq signal's occupied bandwidth; & internal =1ms
3. Set the number of counts to a value that stabilizes the measured CCDF curve.

Unless otherwise stated the results shown in this test report refer only to the sample(s) tested and such sample(s) are retained for 90 days only.

除非另有說明，此報告結果僅對測試之樣品負責，同時此樣品僅保留90天。本報告未經本公司書面許可，不可部份複製。

This document is issued by the Company subject to its General Conditions of Service printed overleaf, available on request or accessible at www.sgs.com/terms_and_conditions.htm and for electronic format documents, subject to Terms and Conditions for Electronic Documents at www.sgs.com/terms_e-document.htm. Attention is drawn to the limitation of liability, indemnification and jurisdiction issues defined therein. Any holder of this document is advised that information contained hereon reflects the Company's findings at the time of its intervention only and within the limits of Client's instructions, if any. The Company's sole responsibility is to its Client and this document does not exonerate parties to a transaction from exercising all their rights and obligations under the transaction documents. This document cannot be reproduced except in full, without prior written approval of the Company. Any unauthorized alteration, forgery or falsification of the content or appearance of this document is unlawful and offenders may be prosecuted to the fullest extent of the law.

11.4. Measurement Equipment Used

EQUIPMENT TYPE	MFR	MODEL NUMBER	SERIAL NUMBER	LAST CAL.	CAL DUE.
DC Power Supply	Agilent	E3640A	KR93300208	Aug. 15th, 2018	Aug. 14th, 2019
EXA Spectrum Analyzer	KEYSIGHT	N9010A	MY57120290	Feb. 13th, 2019	Feb. 12th, 2020
Radio Communication Analyzer	Anritsu	MT8820C	6201465317	Jan. 16th, 2019	Jan. 15th, 2020
Thermostatic/Hrgrosatic Chamber	TAICHY	MHG-150LF	930619	Oct. 08th, 2018	Oct. 07th, 2019
Splitter	RF-LAMBAD	RFLT2W1G18G	11-JSPD022-013	Feb. 26th, 2019	Feb. 25th, 2020
DC Block	Mini-Circuits	BLK-18-S+	31129(1)	Feb. 26th, 2019	Feb. 25th, 2020
Attenuator	Mini-Circuit	BW-S10W2+	1	Feb. 26th, 2019	Feb. 25th, 2020
Radio Communication Analyzer	Anritsu	MT8815B	6200711454	Apr. 1st, 2019	Mar. 31th, 2020

Unless otherwise stated the results shown in this test report refer only to the sample(s) tested and such sample(s) are retained for 90 days only.

除非另有說明，此報告結果僅對測試之樣品負責，同時此樣品僅保留90天。本報告未經本公司書面許可，不可部份複製。

This document is issued by the Company subject to its General Conditions of Service printed overleaf, available on request or accessible at www.sgs.com/terms_and_conditions.htm and for electronic format documents, subject to Terms and Conditions for Electronic Documents at www.sgs.com/terms_e-document.htm. Attention is drawn to the limitation of liability, indemnification and jurisdiction issues defined therein. Any holder of this document is advised that information contained hereon reflects the Company's findings at the time of its intervention only and within the limits of Client's instructions, if any. The Company's sole responsibility is to its Client and this document does not exonerate parties to a transaction from exercising all their rights and obligations under the transaction documents. This document cannot be reproduced except in full, without prior written approval of the Company. Any unauthorized alteration, forgery or falsification of the content or appearance of this document is unlawful and offenders may be prosecuted to the fullest extent of the law.

11.5. Measurement Result

Tabular Results:

Freq. (MHz)	CH	Peak-to-Average		Freq. (MHz)	CH	Peak-to-Average Ratio (dB)		
		GSM 1900	GPRS 1900			WCDMA II	HSDPA II	HSUPA II
1850.2	512	8.36	8.66	1852.4	9262	2.99	3.00	2.99
1880	661	8.45	9.4	1880	9400	3.30	3.28	3.27
1909.8	810	9.68	9.78	1907.6	9538	3.03	3.09	3.12

LTE BAND 2							
Channel bandwidth: 1.4MHz				Channel bandwidth: 3MHz			
Freq. (MHz)	CH	PAPR (dB)		Freq. (MHz)	CH	PAPR (dB)	
		16QAM	Limit			16QAM	Limit
1850.7	18607	5.84	13	1851.5	18615	6.05	13
1880.0	18900	6.18	13	1880.0	18900	6.35	13
1909.3	19193	5.89	13	1908.5	19185	6.24	13

LTE BAND 2							
Channel bandwidth: 5MHz				Channel bandwidth: 10MHz			
Freq. (MHz)	CH	PAPR (dB)		Freq. (MHz)	CH	PAPR (dB)	
		16QAM	Limit			16QAM	Limit
1852.5	18625	5.85	13	1855.0	18650	5.86	13
1880.0	18900	6.25	13	1880.0	18900	6.19	13
1907.5	19175	6.12	13	1905.0	19150	6.09	13

LTE BAND 2							
Channel bandwidth: 15MHz				Channel bandwidth: 20MHz			
Freq. (MHz)	CH	PAPR (dB)		Freq. (MHz)	CH	PAPR (dB)	
		16QAM	Limit			16QAM	Limit
1857.5	18675	6.19	13	1860.0	18700	6.78	13
1880.0	18900	6.34	13	1880.0	18900	6.76	13
1902.5	19125	6.18	13	1900.0	19100	6.69	13

Measurement Results:

Please refer to next page.

Unless otherwise stated the results shown in this test report refer only to the sample(s) tested and such sample(s) are retained for 90 days only.

除非另有說明，此報告結果僅對測試之樣品負責，同時此樣品僅保留90天。本報告未經本公司書面許可，不可部份複製。

This document is issued by the Company subject to its General Conditions of Service printed overleaf, available on request or accessible at www.sgs.com/terms_and_conditions.htm and for electronic format documents, subject to Terms and Conditions for Electronic Documents at www.sgs.com/terms_e-document.htm. Attention is drawn to the limitation of liability, indemnification and jurisdiction issues defined therein. Any holder of this document is advised that information contained hereon reflects the Company's findings at the time of its intervention only and within the limits of Client's instructions, if any. The Company's sole responsibility is to its Client and this document does not exonerate parties to a transaction from exercising all their rights and obligations under the transaction documents. This document cannot be reproduced except in full, without prior written approval of the Company. Any unauthorized alteration, forgery or falsification of the content or appearance of this document is unlawful and offenders may be prosecuted to the fullest extent of the law.

GSM_1900MHz_LowCH512-1850.2

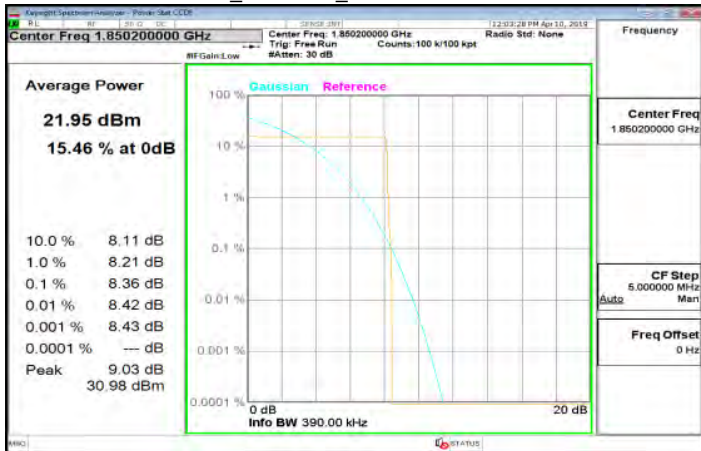

GPRS_1900MHz_LowCH512-1850.2

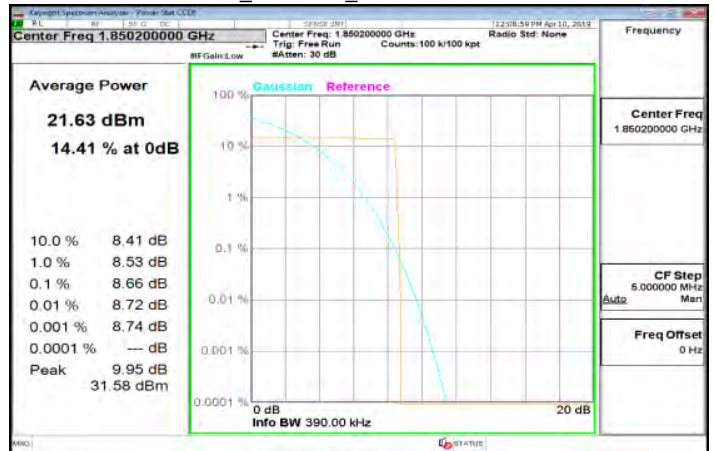

GSM_1900MHz_MidCH661-1880

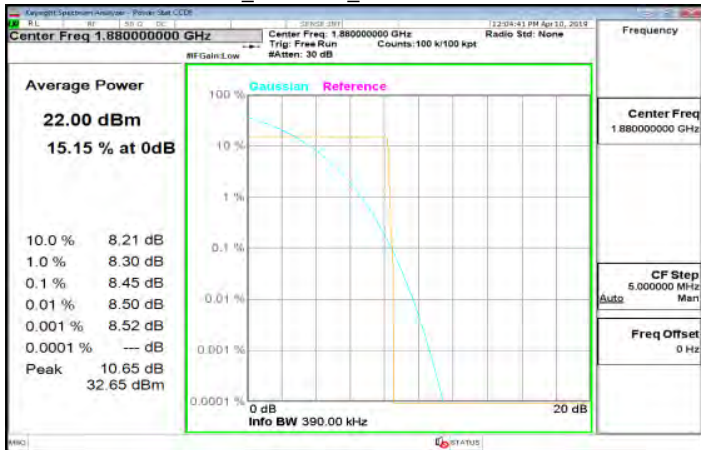

GPRS_1900MHz_MidCH661-1880



GSM_1900MHz_HighCH810-1909.8

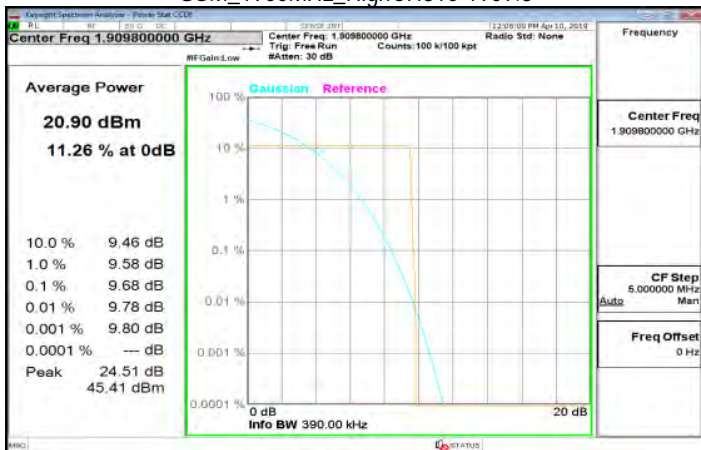

GPRS_1900MHz_HighCH810-1909.8

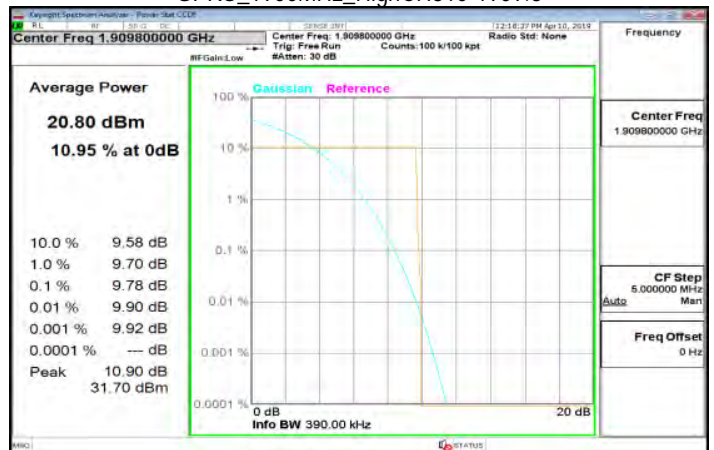

Unless otherwise stated the results shown in this test report refer only to the sample(s) tested and such sample(s) are retained for 90 days only.

除非另有說明，此報告結果僅對測試之樣品負責，同時此樣品僅保留90天。本報告未經本公司書面許可，不可部份複製。

This document is issued by the Company subject to its General Conditions of Service printed overleaf, available on request or accessible at www.sgs.com/terms_and_conditions.htm and for electronic format documents, subject to Terms and Conditions for Electronic Documents at www.sgs.com/terms_e-document.htm. Attention is drawn to the limitation of liability, indemnification and jurisdiction issues defined therein. Any holder of this document is advised that information contained hereon reflects the Company's findings at the time of its intervention only and within the limits of Client's instructions, if any. The Company's sole responsibility is to its Client and this document does not exonerate parties to a transaction from exercising all their rights and obligations under the transaction documents. This document cannot be reproduced except in full, without prior written approval of the Company. Any unauthorized alteration, forgery or falsification of the content or appearance of this document is unlawful and offenders may be prosecuted to the fullest extent of the law.

WCDMA_B2_LowCH9262-1852.4

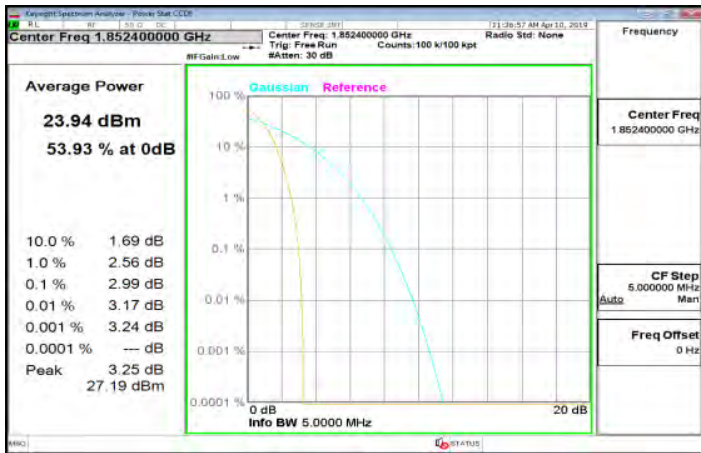

HSDPA_B2_LowCH9262-1852.4

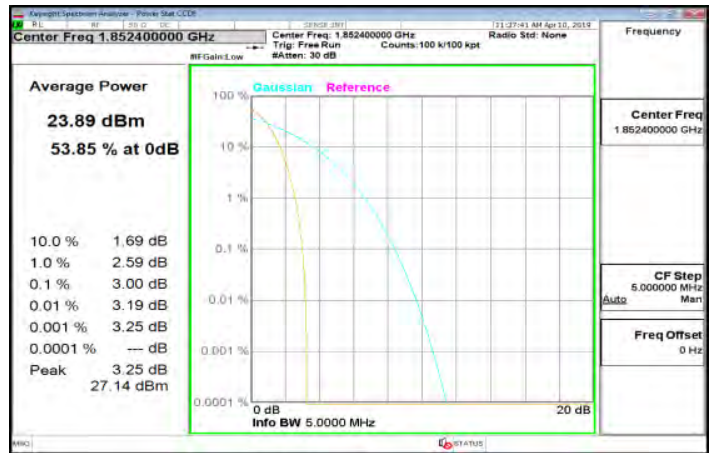

WCDMA_B2_MidCH9400-1880

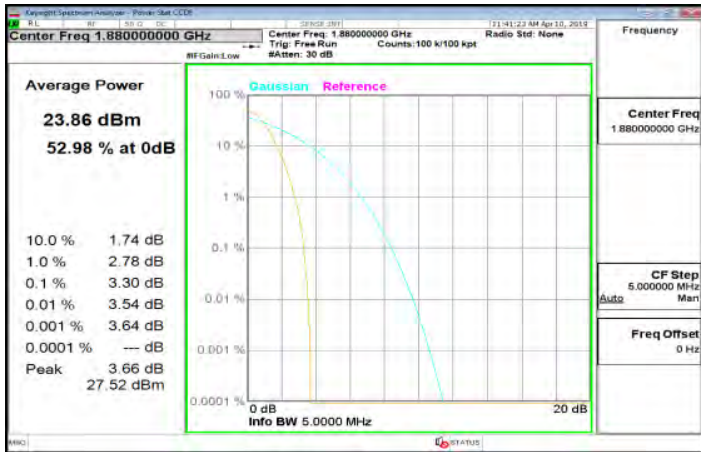

HSDPA_B2_MidCH9400-1880

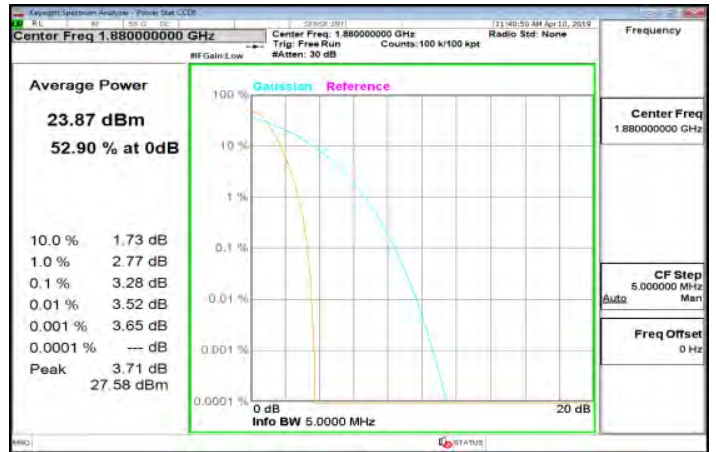

WCDMA_B2_HighCH9538-1907.6

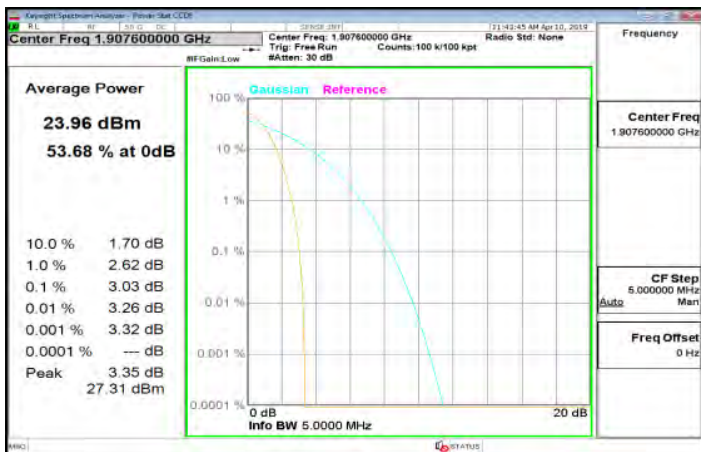

HSDPA_B2_HighCH9538-1907.6

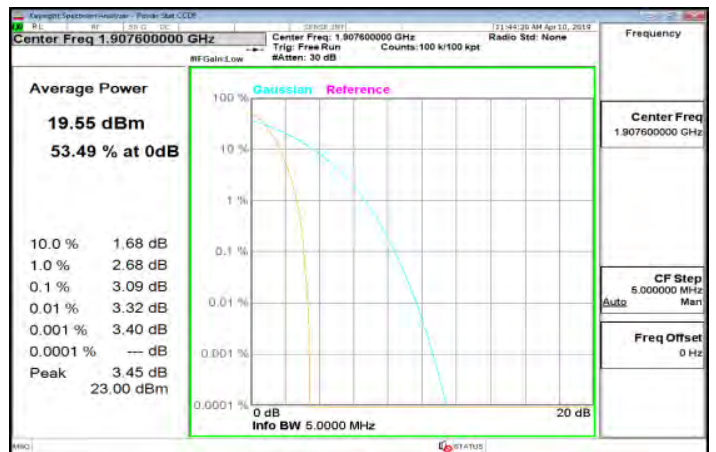

Unless otherwise stated the results shown in this test report refer only to the sample(s) tested and such sample(s) are retained for 90 days only.

除非另有說明，此報告結果僅對測試之樣品負責，同時此樣品僅保留90天。本報告未經本公司書面許可，不可部份複製。

This document is issued by the Company subject to its General Conditions of Service printed overleaf, available on request or accessible at www.sgs.com/terms_and_conditions.htm and for electronic format documents, subject to Terms and Conditions for Electronic Documents at www.sgs.com/terms_e-document.htm. Attention is drawn to the limitation of liability, indemnification and jurisdiction issues defined therein. Any holder of this document is advised that information contained hereon reflects the Company's findings at the time of its intervention only and within the limits of Client's instructions, if any. The Company's sole responsibility is to its Client and this document does not exonerate parties to a transaction from exercising all their rights and obligations under the transaction documents. This document cannot be reproduced except in full, without prior written approval of the Company. Any unauthorized alteration, forgery or falsification of the content or appearance of this document is unlawful and offenders may be prosecuted to the fullest extent of the law.

HSUPA_B2_LowCH9262-1852.4

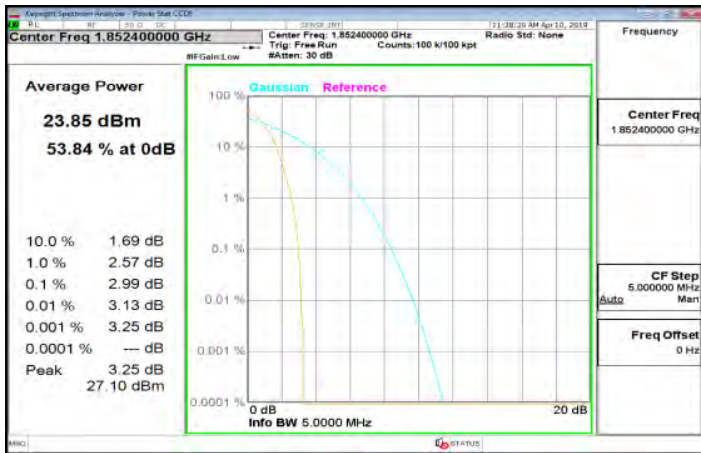

LTE_Band2_1_4MHz_16QAM_6_0_LowCH18607-1850.7

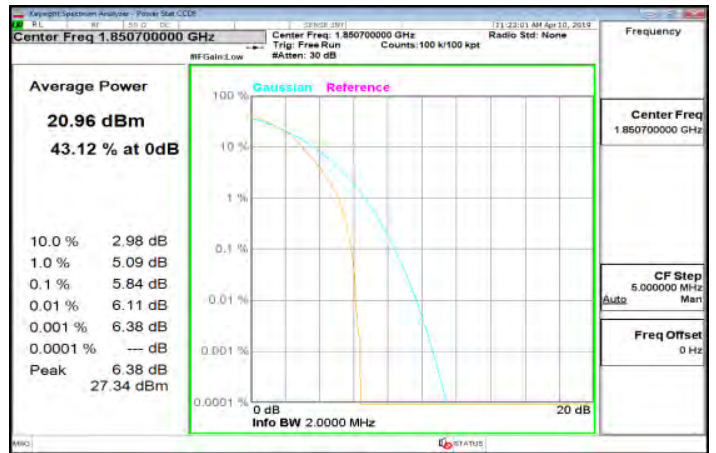

HSUPA_B2_MidCH9400-1880

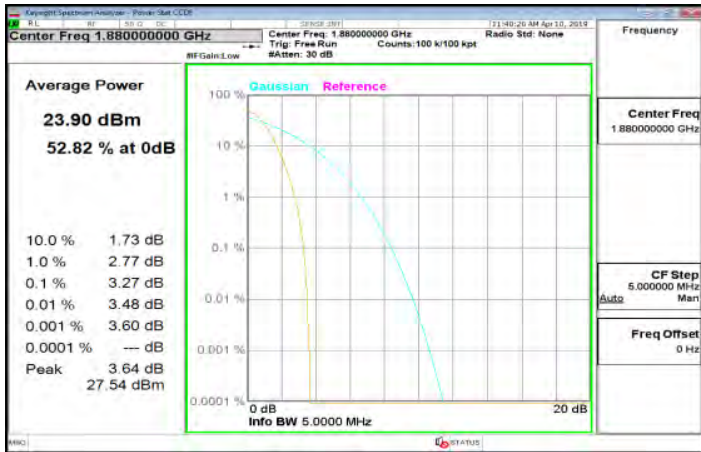

LTE_Band2_1_4MHz_64QAM_6_0_LowCH18607-1850.7

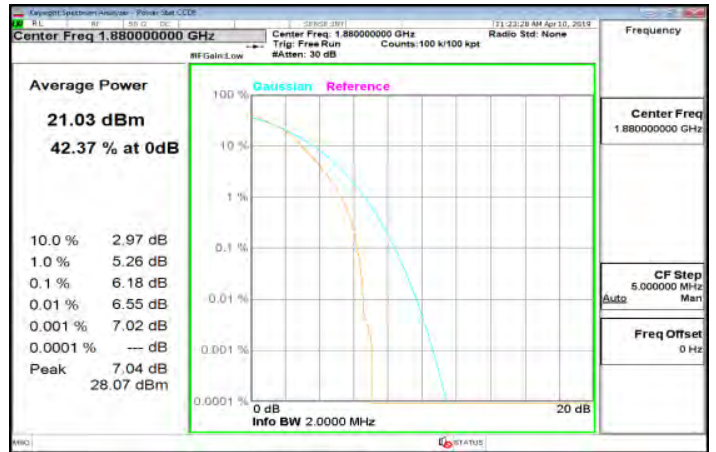

HSUPA_B2_HighCH9538-1907.6

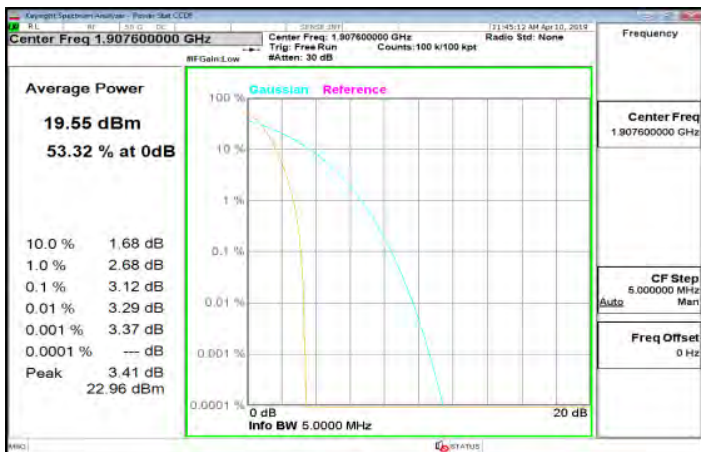

LTE_Band2_1_4MHz_16QAM_6_0_MidCH18900-1880

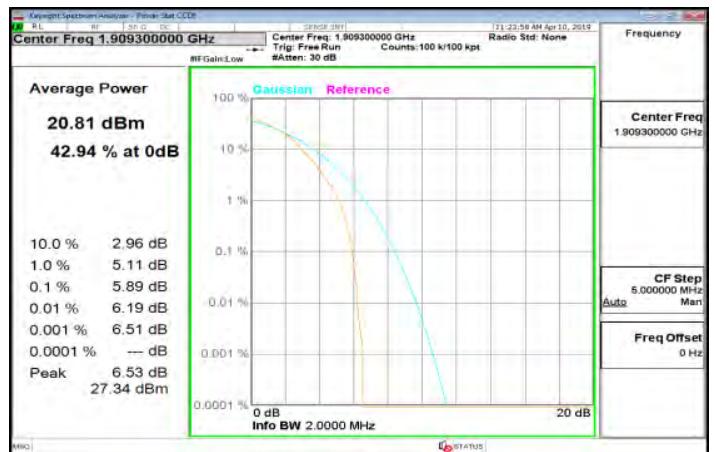

Unless otherwise stated the results shown in this test report refer only to the sample(s) tested and such sample(s) are retained for 90 days only.

除非另有說明，此報告結果僅對測試之樣品負責，同時此樣品僅保留90天。本報告未經本公司書面許可，不可部份複製。

This document is issued by the Company subject to its General Conditions of Service printed overleaf, available on request or accessible at www.sgs.com/terms_and_conditions.htm and for electronic format documents, subject to Terms and Conditions for Electronic Documents at www.sgs.com/terms_e-document.htm. Attention is drawn to the limitation of liability, indemnification and jurisdiction issues defined therein. Any holder of this document is advised that information contained hereon reflects the Company's findings at the time of its intervention only and within the limits of Client's instructions, if any. The Company's sole responsibility is to its Client and this document does not exonerate parties to a transaction from exercising all their rights and obligations under the transaction documents. This document cannot be reproduced except in full, without prior written approval of the Company. Any unauthorized alteration, forgery or falsification of the content or appearance of this document is unlawful and offenders may be prosecuted to the fullest extent of the law.

LTE_Band2_3MHz_16QAM_15_0_LowCH18615-1851.5

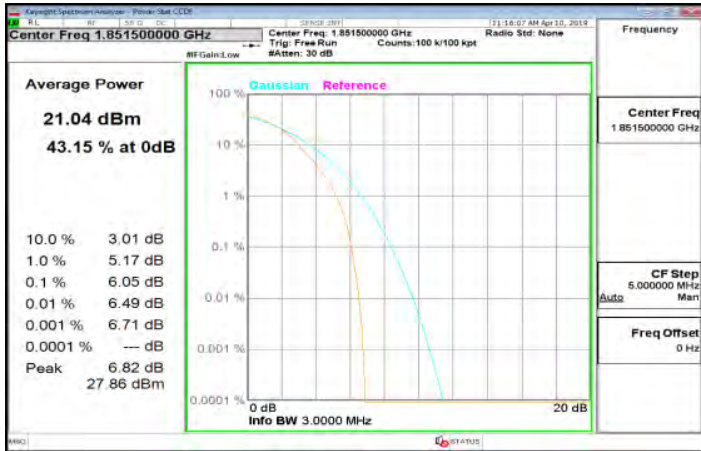

LTE_Band2_5MHz_16QAM_25_0_LowCH18625-1852.5

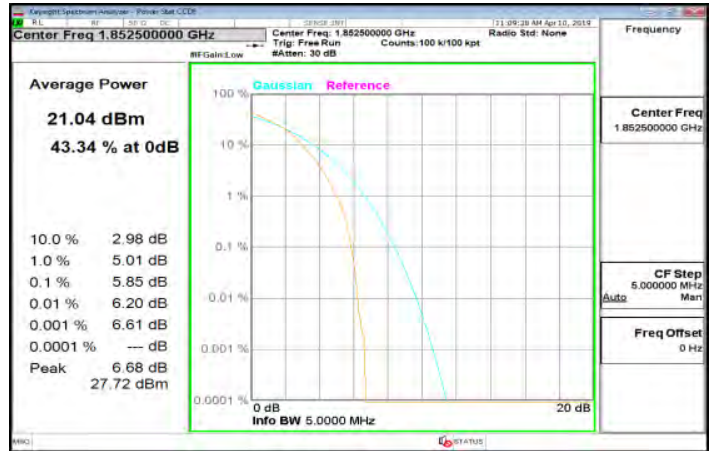

LTE_Band2_3MHz_64QAM_15_0_LowCH18615-1851.5

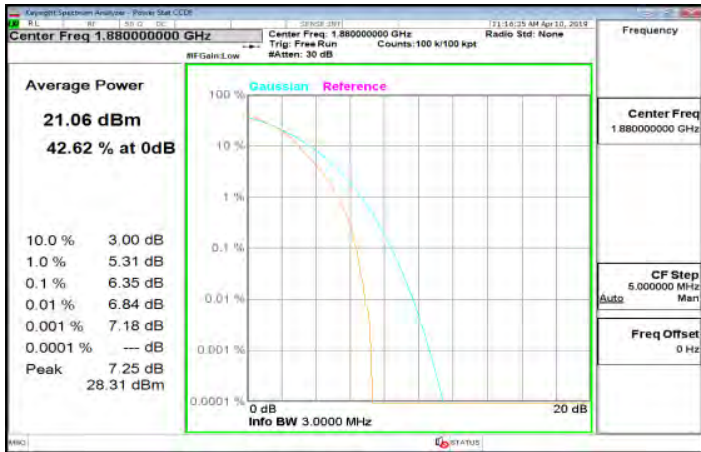

LTE_Band2_5MHz_64QAM_25_0_LowCH18625-1852.5

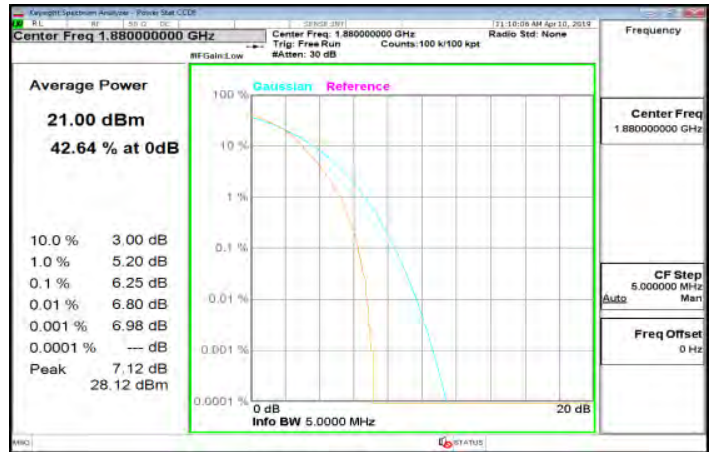

LTE_Band2_3MHz_16QAM_15_0_MidCH1890-1880

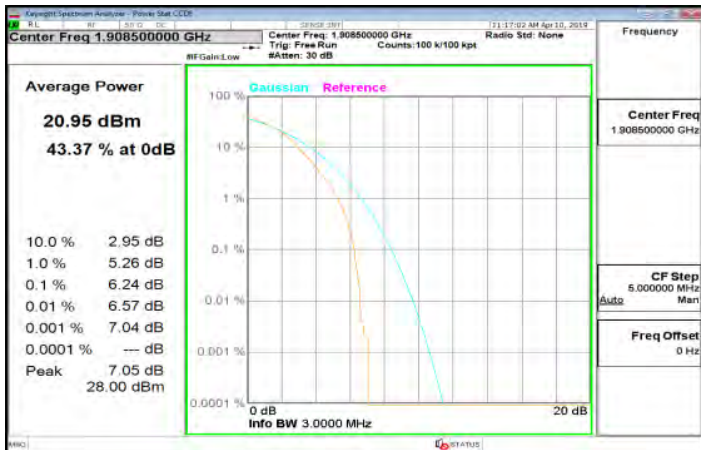

LTE_Band2_5MHz_16QAM_25_0_MidCH1890-1880

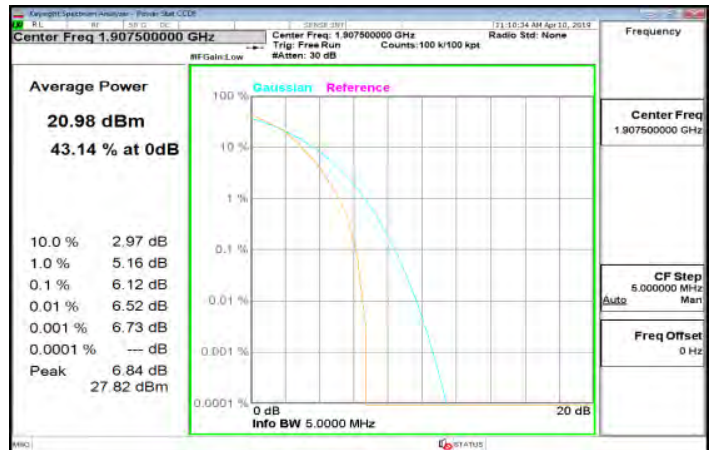

Unless otherwise stated the results shown in this test report refer only to the sample(s) tested and such sample(s) are retained for 90 days only.

除非另有說明，此報告結果僅對測試之樣品負責，同時此樣品僅保留90天。本報告未經本公司書面許可，不可部份複製。

This document is issued by the Company subject to its General Conditions of Service printed overleaf, available on request or accessible at www.sgs.com/terms_and_conditions.htm and for electronic format documents, subject to Terms and Conditions for Electronic Documents at www.sgs.com/terms_e-document.htm. Attention is drawn to the limitation of liability, indemnification and jurisdiction issues defined therein. Any holder of this document is advised that information contained hereon reflects the Company's findings at the time of its intervention only and within the limits of Client's instructions, if any. The Company's sole responsibility is to its Client and this document does not exonerate parties to a transaction from exercising all their rights and obligations under the transaction documents. This document cannot be reproduced except in full, without prior written approval of the Company. Any unauthorized alteration, forgery or falsification of the content or appearance of this document is unlawful and offenders may be prosecuted to the fullest extent of the law.

LTE_Band2_10MHz_16QAM_50_0_LowCH18650-1855

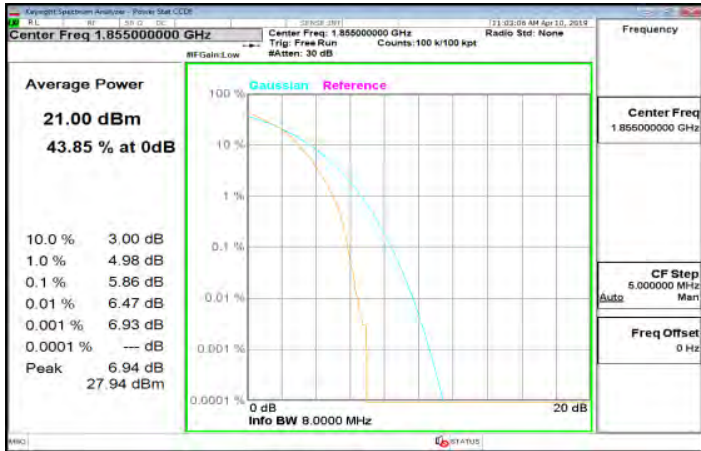

LTE_Band2_15MHz_16QAM_75_0_LowCH18675-1857.5

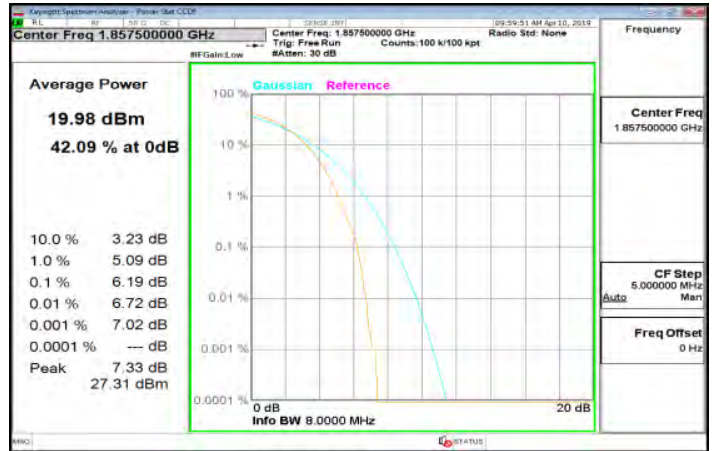

LTE_Band2_10MHz_64QAM_50_0_LowCH18650-1855

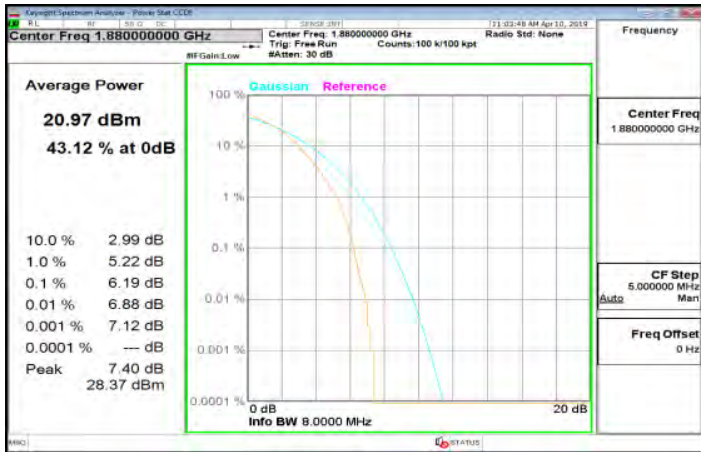

LTE_Band2_15MHz_64QAM_75_0_LowCH18675-1857.5

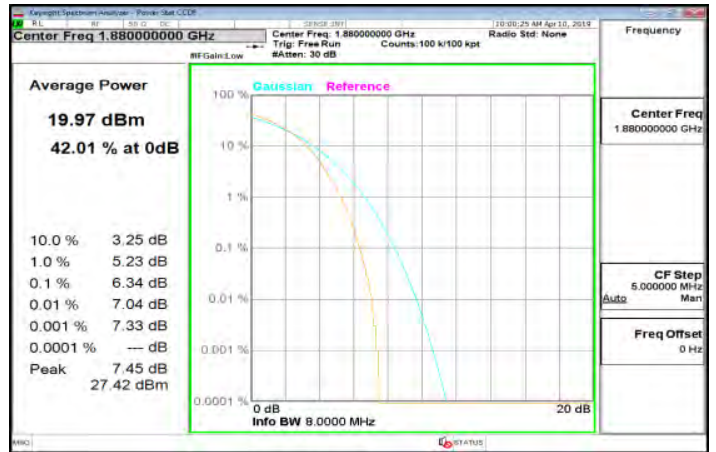

LTE_Band2_10MHz_16QAM_50_0_MidCH18900-1880

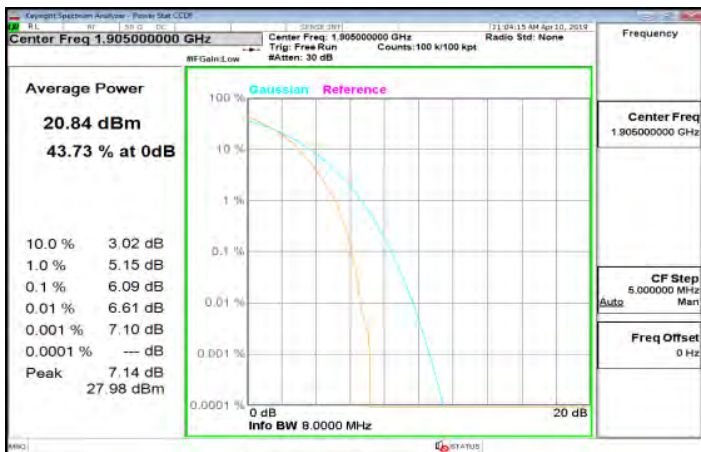

LTE_Band2_15MHz_16QAM_75_0_MidCH18900-1880

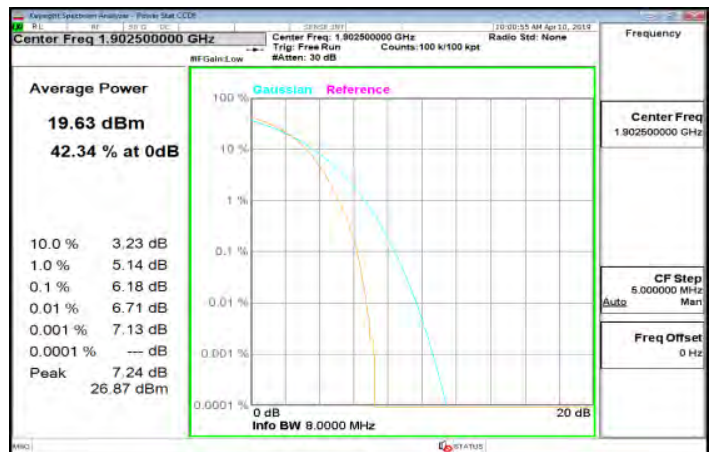

Unless otherwise stated the results shown in this test report refer only to the sample(s) tested and such sample(s) are retained for 90 days only.

除非另有說明，此報告結果僅對測試之樣品負責，同時此樣品僅保留90天。本報告未經本公司書面許可，不可部份複製。

This document is issued by the Company subject to its General Conditions of Service printed overleaf, available on request or accessible at www.sgs.com/terms_and_conditions.htm and for electronic format documents, subject to Terms and Conditions for Electronic Documents at www.sgs.com/terms_e-document.htm. Attention is drawn to the limitation of liability, indemnification and jurisdiction issues defined therein. Any holder of this document is advised that information contained hereon reflects the Company's findings at the time of its intervention only and within the limits of Client's instructions, if any. The Company's sole responsibility is to its Client and this document does not exonerate parties to a transaction from exercising all their rights and obligations under the transaction documents. This document cannot be reproduced except in full, without prior written approval of the Company. Any unauthorized alteration, forgery or falsification of the content or appearance of this document is unlawful and offenders may be prosecuted to the fullest extent of the law.

LTE_Band2_20MHz_16QAM_100_0_LowCH18700-1860

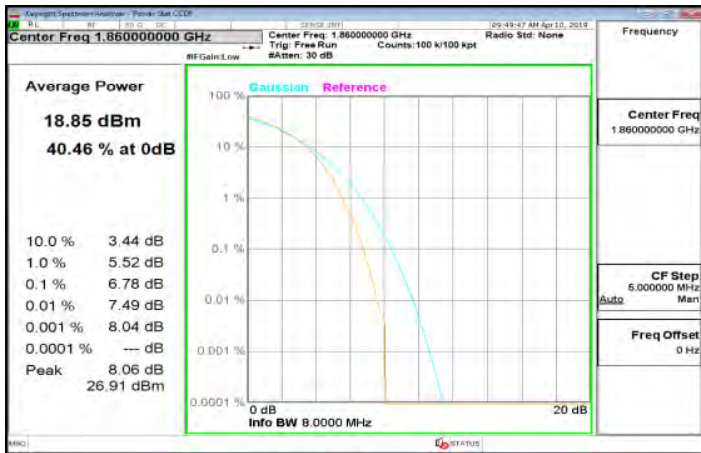

LTE_Band2_20MHz_16QAM_100_0_MidCH18900-1880

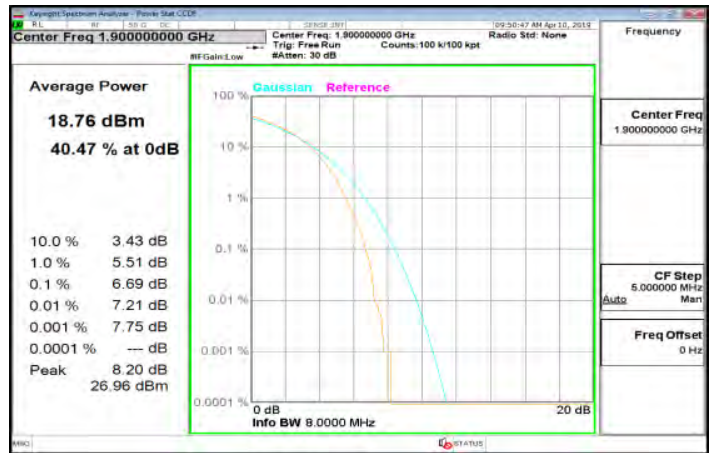

LTE_Band2_20MHz_64QAM_100_0_LowCH18700-1860

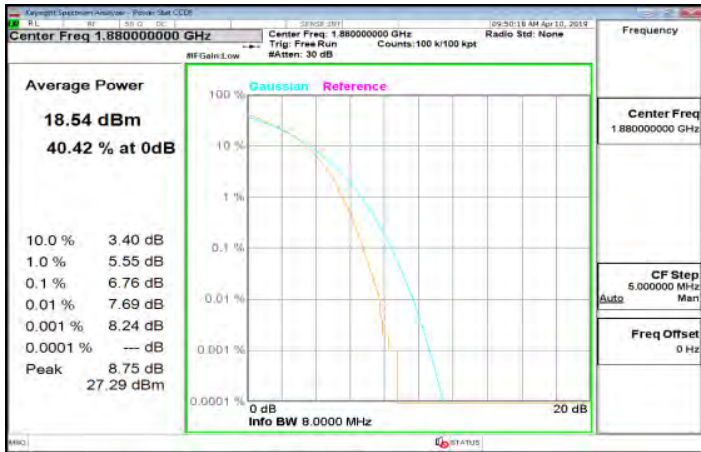

~ End of Report ~

Unless otherwise stated the results shown in this test report refer only to the sample(s) tested and such sample(s) are retained for 90 days only.

除非另有說明，此報告結果僅對測試之樣品負責，同時此樣品僅保留90天。本報告未經本公司書面許可，不可部份複製。

This document is issued by the Company subject to its General Conditions of Service printed overleaf, available on request or accessible at www.sgs.com/terms_and_conditions.htm and for electronic format documents, subject to Terms and Conditions for Electronic Documents at www.sgs.com/terms_e-document.htm. Attention is drawn to the limitation of liability, indemnification and jurisdiction issues defined therein. Any holder of this document is advised that information contained hereon reflects the Company's findings at the time of its intervention only and within the limits of Client's instructions, if any. The Company's sole responsibility is to its Client and this document does not exonerate parties to a transaction from exercising all their rights and obligations under the transaction documents. This document cannot be reproduced except in full, without prior written approval of the Company. Any unauthorized alteration, forgery or falsification of the content or appearance of this document is unlawful and offenders may be prosecuted to the fullest extent of the law.