

FCC Test Report

FCC ID : 2AQYEFMP169
Equipment : Mobile Phone
Model No. : F-02L
Brand Name : FUJITSU
Applicant : FUJITSU CONNECTED TECHNOLOGIES Ltd.
Address : 1-1, Kamikodanaka 4-chome, Nakahara-ku,
Kawasaki 211-8588, Japan
Standard : 47 CFR FCC Part 15.247
Received Date : Feb. 12, 2019
Tested Date : Feb. 16 ~ Mar. 05, 2019

We, International Certification Corp., would like to declare that the tested sample has been evaluated and in compliance with the requirement of the above standards. The test results contained in this report refer exclusively to the product. It may be duplicated completely for legal use with the approval of the applicant. It shall not be reproduced except in full without the written approval of our laboratory.

Reviewed by:

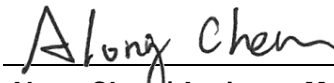

Along Chen / Assistant Manager

Approved by:



Gary Chang / Manager



Table of Contents

1	GENERAL DESCRIPTION	5
1.1	Information.....	5
1.2	Local Support Equipment List	7
1.3	Test Setup Chart	7
1.4	The Equipment List	8
1.5	Test Standards	9
1.6	Deviation from Test Standard and Measurement Procedure.....	9
1.7	Measurement Uncertainty	9
2	TEST CONFIGURATION	10
2.1	Testing Condition	10
2.2	The Worst Test Modes and Channel Details	10
3	TRANSMITTER TEST RESULTS.....	11
3.1	Conducted Emissions.....	11
3.2	6dB and Occupied Bandwidth	14
3.3	RF Output Power.....	19
3.4	Power Spectral Density	22
3.5	Unwanted Emissions into Restricted Frequency Bands	27
3.6	Emissions in Non-Restricted Frequency Bands.....	49
4	TEST LABORATORY INFORMATION	53

Release Record

Report No.	Version	Description	Issued Date
FR8D1403AC	Rev. 01	Initial issue	Mar. 22, 2019

Summary of Test Results

FCC Rules	Test Items	Measured	Result
15.207	Conducted Emissions	[dBuV]: 2.110MHz 29.75 (Margin -16.25dB) - AV	Pass
15.247(d) 15.209	Radiated Emissions	[dBuV/m at 3m]: 2390.00MHz 62.24 (Margin -11.76dB) - PK	Pass
15.247(b)(3)	Maximum Output Power	Max Power [dBm]: 23.08	Pass
15.247(a)(2)	6dB Bandwidth	Meet the requirement of limit	Pass
15.247(e)	Power Spectral Density	Meet the requirement of limit	Pass
15.203	Antenna Requirement	Meet the requirement of limit	Pass

Declaration of Conformity:

The test results with all measurement uncertainty excluded are presented in accordance with the regulation limits or requirements declared by manufacturers.

Comments and Explanations:

The declared values of gain for EUT presented in the report are provided by the manufacturer, and the manufacturer takes all the responsibilities for the accuracy of the gain.

1 General Description

1.1 Information

1.1.1 Product Details

Product Name	Mobile Phone
Brand Name	FUJITSU
Model Name	F-02L
IMEI Code	353323100015576 / 353323100017150
H/W Version	v2.1.0
S/W Version	R022.1e

1.1.2 Specification of the Equipment under Test (EUT)

RF General Information					
Frequency Range (MHz)	IEEE Std. 802.11	Ch. Freq. (MHz)	Channel Number	Transmit Chains (N _{TX})	Data Rate / MCS
2400-2483.5	b	2412-2462	1-11 [11]	1	1-11 Mbps
2400-2483.5	g	2412-2462	1-11 [11]	1	6-54 Mbps
2400-2483.5	n (HT20)	2412-2462	1-11 [11]	1	MCS 0-7

Note 1: RF output power specifies that Maximum Peak Conducted Output Power.
 Note 2: 802.11b uses a combination of DSSS-DBPSK, DQPSK, CCK modulation.
 Note 3: 802.11g/n uses a combination of OFDM-BPSK, QPSK, 16QAM, 64QAM modulation.

1.1.3 Antenna Details

Ant. No.	Type	Connector	Operating Frequencies (MHz) / Antenna Gain (dBi)			
			2400~2483.5	5150~5250	5250~5350	5470~5725
1	Monopole	No	-5	-3.4	-3.4	-3.4

1.1.4 Power Supply Type of Equipment under Test (EUT)

Power Supply Type	3.8Vdc from battery: 9Vdc,1.5A from adapter (No bundle, support unit only)
-------------------	---

1.1.5 Accessories

Accessories		
No.	Equipment	Description
1	Battery	Brand: FUJITSU CONNECTED TECHNOLOGIES LIMITED Model Name: CA54310-0074 Power Rating: 3.8Vdc, 2,780mAh, 10.6Wh

1.1.6 Channel List

Channel	Frequency(MHz)
1	2412
2	2417
3	2422
4	2427
5	2432
6	2437
7	2442
8	2447
9	2452
10	2457
11	2462

1.1.7 Test Tool and Duty Cycle

Test Tool	QRCT, v 3.0.54.0		
Duty Cycle and Duty Factor	Mode	Duty Cycle (%)	Duty Factor (dB)
	11b	100.00%	0.00
	11g	100.00%	0.00
	HT20	100.00%	0.00

1.1.8 Power Index of Test Tool

Modulation Mode	Test Frequency (MHz)	Power Index
11b	2412	15.5
11b	2437	15.5
11b	2462	15.5
11g	2412	15
11g	2437	15
11g	2462	15
HT20	2412	15
HT20	2437	15
HT20	2462	15

1.2 Local Support Equipment List

Support Equipment List					
No.	Equipment	Brand	Model	S/N	Remarks
1	Earphone	APPLE	MD827FE/A	6	---
2	Notebook	DELL	Latitude E6440	---	---

1.3 Test Setup Chart

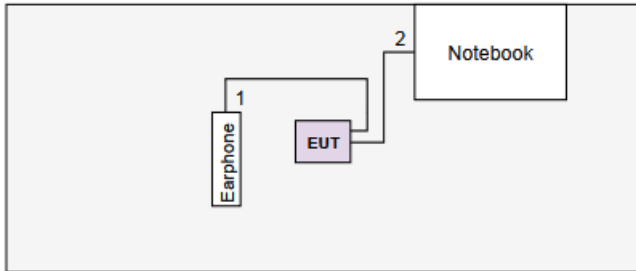
Test Setup Diagram	
	
No.	Signal cable / Length (m)
1	Audio, 1.2m non-shielded.
2	USB Type-C, 1m shielded.

1.4 The Equipment List

Test Item	Conducted Emission				
Test Site	Conduction room 1 / (CO01-WS)				
Instrument	Manufacturer	Model No.	Serial No.	Calibration Date	Calibration Until
Receiver	R&S	ESR3	101657	Jan. 08, 2019	Jan. 07, 2020
LISN	SCHWARZBECK	Schwarzbeck 8127	8127-667	Nov. 05, 2018	Nov. 04, 2019
RF Cable-CON	Woken	CFD200-NL	CFD200-NL-001	Oct. 23, 2018	Oct. 23, 2019
Measurement Software	AUDIX	e3	6.120210k	NA	NA

Note: Calibration Interval of instruments listed above is one year.

Test Item	Radiated Emission				
Test Site	966 chamber1 / (03CH01-WS)				
Instrument	Manufacturer	Model No.	Serial No.	Calibration Date	Calibration Until
Spectrum Analyzer	R&S	FSV40	101498	Dec. 27, 2018	Dec. 26, 2019
Receiver	R&S	ESR3	101658	Dec. 11, 2018	Dec. 10, 2019
Bilog Antenna	SCHWARZBECK	VULB9168	VULB9168-522	Jul. 18, 2018	Jul. 17, 2019
Horn Antenna 1G-18G	SCHWARZBECK	BBHA 9120 D	BBHA 9120 D 1096	Dec. 18, 2018	Dec. 17, 2019
Horn Antenna 18G-40G	SCHWARZBECK	BBHA 9170	BBHA 9170517	Nov. 15, 2018	Nov. 14, 2019
Loop Antenna	R&S	HFH2-Z2	100330	Nov. 09, 2018	Nov. 08, 2019
Loop Antenna Cable	KOAX KABEL	101354-BW	101354-BW	Oct. 08, 2018	Oct. 07, 2019
Preamplifier	EMC	EMC02325	980225	Jul. 20, 2018	Jul. 19, 2019
Preamplifier	Agilent	83017A	MY39501308	Oct. 04, 2018	Oct. 03, 2019
Preamplifier	EMC	EMC184045B	980192	Aug. 09, 2018	Aug. 08, 2019
RF Cable	EMC	EMC104-SM-SM-8000	181106	Oct. 08, 2018	Oct. 07, 2019
RF Cable	HUBER+SUHNER	SUCOFLEX104	MY16019/4	Oct. 08, 2018	Oct. 07, 2019
RF Cable	HUBER+SUHNER	SUCOFLEX104	MY16014/4	Oct. 08, 2018	Oct. 07, 2019
LF cable 1M	EMC	EMCCFD400-NM-NM-1000	160502	Oct. 08, 2018	Oct. 07, 2019
LF cable 3M	Woken	CFD400NL-LW	CFD400NL-001	Oct. 08, 2018	Oct. 07, 2019
LF cable 10M	Woken	CFD400NL-LW	CFD400NL-002	Oct. 08, 2018	Oct. 07, 2019
Measurement Software	AUDIX	e3	6.120210g	NA	NA

Note: Calibration Interval of instruments listed above is one year.

Test Item	RF Conducted				
Test Site	(TH01-WS)				
Instrument	Manufacturer	Model No.	Serial No.	Calibration Date	Calibration Until
Spectrum Analyzer	R&S	FSV40	101063	Apr. 16, 2018	Apr. 15, 2019
Power Meter	Anritsu	ML2495A	1241002	Oct. 09, 2018	Oct. 08, 2019
Power Sensor	Anritsu	MA2411B	1207366	Oct. 09, 2018	Oct. 08, 2019
DC POWER SOURCE	GW INSTEK	GPC-6030D	EM892433	Oct. 25, 2018	Oct. 24, 2019
Measurement Software	Sporton	SENSE-15247_DTS	V5.9	NA	NA
Note: Calibration Interval of instruments listed above is one year.					

1.5 Test Standards

According to the specification of EUT, the EUT must comply with following standards and KDB documents.

47 CFR FCC Part 15.247

ANSI C63.10-2013

FCC KDB 558074 D01 15.247 Meas Guidance v05r01

1.6 Deviation from Test Standard and Measurement Procedure

None

1.7 Measurement Uncertainty

ISO/IEC 17025 requires that an estimate of the measurement uncertainties associated with the emissions test results be included in the report. The measurement uncertainties given below are based on a 95% confidence level (based on a coverage factor (k=2))

Measurement Uncertainty	
Parameters	Uncertainty
Bandwidth	±34.130 Hz
Conducted power	±0.808 dB
Power density	±0.583 dB
Conducted emission	±2.715 dB
AC conducted emission	±2.92 dB
Radiated emission ≤ 1GHz	±3.41 dB
Radiated emission > 1GHz	±4.59 dB

2 Test Configuration

2.1 Testing Condition

Test Item	Test Site	Ambient Condition	Tested By
AC Conduction	CO01-WS	21°C / 56%	Akun Chung
Radiated Emissions	03CH01-WS	22-24°C / 60-65%	Roger Lu Akun Chung
RF Conducted	TH01-WS	20°C / 65%	Roger Lu

- FCC Designation No.: TW2732
- FCC site registration No.: 181692
- IC site registration No.: 10807A-1

2.2 The Worst Test Modes and Channel Details

Test item	Modulation Mode	Test Frequency (MHz)	Data Rate	Test Configuration
Conducted Emissions	11g	2437	6 Mbps	---
Radiated Emissions ≤1GHz	11g	2437	6 Mbps	---
Radiated Emissions >1GHz				
Maximum Output Power	11b	2412 / 2437 / 2462	1 Mbps	
6dB bandwidth	11g	2412 / 2437 / 2462	6 Mbps	---
Power spectral density	HT20	2412 / 2437 / 2462	MCS 0	

NOTE:

1. The EUT was pretested with 3 orientations placed on the table for the radiated emission measurement – X, Y, and Z-plane. The **Y-plane** results were found as the worst case and were shown in this report.

3 Transmitter Test Results

3.1 Conducted Emissions

3.1.1 Limit of Conducted Emissions

Conducted Emissions Limit		
Frequency Emission (MHz)	Quasi-Peak	Average
0.15-0.5	66 - 56 *	56 - 46 *
0.5-5	56	46
5-30	60	50

Note 1: * Decreases with the logarithm of the frequency.

3.1.2 Test Procedures

1. The device is placed on a test table, raised 80 cm above the reference ground plane. The vertical conducting plane is located 40 cm to the rear of the device.
2. The device is connected to line impedance stabilization network (LISN) and other accessories are connected to other LISN. Measured levels of AC power line conducted emission are across the 50 Ω LISN port.
3. AC conducted emission measurements is made over frequency range from 150 kHz to 30 MHz.
4. This measurement was performed with AC 120V / 60Hz.

3.1.3 Test Setup

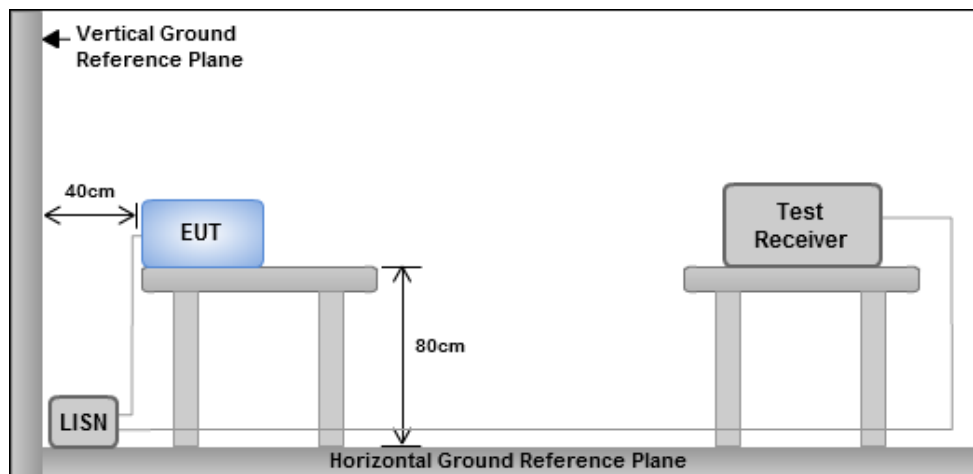

- Note: 1. Support units were connected to second LISN.
 2. Both of LISNs (AMN) are 80 cm from EUT and at least 80 cm from other units and other metal planes

3.1.4 Test Result of Conducted Emissions

Modulation	11g	Test Freq. (MHz)	2437
Power Phase	Line		

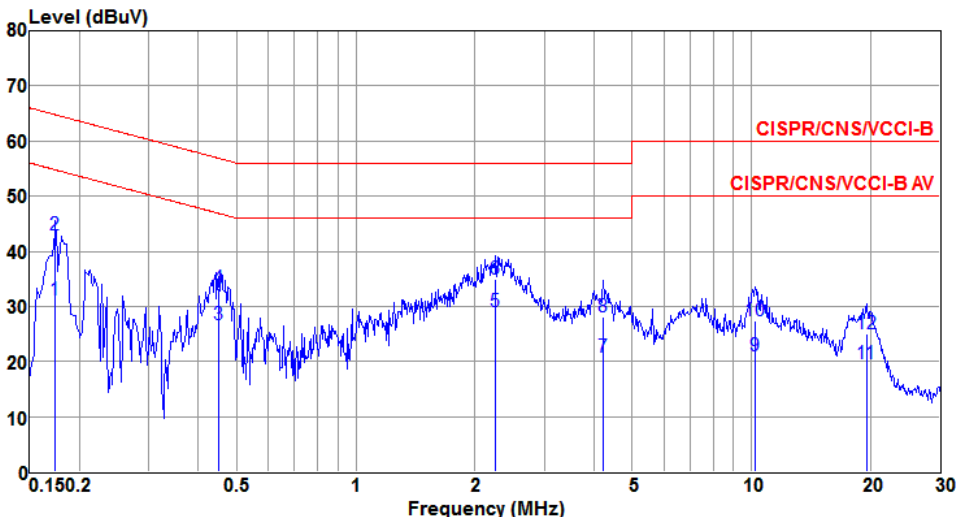

	Freq MHz	Level dBuV	Limit Line dBuV	Over Limit dB	Read Level dBuV	LISN factor dB	cable loss dB	Remark
1	0.174	31.04	54.77	-23.73	30.92	0.06	0.06	Average
2	0.174	42.95	64.77	-21.82	42.83	0.06	0.06	QP
3	0.450	26.60	46.87	-20.27	26.46	0.06	0.08	Average
4	0.450	33.18	56.87	-23.69	33.04	0.06	0.08	QP
5*	2.261	29.02	46.00	-16.98	28.75	0.09	0.18	Average
6	2.261	34.95	56.00	-21.05	34.68	0.09	0.18	QP
7	4.224	20.67	46.00	-25.33	20.27	0.11	0.29	Average
8	4.224	27.98	56.00	-28.02	27.58	0.11	0.29	QP
9	10.208	21.13	50.00	-28.87	20.51	0.18	0.44	Average
10	10.208	27.45	60.00	-32.55	26.83	0.18	0.44	QP
11	19.532	19.68	50.00	-30.32	18.84	0.24	0.60	Average
12	19.532	25.09	60.00	-34.91	24.25	0.24	0.60	QP

Note 1: Level (dBuV) = Read Level (dBuV) + LISN Factor (dB) + Cable Loss (dB).
 2: Over Limit (dB) = Level (dBuV) – Limit Line (dBuV).

Modulation	11g	Test Freq. (MHz)	2437
Power Phase	Neutral		

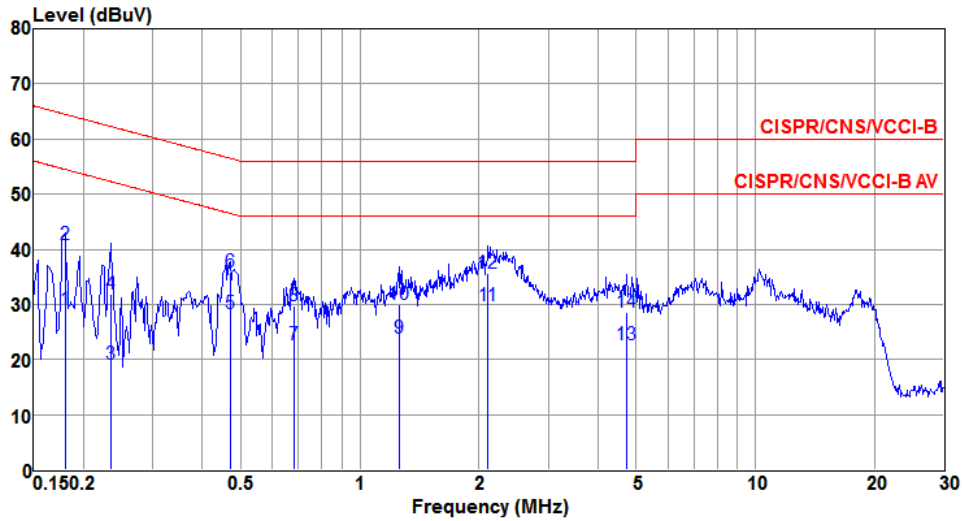

	Freq MHz	Level dBuV	Limit Line dBuV	Over Limit dB	Read Level dBuV	LISN factor dB	cable loss dB	Remark
1	0.180	29.11	54.50	-25.39	29.01	0.04	0.06	Average
2	0.180	40.75	64.50	-23.75	40.65	0.04	0.06	QP
3	0.234	19.13	52.30	-33.17	19.02	0.04	0.07	Average
4	0.234	31.97	62.30	-30.33	31.86	0.04	0.07	QP
5	0.471	28.29	46.49	-18.20	28.16	0.05	0.08	Average
6	0.471	35.91	56.49	-20.58	35.78	0.05	0.08	QP
7	0.683	22.77	46.00	-23.23	22.62	0.06	0.09	Average
8	0.683	29.71	56.00	-26.29	29.56	0.06	0.09	QP
9	1.255	23.75	46.00	-22.25	23.57	0.06	0.12	Average
10	1.255	30.07	56.00	-25.93	29.89	0.06	0.12	QP
11*	2.110	29.75	46.00	-16.25	29.51	0.07	0.17	Average
12	2.110	35.54	56.00	-20.46	35.30	0.07	0.17	QP
13	4.721	22.72	46.00	-23.28	22.30	0.11	0.31	Average
14	4.721	28.52	56.00	-27.48	28.10	0.11	0.31	QP

Note 1: Level (dBuV) = Read Level (dBuV) + LISN Factor (dB) + Cable Loss (dB).
 2: Over Limit (dB) = Level (dBuV) – Limit Line (dBuV).

3.2 6dB and Occupied Bandwidth

3.2.1 Limit of 6dB Bandwidth

The minimum 6dB bandwidth shall be at least 500 kHz.

3.2.2 Test Procedures

6dB Bandwidth

1. Set resolution bandwidth (RBW) = 100 kHz, Video bandwidth = 300 kHz.
2. Detector = Peak, Trace mode = max hold.
3. Sweep = auto couple, Allow the trace to stabilize.
4. Measure the maximum width of the emission that is constrained by the frequencies associated with the two outermost amplitude points (upper and lower) that are attenuated by 6dB relative to the maximum level measured in the fundamental emission.

Occupied Bandwidth

1. Set resolution bandwidth (RBW) = 1% ~ 5 % of OBW, Video bandwidth = 3 x RBW
2. Detector = Sample, Trace mode = max hold.
3. Sweep = auto couple, Allow the trace to stabilize.
4. Use the OBW measurement function of spectrum analyzer to measure the occupied bandwidth.

3.2.3 Test Setup

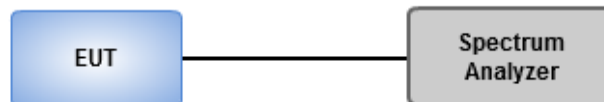

3.2.4 Test Result of 6dB and Occupied Bandwidth

Summary

Mode	Max-N dB (Hz)	Max-OBW (Hz)	ITU-Code	Min-N dB (Hz)	Min-OBW (Hz)
2.4-2.4835GHz	-	-	-	-	-
802.11b_Nss1,(1Mbps)_1TX	8.986M	13.097M	13M1G1D	8.043M	13.025M
802.11g_Nss1,(6Mbps)_1TX	16.449M	16.787M	16M8D1D	16.377M	16.715M
802.11n HT20_Nss1,(MCS0)_1TX	17.681M	17.873M	17M9D1D	17.609M	17.8M

Max-N dB = Maximum6dB down bandwidth; **Max-OBW** = Maximum99% occupied bandwidth;
Min-N dB = Minimum6dB down bandwidth; **Min-OBW** = Minimum99% occupied bandwidth;

Result

Mode	Result	Limit (Hz)	Port 1-N dB (Hz)	Port 1-OBW (Hz)
802.11b_Nss1,(1Mbps)_1TX	-	-	-	-
2412MHz	Pass	500k	8.986M	13.025M
2437MHz	Pass	500k	8.043M	13.097M
2462MHz	Pass	500k	8.043M	13.025M
802.11g_Nss1,(6Mbps)_1TX	-	-	-	-
2412MHz	Pass	500k	16.377M	16.715M
2437MHz	Pass	500k	16.377M	16.787M
2462MHz	Pass	500k	16.449M	16.787M
802.11n HT20_Nss1,(MCS0)_1TX	-	-	-	-
2412MHz	Pass	500k	17.681M	17.8M
2437MHz	Pass	500k	17.609M	17.873M
2462MHz	Pass	500k	17.681M	17.873M

Port X-N dB = Port X6dB down bandwidth; **Port X-OBW** = Port X99% occupied bandwidth;

802.11b_Nss1,(1Mbps)_1TX

EBW

2412MHz

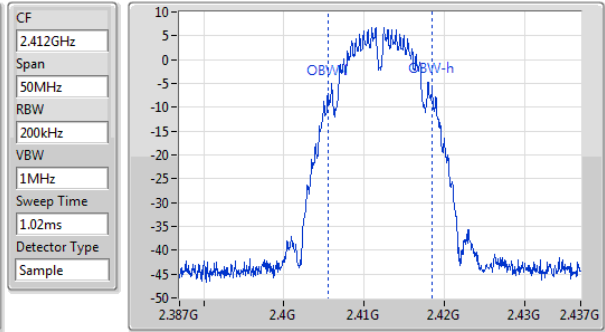
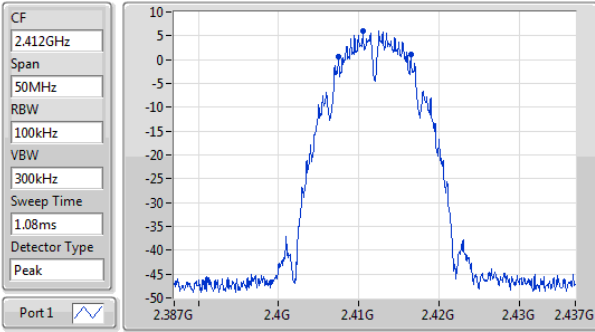

6dB(Hz)	Fl-6dB(Hz)	Fh-6dB(Hz)	OBW(Hz)	Fl-OBW(Hz)	Fh-OBW(Hz)	Limit(Hz)	Port
8.986M	2.407507G	2.416493G	13.025M	2.405488G	2.418512G	500k	1

802.11b_Nss1,(1Mbps)_1TX

EBW

2437MHz

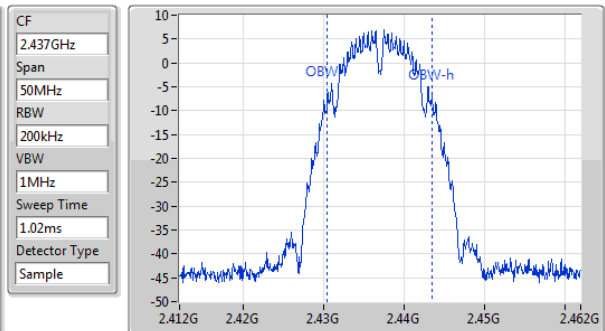
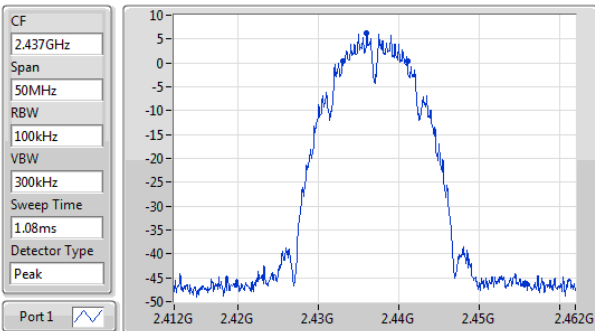

6dB(Hz)	Fl-6dB(Hz)	Fh-6dB(Hz)	OBW(Hz)	Fl-OBW(Hz)	Fh-OBW(Hz)	Limit(Hz)	Port
8.043M	2.433014G	2.441058G	13.097M	2.430415G	2.443512G	500k	1

802.11b_Nss1,(1Mbps)_1TX

EBW

2462MHz

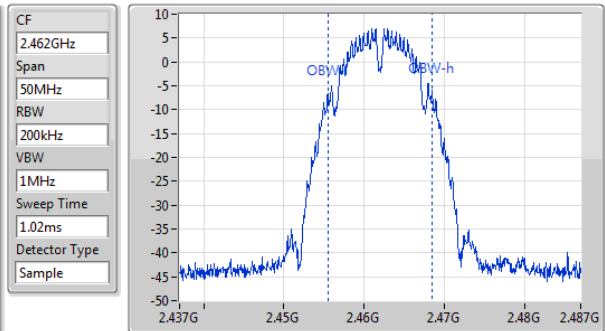
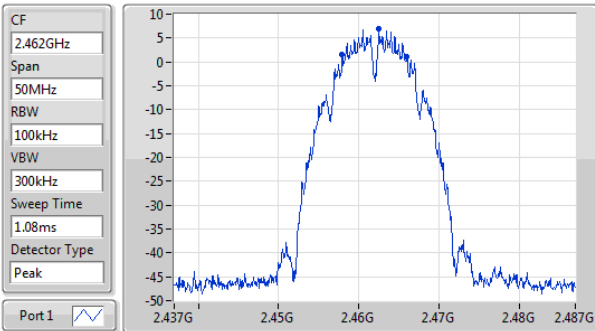

6dB(Hz)	Fl-6dB(Hz)	Fh-6dB(Hz)	OBW(Hz)	Fl-OBW(Hz)	Fh-OBW(Hz)	Limit(Hz)	Port
8.043M	2.457942G	2.465986G	13.025M	2.455488G	2.468512G	500k	1

802.11g_Nss1,(6Mbps)_1TX

EBW

2412MHz

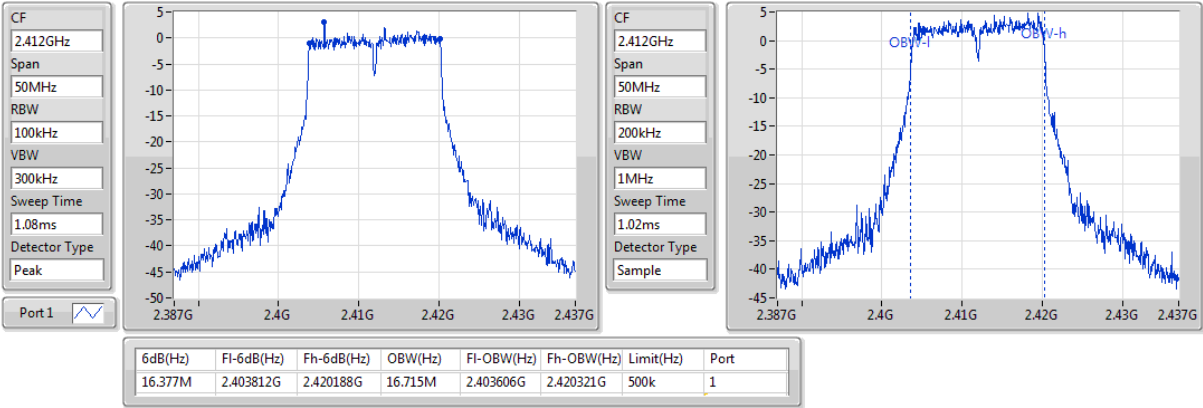

802.11g_Nss1,(6Mbps)_1TX

EBW

2437MHz

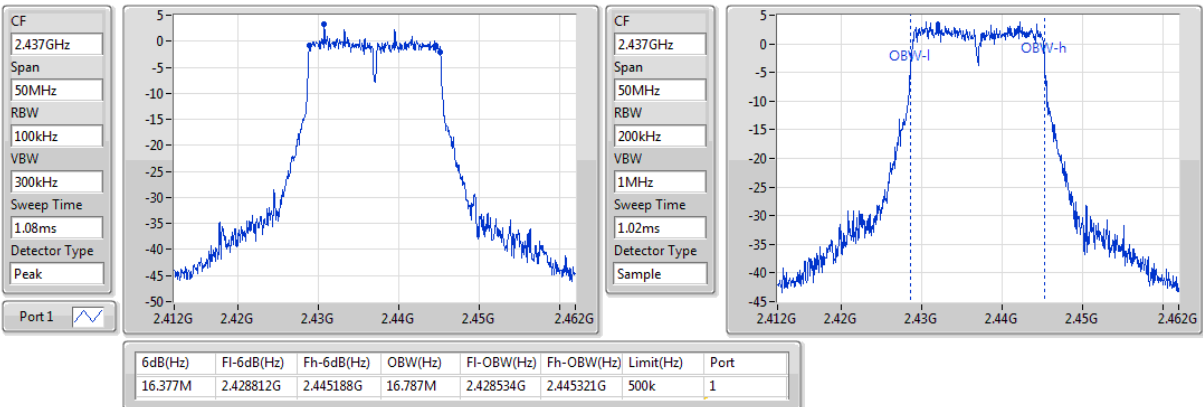

802.11g_Nss1,(6Mbps)_1TX

EBW

2462MHz

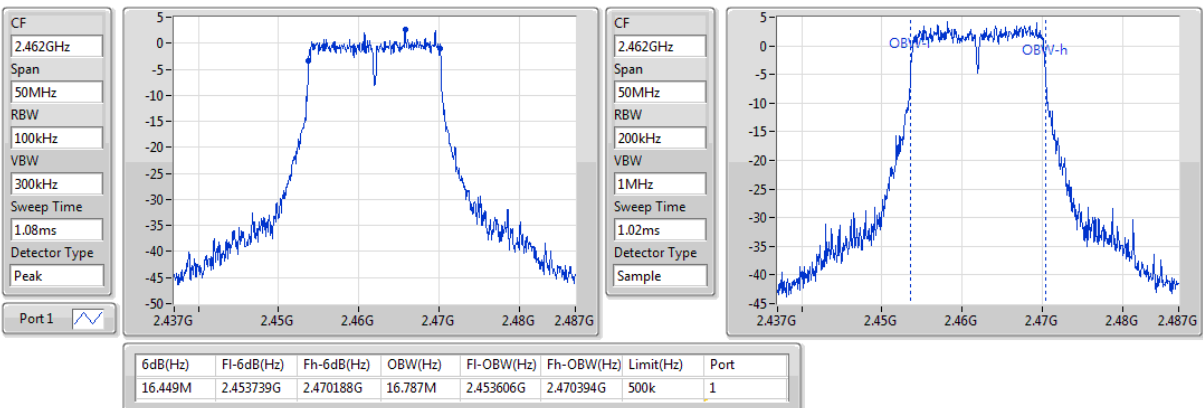

802.11n HT20_Nss1,(MCS0)_1TX

EBW

2412MHz

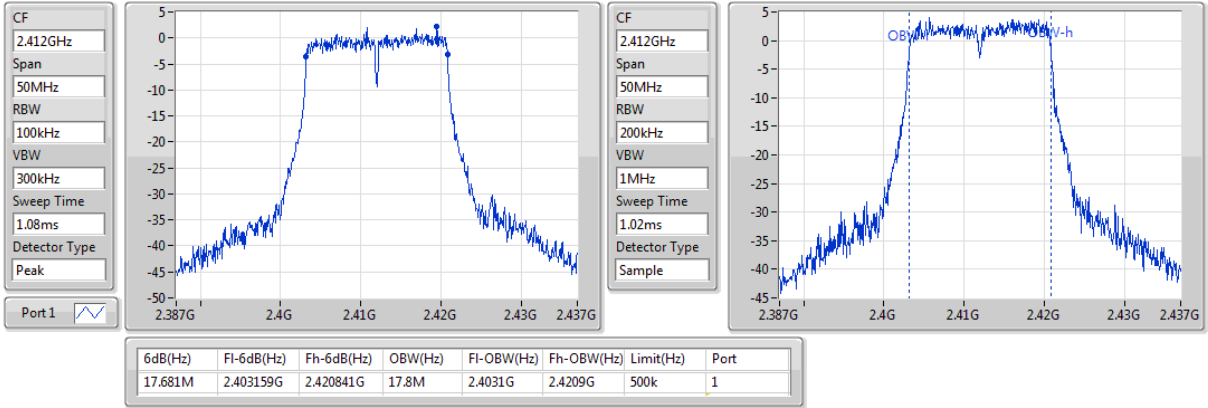

802.11n HT20_Nss1,(MCS0)_1TX

EBW

2437MHz

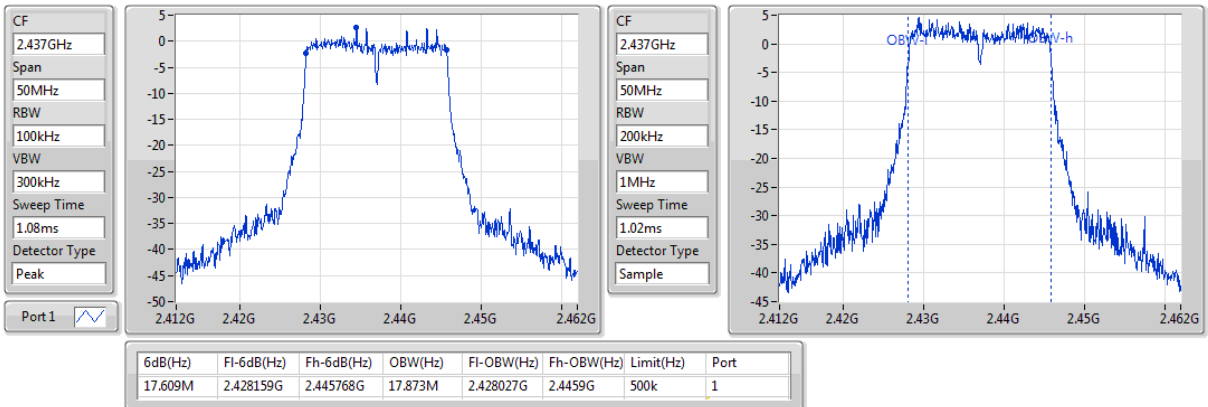

802.11n HT20_Nss1,(MCS0)_1TX

EBW

2462MHz

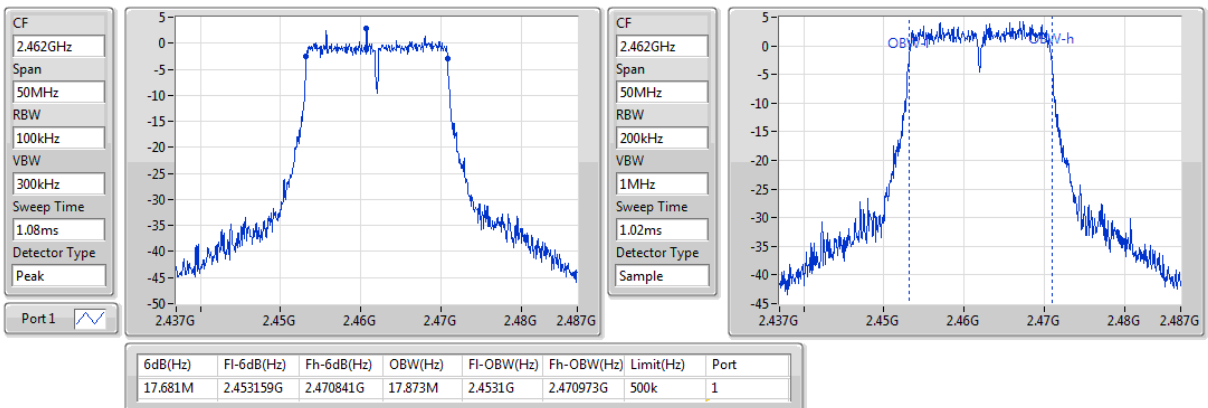

3.3 RF Output Power

3.3.1 Limit of RF Output Power

Conducted power shall not exceed 1Watt.

Antenna gain $\leq 6\text{dBi}$, no any corresponding reduction is in output power limit.

3.3.2 Test Procedures

A broadband RF power meter is used for output power measurement. The video bandwidth of power meter is greater than DTS bandwidth of EUT. If duty cycle of test signal is not 100 %, trigger and gating function of power meter will be enabled to capture transmission burst for measuring output power.

3.3.3 Test Setup

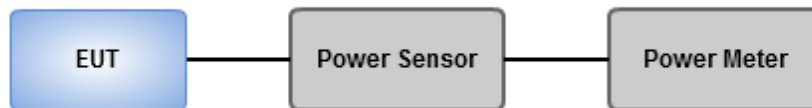

3.3.4 Test Result of Maximum Output Power

Summary of Peak Conducted Output Power

Mode	Total Power (dBm)	Total Power (W)
2.4-2.4835GHz	-	-
802.11b_Nss1,(1Mbps)_1TX	18.26	0.06699
802.11g_Nss1,(6Mbps)_1TX	23.08	0.20324
802.11n HT20_Nss1,(MCS0)_1TX	23.06	0.20230

Result

Mode	Result	DG (dBi)	Port 1 (dBm)	Total Power (dBm)	Power Limit (dBm)	EIRP (dBm)	EIRP Limit (dBm)
802.11b_Nss1,(1Mbps)_1TX	-	-	-	-	-	-	-
2412MHz	Pass	-5.00	18.13	18.13	30.00	13.13	36.00
2437MHz	Pass	-5.00	18.26	18.26	30.00	13.26	36.00
2462MHz	Pass	-5.00	18.21	18.21	30.00	13.21	36.00
802.11g_Nss1,(6Mbps)_1TX	-	-	-	-	-	-	-
2412MHz	Pass	-5.00	23.03	23.03	30.00	18.03	36.00
2437MHz	Pass	-5.00	23.08	23.08	30.00	18.08	36.00
2462MHz	Pass	-5.00	22.79	22.79	30.00	17.79	36.00
802.11n HT20_Nss1,(MCS0)_1TX	-	-	-	-	-	-	-
2412MHz	Pass	-5.00	23.01	23.01	30.00	18.01	36.00
2437MHz	Pass	-5.00	23.06	23.06	30.00	18.06	36.00
2462MHz	Pass	-5.00	22.98	22.98	30.00	17.98	36.00

DG = Directional Gain; Port X = Port X output power

Summary of Conducted (Average) Output Power

Mode	Total Power (dBm)	Total Power (W)
2.4-2.4835GHz	-	-
802.11b_Nss1,(1Mbps)_1TX	15.47	0.03524
802.11g_Nss1,(6Mbps)_1TX	15.27	0.03365
802.11n HT20_Nss1,(MCS0)_1TX	15.26	0.03357

Result

Mode	Result	DG (dBi)	Port 1 (dBm)	Total Power (dBm)	Power Limit (dBm)	EIRP (dBm)	EIRP Limit (dBm)
802.11b_Nss1,(1Mbps)_1TX	-	-	-	-	-	-	-
2412MHz	Pass	-5.00	15.21	15.21	-	10.21	-
2437MHz	Pass	-5.00	15.47	15.47	-	10.47	-
2462MHz	Pass	-5.00	15.44	15.44	-	10.44	-
802.11g_Nss1,(6Mbps)_1TX	-	-	-	-	-	-	-
2412MHz	Pass	-5.00	15.16	15.16	-	10.16	-
2437MHz	Pass	-5.00	15.27	15.27	-	10.27	-
2462MHz	Pass	-5.00	15.23	15.23	-	10.23	-
802.11n HT20_Nss1,(MCS0)_1TX	-	-	-	-	-	-	-
2412MHz	Pass	-5.00	15.18	15.18	-	10.18	-
2437MHz	Pass	-5.00	15.26	15.26	-	10.26	-
2462MHz	Pass	-5.00	15.22	15.22	-	10.22	-

DG = Directional Gain; Port X = Port X output power

Note :Conducted average output power is for reference only

3.4 Power Spectral Density

3.4.1 Limit of Power Spectral Density

Power spectral density shall not be greater than 8 dBm in any 3 kHz band.

3.4.2 Test Procedures

1. Set the RBW = 3 kHz, VBW = 10 kHz.
2. Detector = Peak, Sweep time = auto couple.
3. Trace mode = max hold, allow trace to fully stabilize.
4. Use the peak marker function to determine the maximum amplitude level.

3.4.3 Test Setup

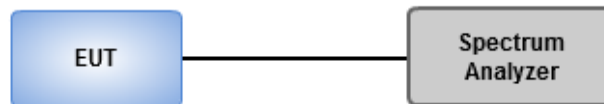

3.4.4 Test Result of Power Spectral Density

Summary

Mode	PD (dBm/RBW)
2.4-2.4835GHz	-
802.11b_Nss1,(1Mbps)_1TX	-7.05
802.11g_Nss1,(6Mbps)_1TX	-10.17
802.11n HT20_Nss1,(MCS0)_1TX	-9.30

RBW=3kHz.

Result

Mode	Result	DG (dBi)	Port 1 (dBm/RBW)	PD (dBm/RBW)	PD Limit (dBm/RBW)
802.11b_Nss1,(1Mbps)_1TX	-	-	-	-	-
2412MHz	Pass	-5.00	-7.05	-7.05	8.00
2437MHz	Pass	-5.00	-8.59	-8.59	8.00
2462MHz	Pass	-5.00	-8.41	-8.41	8.00
802.11g_Nss1,(6Mbps)_1TX	-	-	-	-	-
2412MHz	Pass	-5.00	-10.44	-10.44	8.00
2437MHz	Pass	-5.00	-10.92	-10.92	8.00
2462MHz	Pass	-5.00	-10.17	-10.17	8.00
802.11n HT20_Nss1,(MCS0)_1TX	-	-	-	-	-
2412MHz	Pass	-5.00	-9.36	-9.36	8.00
2437MHz	Pass	-5.00	-9.30	-9.30	8.00
2462MHz	Pass	-5.00	-10.36	-10.36	8.00

DG = Directional Gain;

PD = Power density; Port X = Port Xpower density;

802.11b_Nss1,(1Mbps)_1TX

PSD

2412MHz

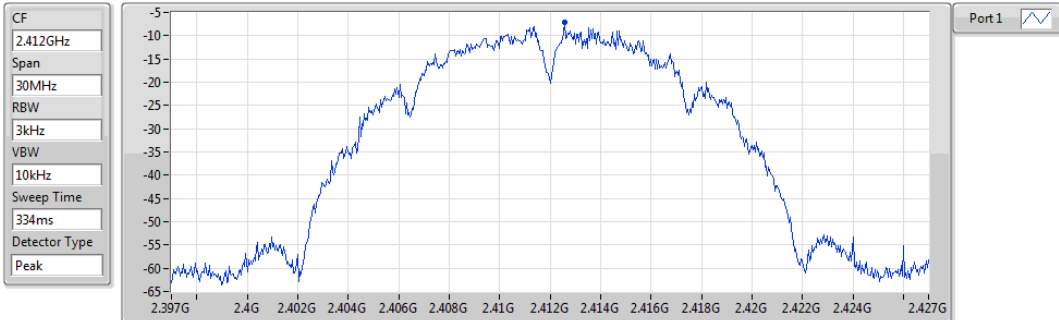

Sum	PD	Port 1
(dBm/100kHz)	(dBm/100kHz)	(dBm/100kHz)
-7.05	-7.05	-7.05

802.11b_Nss1,(1Mbps)_1TX

PSD

2437MHz

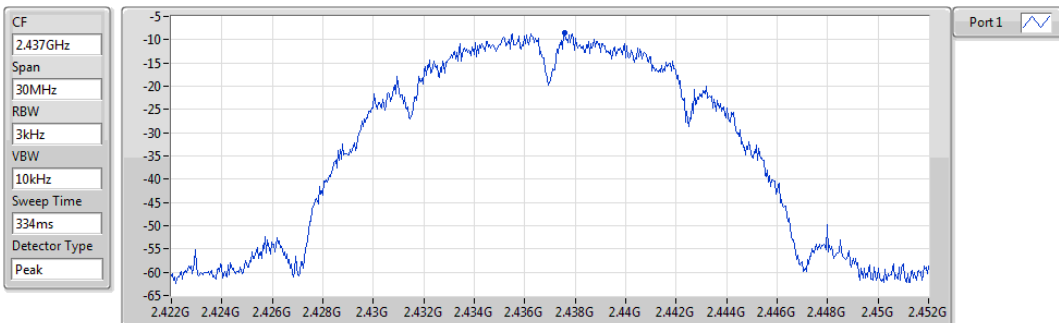

Sum	PD	Port 1
(dBm/100kHz)	(dBm/100kHz)	(dBm/100kHz)
-8.59	-8.59	-8.59

802.11b_Nss1,(1Mbps)_1TX

PSD

2462MHz

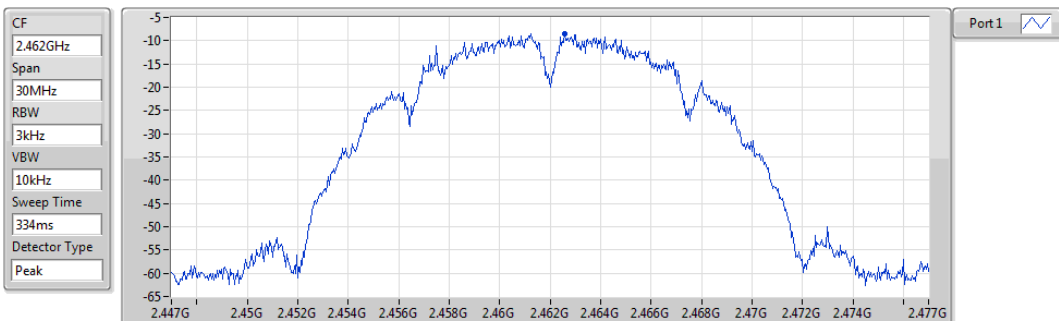

Sum	PD	Port 1
(dBm/100kHz)	(dBm/100kHz)	(dBm/100kHz)
-8.41	-8.41	-8.41

802.11g_Nss1,(6Mbps)_1TX

PSD

2412MHz

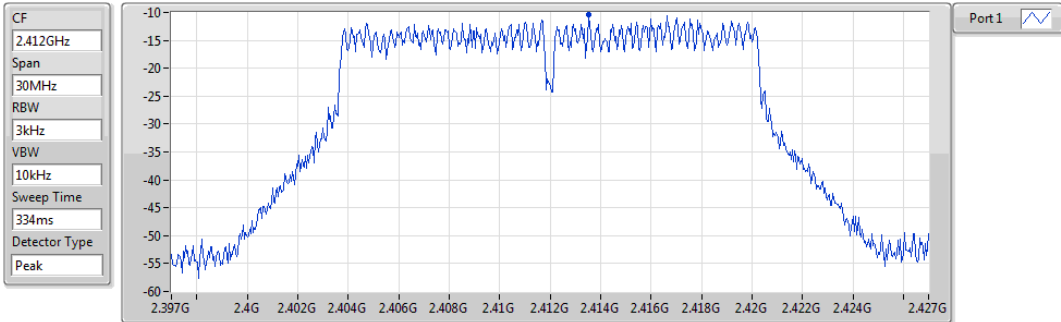

Sum	PD	Port 1
(dBm/RBW)	(dBm/RBW)	(dBm/RBW)
-10.44	-10.44	-10.44

802.11g_Nss1,(6Mbps)_1TX

PSD

2437MHz

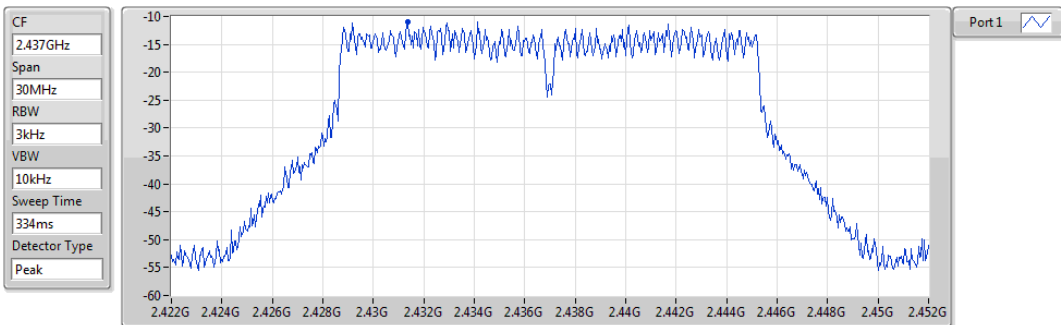

Sum	PD	Port 1
(dBm/RBW)	(dBm/RBW)	(dBm/RBW)
-10.92	-10.92	-10.92

802.11g_Nss1,(6Mbps)_1TX

PSD

2462MHz

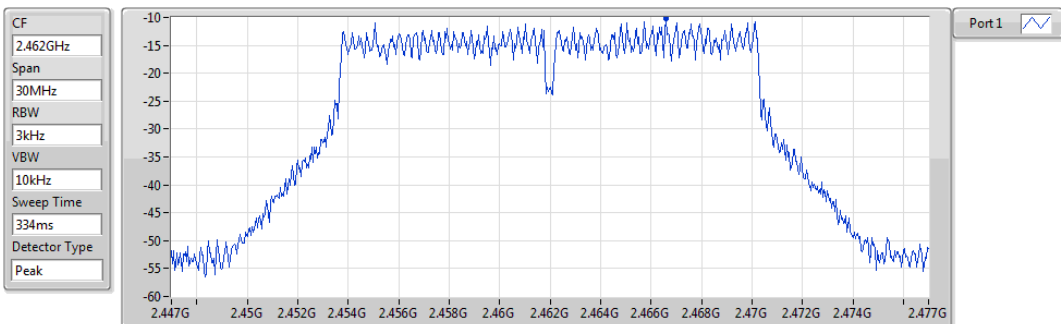

Sum	PD	Port 1
(dBm/RBW)	(dBm/RBW)	(dBm/RBW)
-10.17	-10.17	-10.17

802.11n HT20_Nss1,(MCS0)_1TX

PSD

2412MHz

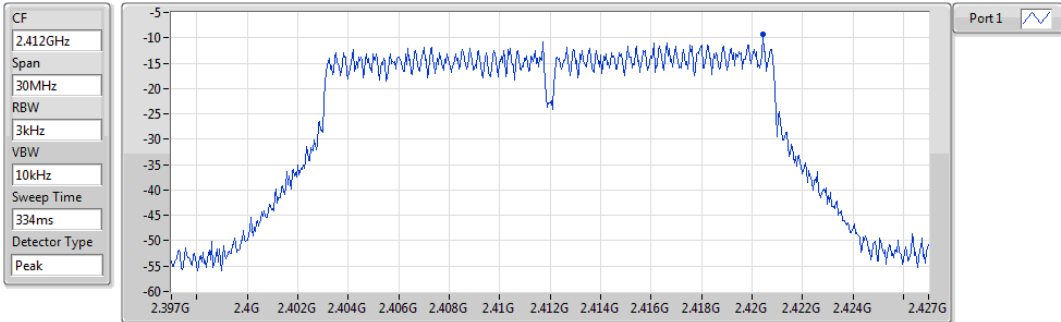

Sum	PD	Port 1
(dBm/100Hz)	(dBm/100Hz)	(dBm/100Hz)
-9.36	-9.36	-9.36

802.11n HT20_Nss1,(MCS0)_1TX

PSD

2437MHz

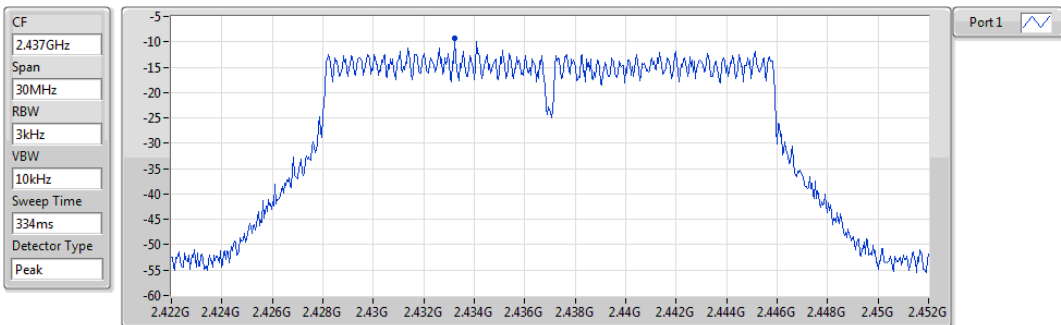

Sum	PD	Port 1
(dBm/100Hz)	(dBm/100Hz)	(dBm/100Hz)
-9.30	-9.30	-9.30

802.11n HT20_Nss1,(MCS0)_1TX

PSD

2462MHz

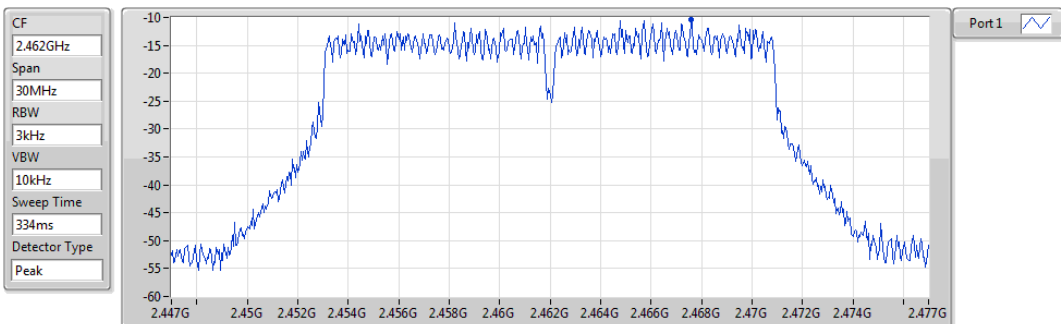

Sum	PD	Port 1
(dBm/100Hz)	(dBm/100Hz)	(dBm/100Hz)
-10.36	-10.36	-10.36

3.5 Unwanted Emissions into Restricted Frequency Bands

3.5.1 Limit of Unwanted Emissions into Restricted Frequency Bands

Restricted Band Emissions Limit			
Frequency Range (MHz)	Field Strength (uV/m)	Field Strength (dBuV/m)	Measure Distance (m)
0.009~0.490	2400/F(kHz)	48.5 - 13.8	300
0.490~1.705	24000/F(kHz)	33.8 - 23	30
1.705~30.0	30	29	30
30~88	100	40	3
88~216	150	43.5	3
216~960	200	46	3
Above 960	500	54	3

Note 1:
Quasi-Peak value is measured for frequency below 1GHz except for 9–90 kHz, 110–490 kHz frequency band. Peak and average value are measured for frequency above 1GHz. The limit on average radio frequency emission is as above table. The limit on peak radio frequency emissions is 20 dB above the maximum permitted average emission limit

Note 2:
Measurements may be performed at a distance other than what is specified provided. When performing measurements at a distance other than that specified, the results shall be extrapolated to the specified distance using an extrapolation factor as below, Frequency at or above 30 MHz: 20 dB/decade Frequency below 30 MHz: 40 dB/decade.

3.5.2 Test Procedures

1. Measurement is made at a semi-anechoic chamber that incorporates a turntable allowing a EUT rotation of 360°. A continuously-rotating, remotely-controlled turntable is installed at the test site to support the EUT and facilitate determination of the direction of maximum radiation for each EUT emission frequency. The EUT is placed at test table. For emissions testing at or below 1 GHz, the table height is 80 cm above the reference ground plane. For emission measurements above 1 GHz, the table height is 1.5 m
2. Measurement is made with the antenna positioned in both the horizontal and vertical planes of polarization. The measurement antenna is varied in height (1m ~ 4m) above the reference ground plane to obtain the maximum signal strength. Distance between EUT and antenna is 3 m.
3. This investigation is performed with the EUT rotated 360°, the antenna height scanned between 1 m and 4 m, and the antenna rotated to repeat the measurements for both the horizontal and vertical antenna polarizations.

Note:

1. 120kHz measurement bandwidth of test receiver and Quasi-peak detector is for radiated emission below 1GHz.
2. RBW=1MHz, VBW=3MHz and Peak detector is for peak measured value of radiated emission above 1GHz.
3. RBW=1MHz, VBW=1/T and Peak detector is for average measured value of radiated emission above 1GHz.

3.5.3 Test Setup

Radiated Emissions below 1 GHz

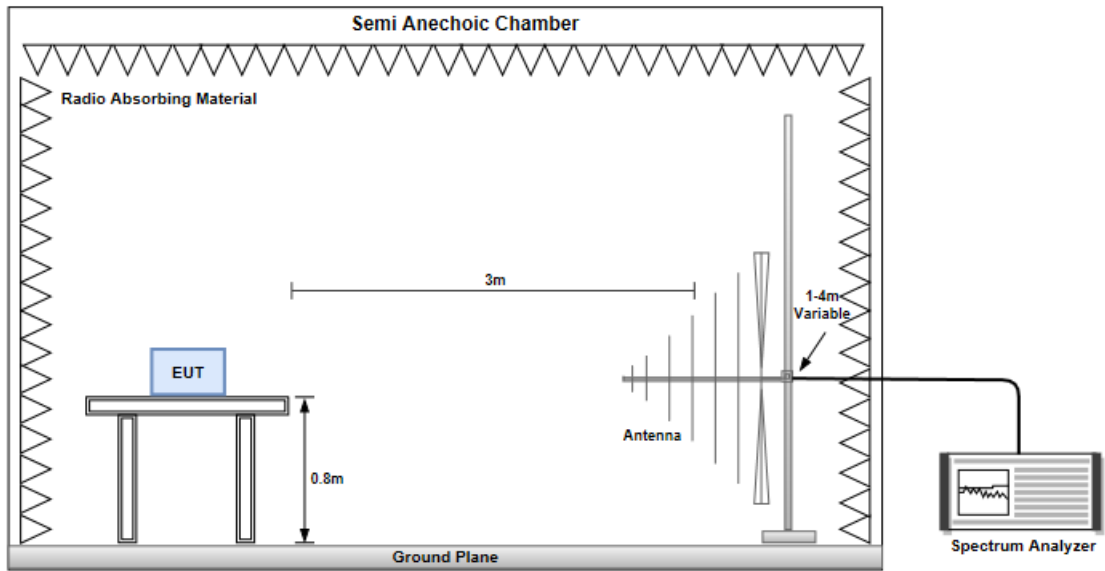

Radiated Emissions above 1 GHz

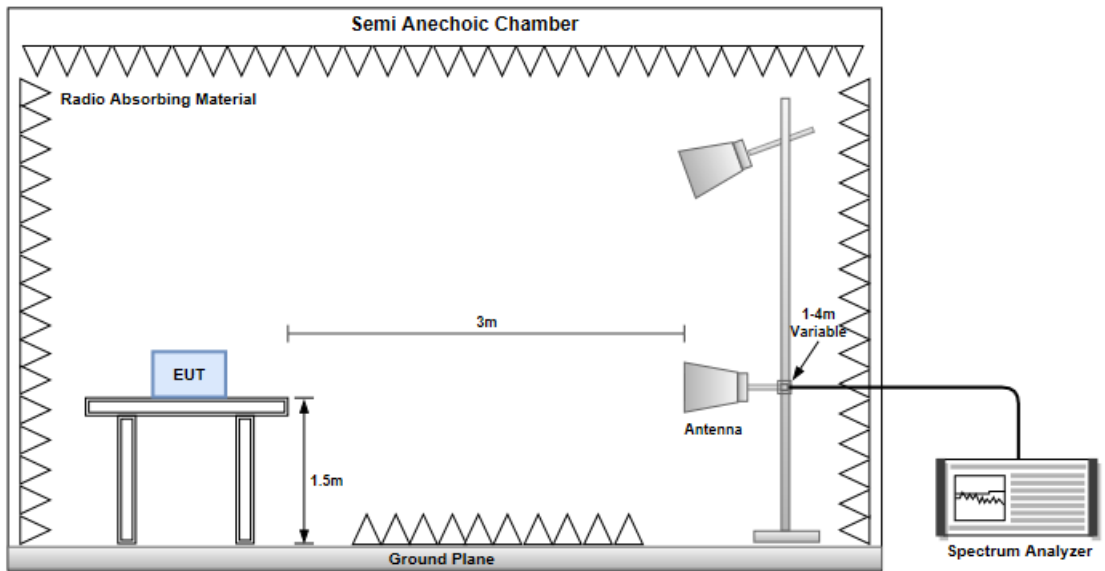

3.5.4 Transmitter Radiated Unwanted Emissions (Below 1GHz)

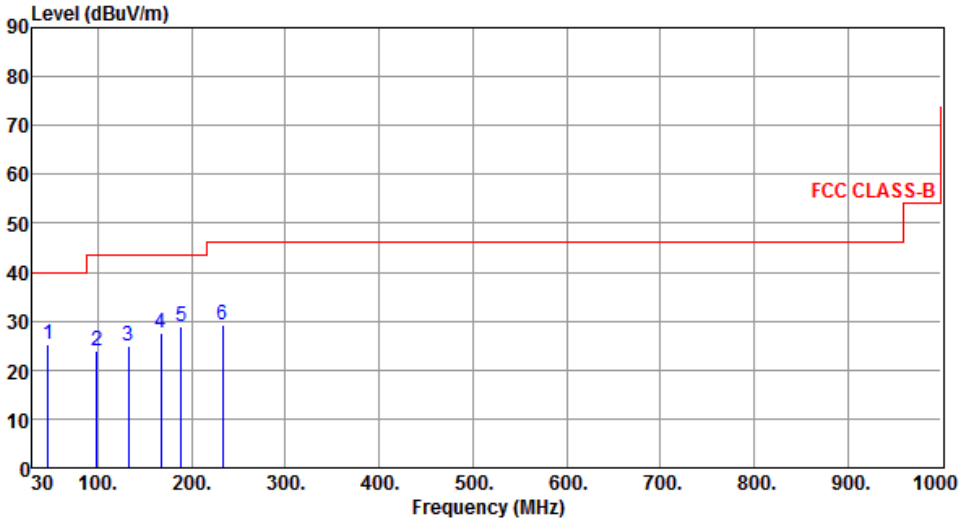
Modulation	11g	Test Freq. (MHz)	2437						
Polarization	Horizontal								
									
	Freq.	Emission level	Limit	Margin	SA reading	Factor	Remark	ANT High	Turn Table
	MHz	dBuV/m	dBuV/m	dB	dBuV	dB		cm	deg
1	46.49	25.16	40.00	-14.84	32.94	-7.78	Peak	---	---
2	98.87	23.88	43.50	-19.62	37.08	-13.20	Peak	---	---
3	132.82	24.84	43.50	-18.66	34.14	-9.30	Peak	---	---
4	166.77	27.50	43.50	-16.00	35.84	-8.34	Peak	---	---
5	189.08	29.01	43.50	-14.49	39.34	-10.33	Peak	---	---
6	232.73	29.39	46.00	-16.61	39.49	-10.10	Peak	---	---
<p>Note 1: Emission Level (dBuV/m) = SA Reading (dBuV/m) + Factor* (dB) *Factor includes antenna factor , cable loss and amplifier gain Note 2: Margin (dB) = Emission level (dBuV/m) – Limit (dBuV/m). Note 3: All spurious emissions below 30MHz are more than 20 dB below the limit.</p>									

Modulation	11g	Test Freq. (MHz)	2437
Polarization	Vertical		

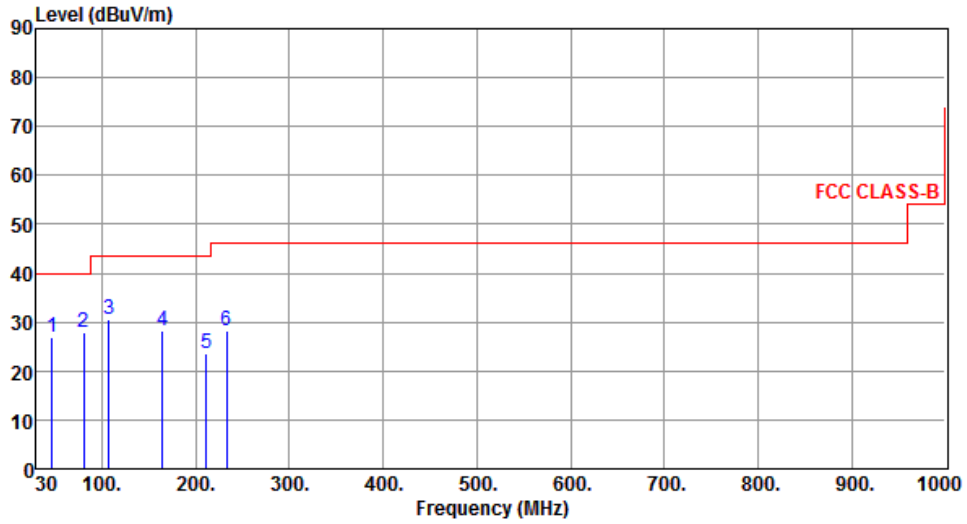

	Freq. MHz	Emission level dBuV/m	Limit dBuV/m	Margin dB	SA reading dBuV	Factor dB	Remark	ANT High cm	Turn Table deg
1	46.49	26.85	40.00	-13.15	34.63	-7.78	Peak	---	---
2	80.44	27.98	40.00	-12.02	41.00	-13.02	Peak	---	---
3	107.60	30.56	43.50	-12.94	42.35	-11.79	Peak	---	---
4	164.83	28.12	43.50	-15.38	36.45	-8.33	Peak	---	---
5	211.39	23.65	43.50	-19.85	34.61	-10.96	Peak	---	---
6	232.73	28.25	46.00	-17.75	38.35	-10.10	Peak	---	---

Note 1: Emission Level (dBuV/m) = SA Reading (dBuV/m) + Factor* (dB)

*Factor includes antenna factor , cable loss and amplifier gain

Note 2: Margin (dB) = Emission level (dBuV/m) – Limit (dBuV/m).

Note 3: All spurious emissions below 30MHz are more than 20 dB below the limit.

3.5.5 Transmitter Radiated Unwanted Emissions (Above 1GHz) for 11b

Modulation	11b	Test Freq. (MHz)	2412
Polarization	Horizontal		

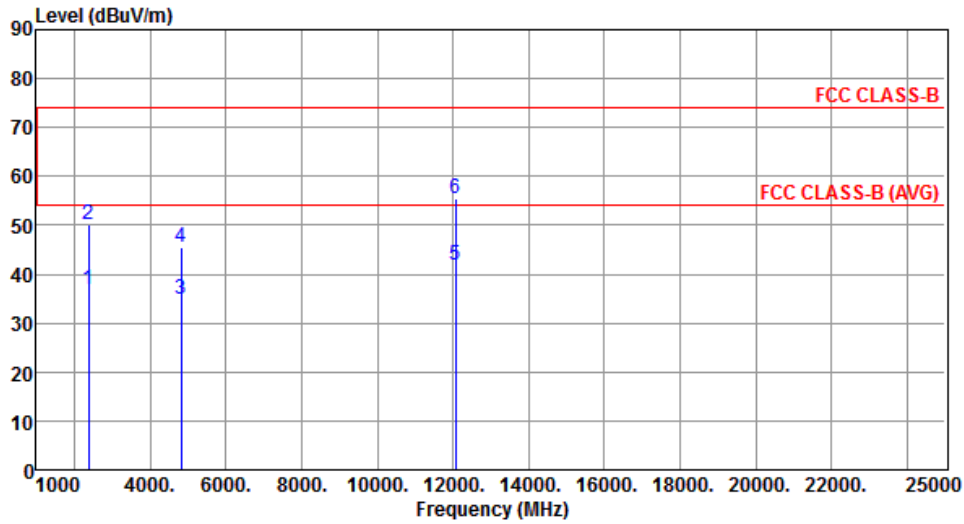

	Freq. MHz	Emission level dBuV/m	Limit dBuV/m	Margin dB	SA reading dBuV	Factor dB	Remark	ANT High cm	Turn Table deg
1	2390.00	36.95	54.00	-17.05	40.02	-3.07	Average	100	61
2	2390.00	50.14	74.00	-23.86	53.21	-3.07	Peak	100	61
3	4824.00	34.94	54.00	-19.06	31.41	3.53	Average	100	72
4	4824.00	45.58	74.00	-28.42	42.05	3.53	Peak	100	72
5	12060.00	41.68	54.00	-12.32	28.41	13.27	Average	100	100
6	12060.00	55.33	74.00	-18.67	42.06	13.27	Peak	100	100

Note 1: Emission Level (dBuV/m) = SA Reading (dBuV/m) + Factor* (dB)

*Factor includes antenna factor , cable loss and amplifier gain

Note 2: Margin (dB) = Emission level (dBuV/m) – Limit (dBuV/m).

Modulation	11b	Test Freq. (MHz)	2412
Polarization	Vertical		

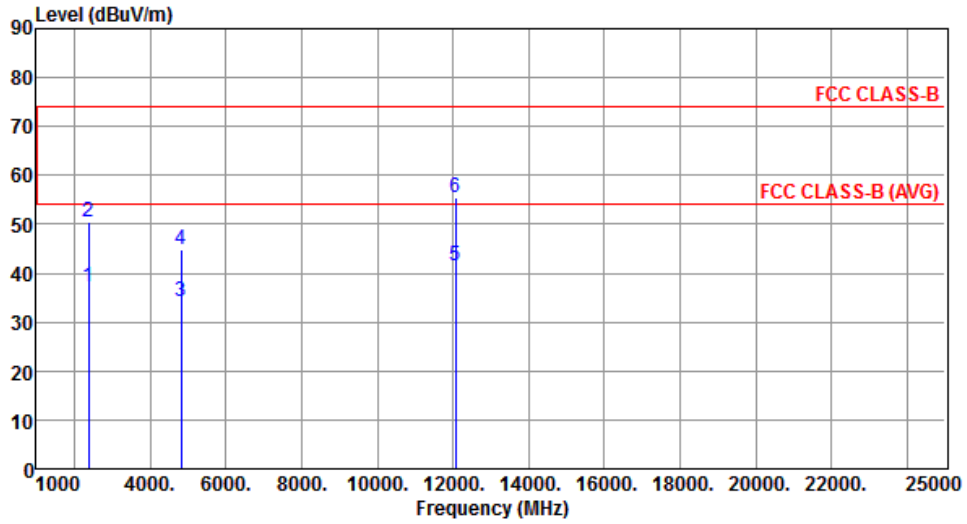

	Freq. MHz	Emission level dBuV/m	Limit dBuV/m	Margin dB	SA reading dBuV	Factor dB	Remark	ANT High cm	Turn Table deg
1	2390.00	37.05	54.00	-16.95	40.12	-3.07	Average	100	222
2	2390.00	50.38	74.00	-23.62	53.45	-3.07	Peak	100	222
3	4824.00	34.09	54.00	-19.91	30.56	3.53	Average	100	114
4	4824.00	44.78	74.00	-29.22	41.25	3.53	Peak	100	114
5	12060.00	41.52	54.00	-12.48	28.25	13.27	Average	100	60
6	12060.00	55.39	74.00	-18.61	42.12	13.27	Peak	100	60

Note 1: Emission Level (dBuV/m) = SA Reading (dBuV/m) + Factor* (dB)

*Factor includes antenna factor , cable loss and amplifier gain

Note 2: Margin (dB) = Emission level (dBuV/m) – Limit (dBuV/m).

Modulation	11b	Test Freq. (MHz)	2437
Polarization	Horizontal		

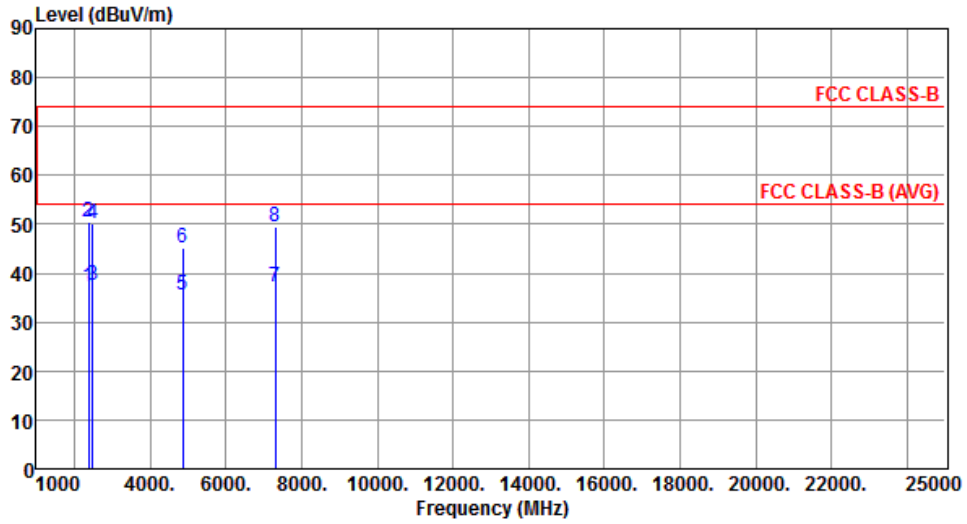

	Freq. MHz	Emission level dBuV/m	Limit dBuV/m	Margin dB	SA reading dBuV	Factor dB	Remark	ANT High cm	Turn Table deg
1	2390.00	37.18	54.00	-16.82	40.25	-3.07	Average	100	59
2	2390.00	50.39	74.00	-23.61	53.46	-3.07	Peak	100	59
3	2483.50	37.43	54.00	-16.57	40.65	-3.22	Average	100	59
4	2483.50	50.25	74.00	-23.75	53.47	-3.22	Peak	100	59
5	4874.00	35.66	54.00	-18.34	32.06	3.60	Average	100	74
6	4874.00	45.30	74.00	-28.70	41.70	3.60	Peak	100	74
7	7311.00	37.07	54.00	-16.93	28.25	8.82	Average	100	100
8	7311.00	49.50	74.00	-24.50	40.68	8.82	Peak	100	100

Note 1: Emission Level (dBuV/m) = SA Reading (dBuV/m) + Factor* (dB)

*Factor includes antenna factor , cable loss and amplifier gain

Note 2: Margin (dB) = Emission level (dBuV/m) – Limit (dBuV/m).

Modulation	11b	Test Freq. (MHz)	2437
Polarization	Vertical		

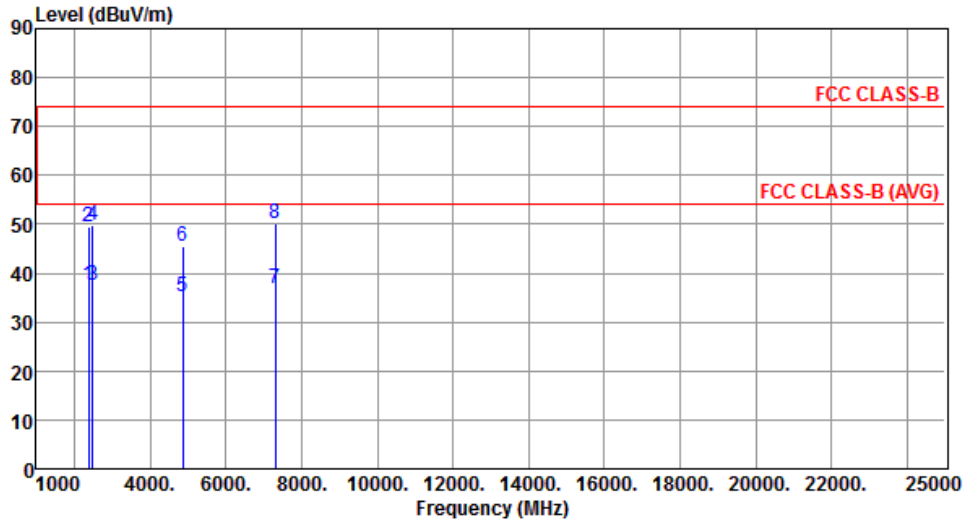

	Freq. MHz	Emission level dBuV/m	Limit dBuV/m	Margin dB	SA reading dBuV	Factor dB	Remark	ANT High cm	Turn Table deg
1	2390.00	37.61	54.00	-16.39	40.68	-3.07	Average	112	210
2	2390.00	49.41	74.00	-24.59	52.48	-3.07	Peak	112	210
3	2483.50	37.43	54.00	-16.57	40.65	-3.22	Average	112	210
4	2483.50	49.90	74.00	-24.10	53.12	-3.22	Peak	112	210
5	4874.00	35.30	54.00	-18.70	31.70	3.60	Average	142	110
6	4874.00	45.39	74.00	-28.61	41.79	3.60	Peak	142	110
7	7311.00	36.94	54.00	-17.06	28.12	8.82	Average	100	320
8	7311.00	50.04	74.00	-23.96	41.22	8.82	Peak	100	320

Note 1: Emission Level (dBuV/m) = SA Reading (dBuV/m) + Factor* (dB)

*Factor includes antenna factor , cable loss and amplifier gain

Note 2: Margin (dB) = Emission level (dBuV/m) – Limit (dBuV/m).

Modulation	11b	Test Freq. (MHz)	2462
Polarization	Horizontal		

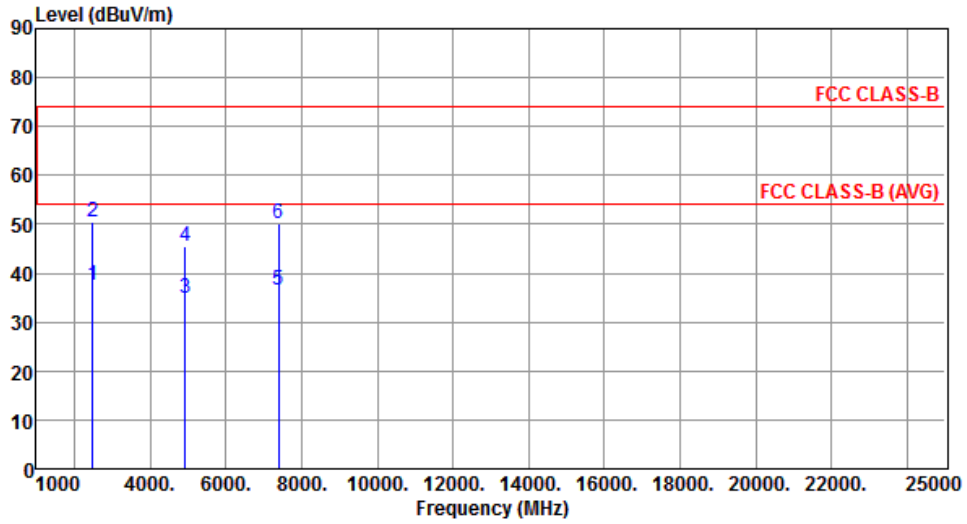

	Freq. MHz	Emission level dBuV/m	Limit dBuV/m	Margin dB	SA reading dBuV	Factor dB	Remark	ANT High cm	Turn Table deg
1	2483.50	37.47	54.00	-16.53	40.69	-3.22	Average	100	60
2	2483.50	50.47	74.00	-23.53	53.69	-3.22	Peak	100	60
3	4924.00	35.01	54.00	-18.99	31.30	3.71	Average	100	75
4	4924.00	45.41	74.00	-28.59	41.70	3.71	Peak	100	75
5	7386.00	36.57	54.00	-17.43	28.02	8.55	Average	100	10
6	7386.00	50.13	74.00	-23.87	41.58	8.55	Peak	100	10

Note 1: Emission Level (dBuV/m) = SA Reading (dBuV/m) + Factor* (dB)

*Factor includes antenna factor , cable loss and amplifier gain

Note 2: Margin (dB) = Emission level (dBuV/m) – Limit (dBuV/m).

Modulation	11b	Test Freq. (MHz)	2462
Polarization	Vertical		

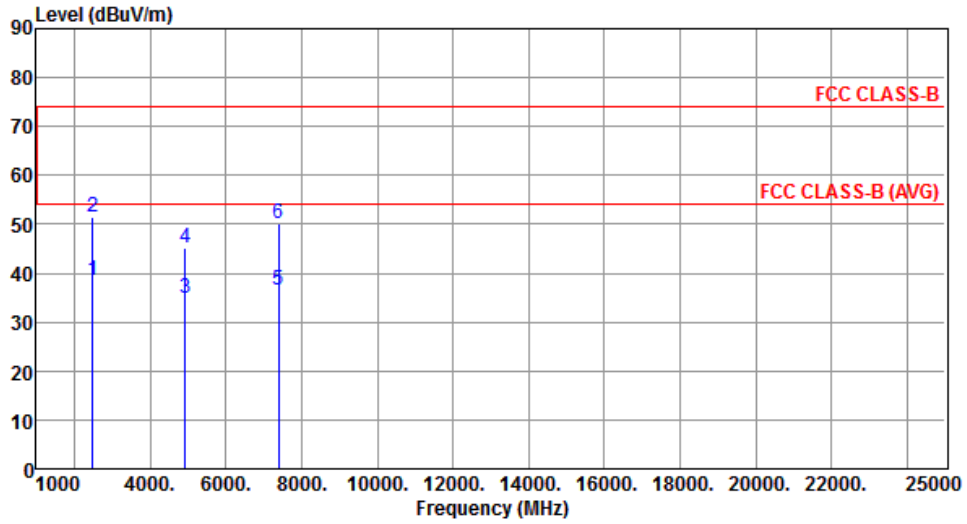

	Freq. MHz	Emission level dBuV/m	Limit dBuV/m	Margin dB	SA reading dBuV	Factor dB	Remark	ANT High cm	Turn Table deg
1	2483.50	38.43	54.00	-15.57	41.65	-3.22	Average	100	221
2	2483.50	51.47	74.00	-22.53	54.69	-3.22	Peak	100	221
3	4924.00	35.00	54.00	-19.00	31.29	3.71	Average	100	115
4	4924.00	45.28	74.00	-28.72	41.57	3.71	Peak	100	115
5	7386.00	36.61	54.00	-17.39	28.06	8.55	Average	100	100
6	7386.00	50.09	74.00	-23.91	41.54	8.55	Peak	100	100

Note 1: Emission Level (dBuV/m) = SA Reading (dBuV/m) + Factor* (dB)

*Factor includes antenna factor , cable loss and amplifier gain

Note 2: Margin (dB) = Emission level (dBuV/m) – Limit (dBuV/m).

3.5.6 Transmitter Radiated Unwanted Emissions (Above 1GHz) for 11g

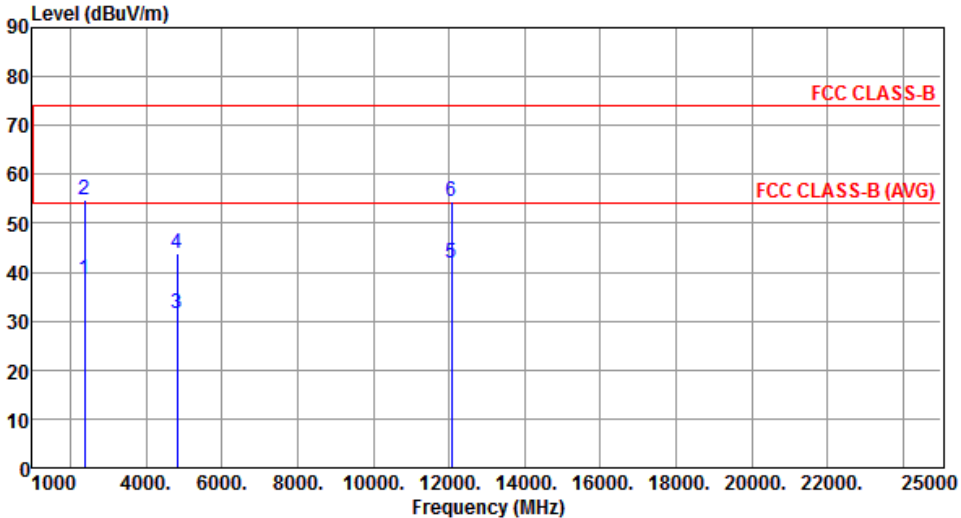
Modulation	11g	Test Freq. (MHz)	2412						
Polarization	Horizontal								
									
	Freq. MHz	Emission level dBuV/m	Limit dBuV/m	Margin dB	SA reading dBuV	Factor dB	Remark	ANT High cm	Turn Table deg
1	2390.00	38.37	54.00	-15.63	41.44	-3.07	Average	100	58
2	2390.00	54.89	74.00	-19.11	57.96	-3.07	Peak	100	58
3	4824.00	31.65	54.00	-22.35	28.12	3.53	Average	100	30
4	4824.00	43.79	74.00	-30.21	40.26	3.53	Peak	100	30
5	12060.00	41.92	54.00	-12.08	28.65	13.27	Average	100	40
6	12060.00	54.52	74.00	-19.48	41.25	13.27	Peak	100	40

Note 1: Emission Level (dBuV/m) = SA Reading (dBuV/m) + Factor* (dB)
*Factor includes antenna factor , cable loss and amplifier gain
Note 2: Margin (dB) = Emission level (dBuV/m) – Limit (dBuV/m).

Modulation	11g	Test Freq. (MHz)	2412
Polarization	Vertical		

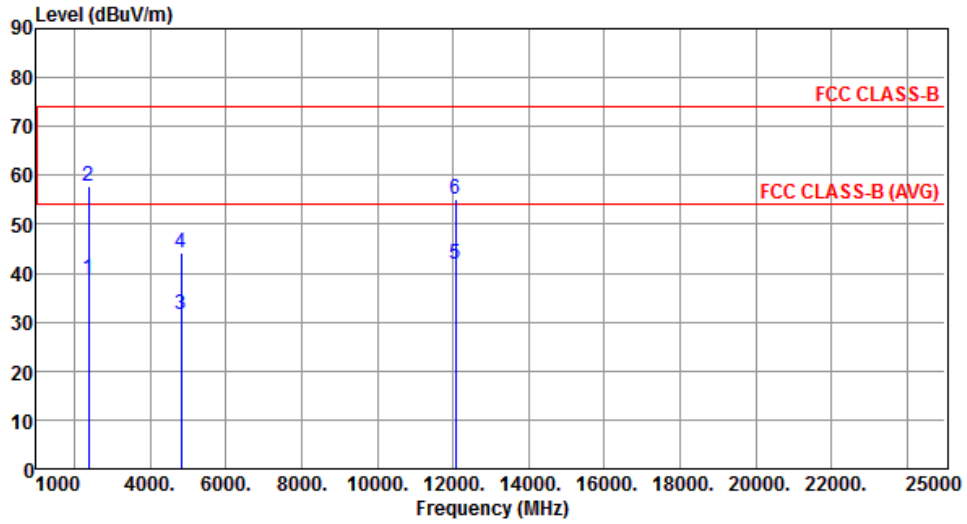

	Freq. MHz	Emission level dBuV/m	Limit dBuV/m	Margin dB	SA reading dBuV	Factor dB	Remark	ANT High cm	Turn Table deg
1	2390.00	38.81	54.00	-15.19	41.88	-3.07	Average	104	204
2	2390.00	57.95	74.00	-16.05	61.02	-3.07	Peak	104	204
3	4824.00	31.69	54.00	-22.31	28.16	3.53	Average	100	200
4	4824.00	44.11	74.00	-29.89	40.58	3.53	Peak	100	200
5	12060.00	41.84	54.00	-12.16	28.57	13.27	Average	100	200
6	12060.00	54.96	74.00	-19.04	41.69	13.27	Peak	100	200

Note 1: Emission Level (dBuV/m) = SA Reading (dBuV/m) + Factor* (dB)

*Factor includes antenna factor , cable loss and amplifier gain

Note 2: Margin (dB) = Emission level (dBuV/m) – Limit (dBuV/m).

Modulation	11g	Test Freq. (MHz)	2437
Polarization	Horizontal		

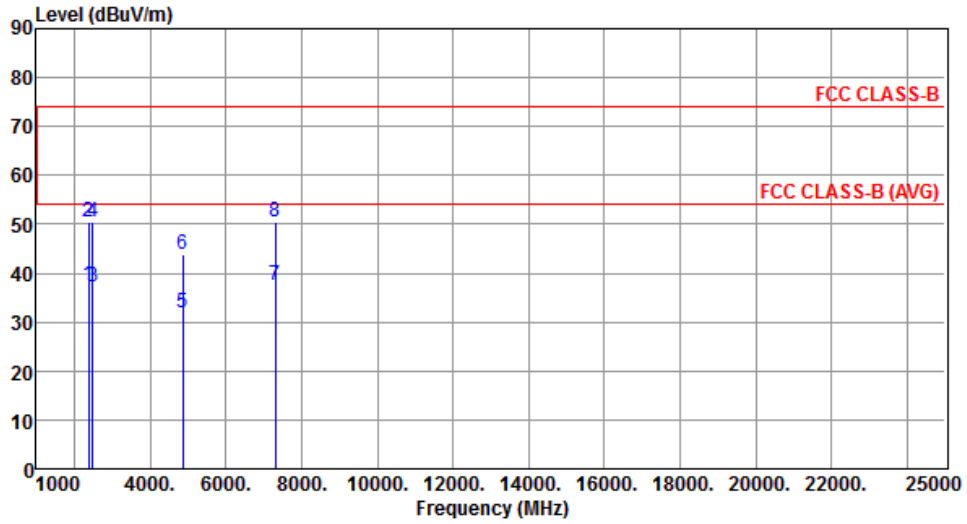

	Freq. MHz	Emission level dBuV/m	Limit dBuV/m	Margin dB	SA reading dBuV	Factor dB	Remark	ANT High cm	Turn Table deg
1	2390.00	37.51	54.00	-16.49	40.58	-3.07	Average	100	62
2	2390.00	50.40	74.00	-23.60	53.47	-3.07	Peak	100	62
3	2483.50	37.35	54.00	-16.65	40.57	-3.22	Average	100	62
4	2483.50	50.43	74.00	-23.57	53.65	-3.22	Peak	100	62
5	4874.00	31.75	54.00	-22.25	28.15	3.60	Average	100	50
6	4874.00	43.99	74.00	-30.01	40.39	3.60	Peak	100	50
7	7311.00	37.56	54.00	-16.44	28.74	8.82	Average	100	90
8	7311.00	50.39	74.00	-23.61	41.57	8.82	Peak	100	90

Note 1: Emission Level (dBuV/m) = SA Reading (dBuV/m) + Factor* (dB)

*Factor includes antenna factor , cable loss and amplifier gain

Note 2: Margin (dB) = Emission level (dBuV/m) – Limit (dBuV/m).

Modulation	11g	Test Freq. (MHz)	2437
Polarization	Vertical		

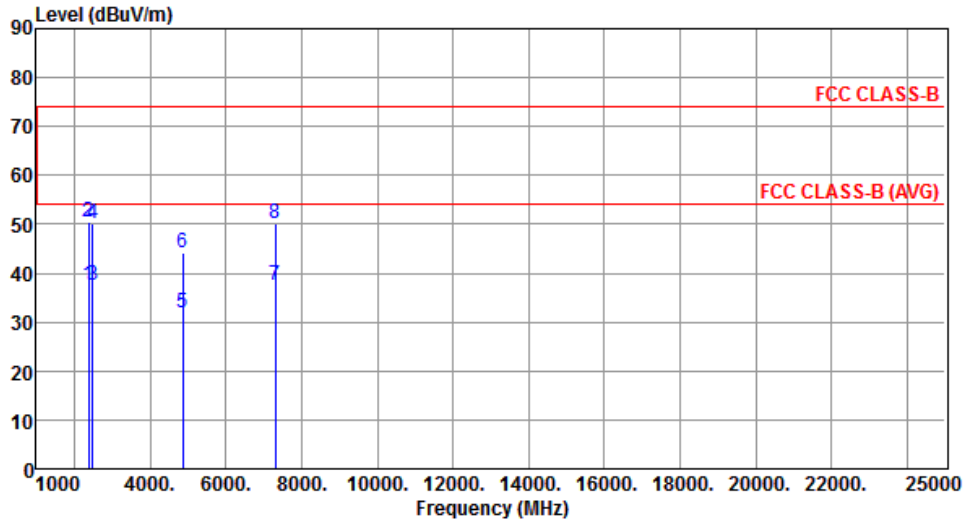

	Freq. MHz	Emission level dBuV/m	Limit dBuV/m	Margin dB	SA reading dBuV	Factor dB	Remark	ANT High cm	Turn Table deg
1	2390.00	37.58	54.00	-16.42	40.65	-3.07	Average	100	208
2	2390.00	50.57	74.00	-23.43	53.64	-3.07	Peak	100	208
3	2483.50	37.47	54.00	-16.53	40.69	-3.22	Average	100	208
4	2483.50	50.25	74.00	-23.75	53.47	-3.22	Peak	100	208
5	4874.00	31.74	54.00	-22.26	28.14	3.60	Average	100	90
6	4874.00	44.14	74.00	-29.86	40.54	3.60	Peak	100	90
7	7311.00	37.47	54.00	-16.53	28.65	8.82	Average	100	100
8	7311.00	50.29	74.00	-23.71	41.47	8.82	Peak	100	100

Note 1: Emission Level (dBuV/m) = SA Reading (dBuV/m) + Factor* (dB)

*Factor includes antenna factor , cable loss and amplifier gain

Note 2: Margin (dB) = Emission level (dBuV/m) – Limit (dBuV/m).

Modulation	11g	Test Freq. (MHz)	2462
Polarization	Horizontal		

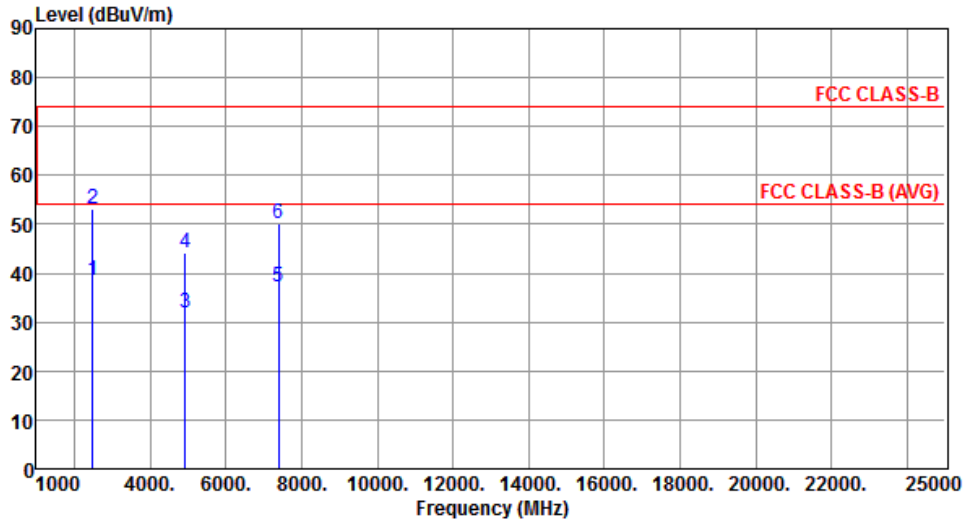

	Freq. MHz	Emission level dBuV/m	Limit dBuV/m	Margin dB	SA reading dBuV	Factor dB	Remark	ANT High cm	Turn Table deg
1	2483.50	38.43	54.00	-15.57	41.65	-3.22	Average	100	61
2	2483.50	53.04	74.00	-20.96	56.26	-3.22	Peak	100	61
3	4924.00	31.87	54.00	-22.13	28.16	3.71	Average	100	30
4	4924.00	44.31	74.00	-29.69	40.60	3.71	Peak	100	30
5	7386.00	37.03	54.00	-16.97	28.48	8.55	Average	100	50
6	7386.00	50.02	74.00	-23.98	41.47	8.55	Peak	100	50

Note 1: Emission Level (dBuV/m) = SA Reading (dBuV/m) + Factor* (dB)

*Factor includes antenna factor , cable loss and amplifier gain

Note 2: Margin (dB) = Emission level (dBuV/m) – Limit (dBuV/m).

Modulation	11g	Test Freq. (MHz)	2462
Polarization	Vertical		

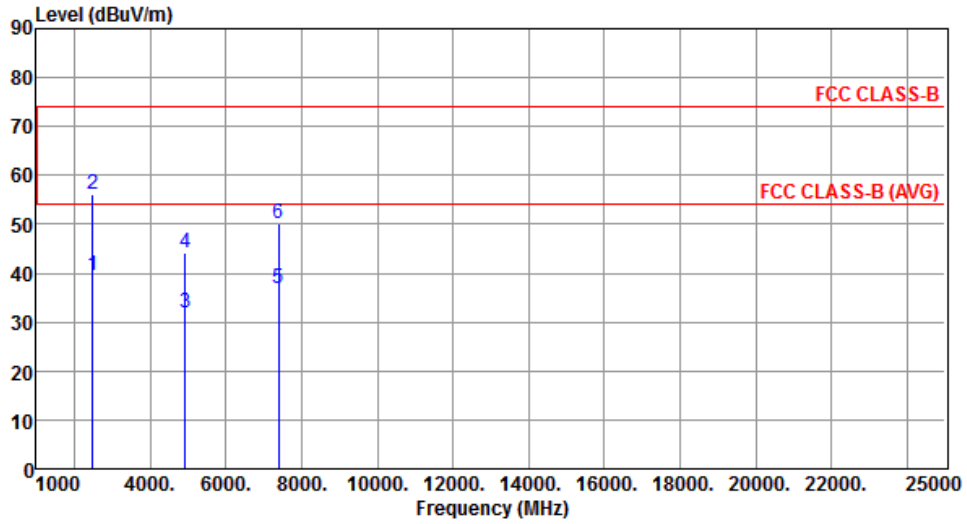

	Freq. MHz	Emission level dBuV/m	Limit dBuV/m	Margin dB	SA reading dBuV	Factor dB	Remark	ANT High cm	Turn Table deg
1	2483.50	39.54	54.00	-14.46	42.76	-3.22	Average	100	224
2	2483.50	56.20	74.00	-17.80	59.42	-3.22	Peak	100	224
3	4924.00	31.86	54.00	-22.14	28.15	3.71	Average	100	10
4	4924.00	44.29	74.00	-29.71	40.58	3.71	Peak	100	10
5	7386.00	37.00	54.00	-17.00	28.45	8.55	Average	100	90
6	7386.00	50.09	74.00	-23.91	41.54	8.55	Peak	100	90

Note 1: Emission Level (dBuV/m) = SA Reading (dBuV/m) + Factor* (dB)

*Factor includes antenna factor , cable loss and amplifier gain

Note 2: Margin (dB) = Emission level (dBuV/m) – Limit (dBuV/m).

3.5.7 Transmitter Radiated Unwanted Emissions (Above 1GHz) for HT20

Modulation	HT20	Test Freq. (MHz)	2412
Polarization	Horizontal		

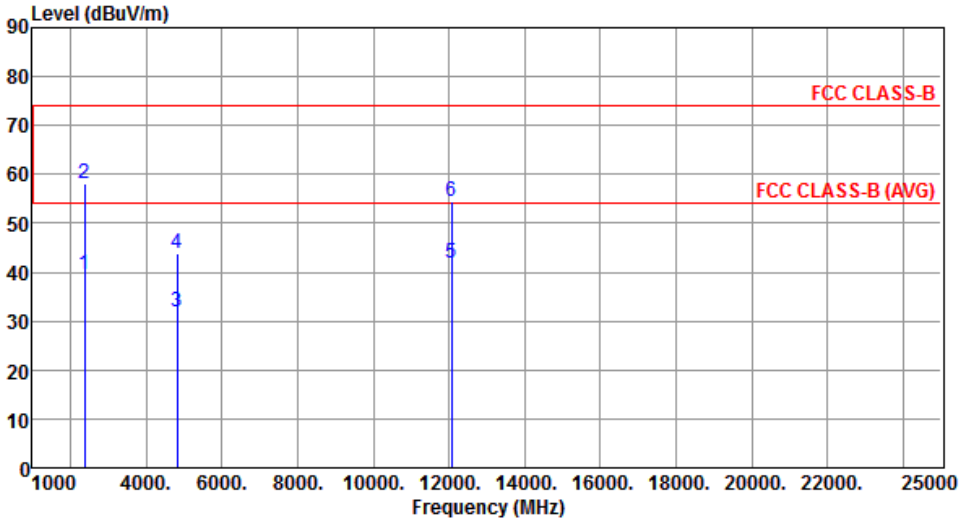

	Freq. MHz	Emission level dBuV/m	Limit dBuV/m	Margin dB	SA reading dBuV	Factor dB	Remark	ANT High cm	Turn Table deg
1	2390.00	39.38	54.00	-14.62	42.45	-3.07	Average	100	58
2	2390.00	58.16	74.00	-15.84	61.23	-3.07	Peak	100	58
3	4824.00	31.74	54.00	-22.26	28.21	3.53	Average	100	30
4	4824.00	43.79	74.00	-30.21	40.26	3.53	Peak	100	30
5	12060.00	41.84	54.00	-12.16	28.57	13.27	Average	100	50
6	12060.00	54.60	74.00	-19.40	41.33	13.27	Peak	100	50

Note 1: Emission Level (dBuV/m) = SA Reading (dBuV/m) + Factor* (dB)
*Factor includes antenna factor , cable loss and amplifier gain
Note 2: Margin (dB) = Emission level (dBuV/m) – Limit (dBuV/m).

Modulation	HT20	Test Freq. (MHz)	2412
Polarization	Vertical		

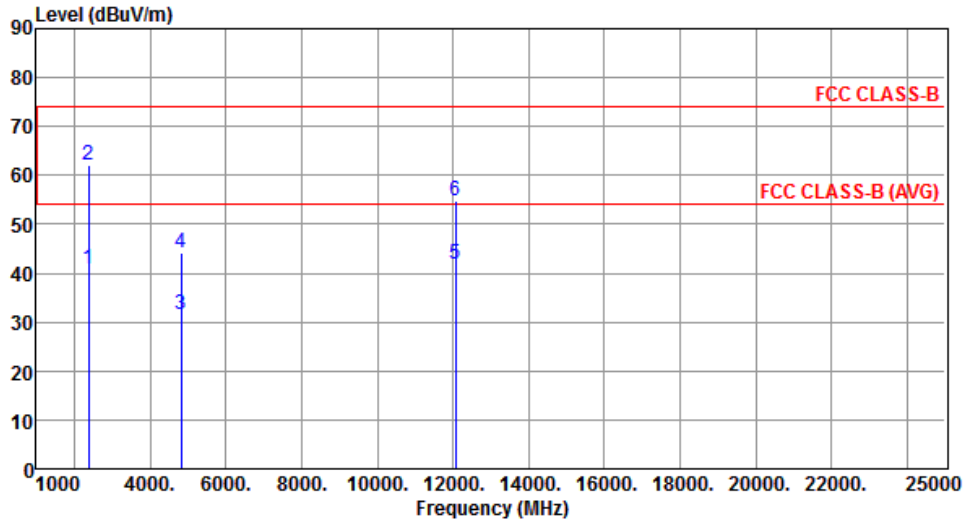

	Freq. MHz	Emission level dBuV/m	Limit dBuV/m	Margin dB	SA reading dBuV	Factor dB	Remark	ANT High cm	Turn Table deg
1	2390.00	40.69	54.00	-13.31	43.76	-3.07	Average	100	235
2	2390.00	62.24	74.00	-11.76	65.31	-3.07	Peak	100	235
3	4824.00	31.67	54.00	-22.33	28.14	3.53	Average	100	100
4	4824.00	44.15	74.00	-29.85	40.62	3.53	Peak	100	100
5	12060.00	41.74	54.00	-12.26	28.47	13.27	Average	100	150
6	12060.00	54.87	74.00	-19.13	41.60	13.27	Peak	100	150

Note 1: Emission Level (dBuV/m) = SA Reading (dBuV/m) + Factor* (dB)

*Factor includes antenna factor , cable loss and amplifier gain

Note 2: Margin (dB) = Emission level (dBuV/m) – Limit (dBuV/m).

Modulation	HT20	Test Freq. (MHz)	2437
Polarization	Horizontal		

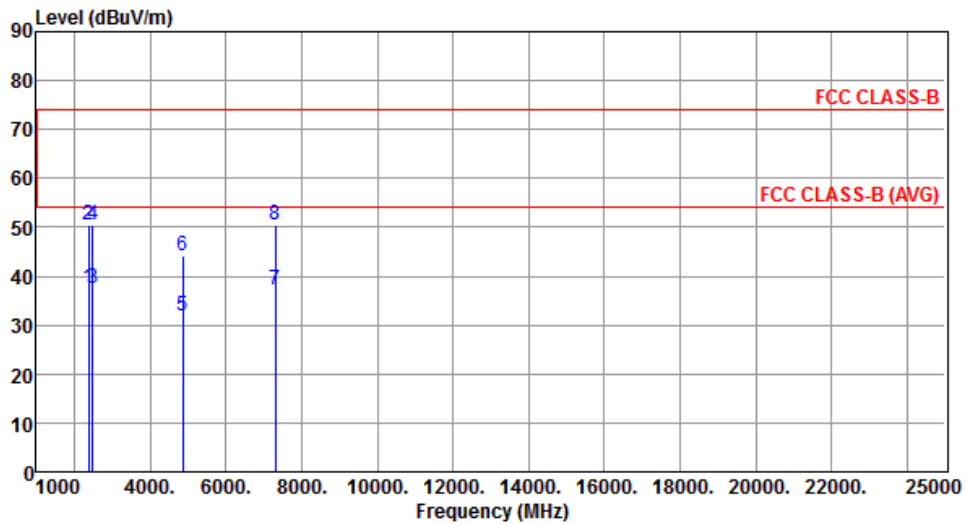

	Freq. MHz	Emission level dBuV/m	Limit dBuV/m	Margin dB	SA reading dBuV	Factor dB	Remark	ANT High cm	Turn Table deg
1	2390.00	37.58	54.00	-16.42	40.65	-3.07	Average	100	59
2	2390.00	50.49	74.00	-23.51	53.56	-3.07	Peak	100	59
3	2483.50	37.41	54.00	-16.59	40.63	-3.22	Average	100	59
4	2483.50	50.36	74.00	-23.64	53.58	-3.22	Peak	100	59
5	4874.00	31.81	54.00	-22.19	28.21	3.60	Average	100	50
6	4874.00	44.02	74.00	-29.98	40.42	3.60	Peak	100	50
7	7311.00	37.27	54.00	-16.73	28.45	8.82	Average	100	80
8	7311.00	50.44	74.00	-23.56	41.62	8.82	Peak	100	80

Note 1: Emission Level (dBuV/m) = SA Reading (dBuV/m) + Factor* (dB)

*Factor includes antenna factor , cable loss and amplifier gain

Note 2: Margin (dB) = Emission level (dBuV/m) – Limit (dBuV/m).

Modulation	HT20	Test Freq. (MHz)	2437
Polarization	Vertical		

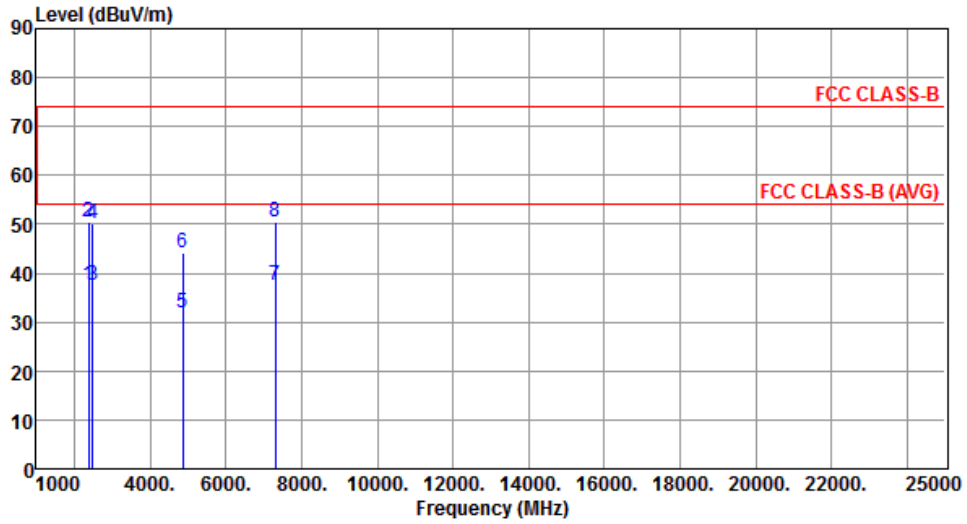

	Freq. MHz	Emission level dBuV/m	Limit dBuV/m	Margin dB	SA reading dBuV	Factor dB	Remark	ANT High cm	Turn Table deg
1	2390.00	37.46	54.00	-16.54	40.53	-3.07	Average	100	230
2	2390.00	50.61	74.00	-23.39	53.68	-3.07	Peak	100	230
3	2483.50	37.47	54.00	-16.53	40.69	-3.22	Average	100	230
4	2483.50	50.30	74.00	-23.70	53.52	-3.22	Peak	100	230
5	4874.00	31.77	54.00	-22.23	28.17	3.60	Average	100	100
6	4874.00	44.22	74.00	-29.78	40.62	3.60	Peak	100	100
7	7311.00	37.40	54.00	-16.60	28.58	8.82	Average	100	120
8	7311.00	50.38	74.00	-23.62	41.56	8.82	Peak	100	120

Note 1: Emission Level (dBuV/m) = SA Reading (dBuV/m) + Factor* (dB)

*Factor includes antenna factor , cable loss and amplifier gain

Note 2: Margin (dB) = Emission level (dBuV/m) – Limit (dBuV/m).

Modulation	HT20	Test Freq. (MHz)	2462
Polarization	Horizontal		

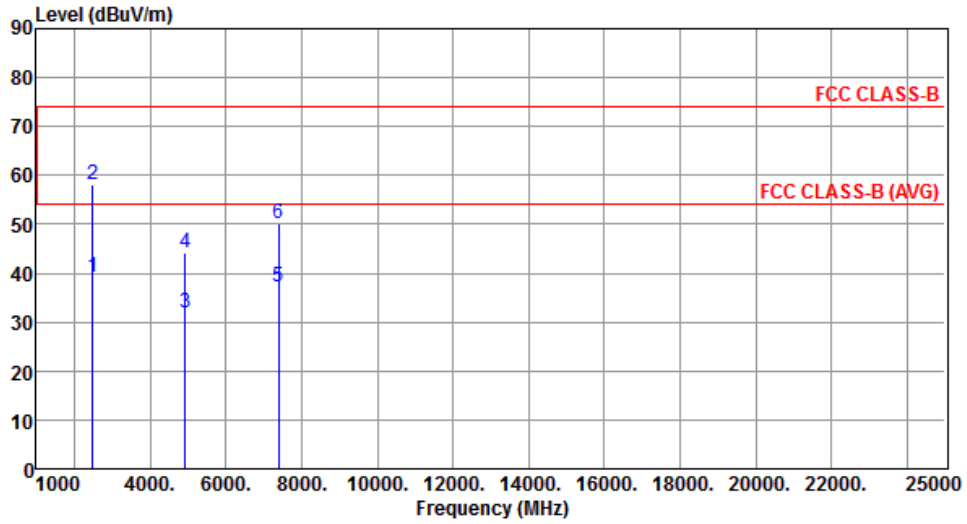

	Freq. MHz	Emission level dBuV/m	Limit dBuV/m	Margin dB	SA reading dBuV	Factor dB	Remark	ANT High cm	Turn Table deg
1	2483.50	39.03	54.00	-14.97	42.25	-3.22	Average	100	59
2	2483.50	58.01	74.00	-15.99	61.23	-3.22	Peak	100	59
3	4924.00	31.83	54.00	-22.17	28.12	3.71	Average	100	20
4	4924.00	44.30	74.00	-29.70	40.59	3.71	Peak	100	20
5	7386.00	37.09	54.00	-16.91	28.54	8.55	Average	100	90
6	7386.00	50.11	74.00	-23.89	41.56	8.55	Peak	100	90

Note 1: Emission Level (dBuV/m) = SA Reading (dBuV/m) + Factor* (dB)

*Factor includes antenna factor , cable loss and amplifier gain

Note 2: Margin (dB) = Emission level (dBuV/m) – Limit (dBuV/m).

Modulation	HT20	Test Freq. (MHz)	2462
Polarization	Vertical		

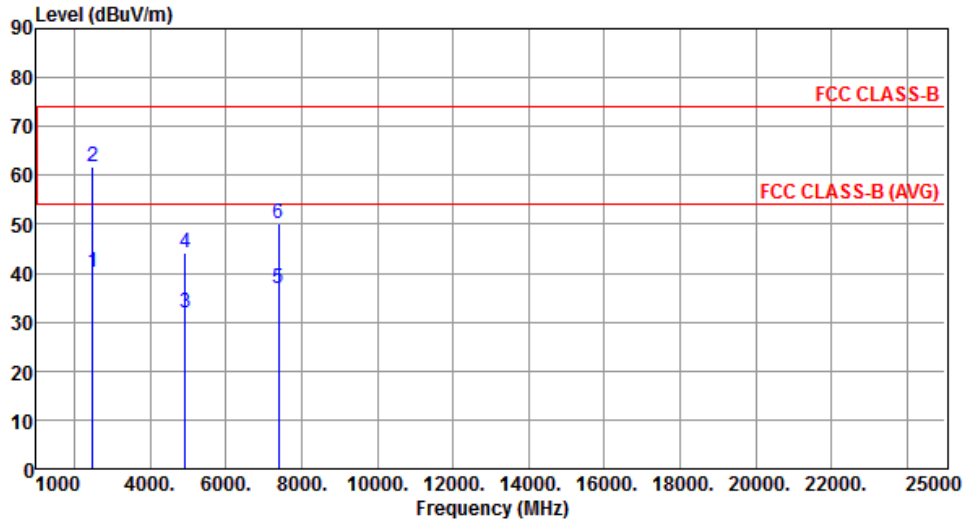

	Freq. MHz	Emission level dBuV/m	Limit dBuV/m	Margin dB	SA reading dBuV	Factor dB	Remark	ANT High cm	Turn Table deg
1	2483.50	40.33	54.00	-13.67	43.55	-3.22	Average	100	240
2	2483.50	61.87	74.00	-12.13	65.09	-3.22	Peak	100	240
3	4924.00	31.84	54.00	-22.16	28.13	3.71	Average	100	200
4	4924.00	44.29	74.00	-29.71	40.58	3.71	Peak	100	200
5	7386.00	37.00	54.00	-17.00	28.45	8.55	Average	100	100
6	7386.00	50.02	74.00	-23.98	41.47	8.55	Peak	100	100

Note 1: Emission Level (dBuV/m) = SA Reading (dBuV/m) + Factor* (dB)

*Factor includes antenna factor , cable loss and amplifier gain

Note 2: Margin (dB) = Emission level (dBuV/m) – Limit (dBuV/m).

3.6 Emissions in Non-Restricted Frequency Bands

3.6.1 Emissions in Non-Restricted Frequency Bands Limit

Peak power in any 100 kHz bandwidth outside of the authorized frequency band shall be attenuated by at least 20 dB relative to the maximum in-band peak PSD level in 100 kHz.

3.6.2 Test Procedures

Reference level measurement

1. Set RBW=100kHz, VBW = 300kHz , Detector = Peak, Sweep time = Auto
2. Trace = max hold , Allow Trace to fully stabilize
3. Use the peak marker function to determine the maximum PSD level

Emission level measurement

1. Set RBW=100kHz, VBW = 300kHz , Detector = Peak, Sweep time = Auto
2. Trace = max hold , Allow Trace to fully stabilize
3. Scan Frequency range is up to 25GHz
4. Use the peak marker function to determine the maximum amplitude level

3.6.3 Test Setup

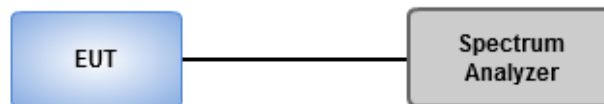

3.6.4 Unwanted Emissions into Non-Restricted Frequency Bands

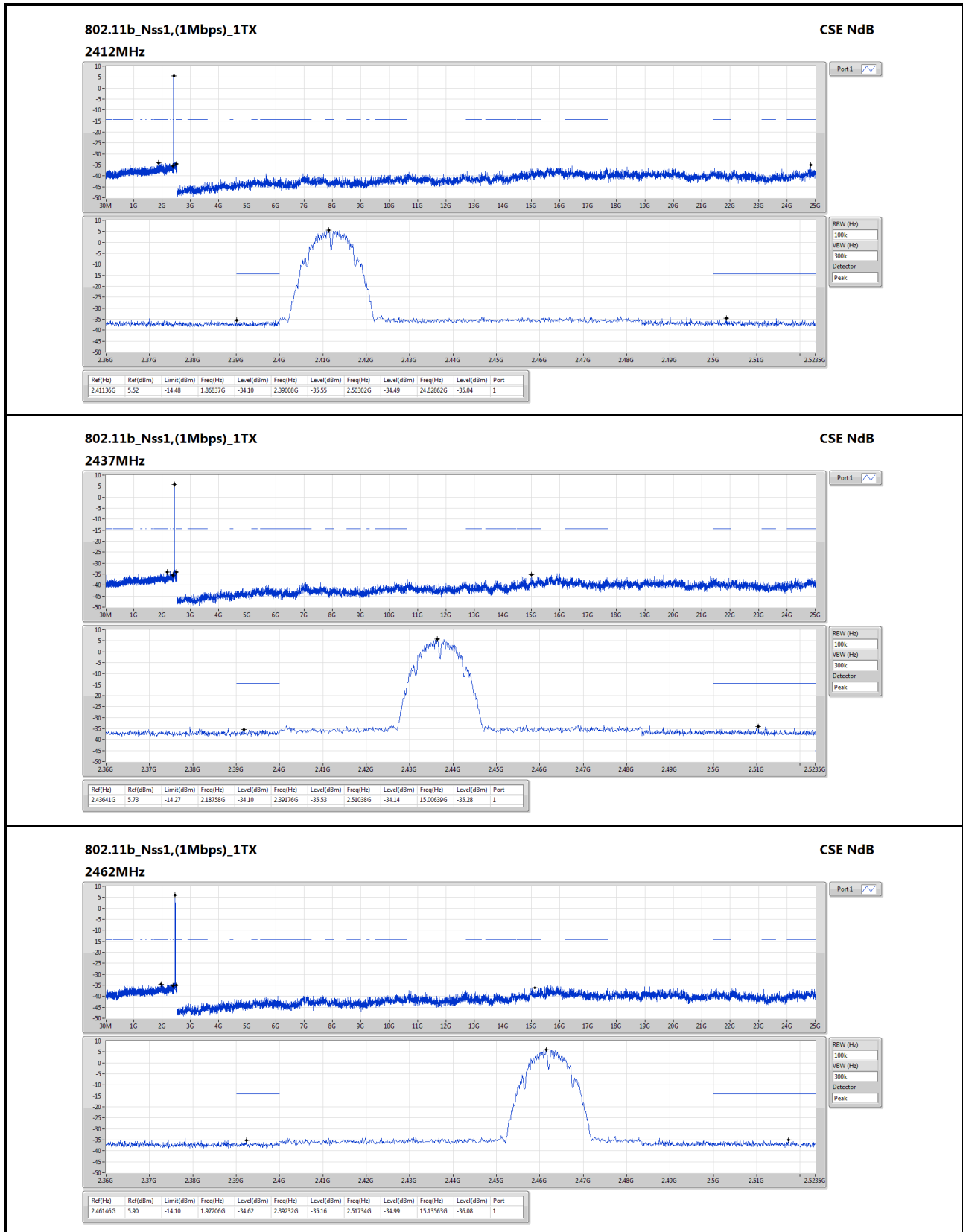

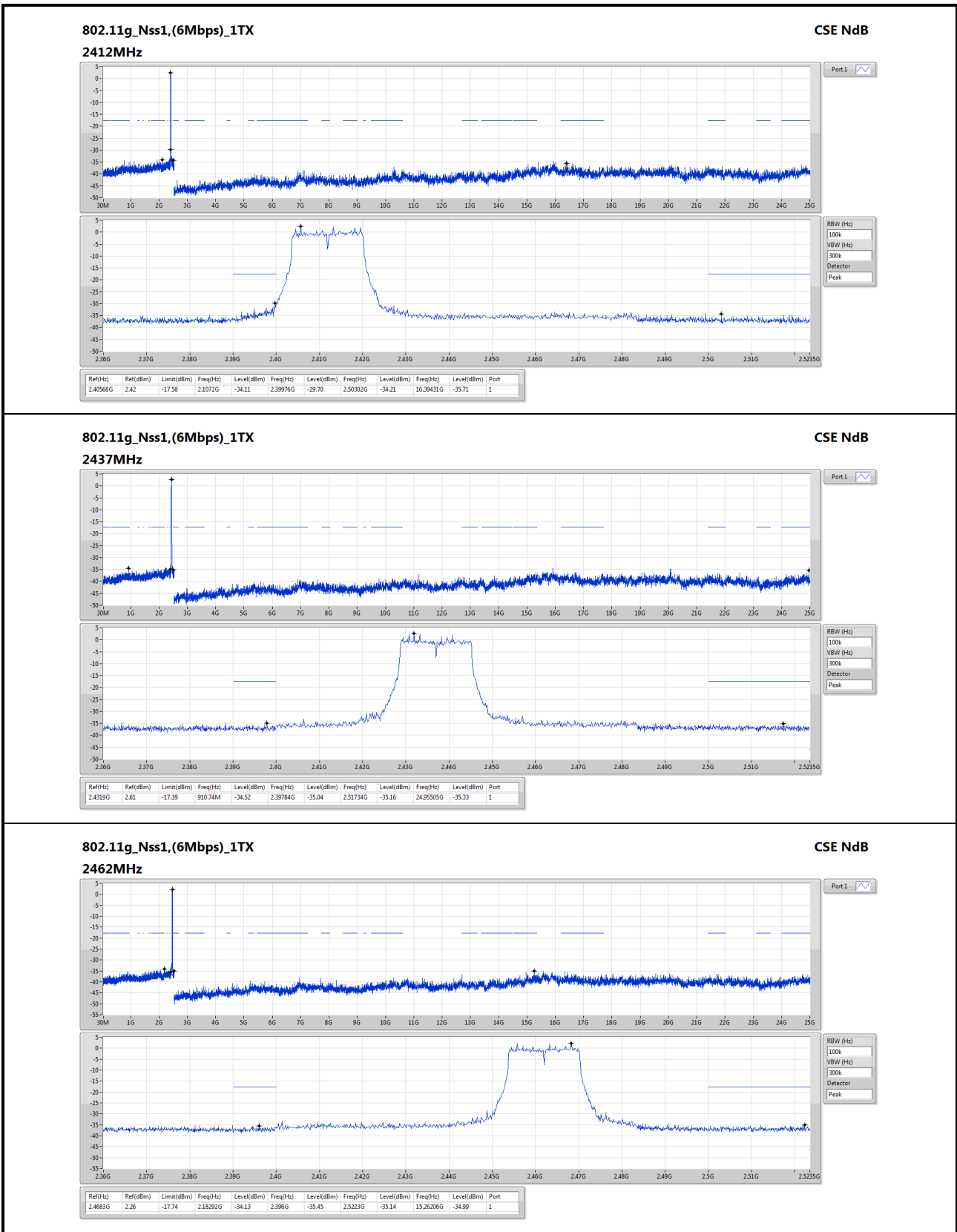

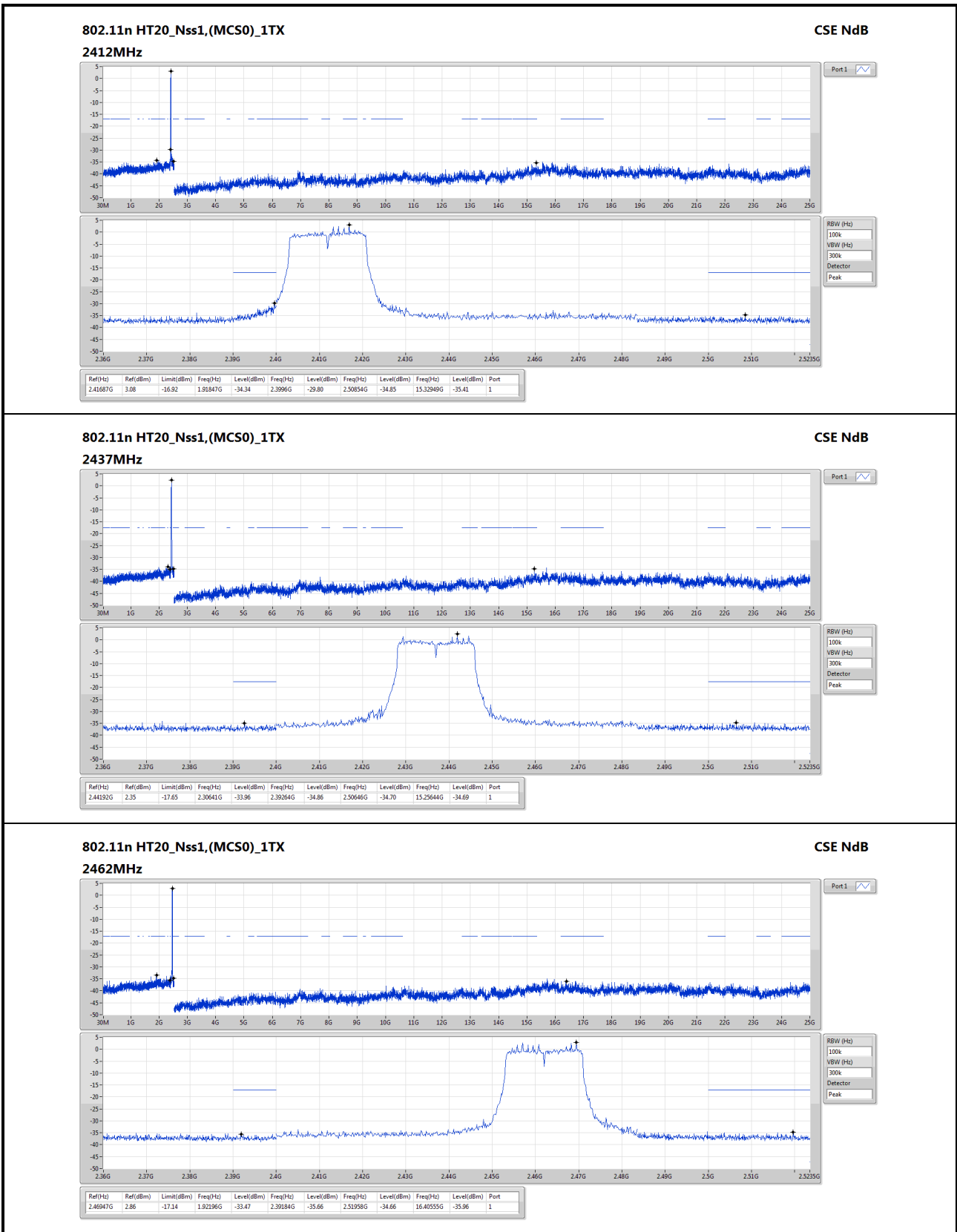

4 Test laboratory information

Established in 2012, ICC provides foremost EMC & RF Testing and advisory consultation services by our skilled engineers and technicians. Our services employ a wide variety of advanced edge test equipment and one of the widest certification extents in the business.

International Certification Corp (EMC and Wireless Communication Laboratory), it is our definitive objective is to institute long term, trust-based associations with our clients. The expectation we set up with our clients is based on outstanding service, practical expertise and devotion to a certified value structure. Our passion is to grant our clients with best EMC / RF services by oriented knowledgeable and accommodating staff.

Our Test sites are located at Linkou District and Kwei Shan District. Location map can be found on our website <http://www.icertifi.com.tw>.

Linkou

Tel: 886-2-2601-1640

No. 30-2, Ding Fwu Tsuen, Lin
Kou District, New Taipei City,
Taiwan, R.O.C.

Kwei Shan

Tel: 886-3-271-8666

No. 3-1, Lane 6, Wen San 3rd St.,
Kwei Shan District, Tao Yuan City
333, Taiwan, R.O.C.

Kwei Shan Site II

Tel: 886-3-271-8640

No. 14-1, Lane 19, Wen San 3rd
St., Kwei Shan District, Tao Yuan
City 333, Taiwan, R.O.C.

If you have any suggestion, please feel free to contact us as below information.

Tel: 886-3-271-8666

Fax: 886-3-318-0155

Email: ICC_Service@icertifi.com.tw

==END==