



FCC CERTIFICATION REPORT

Test Report No. : MH/2018/70100
Applicant : FUJITSU CONNECTED TECHNOLOGIES Ltd.
Address : 1-1, Kamikodanaka 4-chome, Nakahara-ku, Kawasaki 211-8588, Japan
Manufacturer : FUJITSU CONNECTED TECHNOLOGIES Ltd.
Address : 1-1, Kamikodanaka 4-chome, Nakahara-ku, Kawasaki 211-8588, Japan
Equipment Under Test (EUT) :
Product Name : Smart Phone
Brand Name : FUJITSU
Model No. : F-01L
Added Model(s) : N/A

Standards : FCC Part 15, Subpart B, Class B
FCC Designation Numbers : 916890 / TW1087

Date of Receipt : Aug. 20th, 2018
Date of Test : Aug. 20th ~ Sep. 4th, 2018
Date of Issue : Sep. 28th, 2018

Test Result :	PASS
----------------------	-------------

In the configuration tested, the EUT complied with the standards specified above.

Remarks :

This report details the results of the testing carried out on one sample, the results contained in this test report do not relate to other samples of the same product. The manufacturer should ensure that all products in series production are in conformity with the product sample detailed in this report.

This report shall not be reproduced except in full, without the written approval of the laboratory. If the product in this report is used in any configuration other than that detailed in the report, the manufacturer must ensure the new system complies with all relevant standards.

Tested By:

Thomas Liu

Date

Sep. 28th, 2018

Thomas Liu (Engineer)

Approved By

Eddy Cheng

Date

Sep. 28th, 2018

Eddy Cheng (Asst. Supervisor)



Unless otherwise stated the results shown in this test report refer only to the sample(s) tested and such sample(s) are retained for 90 days only.
 除非另有說明，此報告結果僅對測試之樣品負責，同時此樣品僅保留90天。本報告未經本公司書面許可，不可部份複製。

This document is issued by the Company subject to its General Conditions of Service printed overleaf, available on request or accessible at www.sgs.com/terms_and_conditions.htm and for electronic format documents, subject to Terms and Conditions for Electronic Documents at www.sgs.com/terms_e-document.htm. Attention is drawn to the limitation of liability, indemnification and jurisdiction issues defined therein. Any holder of this document is advised that information contained hereon reflects the Company's findings at the time of its intervention only and within the limits of Client's instructions, if any. The Company's sole responsibility is to its Client and this document does not exonerate parties to a transaction from exercising all their rights and obligations under the transaction documents. This document cannot be reproduced except in full, without prior written approval of the Company. Any unauthorized alteration, forgery or falsification of the content or appearance of this document is unlawful and offenders may be prosecuted to the fullest extent of the law.



Revision History

Report Number	Revision	Description	Issue Date
MH/2018/70100	Rev.00	Initial creation of document	Sep. 28th, 2018

Unless otherwise stated the results shown in this test report refer only to the sample(s) tested and such sample(s) are retained for 90 days only.
 除非另有說明，此報告結果僅對測試之樣品負責，同時此樣品僅保留90天。本報告未經本公司書面許可，不可部份複製。

This document is issued by the Company subject to its General Conditions of Service printed overleaf, available on request or accessible at www.sgs.com/terms_and_conditions.htm and for electronic format documents, subject to Terms and Conditions for Electronic Documents at www.sgs.com/terms_e-document.htm. Attention is drawn to the limitation of liability, indemnification and jurisdiction issues defined therein. Any holder of this document is advised that information contained hereon reflects the Company's findings at the time of its intervention only and within the limits of Client's instructions, if any. The Company's sole responsibility is to its Client and this document does not exonerate parties to a transaction from exercising all their rights and obligations under the transaction documents. This document cannot be reproduced except in full, without prior written approval of the Company. Any unauthorized alteration, forgery or falsification of the content or appearance of this document is unlawful and offenders may be prosecuted to the fullest extent of the law.



Contents

1. GENERAL INFORMATION	4
1.1 APPLICANT & MANUFACTURER INFORMATION	4
1.2 GENERAL DESCRIPTION OF EUT	4
1.3 DETAILS OF EUT	4
1.4 OPERATION PROCEDURE	6
1.5 DESCRIPTION OF SUPPORT UNITS	8
1.6 MODIFICATION LIST	8
1.7 ACCESSORIES CABLE LIST	8
1.8 TEST SET-UP CONFIGURATION.....	9
1.9 MEASUREMENT PROCEDURE	10
1.10 STANDARDS APPLICABLE FOR TESTING.....	10
1.11 SUMMARY OF RESULTS	10
2. EMISSION	11
2.1 TEST RESULTS	11
2.2 FREQUENCY RANGE.....	11
2.3 LIMITS OF CONDUCTED AND RADIATED EMISSION	11
2.3.1 LIMITS OF CONDUCTED EMISSION	11
2.3.2 LIMITS OF RADIATED EMISSIONS	12
2.4. TEST OF CONDUCTED EMISSION.....	13
2.4.1 TEST EQUIPMENTS	13
2.4.2 OPERATING ENVIRONMENT	13
2.4.3 MEASUREMENT LEVEL CALCULATION.....	13
2.4.4 MEASUREMENT DATA:.....	14
2.5 TEST OF RADIATED EMISSION.....	16
2.5.1 TEST EQUIPMENTS	16
2.5.2 OPERATING ENVIRONMENT	18
2.5.3 MEASUREMENT LEVEL CALCULATION.....	18
2.5.4 MEASUREMENT DATA.....	19
3. PHOTOGRAPHS OF TEST	25

Unless otherwise stated the results shown in this test report refer only to the sample(s) tested and such sample(s) are retained for 90 days only.
 除非另有說明，此報告結果僅對測試之樣品負責，同時此樣品僅保留90天。本報告未經本公司書面許可，不可部份複製。

This document is issued by the Company subject to its General Conditions of Service printed overleaf, available on request or accessible at www.sgs.com/terms_and_conditions.htm and for electronic format documents, subject to Terms and Conditions for Electronic Documents at www.sgs.com/terms_e-document.htm. Attention is drawn to the limitation of liability, indemnification and jurisdiction issues defined therein. Any holder of this document is advised that information contained hereon reflects the Company's findings at the time of its intervention only and within the limits of Client's instructions, if any. The Company's sole responsibility is to its Client and this document does not exonerate parties to a transaction from exercising all their rights and obligations under the transaction documents. This document cannot be reproduced except in full, without prior written approval of the Company. Any unauthorized alteration, forgery or falsification of the content or appearance of this document is unlawful and offenders may be prosecuted to the fullest extent of the law.



1. General Information

1.1 Applicant & Manufacturer Information

Applicant : FUJITSU CONNECTED TECHNOLOGIES Ltd.
 Address of Applicant : 1-1, Kamikodanaka 4-chome, Nakahara-ku, Kawasaki
 211-8588, Japan
 Manufacturer : FUJITSU CONNECTED TECHNOLOGIES Ltd.
 Address of Manufacturer : 1-1, Kamikodanaka 4-chome, Nakahara-ku, Kawasaki
 211-8588, Japan

1.2 General Description of EUT

Product Name : Smart Phone
 Brand Name : FUJITSU
 Model No. : F-01L
 Added Model(s) : N/A
 Model Difference : N/A

1.3 Details of EUT

Power Supply : AC 100~240V, 50~60Hz
 Modes/Function : Mode 1. ADP + Earphone + WiFi Link+NFC OFF+
 BT Link + GPS/Glonass Link +SD Card+
 GSM : 850 Link
 Mode 2. ADP + Earphone + WiFi Idle+NFC OFF +
 BT Idle + GPS/Glonass Idle + SD Card +
 GSM : 1900Idle
 Mode 3. WiFi Link + NFC ON(Standalone) +
 BT Link + GPS/Glonass Link +SD Card +
 GSM : 850/1900 (Wosrt) Single
 Mode 4. ADP + Earphone + WiFi Idle +NFC OFF+
 BT Idle + GPS/Glonass Idle + SD Card +
 WCDMA : B5 Idle
 Mode 5. ADP + Earphone + WiFi Link+NFC OFF+
 BT Link + GPS/Glonass Link + SD Card+
 LTE : B5 Link

Unless otherwise stated the results shown in this test report refer only to the sample(s) tested and such sample(s) are retained for 90 days only.
 除非另有說明，此報告結果僅對測試之樣品負責，同時此樣品僅保留90天。本報告未經本公司書面許可，不可部份複製。

This document is issued by the Company subject to its General Conditions of Service printed overleaf, available on request or accessible at www.sgs.com/terms_and_conditions.htm and for electronic format documents, subject to Terms and Conditions for Electronic Documents at www.sgs.com/terms_e-document.htm. Attention is drawn to the limitation of liability, indemnification and jurisdiction issues defined therein. Any holder of this document is advised that information contained hereon reflects the Company's findings at the time of its intervention only and within the limits of Client's instructions, if any. The Company's sole responsibility is to its Client and this document does not exonerate parties to a transaction from exercising all their rights and obligations under the transaction documents. This document cannot be reproduced except in full, without prior written approval of the Company. Any unauthorized alteration, forgery or falsification of the content or appearance of this document is unlawful and offenders may be prosecuted to the fullest extent of the law.

Mode 6. ADP + Earphone + Camera Rear REC +
WiFi Link + NFC OFF + BT Stand by +
GPS/Glonass Link + SD Card

Mode 7. ADP + Earphone+ Camera Front REC+
WiFi Link + NFC OFF + BT Stand by +
GPS/Glonass Link + SD Card

Mode 8. WiFi Link + BT Link+GPS/Glonass Link +
Earphone + SD Card + USB Cable +
SD Write

Mode 9. WiFi Link + BT Link +GPS/Glonass Link+
Earphone + SD Card + USB Cable +
SD Read

Worst case

: CE worst case :

Mode 6. ADP + Earphone + Camera Rear REC +
WiFi Link + NFC OFF + BT Stand by +
GPS/Glonass Link + SD Card

Below / Above RE worst case :

Mode 8. WiFi Link + BT Link+GPS/Glonass Link +
Earphone + SD Card + USB Cable +
SD Write

Highest operate description : 5GHz

Adapter

: Model No.: AC Adapter 06

Supplier : docmo

I/P : AC 100-240V, 50/60Hz, 0.8A

O/P : DC 5.0V, 3.0A / DC 9.0V, 3.0A /
DC 12.0V, 2.25A

Battery

: Model No.: CA54310-0075-A1

Supplier : FUJITSU CONNECTED

TECHNOLOGIES LIMITED

3.8V, 2110mAh, 8.1Wh

IMEI

: 357963090014646

Unless otherwise stated the results shown in this test report refer only to the sample(s) tested and such sample(s) are retained for 90 days only.
除非另有說明，此報告結果僅對測試之樣品負責，同時此樣品僅保留90天。本報告未經本公司書面許可，不可部份複製。

This document is issued by the Company subject to its General Conditions of Service printed overleaf, available on request or accessible at www.sgs.com/terms_and_conditions.htm and for electronic format documents, subject to Terms and Conditions for Electronic Documents at www.sgs.com/terms_e-document.htm. Attention is drawn to the limitation of liability, indemnification and jurisdiction issues defined therein. Any holder of this document is advised that information contained hereon reflects the Company's findings at the time of its intervention only and within the limits of Client's instructions, if any. The Company's sole responsibility is to its Client and this document does not exonerate parties to a transaction from exercising all their rights and obligations under the transaction documents. This document cannot be reproduced except in full, without prior written approval of the Company. Any unauthorized alteration, forgery or falsification of the content or appearance of this document is unlawful and offenders may be prosecuted to the fullest extent of the law.



1.4 Operation Procedure

Mode 1

1. Let EUT connect to the Adapter and Earphone.
2. Turn on the WiFi of EUT and connect to the AP.
Turn on Bluetooth and connect to the Bluetooth speaker.
Turn off NFC.
Turn on the GPS and connect to GPS simulator.
Play 1KHz from SD Card.
Turn on GSM and call connection with CMU200(GSM850).
3. Start the test.

Mode 2

1. Let EUT connect to the Adapter and Earphone.
2. Turn on the WiFi of EUT and connect to the AP.
Turn on Bluetooth and connect to the Bluetooth speaker.
Turn off NFC.
Turn on the GPS and connect to GPS simulator.
Play 1KHz from SD Card.
Turn on GSM and call connection with CMU200(GSM1900).
3. Start the test.

Mode 3

1. Turn on the WiFi of EUT and connect to the AP.
Turn on NFC.
Turn on Bluetooth and connect to the Bluetooth speaker.
Turn on the GPS and connect to GPS simulator.
Play 1KHz from SD Card.
Turn on GSM and call connection with CMU200 Worst(GSM850/GSM1900).
2. Start the test.

Mode 4

1. Let EUT connect to the Adapter and Earphone.
2. Turn on the WiFi of EUT and connect to the AP.
Turn on Bluetooth and connect to the Bluetooth speaker.
Turn off NFC.
Turn on the GPS and connect to GPS simulator.
Play 1KHz from SD Card.
Turn on GSM and call connection with CMU200 (3G B).
3. Start the test.

Unless otherwise stated the results shown in this test report refer only to the sample(s) tested and such sample(s) are retained for 90 days only.
除非另有說明，此報告結果僅對測試之樣品負責，同時此樣品僅保留90天。本報告未經本公司書面許可，不可部份複製。

This document is issued by the Company subject to its General Conditions of Service printed overleaf, available on request or accessible at www.sgs.com/terms_and_conditions.htm and for electronic format documents, subject to Terms and Conditions for Electronic Documents at www.sgs.com/terms_e-document.htm. Attention is drawn to the limitation of liability, indemnification and jurisdiction issues defined therein. Any holder of this document is advised that information contained hereon reflects the Company's findings at the time of its intervention only and within the limits of Client's instructions, if any. The Company's sole responsibility is to its Client and this document does not exonerate parties to a transaction from exercising all their rights and obligations under the transaction documents. This document cannot be reproduced except in full, without prior written approval of the Company. Any unauthorized alteration, forgery or falsification of the content or appearance of this document is unlawful and offenders may be prosecuted to the fullest extent of the law.



Mode 5

1. Let EUT connect to the Adapter and Earphone.
2. Turn on the WiFi of EUT and connect to the AP.
Turn on Bluetooth and connect to the Bluetooth speaker.
Turn off NFC.
Turn on the GPS and connect to GPS simulator.
Play 1KHz from SD Card.
Turn on GSM and call connection with CMW500 (4G B5).
3. Start the test.

Mode 6

1. Let EUT connect to the Adapter and Earphone.
2. Turn on the rear camera to start recording.
Turn on the WiFi of EUT and connect to the AP.
Turn on Bluetooth and connect to the Bluetooth speaker.
Turn off NFC.
Turn on the GPS and connect to GPS simulator.
Play 1KHz from SD Card.
3. Start the test.

Mode 7

1. Let EUT connect to the Adapter and Earphone.
2. Turn on the front camera to start recording.
Turn on the WiFi of EUT and connected to the AP.
Turn on Bluetooth and connect to the Bluetooth speaker.
Turn off NFC.
Turn on the GPS and connect to GPS simulator.
Play 1KHz from SD Card.
3. Start the test.

Mode 8

1. Let EUT connect to the Earphone and NB with USB Cable
2. Turn on the WiFi of EUT and connect to the AP.
Turn on Bluetooth and connect to the Bluetooth speaker.
Turn on the GPS and connect to GPS simulator.
Let data from SD Card write into notebook.
3. Start the test.

Unless otherwise stated the results shown in this test report refer only to the sample(s) tested and such sample(s) are retained for 90 days only.
除非另有說明，此報告結果僅對測試之樣品負責，同時此樣品僅保留90天。本報告未經本公司書面許可，不可部份複製。

This document is issued by the Company subject to its General Conditions of Service printed overleaf, available on request or accessible at www.sgs.com/terms_and_conditions.htm and for electronic format documents, subject to Terms and Conditions for Electronic Documents at www.sgs.com/terms_e-document.htm. Attention is drawn to the limitation of liability, indemnification and jurisdiction issues defined therein. Any holder of this document is advised that information contained hereon reflects the Company's findings at the time of its intervention only and within the limits of Client's instructions, if any. The Company's sole responsibility is to its Client and this document does not exonerate parties to a transaction from exercising all their rights and obligations under the transaction documents. This document cannot be reproduced except in full, without prior written approval of the Company. Any unauthorized alteration, forgery or falsification of the content or appearance of this document is unlawful and offenders may be prosecuted to the fullest extent of the law.



Mode 9

1. Let EUT connect to the Earphone and NB with USB Cable
2. Turn on the WiFi of EUT and connect to the AP.
Turn on Bluetooth and connect to the Bluetooth speaker.
Turn on the GPS and connect to GPS simulator.
Read data from SD Card.
3. Start the test.

1.5 Description of Support Units

PRODUCT	MANUFACTURER	MODEL NO.	SERIAL NO.
Micro SD	Transcend	Micro SDHC (Class4)	N/A
BT Speaker	Creative	MF8090	YFMF8090245R00855Y
CMW500	R&S	CMW500	1201.002K50-152303-Zr
CMU 200	R&S	CMU 200	102189
GPS Signal Generator	Spectracom	GSG53 GNSS4	200218
AP	BUFFALO	WZR-HP-G300NH2	44066221202559[[G]]
Earphone (HRE, CE)	SONY	N/A	N/A
Earphone (RE)	htc	N/A	N/A
Notebook (EMI)	DELL	Latitude E6440	CYRVQ32

Support Equipment Used in Tested Cable

Cable Type	Core	Length	Shielding/Non-shielding
USB Cable*2	N/A	1.8m	Shielding
USB Cable	N/A	1m	Shielding
Earphone Cable*3	N/A	1.5m	Non-shielding

1.6 Modification List

No modification was made by SGS Taiwan Electronics & Communication Laboratory.

1.7 Accessories Cable List

Cable Type	Core	Length	Shielding/Non-shielding
Adapter USB Cable	Near AE	1.1m	Shielding

Unless otherwise stated the results shown in this test report refer only to the sample(s) tested and such sample(s) are retained for 90 days only.
除非另有說明，此報告結果僅對測試之樣品負責，同時此樣品僅保留90天。本報告未經本公司書面許可，不可部份複製。

This document is issued by the Company subject to its General Conditions of Service printed overleaf, available on request or accessible at www.sgs.com/terms_and_conditions.htm and for electronic format documents, subject to Terms and Conditions for Electronic Documents at www.sgs.com/terms_e-document.htm. Attention is drawn to the limitation of liability, indemnification and jurisdiction issues defined therein. Any holder of this document is advised that information contained hereon reflects the Company's findings at the time of its intervention only and within the limits of Client's instructions, if any. The Company's sole responsibility is to its Client and this document does not exonerate parties to a transaction from exercising all their rights and obligations under the transaction documents. This document cannot be reproduced except in full, without prior written approval of the Company. Any unauthorized alteration, forgery or falsification of the content or appearance of this document is unlawful and offenders may be prosecuted to the fullest extent of the law.



1.8 Test Set-Up Configuration

Mode 1~7

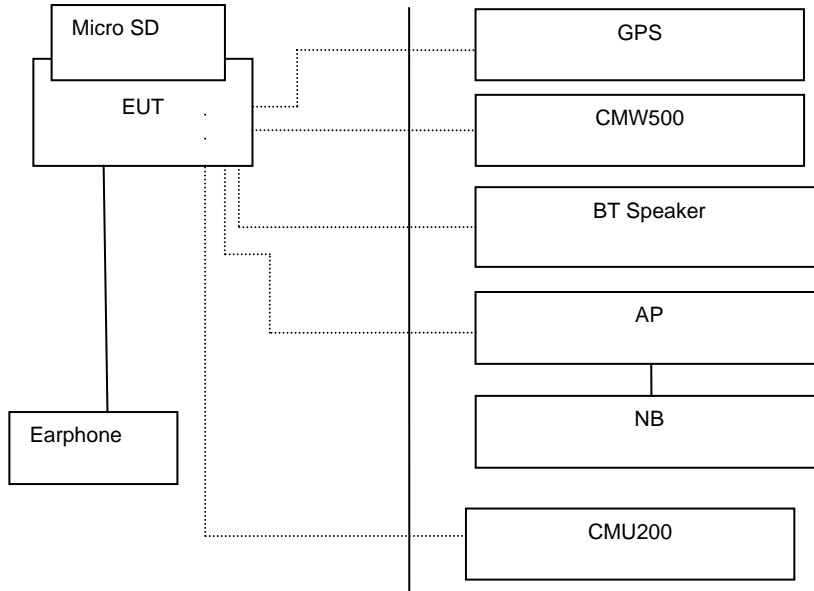

Mode 8~9

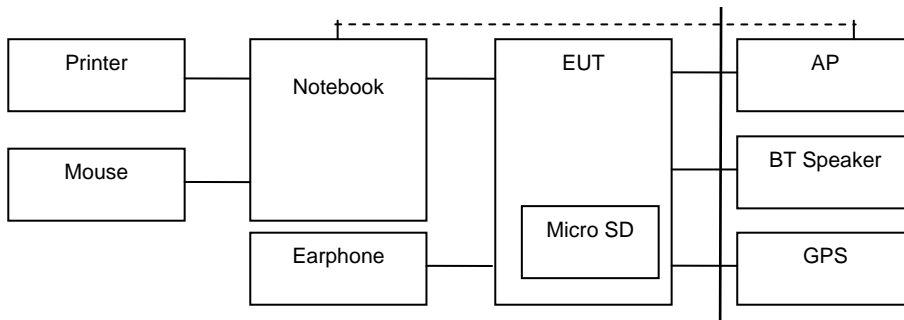

Unless otherwise stated the results shown in this test report refer only to the sample(s) tested and such sample(s) are retained for 90 days only.

除非另有說明，此報告結果僅對測試之樣品負責，同時此樣品僅保留90天。本報告未經本公司書面許可，不可部份複製。

This document is issued by the Company subject to its General Conditions of Service printed overleaf, available on request or accessible at www.sgs.com/terms_and_conditions.htm and for electronic format documents, subject to Terms and Conditions for Electronic Documents at www.sgs.com/terms_e-document.htm. Attention is drawn to the limitation of liability, indemnification and jurisdiction issues defined therein. Any holder of this document is advised that information contained hereon reflects the Company's findings at the time of its intervention only and within the limits of Client's instructions, if any. The Company's sole responsibility is to its Client and this document does not exonerate parties to a transaction from exercising all their rights and obligations under the transaction documents. This document cannot be reproduced except in full, without prior written approval of the Company. Any unauthorized alteration, forgery or falsification of the content or appearance of this document is unlawful and offenders may be prosecuted to the fullest extent of the law.



1.9 Measurement Procedure

Conducted Emission Testing was performed according to ANSI C63.4:2014 in a shielded room with peripherals placed on a table, 0.8m high over a metal floor. It was located more than required distance away from the shielded room wall.

Radiated Emission Testing was performed according to ANSI C63.4:2014 at the 3/10m semi-anechoic chamber. The EUT was placed on a 0.8m high table along with the peripherals. The turn table was placed 10m distance from the antenna. Cables were placed in a position to produce maximum emissions as determined by experimentation, and operation mode was selected for production of maximum emission.

The frequencies and amplitudes of maximum emission were measured at varying azimuths, antenna heights and antenna polarities. Maximum emission levels are then reported.

1.10 Standards Applicable for Testing

Tests to be carried out under FCC Part 15, Subpart B/CISPR 22

Test Standards	Status
FCC Part 15, Subpart B/ CISPR 22	Applicable
Deviation from Standard	No deviation

1.11 Summary of Results

Standard	Test Type	Highest Emission			
		Result	Phase/Pol.	Frequency(MHz)	Margin(dB)
FCC Part 15 Subpart B Class B	Conducted Emission	PASS	Line	0.5260	-11.49 (QP)
			Neutral	3.6980	-18.18 (QP)
	Radiated Emission	PASS	Ver.	949.9100	-3.28 (QP)

Unless otherwise stated the results shown in this test report refer only to the sample(s) tested and such sample(s) are retained for 90 days only.
除非另有說明，此報告結果僅對測試之樣品負責，同時此樣品僅保留90天。本報告未經本公司書面許可，不可部份複製。

This document is issued by the Company subject to its General Conditions of Service printed overleaf, available on request or accessible at www.sgs.com/terms_and_conditions.htm and for electronic format documents, subject to Terms and Conditions for Electronic Documents at www.sgs.com/terms_e-document.htm. Attention is drawn to the limitation of liability, indemnification and jurisdiction issues defined therein. Any holder of this document is advised that information contained hereon reflects the Company's findings at the time of its intervention only and within the limits of Client's instructions, if any. The Company's sole responsibility is to its Client and this document does not exonerate parties to a transaction from exercising all their rights and obligations under the transaction documents. This document cannot be reproduced except in full, without prior written approval of the Company. Any unauthorized alteration, forgery or falsification of the content or appearance of this document is unlawful and offenders may be prosecuted to the fullest extent of the law.

2. EMISSION

2.1 Test Results

	Results
Conducted Emission	Pass
Radiated Emission	Pass

2.2 Frequency Range

FCC Part 15, Subpart B:

Conducted Emission : 150 kHz - 30 MHz

Radiated Emission : See below table

Highest frequency generated or Upper frequency of measurement
used in the device or on which the range (MHz)
device operates or tunes (MHz)

Below 1.705	30
1.705 - 108	1000
108 - 500	2000
500 - 1000	5000
Above 1000	5th harmonic of the highest frequency or 40 GHz, whichever is lower

2.3 Limits of Conducted and Radiated Emission

2.3.1 Limits of Conducted Emission

FCC Part 15, Subpart B/CISPR 22:

FREQUENCY (MHz)	Class A (dBuV)		Class B (dBuV)	
	Quasi - peak	Average	Quasi - peak	Average
0.15 - 0.5	79	66	66 - 56	56 - 46
0.50 - 5.0	73	60	56	46
5.0 - 30.0	73	60	60	50

Note : (1) The lower limit shall apply at the transition frequencies.

(2) The limit decreases linearly with the logarithm of the frequency in the range 0.15 to 0.50 MHz.

(3) All emanation from a class A/B digital device or system, including any network of conductors and apparatus connected there to, shall not exceed the level of field strengths specified above.

Unless otherwise stated the results shown in this test report refer only to the sample(s) tested and such sample(s) are retained for 90 days only.
除非另有說明，此報告結果僅對測試之樣品負責，同時此樣品僅保留90天。本報告未經本公司書面許可，不可部份複製。

This document is issued by the Company subject to its General Conditions of Service printed overleaf, available on request or accessible at www.sgs.com/terms_and_conditions.htm and for electronic format documents, subject to Terms and Conditions for Electronic Documents at www.sgs.com/terms_e-document.htm. Attention is drawn to the limitation of liability, indemnification and jurisdiction issues defined therein. Any holder of this document is advised that information contained hereon reflects the Company's findings at the time of its intervention only and within the limits of Client's instructions, if any. The Company's sole responsibility is to its Client and this document does not exonerate parties to a transaction from exercising all their rights and obligations under the transaction documents. This document cannot be reproduced except in full, without prior written approval of the Company. Any unauthorized alteration, forgery or falsification of the content or appearance of this document is unlawful and offenders may be prosecuted to the fullest extent of the law.



2.3.2 Limits of Radiated Emissions

FCC Part 15, Subpart B Limit:

- Detector Function : Quasi – Peak

FREQUENCY (MHz)	Class A (at 10m)	Class B (at 3m)
	dBuV/m	dBuV/m
30~88	39	40
88~216	43.5	43.5
216~960	46.44	46
Above 960	49.54	54

- Detector Function : Peak , Average

FREQUENCY (MHz)	Class A (dBuV/m) (at 3m)		Class B (dBuV/m) (at 3m)	
	Peak	Average	Peak	Average
Above 1000-18000	79.3	59.3	73.9	53.9

CISPR 22 Limit:

- Detector Function : Quasi – Peak

FREQUENCY (MHz)	Class A (at 10m)	Class B (at 10m)
	dBuV/m	dBuV/m
30-230	40	30
230-1000	47	37

NOTE 1 The lower limit shall apply at the transition frequency.

NOTE 2 Additional provisions may be required for cases where interference occurs.

FREQUENCY (GHz)	Class A (dBuV/m) (at 3m)		Class B (dBuV/m) (at 3m)	
	Average	Peak	Average	Peak
1~3	56	76	50	70
3~6	60	80	54	74

NOTE The lower limit applies at the transition frequency.

Unless otherwise stated the results shown in this test report refer only to the sample(s) tested and such sample(s) are retained for 90 days only.
除非另有說明，此報告結果僅對測試之樣品負責，同時此樣品僅保留90天。本報告未經本公司書面許可，不可部份複製。

This document is issued by the Company subject to its General Conditions of Service printed overleaf, available on request or accessible at www.sgs.com/terms_and_conditions.htm and for electronic format documents, subject to Terms and Conditions for Electronic Documents at www.sgs.com/terms_e-document.htm. Attention is drawn to the limitation of liability, indemnification and jurisdiction issues defined therein. Any holder of this document is advised that information contained hereon reflects the Company's findings at the time of its intervention only and within the limits of Client's instructions, if any. The Company's sole responsibility is to its Client and this document does not exonerate parties to a transaction from exercising all their rights and obligations under the transaction documents. This document cannot be reproduced except in full, without prior written approval of the Company. Any unauthorized alteration, forgery or falsification of the content or appearance of this document is unlawful and offenders may be prosecuted to the fullest extent of the law.



2.4. Test of Conducted Emission

2.4.1 Test Equipments

SGS Conducted_Emission HWAYA Conducted Room No.B_EMC					
EQUIPMENT TYPE	Manufacturer	Model Number	Serial Number	Calibration Date	Calibration Due
EMI Test Receiver	R&S	ESCI 3	101300	Nov.01 th , 2017	Oct.31 th , 2018
Coaxial Cable	EMC Instruments Corp.	EMC5D-BM-BM-3000	1401004	May 25 th , 2018	May 24 th , 2019
LISN	TESEQ	NNB 51	36061	Feb.26 th , 2018	Feb.25 th , 2019
Pulse Limiter	R&S	ESH3Z2	102099	Jun.08 th , 2018	Jun.07 th , 2019
LISN	TESEQ	NNB 51	36062	Mar.30 th , 2018	Mar.29 th , 2019
Communication Tester	R&S	CMU200	119988	Feb.22 th , 2018	Feb.21 th , 2019
Communication Tester	R&S	CMW500	152303	Feb.21 th , 2018	Feb.20 th , 2019
Test S/W	Farad	EZ-EMC	Ver. SGS-03A2	N.C.R.	N.C.R.

SGS Taiwan LTD. Electronics & Communication Laboratory
 No.2, Keji 1st Rd., Guishan Dist., Taoyuan City 333, Taiwan (R.O.C.)
 Measurement Uncertainty of Conducted Emission
 Expanded uncertainty Ulab (K=2) of conducted emission is 2.25 dB
 Theory values uncertainty Ucispr 16-4-2:2011+A1:2014 (K=2) of AC mains Conducted Emission is 3.44dB

2.4.2 Operating Environment

Temperature : 23 degree C

Humidity : 69 %RH

Atmospheric Pressure : 992 mBar

2.4.3 Measurement Level Calculation

Factor = LISN insertion loss + Cable loss + Pulse Limiter Insertion Loss

Measurement Level = Reading Level + Factor

Over (Margin) = Measurement Level – Limit

Unless otherwise stated the results shown in this test report refer only to the sample(s) tested and such sample(s) are retained for 90 days only.
 除非另有說明，此報告結果僅對測試之樣品負責，同時此樣品僅保留90天。本報告未經本公司書面許可，不可部份複製。

This document is issued by the Company subject to its General Conditions of Service printed overleaf, available on request or accessible at www.sgs.com/terms_and_conditions.htm and for electronic format documents, subject to Terms and Conditions for Electronic Documents at www.sgs.com/terms_e-document.htm. Attention is drawn to the limitation of liability, indemnification and jurisdiction issues defined therein. Any holder of this document is advised that information contained hereon reflects the Company's findings at the time of its intervention only and within the limits of Client's instructions, if any. The Company's sole responsibility is to its Client and this document does not exonerate parties to a transaction from exercising all their rights and obligations under the transaction documents. This document cannot be reproduced except in full, without prior written approval of the Company. Any unauthorized alteration, forgery or falsification of the content or appearance of this document is unlawful and offenders may be prosecuted to the fullest extent of the law.



2.4.4 Measurement Data:

Model No.:F-01L

Mode_6_L

Site : Conduction Room Phase: L1 Temperature: 23 °C
 Limit: FCC Class B Conduction(QP) Power: AC 120V/60Hz Humidity: 69 %
 Mode: Mode_6
 Note:

Conducted Emission

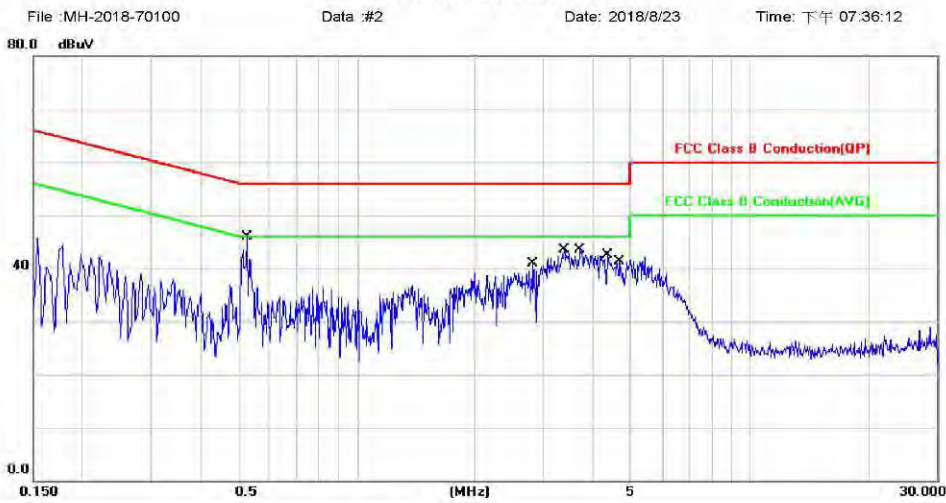

No.	Mk.	Freq.	Reading Level	Correct Factor	Measurement	Limit	Over	Detector	Comment
		MHz	dBuV	dB	dBuV	dBuV	dB		
1	*	0.5260	24.30	20.21	44.51	56.00	-11.49	QP	
2		0.5260	13.80	20.21	34.01	46.00	-11.99	AVG	
3		2.8140	16.30	20.41	36.71	56.00	-19.29	QP	
4		2.8140	3.90	20.41	24.31	46.00	-21.69	AVG	
5		3.3780	18.60	20.29	38.89	56.00	-17.11	QP	
6		3.3780	5.60	20.29	25.89	46.00	-20.11	AVG	
7		3.7020	19.25	20.24	39.49	56.00	-16.51	QP	
8		3.7020	6.39	20.24	26.63	46.00	-19.37	AVG	
9		4.3420	18.52	20.11	38.63	56.00	-17.37	QP	
10		4.3420	5.88	20.11	25.99	46.00	-20.01	AVG	
11		4.6860	17.80	20.05	37.85	56.00	-18.15	QP	
12		4.6860	5.80	20.05	25.85	46.00	-20.15	AVG	

*:Maximum data x:Over limit !:over margin

File :MH-2018-70100\Data :#2

Page: 1

Unless otherwise stated the results shown in this test report refer only to the sample(s) tested and such sample(s) are retained for 90 days only.

除非另有說明，此報告結果僅對測試之樣品負責，同時此樣品僅保留90天。本報告未經本公司書面許可，不可部份複製。

This document is issued by the Company subject to its General Conditions of Service printed overleaf, available on request or accessible at www.sgs.com/terms_and_conditions.htm and for electronic format documents, subject to Terms and Conditions for Electronic Documents at www.sgs.com/terms_e-document.htm. Attention is drawn to the limitation of liability, indemnification and jurisdiction issues defined therein. Any holder of this document is advised that information contained hereon reflects the Company's findings at the time of its intervention only and within the limits of Client's instructions, if any. The Company's sole responsibility is to its Client and this document does not exonerate parties to a transaction from exercising all their rights and obligations under the transaction documents. This document cannot be reproduced except in full, without prior written approval of the Company. Any unauthorized alteration, forgery or falsification of the content or appearance of this document is unlawful and offenders may be prosecuted to the fullest extent of the law.

Mode_6_N

Site : Conduction Room Phase: **N** Temperature: 23 °C
 Limit: FCC Class B Conduction(QP) Power: AC 120V/60Hz Humidity: 69 %
 Mode: Mode_6
 Note:

Conducted Emission

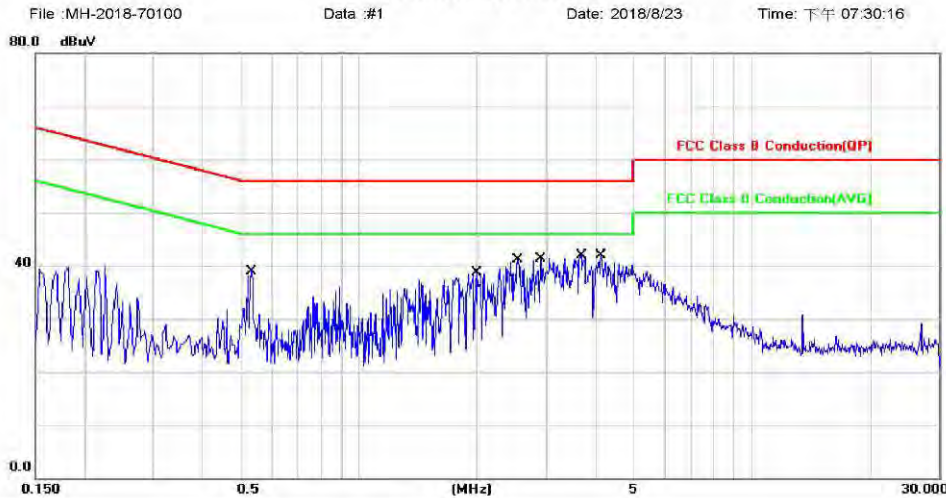

No.	Mk.	Freq.	Reading Level	Correct Factor	Measurement	Limit	Over	Detector	Comment
		MHz	dBuV	dB	dBuV	dBuV	dB		
1		0.5340	14.30	20.19	34.49	56.00	-21.51	QP	
2		0.5340	7.30	20.19	27.49	46.00	-18.51	AVG	
3		2.0060	15.50	20.54	36.04	56.00	-19.96	QP	
4		2.0060	2.80	20.54	23.34	46.00	-22.66	AVG	
5		2.5420	16.60	20.44	37.04	56.00	-18.96	QP	
6		2.5420	3.30	20.44	23.74	46.00	-22.26	AVG	
7		2.9060	16.80	20.37	37.17	56.00	-18.83	QP	
8		2.9060	3.43	20.37	23.80	46.00	-22.20	AVG	
9 *		3.6980	17.60	20.22	37.82	56.00	-18.18	QP	
10		3.6980	4.60	20.22	24.82	46.00	-21.18	AVG	
11		4.1380	17.20	20.13	37.33	56.00	-18.67	QP	
12		4.1380	4.30	20.13	24.43	46.00	-21.57	AVG	

*:Maximum data x:Over limit !:over margin

File :MH-2018-70100\Data :#1

Page: 1

Unless otherwise stated the results shown in this test report refer only to the sample(s) tested and such sample(s) are retained for 90 days only.

除非另有說明，此報告結果僅對測試之樣品負責，同時此樣品僅保留90天。本報告未經本公司書面許可，不可部份複製。

This document is issued by the Company subject to its General Conditions of Service printed overleaf, available on request or accessible at www.sgs.com/terms_and_conditions.htm and for electronic format documents, subject to Terms and Conditions for Electronic Documents at www.sgs.com/terms_e-document.htm. Attention is drawn to the limitation of liability, indemnification and jurisdiction issues defined therein. Any holder of this document is advised that information contained hereon reflects the Company's findings at the time of its intervention only and within the limits of Client's instructions, if any. The Company's sole responsibility is to its Client and this document does not exonerate parties to a transaction from exercising all their rights and obligations under the transaction documents. This document cannot be reproduced except in full, without prior written approval of the Company. Any unauthorized alteration, forgery or falsification of the content or appearance of this document is unlawful and offenders may be prosecuted to the fullest extent of the law.



2.5 Test of Radiated Emission

2.5.1 Test Equipments

Below 1GHz

SGS Radiated_Below_1GHz HWAYA 10m_EMC					
EQUIPMENT TYPE	Manufacturer	Model Number	Serial Number	Calibration Date	Calibration Due
EMI Test Receiver	R&S	ESCI 7	100950	Dec.12 th , 2017	Dec.11 th , 2018
EMI Test Receiver	R&S	ESCI 3	101343	Jan.31 th , 2018	Jan.30 th , 2019
Broadband Antenna	SCHWAZBECK	VULB9168	9168-628	Sep.08 th , 2017	Sep.07 th , 2018
Broadband Antenna	SCHWAZBECK	VULB9168	9168-629	Sep.12 th , 2017	Sep.11 th , 2018
Pre Amplifier	EMC Instruments Corp.	EMC330	980178	Mar.31 th , 2018	Mar.30 th , 2019
Pre Amplifier	EMC Instruments Corp.	EMC330	980179	Mar.31 th , 2018	Mar.30 th , 2019
Coaxial Cable	EMC Instruments	EMCCFD400-NM-NM	150917	Sep.18 th , 2017	Sep.17 th , 2018
Coaxial Cable	EMC Instruments	EMCCFD400-NM-NM	150919	Sep.18 th , 2017	Sep.17 th , 2018
Coaxial Cable	EMC Instruments	EMCCFD400-NM-NM	150820	Sep.18 th , 2017	Sep.17 th , 2018
Coaxial Cable	EMC Instruments	EMCCFD400-NM-NM	150918	Sep.18 th , 2017	Sep.17 th , 2018
Coaxial Cable	EMC Instruments	EMCCFD400-NM-NM	150821	Sep.18 th , 2017	Sep.17 th , 2018
Coaxial Cable	EMC Instruments	EMCCFD400-NM-NM	150822	Sep.18 th , 2017	Sep.17 th , 2018
Universal Digital Radio Communication Tester	R&S	CMU 200	119988	Feb.22 th , 2018	Feb.21 th , 2019
Wideband Radio Communication Tester	R&S	CMW 500	152303	Feb.21 th , 2018	Feb.20 th , 2019
Controller	MF	MF-7802	N/A	N.C.R.	N.C.R.
Controller	MF	MF-7802	N/A	N.C.R.	N.C.R.
Antenna Master	MF	N/A	N/A	N.C.R.	N.C.R.
Antenna Master	MF	N/A	N/A	N.C.R.	N.C.R.
Antenna Master	MF	N/A	N/A	N.C.R.	N.C.R.
Turn Table	MF	N/A	N/A	N.C.R.	N.C.R.
Site NSA	Chance Most	10M Chamber	10M SAC	Dec.31 th , 2017	Dec.30 th , 2018
Test S/W	Farad	EZ-EMC	Ver. SGS-03A2	N.C.R.	N.C.R.

SGS Taiwan LTD. Electronics & Communication Laboratory

No.2, Keji 1st Rd., Guishan Dist., Taoyuan City 333, Taiwan (R.O.C.)

Measurement Uncertainty of Radiated Emission

Expanded uncertainty U_{lab} (K=2) of radiated emission is 4.09 dB. (30MHz ~ 1000MHz)

Theory values uncertainty U_{cispr} 16-4-2:2011+A1:2014 (K=2) of radiated emission is 5.22 dB. (30MHz ~ 1000MHz)

Unless otherwise stated the results shown in this test report refer only to the sample(s) tested and such sample(s) are retained for 90 days only.

除非另有說明，此報告結果僅對測試之樣品負責，同時此樣品僅保留90天。本報告未經本公司書面許可，不可部份複製。

This document is issued by the Company subject to its General Conditions of Service printed overleaf, available on request or accessible at www.sgs.com/terms_and_conditions.htm and for electronic format documents, subject to Terms and Conditions for Electronic Documents at www.sgs.com/terms_e-document.htm. Attention is drawn to the limitation of liability, indemnification and jurisdiction issues defined therein. Any holder of this document is advised that information contained hereon reflects the Company's findings at the time of its intervention only and within the limits of Client's instructions, if any. The Company's sole responsibility is to its Client and this document does not exonerate parties to a transaction from exercising all their rights and obligations under the transaction documents. This document cannot be reproduced except in full, without prior written approval of the Company. Any unauthorized alteration, forgery or falsification of the content or appearance of this document is unlawful and offenders may be prosecuted to the fullest extent of the law.

SGS Taiwan Ltd.

No.134,Wu Kung Road, New Taipei Industrial Park, Wuku District, New Taipei City, Taiwan 24803/新北市五股區新北產業園區五工路 134 號

台灣檢驗科技股份有限公司

t (886-2) 2299-3279

f (886-2) 2298-0488

www.tw.sgs.com

Member of SGS Group



Above 1GHz

SGS Radiated_Above_1GHz HWAYA 966A EMC					
EQUIPMENT TYPE	Manufacturer	Model Number	Serial Number	Calibration Date	Calibration Due
Spectrum Analyzer	R&S	FSV 40	101419	May 15 th , 2018	May 14 th , 2019
EMI Test Receiver	R&S	ESR 7	101459	Feb.21 th , 2018	Feb.20 th , 2019
Horn Antenna	SCHWARZBECK	BBHA9120D	BBHA9120D673	Oct.16 th , 2017	Oct.15 th , 2018
Horn Antenna	Schwarzbeck	BBHA9170	BBHA9170-184	Dec.12 th , 2017	Dec.11 th , 2018
Pre Amplifier	EMC Instruments Corp.	EMC012645B	980216	Mar.31 th , 2018	Mar.30 th , 2019
Pre Amplifier	EMC Instruments Corp.	EMC184045B	980135	Oct.27 th , 2017	Oct.26 th , 2018
Coaxial Cable	JUNFLOW	MWX221-NMSNMS	J0778929	Apr.23 th , 2018	Apr.22 th , 2019
Coaxial Cable	Huber+Suhner	SUCCOFLEX 104PEA	30255/4PEA	Apr.23 th , 2018	Apr.22 th , 2019
Coaxial Cable	EMC Instruments	EMC104-SM-SM	140927	Apr.23 th , 2018	Apr.22 th , 2019
Coaxial Cable	Huber+Suhner	SUCOFLEX 102	MY 2651/2	Jun.05 th , 2018	Jun.04 th , 2019
Coaxial Cable	Huber+Suhner	SUCOFLEX 102	MY 2153/2	Jun.05 th , 2018	Jun.04 th , 2019
Universal Digital Radio Communication Tester	R&S	CMU 200	119988	Feb.22 th , 2018	Feb.21 th , 2019
Wideband Radio Communication Tester	R&S	CMW 500	152303	Feb.21 th , 2018	Feb.20 th , 2019
Controller	MF	MF-7802	N.C.R.	N.C.R.	N.C.R.
Antenna Master	MF	N/A	N/A	N.C.R.	N.C.R.
Turn Table	MF	N/A	N/A	N.C.R.	N.C.R.
Site VSWR	SGS	966 Chamber A	SAC-A	Jan.12 th , 2018	Jan.11 th , 2019
Test S/W	Farad	EZ-EMC	Ver. SGS-03A2	N.C.R.	N.C.R.

SGS Taiwan LTD. Electronics & Communication Laboratory
 No.2, Keji 1st Rd., Guishan Dist., Taoyuan City 333, Taiwan (R.O.C.)
 Measurement Uncertainty of Radiated Emission
 Expanded uncertainty (k=2) of radiated emission measurement is 5.05 dB. (1-6GHz)
 Expanded uncertainty (k=2) of radiated emission measurement is 5.07 dB. (6-18GHz)
 Expanded uncertainty Ulab (k=2) of radiated emission measurement is 5.19 dB. (18-26GHz)
 Expanded uncertainty Ulab (k=2) of radiated emission measurement is 5.14 dB. (26-40GHz)
 Theory values uncertainty Ucispr 16-4-2:2011+A1:2014 (K=2) of radiated emission measurement is 5.18 dB.(1-6GHz)
 Theory values uncertainty Ucispr 16-4-2:2011+A1:2014 (K=2) of radiated emission measurement is 5.48 dB.(6-18GHz)
 Theory values uncertainty Ucispr 16-4-2:2011+A1:2014 (K=2) of radiated emission measurement is ---- dB.(18-26GHz)
 Theory values uncertainty Ucispr 16-4-2:2011+A1:2014 (K=2) of radiated emission measurement is ---- dB.(26-40GHz)

Unless otherwise stated the results shown in this test report refer only to the sample(s) tested and such sample(s) are retained for 90 days only.

除非另有說明，此報告結果僅對測試之樣品負責，同時此樣品僅保留90天。本報告未經本公司書面許可，不可部份複製。

This document is issued by the Company subject to its General Conditions of Service printed overleaf, available on request or accessible at www.sgs.com/terms_and_conditions.htm and for electronic format documents, subject to Terms and Conditions for Electronic Documents at www.sgs.com/terms_e-document.htm. Attention is drawn to the limitation of liability, indemnification and jurisdiction issues defined therein. Any holder of this document is advised that information contained hereon reflects the Company's findings at the time of its intervention only and within the limits of Client's instructions, if any. The Company's sole responsibility is to its Client and this document does not exonerate parties to a transaction from exercising all their rights and obligations under the transaction documents. This document cannot be reproduced except in full, without prior written approval of the Company. Any unauthorized alteration, forgery or falsification of the content or appearance of this document is unlawful and offenders may be prosecuted to the fullest extent of the law.



2.5.2 Operating Environment

Temperature : 24 degree C

Humidity : 66 %RH

Atmospheric Pressure : 996 mBar

2.5.3 Measurement Level Calculation

Correction Factor = Antenna Factor + Cable loss- Amplifier Gain

Measurement Level = Reading Level + Correction Factor

Over (Margin) = Measurement Level – Limit

Unless otherwise stated the results shown in this test report refer only to the sample(s) tested and such sample(s) are retained for 90 days only.
除非另有說明，此報告結果僅對測試之樣品負責，同時此樣品僅保留90天。本報告未經本公司書面許可，不可部份複製。

This document is issued by the Company subject to its General Conditions of Service printed overleaf, available on request or accessible at www.sgs.com/terms_and_conditions.htm and for electronic format documents, subject to Terms and Conditions for Electronic Documents at www.sgs.com/terms_e-document.htm. Attention is drawn to the limitation of liability, indemnification and jurisdiction issues defined therein. Any holder of this document is advised that information contained hereon reflects the Company's findings at the time of its intervention only and within the limits of Client's instructions, if any. The Company's sole responsibility is to its Client and this document does not exonerate parties to a transaction from exercising all their rights and obligations under the transaction documents. This document cannot be reproduced except in full, without prior written approval of the Company. Any unauthorized alteration, forgery or falsification of the content or appearance of this document is unlawful and offenders may be prosecuted to the fullest extent of the law.



2.5.4 Measurement Data

Below 1GHz

Model No.:F-01L

Mode_8_H

Site: SGS 10m Chamber	Polarization: <i>Horizontal</i>	Temperature: 24 °C
Limit: CISPR22 Class B 10M Radiation	Power:	Humidity: 66 %
Mode: Mode_8	Distance: 10m	
Note:		

Radiated Emission

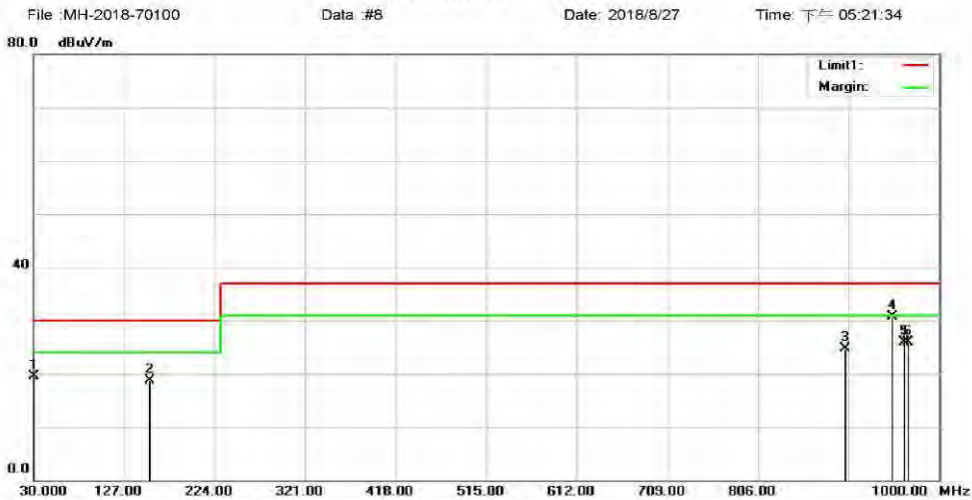

No.	Mk.	Freq. MHz	Reading Level dBuV	Correct Factor dB/m	Measurement dBuV/m	Limit dBuV/m	Over dB	Detector	Comment
1		30.3600	31.99	-12.57	19.42	30.00	-10.58	QP	
2		153.6040	30.07	-11.27	18.80	30.00	-11.20	QP	
3		900.0900	23.85	0.80	24.65	37.00	-12.35	QP	
4	*	950.5300	28.81	1.99	30.80	37.00	-6.20	QP	
5		963.1400	24.10	1.87	25.97	37.00	-11.03	QP	
6		967.0200	24.14	1.83	25.97	37.00	-11.03	QP	

*:Maximum data x:Over limit !:over margin

File :MH-2018-70100\Data #8

Page: 1

Unless otherwise stated the results shown in this test report refer only to the sample(s) tested and such sample(s) are retained for 90 days only.

除非另有說明，此報告結果僅對測試之樣品負責，同時此樣品僅保留90天。本報告未經本公司書面許可，不可部份複製。

This document is issued by the Company subject to its General Conditions of Service printed overleaf, available on request or accessible at www.sgs.com/terms_and_conditions.htm and for electronic format documents, subject to Terms and Conditions for Electronic Documents at www.sgs.com/terms_e-document.htm. Attention is drawn to the limitation of liability, indemnification and jurisdiction issues defined therein. Any holder of this document is advised that information contained hereon reflects the Company's findings at the time of its intervention only and within the limits of Client's instructions, if any. The Company's sole responsibility is to its Client and this document does not exonerate parties to a transaction from exercising all their rights and obligations under the transaction documents. This document cannot be reproduced except in full, without prior written approval of the Company. Any unauthorized alteration, forgery or falsification of the content or appearance of this document is unlawful and offenders may be prosecuted to the fullest extent of the law.

Mode_8_V

Site: SGS 10m Chamber Polarization: **Vertical** Temperature: 24 °C
 Limit: CISPR22 Class B 10M Radiation Power: From System Humidity: 66 %
 Mode: Mode_8 Distance: 10m
 Note:

Radiated Emission

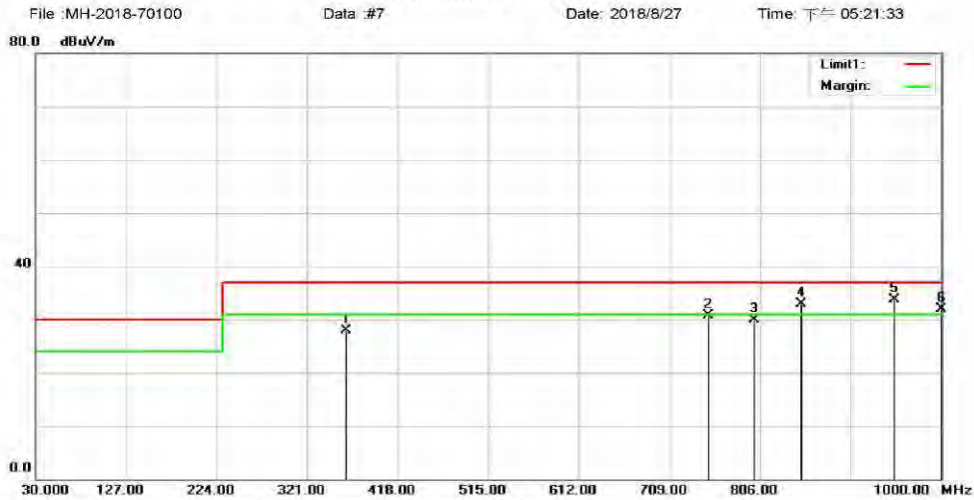

No.	Mk.	Freq. MHz	Reading Level dBuV	Correct Factor dB/m	Measurement dBuV/m	Limit dBuV/m	Over dB	Detector	Comment
1		362.5900	36.55	-8.70	27.85	37.00	-9.15	QP	
2		749.8600	31.42	-0.80	30.62	37.00	-6.38	QP	
3		799.9000	29.51	0.30	29.81	37.00	-7.19	QP	
4	!	849.9000	32.91	0.00	32.91	37.00	-4.09	QP	
5	*	949.9100	32.22	1.50	33.72	37.00	-3.28	QP	
6	!	999.8600	30.11	1.70	31.81	37.00	-5.19	QP	

*:Maximum data x:Over limit !:over margin

Unless otherwise stated the results shown in this test report refer only to the sample(s) tested and such sample(s) are retained for 90 days only.
 除非另有說明，此報告結果僅對測試之樣品負責，同時此樣品僅保留90天。本報告未經本公司書面許可，不可部份複製。

This document is issued by the Company subject to its General Conditions of Service printed overleaf, available on request or accessible at www.sgs.com/terms_and_conditions.htm and for electronic format documents, subject to Terms and Conditions for Electronic Documents at www.sgs.com/terms_e-document.htm. Attention is drawn to the limitation of liability, indemnification and jurisdiction issues defined therein. Any holder of this document is advised that information contained hereon reflects the Company's findings at the time of its intervention only and within the limits of Client's instructions, if any. The Company's sole responsibility is to its Client and this document does not exonerate parties to a transaction from exercising all their rights and obligations under the transaction documents. This document cannot be reproduced except in full, without prior written approval of the Company. Any unauthorized alteration, forgery or falsification of the content or appearance of this document is unlawful and offenders may be prosecuted to the fullest extent of the law.



Above 1GHz

Model No.:F-01L
1GMz~18GHz
Mode_8_H

Site: SGS 966 Chamber A Polarization: **Horizontal** Temperature: 22 °C
Limit: FCC Class B 3M Radiation(1G-40G)(Pea) Power: AC 120V/60Hz Humidity: 72 %
Mode: Mode_8 Distance:
Note:

Radiated Emission

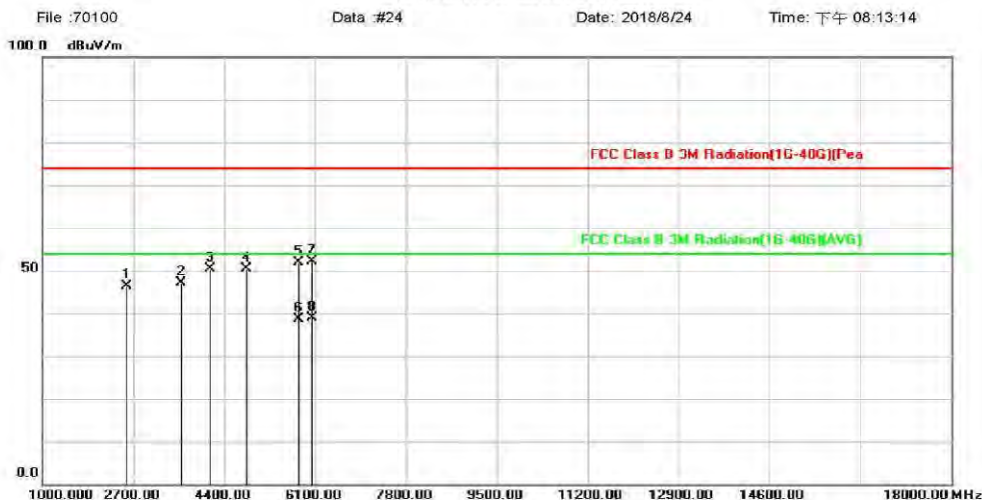

No.	Mk.	Freq.	Reading Level	Correct Factor	Measurement	Limit	Over	Detector	Comment
		MHz	dBuV	dB/m	dBuV/m	dBuV/m	dB		
1		2581.000	57.79	-11.35	46.44	74.00	-27.56	peak	
2		3584.000	57.47	-10.22	47.25	74.00	-26.75	peak	
3		4145.000	58.44	-8.13	50.31	74.00	-23.69	peak	
4		4808.000	57.78	-7.34	50.44	74.00	-23.56	peak	
5		5794.000	57.00	-5.22	51.78	74.00	-22.22	peak	
6		5794.000	43.78	-5.22	38.56	54.00	-15.44	AVG	
7		6032.000	56.47	-4.37	52.10	74.00	-21.90	peak	
8 *		6032.000	43.28	-4.37	38.91	54.00	-15.09	AVG	

*:Maximum data x:Over limit !:over margin

File :70100\Data :#24

Page: 1

Unless otherwise stated the results shown in this test report refer only to the sample(s) tested and such sample(s) are retained for 90 days only.
除非另有說明，此報告結果僅對測試之樣品負責，同時此樣品僅保留90天。本報告未經本公司書面許可，不可部份複製。

This document is issued by the Company subject to its General Conditions of Service printed overleaf, available on request or accessible at www.sgs.com/terms_and_conditions.htm and for electronic format documents, subject to Terms and Conditions for Electronic Documents at www.sgs.com/terms_e-document.htm. Attention is drawn to the limitation of liability, indemnification and jurisdiction issues defined therein. Any holder of this document is advised that information contained hereon reflects the Company's findings at the time of its intervention only and within the limits of Client's instructions, if any. The Company's sole responsibility is to its Client and this document does not exonerate parties to a transaction from exercising all their rights and obligations under the transaction documents. This document cannot be reproduced except in full, without prior written approval of the Company. Any unauthorized alteration, forgery or falsification of the content or appearance of this document is unlawful and offenders may be prosecuted to the fullest extent of the law.

Mode_8_V

Site: SGS 966 Chamber A Polarization: **Vertical** Temperature: 22 °C
 Limit: FCC Class B 3M Radiation(1G-40G)(Pea) Power: AC 120V/60Hz Humidity: 72 %
 Mode: Mode_8 Distance: Note:

Radiated Emission

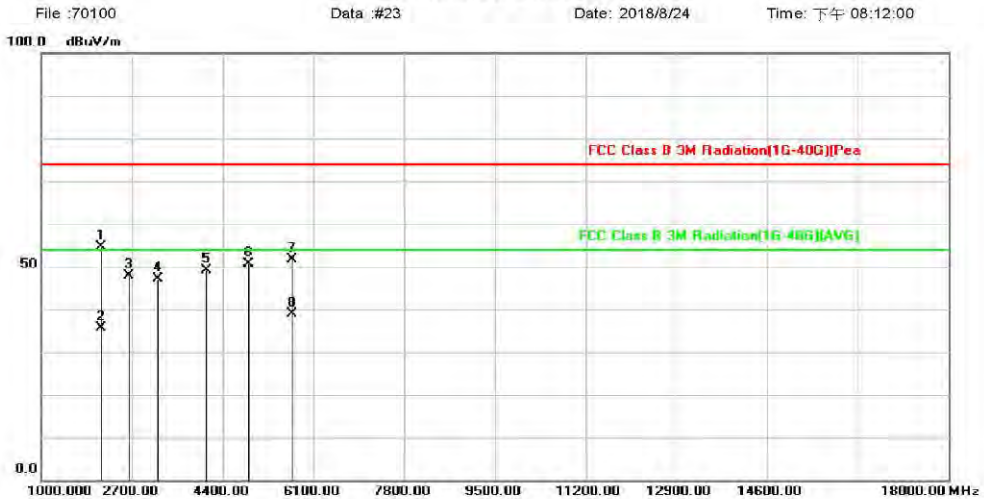

No.	Mk.	Freq. MHz	Reading Level dBuV	Correct Factor dB/m	Measure- ment dBuV/m	Limit dBuV/m	Over dB	Detector	Comment
1		2122.000	69.97	-15.39	54.58	74.00	-19.42	peak	
2		2122.000	51.02	-15.39	35.63	54.00	-18.37	AVG	
3		2649.000	59.38	-11.47	47.91	74.00	-26.09	peak	
4		3176.000	58.74	-11.57	47.17	74.00	-26.83	peak	
5		4094.000	57.23	-8.19	49.04	74.00	-24.96	peak	
6		4893.000	57.92	-7.22	50.70	74.00	-23.30	peak	
7		5709.000	57.09	-5.48	51.61	74.00	-22.39	peak	
8 *		5709.000	44.42	-5.48	38.94	54.00	-15.06	AVG	

*:Maximum data x:Over limit !:over margin

File :70100\Data #23

Page: 1

Unless otherwise stated the results shown in this test report refer only to the sample(s) tested and such sample(s) are retained for 90 days only.

除非另有說明，此報告結果僅對測試之樣品負責，同時此樣品僅保留90天。本報告未經本公司書面許可，不可部份複製。

This document is issued by the Company subject to its General Conditions of Service printed overleaf, available on request or accessible at www.sgs.com/terms_and_conditions.htm and for electronic format documents, subject to Terms and Conditions for Electronic Documents at www.sgs.com/terms_e-document.htm. Attention is drawn to the limitation of liability, indemnification and jurisdiction issues defined therein. Any holder of this document is advised that information contained hereon reflects the Company's findings at the time of its intervention only and within the limits of Client's instructions, if any. The Company's sole responsibility is to its Client and this document does not exonerate parties to a transaction from exercising all their rights and obligations under the transaction documents. This document cannot be reproduced except in full, without prior written approval of the Company. Any unauthorized alteration, forgery or falsification of the content or appearance of this document is unlawful and offenders may be prosecuted to the fullest extent of the law.

18GMz~30GHz

Mode_8_H

Site: SGS 966 Chamber A	Polarization: Horizontal	Temperature: 22 °C
Limit: FCC Class B 1M Radiation(1G-40G)(Pea)	Power: AC 120V/60Hz	Humidity: 72 %
Mode: Mode_8	Distance:	
Note:		

Radiated Emission

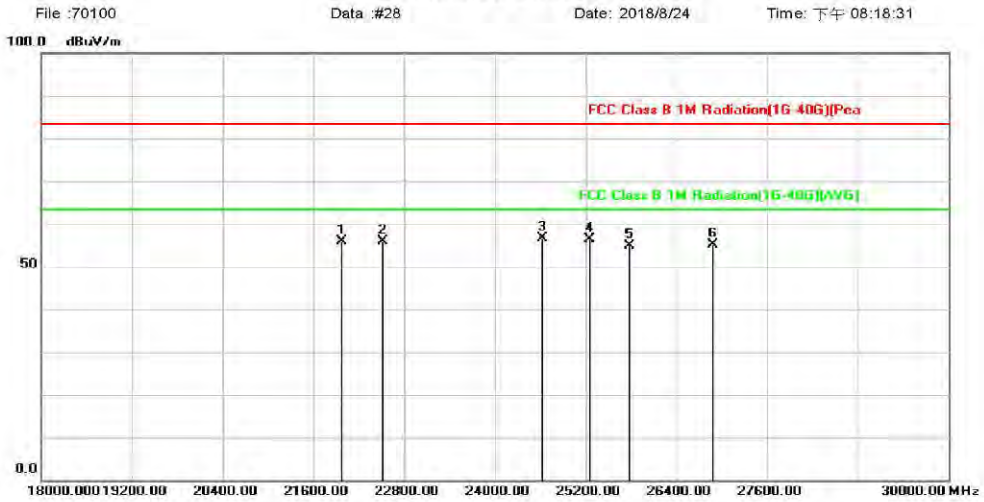

No.	Mk.	Freq.	Reading Level	Correct Factor	Measurement	Limit	Over	Detector	Comment
		MHz	dBuV	dB/m	dBuV/m	dBuV/m	dB		
1		21972.000	51.05	4.95	56.00	83.50	-27.50	peak	
2		22524.000	50.48	5.40	55.88	83.50	-27.62	peak	
3	*	24624.000	50.50	6.22	56.72	83.50	-26.78	peak	
4		25248.000	50.73	5.75	56.48	83.50	-27.02	peak	
5		25788.000	49.33	5.44	54.77	83.50	-28.73	peak	
6		26892.000	49.13	6.05	55.18	83.50	-28.32	peak	

*:Maximum data x:Over limit !:over margin

File :70100\Data #28

Page: 1

Unless otherwise stated the results shown in this test report refer only to the sample(s) tested and such sample(s) are retained for 90 days only.

除非另有說明，此報告結果僅對測試之樣品負責，同時此樣品僅保留90天。本報告未經本公司書面許可，不可部份複製。

This document is issued by the Company subject to its General Conditions of Service printed overleaf, available on request or accessible at www.sgs.com/terms_and_conditions.htm and for electronic format documents, subject to Terms and Conditions for Electronic Documents at www.sgs.com/terms_e-document.htm. Attention is drawn to the limitation of liability, indemnification and jurisdiction issues defined therein. Any holder of this document is advised that information contained hereon reflects the Company's findings at the time of its intervention only and within the limits of Client's instructions, if any. The Company's sole responsibility is to its Client and this document does not exonerate parties to a transaction from exercising all their rights and obligations under the transaction documents. This document cannot be reproduced except in full, without prior written approval of the Company. Any unauthorized alteration, forgery or falsification of the content or appearance of this document is unlawful and offenders may be prosecuted to the fullest extent of the law.

Mode_8_V

Site: SGS 966 Chamber A Polarization: **Vertical** Temperature: 22 °C
 Limit: FCC Class B 1M Radiation(1G-40G)(Pea) Power: AC 120V/60Hz Humidity: 72 %
 Mode: Mode_8 Distance: _____
 Note: _____

Radiated Emission



No.	Mk.	Freq.	Reading Level	Correct Factor	Measurement	Limit	Over	Detector	Comment
		MHz	dBuV	dB/m	dBuV/m	dBuV/m	dB		
1		18420.000	52.86	1.26	54.12	83.50	-29.38	peak	
2		18900.000	52.46	1.28	53.74	83.50	-29.76	peak	
3		19812.000	52.49	2.32	54.81	83.50	-28.69	peak	
4		21264.000	51.99	3.67	55.66	83.50	-27.84	peak	
5		22008.000	52.16	5.00	57.16	83.50	-26.34	peak	
6	*	24672.000	52.44	6.23	58.67	83.50	-24.83	peak	

*:Maximum data x:Over limit !:over margin

File :70100\Data :#27

Page: 1

Unless otherwise stated the results shown in this test report refer only to the sample(s) tested and such sample(s) are retained for 90 days only.
 除非另有說明，此報告結果僅對測試之樣品負責，同時此樣品僅保留90天。本報告未經本公司書面許可，不可部份複製。

This document is issued by the Company subject to its General Conditions of Service printed overleaf, available on request or accessible at www.sgs.com/terms_and_conditions.htm and for electronic format documents, subject to Terms and Conditions for Electronic Documents at www.sgs.com/terms_e-document.htm. Attention is drawn to the limitation of liability, indemnification and jurisdiction issues defined therein. Any holder of this document is advised that information contained hereon reflects the Company's findings at the time of its intervention only and within the limits of Client's instructions, if any. The Company's sole responsibility is to its Client and this document does not exonerate parties to a transaction from exercising all their rights and obligations under the transaction documents. This document cannot be reproduced except in full, without prior written approval of the Company. Any unauthorized alteration, forgery or falsification of the content or appearance of this document is unlawful and offenders may be prosecuted to the fullest extent of the law.