

Professional Antenna Service Provider



Antenna test report

Model KDS

Manufacturer Shenzhen Kaadas Intelligent Technology Co., Ltd

Test Wei quan

Review Xie yi chao

Time 2022-12-21



Test equipment and test environment

测试设备和测试环境

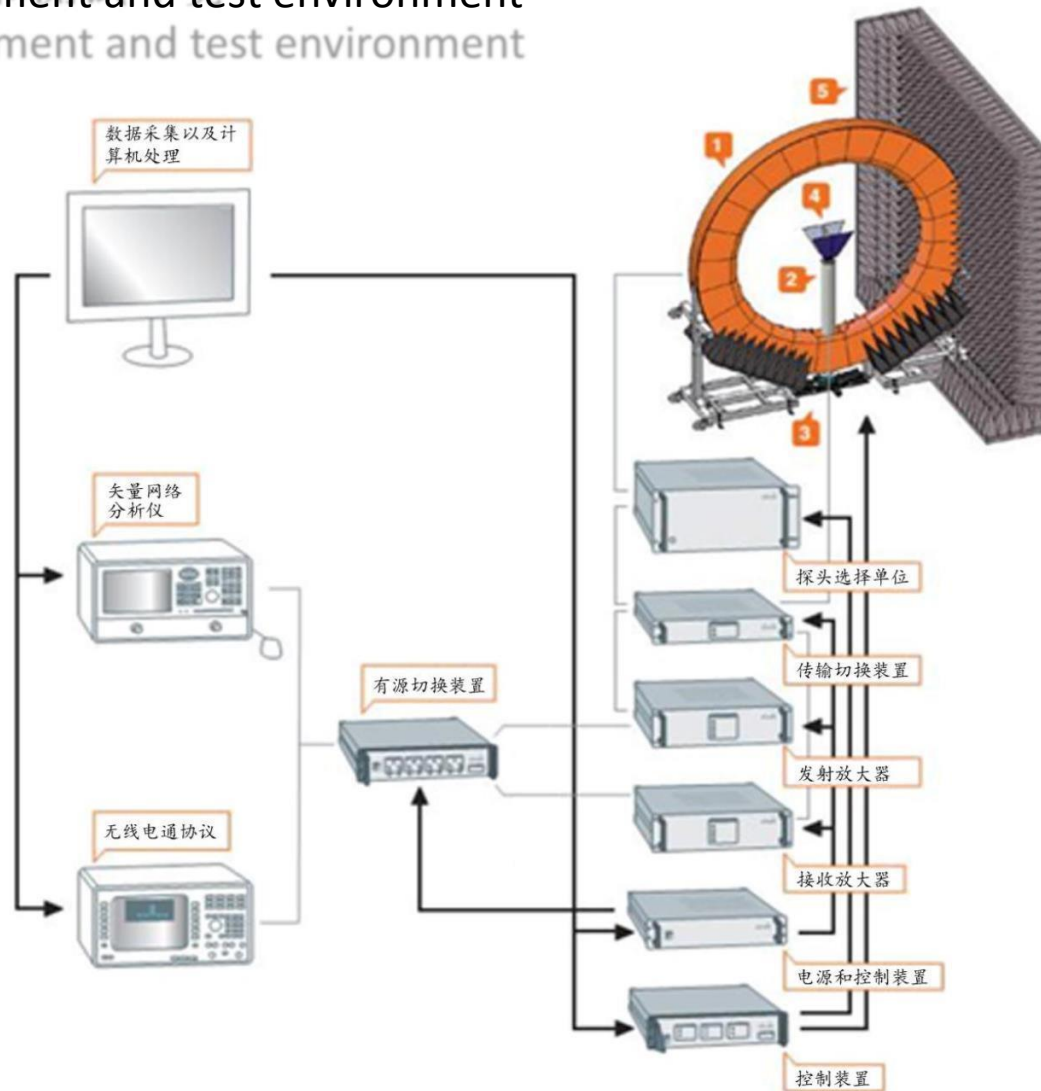



Test equipment
Test equipment

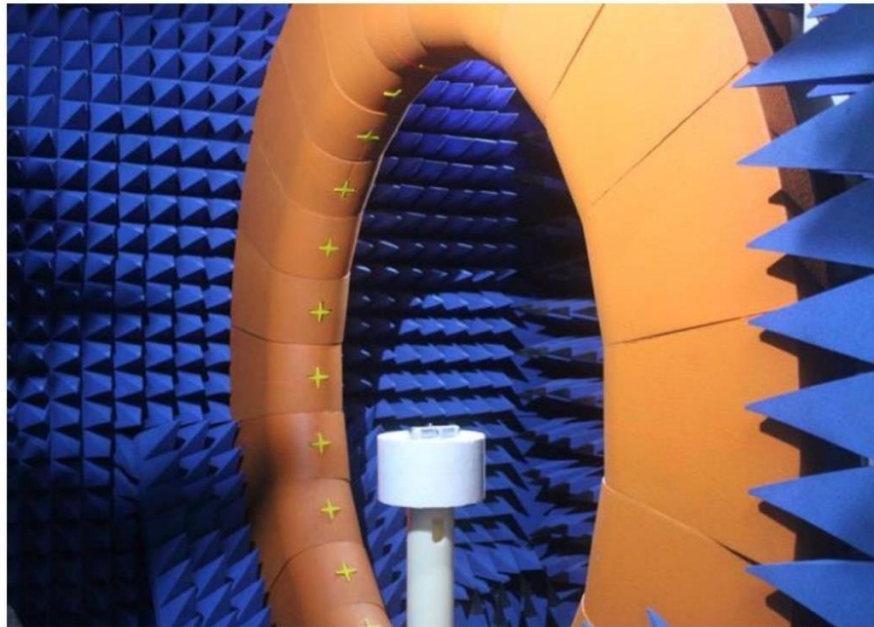

Probe Microwave Anechoic Chamber

Frequency: 0.4GHz to 6GHz

Main test indicators

Passive indicator

Gain

Efficiency

3D direction map

Active indicator

TRP total radiated power

TIS total receiver sensitivity



Test equipment
Test equipment

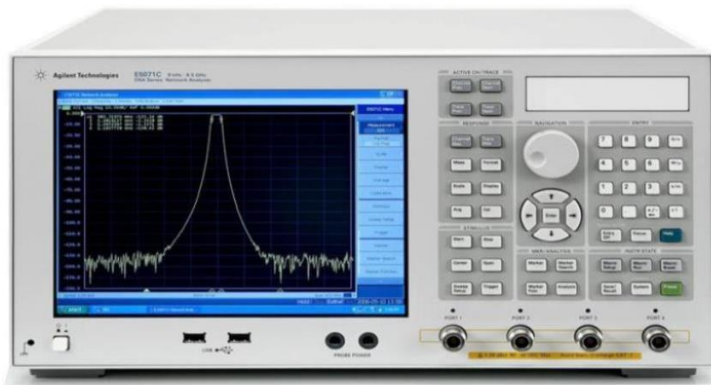

Agilent E5071C Vector Network
Analyzer

Frequency: 300 kHz to 8.5GHz



R&S CMW500 Broadband Wireless
Communication Tester

GSM/3G/4G

WIFI/ Bluetooth

NB-IoT



Test photos

Test photos

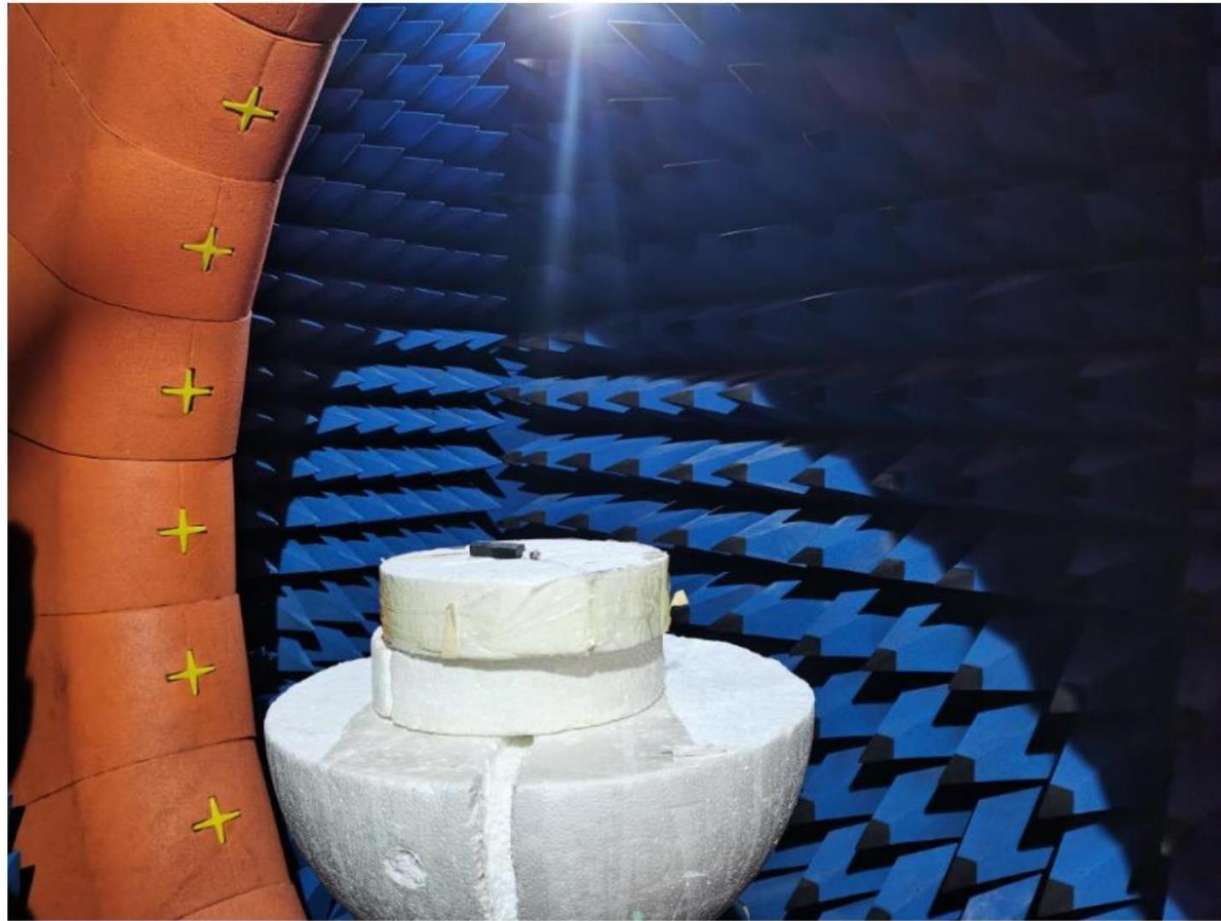

Passive antenna data

Antenna installation location and method. Coaxial cable: 0.81*35mm, one end with 4th generation ipex, one end stripped 2-2-1.5

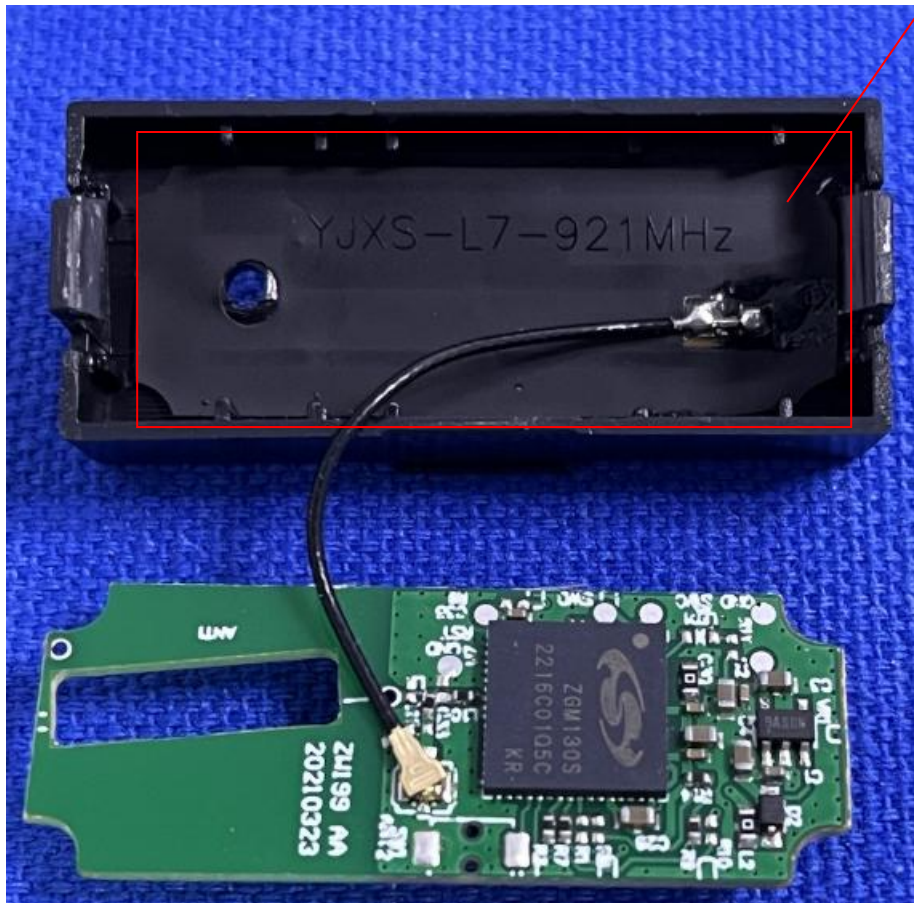



Antenna SWR

Antenna SWR

On-The-Fly Sensitive
Debug Antenna

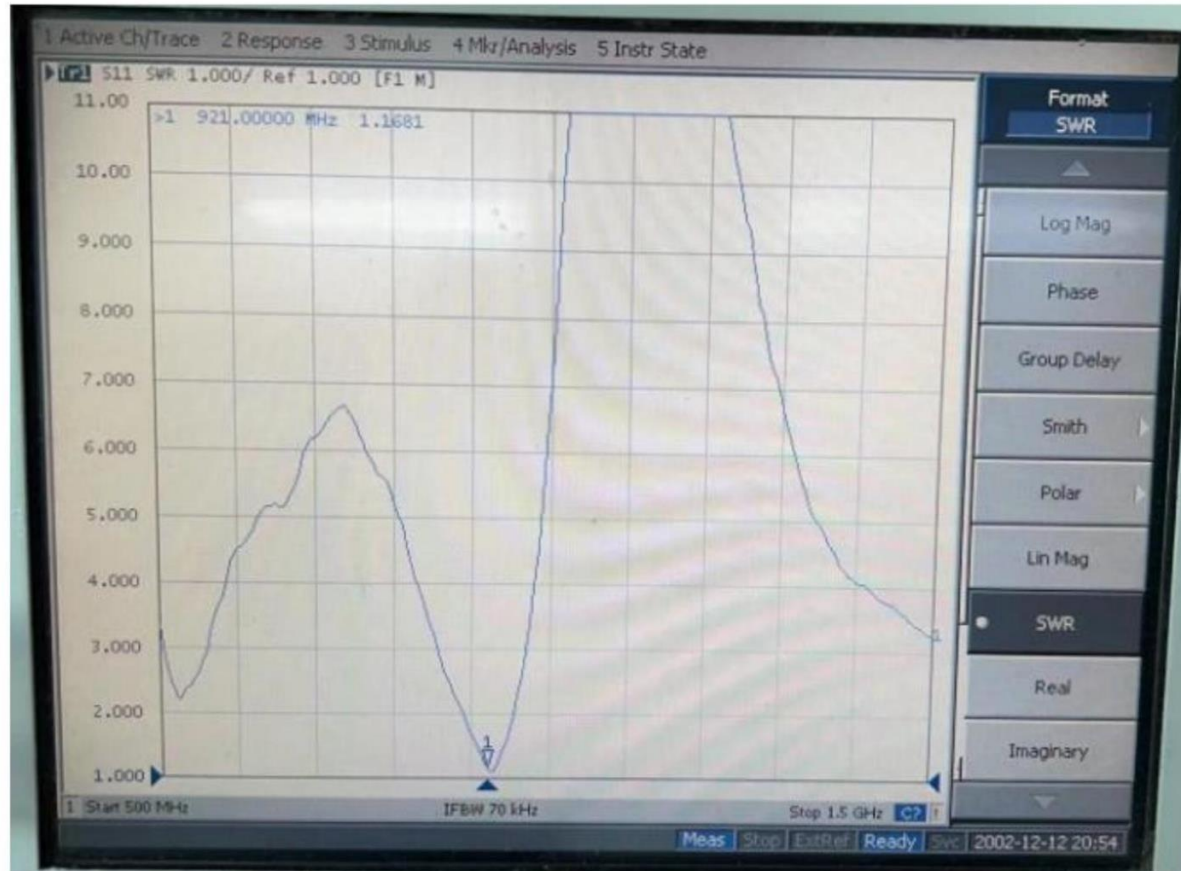



Antenna Return loss

Antenna Return loss

On-The-Fly Sensitive
Debug Antenna

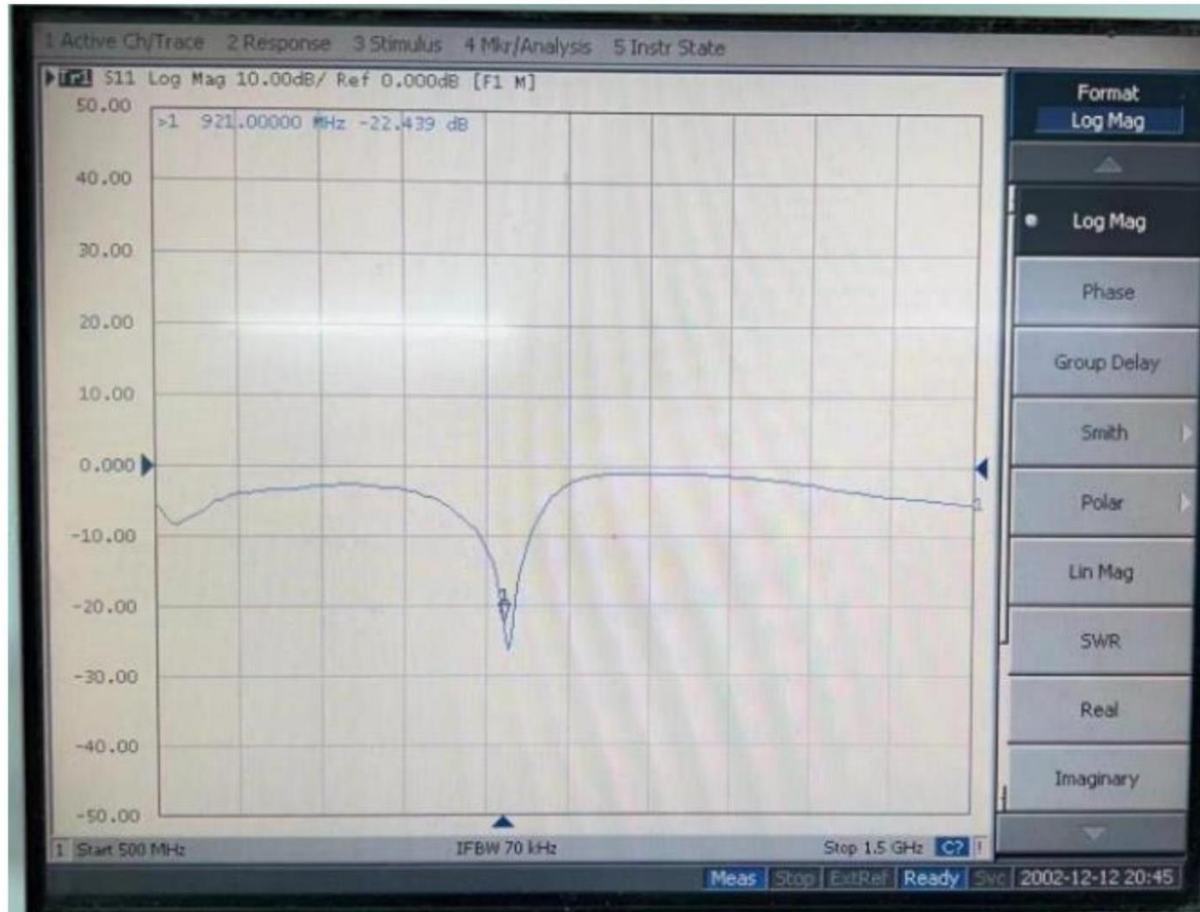



Antenna gain and efficiency

Antenna gain and efficiency

On-The-Fly Sensitive

Debug Antenna

Antenna		
Freq (MHz)	Efficiency (%)	Gian (dBi)
908	32.85	-0.29
916	31.87	0.00
917	32.05	-0.15
918	32.17	-0.14
919	32.17	-0.12
920	32.01	-0.14
921	32.01	-0.17
922	32.02	-0.19
923	32.02	-0.2
924	32.07	-0.21
925	32.24	-0.19



Antenna Radiation Pattern

Antenna Radiation Pattern

On-The-Fly Sensitive
Debug Antenna

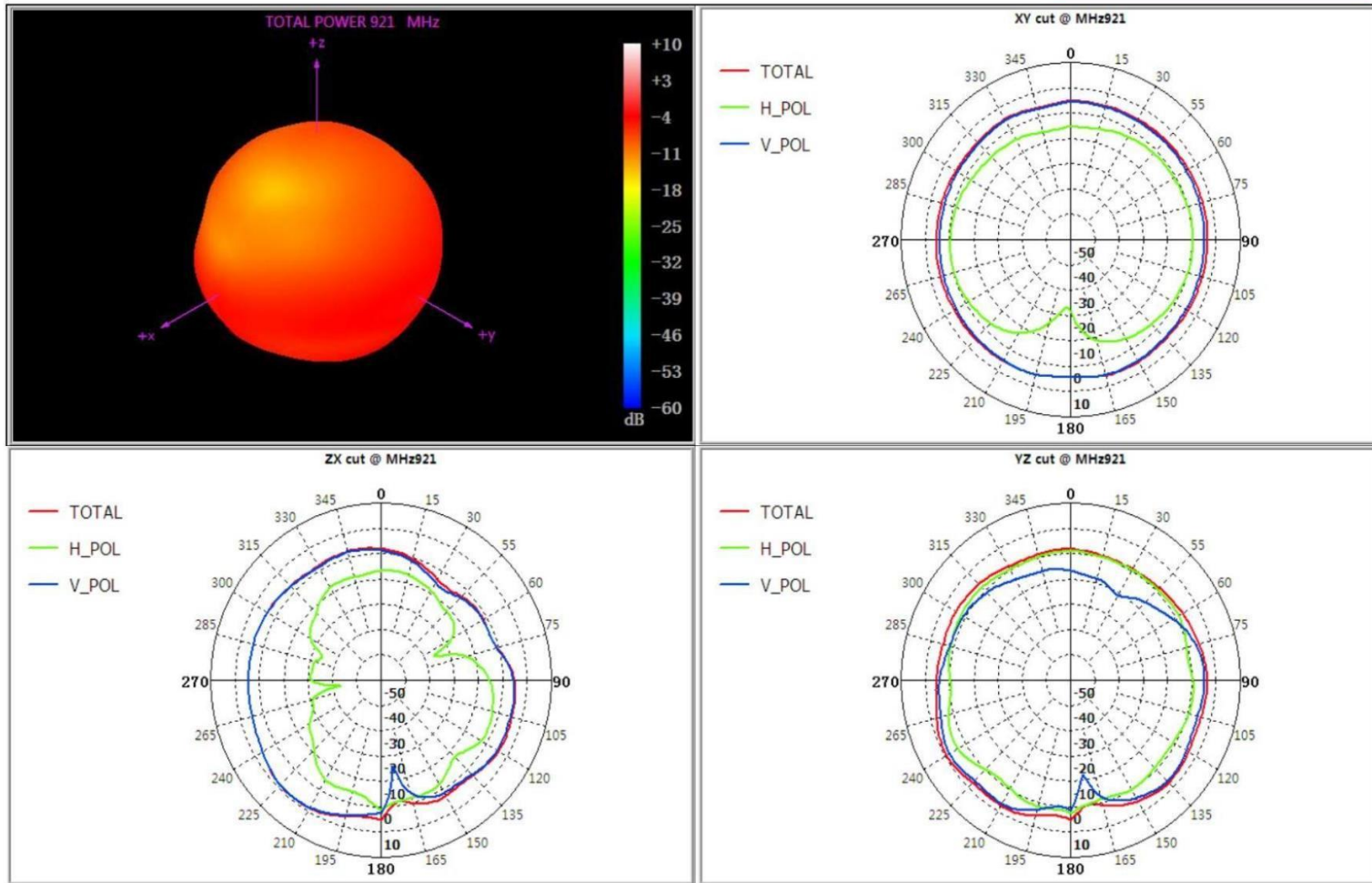



Antenna SWR

Antenna SWR

Customer's original antenna

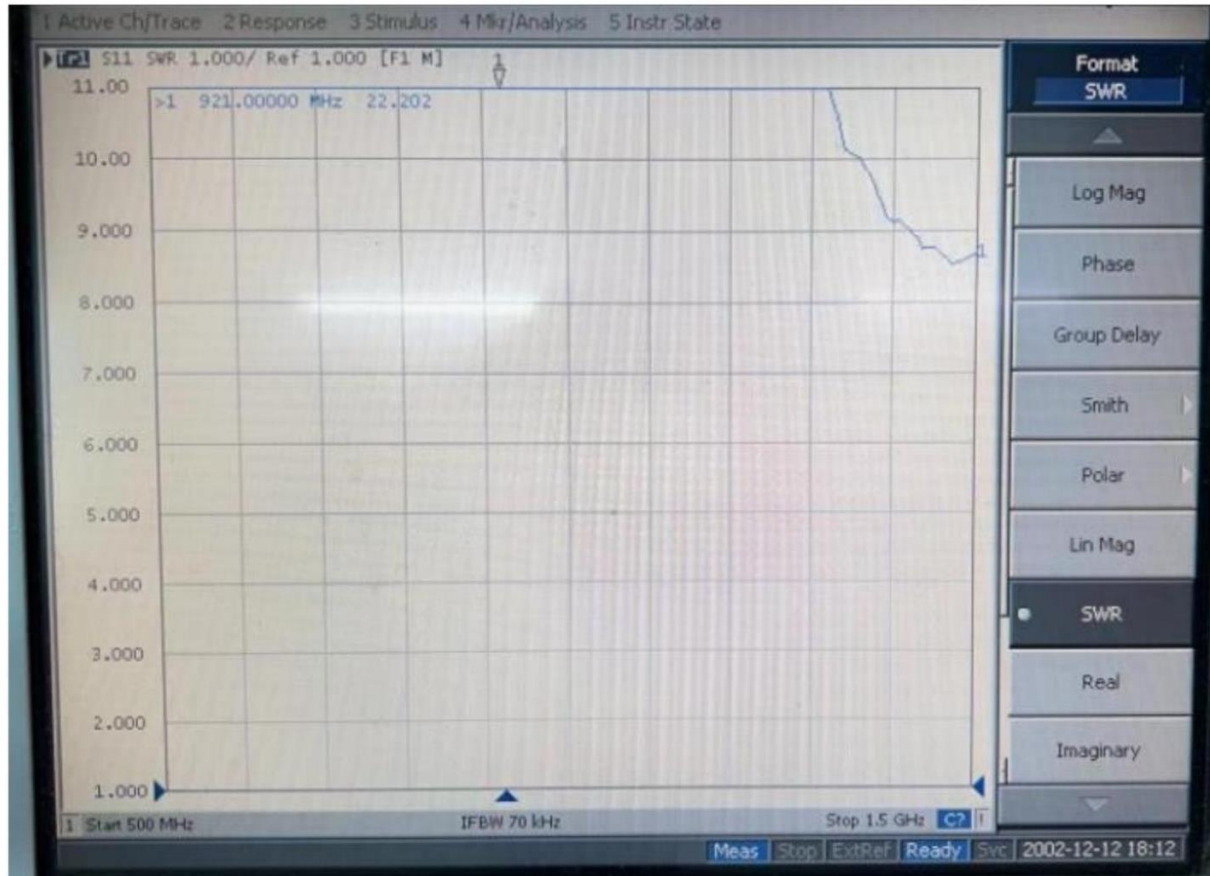



Antenna Return loss

Antenna Return loss

Customer's original antenna

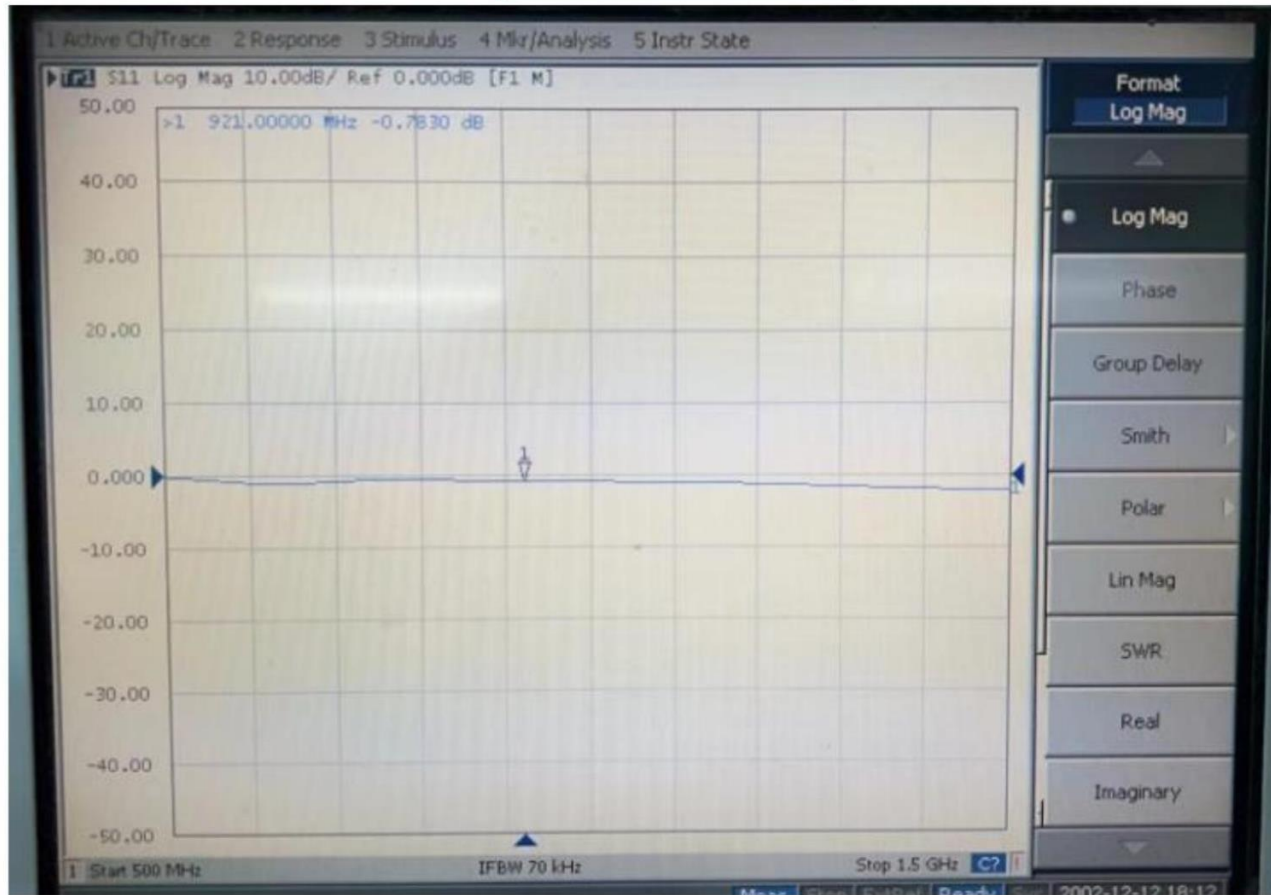

Product figure

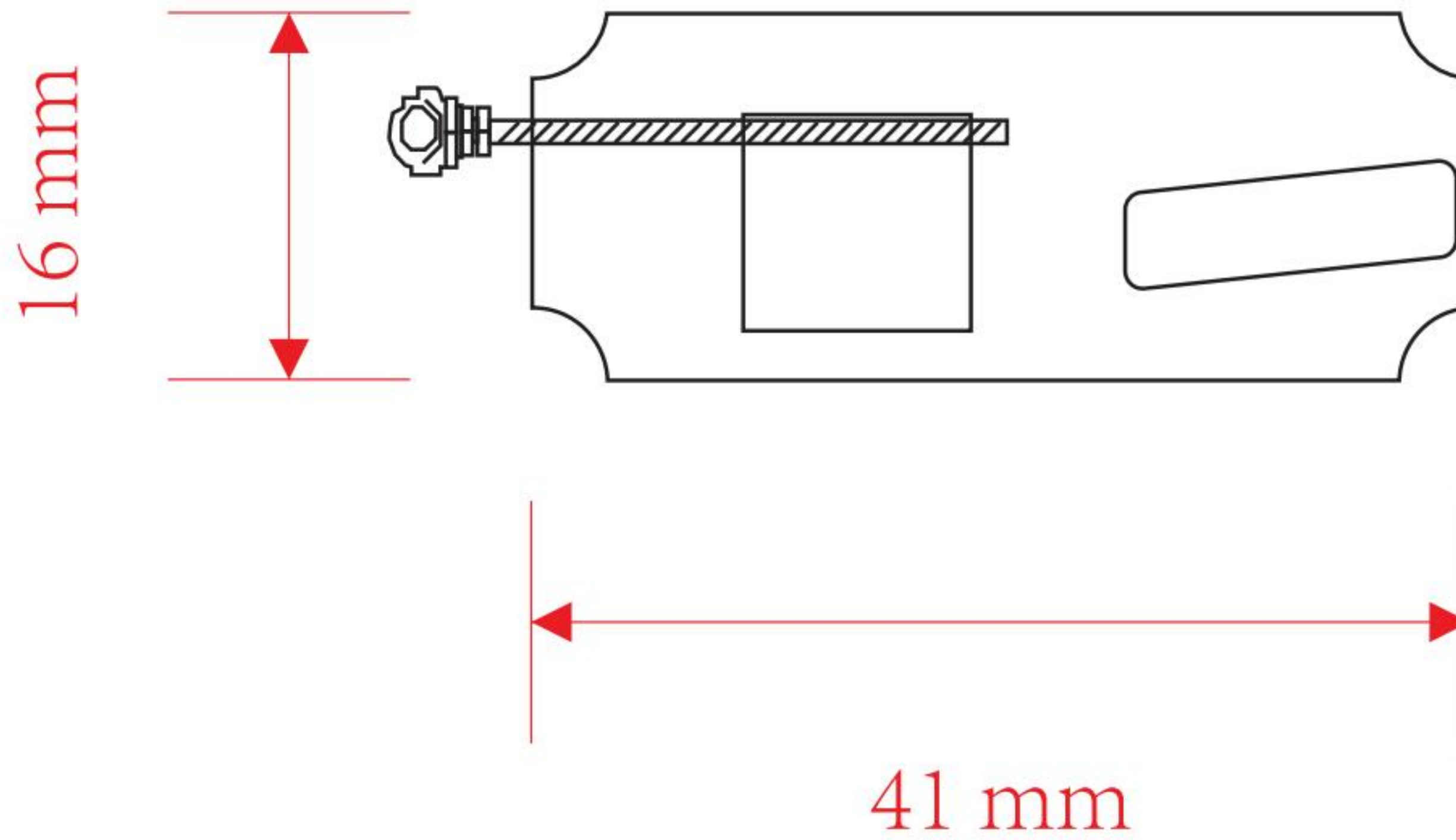

Thanks for your support!

TEL:(86)755-23035723. FAX:0755-23036702

E-mail:ant001@fmant.cn

ADD: 303, building C,GUSHU Hengnan Road,Xixiang,Baoan district Shenzhen