



WiFi Retrofit Smart Lock



Quick Start Guide

DOWNLOAD REVOLO APP



Download the Revolo APP from the APP store or Google Play.



Scan the QR code to
download the Revolo APP



If you have any questions,
please contact
support@irevolo.com.

CONTENT

Process Guide	01
What's Included	02
Product Overview	03
Installation Guide	04
STEP1–Remove the interior assembly of deadblit lock	04
STEP2–Deaddolt Compatibility Chart	05
STEP3–Select The Corresponding Shape In One Of The Adapters	06
STEP4–Installing Interior Assembly	09
STEP5–Installing Battery and Battery Cover	10
STEP6–Pair And Set Up Your Smart Lock Via App.....	11
STEP7–Installing Door Sensor	12
STEP8–Add Accessory (Optional).....	13
FCC Statement	14
Canada Statement	14
Warning	15

PROCESS GUIDE



1 Download the Revolo app to setup.

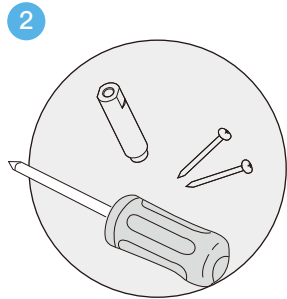

2 Follow the instructions and replace your existing lock.

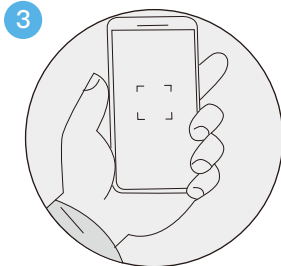

3 Scan the QR code on your device.

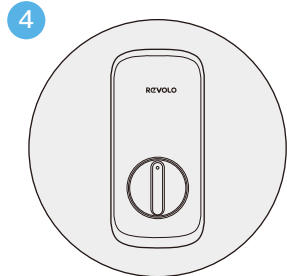

4 Calibrate your lock and you are done.

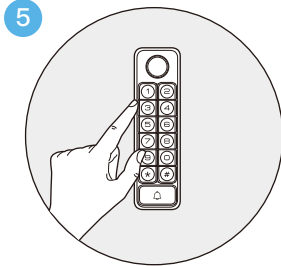

5 Hold the "*" + key for 5 seconds to enter pairing mode.

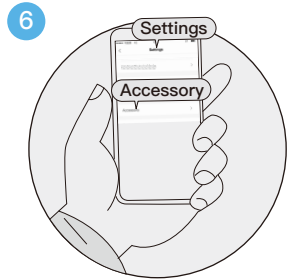

6 Go to the device to an add accessory, "Settings" -> "Accessory" (Optional).

WHAT'S INCLUDED

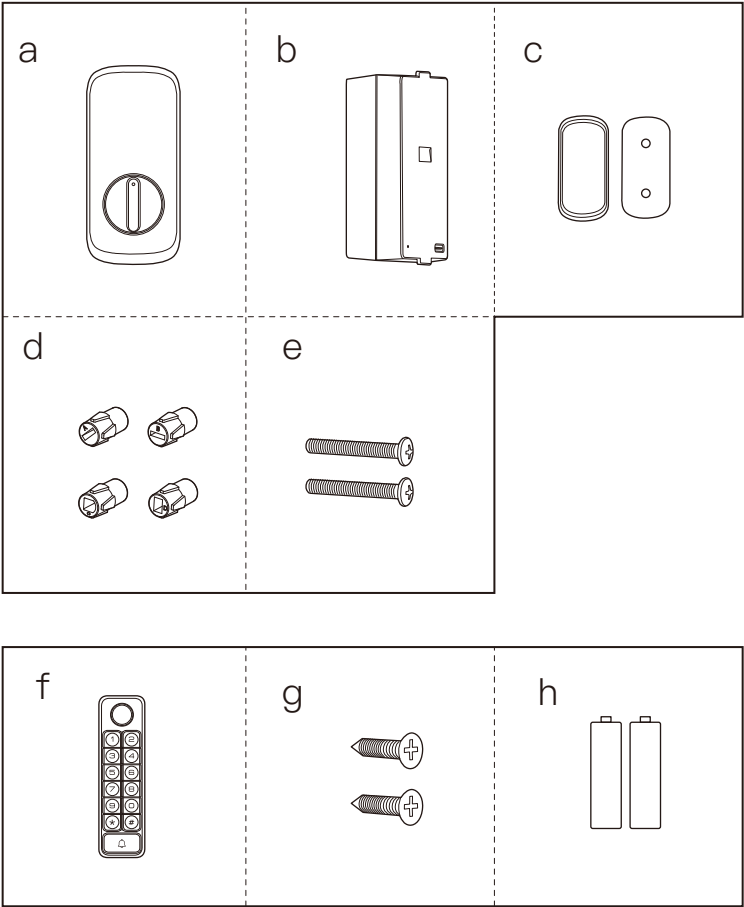

PRODUCT OVERVIEW

Revolvo WiFi Retrofit Smart Lock make your existing key,deadbolt,exterior lock by replacing the interior thumb latch conveniently.

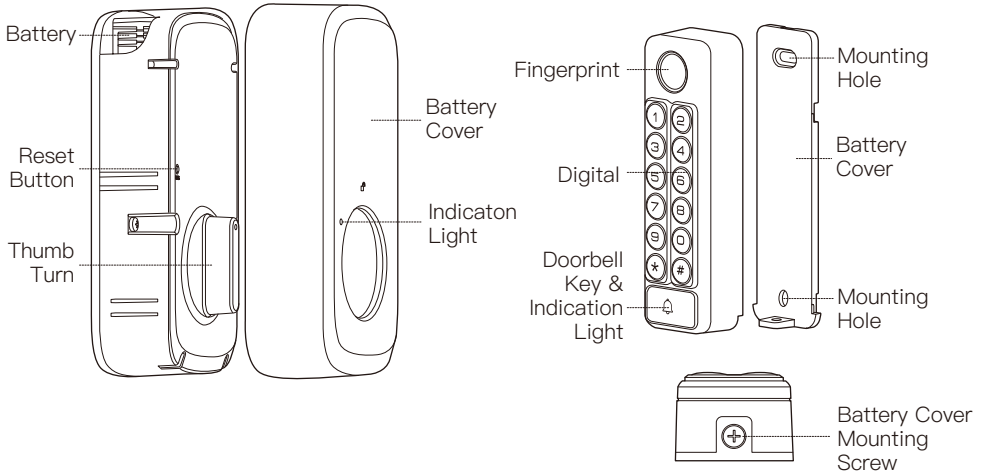

DEFINATION

Pairing Mode: Press and hold the "*" + key for 5 seconds , until the green light blinks slowly, and the buzzer beeps shortly one time.

One Touch Locking: Press and hold **Any key** on keypad for **2 Seconds** to lock the door.

Lock-Out: If you fail to unlock the door for 5 consecutive times using the PIN Key, your lock will be shut-down for 3 mins.

Reset: Press and HOLD the Reset Button on inside panel for 5 seconds to reset your device. After reset, the lock will be restored to factory default settings, all user credentials will be deleted.

NOTE:The lock can ONLY adapt a deadbolt lock

INSTALLATION GUIDE

STEP 1





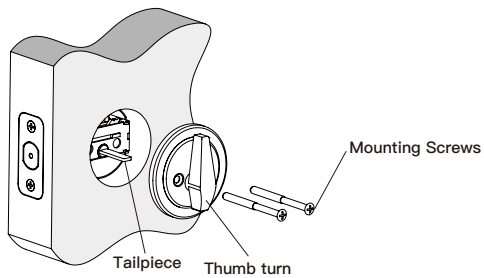
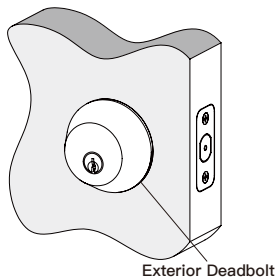





REMOVE THE INTERIOR ASSEMBLY OF DEADBOLT LOCK

Remove the interior assembly of deadbolt, the others is reserved.



STEP 2

If you know the brand and model of your deadbolt, select the correct adapter (A,B,C,D) from the chart below. If not, proceed to next step.

Deadbolt Compatibility Chart		
Major Brands	Adapter ID	Adapter Image
Ace & Brinks (most models)	B (blue)	
Baldwin Estates & Images Collectongs	B (blue)	
Baldwin Reserve & Prestige Collectongs	C (green)	
Defiant & Brinks (limtted models)	D (red)	
Emtek / Delaney / Dexter / Weslock	B (blue)	
Gatehouse (current models)	B (blue)	
Kwikset	C (green)	
Schlage (B60, B560, B600 Series)	A (yellow)	
Schlage (B360)	B (blue)	
Weiser (current models)	C (green)	
Yale Standard Series	B (blue)	

NOTE: Some low profile deadbolt cannot be adapted. Minimum door thickness: 1-3/8" (35mm)

Not all brands and models shown.

STEP 3

If you do not know the brand and model of your deadbolt, or want to visually verify your selection in Step 2, check the shape of the tailpiece protruding through the latch when the deadbolt is unlocked (latch bolt retracted).

Select the corresponding shape in one of the adapters with one of the triangular tabs pointing up.

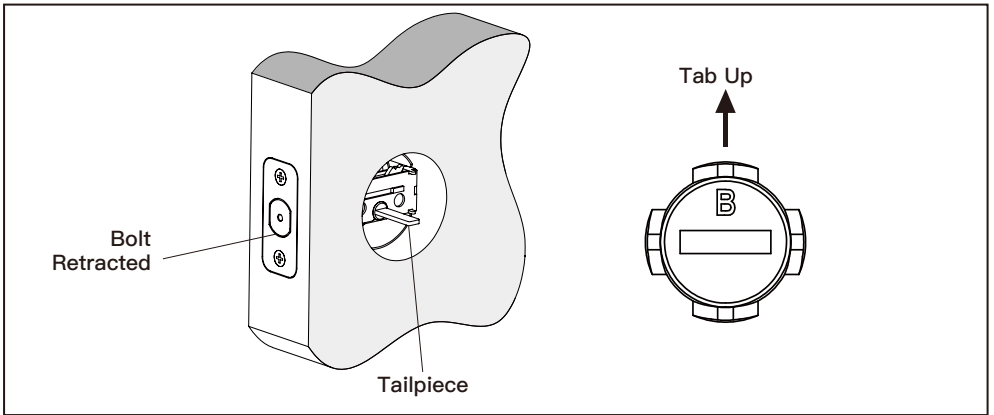

Revive Adapters – Four adapters provided to match any deadbolt tailpiece.

Tailpiece orientation is with the latch bolt retracted.

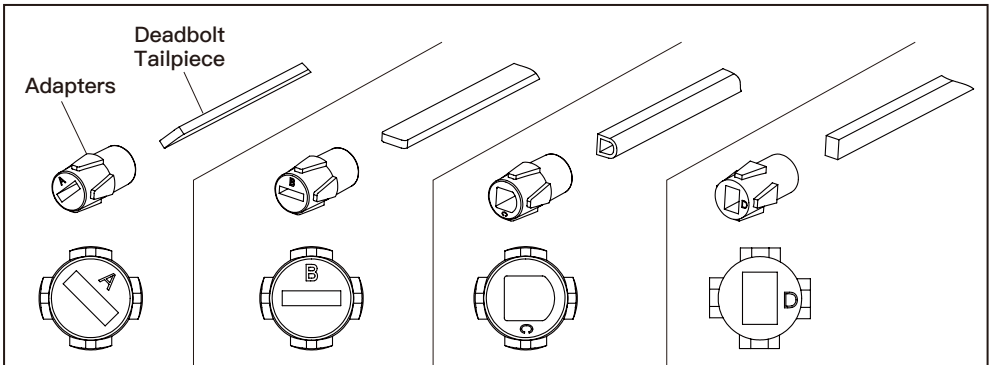

Keep in mind that the tailpiece of your deadbolt may be oriented differently depending on the side of the door that the hinges are on. Shown below are examples of three common deadbolts that are illustrative of this.

Kwikset® 660 (also representative of other Kwikset® and Weise®t models)

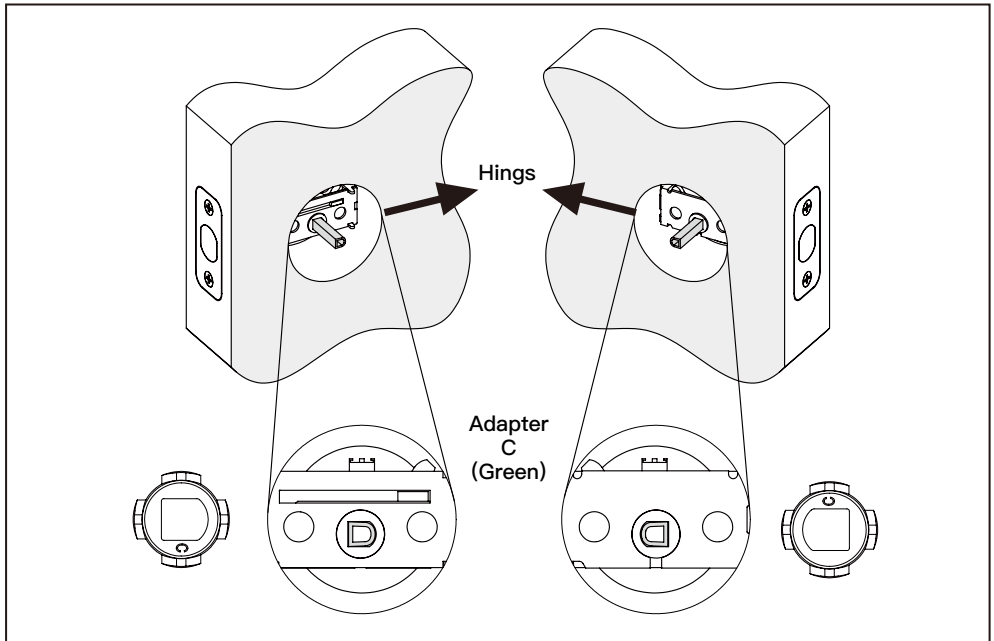

Kwikset and Wiser are registered trademarks of their respective holders. Use of them does not imply and affiliation with or endorsement by them.

Schlage® B60N

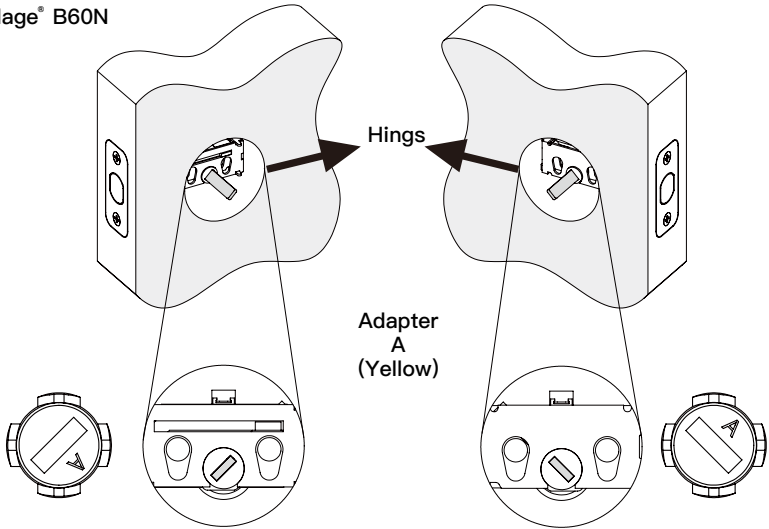

Schlage® B360

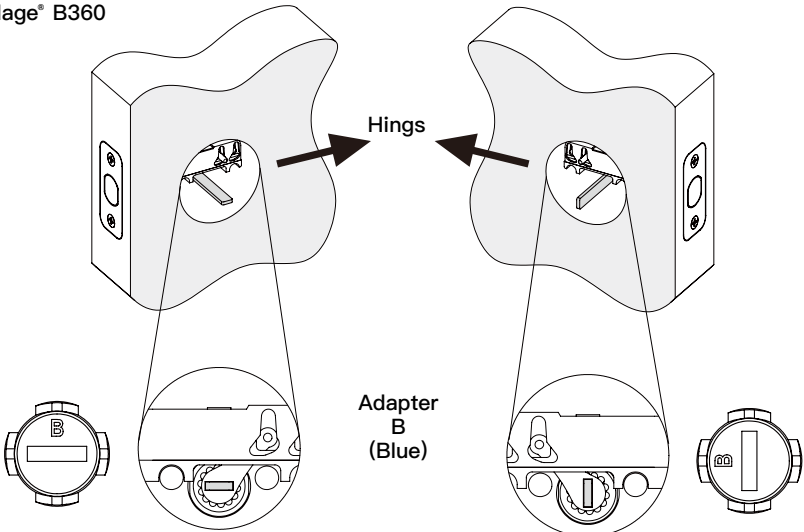

STEP 4

INSTALLING INTERIOR ASSEMBLY

Install the Mounting Plate
Follow the instructions in step 3

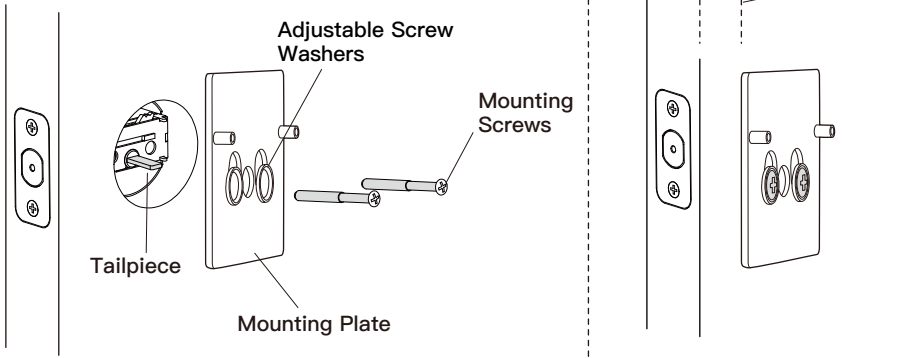

Install the Interior assembly

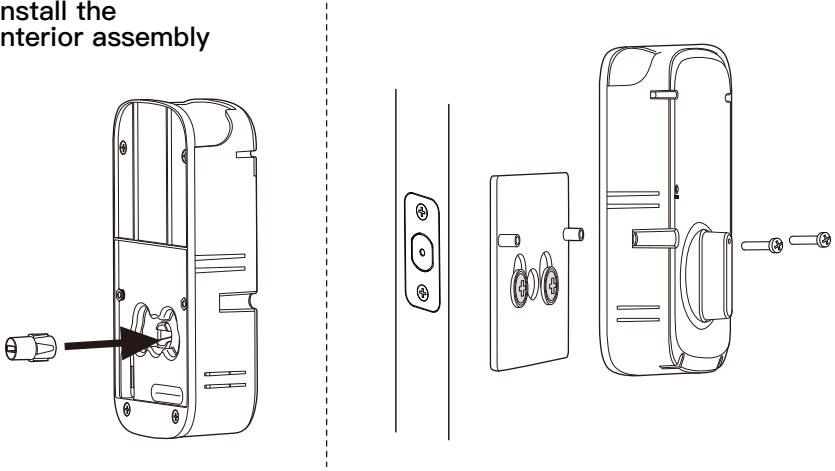

STEP 5

INSTALL BATTERY AND BATTERY COVER

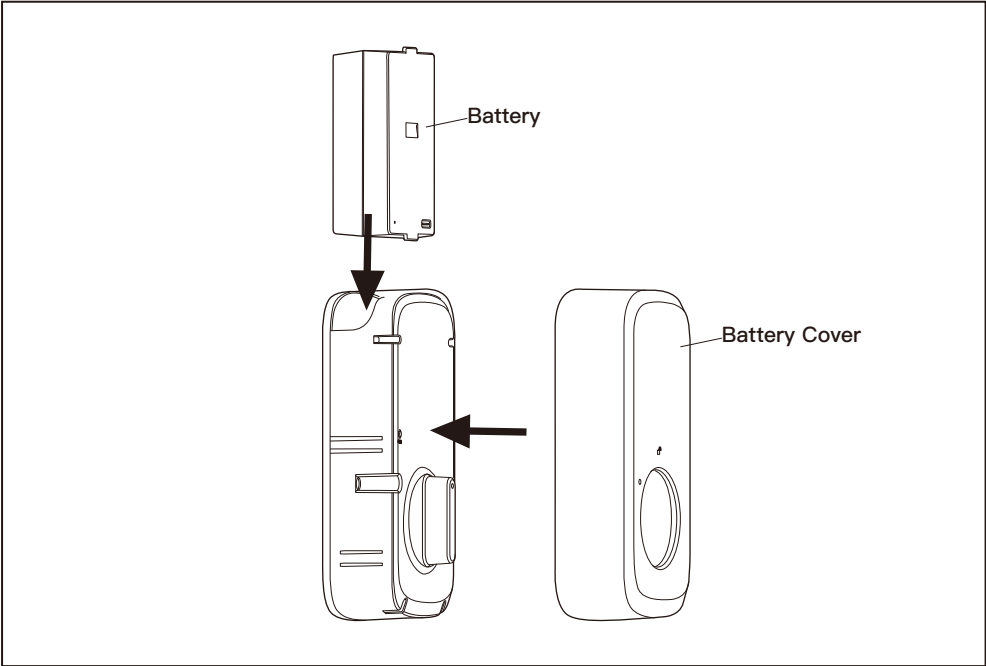

STEP 6

PAIR AND SET UP YOUR SMART LOCK VIA APP

 Note: The lock will not lock automatically before the setting is completed. To avoid being locked outside, pair your phone with the Smart Lock and set an access code unlocking the door.

To pair your phone with Smart Lock.

1. Scan the QR code on the back of the Smart Lock to get the information of the Smart Lock. Follow the on-screen instructions to complete the setup.

 Note:

- The first user that is paired is the only administrator, and can authorize other users to use the lock.
- Reset the device locally by press and HOLD the reset button for 5 seconds will not unpair the device from the administrator's APP.
- The administrator will not be able to setup and operate the device with Revolo App anymore after reset locally. Moreover the administrator has to unbind the Lock via Revolo App, so that the Lock can be paired or binded by other users.

STEP 7

INSTALLING DOOR SENSOR

 For optimal performance, Door Sensor should be mounted within 1" from the edge of your door, and within 1" from the top of the interior assembly.

- 7.1 Determine mounting location.
- 7.2 Stick the mounting tape to the door sensor.
- 7.3 Stick it on door frame.
- 7.4 Calibrate your Lock.

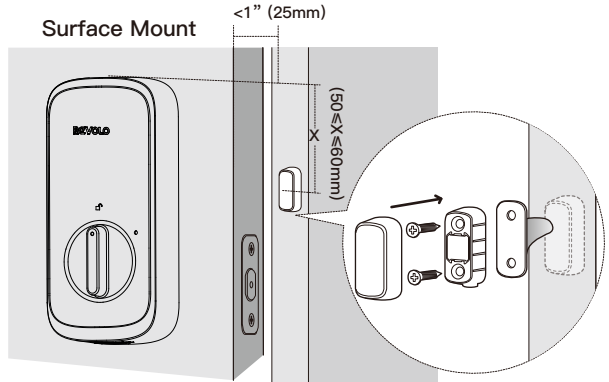

Flush Mount

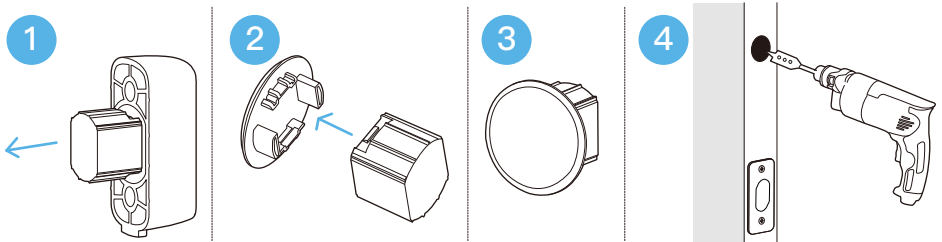

1. Remove magnet from housing
2. Attach magnet to cap
3. Determine mounting location and Drill the hole on your doorframe:
 - a. more than 1" (25mm) to 1.5" (38mm) from the top edge of your deadbolt strike plate,
 - b. Requires a $\frac{1}{2}''$ (12.5mm) deep hole,
 - c. Requires a $\frac{5}{8}''$ (16mm) inch diameter hole.
4. Insert Doorsensor into the hole

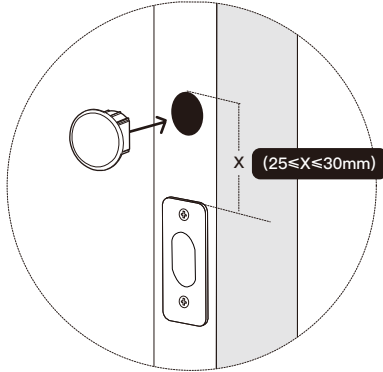

STEP 8

ADD ACCESSORY (Optional)

8.1. Go to the device to an add accessory,
“Settings”->“Accessory”->
“Add Accessories” or “+”.

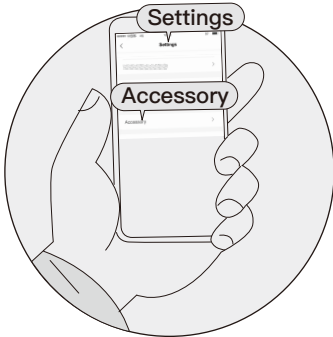

8.2. Hold the “*” + key for 5 seconds
to enter pairing mode.

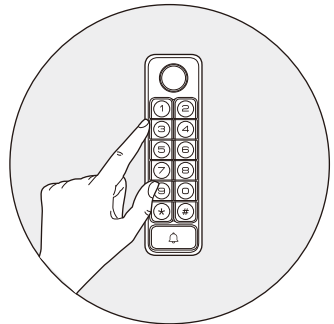

8.3. Follow instructions from App and accessory prompts, then complete the process.

⚠ Tip: If you encounter any problems during the use of the product, please contact support@irevolo.com.

FCC STATEMENT

This equipment has been tested and found to comply with the limits for a Class B digital device, pursuant to part 15 of the FCC Rules. These limits are designed to provide reasonable protection against harmful interference in a residential installation. This equipment generates, uses and can radiate radio frequency energy and, if not installed and used in accordance with the instructions, may cause harmful interference to radio communications. However, there is no guarantee that interference will not occur in a particular installation. If this equipment does cause harmful interference to radio or television reception, which can be determined by turning the equipment off and on, the user is encouraged to try to correct the interference by one or more of the following measures:

- Reorient or relocate the receiving antenna.
- Increase the separation between the equipment and receiver.
- Connect the equipment into an outlet on a circuit different from that to which the receiver is connected.
- Consult the dealer or an experienced radio/TV technician for help.

FCC Radiation Exposure Statement

This device complies with FCC radiation exposure limits set forth for an uncontrolled environment. This equipment must be installed and operated in accordance with provided instructions and the antenna(s) used for this transmitter must be installed to provide a separation distance of at least 20 cm from all persons.

This device complies with Part 15 of the FCC Rules. Operation is subject to the following two conditions:

- (1) this device may not cause harmful interference, and
- (2) this device must accept any interference received, including interference that may cause undesired operation.

Caution!

Any changes or modifications not expressly approved by the party responsible for compliance could void the user's authority to operate the equipment.

CANADA STATEMENT

This device contains licence-exempt transmitter(s)/receiver(s) that comply with Innovation, Science and Economic Development Canada's licence-exempt RSS(s). Operation is subject to the following two conditions:

- (1) This device may not cause interference.
- (2) This device must accept any interference, including interference that may cause undesired operation of the device.

L'émetteur/récepteur exempt de licence contenu dans le présent appareil est conforme aux CNR d'Innovation, Sciences et Développement économique Canada applicables aux appareils radio exempts de licence. L'exploitation est autorisée aux deux conditions suivantes :

- 1) L'appareil ne doit pas produire de brouillage;
- 2) L'appareil doit accepter tout brouillage radioélectrique subi, même si le brouillage est susceptible d'en compromettre le fonctionnement.

The device meets the exemption from the routine evaluation limits in section 2.5 of RSS 102 and compliance with RSS-102 RF exposure, users can obtain Canadian information on RF exposure and compliance.

Le dispositif rencontre l'exemption des limites courantes d'évaluation dans la section 2.5 de RSS 102 et la conformité à l'exposition de RSS-102 rf, utilisateurs peut obtenir l'information canadienne sur l'exposition et la conformité de rf.

This transmitter must not be co-located or operating in conjunction with any other antenna or transmitter. This equipment should be installed and operated with a minimum distance of 20 centimeters between the radiator and your body.

Cet émetteur ne doit pas être Co-placé ou ne fonctionnant en même temps qu'aucune autre antenne ou émetteur. Cet équipement devrait être installé et actionné avec une distance minimum de 20 centimètres entre le radiateur et votre corps.

WARNINGS

Failure to follow the below instructions could result in damage to the product and void the factory warranty.

The accuracy of the door preparation is critical to allow proper functioning and security of this Revolo Product. Misalignment of the door prep and lock can cause performance degradation and hinder the security functions of the lock.

Finish Care: This lockset is designed to provide the highest standard of product quality and performance. Care should be taken to ensure a long-lasting finish. When cleaning is required use a soft, damp cloth. Using lacquer thinner, caustic soaps, abrasive cleaners or polishes could damage the coating and result in tarnishing.