

# Digital Fingerprint Door Lock With Doorbell

User Guide/ Installation Instruction

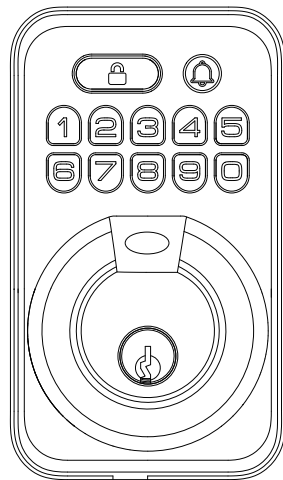

Thank you for purchasing our products. Please review this manual thoroughly before operating your device. All pictures in this manual are for illustration purpose only. Actual product may vary due to product upgrade.

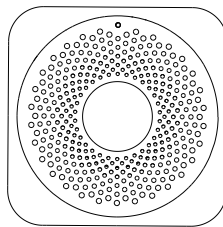

# User Guide

- P 1 At a Glance
- P 2 How to Use
- P 4 *Definitions*
- P 5 Code format

# Installation Instruction

- P 8 STEP 1: Prepare the door and check dimensions
- P 9 STEP 2: Install the latch and strike
- P 11 STEP 3: Install exterior assembly
- P 12 STEP 4: Install interior assembly
- P 13 STEP 5: Detect left/right hand door installation
- P 14 Factory Default Settings
- P 15 Programming Guide
- P 17 Troubleshooting
- P 18 Information & Safety Warnings

## TOOL REQUIRED:



Do not use an electric screwdriver during installation.

## IMPORTANT:



Do not load batteries until lock is completely installed.

# USER GUIDE

## At a Glance

### Exterior Assembly

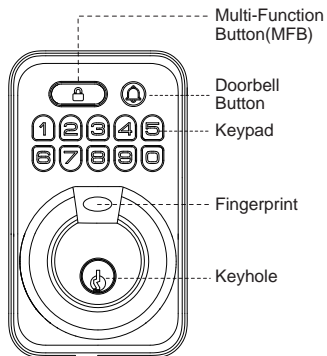

### Interior Assembly

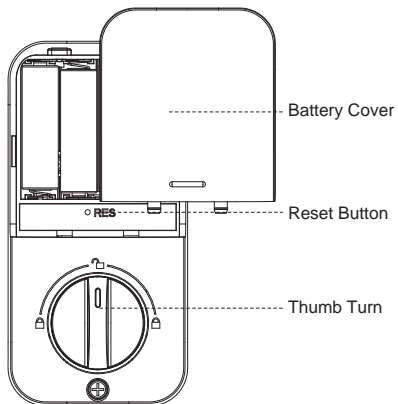

### Doorbell

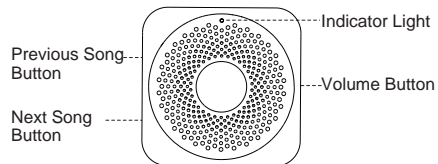

Previous Song Button

Next Song Button

## How to Use

### UNLOCK the door from outside

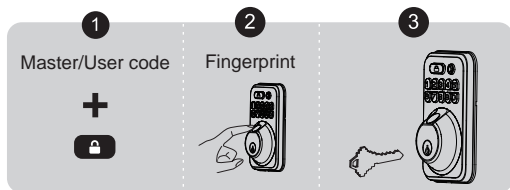

### LOCK the door from outside

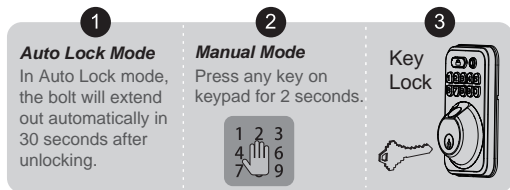

### UNLOCK the door from inside

Rotate the thumb turn to unlock position.

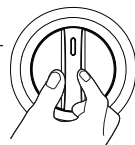

### LOCK the door from inside

#### **Auto Lock Mode**

In Auto Lock mode, the bolt will extend out automatically in 30 seconds after unlocking.

#### **Manual Mode**

Rotate the thumb turn to lock position.

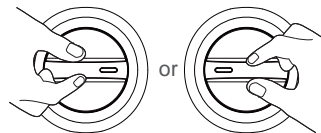

## How to Use

---

### How to pair the doorbell

**Step1:** Power on the device. Hold down the volume button for 3 seconds until the blue indicator light is on.

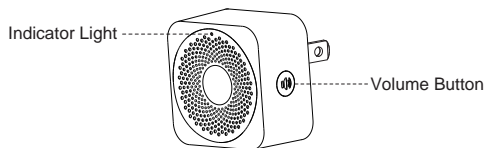

**Step3:** Press the doorbell button to test whether your doorbell is paired successfully.

**Step2:** Press the doorbell button once to pair the doorbell until the indicator light is off.

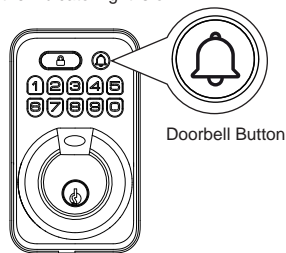

### How to unpair the doorbell

Hold down the volume button for 10 seconds until the indicator light flashes 4 times and fades out. It means the doorbell has been unpaired successfully.

### How to adjust the volume of the doorbell

The default volume is 3, press the volume button once to increase the volume to the maximum of 5, then keep pressing the volume button to decrease the volume to the minimum of 1.

### How to switch the song of the doorbell

Press the previous song button or next song button to switch the song of the doorbell. There're a total of 38 songs available to play.

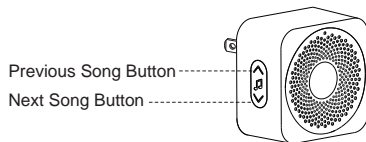

## Definitions

---

- **Master Code**

Required for programming and feature settings. Master code can be used to unlock the door under vacation mode. The default master code needs to be changed before programming.

Property owner & manager should keep this information confidential.

- **Auto Lock**

Automatically locks the deadbolt 30 seconds after unlocking. This feature is off by default. You can customize the Auto Lock time delay between 10 and 99 seconds.

- **Key Unlock**

Key Unlock is always available when the batteries are completely dead or valid User Codes are forgotten.

- **Low Battery Indicator**

If you hear 10 beeps along with 10 red light flashing after pressing any key to lock or unlock the door, that's an alert for replacing batteries. Please replace with 4 brand new AA alkaline batteries and do not mix used and new batteries. All settings are stored in the lock while the batteries are removed and replaced.

- **Wrong Entry Limit**

After 10 unsuccessful attempts at entering a invalid PIN code, the unit will shut down for 3 minutes.

- **Silent Mode**

The beep sounds when pressing keypad can be muted. But you will still hear low battery and system alerts.

- **Vacation Mode**

This is a security feature for you when you are leaving your home for vacation or long trip. Enabling vacation mode will restrict all user codes until master code is entered on keypad. If the lock would be unlocked by the thumb turn from the inside, the lock will sound an alarm.

- **One Time Code**

This code only can be used once and will be automatically deleted after used.

- **Unlock with Fake code**

User can prevent pin code exposure from strangers by entering random digits before or after pin code.

83618 137192 14710  
-----  
password  
----- Random digits -----

## Code Format

---

1. Master Code(4 to 10 digits): The default Master Code is **12345678**. It is required that you change it to a code of your own before programming.
2. User Code: 20 User Codes (including one one-time user code) can be programmed and stored in the lock.
3. Both Master Code and User Code don't support the following combination of numbers.

- A. 

1	2	3	4	5	6	7	8	9
---	---	---	---	---	---	---	---	---

 ✗ Forward number sequence
- B. 

9	8	7	6	5	4	3	2	1
---	---	---	---	---	---	---	---	---

 ✗ Backward number sequence
- C. 

2	2	2	2	2	2	2	2	2
---	---	---	---	---	---	---	---	---

 ✗ Repeat number sequence
- D. If 

5	6	8	3
---	---	---	---

 ✓
- Then 

5	6	8	3	9	1
---	---	---	---	---	---

 ✗ Contain existing code sequence
- and 

9	1	5	6	8	3
---	---	---	---	---	---







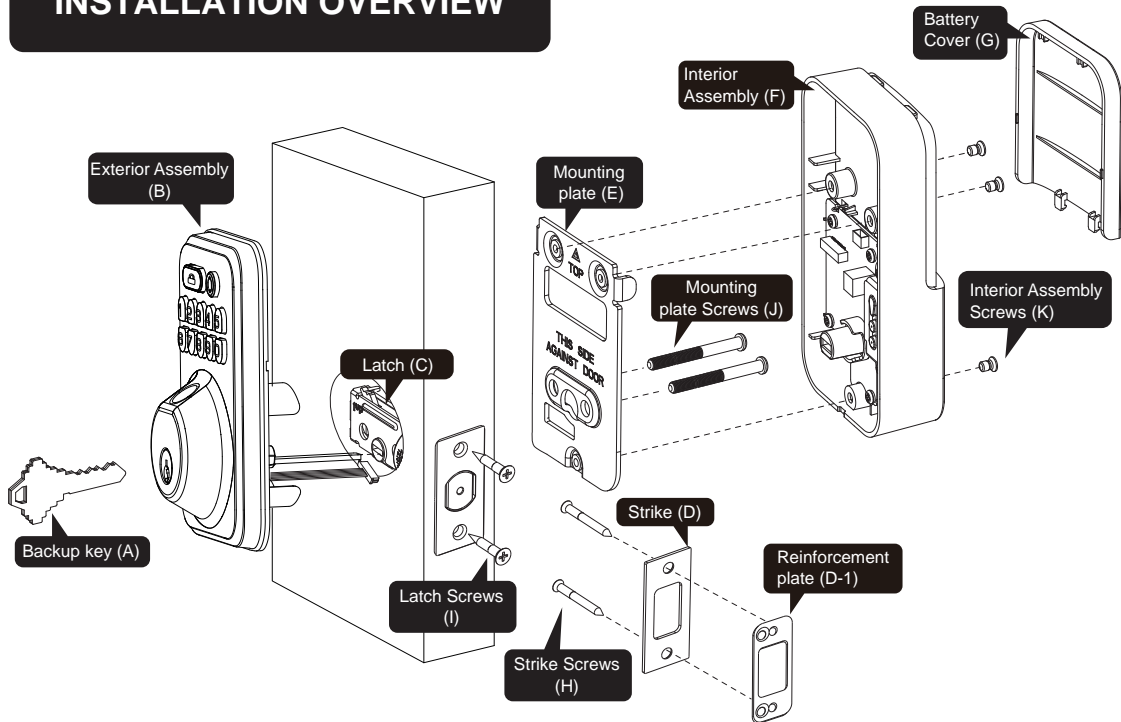

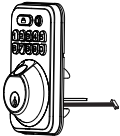

 ✗

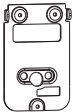
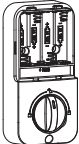

# INSTALLATION OVERVIEW

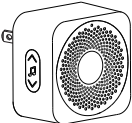

## Parts List

<p><b>A</b> Backup Key x2</p> 	<p><b>B</b> Exterior Assembly x1</p> 	<p><b>C</b> Latch x1</p>  <p><b>C-1</b> Drive-In Collar (Optional)</p> 	<p><b>D</b> Strike x1</p>  <p><b>D-1</b> Reinforcement Plate x1 (optional)</p> 
<p><b>E</b> Mounting Plate x1</p> 	<p><b>F</b> Interior Assembly x1</p> 	<p><b>G</b> Battery Cover x1</p> 	<p><b>H</b> Strike Screws x2</p>  <p><b>I</b> Latch Screws x2</p> 
<p><b>J</b> Mounting Plate Screws x2</p> 	<p><b>K</b> Interior Assembly Screws x3</p> 	<p><b>L</b> Reset Tool x1</p> 	<p><b>M</b> Doorbell</p> 

If any parts are missing or damaged, please contact customer support.

# 1 Prepare the door and check dimensions

A

Measure to confirm that the bore hole is 1-1/2" or 2-1/8" (38mm or 54mm).

Measure to confirm that the hole in the door edge is 1" (25mm).

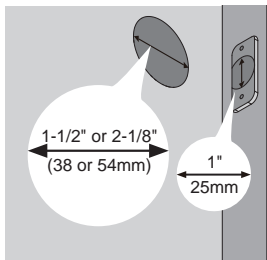

B

Measure to confirm that the backset is either 2-3/8" or 2-3/4" (60 or 70mm)

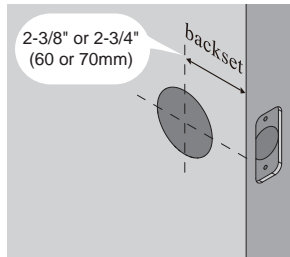

C

Measure to confirm that the door is 1-3/8" to 2" (35mm to 50mm) thick.

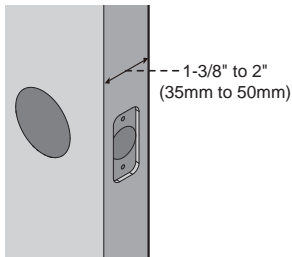

D

Make sure the hole in the door frame is drilled a minimum of 1" (25mm) deep, to leave enough space for the deadbolt to extend into the door frame when the door is locked.

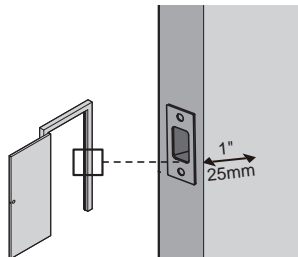

**Notes:** Make sure the door frame is aligned with the door and there are no obstructions stuck in the door frame.

## 2 Install the latch and strike

### A Determine backset and adjust the latch

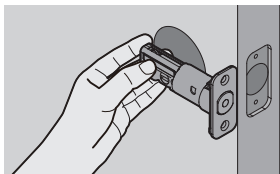

Hold the latch in front of the door hole, with the latch face flush against the door edge. Is the slotted hole centered in the door hole?

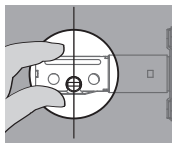

**YES**

No adjustment is required.  
Proceed to next step.

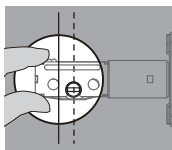

**NO**

Slotted hole is NOT centered.

Rotate and pull the latch as shown to extend latch.

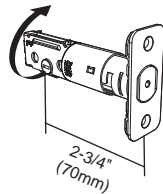
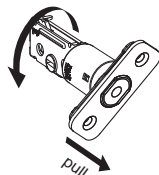
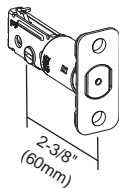

### B

#### Install the latch

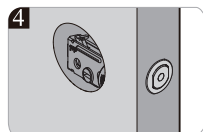
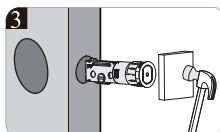
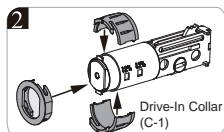
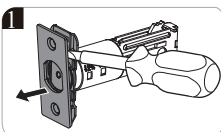
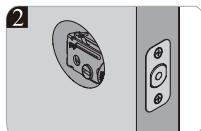
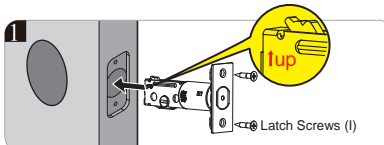

- C Use a screwdriver to test if deadbolt works smoothly.

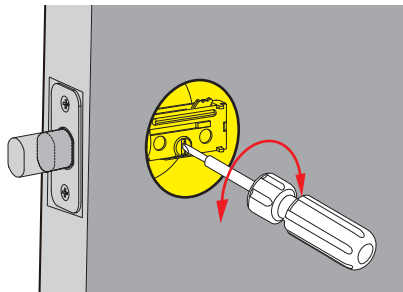

- D Install strike on the door frame.

**! IMPORTANT:**

Make sure the hole in door frame is drilled a minimum of 1" (25mm) deep.

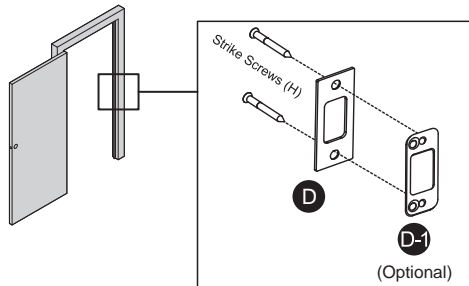

### 3 Install exterior assembly

#### ! IMPORTANT:

Before installation, make sure the latch is fully retracted (in the unlocked position).



- B** With the latch fully retracted (in the unlocked position), route the cable below the latch, and insert the tailpiece through the slot in the latch.

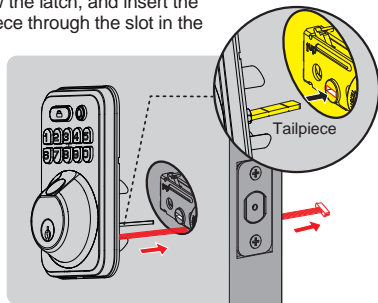

- A** Measure the diameter of the hole in the door.

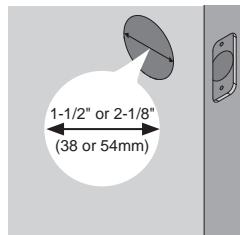

**1-1/2" (38mm)**



Remove the spacer

**2-1/8" (54mm)**

Proceed to next step

- C** Secure the mounting plate with the supplied screws. Do not overtighten screws.

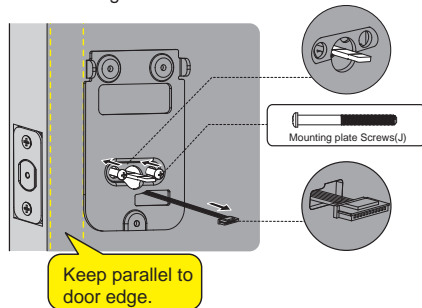

## 4 Install interior assembly

A

Push the battery cover out in the direction as illustrated.

**! IMPORTANT:**

Do not load batteries until lock is completely installed.

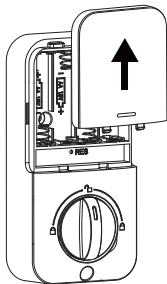

B

Insert the cable connector to the socket. Push the connector in firmly until it is completely attached.

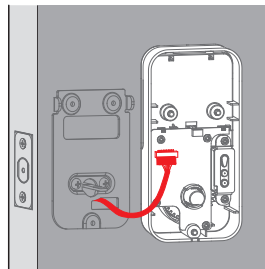

C

Keep the thumb turn in vertical position and install the interior assembly.

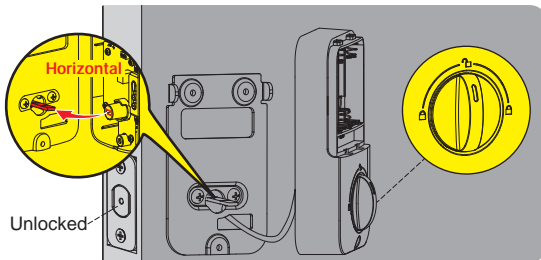

D

Attach Interior Assembly to Mounting Plate and tighten 3 Screws.

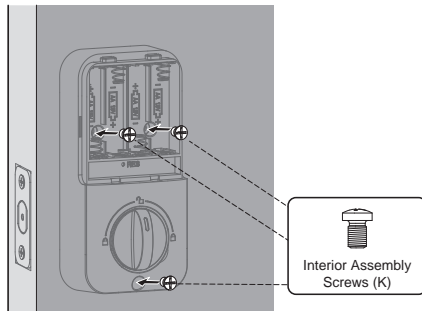

**5 Detect left/right hand door installation**

Reset the lock to teach the lock the orientation of the door.

**IMPORTANT:**

This step is required and crucial for the lock to operate properly.

- A** While the door is **OPEN** and **UNLOCKED**, load 3 AA batteries into the battery compartment.

**Note:**

For long last, please use all new, non-rechargeable Alkaline batteries only.

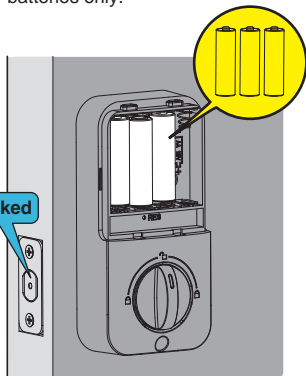

- B** Press and hold the Reset button on the interior assembly by using the reset tool.

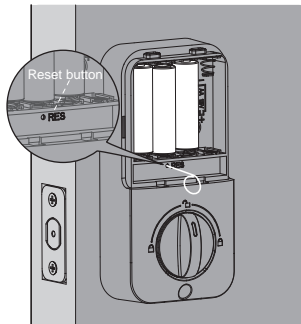

- C** Load the **4th** battery and keep holding the reset button for 3 seconds, until you hear the sound of "beep". The latch bolt will extend to learn the orientation of the door automatically.

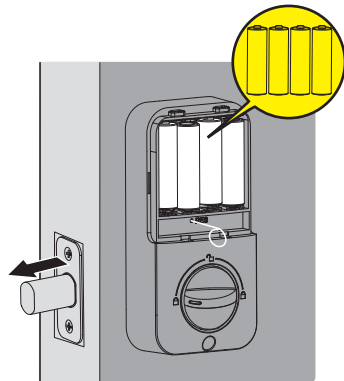



## Factory Default Settings

### How to Reset?



**IMPORTANT:** The resetting will delete all User Codes stored in the lock.

- Step 1.** Keep the door open and unlocked.
- Step 2.** Press and hold the Reset button, at the same time take out one battery and then place it back.
- Step 3.** Keep holding the Reset button for 3 seconds, until you hear the sound of "beep" and the latch will extend out automatically.

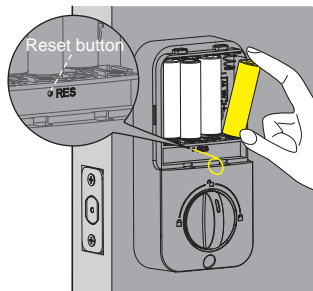

Settings	Factory Default
Master Code	12345678
Auto Lock	Disabled
Silent Mode	Disabled
Wrong Code Entry Limit	10 times
Shutdown Time	3 mins
Vacation Mode	Disabled

# Programming Guide



## IMPORTANT:

The default Master Code is **12345678**. It is required that you change it to a code of your own before programming.

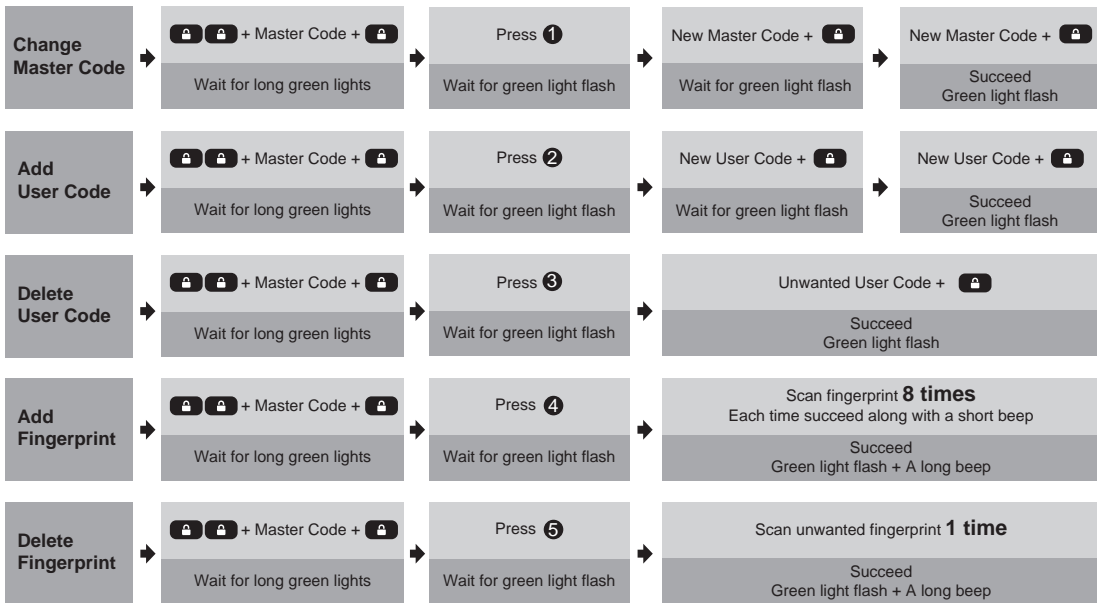

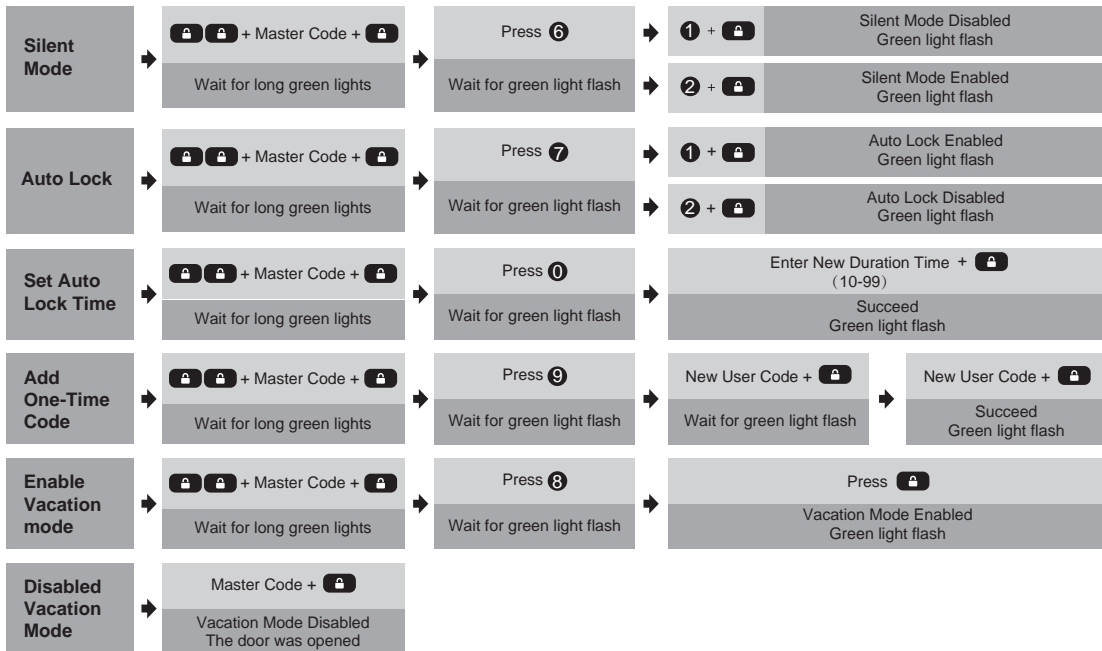

## Troubleshooting

---

### ***Why does not the latch extend but the motor is rotating when resetting my lock?***

Improper installation may have caused the issue. Please follow the steps to review:

1. Please make sure the latch and strike are aligned.
2. Please slightly loosen the mounting screws on the external assembly keypad and the latch bolt if the screws are over-tightened.
3. Please open your door and reset the lock.

### ***Why does not the latch extend and the motor isn't rotating when resetting my lock?***

The deadbolt latch should be retracted(unlocked) through all your installation process.

The thumb turn should be vertical in your installation steps 4C and 5A.

Please open your door and reset the lock.

### ***When I attempt to lock/unlock my deadbolt, why does the latch go in and out for a few times?***

It happens when the latch and strike are misaligned.

Please make sure the bolt hole on the door frame is at least 1 inch deep, so that the bolt can be fully extended.

Please check if the door can be closed properly, the deadbolt should not impact the strike or door frame on the door frame side, it should go directly into the hole properly.

### ***Why does my lock only work properly when the backup key is in? Why am I unable to pull the key out in the unlocked position?***

You may need to re-install the whole lock.

Please make sure when you start to install, the lock is in unlocked status;

Please make sure the thumb turn is vertical.

Please do not put the backup key in the lock during the installation.

### ***What does 5 short and fast beeps mean while programming?***

It alerts you either time-out or wrong entry.

Please be sure to complete each setting step within 5 seconds.

Please change the default master code in the first time programming.

Please be sure the user code is with correct format and with 4 to 10 digits.

### ***What if I forget my Master Codes?***

If you forget your Master code, resetting your lock, then the original master code (12345678) works, and all previous user codes were erased.

## Information & Safety Warnings

---

- Protect your User Codes and Master Code.
  - Restrict access to your lock's interior assembly and routinely check your settings to ensure they have not been altered without your knowledge.
  - Do not use an electric screwdriver during installation.
  - This manufacturer advises that no lock can provide complete security by itself.
  - This lock may be defeated by forcible or technical means, or evaded by entry elsewhere on the property.
  - No lock can substitute for caution, awareness of your environment, and common sense.
- Care should be taken to ensure a long-lasting finish. When cleaning is required use a soft, damp cloth. Using lacquer thinner, caustic soaps, abrasive cleaners or polishes could damage the coating and result in tarnishing.
  - The lock is water resistant. It can withstand water splashes; however, do not let water and liquids get into the lock.
  - Avoid exposure to direct sunlight. Long-term exposure to direct sunlight may damage the lock.

**FCC STATEMENT :**

This device complies with Part 15 of the FCC Rules. Operation is subject to the following two conditions:

- (1) This device may not cause harmful interference, and
- (2) This device must accept any interference received, including interference that may cause undesired operation.

Warning: Changes or modifications not expressly approved by the party responsible for compliance could void the user's authority to operate the equipment.

NOTE: This equipment has been tested and found to comply with the limits for a Class B digital device, pursuant to Part 15 of the FCC Rules. These limits are designed to provide reasonable protection against harmful interference in a residential installation. This equipment generates uses and can radiate radio frequency energy and, if not installed and used in accordance with the instructions, may cause harmful interference to radio communications. However, there is no guarantee that interference will not occur in a particular installation. If this equipment does cause harmful interference to radio or television reception, which can be determined by turning the equipment off and on, the user is encouraged to try to correct the interference by one or more of the following measures:

Reorient or relocate the receiving antenna.

Increase the separation between the equipment and receiver.

Connect the equipment into an outlet on a circuit different from that to which the receiver is connected.

Consult the dealer or an experienced radio/TV technician for help.

**FCC Radiation Exposure Statement:**

This equipment complies with FCC radiation exposure limits set forth for an uncontrolled environment. This equipment should be installed and operated with minimum distance 20cm between the radiator & your body.







<b>物料名称:</b>	TD002-C说明书	<b>成品尺寸:</b>	164x105mm
<b>时 间:</b>		<b>材 质:</b>	105g双铜纸
<b>设 计:</b>		<b>工 艺:</b>	四色双面印刷; 骑马钉
<b>料 号:</b>		<b>备 注:</b>	