

FCC Report (Bluetooth)

Product Name : True Wireless Earbuds
Trade mark : BlitzWolf
Model No. : BW-FYE1, BW-FYE2, BW-FYE3, BW-FYE4,
BW-FYE5, BW-FYE6, BW-FYE7, BW-FYE8
BW-FYE9, BW-FYE10, BW-FYE11, BW-
FYE12, BW-FYE13, BW-FYE14, BW-FYE15,
AA-UM1, AA-UM2, AA-UM3, AA-UM4, AA-
UM5
FCC ID : 2AQXL-BW-FYE5
Report Number : BLA-EMC-201907-A34-01
Date of sample receipt : July 15, 2019
Date of Test : July 15, 2019–July 31, 2019
Date of Issue : August 1, 2019
Test standard : FCC CFR Title 47 Part 15 Subpart C Section
15.247
Test result : PASS

Prepared for:

Tong De Limited

**Palm Grove House, P.O.Box 438, Road Town, Tortola, British Virgin
Islands**

Prepared by:

Qianhai BlueAsia of Technical Services(Shenzhen) Co., Ltd.

IOT Test Centre of BlueAsia

**No. 448 Bulong Road, Bantian Street, Longgang District, Shenzhen,
China**

TEL: +86-755-28682673

FAX: +86-755-28682673

Compiled by:

Bason

Review by:

Sweet . wang

Approved by:

Emen - li

Date: August 1, 2019



2 Version

Version No.	Date	Description
00	August 1, 2019	Original

BlueAsia

3 Contents

Page

1	COVER PAGE	1
2	VERSION	2
3	CONTENTS	3
4	TEST SUMMARY	4
5	GENERAL INFORMATION	5
5.1	GENERAL DESCRIPTION OF EUT	5
5.2	TEST MODE	7
5.3	TEST FACILITY.....	7
5.4	TEST LOCATION.....	7
5.5	OTHER INFORMATION REQUESTED BY THE CUSTOMER.....	7
5.6	DESCRIPTION OF SUPPORT UNITS	7
6	TEST INSTRUMENTS LIST	8
7	TEST RESULTS AND MEASUREMENT DATA	10
7.1	ANTENNA REQUIREMENT	10
7.2	CONDUCTED EMISSIONS	11
7.3	CONDUCTED PEAK OUTPUT POWER.....	14
7.4	20DB EMISSION BANDWIDTH.....	18
7.5	CARRIER FREQUENCIES SEPARATION.....	22
7.6	HOPPING CHANNEL NUMBER	26
7.7	DWELL TIME.....	27
7.8	PSEUDORANDOM FREQUENCY HOPPING SEQUENCE	29
7.9	BAND EDGE.....	30
7.9.1	<i>Conducted Emission Method</i>	30
7.9.2	<i>Radiated Emission Method</i>	34
7.10	SPURIOUS EMISSION	36
7.10.1	<i>Conducted Emission Method</i>	36
7.10.2	<i>Radiated Emission Method</i>	38
8	TEST SETUP PHOTO	46
9	EUT CONSTRUCTIONAL DETAILS.....	48

4 Test Summary

Test Item	Section in CFR 47	Result
Antenna Requirement	15.203/15.247 (c)	Pass
AC Power Line Conducted Emission	15.207	Pass
Conducted Peak Output Power	15.247 (b)(1)	Pass
20dB Occupied Bandwidth	15.247 (a)(1)	Pass
Carrier Frequencies Separation	15.247 (a)(1)	Pass
Hopping Channel Number	15.247 (a)(iii)	Pass
Dwell Time	15.247 (a)(iii)	Pass
Pseudorandom Frequency Hopping Sequence	15.247(a)(1)	Pass
Radiated Emission	15.205/15.209	Pass
Band Edge	15.247(d)	Pass

Pass: The EUT complies with the essential requirements in the standard.

Remark: Test according ANSI C63.10:2013

Measurement Uncertainty

Test Item	Frequency Range	Measurement Uncertainty	Notes
Radiated Emission	9kHz ~ 30MHz	± 4.34dB	(1)
Radiated Emission	30MHz ~ 1000MHz	± 4.24dB	(1)
Radiated Emission	1GHz ~ 26.5GHz	± 4.68dB	(1)
AC Power Line Conducted Emission	0.15MHz ~ 30MHz	± 3.45dB	(1)

Note (1): The measurement uncertainty is for coverage factor of k=2 and a level of confidence of 95%.

5 General Information

5.1 General Description of EUT

Product Name:	True Wireless Earbuds
Model No.:	BW-FYE1, BW-FYE2, BW-FYE3, BW-FYE4, BW-FYE5, BW-FYE6, BW-FYE7, BW-FYE8, BW-FYE9, BW-FYE10, BW-FYE11, BW-FYE12, BW-FYE13, BW-FYE14, BW-FYE15, AA-UM1, AA-UM2, AA-UM3, AA-UM4, AA-UM5
Test Model No.:	BW-FYE5
<i>Remark: All above models are identical in the same PCB layout, interior structure and electrical circuits. The differences are model name for commercial purpose.</i>	
Serial No.:	N/A
Sample(s) Status	Engineer sample
Hardware:	A1.0
Software:	A1.0
Operation Frequency:	2402MHz-2480MHz
Channel numbers:	79
Channel separation:	1MHz
Modulation type:	GFSK, $\pi/4$ -DQPSK, 8-DPSK
Antenna Type:	Chip Antenna
Antenna gain:	4.97dBi
Power supply:	DC 3.7V

Operation Frequency each of channel							
Channel	Frequency	Channel	Frequency	Channel	Frequency	Channel	Frequency
1	2402MHz	21	2422MHz	41	2442MHz	61	2462MHz
2	2403MHz	22	2423MHz	42	2443MHz	62	2463MHz
3	2404MHz	23	2424MHz	43	2444MHz	63	2464MHz
4	2405MHz	24	2425MHz	44	2445MHz	64	2465MHz
5	2406MHz	25	2426MHz	45	2446MHz	65	2466MHz
6	2407MHz	26	2427MHz	46	2447MHz	66	2467MHz
7	2408MHz	27	2428MHz	47	2448MHz	67	2468MHz
8	2409MHz	28	2429MHz	48	2449MHz	68	2469MHz
9	2410MHz	29	2430MHz	49	2450MHz	69	2470MHz
10	2411MHz	30	2431MHz	50	2451MHz	70	2471MHz
11	2412MHz	31	2432MHz	51	2452MHz	71	2472MHz
12	2413MHz	32	2433MHz	52	2453MHz	72	2473MHz
13	2414MHz	33	2434MHz	53	2454MHz	73	2474MHz
14	2415MHz	34	2435MHz	54	2455MHz	74	2475MHz
15	2416MHz	35	2436MHz	55	2456MHz	75	2476MHz
16	2417MHz	36	2437MHz	56	2457MHz	76	2477MHz
17	2418MHz	37	2438MHz	57	2458MHz	77	2478MHz
18	2419MHz	38	2439MHz	58	2459MHz	78	2479MHz
19	2420MHz	39	2440MHz	59	2460MHz	79	2480MHz
20	2421MHz	40	2441MHz	60	2461MHz		

Note:

In section 15.31(m), regards to the operating frequency range over 10 MHz, the Lowest frequency, the middle frequency, and the highest frequency of channel were selected to perform the test, and the selected channel see below:

Channel	Frequency
The lowest channel	2402MHz
The middle channel	2441MHz
The Highest channel	2480MHz

5.2 Test mode

Transmitting mode	Keep the EUT in continuously transmitting mode.
<p><i>Remark: During the test, the test voltage was tuned from 85% to 115% of the nominal rated supply voltage, and found that the worst case was under the nominal rated supply condition. So the report just shows that condition's data.</i></p>	

5.3 Test Facility

<p>The test facility is recognized, certified, or accredited by the following organizations:</p> <ul style="list-style-type: none"> ● FCC — Designation No.: CN1252 <i>Qianhai BlueAsia of Technical Services(Shenzhen) Co., Ltd</i> has been registered and fully described in a report filed with the (FCC) Federal Communications Commission. The acceptance letter from the FCC is maintained in files. Designation CN1252. ● ISED — CAB identifier No.: CN0028 <i>Qianhai BlueAsia of Technical Services(Shenzhen) Co., Ltd</i> has been registered by Certification and Engineering Bureau of ISED for radio equipment testing with CAB identifier CN0028

5.4 Test Location

All tests were performed at:
<p><i>All tests were performed at:</i> <i>Qianhai BlueAsia of Technical Services(Shenzhen) Co., Ltd.</i> <i>IOT Test Centre of BlueAsia</i> <i>No. 448 Bulong Road, Bantian Street, Longgang District, Shenzhen, China</i> <i>Telephone: TEL: +86-755-28682673 FAX: +86-755-28682673</i> No tests were sub-contracted.</p>

5.5 Other Information Requested by the Customer

None.

5.6 Description of Support Units

Manufacturer	Description	Model	Serial Number
UGREEN	Adapter	CD112	20358
Lenovo	Notebook computer	E470C	PF-10FB5C

6 Test Instruments list

Radiated Emission:						
Item	Test Equipment	Manufacturer	Model No.	Serial No.	Cal.Date (mm-dd-yy)	Cal.Due date (mm-dd-yy)
1	3m SAC	SKET	9m*6 m*6m	966	06-10-2018	06-09-2023
2	Broadband Antenna	SCHWARZBECK	VULB9168	00836 P:00227	07-14-2019	07-13-2020
3	Horn Antenna	SCHWARZBECK	9120D	01892 P:00331	07-14-2019	07-13-2020
4	EMI Test Software	EZ	EZ	N/A	N/A	N/A
5	Pre-amplifier	SKET	N/A	N/A	07-14-2019	07-13-2020
6	Spectrum analyzer	Rohde & Schwarz	FSP40	100817	05-24-2019	05-23-2020
7	EMI Test Receiver	Rohde & Schwarz	ESR7	101199	03-21-2019	03-20-2020
8	Controller	SKET	N/A	N/A	N/A	N/A
9	Vector Signal Generator	Agilent	E4438C	MY45092582	05-24-2019	05-23-2020
10	Signal Generator	Agilent	E8257D	MY44320250	05-24-2019	05-23-2020
11	Coaxial Cable	BlueAsia	BLA-XC-02	N/A	N/A	N/A
12	Coaxial Cable	BlueAsia	BLA-XC-03	N/A	N/A	N/A
13	Coaxial Cable	BlueAsia	BLA-XC-01	N/A	N/A	N/A

Conducted Emission						
Item	Test Equipment	Manufacturer	Model No.	Serial No.	Cal.Date (mm-dd-yy)	Cal.Due date (mm-dd-yy)
1	EMI Test Receiver	Rohde & Schwarz	ESPI3	101082	06-10-2019	06-09-2020
2	LISN	CHASE	MN2050D	1447	12-18-2019	12-17-2020
3	LISN	Rohde & Schwarz	ENV216	3560.6550.15	07-14-2019	07-13-2020
4	EMI Test Software	EZ	EZ	N/A	N/A	N/A
5	Temperature Humidity Chamber	Mingle	TH101B	N/A	07-14-2019	07-13-2020
6	Coaxial Cable	BlueAsia	BLA-XC-05	N/A	N/A	N/A

RF Conducted Test:						
Item	Test Equipment	Manufacturer	Model No.	Serial No.	Cal.Date (mm-dd-yy)	Cal.Due date (mm-dd-yy)
1	Spectrum Analyzer	Agilent	N9030A	MY50510123	05-24-2019	05-23-2020
2	Spectrum analyzer	Rohde & Schwarz	FSP40	100817	05-24-2019	05-23-2020
3	Vector Signal Generator	Agilent	E4438C	MY45092582	05-24-2019	05-23-2020
4	Signal Generator	Agilent	E8257D	MY44320250	05-24-2019	05-23-2020
5	Power Sensor	D.A.R.E	RPR3006W	17100015SNO27	05-24-2019	05-23-2020
6	Power Sensor	D.A.R.E	RPR3006W	17100015SNO28	05-24-2019	05-23-2020
7	DC Power Supply	LODESTAR	LP305DE	N/A	07-14-2019	07-13-2020
8	Temperature Humidity Chamber	Mingle	TH101B	N/A	07-14-2019	07-13-2020

7 Test results and Measurement Data

7.1 Antenna requirement

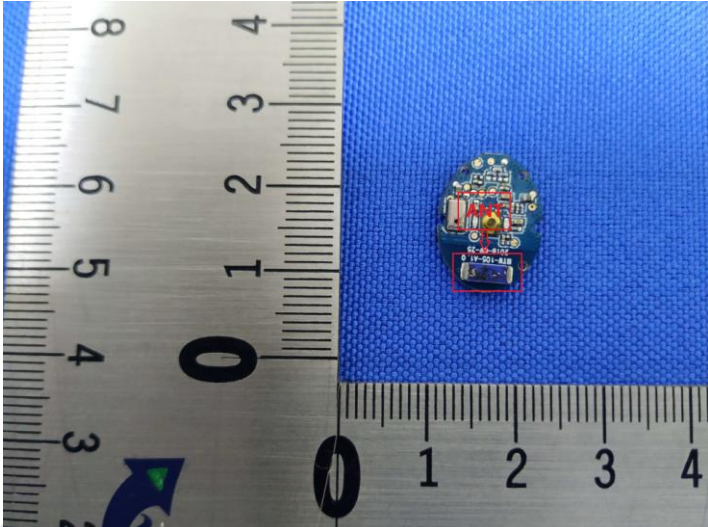
Standard requirement:	FCC Part15 C Section 15.203 /247(c)
<p>15.203 requirement: An intentional radiator shall be designed to ensure that no antenna other than that furnished by the responsible party shall be used with the device. The use of a permanently attached antenna or of an antenna that uses a unique coupling to the intentional radiator, the manufacturer may design the unit so that a broken antenna can be replaced by the user, but the use of a standard antenna jack or electrical connector is prohibited.</p> <p>15.247(c) (1)(i) requirement: (i) Systems operating in the 2400-2483.5 MHz band that is used exclusively for fixed. Point-to-point operations may employ transmitting antennas with directional gain greater than 6dBi provided the maximum conducted output power of the intentional radiator is reduced by 1 dB for every 3 dB that the directional gain of the antenna exceeds 6dBi.</p>	
E.U.T Antenna:	
<p><i>The antenna is Chip antenna, the best case gain of the antenna is 4.97dBi</i></p> 	

7.2 Conducted Emissions

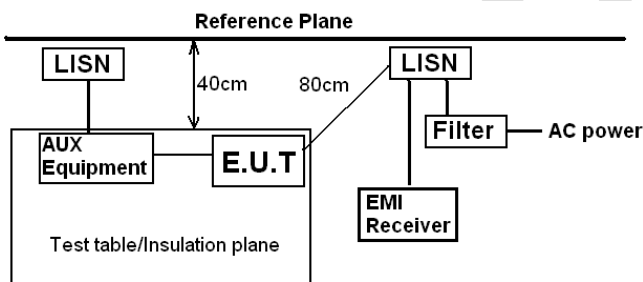
Test Requirement:	FCC Part15 C Section 15.207														
Test Method:	ANSI C63.10:2013														
Test Frequency Range:	150KHz to 30MHz														
Class / Severity:	Class B														
Receiver setup:	RBW=9KHz, VBW=30KHz, Sweep time=auto														
Limit:	<table border="1"> <thead> <tr> <th rowspan="2">Frequency range (MHz)</th> <th colspan="2">Limit (dBuV)</th> </tr> <tr> <th>Quasi-peak</th> <th>Average</th> </tr> </thead> <tbody> <tr> <td>0.15-0.5</td> <td>66 to 56*</td> <td>56 to 46*</td> </tr> <tr> <td>0.5-5</td> <td>56</td> <td>46</td> </tr> <tr> <td>5-30</td> <td>60</td> <td>50</td> </tr> </tbody> </table> <p>* Decreases with the logarithm of the frequency.</p>	Frequency range (MHz)	Limit (dBuV)		Quasi-peak	Average	0.15-0.5	66 to 56*	56 to 46*	0.5-5	56	46	5-30	60	50
Frequency range (MHz)	Limit (dBuV)														
	Quasi-peak	Average													
0.15-0.5	66 to 56*	56 to 46*													
0.5-5	56	46													
5-30	60	50													
Test setup:	 <p><i>Remark</i> E.U.T: Equipment Under Test LISN: Line Impedance Stabilization Network Test table height=0.8m</p>														
Test procedure:	<ol style="list-style-type: none"> 1. The E.U.T and simulators are connected to the main power through a line impedance stabilization network (L.I.S.N.). This provides a 50ohm/50uH coupling impedance for the measuring equipment. 2. The peripheral devices are also connected to the main power through a LISN that provides a 50ohm/50uH coupling impedance with 50ohm termination. (Please refer to the block diagram of the test setup and photographs). 3. Both sides of A.C. line are checked for maximum conducted interference. In order to find the maximum emission, the relative positions of equipment and all of the interface cables must be changed according to ANSI C63.10:2013 on conducted measurement. 														
Test Instruments:	Refer to section 6.0 for details														
Test mode:	Refer to section 5.2 for details														
Test results:	Pass														

Measurement data:

Line:

EUT:	True Wireless Earbuds	Probe:	L1
Model:	BW-FYE5	Power Source:	AC120V/60Hz
Mode:	BT mode	Test by:	Eason
Temp./Hum.(%RH):	26°C/60%RH		

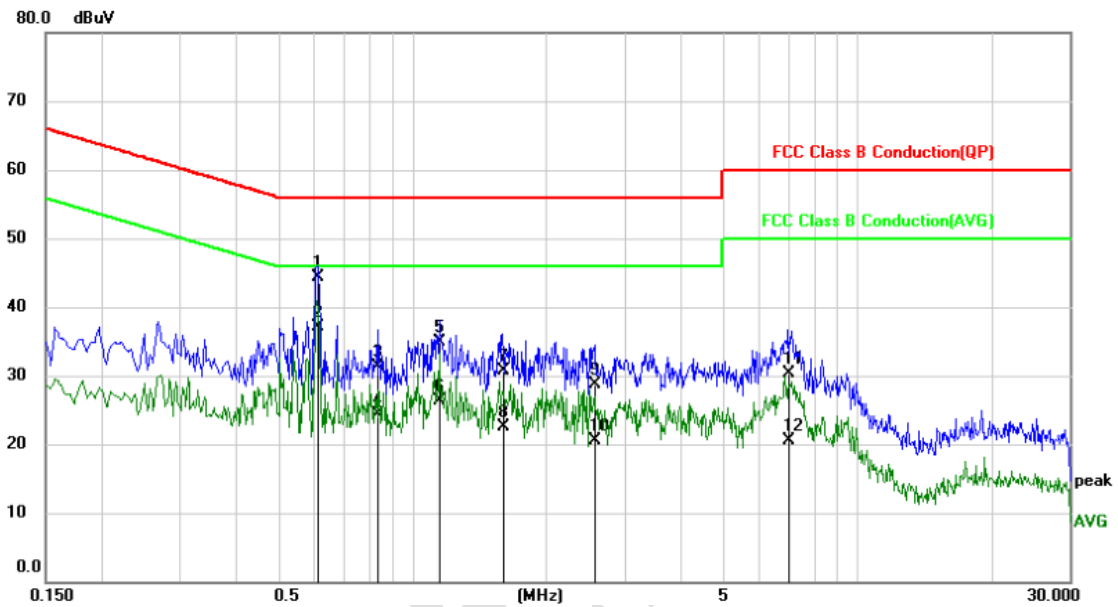

No.	Mk.	Freq. MHz	Reading Level dBuV	Correct Factor dB	Measure- ment dBuV	Limit dBuV	Over dB	Detector
1		0.6140	34.50	9.73	44.23	56.00	-11.77	QP
2	*	0.6140	27.34	9.73	37.07	46.00	-8.93	AVG
3		0.8380	21.49	9.74	31.23	56.00	-24.77	QP
4		0.8380	14.54	9.74	24.28	46.00	-21.72	AVG
5		1.1500	25.10	9.83	34.93	56.00	-21.07	QP
6		1.1500	16.39	9.83	26.22	46.00	-19.78	AVG
7		1.5980	20.79	9.84	30.63	56.00	-25.37	QP
8		1.5980	12.58	9.84	22.42	46.00	-23.58	AVG
9		2.5740	18.90	9.83	28.73	56.00	-27.27	QP
10		2.5740	10.63	9.83	20.46	46.00	-25.54	AVG
11		7.0020	20.38	9.86	30.24	60.00	-29.76	QP
12		7.0020	10.69	9.86	20.55	50.00	-29.45	AVG

Neutral:

EUT:	True Wireless Earbuds	Probe:	N
Model:	BW-FYE5	Power Source:	AC120V/60Hz
Mode:	BT mode	Test by:	Eason
Temp./Hum.(%RH):	26°C/60%RH		

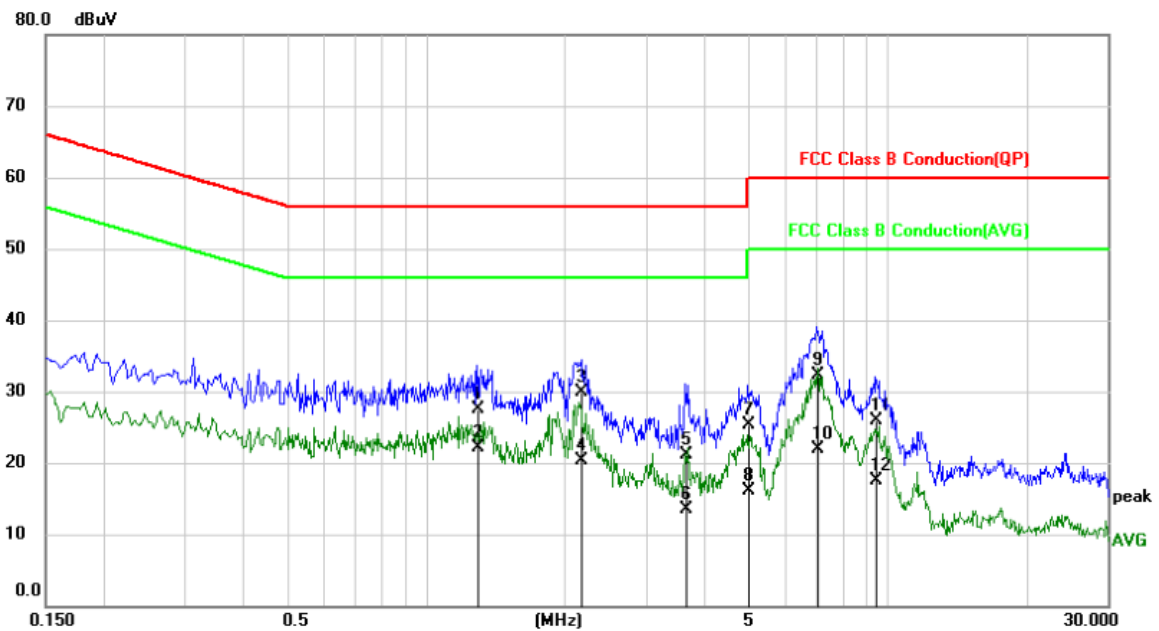

No.	Mk.	Freq. MHz	Reading Level dBuV	Correct Factor dB	Measure- ment dBuV	Limit dBuV	Over dB	Detector
1		1.2900	17.66	9.83	27.49	56.00	-28.51	QP
2	*	1.2900	12.36	9.83	22.19	46.00	-23.81	AVG
3		2.1700	20.01	9.86	29.87	56.00	-26.13	QP
4		2.1700	10.37	9.86	20.23	46.00	-25.77	AVG
5		3.6420	11.22	9.85	21.07	56.00	-34.93	QP
6		3.6420	3.68	9.85	13.53	46.00	-32.47	AVG
7		5.0020	15.31	9.91	25.22	60.00	-34.78	QP
8		5.0020	6.18	9.91	16.09	50.00	-33.91	AVG
9		7.0340	22.53	9.84	32.37	60.00	-27.63	QP
10		7.0340	12.01	9.84	21.85	50.00	-28.15	AVG
11		9.4100	15.88	9.95	25.83	60.00	-34.17	QP
12		9.4100	7.49	9.95	17.44	50.00	-32.56	AVG

Notes:

1. An initial pre-scan was performed on the line and neutral lines with peak detector.
2. Quasi-Peak and Average measurement were performed at the frequencies with maximized peak emission.
3. Final Level = Receiver Read level + Correct Factor
4. Correct Factor = LISN Factor + Cable Loss

7.3 Conducted Peak Output Power

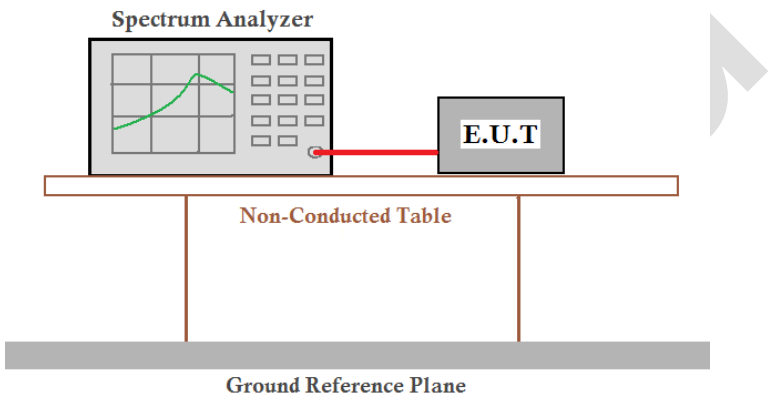
Test Requirement:	FCC Part15 C Section 15.247 (b)(3)
Test Method:	ANSI C63.10:2013
Limit:	30dBm(for GFSK),21dBm(for EDR)
Test setup:	
Test Instruments:	Refer to section 6.0 for details
Test mode:	Refer to section 5.2 for details
Test results:	Pass

Measurement Data

Mode	Test channel	Peak Output Power (dBm)	Limit (dBm)	Result
GFSK	Lowest	5.90	30.00	Pass
	Middle	6.12		
	Highest	6.54		
Pi/4QPSK	Lowest	5.75	21.00	Pass
	Middle	6.03		
	Highest	6.61		
8-DPSK	Lowest	5.97	21.00	Pass
	Middle	6.30		
	Highest	6.82		

Test plot as follows:

Test mode:	GFSK mode
------------	-----------

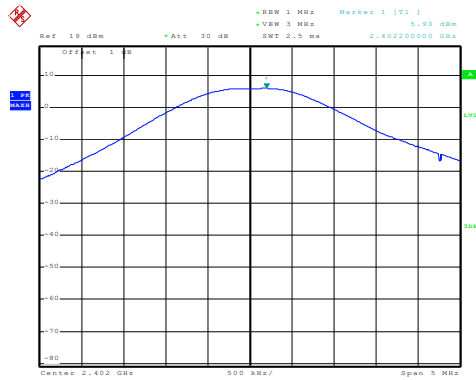

Date: 31.JUL.2019 18:23:30

Lowest channel

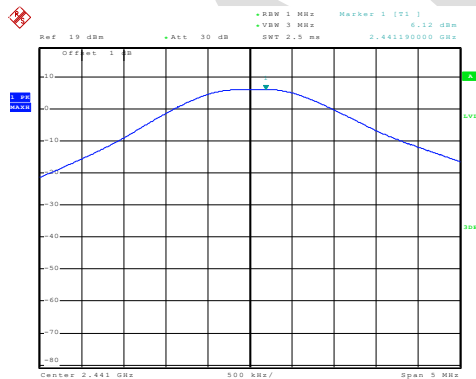

Date: 31.JUL.2019 18:24:17

Middle channel

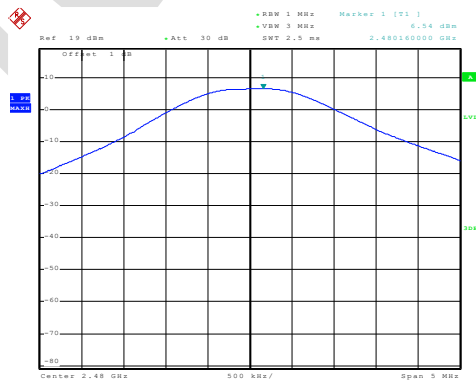

Date: 31.JUL.2019 18:25:02

Highest channel

Test mode: Pi/4QPSK mode

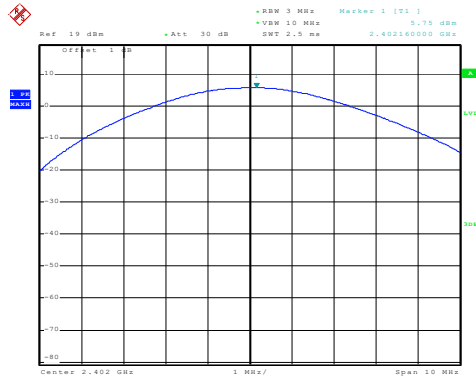

Date: 31.JUL.2019 18:18:35

Lowest channel

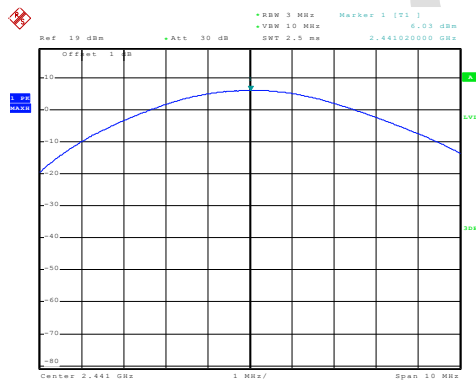

Date: 31.JUL.2019 18:19:34

Middle channel

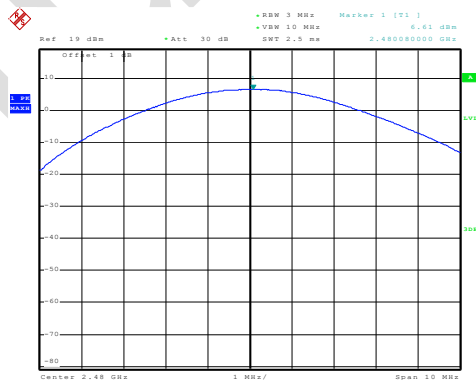

Date: 31.JUL.2019 18:20:17

Highest channel

Test mode: 8-DPSK mode

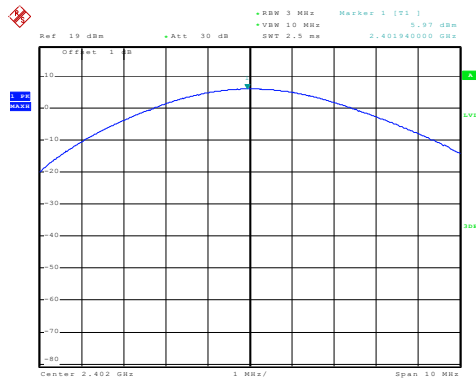

Date: 31.JUL.2019 18:22:37

Lowest channel

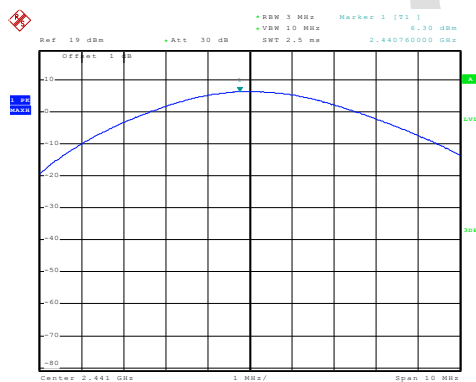

Date: 31.JUL.2019 18:21:53

Middle channel

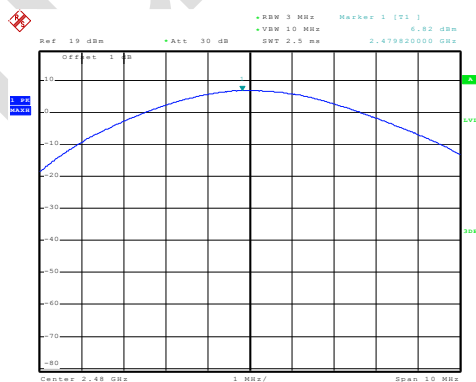

Date: 31.JUL.2019 18:21:18

Highest channel

7.4 20dB Emission Bandwidth

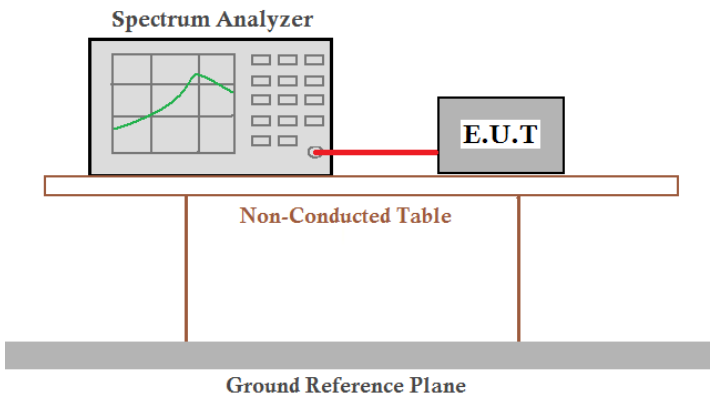
Test Requirement:	FCC Part15 C Section 15.247 (a)(2)
Test Method:	ANSI C63.10:2013
Limit:	N/A
Test setup:	
Test Instruments:	Refer to section 6.0 for details
Test mode:	Refer to section 5.2 for details
Test results:	Pass

Measurement Data

Mode	Test channel	20dB Emission Bandwidth (MHz)	Result
GFSK	Lowest	0.840	Pass
	Middle	0.844	
	Highest	0.848	
Pi/4QPSK	Lowest	1.248	Pass
	Middle	1.254	
	Highest	1.254	
8-DPSK	Lowest	1.224	Pass
	Middle	1.224	
	Highest	1.224	

Test plot as follows:

Test mode:	GFSK mode
------------	-----------

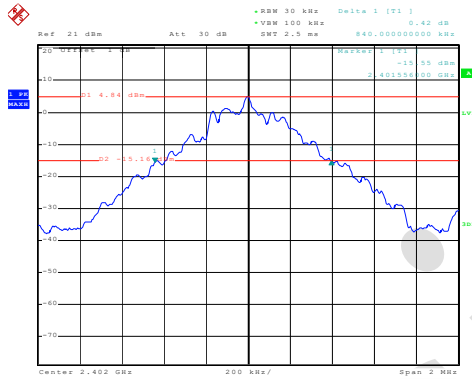

Lowest channel

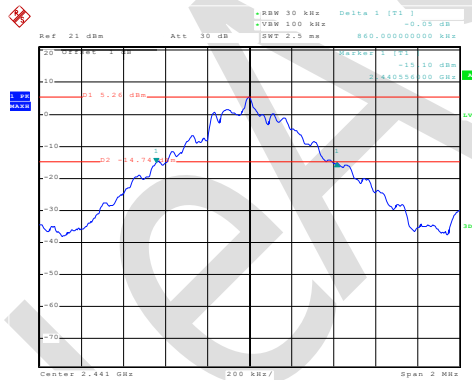

Middle channel

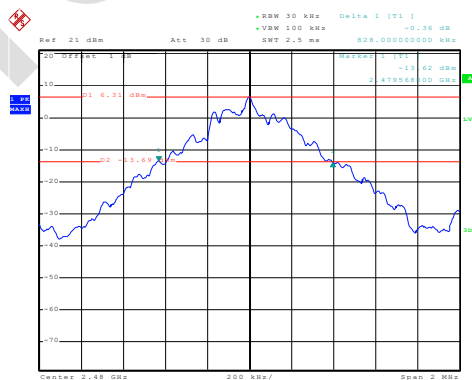

Highest channel

Test mode: Pi/4QPSK mode

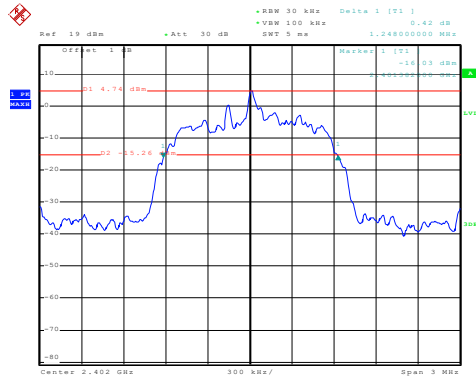

Date: 31.JUL.2019 17:55:32

Lowest channel

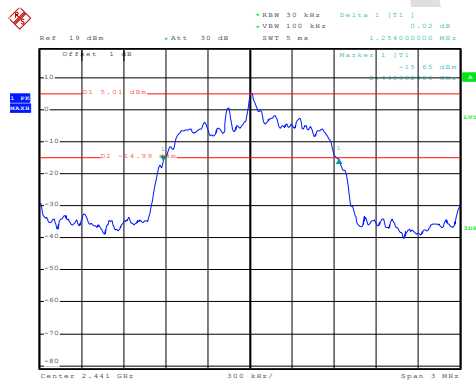

Date: 31.JUL.2019 17:58:58

Middle channel

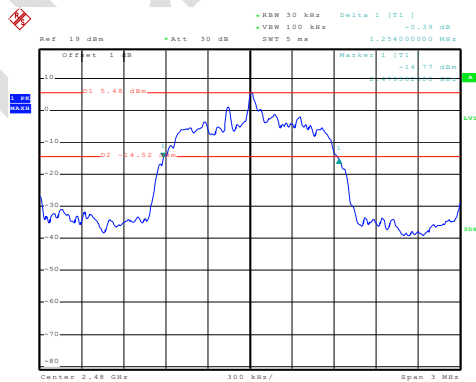

Date: 31.JUL.2019 18:02:17

Highest channel

Test mode: 8-DPSK mode

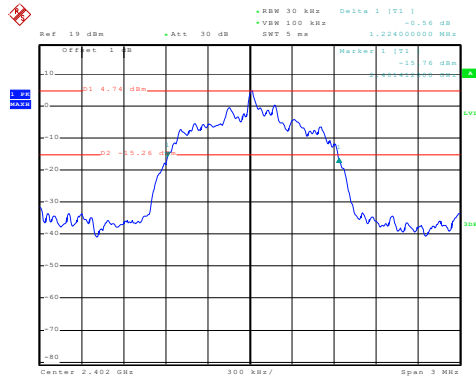

Date: 31.JUL.2019 18:10:27

Lowest channel

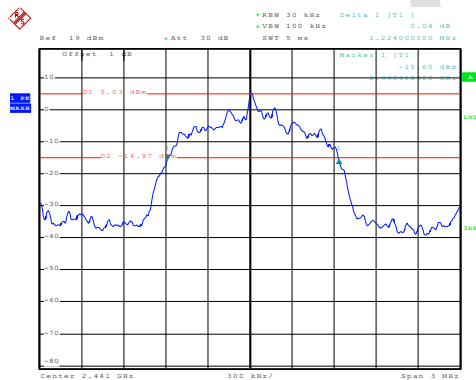

Date: 31.JUL.2019 18:08:37

Middle channel

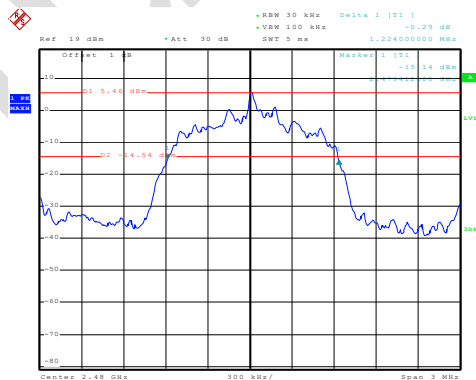

Date: 31.JUL.2019 18:07:46

Highest channel

7.5 Carrier Frequencies Separation

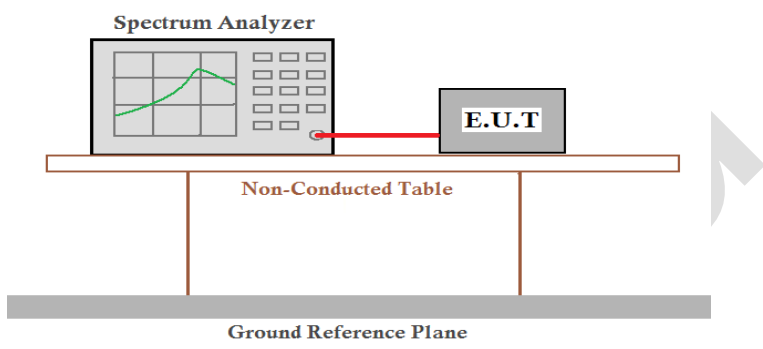
Test Requirement:	FCC Part15 C Section 15.247 (a)(1)
Test Method:	ANSI C63.10:2013
Receiver setup:	RBW=100KHz, VBW=300KHz, detector=Peak
Limit:	GFSK: 20dB bandwidth Pi/4QPSK & 8-DPSK: 0.025MHz or 2/3 of the 20dB bandwidth (whichever is greater)
Test setup:	
Test Instruments:	Refer to section 6.0 for details
Test mode:	Refer to section 5.2 for details
Test results:	Pass

Measurement Data

Mode	Test channel	Carrier Frequencies Separation (kHz)	Limit (kHz)	Result
GFSK	Lowest	1000	565.33	Pass
	Middle	1000	565.33	Pass
	Highest	1004	565.33	Pass
Pi/4QPSK	Lowest	1000	836.00	Pass
	Middle	1000	836.00	Pass
	Highest	1004	836.00	Pass
8-DPSK	Lowest	1004	816.00	Pass
	Middle	1004	816.00	Pass
	Highest	1008	816.00	Pass

Note: According to section 7.4

Mode	20dB bandwidth (kHz) (worse case)	Limit (kHz) (Carrier Frequencies Separation)
GFSK	848	565.33
Pi/4QPSK	1254	836.00
8-DPSK	1224	816.00

Test plot as follows:

Modulation mode:	GFSK
------------------	------

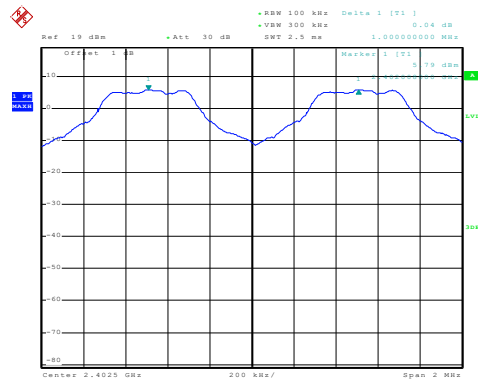

Date: 31.JUL.2019 19:21:58

Lowest channel

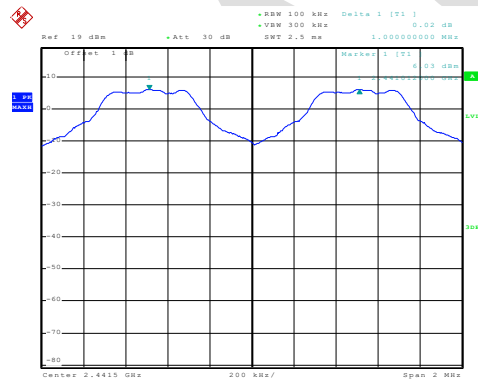

Date: 31.JUL.2019 19:23:11

Middle channel

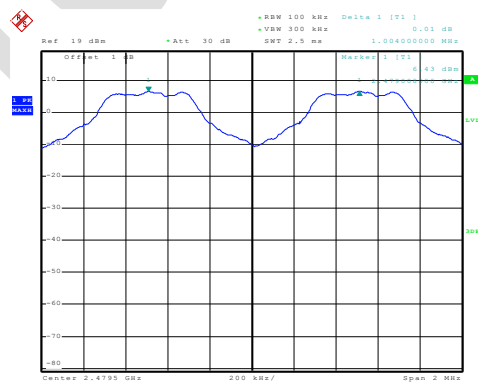

Date: 31.JUL.2019 19:24:21

Highest channel

Test mode: Pi/4QPSK mode

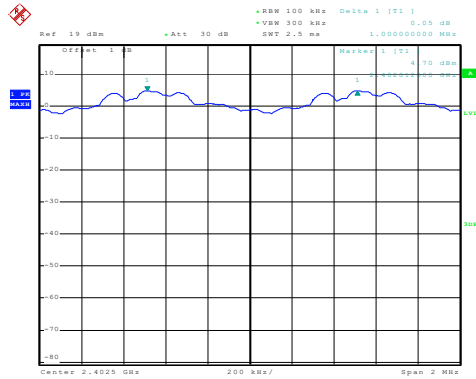

Date: 31.JUL.2019 19:11:13

Lowest channel

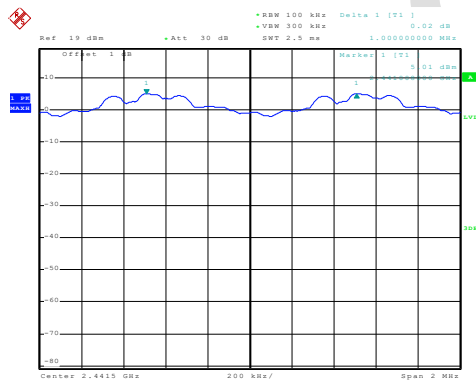

Date: 31.JUL.2019 19:13:00

Middle channel

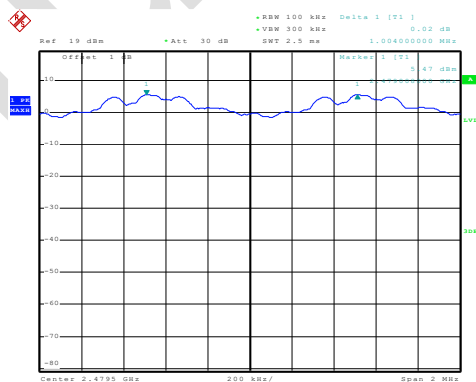

Date: 31.JUL.2019 19:14:47

Highest channel

Test mode:	8-DPSK mode
------------	-------------

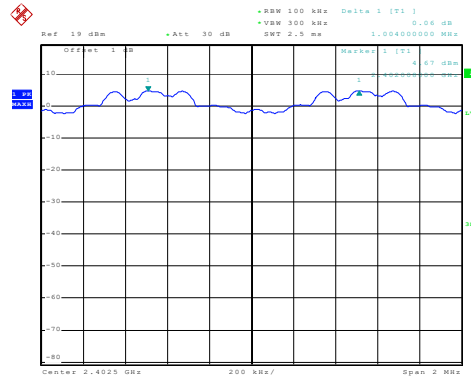

Date: 31.JUL.2019 19:17:24

Lowest channel

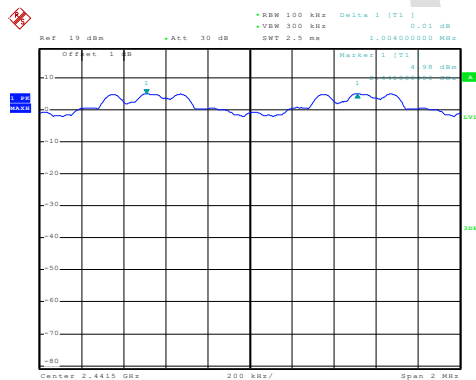

Date: 31.JUL.2019 19:18:59

Middle channel

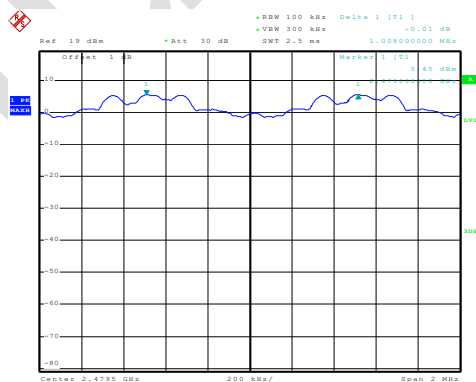

Date: 31.JUL.2019 19:20:33

Highest channel

7.6 Hopping Channel Number

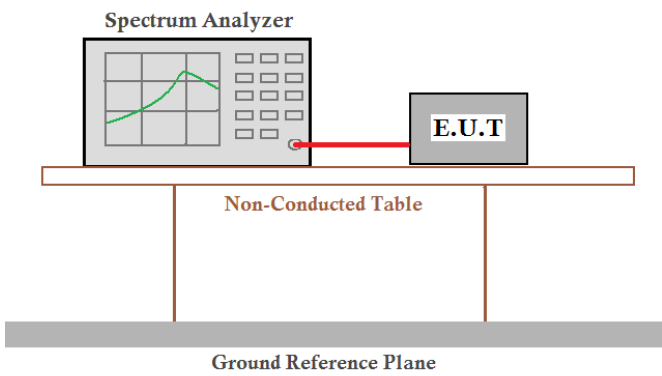
Test Requirement:	FCC Part15 C Section 15.247 (a)(1)
Test Method:	ANSI C63.10:2013
Receiver setup:	RBW=100kHz, VBW=300kHz, Frequency range=2400MHz-2483.5MHz, Detector=Peak
Limit:	15 channels
Test setup:	
Test Instruments:	Refer to section 6.0 for details
Test mode:	Refer to section 5.2 for details
Test results:	Pass

Measurement Data:

Mode	Hopping channel numbers	Limit	Result
GFSK	79	15	Pass
Pi/4QPSK	79	15	Pass
8-DPSK	79	15	Pass

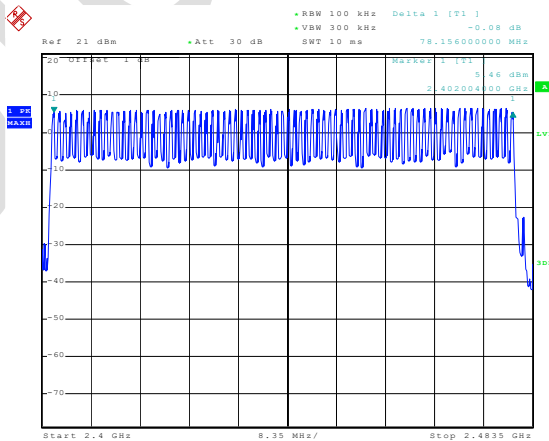

Date: 31.JUL.2019 19:36:34

7.7 Dwell Time

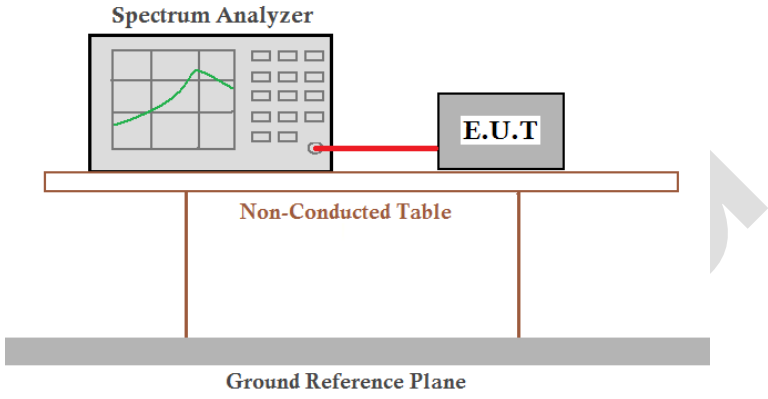
Test Requirement:	FCC Part15 C Section 15.247 (a)(1)
Test Method:	ANSI C63.10:2013
Receiver setup:	RBW=1MHz, VBW=1MHz, Span=0Hz, Detector=Peak
Limit:	0.4 Second
Test setup:	
Test Instruments:	Refer to section 6.0 for details
Test mode:	Refer to section 5.2 for details
Test results:	Pass

Measurement Data

Frequency	Packet	Dwell time(ms)	Limit(ms)	Result
2441MHz	DH1/2-DH1/3-DH1	142.08	400	Pass
2441MHz	DH3/2-DH3/3-DH3	283.52	400	Pass
2441MHz	DH5/2-DH5/3-DH5	318.29	400	Pass

The test period: $T = 0.4 \text{ Second/Channel} \times 79 \text{ Channel} = 31.6 \text{ s}$

Test channel: 2441MHz as blow

DH1/2-DH1/3-DH1 time slot = $0.444(\text{ms}) \times (1600 / (2 \times 79)) \times 31.6 = 142.08\text{ms}$

DH3/2-DH3/3-DH3 time slot = $1.722(\text{ms}) \times (1600 / (4 \times 79)) \times 31.6 = 283.52\text{ms}$

DH5/2-DH5/3-DH5 time slot = $2.984(\text{ms}) \times (1600 / (6 \times 79)) \times 31.6 = 318.29\text{ms}$

Test plot as follows:

Test channel: 2441MHz

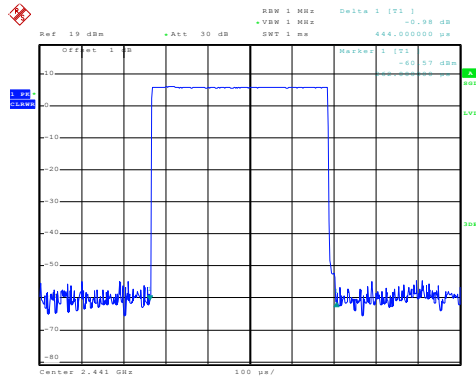

Date: 31.JUL.2019 19:30:04

DH1/2-DH1/3-DH1

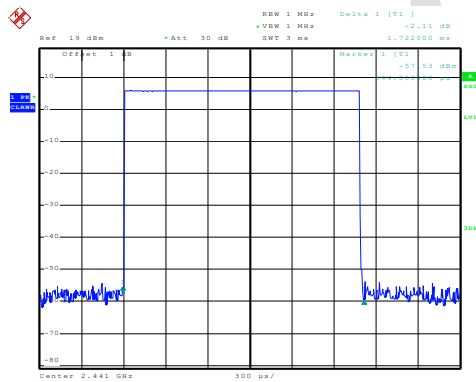

Date: 31.JUL.2019 19:31:39

DH3/2-DH3/3-DH3

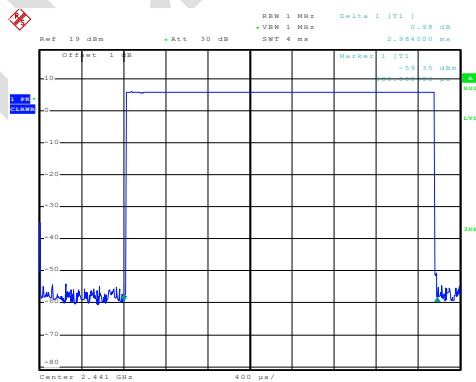

Date: 31.JUL.2019 19:32:56

DH5/2-DH5/3-DH5

7.8 Pseudorandom Frequency Hopping Sequence

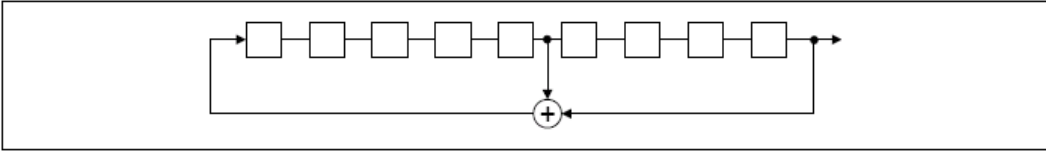
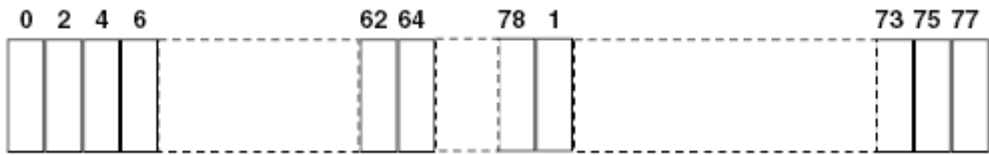
Test Requirement:	FCC Part15 C Section 15.247 (a)(1) requirement:
<p>Frequency hopping systems shall have hopping channel carrier frequencies separated by a minimum of 25 kHz or the 20 dB bandwidth of the hopping channel, whichever is greater.</p> <p>Alternatively. Frequency hopping systems operating in the 2400-2483.5 MHz band may have hopping channel carrier frequencies that are separated by 25 kHz or two-thirds of the 20 dB bandwidth of the hopping channel, whichever is greater, provided the systems operate with an output power no greater than 125 mW. The system shall hop to channel frequencies that are selected at the system hopping rate from a Pseudorandom ordered list of hopping frequencies. Each frequency must be used equally on the average by each transmitter. The system receivers shall have input bandwidths that match the hopping channel bandwidths of their corresponding transmitters and shall shift frequencies in synchronization with the transmitted signals.</p>	
EUT Pseudorandom Frequency Hopping Sequence	
<p>The pseudorandom sequence may be generated in a nine-stage shift register whose 5th and 9th stage outputs are added in a modulo-two addition stage. And the result is fed back to the input of the first stage. The sequence begins with the first ONE of 9 consecutive ONES; i.e. the shift register is initialized with nine ones.</p> <ul style="list-style-type: none"> • Number of shift register stages: 9 • Length of pseudo-random sequence: $2^9 - 1 = 511$ bits • Longest sequence of zeros: 8 (non-inverted signal) <div data-bbox="245 1016 1295 1167" style="text-align: center;">  </div> <p style="text-align: center;"><i>Linear Feedback Shift Register for Generation of the PRBS sequence</i></p> <p>An example of Pseudorandom Frequency Hopping Sequence as follow:</p> <div data-bbox="245 1263 1238 1417" style="text-align: center;">  </div> <p>Each frequency used equally on the average by each transmitter. The system receivers have input bandwidths that match the hopping channel bandwidths of their corresponding transmitters and shift frequencies in synchronization with the transmitted signals.</p>	

7.9 Band Edge

7.9.1 Conducted Emission Method

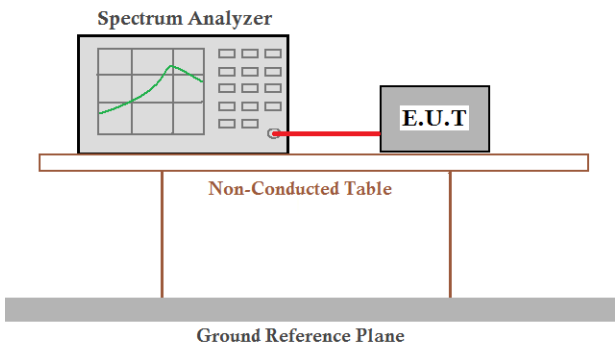
Test Requirement:	FCC Part15 C Section 15.247 (d)
Test Method:	ANSI C63.10:2013
Receiver setup:	RBW=100kHz, VBW=300kHz, Detector=Peak
Limit:	In any 100 kHz bandwidth outside the frequency band in which the spread spectrum intentional radiator is operating, the radio frequency power that is produced by the intentional radiator shall be at least 20 dB below that in the 100 kHz bandwidth within the band that contains the highest level of the desired power, based on either an RF conducted or a radiated measurement.
Test setup:	 <p>The diagram illustrates the test setup. A Spectrum Analyzer is connected to an E.U.T. (Equipment Under Test) via a red cable. Both are placed on a Non-Conducted Table, which is supported by a Ground Reference Plane.</p>
Test Instruments:	Refer to section 6.0 for details
Test mode:	Refer to section 5.2 for details
Test results:	Pass

Test plot as follows:

GFSK Mode:

Test channel:	Lowest channel
---------------	----------------

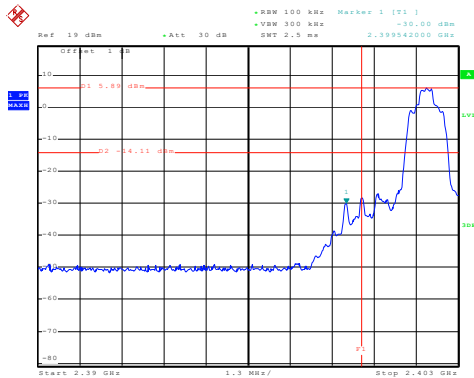

Data: 21.JUL.2019 18:42:39

No-hopping mode

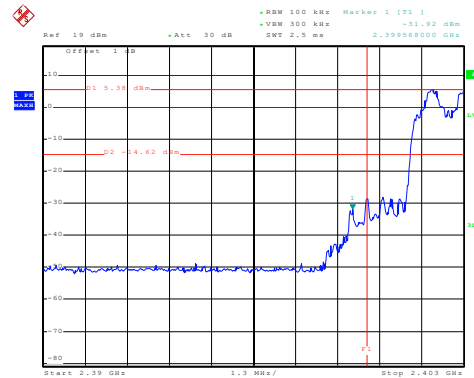

Data: 21.JUL.2019 19:07:22

Hopping mode

Test channel:	Highest channel
---------------	-----------------

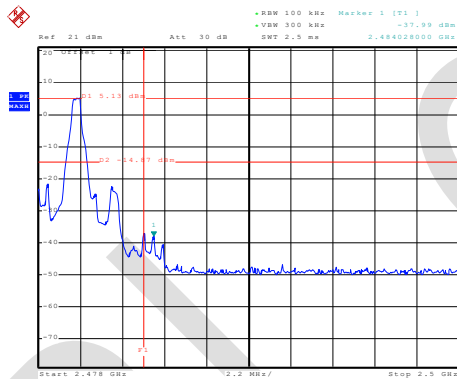

No-hopping mode

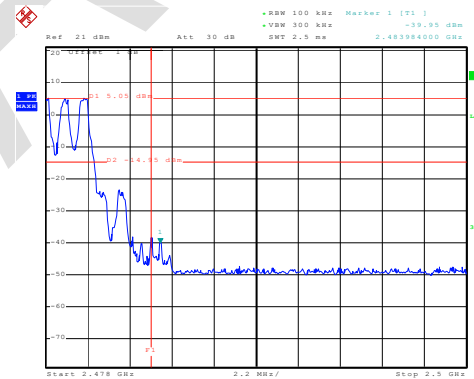

Hopping mode