

Libre Home

Dimmer&Relay Control User's Manual

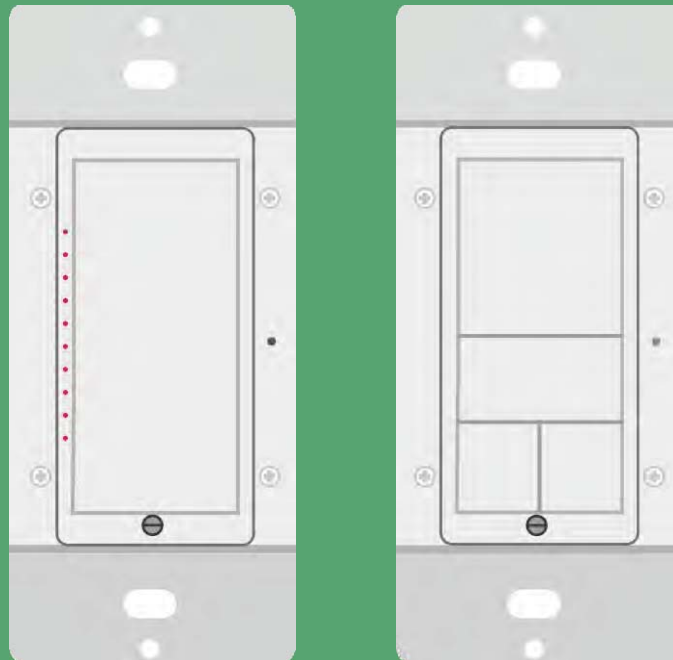

Contents

Cautions and Warnings

Knowing Dimmer

Knowing Relay Control

Getting Started

 Installation Steps

 Installation

Installation Wiring Diagrams

Joining Network

Troubleshooting

Cautions and Warnings

Read and understand these instructions before installing and retain them for future reference.

This product is intended for installation in accordance with the National Electric Code and local regulations in the United States or the Canadian Electrical Code and local regulations in Canada. Use indoors only. This product is not designed or approved for use on power lines other than 120V 60Hz, single phase. Attempting to use this product on non-approved power lines may have hazardous consequences.

Recommended installation practices:

- Use only indoors in dry location.
- Be sure that you have turned off the circuit breaker or removed the fuse for the circuit you are installing this product into. Installing this product with the power on will expose you to dangerous voltages.
- Connect using only copper or copper-clad wire.
- This product may feel warm during operation. The amount of heat generated is within approved limits and poses no hazards. To minimize heat buildup, ensure the area surrounding the rear of this product is as clear of clutter as possible.
- To reduce the risk of overheating and possible damage to other equipment, do not use this product to control loads in excess of the specified maximum(s) or, install in locations with electricity specifications which are outside of the product's specifications.

Identifying the Electrical Wires in Your Home:

- line – carries 120VAC electricity into the wall box, may also be called hot, live or power, commonly black
- neutral – returns 120VAC to power company, commonly white and in a multi-wire bundle
- load – connects to light/load device, commonly black and in a separate cable jacket
- ground – connection to electrical ground, commonly a bare wire, a green wire or a screw on a metal box

IMPORTANT:

If you have any difficulties or questions, consult an electrician. If you are not knowledgeable about and comfortable with electrical circuitry, have a qualified electrician install the product for you.

WARNING:

Changes or modifications to this device not expressly approved by the party responsible for compliance could void the user's authority to operate the equipment.

Caution:

-To Reduce the Risk of Overheating And Possible Damage to Other Equipment, Do Not Install To Control A Receptacle, A Motor-Operated Appliance, A Fluorescent Lighting Fixture, Or A Transformer-Supplied Appliance;

-Install only in a suitable UL Listed outlet box

- Risk of Electric Shock - More than one disconnect switch may be required to de-energize the equipment before servicing".

FCC STATEMENT

1. This device complies with Part 15 of the FCC Rules. Operation is subject to the following two conditions:

(1) This device may not cause harmful interference, and (2) This device must accept any interference received, including interference that may cause undesired operation.

2. Changes or modifications not expressly approved by the party responsible for compliance could void the user's authority to operate the equipment.

This equipment has been tested and found to comply with the limits for a Class B digital device, pursuant to part 15 of the FCC Rules. These limits are designed to provide reasonable protection against harmful interference in a residential installation. This equipment generates uses and can radiate radio frequency energy and, if not installed and used in accordance with the instructions, may cause harmful interference to radio communications. However, there is no guarantee that interference will not occur in a particular installation. If this equipment does cause harmful interference to radio or television reception, which can be determined by turning the equipment off and on, the user is encouraged to try to correct the interference by one or more of the following measures:

—Reorient or relocate the receiving antenna.

—Increase the separation between the equipment and receiver.

—Connect the equipment into an outlet on a circuit different from that to which the receiver is connected.

—Consult the dealer or an experienced radio/ TV technician for help.

FCC Radiation Exposure Statement:

This equipment complies with FCC radiation exposure limits set forth for an uncontrolled environment. In order to avoid the possibility of exceeding the FCC radio frequency exposure limits, Human proximity to the antenna shall not be less than 20cm (8 inches) during normal operation.

Knowing Dimmer

Dimmer with single key

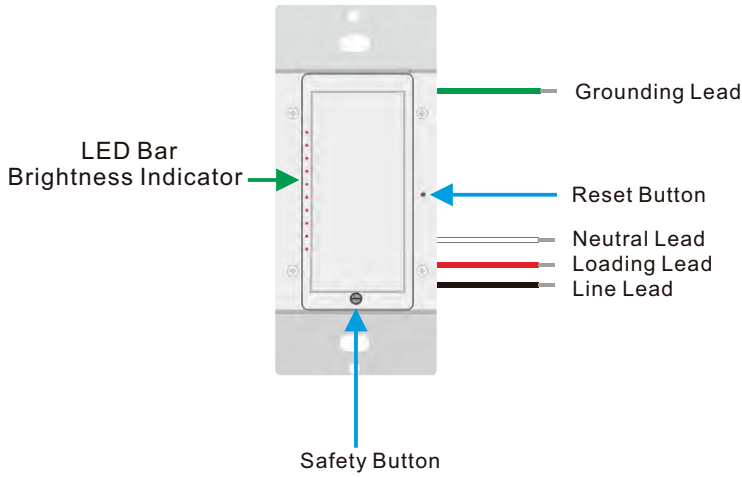

Dimmer with replaceable keys

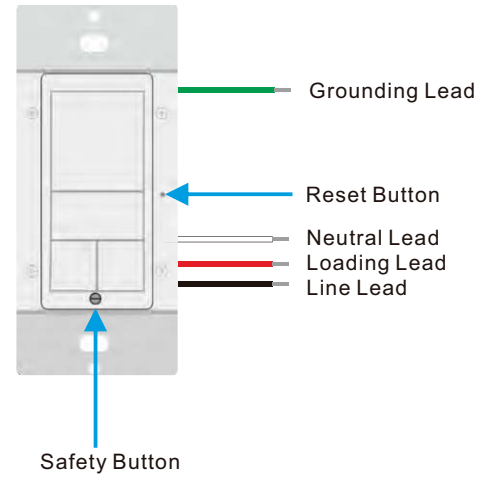

Back View

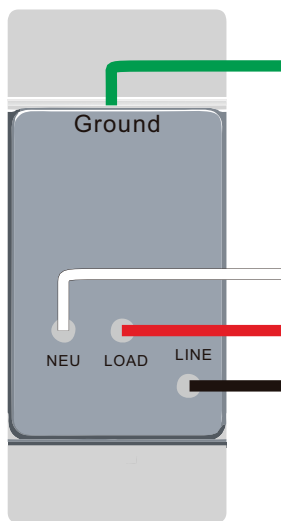

Knowing Safety button of Dimmer

Anytime you need Dimmer's controlled circuit to be unpowered but don't want to turn off the circuit breaker—such as when replacing light bulbs—use the Safety button to quickly and conveniently disable power.

Using your fingernail or a small flathead screwdriver, pull out Safety button. This opens the mechanical contacts and removes all power from Dimmer and its load. (Because Dimmer's settings are stored in its non-volatile memory, your setup information will not be lost.) To re-enable power to Dimmer, simply push in the Safety button until it is flush with the trim frame.

Knowing Relay Control

Relay Control with single key

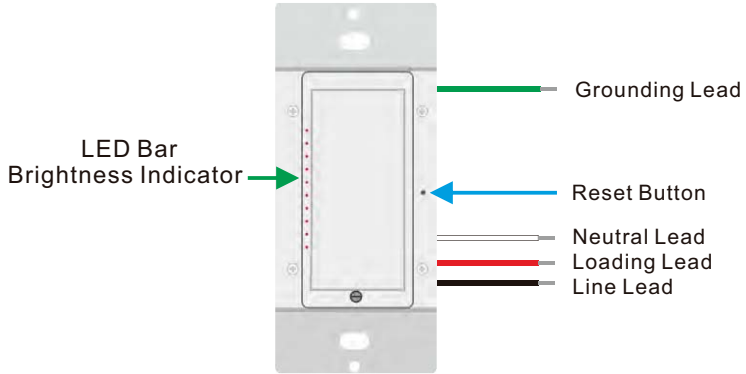

Relay Control with replaceable keys

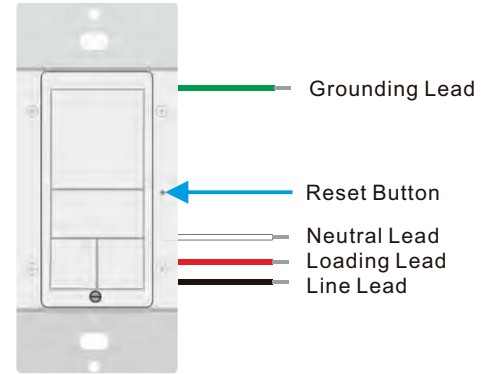

Back View

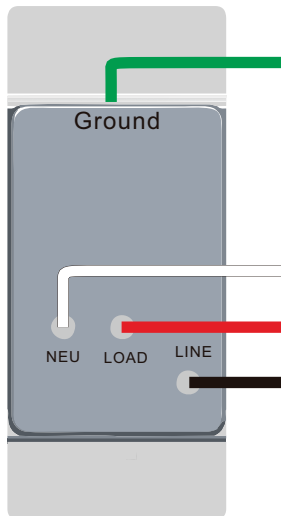

Safety button of relay control has no function, It's not required for relay control Since the built-in relay is worked as air gap switch. for safety protection.

Installation Steps

- Read Instruction
- Get Installation tools
- Unbox and Disconnect power
- Remove the old dimmer or relay control
- Reconnect Power
- Identify Line and Load wire
- Disconnect Power
- Connect the dimmer or relay control wires to the Junction box wires
- Install the Dimmer or Relay Control into the junction box
- Reconnect Power
- Test the Dimmer or Relay Control by tapping the paddle to turn on and off
- Install wire plate

Installation

Read Instruction Before installation

Get installation Tools:



Philips Screwdriver



Flathead Screwdriver



Voltage Detector



Wire Cutter/Stripper

1

Disconnect Power

Turn off power to your dimmer or switch at the electrical service panel

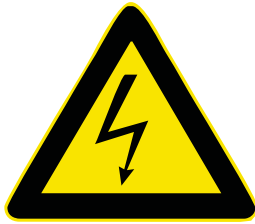

Always disconnect power before installation.

2

Remove the old Dimmer or Switch

Remove the old dimmer and disconnect the wires. If your box lacks neutral wires, stop and contact support.

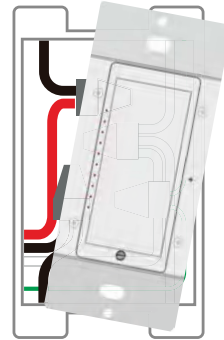

3

Reconnect Power

Turn on power at the circuit breaker.

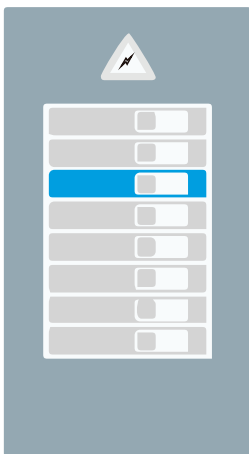

Circuit Breaker

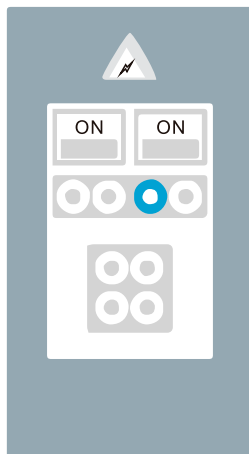

Fuse Panel

4

Identify Line and Load

Use a voltage detector or multi-meter to identify line and load. Line will be energized.

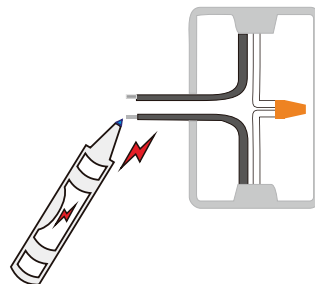

Installation

Wire-In the Dimmer or Relay Control

5

Turn off power at the circuit breaker. Connect the dimmer or relay control wires to the identified wires in the junction box. Verify that the wire nuts are secure and that no exposed copper wire is visible except for the bare ground wire. Additional wiring diagrams can be found in the Installation Diagrams section.

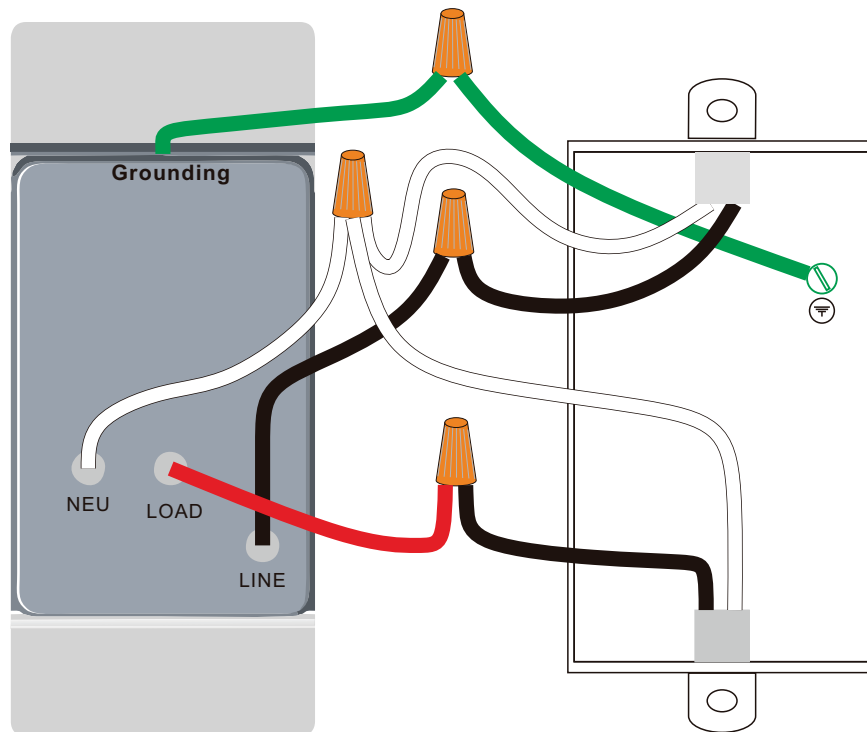

6

Install Dimmer or Relay Control

Mount the Dimmer or Relay Control into the junction box with the LED bar on the left



7

Reconnect Power

Turn power on to the Dimmer or Relay Control at the circuit breaker panel.

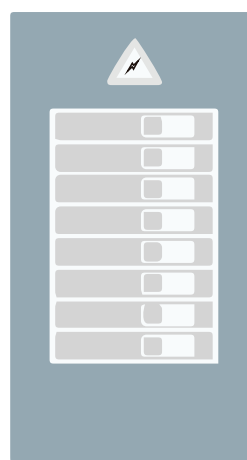

Circuit Breaker

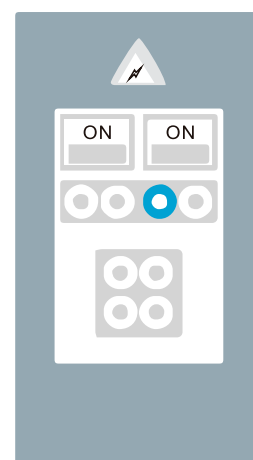

Fuse Panel

Installation

Test the Dimmer or Relay Control

8

Test your dimmer or relay control by tapping the paddle to turn On and Of. For dimmer, Press and hold to dim or brighten.

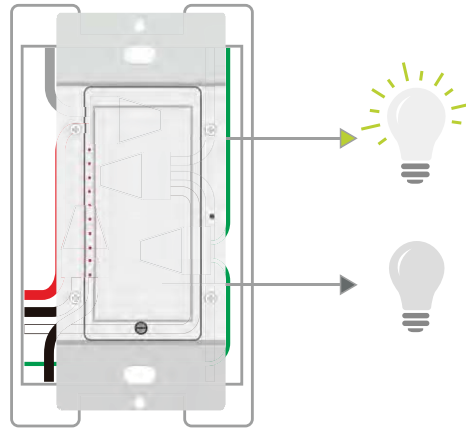

Install wall plate

9

Complete installation by reattaching your wall plate. For the best look, use an screwless wall plate

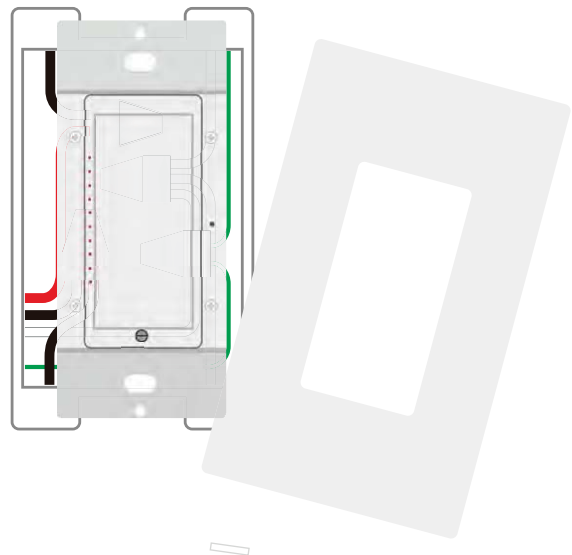

Complete installation

Installation Wiring Diagrams

Use the installation diagrams in this section to help you wire your Dimmer and Relay Control

2-Way wiring diagram

Note: The wire colors indicated are the regular colors, may different in some homes.

Connection instructions:

Insulation strip length: 12mm

Splicing wire connector: For 16AWG wires, Max twisting numbers: 3

The dimmer is rated for use with Copper wire only

For supply connection, use wires rated at least 75°C

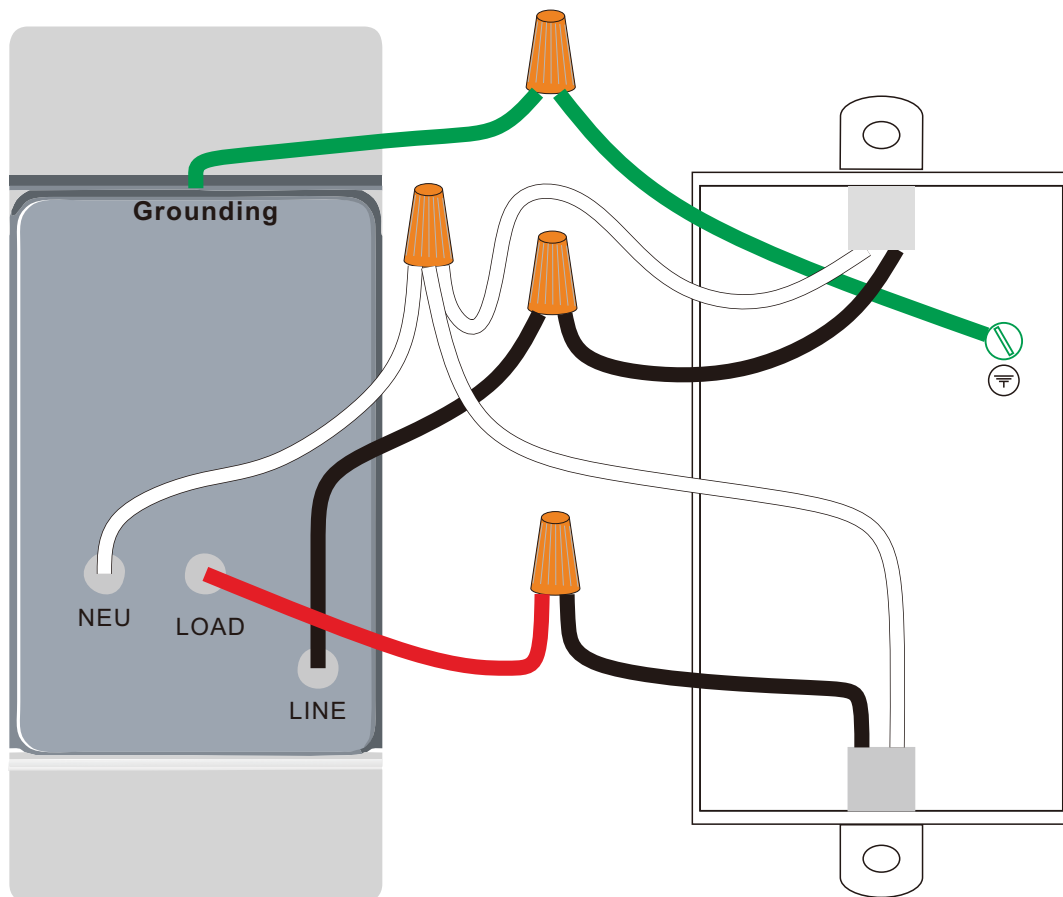

Using Dimmer or Relay Control in Virtual Multi-Way Circuits

You can use Dimmer or Relay Control to replace switches in multi-way circuits that are already wired in or to create multi-way circuits where there is no existing wiring. These are called virtual multi-way circuits. In a virtual multi-way circuit, only one Dimmer or Relay Control is actually connected to and controls the load. Any additional Dimmer or Relay Control modules (called Dimmer or Relay Control Secondaries) are only connected to the powerline via the line and neutral wires. All Dimmer or Relay Control can communicate with one another using Libre Home networking on the powerline. After wiring in Dimmer or Relay Control, you can create a virtual multi-way circuit by setting up all of the modules to control each other. The diagram below shows how you convert a wired-in 3-way circuit using two Dimmer or Relay Control.

3-Way Wiring Diagram

Note: The wire colors indicated are the regular colors, may differ in some homes.

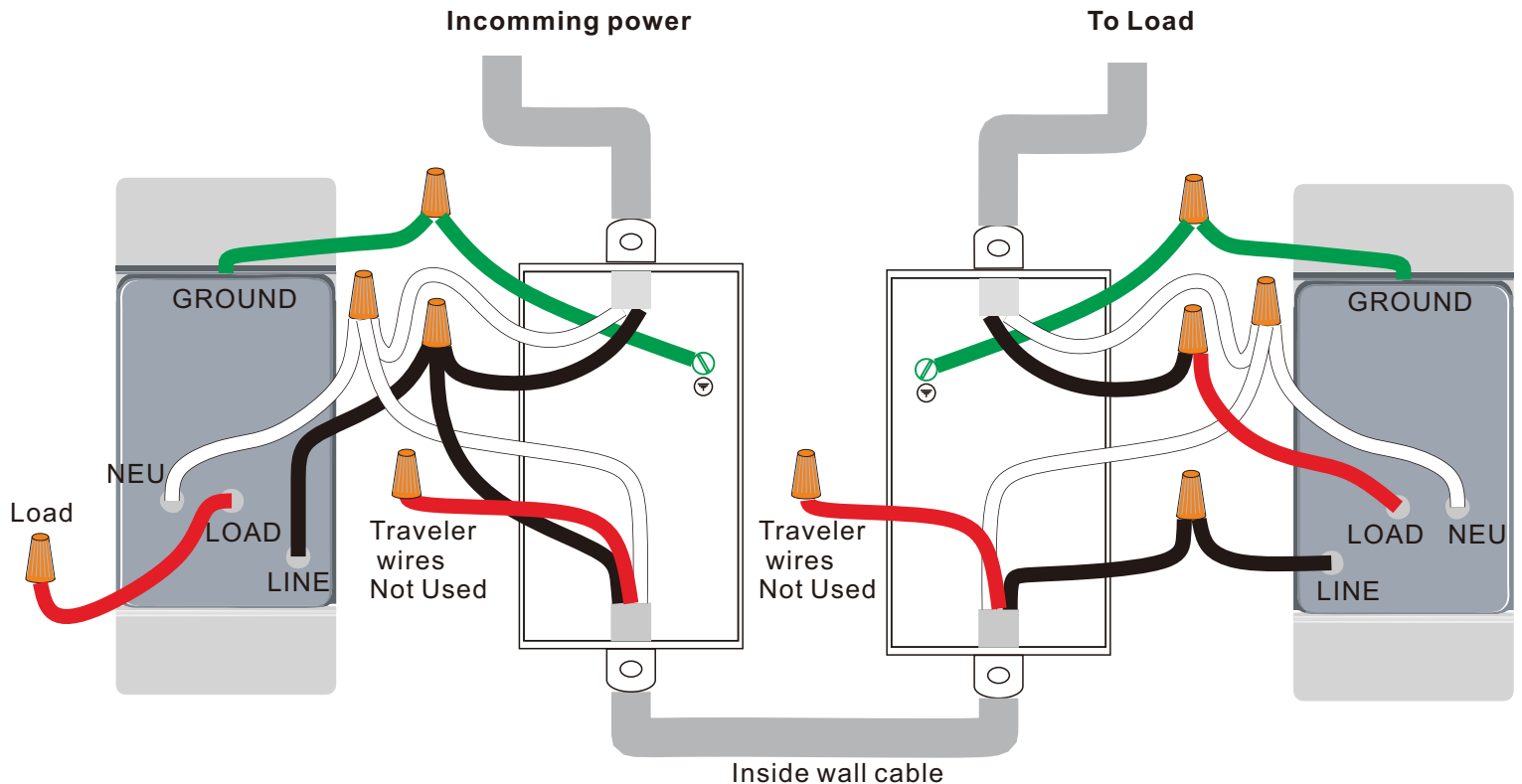

Special Treatment for 4- or More-Way Circuits

If your lighting circuit includes more than two Dimmer or Relay Controls controlling a single set of lights, those extra Dimmer or Relay Controls will have four wires connected to them. Two of the wires are travelers from the preceding Dimmer or Relay Controls, while the other two are travelers to the next Dimmer or Relay Controls in the chain. You will convert the black traveler wires to line wires and replace the old 4-wire Dimmer or Relay Controls.

See next page for 4-Way Wiring Diagram

4-Way Wiring Diagram

Note: The wire colors indicated are the regular colors, may differ in some homes.

Incomming power

To Load

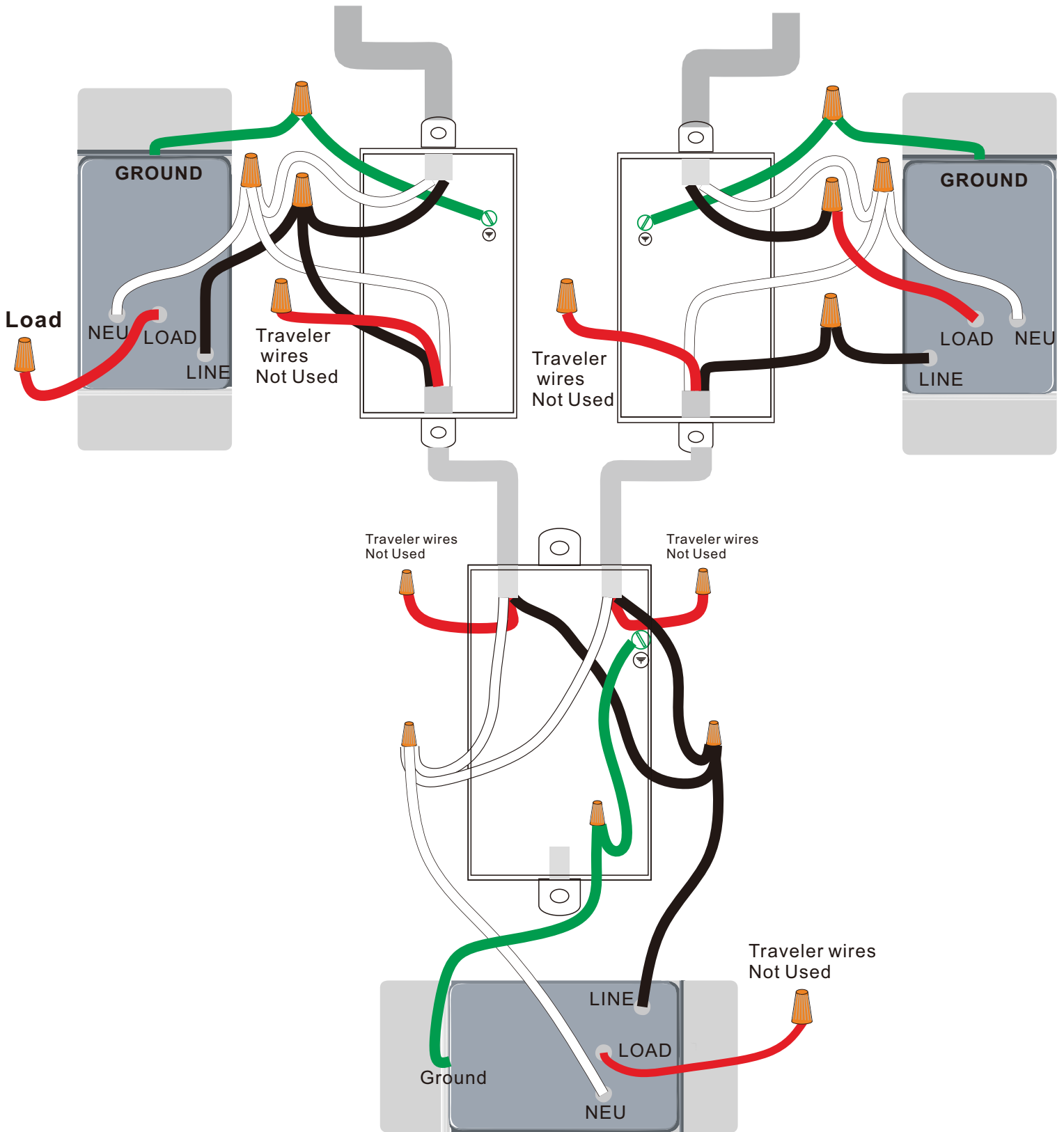

Joining Network

In Libre Home mobile App.

Navigate to Hub Configuration screen.

Press "Add New Device"

Then follow the instruction on screen.

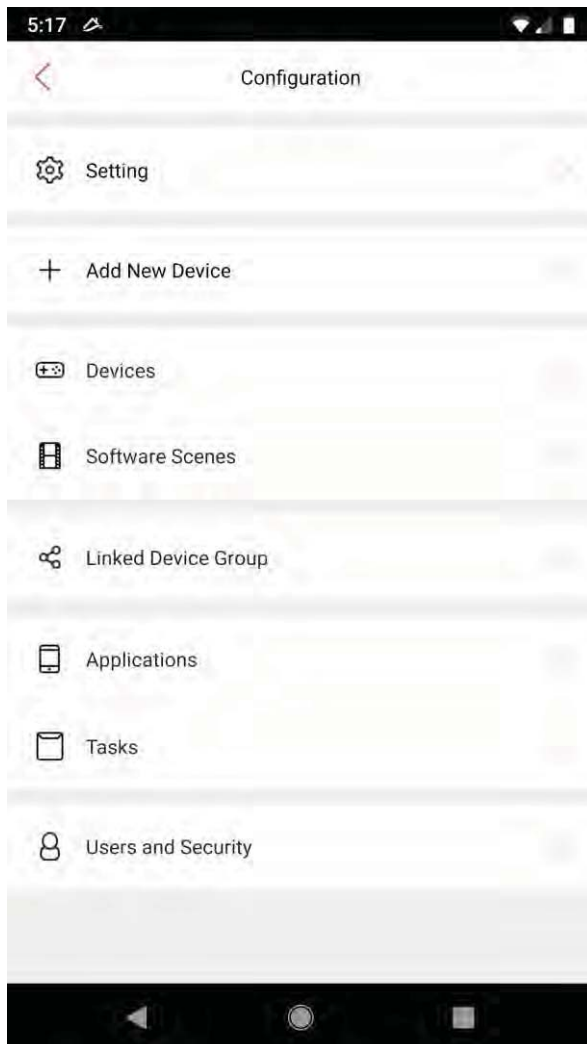

Trouble Shooting

In Libre Home mobile App.

Press "Devices"

Locate the dimmer or relay control that needs troubleshooting

Click "Troubleshooting"

