

**Product Name** : 50 ULTRA HD SMART TV

### APPENDIX B: PHOTOGRAPHS OF EUT

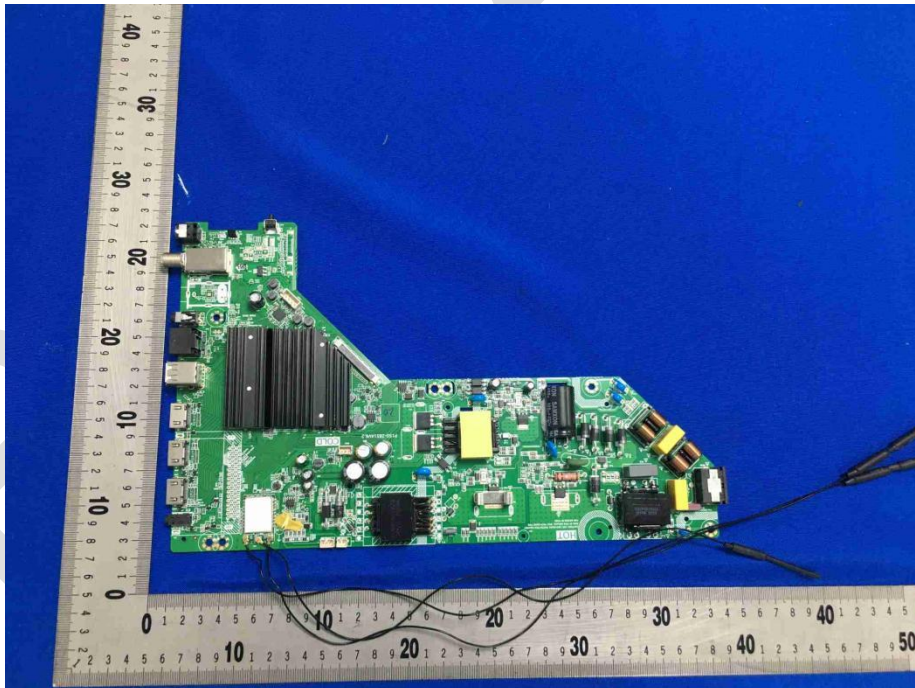

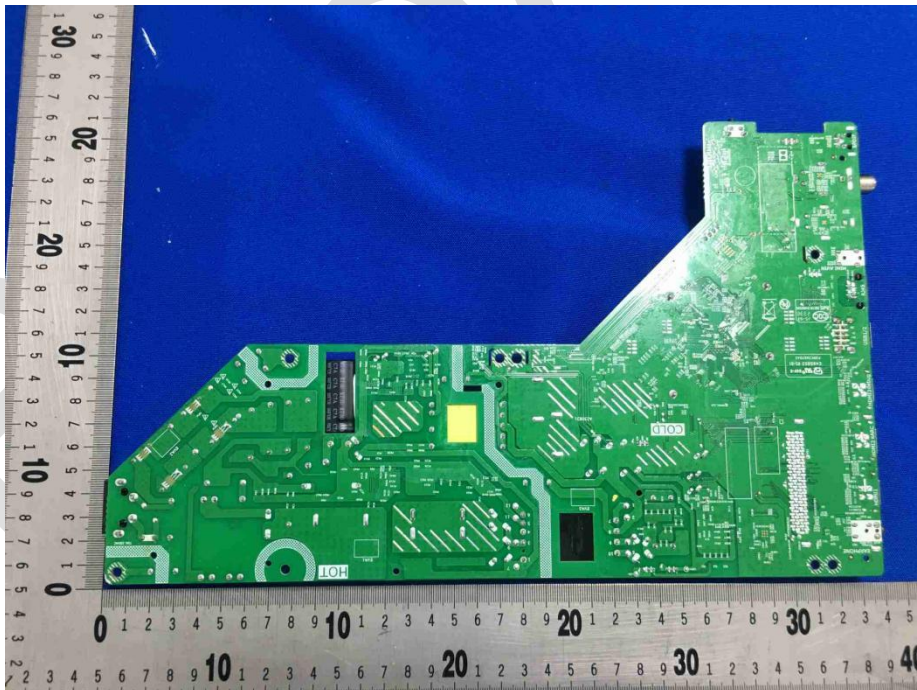

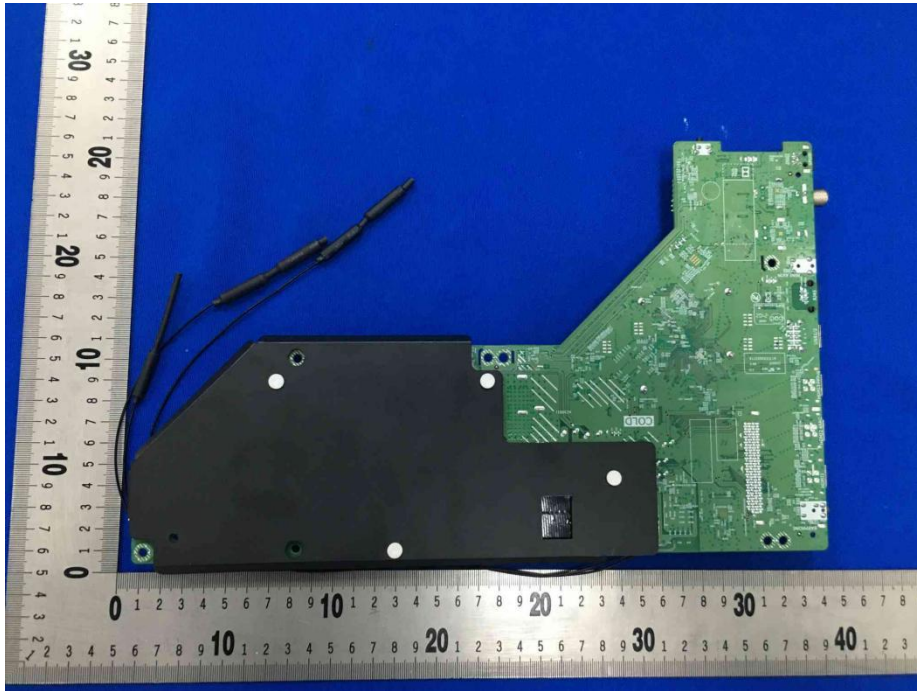

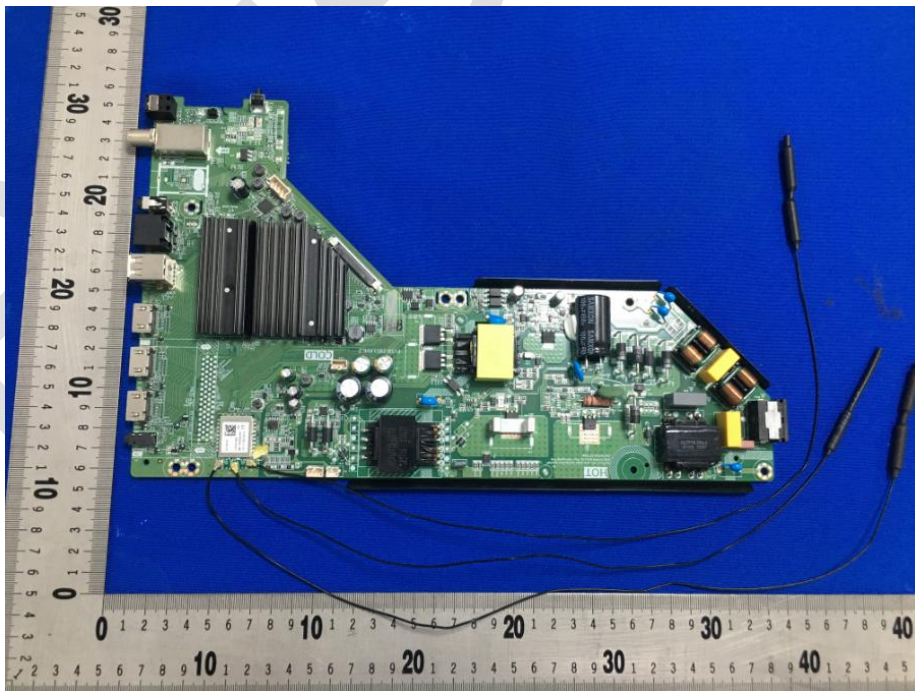
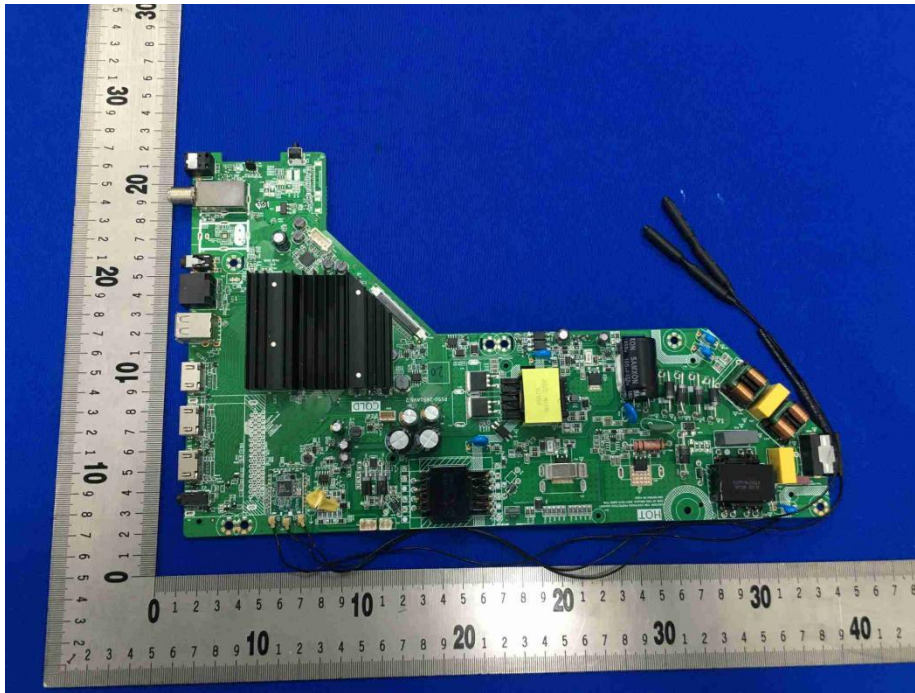

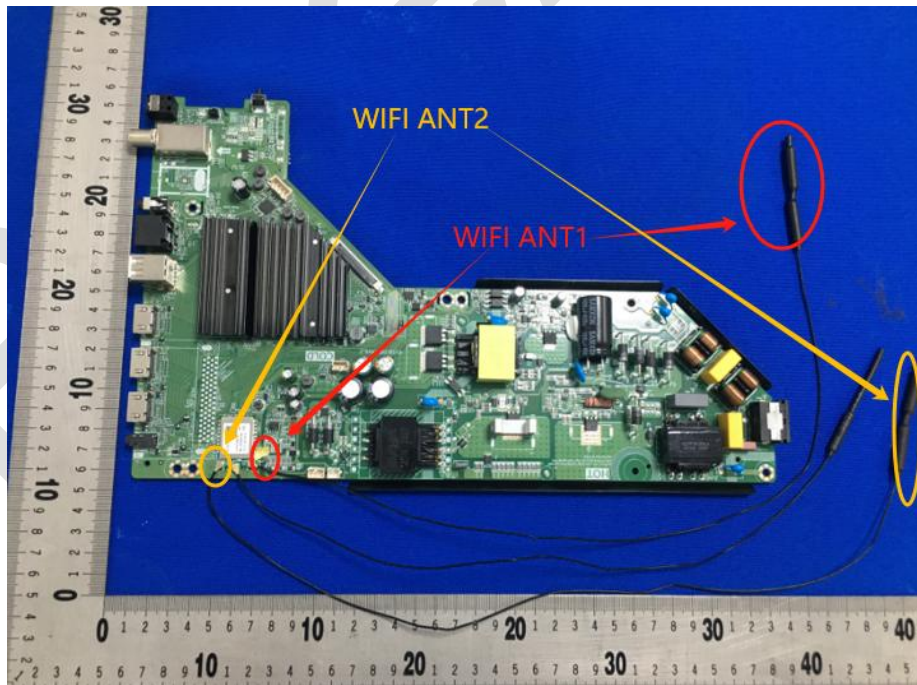
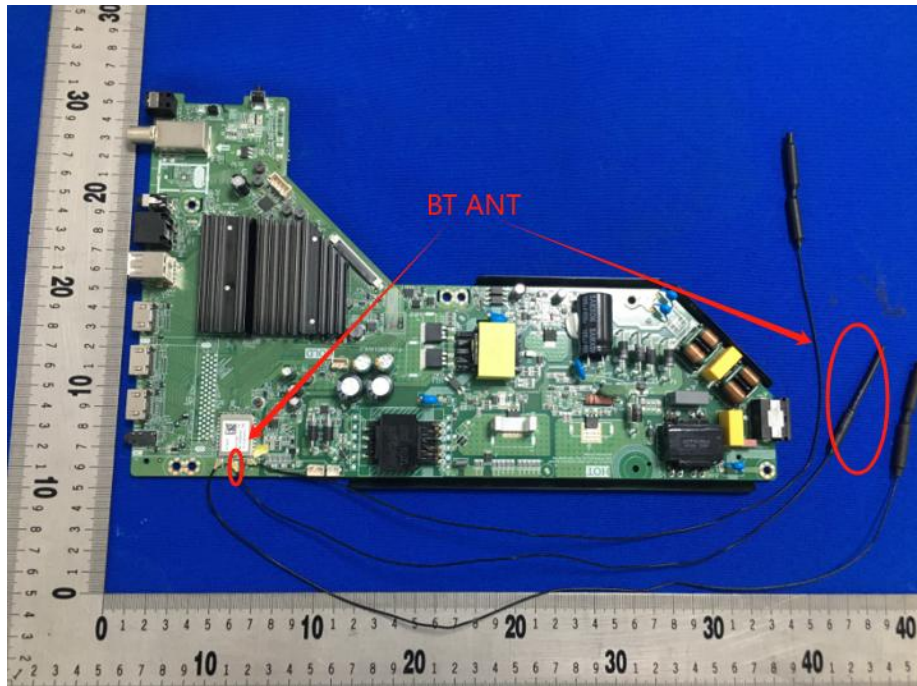

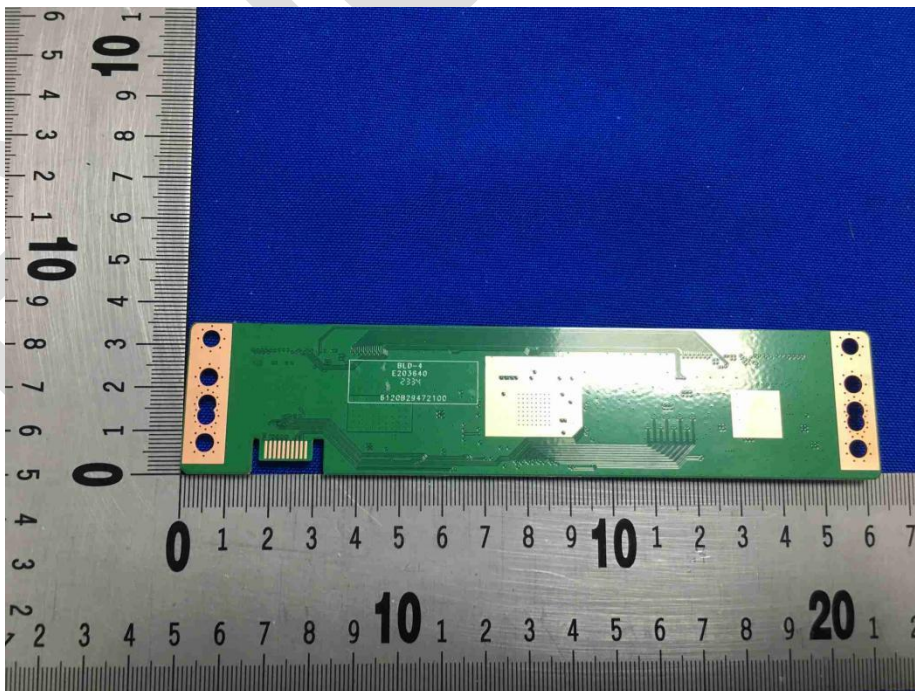
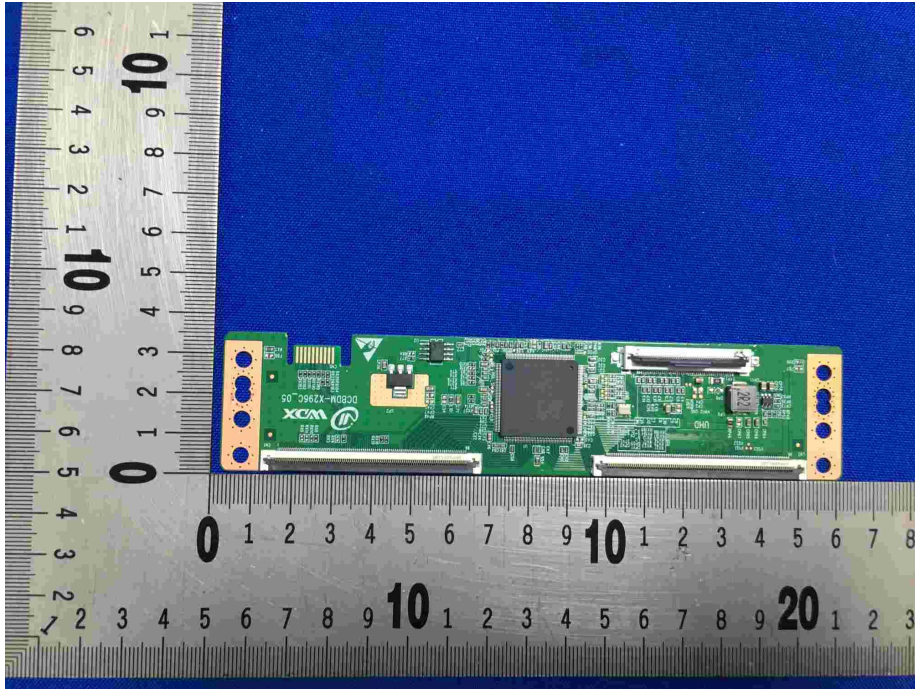

Extension model

