

Owner's Manual

Arm-type Fully Automatic Digital Blood Pressure Monitor Model DBP-6294B

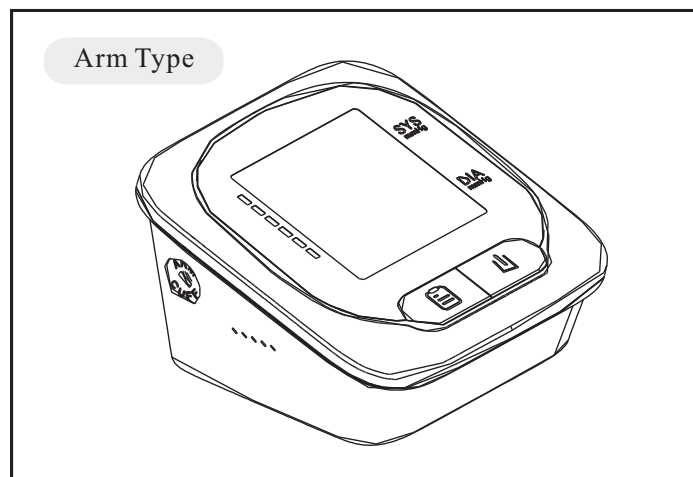

Document No.:JDBP-9404-054
Version: Z
Date of Issue: 2022.3.3

Contact Information

The lay operator or lay responsible or ganization should contact the manufacturer or the representative of manufacturer.
-for assistance,if needed,in setting up,using or maintaining the product,or
-to report unexpected operation or events.
Manufactured by JOYTECH Healthcare Co.,Ltd.
No.365, Wuzhou Road,Yuhang Economic Development Zone,
Hangzhou City,311100 Zhejiang,China
Email: info@sejoy.com
Telephone: +86-571-81957767
Fax: +86-571-81957750

Contents

1

Safety Notice	02
Unit Illustration	06
Important Testing Guidelines	08
Quick Start	09
Unit Operation	10
Battery Installation	10
System Settings	11
Applying the Arm Cuff	13
Testing	14
Power Off	17
Memory Check and Last 3 Test Average	18
Memory Deletion	19
Low Battery Indicator	19
Bluetooth requirement and connection	20
Troubleshooting	22
Blood Pressure Information	23
Blood Pressure Q&A	26
Maintenance	27
Specifications	29
Warranty	31
Electromagnetic Compatibility Information	32
Additional Notes	37

Safety Notice

2

Thank you for purchasing the DBP-6294B Blood Pressure Monitor. The unit has been constructed using reliable circuitry and durable materials. Used properly, this unit will provide years of satisfactory use.

Indications for use: The Arm-type Fully Automatic Digital Blood Pressure monitors are intended to measure blood pressure (systolic and diastolic) and pulse rate of adults and adolescents over 12 years of age.

All functions can be used safely and values can be read out in one LCD DISPLAY. Measurement position is on adult upper arm only.
The PATIENT is an intended OPERATOR

Blood pressure measurement determined with this device are equivalent to those obtained by a trained observer using the cuff/ stethoscope auscultation method, within the limits prescribed by the Recognized Consensus Standard (IEC 80601-2-30) for electronic sphygmomanometers.

Precautions to Ensure Safe, Reliable Operation

1. Do not drop the unit. Protect it from sudden jars or shocks.
2. Do not insert foreign objects into any openings.
3. Do not attempt to disassemble the unit.
4. Do not crush the pressure cuff.
5. If the unit has been stored at temperatures below 0 °C, leave it in a warm place for about 15 minutes before using it. Otherwise, the cuff may not inflate properly.
6. If the unit has been stored at temperatures above 40 °C, leave it in a cool place for about 15 minutes before using it. Otherwise, the cuff may not inflate properly.
7. Do not store the unit in direct sunlight, high humidity or dust.
8. To avoid any possibility of accidental strangulation, keep this unit away from children and do not drape tubing around your neck.
9. Ensure that children do not use the instrument unsupervised; some parts are small enough to be swallowed.
10. Some may get a skin irritation from the cuff taking frequent readings over the course of the day, but this irritation typically goes away on its own after the monitor is removed.

Safety Notice

3







Important Instructions Before Use

- Do not confuse self-monitoring with self-diagnosis. Blood pressure measurements should only be interpreted by a health professional who is familiar with your medical history.
- Contact your physician if test results regularly indicate abnormal readings.
- If you are taking medication, consult with your physician to determine the most appropriate time to measure your blood pressure. NEVER change a prescribed medication without first consulting with your physician.
- Individuals with serious circulation problems may experience discomfort. Consult your physician prior to use.
- For persons with irregular or unstable circulation resulting from diabetes, liver disease, arteriosclerosis or other medical conditions, there may be variations in blood pressure values measured at the wrist versus at the upper arm. Monitoring the trends in your blood pressure taken at either the arm or the wrist is nevertheless useful and important.
- People suffering from vascular constriction, liver disorders or diabetes, people with cardiac pacemakers or a weak pulse, and women who are pregnant should consult their physician before measuring their blood pressure themselves. Different values may be obtained due to their condition.
- People suffering from arrhythmias such as atrial or ventricular premature beats or atrial fibrillation only use this blood pressure monitor in consultation with your doctor. In certain cases oscillometric measurement method can produce incorrect readings.
- Too frequent measurements can cause injury to the patient due to blood flow interference.
- The cuff should not be applied over a wound as this can cause further injury.
- DO NOT** attach the cuff to a limb being used for IV infusions or any other intravascular access, therapy or an arterio-venous (A-V) shunt. The cuff inflation can temporarily block blood flow, potentially causing harm to the patient.
- The cuff should not be placed on the arm on the side of a mastectomy. In the case of a double mastectomy use the side of the least dominant arm.
- Pressurization of the cuff can temporarily cause loss of function of simultaneously used monitoring equipment on the same limb.
- A compressed or kinked connection hose may cause continuous cuff pressure resulting in blood flow interference and potentially harmful injury to the patient.
- Check that operation of the unit does not result in prolonged impairment of the circulation of the patient.
- Product is designed for its intended use only. Do not misuse in any way.
- Product is not intended for infants or individuals who cannot express their intentions.
- Prolonged over-inflation of the bladder may cause ecchymoma of your arm.
- Do not disassemble the unit or arm cuff. Do not attempt to repair.
- Use only the approved arm cuff for this unit. Use of other arm cuffs may result in incorrect measurement results.
- The system might produce incorrect readings if stored or used outside the manufacturer's specified temperature and humidity ranges. Make sure to store the blood pressure monitor, children, pets and pests are outside of accessible range.
- Do not use the device near strong electrical or electromagnetic fields generated by cell phones or other devices, they may cause incorrect readings and interference or become interference source to the device.
- Do not mix new and old batteries simultaneously.

Safety Notice

4

- Replace batteries when Low Battery Indicator "⎓" appears on screen. Replace both batteries at the same time.
- Do not mix battery types. Long-life alkaline batteries are recommended.
- Remove batteries from device when not in operation for more than 3 months.
- Dispose batteries properly; observe local laws and regulations.
- Only use a recommended class II AC Medical approved adaptor which comply with 2MOPP, and pass IEC 60601-1, IEC 60601-1-2 (FCC) standard. An unauthorized adapter may cause fire and electric shock.
-  Advising operator that Instruction manual/ Booklet must be consulted.
- Do not use the device during transport vehicles for influencing measurement accuracy, such as patient transport in an ambulance or helicopter.
- Contains small parts that may cause a choking hazard if swallowed by infants.
- Please align the polarities of each battery with the +ve and -ve signs imprinted on the battery housing when you replace the batteries.
- Use of this equipment adjacent to or stacked with other equipment should be avoided because it could result in improper operation. If such use is necessary, this equipment and the other equipment should be observed to verify that they are operating normally.
- Portable RF communications equipment (including peripherals such as antenna cables and external antennas) should be used no closer than 30 cm (12 inches) to any part of the unit, including cables specified by the manufacturer. Otherwise, degradation of the performance of this equipment could result.
- the blood pressure monitors equipped with bluetooth(BT) module is only transmit historical blood pressure (BP) from the subject device to a user-supplied digital device, and is not intended for active patient monitoring.

WARNING SIGNS AND SYMBOLS USED	
	Keep Dry
	Keep off Sunlight
	Type BF Equipment
	Instructions For Use MUST be Consulted
	Discard the used product to the recycling collection point according to local regulations
	The Bluetooth® Smart word mark and logos are registered trademarks owned by Bluetooth SIG, Inc. and any use of such marks by JOYTECH Healthcare Co.,Ltd.
IP21	IP21 indicate dustproof and waterproof grade. Number 2 indicate that Protected against solid foreign objects of 12.5 mm and greater; Number 1 indicate that Protection against vertically falling water drops.
	Magnetic Resonance unsafe

Safety Notice

5

Federal Commulcation Commission (FCC) Interference Statement

1.This device complies with part 15 of the FCC Rules. Operation is subject to the following two conditions:

- This device may not cause harmful interference, and
 - this device must accept any interference received, including interference that may cause undesired operation. Please note that changes or modifications not expressly approved by the party responsible for compliance could void the user's authority to operate the equipment.
- 2.This equipment has been tested and found to comply with the limits for a Class B digital device, pursuant to part 15 of the FCC Rules. These limits are designed to provide reasonable protection against harmful interference in a residential installation. This equipment generates, uses and can radiate radio frequency energy and, if not installed and used in accordance with the instructions, may cause harmful interference to radio communications. However, there is no guarantee that interference will not occur in a particular installation. If this equipment does cause harmful interference to radio or television reception, which can be determined by turning the equipment off and on, the user is encouraged to try to correct the interference by one or more of the following measures:

- Reorient or relocate the receiving antenna.
 - Increase the separation between the equipment and receiver.
 - Connect the equipment into an outlet on a circuit different from that to which the receiver is connected.
 - Consult the dealer or an experienced radio/TV technician for help.
- 3.This equipment complies with radio frequency exposure limits set forth by the FCC for an uncontrolled environment.
4. This device must not be co-located or operating in conjunction with any other antenna or transmitter.

5. Essential performance:

Electrosurgery interference recovery	Refer 202.6.2.101	IEC 80601-2-30
Limits of the error of the manometer	Refer 202.12.1.102	IEC 80601-2-30
Reproducibility of the BLOOD PRESSURE DETERMINATION	Refer 201.12.1.107	IEC 80601-2-30

Unit Illustration

6

Monitor Unit

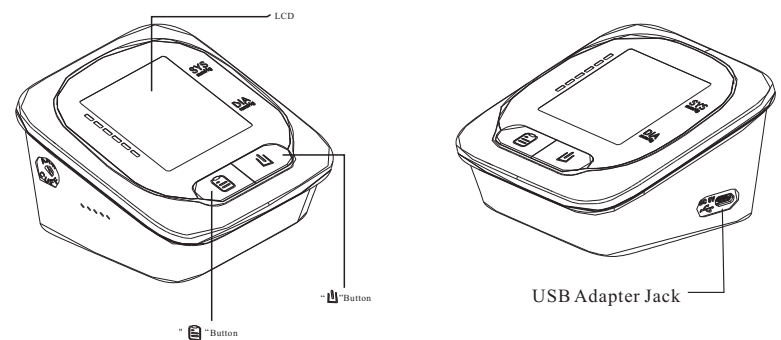

Arm Cuff Medium size cuff (fits arm circumference: 22.0 cm -36.0 cm).

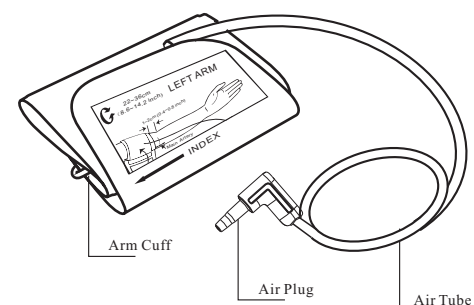

If air is leaking from the arm cuff, replace the arm cuff with a new one. It is generally recommended to have the cuff replaced timely to ensure correct functioning and accuracy. Please consult your local authorized Sejoy distributor or dealer.

Display

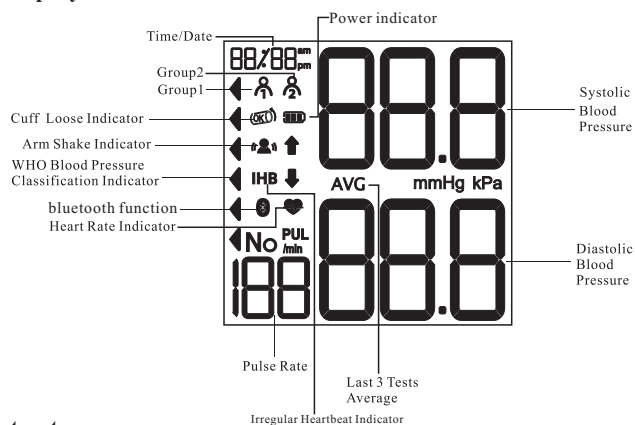

Contents

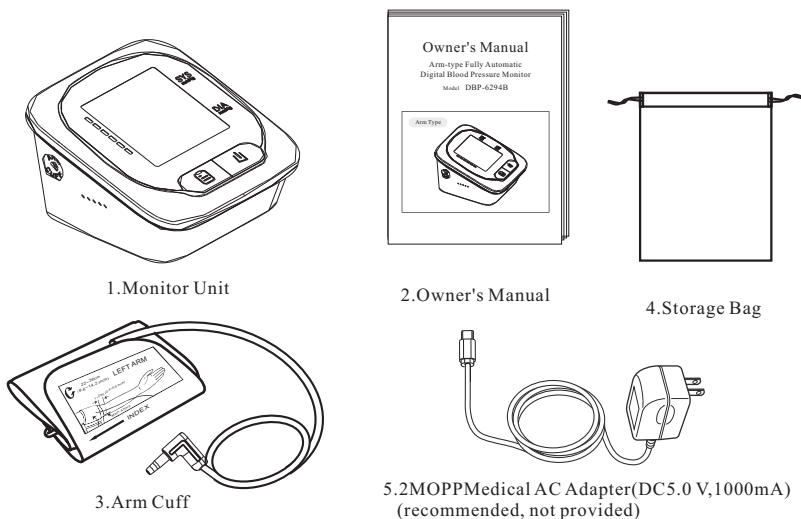

1. Avoid eating, exercising, and bathing for 30 minutes prior to testing.
2. Sit in a calm environment for at least 5 minutes prior to testing.
3. Do not stand while testing. Sit in a relaxed position while keeping your arm level with your heart.
4. Avoid speaking or moving body parts while testing.
5. While testing, avoid strong electromagnetic interference such as microwave ovens and cell phones.
6. Wait 3 minutes or longer before re-testing.
7. Try to measure your blood pressure at the same time each day for consistency.
8. Test comparisons should only be made when monitor is used on the same arm, in the same position, and at the same time of day.
9. This blood pressure monitor is not recommended for people with severe arrhythmia.
10. Do not use this blood pressure monitor if the device is damaged.

Any blood pressure recording can be affected by the following factors:

1. The position of the subject, his or her physiologic condition;
2. The performance and accuracy of the device;
3. Cuff size: too small cuff (bladder) will produce a higher blood pressure value than usual, too big cuff (bladder) will produce a lower blood pressure value;
4. Measuring position does not keep level with your heart;
5. Speaking or moving body parts while testing;
6. Not relaxing for about 5 minutes before taking the measurement.

Quick Start

1. Install batteries. (See Figure A)
2. Insert cuff air plug into the behind side of monitor unit. (See Figure B)

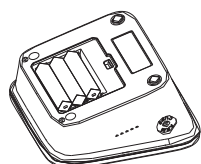

Figure A



Figure B

3. Remove thick clothing from the arm area.
4. Rest for several minutes prior to testing. Sit down in a quiet place comfortably, back and arm support on a desk or table, with your legs uncrossed, your arm resting on a firm surface and your feet flat on the floor. (See Figure C)

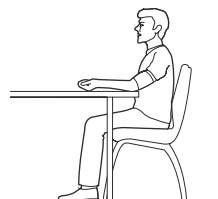

Figure C

5. Apply cuff to your left arm and middle of the cuff at the level of your heart. Bottom of cuff should be placed approximately 1-2cm (1/2") above elbow joint. (See Figures D&E)

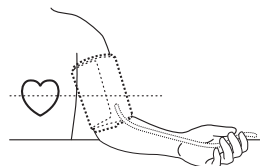

Figure D

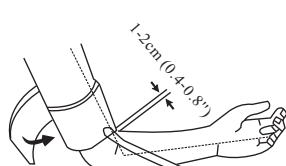

Figure E

6. Press "M" Button to start testing.

Unit Operation

Battery Installation

Slide battery cover off as indicated by arrow.

Install 3 new AAA alkaline batteries according to polarity.

Close battery cover.

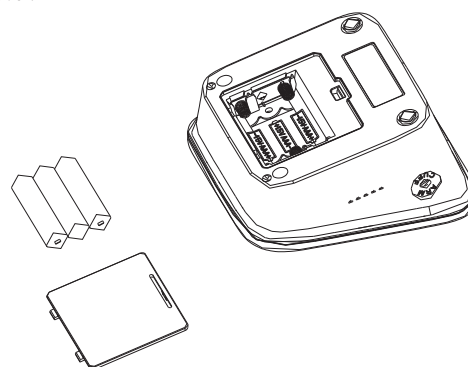

This blood pressure provides external power interface, can use the 2MOPP medical power adapter. The power supply port of the device is USB-C port, and the port applicable parameters is voltage 5v and current 1000mA. Do not use other types of AC adapters, otherwise, the device may be damaged.

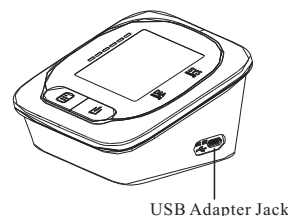

USB Adapter Jack

Note: power supply is specified as part of ME EQUIPMENT if provide.

System Settings

With power off, long press "⏏" button to activate System Settings. The Memory Group icon flashes..

1. Select Memory Group

While in the System Setting mode, you may accumulate test results into 2 different groups. This allows multiple users to save individual test results (up to 60 memories per group.) Press "⏏" button to choose a group setting. Test results will automatically store in each selected group.

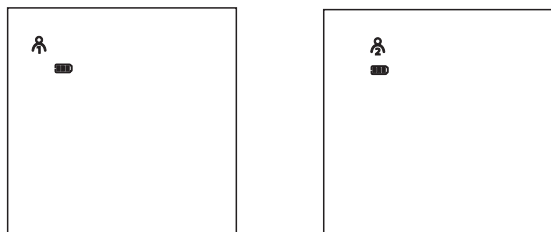

2. Time/Date setting

Press "⏏" button again to set the Time/Date mode. Set the year first by adjusting the "⏏" button. Press "⏏" button again to confirm current month. Continue setting the date, hour and minute in the same way. Every time the "⏏" button is pressed, it will lock in your selection and continue in succession (month,day,hour, minute,12/24 hours)

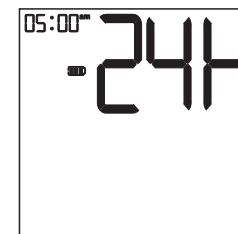
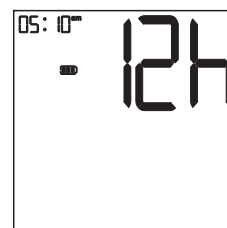
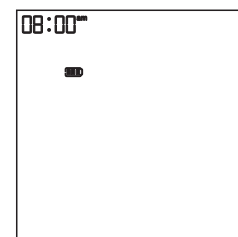
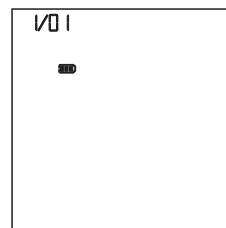
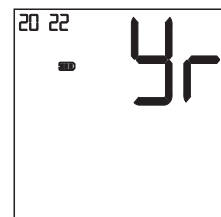

3. Time Format setting

Press "⏏" button again to set the time format setting mode. Set the time format by adjusting the "⏏" button. EU means European Time US means U.S Time.

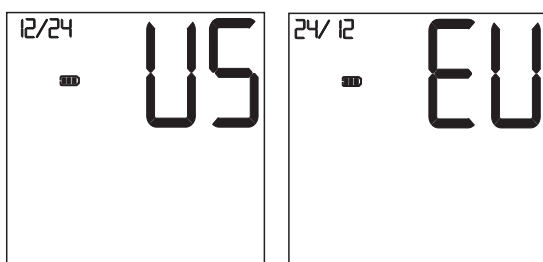

4. Voice Setting

Press "⏏" button to enter voice setting mode. Set voice format ON or OFF by pressing the "⏏" button.

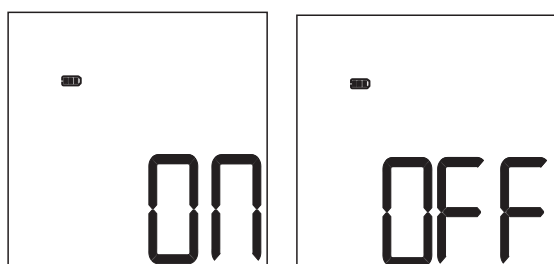

6. Volume Setting

Press "⏏" button to enter volume setting mode. Set the voice volume by adjusting the "⏏" button. There are six volume levels.

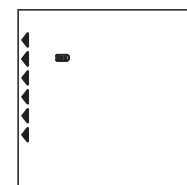

7. Saved Settings

While in any setting mode, long press "⏏" button to turn the unit off. All information will be saved.

Note: If unit is left on and not in use for 3 minutes, it will automatically save all information and shut off.

Applying the Arm Cuff

1. Firmly insert air plug into opening located on behind side of monitor unit.

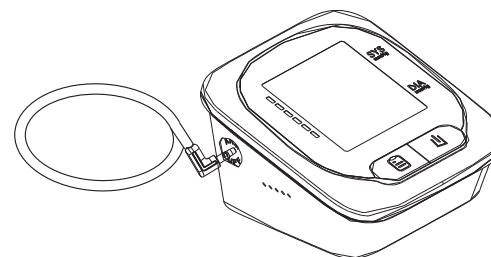

2. With sticky nylon section facing outward, insert end of cuff underneath metal ring of cuff.
3. Fasten cuff about 1-2cm (0.4-0.8") above the elbow joint. For best results apply cuff to bare arm and keep level with heart while testing.

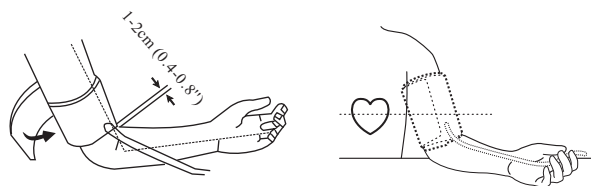

Note: Do not insert air plug into opening located on right side of monitor unit. This opening is designed for an optional power supply only.

Testing

1. Power On

Press and hold "P" button to turn the unit on. The LCD screen will appear for one second as unit performs a quick diagnosis. A voice tone will indicate when unit is ready for testing.

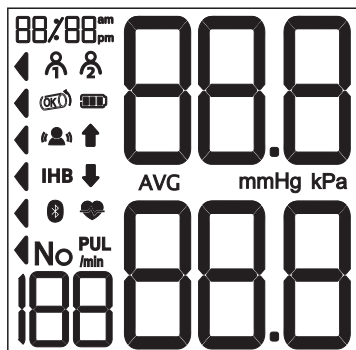

Note: Unit will not function if residual air from previous testing is present in cuff. The LCD will flash "P" until pressure is stabilized.

2. Testing

After cuff inflation, air will slowly rise as indicated by the corresponding cuff pressure value. A flashing "H" will appear simultaneously on screen signaling heart beat detection.

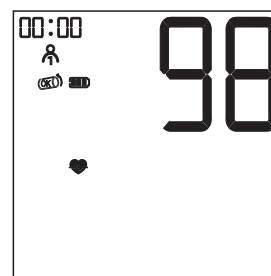

Note: Keep relaxed during testing. Avoid speaking or moving body parts.

3. Result Display

The screen will display measurements for systolic and diastolic blood pressure with voice broadcast. A indicator representing the current measurement will appear next to the corresponding WHO Classification.

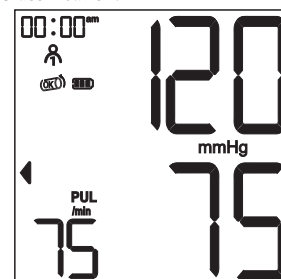

Note: Refer to Page 23~24 for detail WHO Blood Pressure Classification Information.

Irregular Heartbeat Indicator

If the monitor detects an irregular heart rhythm two or more times during the measuring process, the Irregular Heartbeat Symbol "IHB" appears on screen along with measurement results. Irregular heartbeat rhythm is defined as rhythm that is either 25% slower or faster than the average rhythm detected while measuring systolic blood pressure and diastolic blood pressure. Consult your physician if the Irregular Heartbeat Symbol "IHB" frequently appears with your test results.

Power Off

The "P" button can be pressed to turn off the unit in any mode. The unit can turn off the power itself about 3 minutes no operation in any mode.

Safety Precaution: If pressure in arm cuff becomes too extreme while testing, press the "P" button to turn power off. The cuff pressure will rapidly dissipate once the unit is off.

Arm Shake Indicator

If there is arm movement during the measurement, the "A" icon may flash. Indicates that the measurement results may be inaccurate, and the situation will be recorded at the end of the measurement as a reminder.

Cuff loose Indicator

At the beginning of the measurement, when the cuff is properly worn, the "OK" icon will be displayed, and when the cuff is loose, "LO" icon will be displayed. When this happens, please turn off the machine, adjust the cuff and measure again. If the "LO" icon is still displayed, please check the cuff plug connect with device correctly and measure again. If it still cannot be resolved, please contact the seller or manufacturer.

Last 3 Tests Average

With power off, press the "M" button to activate screen display. After the unit performs a self-diagnosis, the screen will display the average test results from the last 3 readings of the last group used. The "AVG" symbol will appear along with the corresponding WHO Blood Pressure Indicator. The Memory Check mode can be accessed by pressing "M" button. To check the average results from other groups, select the desired group first prior to activating "P" button in the off position. (See "Select Memory Group" on Page 11)

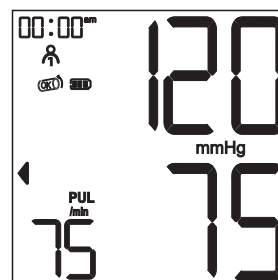

Memory Check

You may check past test results by using the "M" button. The most recent test result and oldest test result in memory can be viewed by pressing and holding the "M" button. Upon activating test results, you can press the "MEM" button to scroll through all test results stored in memory.

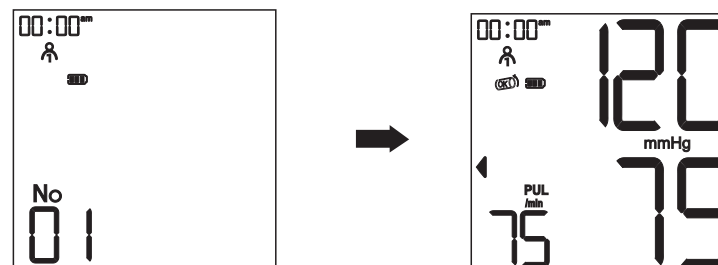

Unit Operation

19

Memory Deletion

Memory for a selected group may be deleted while in Memory Check mode. Press and hold the "M" button for approximately 3 seconds to delete all memory records from the selected group. with voice broadcast "Memory Clear" and then transfer into testing mode. Press the "M" button to turn the unit off.

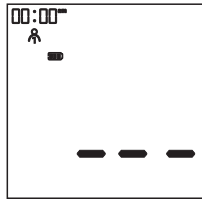

Note: Memory cannot be recovered once it has been deleted.

Low Battery Indicator

The unit will broadcast "Low Battery" when battery life is depleting and unable to inflate cuff for testing. The "B" appears simultaneously for approximately 5 seconds prior to shutting off. Replace batteries at this time. No memory loss will occur throughout this process.

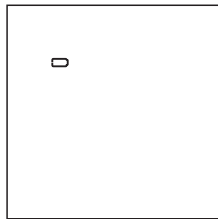

Static Pressure Measurement

In the power down state, press and hold the "M" button, and then install the batteries. Until the LCD screen is full, release the "M" button. When the LCD screen displays the double zero, the blood pressure meter is in static state. Software version is displayed :10 is a software version in the figure.

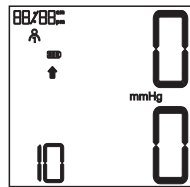

Note:
1) If another family member uses it, clean the cuff before use, and use it after it dries naturally;
2) Press "SET" to set the memory group, set the memory group.
3) Restart the measurement according to the operation method.
4) If you want to view the measured value, please refer to the memory view description on page 18.

Unit Operation

20

Note: Only Service personnel permitted to access to this mode, the mode unavailable in normal use.

Bluetooth requirements

The monitor requires a device with:

- . Bluetooth 4.0 or later
- . Android 5.0 or later
- . IOS 9.0 or later

And works with:

- . iPhone, iPod, iPad
- . Android Phones and Tablets

Wireless communication

- Frequency range : 2.4 GHz (2400-2483.5 MHz)
- Modulation : GFSK
- Antenna gain: 0.5dBi

Bluetooth connection

-Using for the first time

1. Download the free "JoyHealth" App: On your mobile phone or table go to www.sejoy.com.
2. Open the App on your phone or tablet. If requested, you should enable Bluetooth on your device. You can enable Bluetooth under the Settings menu on your smart phone or table.
3. Create a new user login, or login with your existing user name and password.
4. Selection device "Blood pressure monitor".

-Pairing your monitor with a Smart Device

1. Long press the "B" button on your monitor until the word "boo" flashes on your monitor.

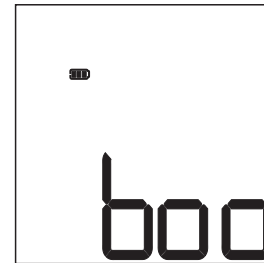

Unit Operation

21

2. Open the APP and click "pair device" button, a popup window will appear. Click "Search device" button to display all sphygmomanometer devices(The display information includes the device mode and MAC address), then you can find the sphygmomanometer through the "device Name", click the pictureA film or text can be used to pair the device.

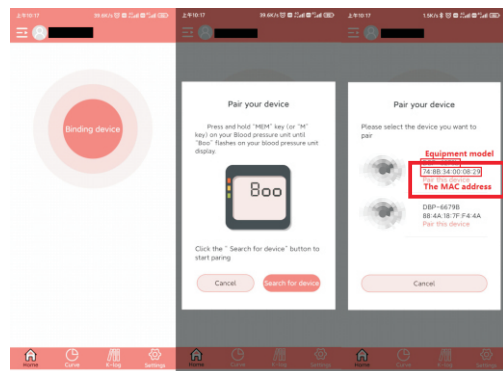

The MAC address

3. After the pairing is complete, the device interface switches from boo interface, indicating that the pairing is successful.

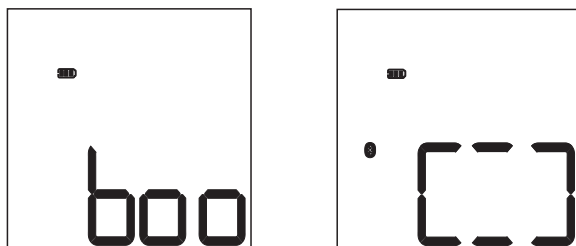

-Transfer your readings

1. As soon as your measurement is complete, open the app on your smart phone to transfer your readings.

Notr: On the paired smartphone, Bluetooth must be enabled.

2. You can view your blood pressure readings on the app.

Unit Operation

22

Troubleshooting

Abnormal phenomenon	Cause analysis	Processing method
Abnormal sphygmomanometer	The armband is tied too tight or too loose, Or the arm strap is tied incorrectly;	Roll the armband correctly
	Move the arm during measurement or Electronic sphygmomanometer	Stay quiet, keep your arm steady, and do not move the monitor
	Speaking, nervous or emotional during measurement	Instead of talking, take deep breaths to calm your mood and relax your body
	Incorrect measurement posture	Adjust posture, see "Blood pressure gauge Wearing"
	There is interference in charging process or improper operation in measuring process	See operation Instructions.

The following table shows the error signs that may occur during measurement, possible causes and handling methods. Please measure again using the correct method

Error display	The cause of the problem	The solution
Er1	Can't detect high and low pressure	Please fasten the cuff before measuring
Er2	Cuff too loose or loose	Please fasten the cuff before measuring
Er3	Improper compression caused by arm or body movement	Hold the arm or body still and measure again
Er4	The pressure exceeds 300mmHg	Please fasten the cuff before measuring
Er5	The pressure exceeds 15mmHg for 3 minutes	Check whether the cuff is knotted or the vent valve is blocked. If the problem persists, contact the manufacturer
B	Battery dead	Replace the battery or connect the power adapter (if any).

Note: If you cannot solve the abnormal situation by yourself, you can consult the manufacturer or the manufacturer's designated unit by phone. It is forbidden to disassemble and repair without permission. If necessary, professional maintenance personnel can ask the manufacturer for the list of components and circuit schematic diagram.

Blood Pressure

Blood pressure is the force of blood pushing against the walls of arteries. It is typically measured in millimeters of mercury (mmHg.) Systolic blood pressure is the maximum force exerted against blood vessel walls each time the heart beats. Diastolic blood pressure is the force exerted on blood vessels when the heart is resting between beats.

An individual's blood pressure frequently changes throughout the course of a day. Excitement and tension can cause blood pressure to rise, while drinking alcohol and bathing can lower blood pressure. Certain hormones like adrenaline (which your body releases under stress) can cause blood vessels to constrict, leading to a rise in blood pressure.

If these measuring numbers become too high, it means the heart is working harder than it should.

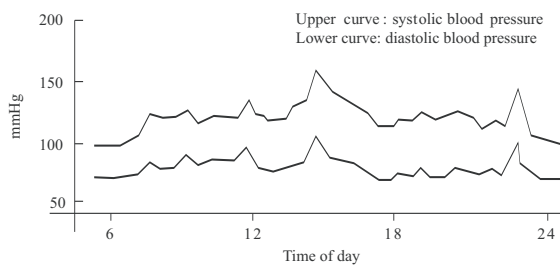

Example: fluctuation within a day (male, 35 years old)

WHO Blood Pressure Classification Indicator

The DBP-6279B is equipped with a classification indicator based on established guidelines from the World Health Organization. The chart below (color coded on monitor unit) indicates test results.

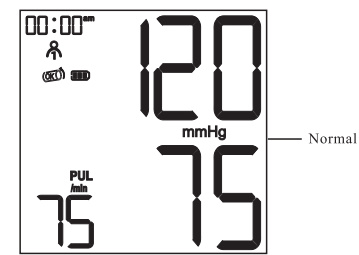
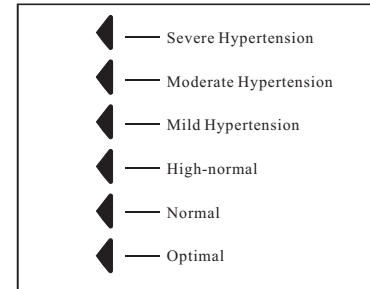

◀ Blood Pressure Classification Indicator

Health Reminder

Hypertension is a dangerous disease that can affect the quality of life. It can lead to a lot of problems including heart failure, kidney failure, and cerebral hemorrhaging. By maintaining a healthy lifestyle and visiting your physician on a regular basis, hypertension and relative diseases are much easier to control when diagnosed in their early stages.

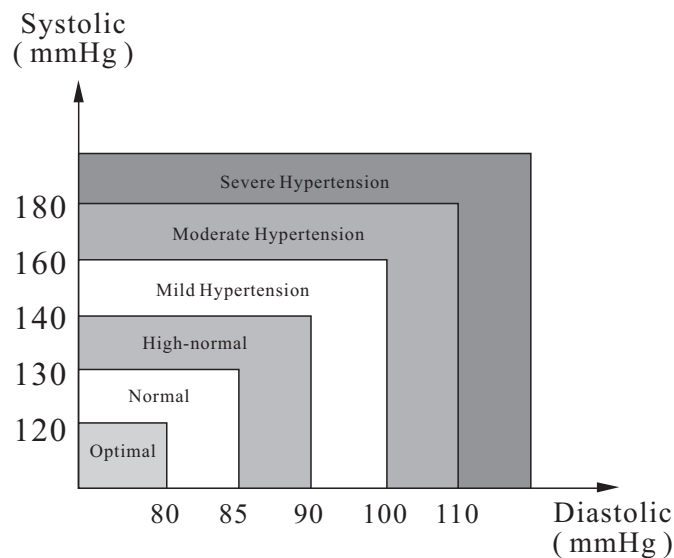

Note: Do not be alarmed if an abnormal reading occurs. A better indication of an individual's blood pressure occurs after 2-3 readings are taken at the same time each day over an extended period of time. Consult your physician if test results remain abnormal.

- Q: What is the difference between measuring blood pressure at home or at a professional healthcare clinic?
- A: Blood pressure readings taken at home are now seen to give a more accurate account as they better reflect your daily life. Readings can be elevated when taken in a clinical or medical environment. This is known as White Coat Hypertension and may be caused by feeling anxious or nervous.

Note: Abnormal test results may be caused by:

1. Improper cuff placement
Make sure cuff is snug-not too tight or too loose.
Make sure bottom of the cuff is approximately 1-2cm (1/2") above the elbow joint.
2. Improper body position
Make sure to keep your body in an upright position.
3. Feeling anxious or nervous
Take 2-3 deep breaths, wait a few minutes and resume testing.

- Q: What causes different readings?
- A: Blood pressure varies throughout the course of a day. Many factors including diet, stress, cuff placement, etc. may affect an individual's blood pressure.
- Q: Should I apply the cuff to the left or right arm? What is the difference?
- A: Either arm can be used when testing, however, when comparing results, the same arm should be used. Testing on your left arm may provide more accurate results as it is located closer to your heart.
- Q: What is the best time of day for testing?
- A: Morning time or any time you feel relaxed and stress free.

1. Avoid dropping, slamming, or throwing the unit.

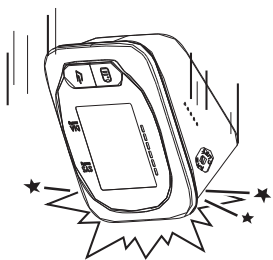

2. Avoid extreme temperatures. Do not expose unit directly under sunshine.

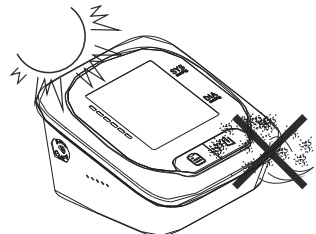

3. When cleaning the unit, use a soft fabric and lightly wipe with mild detergent.

Use a damp cloth to remove dirt and excess detergent. It is recommended to wash once every 1-3 months under normal circumstances. If the previous cleaning instructions are not successful, repeat several times until the visible dirt is removed.

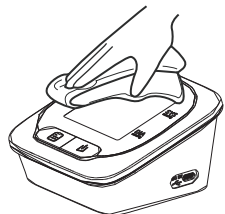

4. Cuff Cleaning and Disinfection:

- A) Spread the cuff (skin-contact surface) upwards onto a clean table. Use a damp clean cloth (water-based) to wipe the skin-contact surface with a force.
 - B) Soak the cloth clean with drinking water and wring it dry. Repeat A) with the damp cloth (water-based) for 3 times.
 - C) Apply 70%-80% alcohol to a new cloth (or 75% alcohol cotton-ball), use it to wipe the skin-contact surface with a force. Then soak the cloth with the alcohol again (or change a new 75% alcohol cotton-ball), repeat the disinfection procedure for 3 times.
 - D) When the disinfection towards the skin-contactsurface is finished, wipe thenon-skin contact surface with a cloth (alcohol-based) or alcohol cotton-ball thoroughly for 3 times.
 - E) Leave the cuff naturally dry, then it is ready for reuse.
- Notice: Do not soak in water or splash water on it.

5. Do not use petrol, thinners or similar solvents.

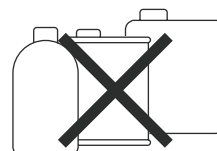

6. Remove batteries when not in operation for an extended period of time.

7. Do not disassemble product.

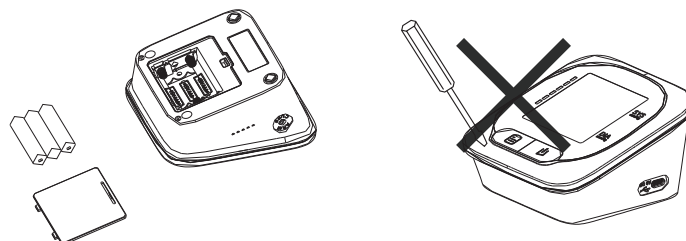

8. It is recommended the performance should be checked every 2 years.

9. Expected service life: Approximately three years at 10 tests per day.

10.No service and maintenance while it is in use and maintenance only be performed by service personnel. Service and maintenance require parts, repair, technical support will be provided.

Product Description	Arm-type Fully Automatic Blood Pressure Monitor	
Model	DBP-6294B	
Display	LCD Digital Display Size:52.4mm x 52.4mm(2.06" x 2.06")	
Measurement Method	Oscillometric Method	
Measurement Range	Systolic Pressure	60mmHg~260mmHg
	Diastolic Pressure	40mmHg~200mmHg
	Pressure	0mmHg~299mmHg
	Pressure	±3mmHg
	Pulse	30 ~ 180 Beats/Minute
	Pulse	±5%
Pressurization	Automatic Pressurization	
Memory	2x150 Memories in Two Groups with Date and Time	
Function	Irregular Heartbeat Detection	
	WHO Classification Indicator	
	Last 3 Tests Average	
	Low Battery Detection	
	Automatic Power-Off	
	Voice	
	Backlight	
Bluetooth		
Power Source	3 AAA batteries or Medical AC Adapter(DC5.0V, 1000mA) (recommended, not provided)	
Battery Life	Approximately 2 months at 3 tests per day	
Unit Weight	Approx.205g (7.23 oz.) (excluding battery)	
Unit Dimensions	Approx.110.2 x 101.9 x 57.3mm (4.34" x 4.01" x 2.26")(L x W x H)	
Cuff Circumference	Medium cuff: Fits arm circumference 22-36 cm or 22-42cm or 32-48cm	
Operating Environment	Temperature	10°C ~ 40°C (50°F~104°F)
	Humidity	15% ~ 93% RH

Operating Environment	Pressure	800hPa~1060hPa
	Temperature	-25°C~55°C (-13°F~131°F)
Storage Environment	Humidity	≤93% RH
	Temperature	-25°C~55°C (-13°F~131°F)
Transport Environment	Humidity	≤93% RH
	Modulation Type	GFSK
Bluetooth	Version	5.0.1 BT Signal mode
	Operation frequency	2. 4GHz (2400~2483. 5MHz)
	Antenna gain	0 dBi
	Bandwidth	2.0 MHz
	Classification	Internal Powered Equipment,Type BF , Cuff is the Applied Part
Ingress Protection rating	IP 21,Indoor Used Only	
Battery Shelf life	60 months	
Battery Storage Temperature	-25°C~55°C (-13°F~131°F)	

Specifications are subject to change without notice.

Safety Standard (included but not limited) :

- 1. IEC 80601-2-30, medical electrical equipment - part 2-30: particular requirements for the basic safety and essential performance of automated noninvasive sphygmomanometers. (Cardiovascular)
- 2. ISO 81060-2, non-invasive sphygmomanometers - part 2: clinical validation of automated measurement type. (Cardiovascular)
- 3. AAMI / ANSI ES 60601-1:2005/ (R) 2012 and, a2:2010/ (r) 2012 (consolidated text) medical electrical equipment -- part 1: general requirements for basic safety and essential performance
- 4. AAMI/ANSI/IEC 60601-1-2, Medical Electrical Equipment -- Part 1-2: General Requirements For Basic Safety And Essential Performance -- Collateral Standard: Electromagnetic Disturbances -- Requirements And Tests (General II (ES/EMC)).
- 5. IEC 60601-1-11, medical electrical equipment - part 1-11: general requirements for basic safety and essential performance - collateral standard: requirements for medical electrical equipment and medical electrical systems used in the home healthcare environment.

The Blood Pressure Monitor is guaranteed for 2-year from the date of purchase. If the Blood Pressure Monitor does not function properly due to defective components or poor workmanship, we will repair or replace it freely. The warranty does not cover damages to your Blood Pressure Monitor due to improper handling. Please contact local retailer for details.

The device satisfies the EMC requirements of the international standard IEC 60601-1-2. The requirements are satisfied under the conditions described in the table below. The device is an electrical medical product and is subject to special precautionary measures with regard to EMC which must be published in the instructions for use. Portable and mobile HF communications equipment can affect the device. Use of the unit in conjunction with non-approved accessories can affect the device negatively and alter the electromagnetic compatibility. The device should not be used directly adjacent to or between other electrical equipment.

Table 1

Guidance and declaration of manufacturer-electromagnetic emissions		
The device is intended for use in the electromagnetic environment specified below. The customer or the user of the device should assure that it is used in such an environment.		
Emissions test	Compliance	Electromagnetic environment -guidance
Radiated emission CISPR 11	Group 1, class B.	The device uses RF energy only for its internal function. Therefore, its emissions are very low and are not likely to cause any interference in nearby electronic equipment.
Conducted emission CISPR 11	Group 1, class B.	The device is suitable for use in all establishments, including domestic establishments and those directly connected to the public low-voltage power supply network that supplies buildings used for domestic purposes.
Harmonic emissions IEC 61000-3-2	Class A	
Voltage fluctuations/flicker emissions IEC 61000-3-3	Complies	

Table 2

Guidance and declaration of manufacturer-electromagnetic immunity			
The device is intended for use in the electromagnetic environment specified below. The customer or the user of the device should assure that it is used in such an environment.			
IMMUNITY test	IEC 60601 test level	Compliance level	Electromagnetic environment -guidance
Electrostatic discharge (ESD) IEC 61000-4-2	± 8 kV contact ± 2 kV, ± 4 kV, ± 8 kV, ± 15 kV air	± 8 kV contact ± 2 kV, ± 4 kV, ± 8 kV, ± 15 kV air	Floors should be wood, concrete or ceramic tile. If floors are covered with synthetic material, the relative humidity should be at least 30 %.
Electrostatic transient/burst IEC 61000-4-4	± 2 kV, 100kHz, for AC power port	± 2 kV, 100kHz, for AC power port	Mains power quality should be that of a typical commercial or hospital environment.
Surge IEC 61000-4-5	±0.5kV, ±1kV (differential mode)	±0.5kV, ±1kV (differential mode)	Mains power quality should be that of a typical commercial or hospital environment.
Voltage dips, short interruptions and voltage variations on power supply input lines IEC 61000-4-11	0 % UT; 0,5 cycle At 0°, 45°, 90°, 135°, 180°, 225°, 270° and 315°	0 % UT; 0,5 cycle At 0°, 45°, 90°, 135°, 180°, 225°, 270° and 315°	Mains power quality should be that of a typical commercial or hospital environment.
	0 % UT; 1 cycle and 70 % UT; 25/30 cycles Single phase: at 0°	0 % UT; 1 cycle and 70 % UT; 25/30 cycles Single phase: at 0°	
Power frequency (50/60 Hz) magnetic field IEC 61000-4-8	30 A/m; 50Hz or 60Hz	30 A/m; 50Hz or 60Hz	Power frequency magnetic fields should be at levels characteristic of a typical location in a typical commercial or hospital environment.

Table 2(continued)



Guidance and declaration of manufacturer-electromagnetic immunity			
The device is intended for use in the electromagnetic environment specified below. The customer or the user of the device should assure that it is used in such an environment.			
IMMUNITY test	IEC 60601 test level	Compliance level	Electromagnetic environment -guidance
Radiated RF EM fields IEC 61000-4-3	10 V/m80MHz-2.7Ghz 80%AM at 1kHz	10 V/m80MHz-2.7Ghz 80%AM at 1kHz	Portable and mobile RF communications equipment should be used no closer to any part of the device, including cables, than the recommended separation distance calculated from the equation applicable to the frequency of the transmitter. Recommended separation distance 80 MHz to 800 MHz 800 MHz to 2.7 GHz where P is the maximum output power rating of the transmitter in watts (W) according to the transmitter manufacturer and d is the recommended separation distance in metres (m). Field strengths from fixed RF transmitters, as determined by an electromagnetic site survey, should be less than the compliance level in each frequency range. Interference may occur in the vicinity of equipment marked with the following symbol: 
Conducted disturbances Induced by RF fields IEC 61000-4-6	3 V in 0.15 MHz- 80 MHz 6 V in ISM and/or amateur radio bands between 0.15 MHz and 80 MHz 80 % AM at 1kHz	3 V in 0.15 MHz- 80 MHz 6 V in ISM and/or amateur radio bands between 0.15 MHz and 80 MHz 80 % AM at 1kHz	Portable and mobile RF communications equipment should be used no closer to any part of the device, including cables, than the recommended separation distance calculated from the equation applicable to the frequency of the transmitter. Recommended separation distance 80 MHz to 800 MHz 800 MHz to 2.7 GHz where P is the maximum output power rating of the transmitter in watts (W) according to the transmitter manufacturer and d is the recommended separation distance in metres (m). Field strengths from fixed RF transmitters, as determined by an electromagnetic site survey, should be less than the compliance level in each frequency range. Interference may occur in the vicinity of equipment marked with the following symbol: 

Table 3

Guidance and declaration of manufacturer-electromagnetic immunity						
Nowadays, many RF wireless equipments have being used in various healthcare locations where medical equipment and/or systems are used. When they are used in close proximity to medical equipment and/or systems, the medical equipment and/or systems' basic safety and essential performance may be affected. Arm-type Fully Automatic Digital Blood Pressure Monitor has been tested with the immunity test level in the below table and meet the related requirements of IEC 60601-1-2:2014. The customer and/or user should help keep a minimum distance between RF wireless communications equipment and this medical equipment and/or systems as recommended below.						
Test frequency (MHz)	Band (MHz)	Service	Modulation	Maximum power (W)	Distance (m)	Immunity test level (V/m)
385	380-390	TETRA 400	Pulse modulation 18Hz	1.8	0.3	27
450	430-470	GMRS 460 FRS 460	FM ± 5 kHz deviation 1 kHz sine	2	0.3	28
710	704-787	LTE Band 13, 17	Pulse modulation 217Hz	0.2	0.3	9
745						
780						
810	800-960	GSM 800/900, TETRA 800, iDEN 820, CDMA 850, LTE Band 5	Pulse modulation 18Hz	2	0.3	28
870						
930						
1720	1700-1990	GSM 1800; CDMA 1900; GSM 1900; DECT; LTE Band 1, 3, 4, 25; UMTS	Pulse modulation 217Hz	2	0.3	28
1845						
1970						
2450	2400-2570	Bluetooth,WLAN, 802.11 b/g/n,RFID 2450,LTE Band 7	Pulse modulation 217Hz	2	0.3	28
5240	5100-5800	WLAN 802.11 a/n	Pulse modulation 217Hz	0.2	0.3	9
5500						
5785						

Table 4

Recommended separation distances between portable and mobile RF communications equipment and the device		
The device is intended for use in an electromagnetic environment in which radiated therefore disturbances are controlled. The customer or the user of the device can help prevent electromagnetic interference by maintaining a minimum distance between portable and mobile RF communications equipment (transmitters) and the device as recommended below, according to the maximum output power of the communications equipment.		
Rated maximum output power of transmitter W	Separation distance according to frequency of transmitter m	
	80 MHz to 800 MHz $d = \left[\frac{3.5}{E_i} \right] \sqrt{P}$	800 MHz to 2.7 GHz $d = \left[\frac{7}{E_i} \right] \sqrt{P}$
0.01	0.12	0.23
0.1	0.38	0.73
1	1.2	2.3
10	3.8	7.3
100	12	23

For transmitters rated at a maximum output power not listed above, the recommended separation distance d in metres (m) can be estimated using the equation applicable to the frequency of the transmitter, where P is the maximum output power rating of the transmitter in watts (W) according to the transmitter manufacturer.

NOTE1 At 80 MHz and 800 MHz, the separation distance for the higher frequency range applies.

NOTE2 These guidelines may not apply in all situations. Electromagnetic propagation is affected by absorption and reflection from structures, objects and people.

Additional Notes

Important Instructions Before Use

- WARNING:** Use of this equipment adjacent to or stacked with other equipment should be avoided because it could result in improper operation. If such use is necessary, this equipment and the other equipment should be observed to verify that they are operating normally.
- WARNING:** PORTABLE RF communications equipment (including peripherals such as antenna cables and external antennas) should be used no closer than 30 cm (12 inches) to any part of Arm-type Fully Automatic Digital Blood Pressure Monitor, including cables specified by the MANUFACTURER. Otherwise, degradation of the performance of this equipment could result.
- The software identifier refer to the software verification and validation report , and the file code is **JYRJ200925001**.
- verify manometer pressure accuracy:**
In the power down state, press and hold the " START/STOP" button, and then install the batteries. Until the LCD screen is full, release the " START/STOP" button. When the LCD screen displays the double zero, the bloodpressure meter is in static state. At this point, 500ml gas capacity, calibrated standard pressure gauge and manual pressure device can be connected to the sphygmomanometer through the sleeve interface of the sphygmomanometer, and manual pressure can be applied to the effective display range of the sphygmomanometer, and then the difference between the reading of the sphygmomanometer and that of the standard pressure gauge can be compared. This mode can be used to verify manometer pressure accuracy.
- Contraindications:**
Product is not intended for infants or individuals who cannot express their intentions.
- Intended Use**
The digital blood pressure monitor are reusable for clinical and home use and are non-invasive blood pressure measurement systems designed to measure the systolic and diastolic blood pressure and pulse rate of adolescents and adults individual by using a non-invasive technique, which is a well-known technique in the market called the "oscillometric method". it can measure the systolic blood pressure, diastolic blood pressure and pulse rated on up-arm, and the device is reusable for clinical or home use.
- The patient is the operator:**
the PATIENT is an intended OPERATOR.
the PATIENT Do not carry out other maintenance operations except to replace the battery.
- WARNING:**
Do not modify this equipment without authorization of the manufacturer.
- ESSENTIAL PERFORMANCE Maintenance advice:**
Pressure calibration will be carried out when this product leaves the factory. Patients can use the method described in the section "Verify Manometer Pressure Accuracy" to verify the accuracy. If the accuracy deviation is large, please contact the manufacturer to recalibration.
- Mechanical strength and resistance to heat**The resistance to heat will be retained by device during the EXPECTED SERVICE LIFE of the ME EQUIPMENT.

Additional Notes

- Do not place the blood pressure monitor and cuff at will. It will cause asphyxiation if the child swallows or twine around his neck.
- The cuff and the case of the blood pressure monitor have been tested for biocompatibility and do not contain allergenic or harmful materials. Please stop using it if allergy occurs during use.
- Warning:**
Non-professionals do not modify the equipment, otherwise it will make the equipment measurement is not accurate.
- Warning:**
Do not expose the equipment for a long time, otherwise it will reduce the performance of the equipment.
- Warning:**
This device is not used for children and pets
- Clean:**
The equipment can be cleaned by lay operator according to the cleaning procedures in the instructions
- Warning:**
Do not use a damaged cuff for blood pressure measurement.
- Warning:**
When measuring with the cuff, if the tester feels seriously uncomfortable, press the button of the blood pressure monitor to deflate the cuff, or remove the cuff directly from the arm.
- Warning:**
If an unexpected reading occurs, the operator can take several more measurements and consult a doctor.
- Warning:**
This equipment is used outside the specified environment, may damage the equipment, and may be inaccurate measurement.
- ME equipment not intended for use in conjunction with flammable agents "ME equipment not intended for use in oxygen rich environment"

Correct Disposal of This Product
(Waste Electrical & Electronic Equipment)



This marking shown on the product indicates that it should not be disposed with other household waste at the end of its life. To prevent potential harm to the environment or to human health, please separate this product from other types of wastes and recycle it responsibly. When disposing this type of product, contact the retailer where product was purchased or contact your local government office for details regarding how this item can be disposed in an environmentally safe recycling center. Business users should contact their supplier and check the terms and conditions of the purchasing agreement. This product should not be mixed with other commercial wastes for disposal. This product is free of hazardous materials.