



TESTING LABORATORY
CERTIFICATE # 4821.01



FCC PART 90

TEST REPORT

For

CALTTA TECHNOLOGIES CO., LTD.

Floor12, Building G2, international E-City Nanshan District, Shenzhen, China

FCC ID: 2AQV7PR900V

Report Type: Original Report	Product Type: Digital Repeater, VHF DMR(Digital Mobile Radio)
Report Number:	SZ1210412-10911E-00
Report Date:	2021-05-10
Reviewed By:	Jacob Kong <i>Jacob Kong</i> RF Engineer
Prepared By:	Bay Area Compliance Laboratories Corp. (Shenzhen) 5F(B-West), 6F, 7F, the 3rd Phase of Wan Li Industrial Building D, Shihua Rd, FuTian Free Trade Zone, Shenzhen, China Tel: +86-755-33320018 Fax: +86-755-33320008 www.baclcorp.com.cn

Note: This report must not be used by the customer to claim product certification, approval, or endorsement by A2LA* or any agency of the Federal Government. This report may contain data that are not covered by the A2LA accreditation and are marked with an asterisk "★".

BACL is not responsible for the authenticity of any test data provided by the applicant. Data included from the applicant that may affect test results are marked with an asterisk '*'. Customer model name, addresses, names, trademarks etc. are not considered data.

This report cannot be reproduced except in full, without prior written approval of the Company. Unless otherwise stated the results shown in this test report refer only to the sample(s) tested. This report is valid only with a valid digital signature. The digital signature may be available only under the Adobe software above version 7.0.

TABLE OF CONTENTS

GENERAL INFORMATION	4
PRODUCT DESCRIPTION FOR EQUIPMENT UNDER TEST (EUT).....	4
OBJECTIVE.....	4
TEST METHODOLOGY.....	4
MEASUREMENT UNCERTAINTY.....	5
TEST FACILITY.....	5
SYSTEM TEST CONFIGURATION	6
DESCRIPTION OF TEST CONFIGURATION.....	6
EUT EXERCISE SOFTWARE.....	6
SPECIAL ACCESSORIES.....	6
EQUIPMENT MODIFICATIONS.....	6
SUPPORT EQUIPMENT LIST AND DETAILS.....	6
EXTERNAL I/O CABLE.....	6
BLOCK DIAGRAM OF TEST SETUP.....	7
SUMMARY OF TEST RESULTS	8
TEST EQUIPMENT LIST	9
§2.1091- MAXIMUM PERMISSIBLE EXPOSURE (MPE)	10
APPLICABLE STANDARD.....	10
RESULT.....	10
FCC §2.1046 & §90.205 - RF Output Power	11
APPLICABLE STANDARD.....	11
TEST PROCEDURE.....	11
TEST DATA.....	11
FCC §2.1047 & §90.207 - MODULATION CHARACTERISTIC	19
APPLICABLE STANDARD.....	19
TEST PROCEDURE.....	19
TEST DATA.....	19
FCC §2.1049 & §90.209 & §90.210 – OCCUPIED BANDWIDTH & EMISSION MASK	25
APPLICABLE STANDARD.....	25
TEST PROCEDURE.....	25
TEST DATA.....	25
FCC §2.1051 & §90.210 - SPURIOUS EMISSIONS AT ANTENNA TERMINALS	39
APPLICABLE STANDARD.....	39
TEST PROCEDURE.....	39
TEST DATA.....	39
FCC §2.1053 & §90.210 - RADIATED SPURIOUS EMISSIONS	46
APPLICABLE STANDARD.....	46
TEST PROCEDURE.....	46
TEST DATA.....	46
FCC §2.1055 & §90.213 - FREQUENCY STABILITY	48
APPLICABLE STANDARD.....	48
TEST PROCEDURE.....	48
TEST DATA.....	48

FCC §90.214 - TRANSIENT FREQUENCY BEHAVIOR.....51
APPLICABLE STANDARD51
TEST PROCEDURE51
TEST DATA52

GENERAL INFORMATION

Product Description for Equipment under Test (EUT)

Product	Digital Repeater, VHF DMR(Digital Mobile Radio)
Tested Model	PR900 VHF
Frequency Range	136-174MHz
Rated Transmit Power	50Watts(High), 1Watt(Low)
Channel separation	12.5kHz
Modulation Technique	4FSK/FM
Antenna Specification	8.5dBi
Voltage Range	AC100-240V or DC 13.6V
Date of Test	2021-04-26 to 2021-05-06
Sample serial number	SZ1210412-10911E-RF-S_2DB (Assigned by BAACL, Shenzhen)
Received date	2021-04-12
Sample/EUT Status	Good condition

Objective

This test report is in accordance with Part 2, and Part 90 of the Federal Communication Commissions rules.

Test Methodology

All tests and measurements indicated in this document were performed in accordance with the Code of federal Regulations Title 47 Part 2, Sub-part J as well as the following individual parts:

Part 90 – Private Land Mobile Radio Service

Applicable Standards: TIA 603-E, ANSI C63.26-2015.

All emissions measurement was performed at Bay Area Compliance Laboratories Corp. (Shenzhen). The radiated testing was performed at an antenna-to-EUT distance of 3 meters.

Each test item follows test standards and with no deviation.

Measurement Uncertainty

Parameter		Uncertainty
Occupied Channel Bandwidth		±5%
RF Output Power with Power meter		±0.73dB
RF conducted test with spectrum		±1.6dB
Emissions, Radiated	Below 1GHz	±4.75dB
	Above 1GHz	±4.88dB
Temperature		±1 °C
Humidity		±6%
Supply voltages		±0.4%

Note: The extended uncertainty given in this report is obtained by combining the standard uncertainty times the coverage factor K with the 95% confidence interval. Otherwise required by the applicant or Product Regulations, Decision Rule in this report did not consider the uncertainty.

Test Facility

The Test site used by Bay Area Compliance Laboratories Corp. (Shenzhen) to collect test data is located on the 5F(B-West), 6F, 7F, the 3rd Phase of Wan Li Industrial Building D, Shihua Rd, FuTian Free Trade Zone, Shenzhen, China.

The test site has been approved by the FCC under the KDB 974614 D01 and is listed in the FCC Public Access Link (PAL) database, FCC Registration No. : 342867, the FCC Designation No. : CN1221.

The test site has been registered with ISED Canada under ISED Canada Registration Number 3062B.

SYSTEM TEST CONFIGURATION

Description of Test Configuration

The system was configured for testing in a test mode which has been done in the factory.

EUT Exercise Software

No exercise software was used.

Special Accessories

No special accessory was used.

Equipment Modifications

No modification was made to the EUT tested.

Support Equipment List and Details

Manufacturer	Description	Model	Serial Number
Dongguan Aohai Power Technology Co.,Ltd.	Adapter	A8-501000	A1906034835
PE	Load	PE2208-10	326598
Unknown	GPS Antenna	Unknown	98214
Unknown	Receiving Antenna	Unknown	323158
CALTTA TECHNOLOGIES CO.,LTD.	AUX	Unknown	123525
HIKVISION	Router	DS-3WR03-E	10021642429
BRL	USB Disk	DTSE9G2 32G	TEST9G2

External I/O Cable

Cable Description	Length (m)	From Port	To
Unshielded Un-detachable AC cable	1.2	EUT	Mains
Unshielded Un-detachable DC cable	1.2	Adapter	Router
Unshielded Detachable RJ45 cable	2.0	Router	EUT

Block Diagram of Test Setup

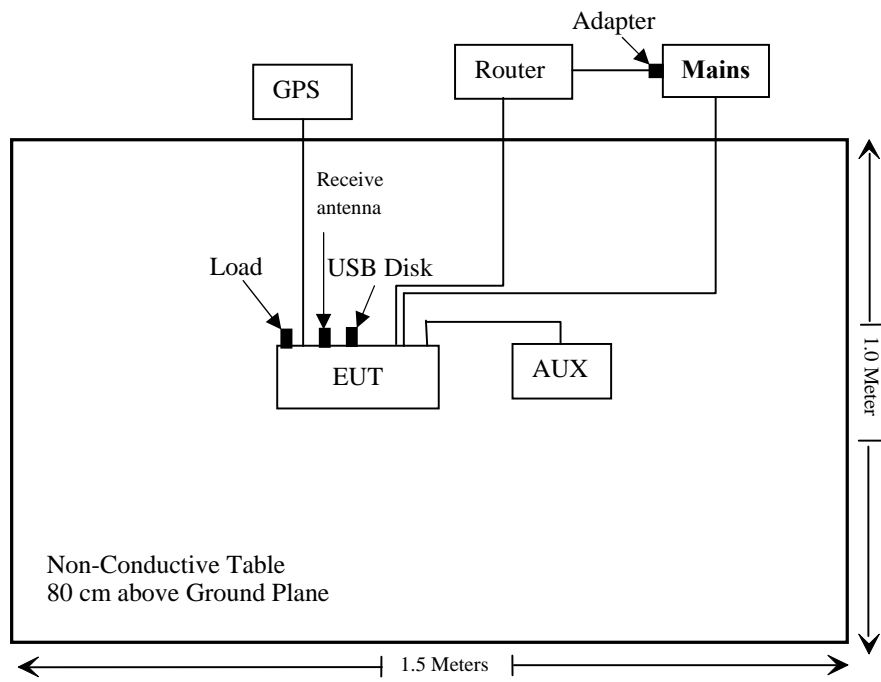

SUMMARY OF TEST RESULTS

FCC Rules	Description of Test	Results
§2.1091	Maximum Permissible Exposure(MPE)	Compliance
§2.1046; §90.205	RF Output Power	Compliance
§2.1047; §90.207	Modulation Characteristic	Compliance
§2.1049; §90.209; §90.210	Occupied Bandwidth & Emission Mask	Compliance
§2.1051;§90.210	Spurious Emission at Antenna Terminal	Compliance
§2.1053;§90.210	Spurious Radiated Emissions	Compliance
§2.1055;§90.213	Frequency Stability	Compliance
§90.214	Transient Frequency Behavior	Compliance

TEST EQUIPMENT LIST

Manufacturer	Description	Model	Serial Number	Calibration Date	Calibration Due Date
Radiated Emission Test					
R&S	EMI Test Receiver	ESR3	102455	2020/08/04	2021/08/03
Sonoma instrument	Pre-amplifier	310 N	186238	2020/08/04	2021/08/03
Sunol Sciences	Broadband Antenna	JB1	A040904-1	2020/12/22	2023/12/21
COM-POWER	Dipole Antenna	AD-100	721027	NCR	NCR
Unknow	Cable	Chamber Cable 1	F-03-EM236	2020/11/29	2021/11/28
Unknow	Cable	Chamber Cable 4	EC-007	2020/11/29	2021/11/28
Rohde & Schwarz	Spectrum Analyzer	FSV40-N	102259	2020/08/04	2021/08/03
Sunol Sciences	Horn Antenna	3115	9107-3694	2021/01/15	2024/01/14
A.H.System	Horn Antenna	SAS-200/571	135	2018/9/1	2021/8/31
Insulted Wire Inc.	RF Cable	SPS-2503-3150	02222010	2020/11/29	2021/11/28
Unknow	RF Cable	W1101-EQ1 OUT	F-19-EM005	2020/11/29	2021/11/28
Agilent	Signal Generator	N5183A	MY51040755	2020/12/4	2021/12/4
Unknown	Pass filter	NHP-250	F-03-EM131	2020/11/29	2021/11/28
RF Conducted Test					
Unknown	RF Cable	Unknown	DLO J5/W6102	2020/11/29	2021/11/28
Unknown	RF Cable	Unknown	8082176/W6111	2020/11/29	2021/11/28
Rohde & Schwarz	SPECTRUM ANALYZER	FSU26	200120	2021/04/03	2022/04/02
Rohde & Schwarz	Signal Analyzer	FSIQ26	837405/023	2021/4/24	2022/4/24
Weinschel	Power divider	1515	MY628	2020/11/29	2021/11/28
HP Agilent	RF Communication test set	8920B	3325U00859	2020/08/04	2021/08/03
Unknown	30dB Attenuator	50FH-030-100 RF	1.7000672E11	2020/11/29	2021/11/28
ESPEC	Temperature & Humidity Chamber	EL-10KA	9107726	2020/12/21	2021/12/21
Long Wei	DC Power Supply	TPR-6420D	398363	NCR	NCR
Piaobian	Voltage Regulator	TDGC2-3	S0120	NCR	NCR
Fluke	Digital Multimeter	287	19000011	2020/07/23	2021/07/22
Unknown	Pass filter	NHP-250	F-03-EM131	2020/11/29	2021/11/28

* **Statement of Traceability:** Bay Area Compliance Laboratories Corp. (Shenzhen) attests that all calibrations have been performed in accordance to requirements that traceable to National Primary Standards and International System of Units (SI).

§2.1091- MAXIMUM PERMISSIBLE EXPOSURE (MPE)

Applicable Standard

According to subpart 2.1091 systems operating under the provisions of this section shall be operated in a manner that ensures the public is not exposed to RF energy level in excess of the communication guidelines.

Limits for Occupational/Controlled Exposure

Limits for General Population/Uncontrolled Exposure				
Frequency Range (MHz)	Electric Field Strength (V/m)	Magnetic Field Strength (A/m)	Power Density (mW/cm ²)	Averaging Time (Minutes)
0.3-1.34	614	1.63	*(100)	6
1.34-30	1824/f	4.89/f	*(900/f ²)	6
30-300	61.4	0.163	1.0	6
300-1500	/	/	f/300	6
1500-100,000	/	/	5.0	6

f = frequency in MHz

* = Plane-wave equivalent power density

Result

Calculated Formulary:

Predication of MPE limit at a given distance

$$S = \frac{PG}{4\pi R^2}$$

S = power density (in appropriate units, e.g. mW/cm²)

P = power input to the antenna (in appropriate units, e.g., mW).

G = power gain of the antenna in the direction of interest relative to an isotropic radiator, the power gain factor, is normally numeric gain.

R = distance to the center of radiation of the antenna (appropriate units, e.g., cm)

Frequency (MHz)	Antenna Gain		Max Tune Up Output Power	MPE Limit (mW/cm ²)	Minimum Distance (cm)
	(dBi)	(numeric)	(W)		
136-174	8.5	7.08	28.1	1.0	126

Note: The maximum tune-up output power is 47.5dBm (56.2W), 50% duty cycle was used, so maximum tune-up output power is 28.1W

To maintain compliance with the FCC's RF exposure guidelines, place the equipment at least 126cm from nearby persons.

Result: compliance.

FCC §2.1046 & §90.205 - RF Output Power

Applicable Standard

FCC §2.1046 and §90.205

Test Procedure

Conducted RF Output Power:

The RF output of the transmitter was connected to the input of the spectrum analyzer through sufficient attenuation.

Spectrum Analyzer Setting:

<u>R B/W</u>	<u>Video B/W</u>
100 kHz	300 kHz

Test Data

Environmental Conditions

Temperature:	25 °C
Relative Humidity:	52 %
ATM Pressure:	101.0 kPa

The testing was performed by Blaker Zhang on 2021-04-26.

Test Mode: Transmitting

Test Result: Pass. Please refer to following table.

Conducted Output Power

Mode	Frequency Spacing (kHz)	Frequency (MHz)	Power level	Output (dBm)	Output Power (W)	Note
Digital	12.5	136.15	L	30.13	1.03	FCC 90
			H	46.98	49.89	
	12.5	155.15	L	30.44	1.11	
			H	47.14	51.76	
	12.5	173.15	L	30.58	1.14	
			H	47.17	52.12	
Analog	12.5	136.15	L	30.15	1.04	
			H	47.00	50.12	
	12.5	155.15	L	30.46	1.11	
			H	47.11	51.40	
	12.5	173.15	L	30.67	1.17	
			H	47.25	53.09	

Rated high power: 50W (40~60W)

Rated low power: 1W (0.8~1.2W)

Digital:

Frequency 136.15 MHz, Low Power

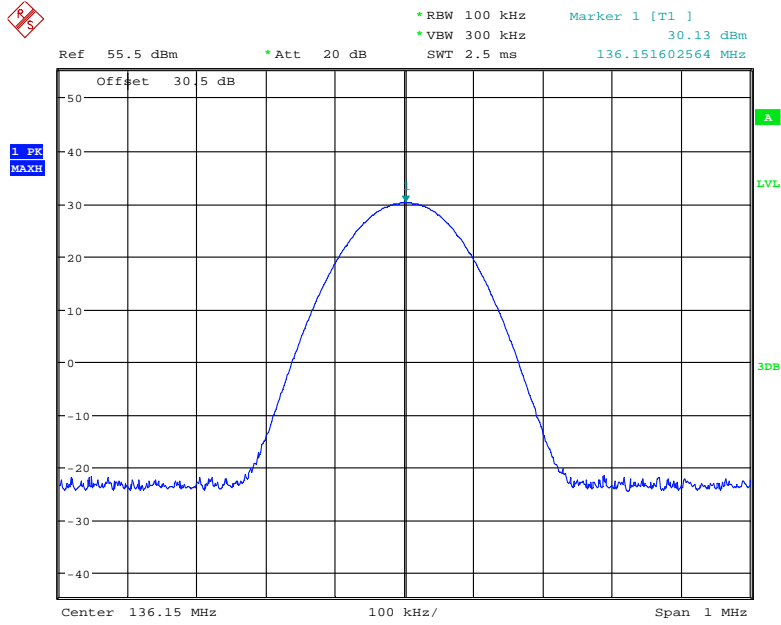

Date: 26.APR.2021 19:49:12

Frequency 136.15 MHz, High Power

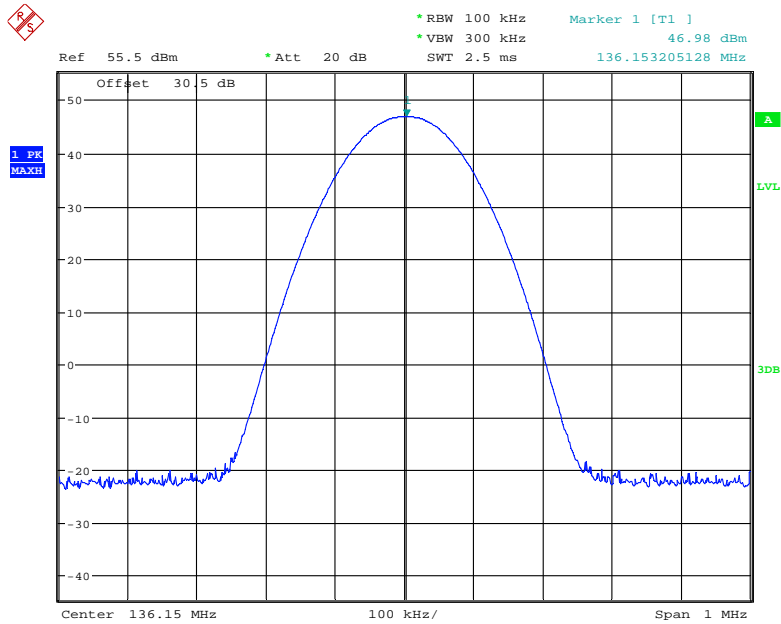

Date: 26.APR.2021 19:48:17

Frequency 155.15 MHz, Low Power

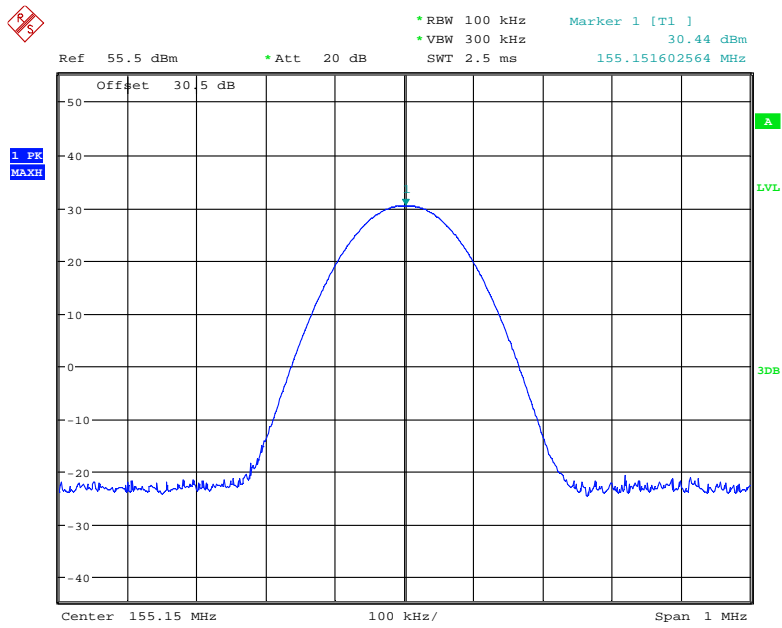

Date: 26.APR.2021 19:47:06

Frequency 155.15 MHz, High Power

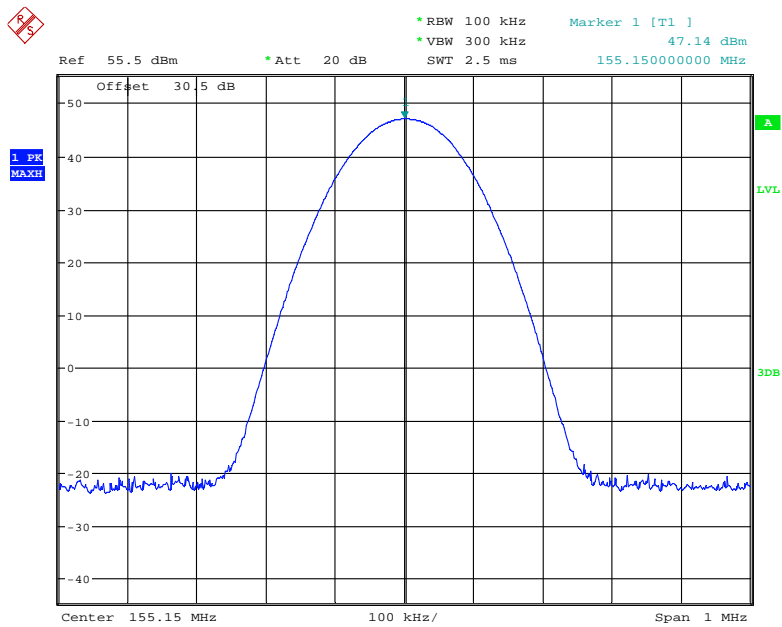

Date: 26.APR.2021 19:46:04

Frequency 173.15 MHz, Low Power

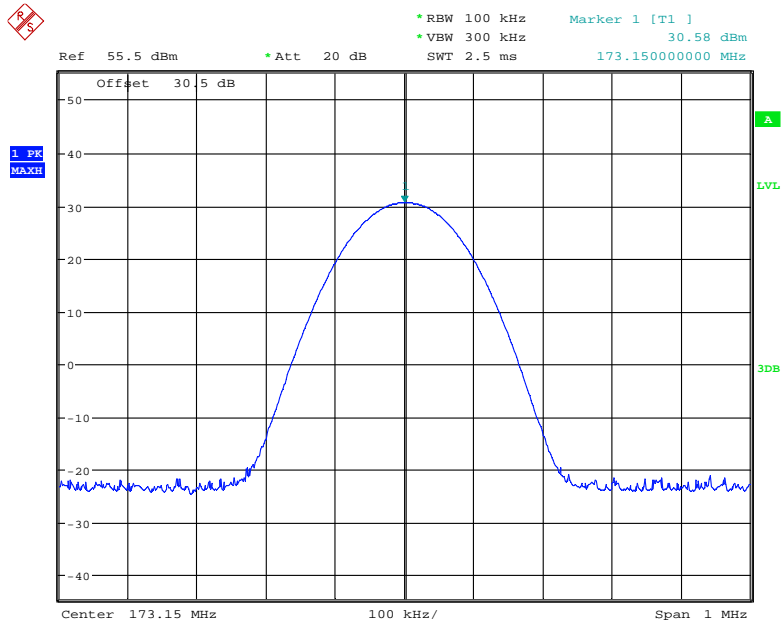

Date: 26.APR.2021 19:45:14

Frequency 173.15 MHz, High Power

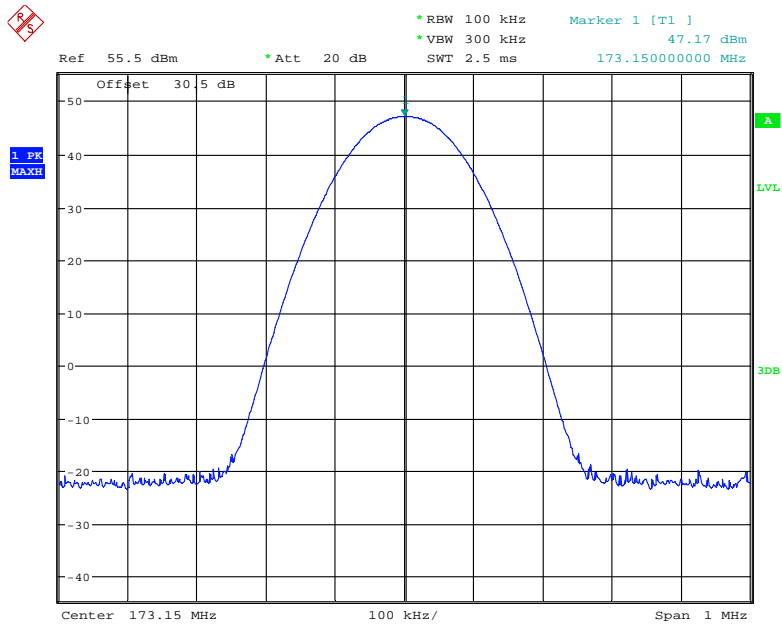

Date: 26.APR.2021 19:44:06

Analog:

Frequency 136.15 MHz, Low Power

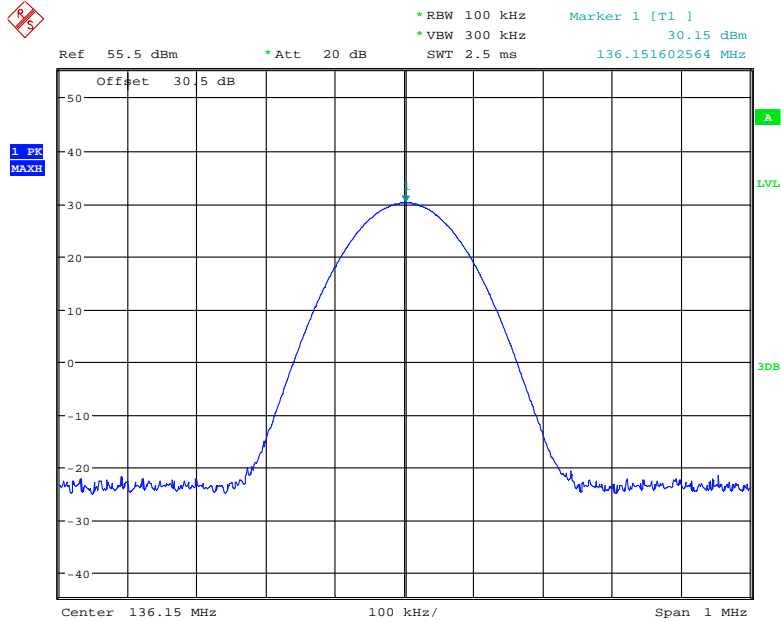

Date: 26.APR.2021 19:41:55

Frequency 136.15 MHz, High Power

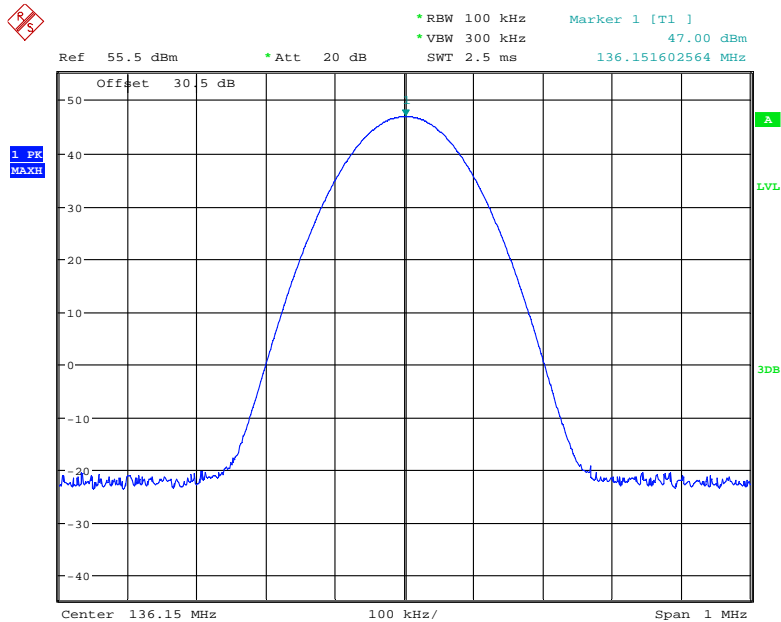

Date: 26.APR.2021 19:41:12

Frequency 155.15 MHz, Low Power

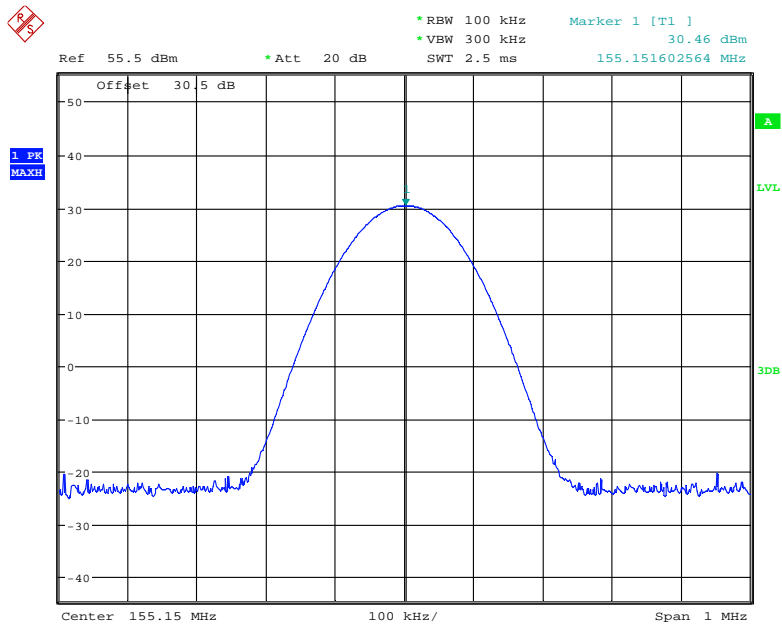

Date: 26.APR.2021 19:40:06

Frequency 155.15 MHz, High Power

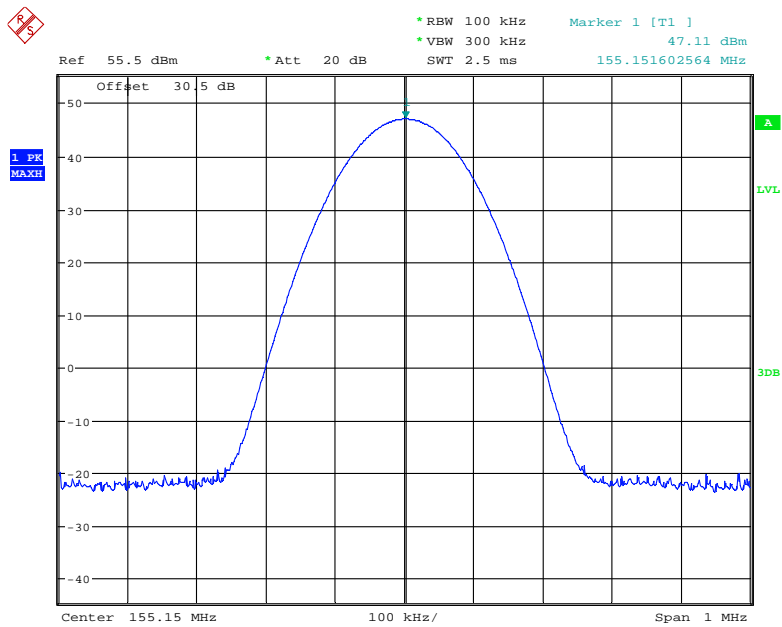

Date: 26.APR.2021 19:39:20

Frequency 173.15 MHz, Low Power

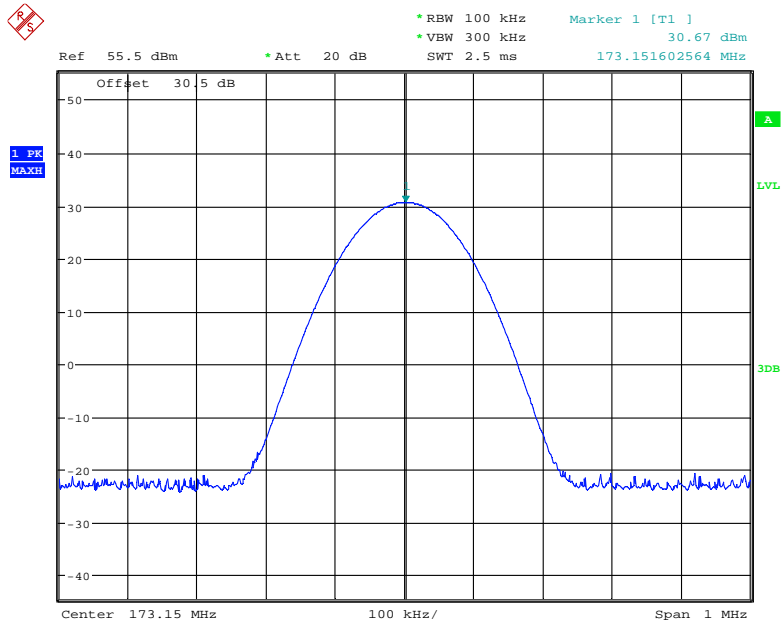

Date: 26.APR.2021 19:38:11

Frequency 173.15 MHz, High Power

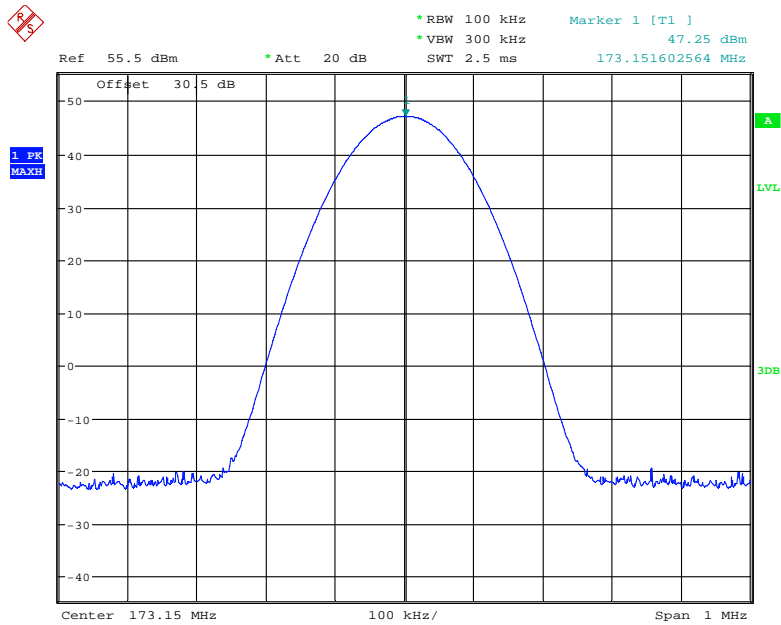

Date: 26.APR.2021 19:36:22

FCC §2.1047 & §90.207 - MODULATION CHARACTERISTIC

Applicable Standard

FCC§2.1047 and §90.207:

- (a) Equipment which utilizes voice modulated communication shall show the frequency response of the audio modulating circuit over a range of 100 to 5000 Hz. for equipment which is required to have a low pass filter, the frequency response of the filter, or all of the circuitry installed between the modulation limited and the modulated stage shall be supplied.
- (b) Equipment which employs modulation limiting, a curve showing the percentage of modulation versus the modulation input voltage shall be supplied.

Test Procedure

Test Method: ANSI C63.26-2015

Test Data

Environmental Conditions

Temperature:	25 °C
Relative Humidity:	52 %
ATM Pressure:	101.0 kPa

The testing was performed by Blaker Zhang on 2021-04-27.

Test Mode: Transmitting

Test Result: *Pass. Please refer to the following tables and plots.*

Analog Modulation:

MODULATION LIMITING

Carrier Frequency: 155.15MHz, Channel Separation=12.5 kHz

Audio Frequency (Hz)	Instantaneous		Steady-state		FCC Limit [kHz]
	DEVIATION (@+20dB) [kHz]	DEVIATION (@-20dB) [kHz]	DEVIATION (@+20dB) [kHz]	DEVIATION (@-20dB) [kHz]	
300	2.018	0.060	1.988	0.030	2.500
400	2.176	0.071	2.136	0.041	2.500
500	2.165	0.084	2.135	0.044	2.500
600	2.141	0.098	2.112	0.068	2.500
700	2.155	0.116	2.134	0.089	2.500
800	2.161	0.133	2.142	0.104	2.500
900	2.148	0.149	2.121	0.119	2.500
1000	2.143	0.161	2.112	0.125	2.500
1200	2.141	0.201	2.113	0.184	2.500
1400	2.138	0.229	2.098	0.201	2.500
1600	2.147	0.245	2.106	0.212	2.500
1800	2.161	0.276	2.123	0.236	2.500
2000	2.198	0.310	2.168	0.286	2.500
2100	2.203	0.318	2.182	0.294	2.500
2200	2.231	0.335	2.198	0.301	2.500
2300	2.229	0.346	2.186	0.310	2.500
2400	2.244	0.356	2.204	0.321	2.500
2500	2.240	0.366	2.210	0.334	2.500
2600	2.247	0.393	2.217	0.369	2.500
2700	2.253	0.408	2.215	0.387	2.500
2800	2.263	0.424	2.243	0.401	2.500
2900	2.267	0.436	2.227	0.412	2.500
3000	2.281	0.428	2.251	0.409	2.500

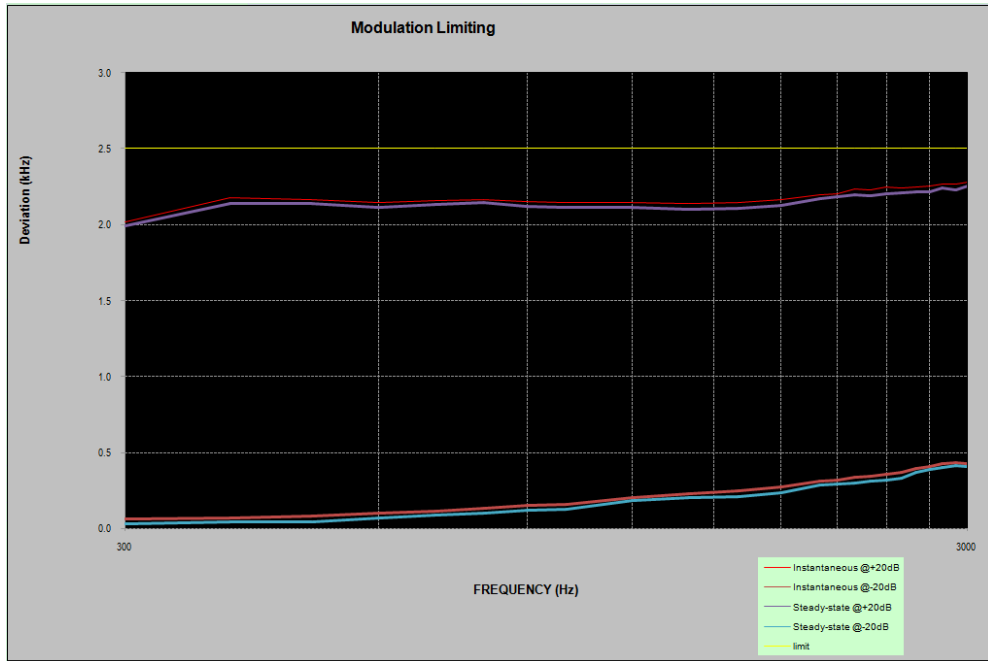

Audio Frequency Response

Carrier Frequency: 155.15MHz, Channel Separation=12.5 kHz

Audio Frequency (Hz)	Response Attenuation (dB)
300	-9.37
400	-7.54
500	-5.92
600	-4.50
700	-3.07
800	-1.87
900	-0.88
1000	0.00
1200	1.76
1400	2.81
1600	3.88
1800	4.78
2000	5.23
2100	6.14
2200	6.55
2300	7.39
2400	7.17
2500	7.52
2600	7.99
2700	8.36
2800	8.58
2900	8.91
3000	8.76

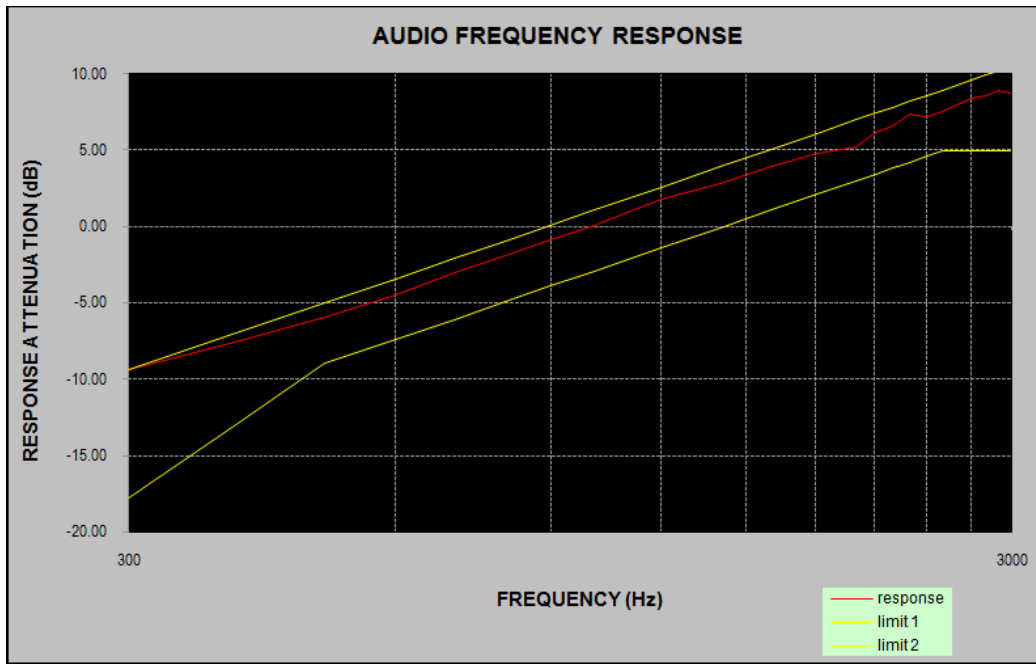

Audio frequency lows pass filter response

Carrier Frequency: 155.15MHz, Channel Separation=12.5 kHz

Audio Frequency (kHz)	Response Attenuation (dB)	Limit (dB)
1.0	0.0	/
3.0	-21.8	0.0
4.0	-79.7	-12.5
5.0	-87.8	-22.2
6.0	-89.1	-30.1
7.0	-88.9	-36.8
8.0	-88.7	-42.6
9.0	-88.5	-47.7
10.0	-89.4	-52.3
12.0	-93.8	-60.2
14.0	-94.9	-66.9
16.0	-94.6	-72.7
18.0	-94.7	-77.8
20.0	-93.6	-82.5

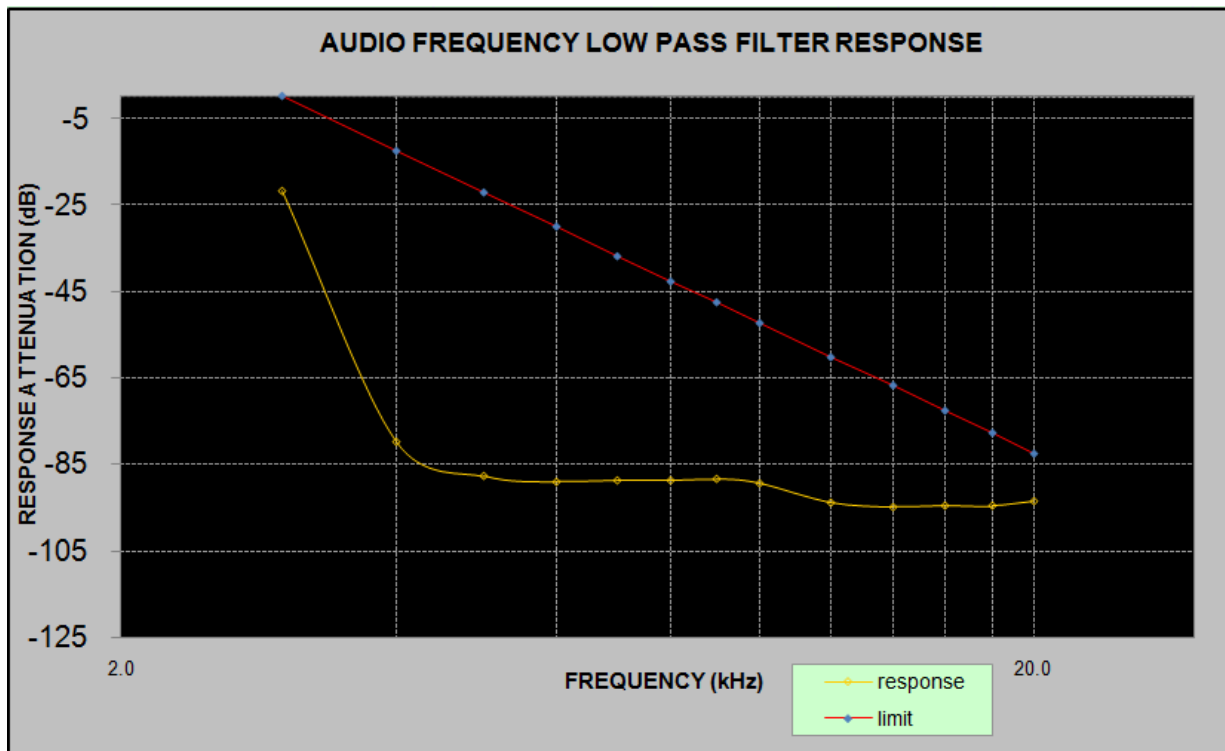

FCC §2.1049 & §90.209 & §90.210 – OCCUPIED BANDWIDTH & EMISSION MASK

Applicable Standard

FCC §2.1049 and §90.210

Emission Mask D - 12.5 kHz channel bandwidth equipment. For transmitters designed to operate with a 12.5 kHz channel bandwidth, any emission must be attenuated below the power (P) of the highest emission contained within the authorized bandwidth as follows:

- 1) For any frequency removed from the center of the authorized bandwidth f_0 to 5.625 kHz removed from f_0 , 0dB.
- 2) On any frequency removed from the center of the authorized bandwidth by a displacement frequency (f_d in kHz) of more than 5.626 kHz but no more than 12.5 kHz, at least $7.27 (f_d - 2.88)$ dB.
- 3) On any frequency removed from the center of the authorized bandwidth by a displacement frequency (f_d in kHz) of more than 12.5 kHz at least: At least $50 + 10 \log (P)$ dB or 70 dB, whichever is the lesser attenuation.

Test Procedure

The RF output of the transmitter was connected to the input of the spectrum analyzer through sufficient attenuation.

The resolution bandwidth of the spectrum analyzer was set at 100 Hz and the spectrum was recorded in the frequency band ± 50 kHz from the carrier frequency.

Test Data

Environmental Conditions

Temperature:	23~26 °C
Relative Humidity:	52~56 %
ATM Pressure:	101.0 kPa

The testing was performed by Blaker Zhang from 2021-04-26 and 2021-05-11.

Test mode: transmitting

Test Result: *Pass. Please refer to the following tables and plots.*

Modulation	Channel Separation (kHz)	Frequency (MHz)	Power Level	99% Occupied Bandwidth (kHz)	26 dB Emissions Bandwidth (kHz)
Analog	12.5	136.15	L	10.016	10.256
	12.5		H	10.016	10.256
	12.5	155.15	L	10.016	10.256
	12.5		H	10.016	10.256
	12.5	173.15	L	10.016	10.256
	12.5		H	10.016	10.256
Digital	12.5	136.15	L	7.772	9.359
	12.5		H	7.853	9.359
	12.5	155.15	L	7.692	9.279
	12.5		H	7.692	9.215
	12.5	173.15	L	7.692	9.215
	12.5		H	7.853	9.487

Note: Emission designator is base on calculation instead of measurement.

Emission Designator Per CFR 47 §2.201 & §2.202, $B_n = 2M + 2D$

For FM Mode (Channel Spacing: 12.5 kHz)

Emission Designator 11K0F3E. In this case, the maximum modulating frequency is 3.0 kHz with a 2.5 kHz deviation. $BW = 2(M+D) = 2*(3.0 \text{ kHz} + 2.5 \text{ kHz}) = 11 \text{ kHz} \rightarrow 11K0$

F3E portion of the designator represents an FM voice transmission Therefore, the entire designator for 12.5 kHz channel spacing FM mode is 11K0F3E.

For Digital Mode (Channel Spacing: 12.5 kHz)

Emission Designator 7K60F1D and 7K60F1E

The 99% energy rule (title 47CFR 2.1049) was used for digital mode. It basically states that 99% of the modulation energy falls within X kHz, in this case, 7.60 kHz. The emission mask was obtained from 47CFR 90.210(d).

F1D and F1E portion of the designator indicates digital information.

Therefore, the entire designator for 12.5 kHz channel spacing digital mode is 7K60F1D and 7K60F1E.

Digital:

Frequency 136.15 MHz: 99% Occupied & 26 dB Bandwidth, Low Power

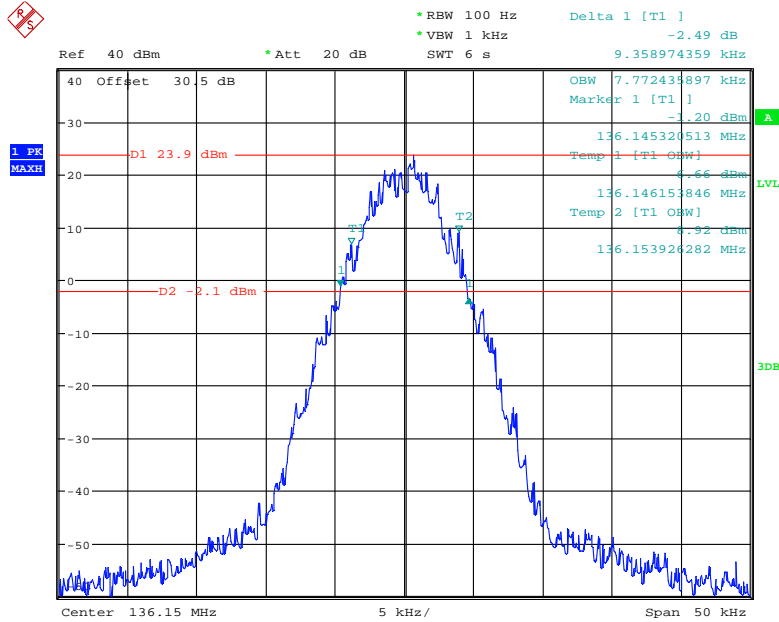

Date: 26.APR.2021 23:31:45

Frequency 136.15 MHz: 99% Occupied & 26 dB Bandwidth, High Power

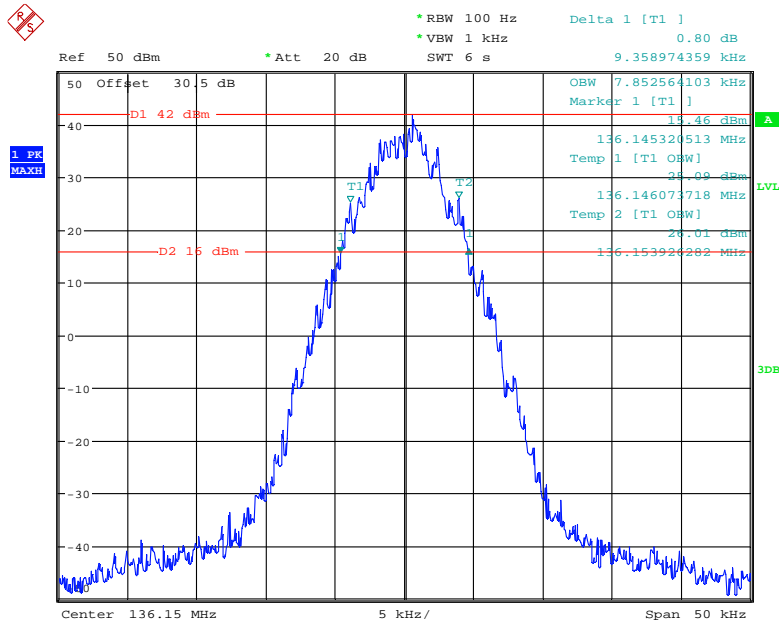

Date: 26.APR.2021 23:28:31

Frequency 155.15 MHz: Occupied & 26 dB Bandwidth, Low Power

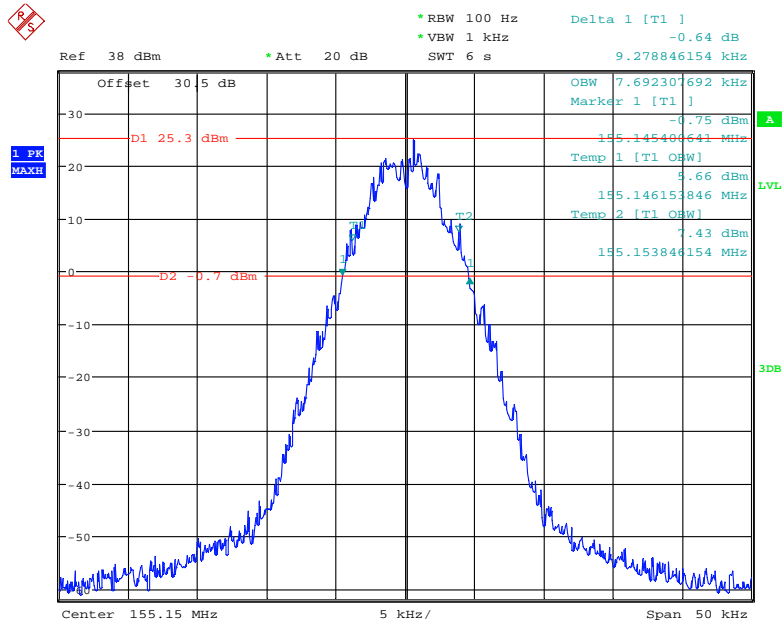

Date: 26.APR.2021 23:04:14

Frequency 155.15 MHz: Occupied & 26 dB Bandwidth, Low Power

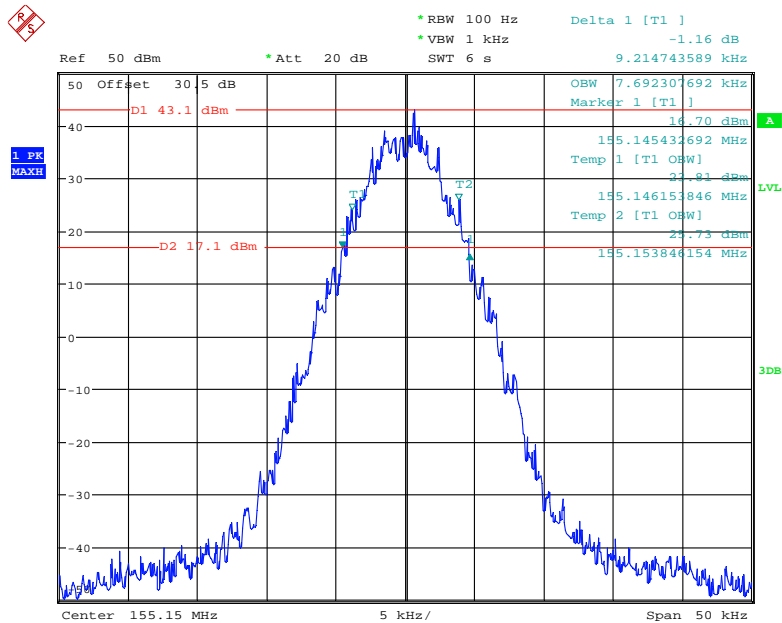

Date: 26.APR.2021 23:26:08

Frequency 173.15 MHz: 99% Occupied & 26 dB Bandwidth, Low Power

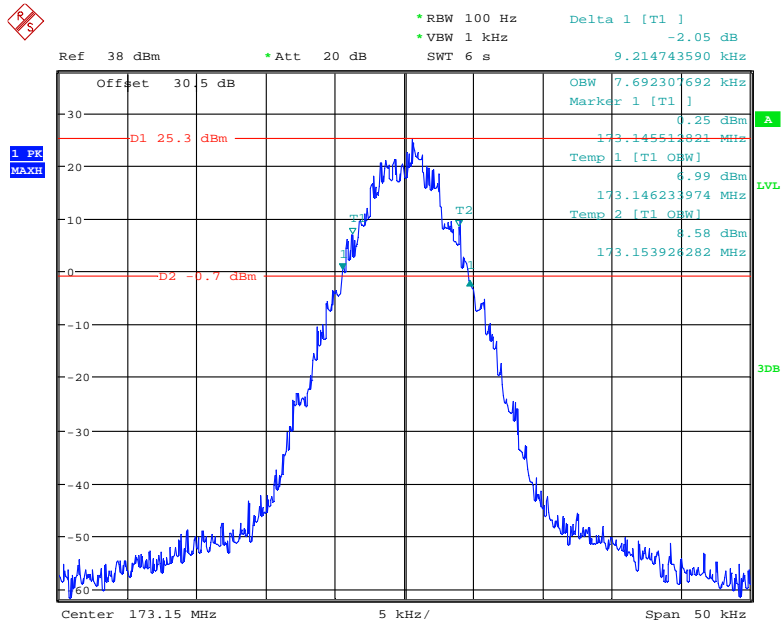

Date: 6.MAY.2021 19:51:14

Frequency 173.15 MHz: 99% Occupied & 26 dB Bandwidth, High Power

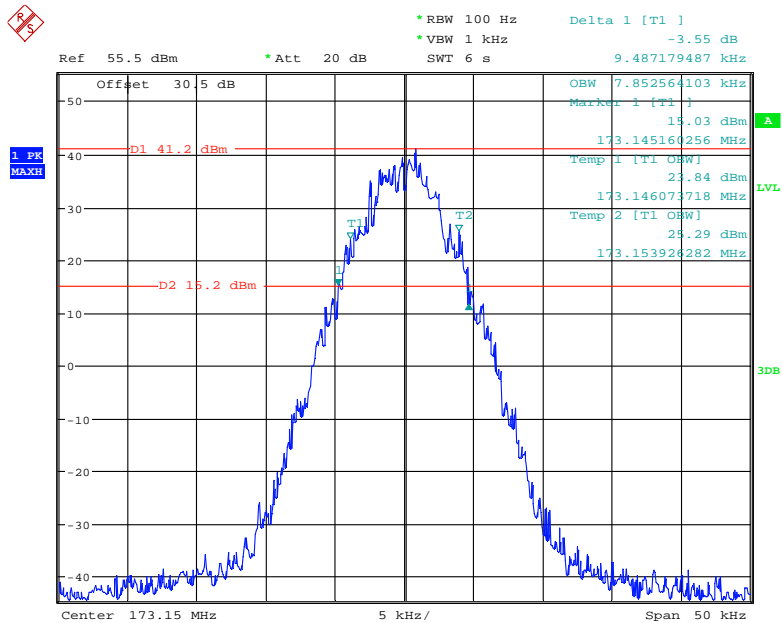

Date: 26.APR.2021 22:55:14

Frequency 136.15 MHz: Emission Mask D, Low Power

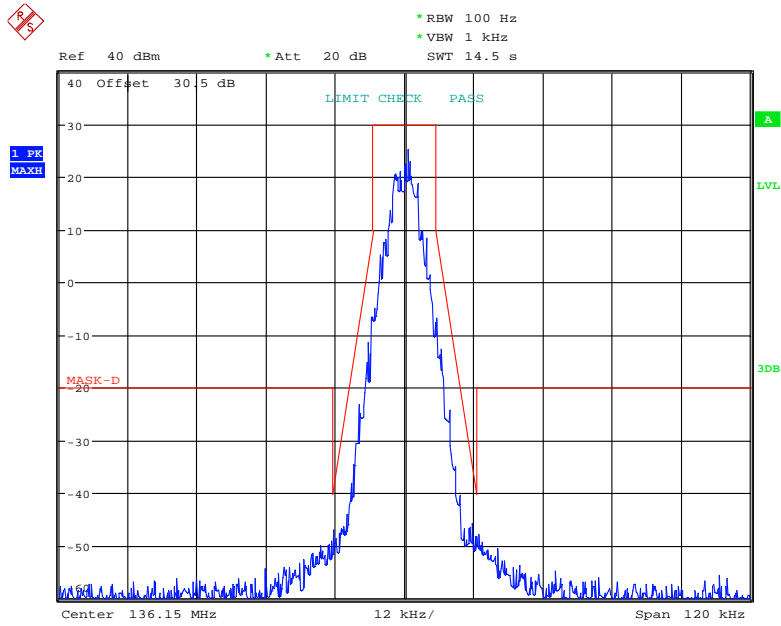

Date: 26.APR.2021 22:28:44

Frequency 136.15 MHz: Emission Mask D, High Power

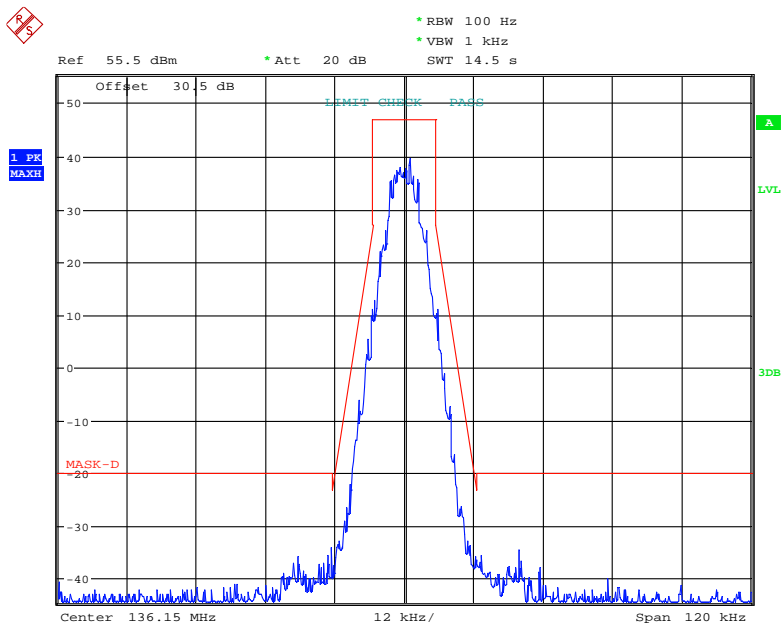

Date: 11.MAY.2021 22:33:15

Frequency 155.15 MHz: Emission Mask D, Low Power

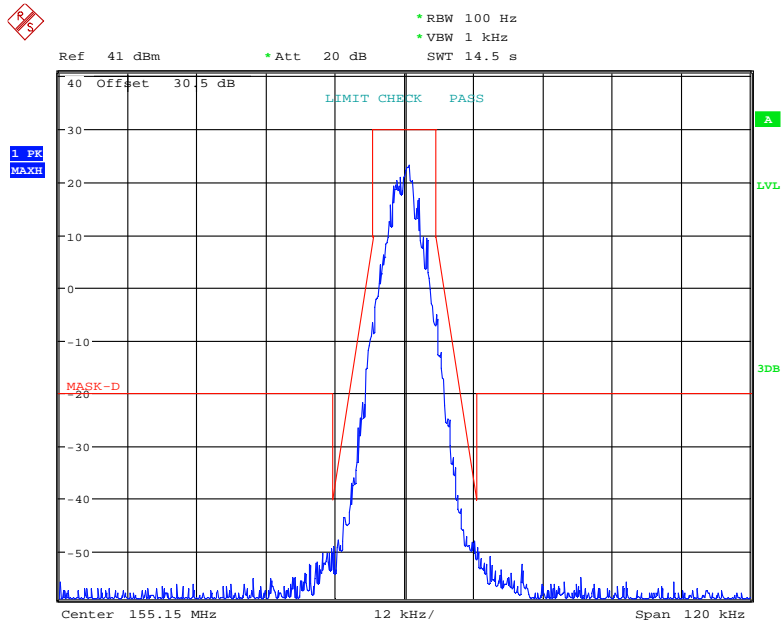

Date: 26.APR.2021 22:38:22

Frequency 155.15 MHz: Emission Mask D, High Power

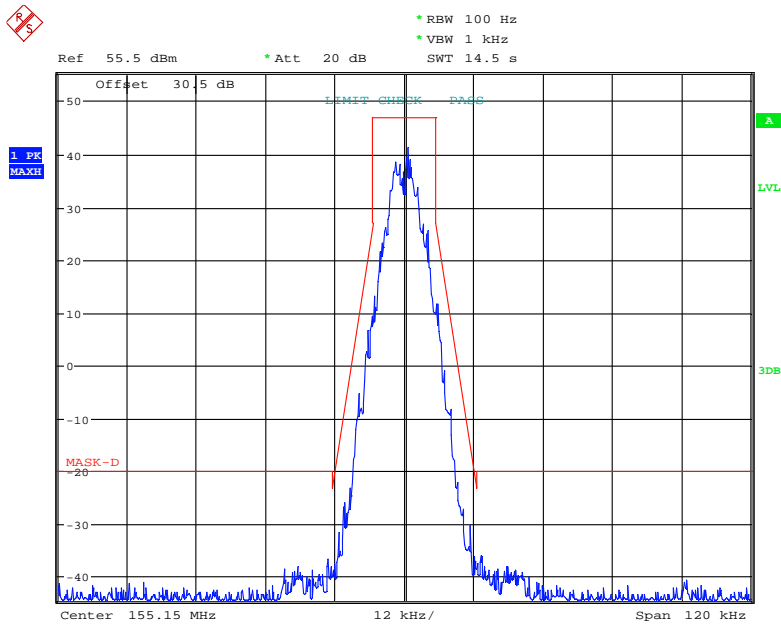

Date: 11.MAY.2021 22:35:04

Frequency 173.15 MHz: Emission Mask D, Low Power

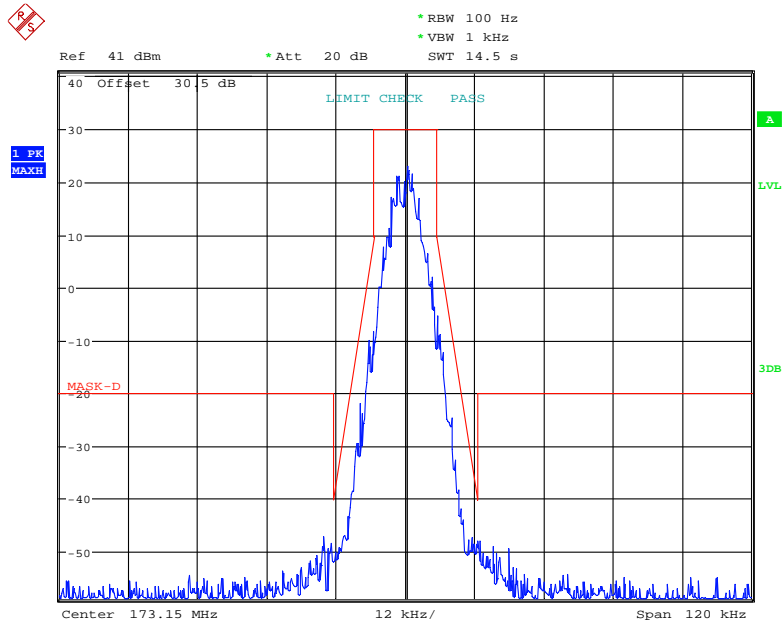

Date: 26.APR.2021 22:40:33

Frequency 173.15 MHz: Emission Mask D, High Power

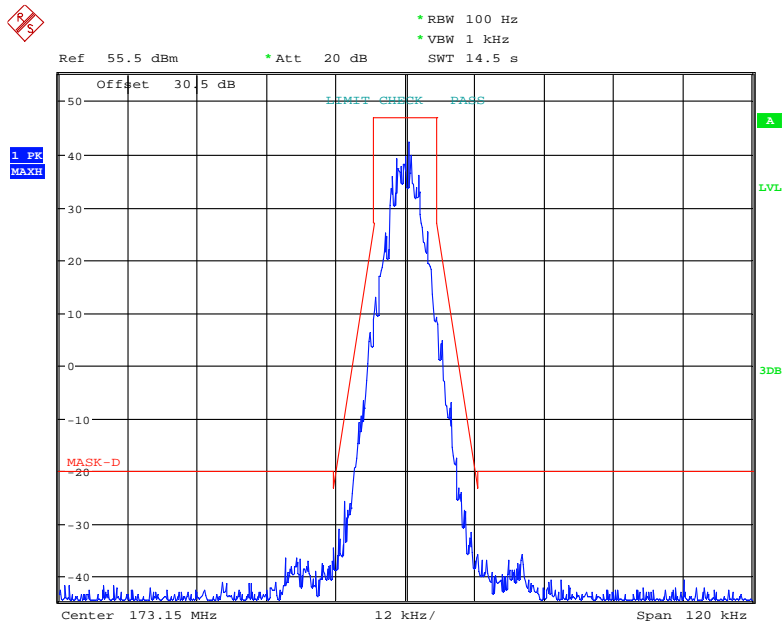

Date: 11.MAY.2021 22:40:12

Analog:

Frequency 136.15 MHz: 99% Occupied & 26 dB Bandwidth, Low Power

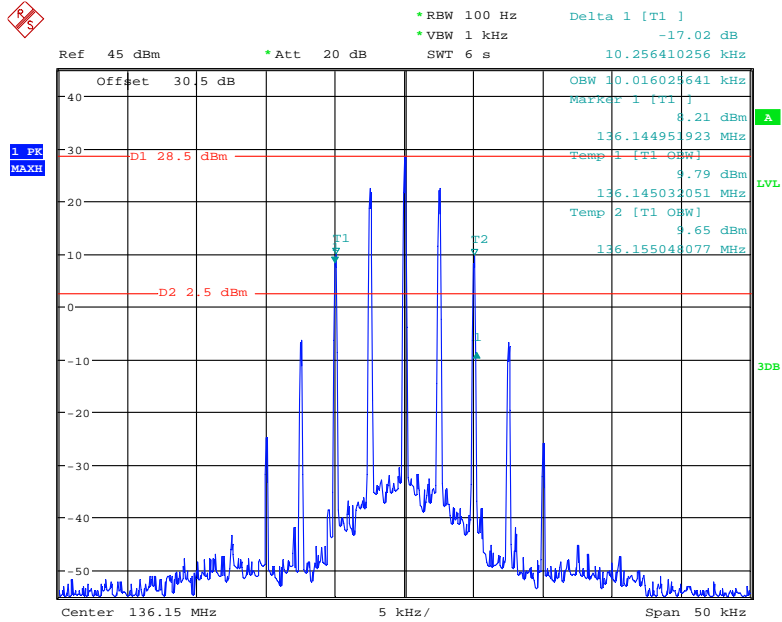

Date: 6.MAY.2021 19:35:08

Frequency 136.15 MHz: 99% Occupied & 26 dB Bandwidth, High Power

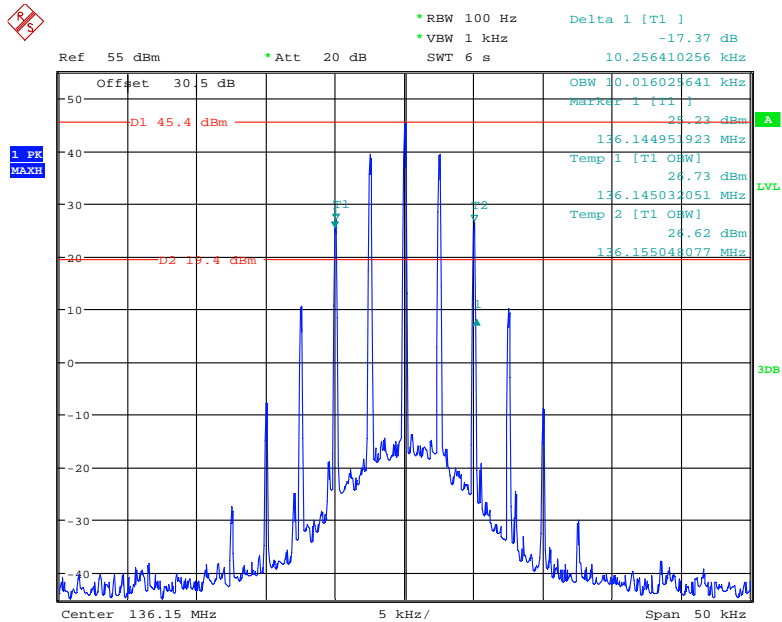

Date: 6.MAY.2021 19:32:54

Frequency 155.15 MHz: Occupied & 26 dB Bandwidth, Low Power

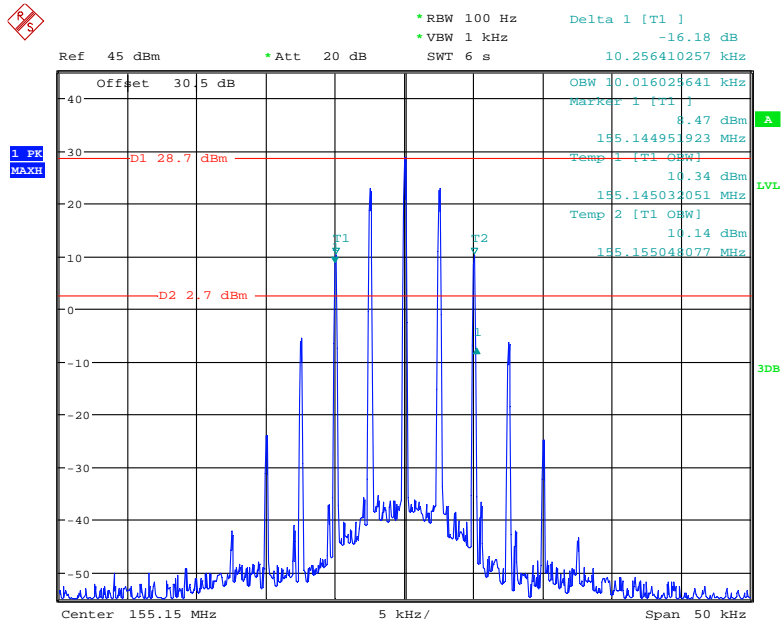

Date: 6.MAY.2021 19:37:19

Frequency 155.15 MHz: Occupied & 26 dB Bandwidth, Low Power

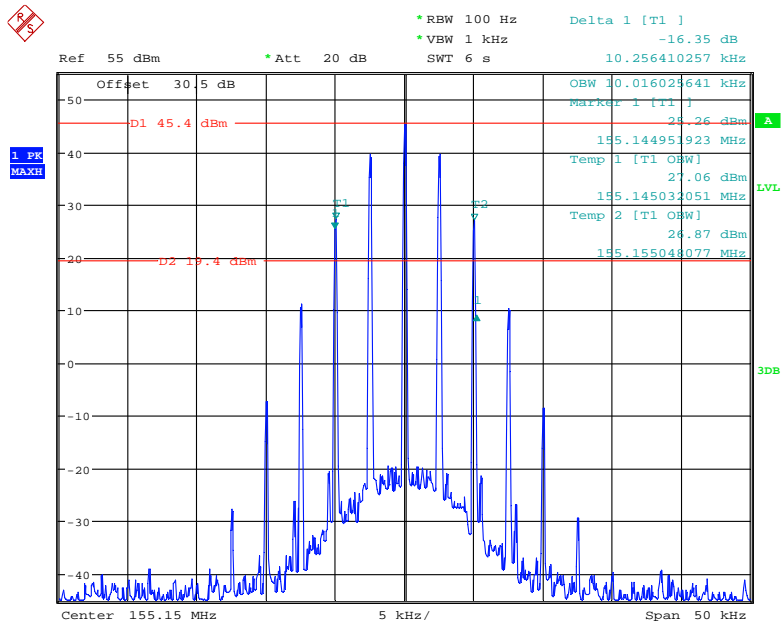

Date: 6.MAY.2021 19:38:48

Frequency 173.15 MHz: 99% Occupied & 26 dB Bandwidth, Low Power

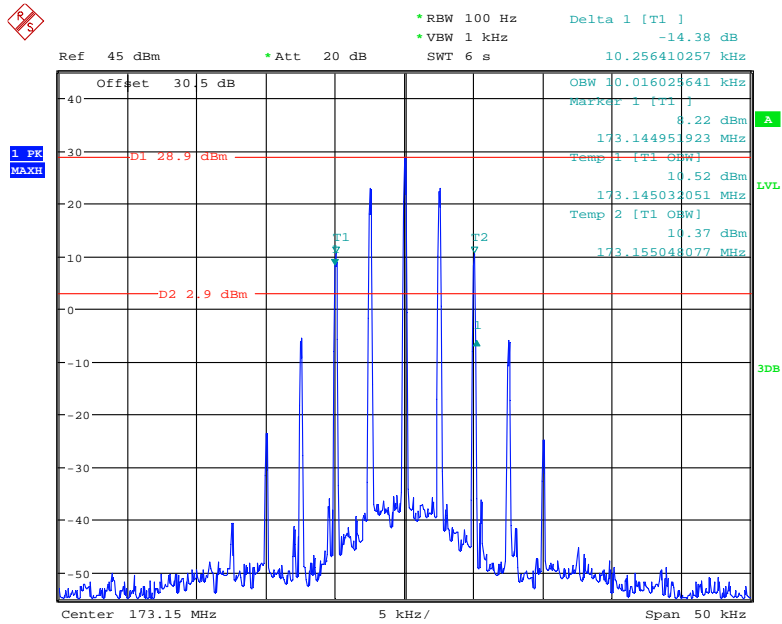

Date: 6.MAY.2021 19:43:06

Frequency 173.15 MHz: 99% Occupied & 26 dB Bandwidth, High Power

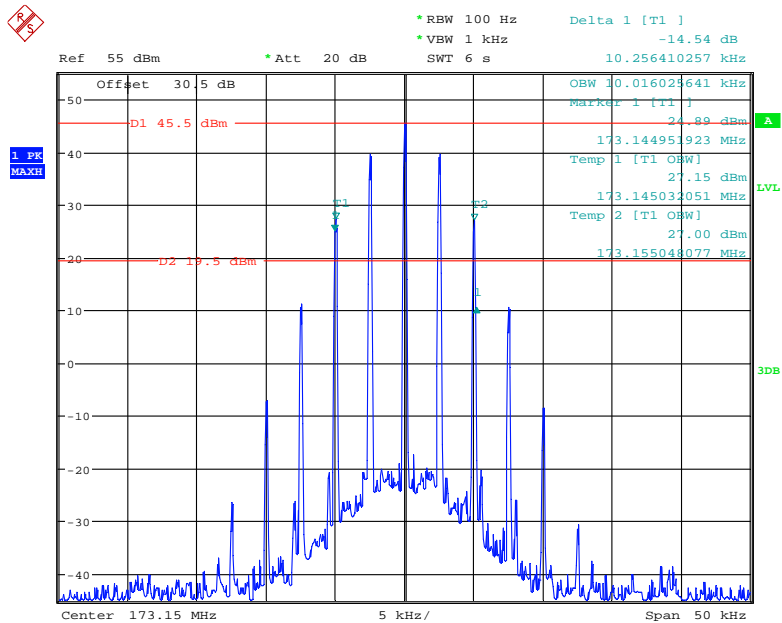

Date: 6.MAY.2021 19:41:08

Frequency 136.15 MHz: Emission Mask D, Low Power

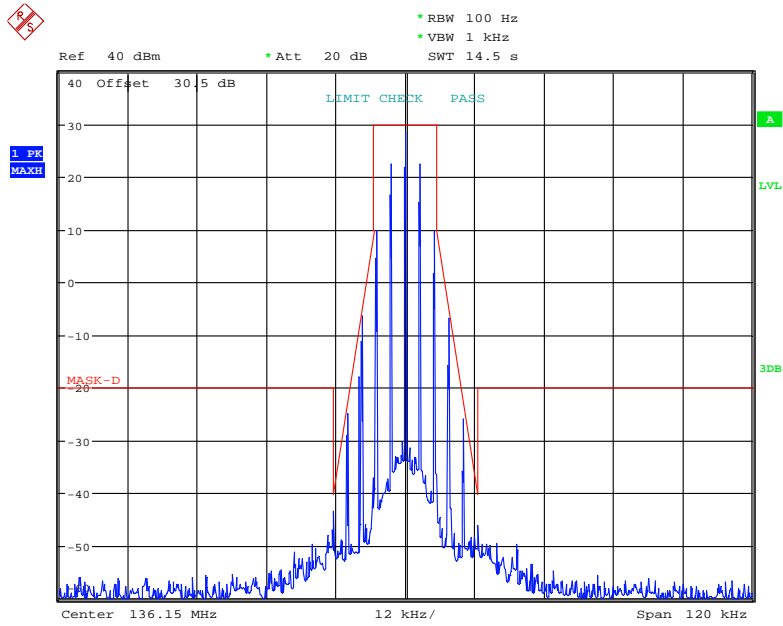

Date: 11.MAY.2021 22:25:10

Frequency 136.15 MHz: Emission Mask D, High Power

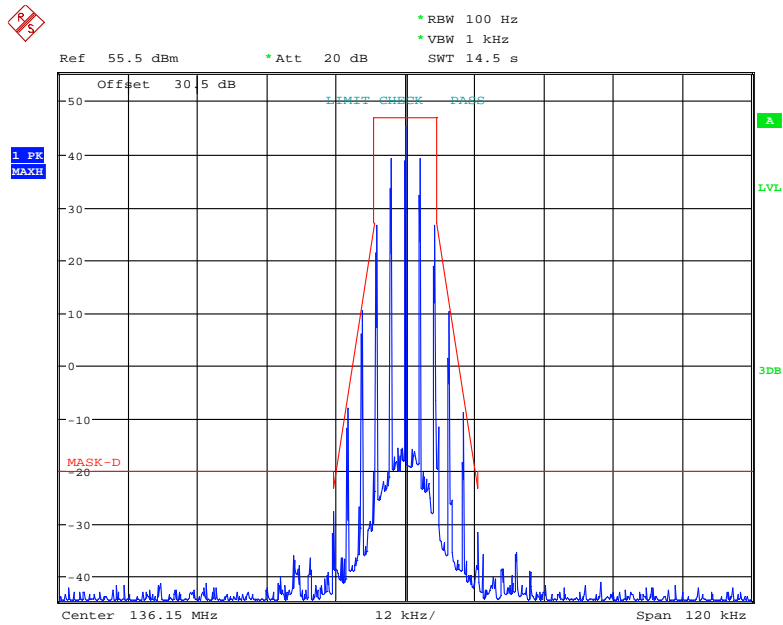

Date: 11.MAY.2021 22:12:46

Frequency 155.15 MHz: Emission Mask D, Low Power

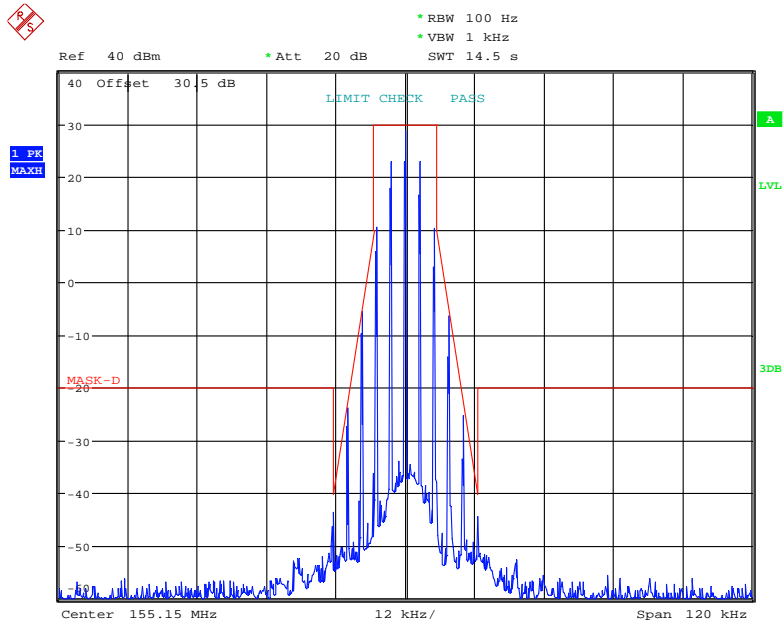

Date: 11.MAY.2021 22:23:28

Frequency 155.15 MHz: Emission Mask D, High Power

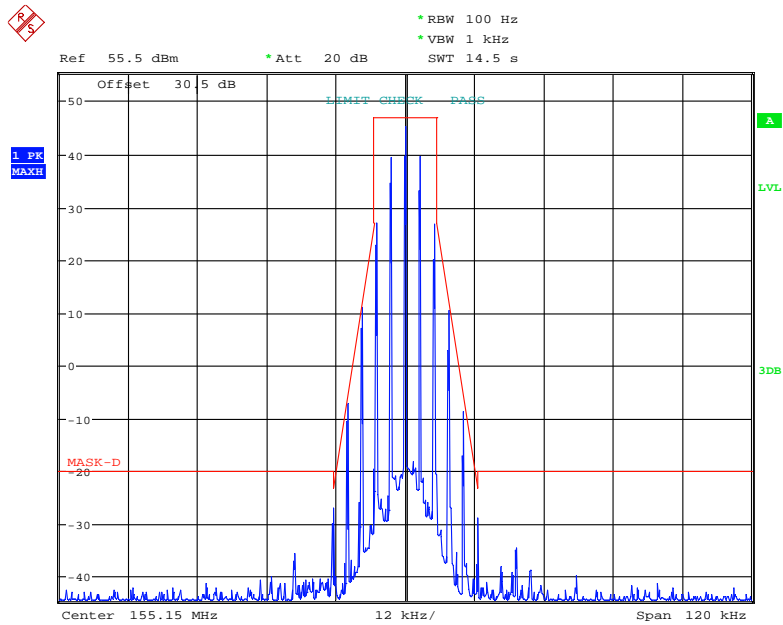

Date: 11.MAY.2021 22:11:08

Frequency 173.15 MHz: Emission Mask D, Low Power

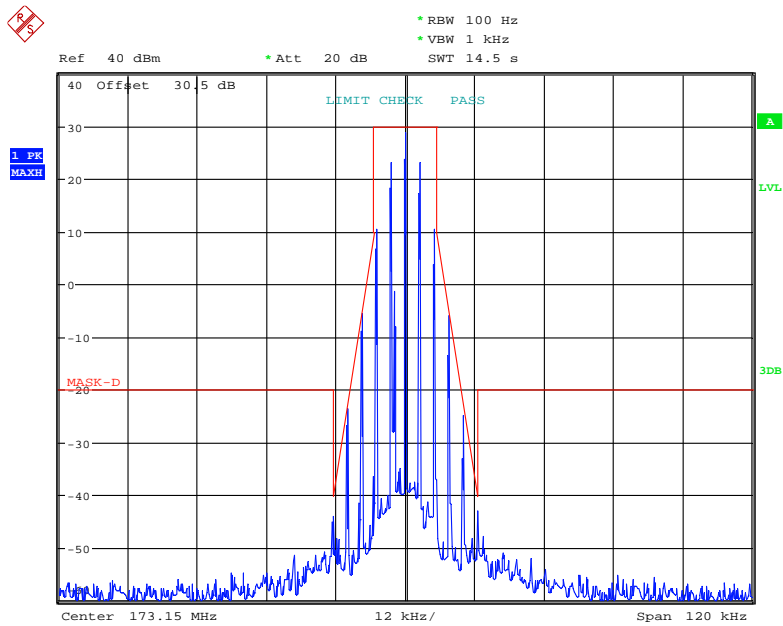

Date: 11.MAY.2021 22:17:41

Frequency 173.15 MHz: Emission Mask D, High Power

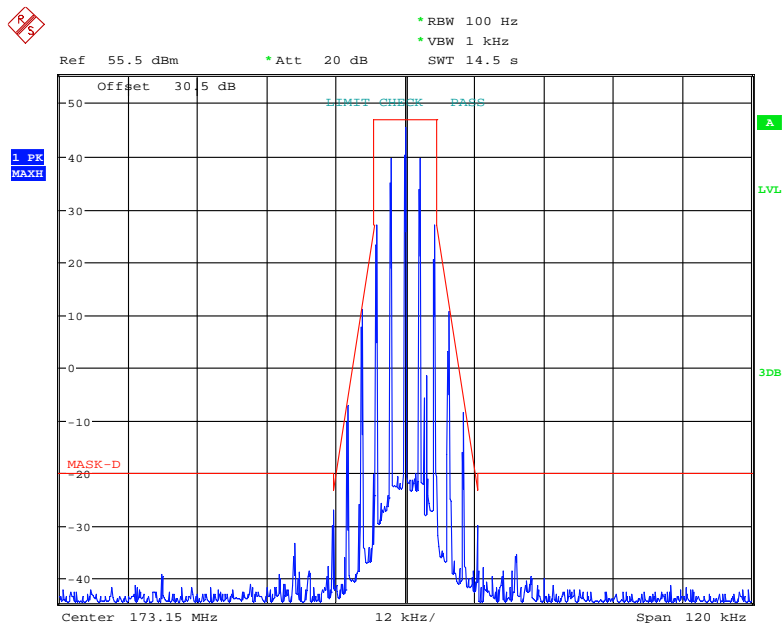

Date: 11.MAY.2021 22:15:26

FCC §2.1051 & §90.210 - SPURIOUS EMISSIONS AT ANTENNA TERMINALS

Applicable Standard

Emission Mask D—12.5 kHz channel bandwidth equipment. For transmitters designed to operate with a 12.5 kHz channel bandwidth, any emission must be attenuated below the power (P) of the highest emission contained within the authorized bandwidth as follows:

- 1) For any frequency removed from the center of the authorized bandwidth f_0 to 5.625 kHz removed from f_0 , 0 dB.
- 2) On any frequency removed from the center of the authorized bandwidth by a displacement frequency (f_d in kHz) of more than 5.626 kHz but no more than 12.5 kHz, at least $7.27 (f_d - 2.88 \text{ kHz})$ dB.
- 3) On any frequency removed from the center of the authorized bandwidth by a displacement frequency (f_d in kHz) of more than 12.5 kHz: At least $50 + 10 \log (P)$ dB or 70 dB, whichever is the lesser attenuation.

Test Procedure

The RF output of the EUT was connected to a spectrum analyzer through appropriate attenuation. The resolution bandwidth of the spectrum analyzer was set at 100kHz for below 1GHz, and 1MHz for above 1GHz. Sufficient scans were taken to show any out of band emissions up to 10th harmonic.

Test Data

Environmental Conditions

Temperature:	25 °C
Relative Humidity:	52 %
ATM Pressure:	101.0 kPa

The testing was performed by Blaker Zhang on 2021-04-26.

Test Mode: Transmitting, worst case for highest power level.

Test Result: *Pass. Please refer to the following tables and plots.*

Digital

30MHz – 1 GHz, - Low Channel

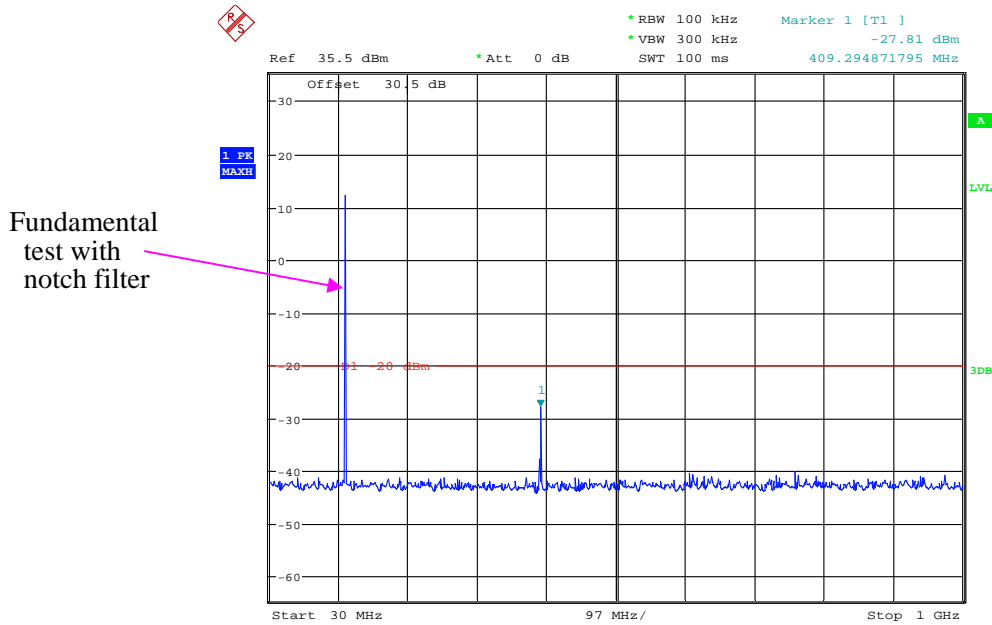

Date: 26.APR.2021 23:52:11

1 GHz – 5 GHz, - Low Channel

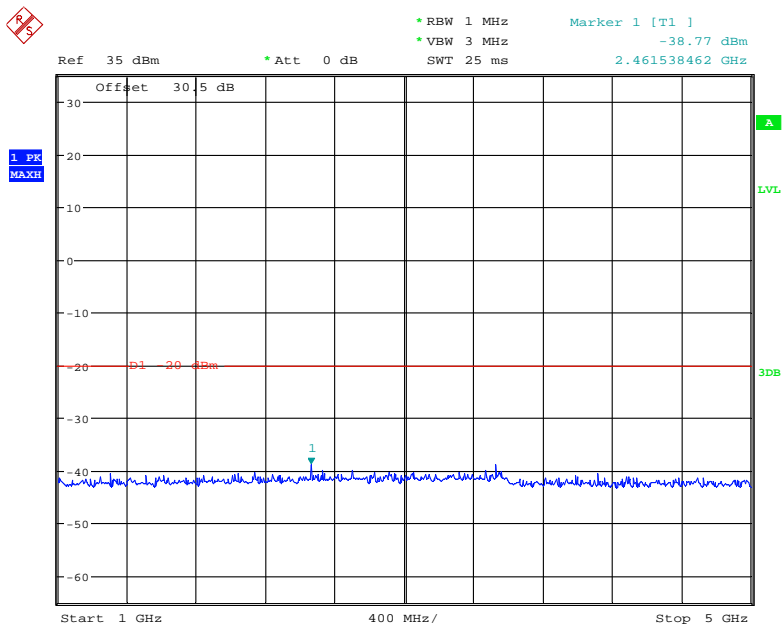

Date: 26.APR.2021 23:35:51

30MHz – 1 GHz, - Middle Channel

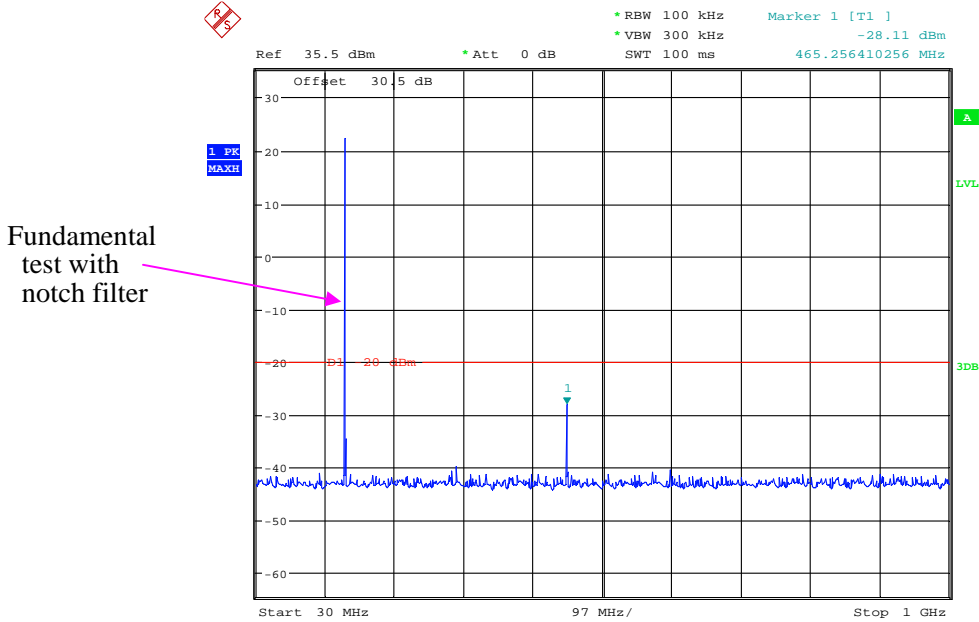

Date: 26.APR.2021 23:52:55

1 GHz – 5 GHz, Middle Channel

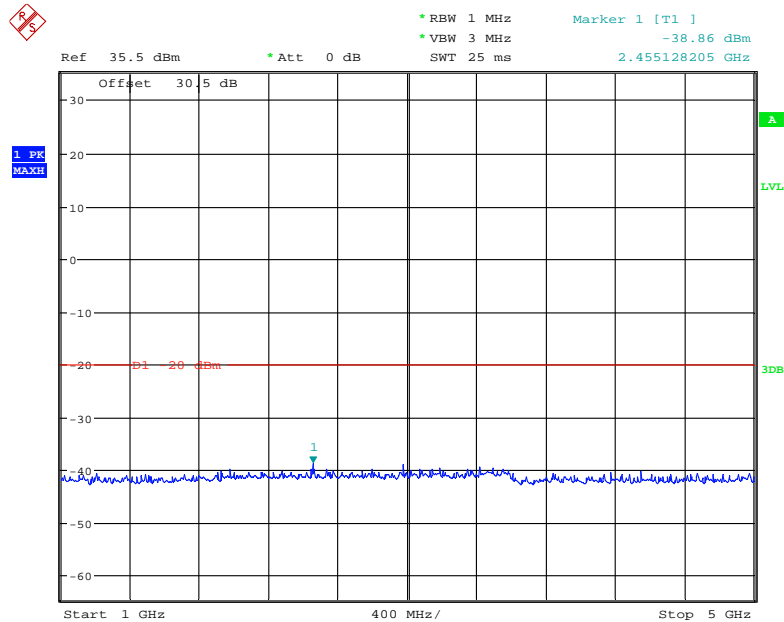

Date: 26.APR.2021 23:46:48

30MHz – 1 GHz, - High Channel

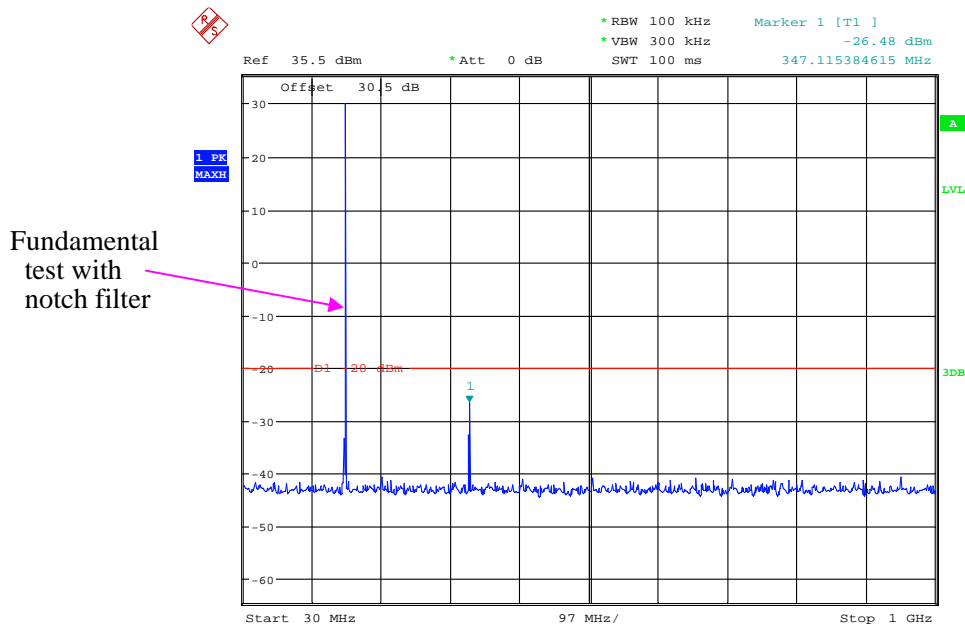

Date: 26.APR.2021 23:53:42

1 GHz – 5 GHz, High Channel

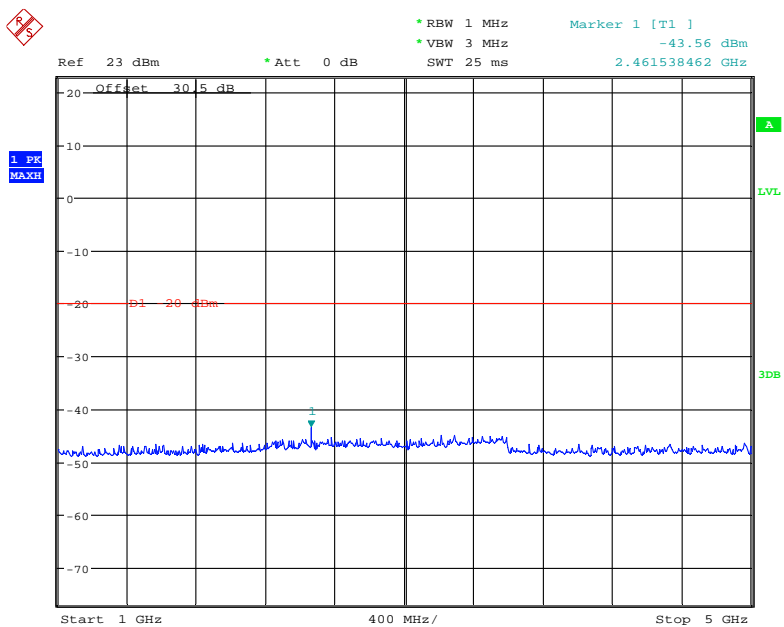

Date: 26.APR.2021 23:40:48

Analog

30MHz – 1 GHz, - Low Channel

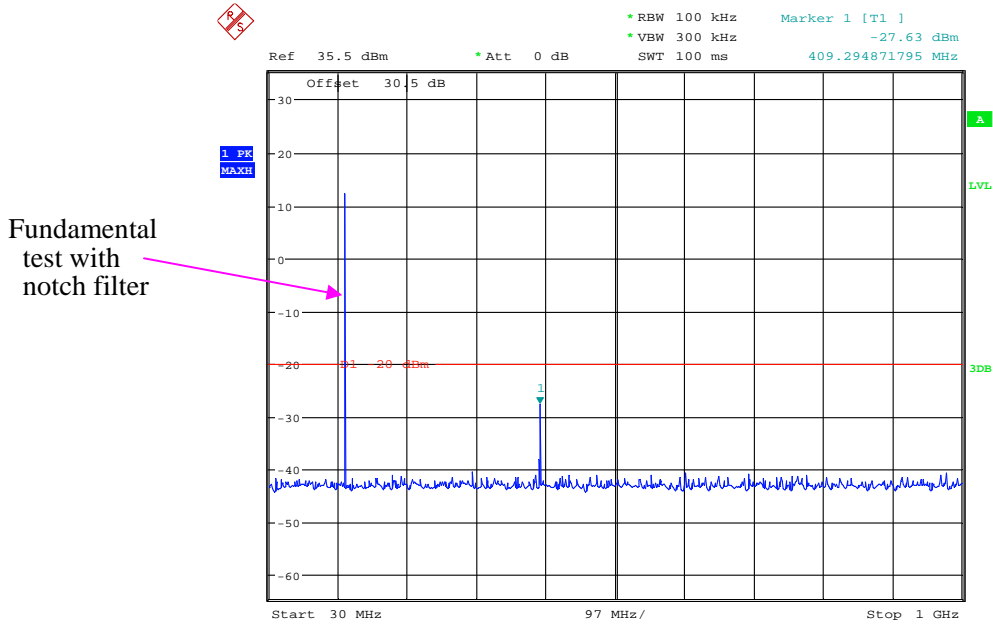

Date: 26.APR.2021 23:49:16

1 GHz – 5 GHz, - Low Channel

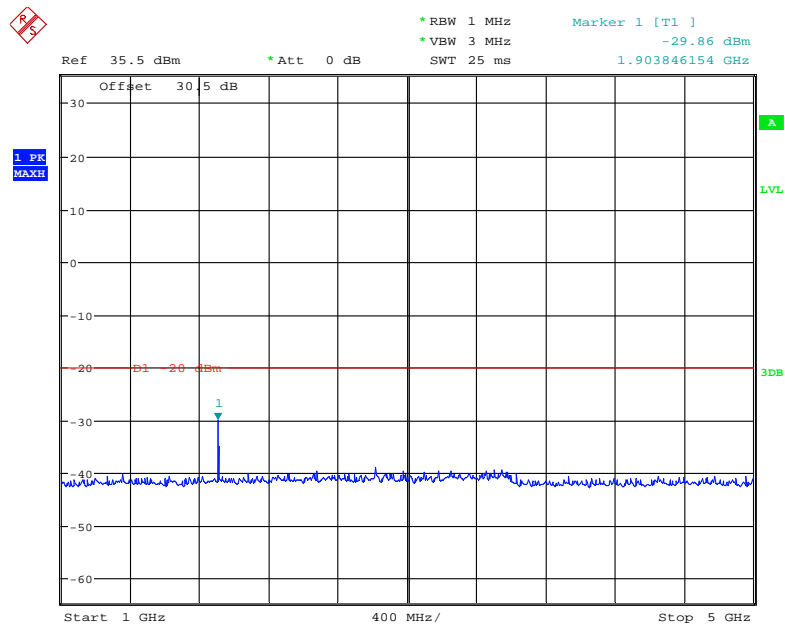

Date: 26.APR.2021 23:42:53

30MHz – 1 GHz, - Middle Channel

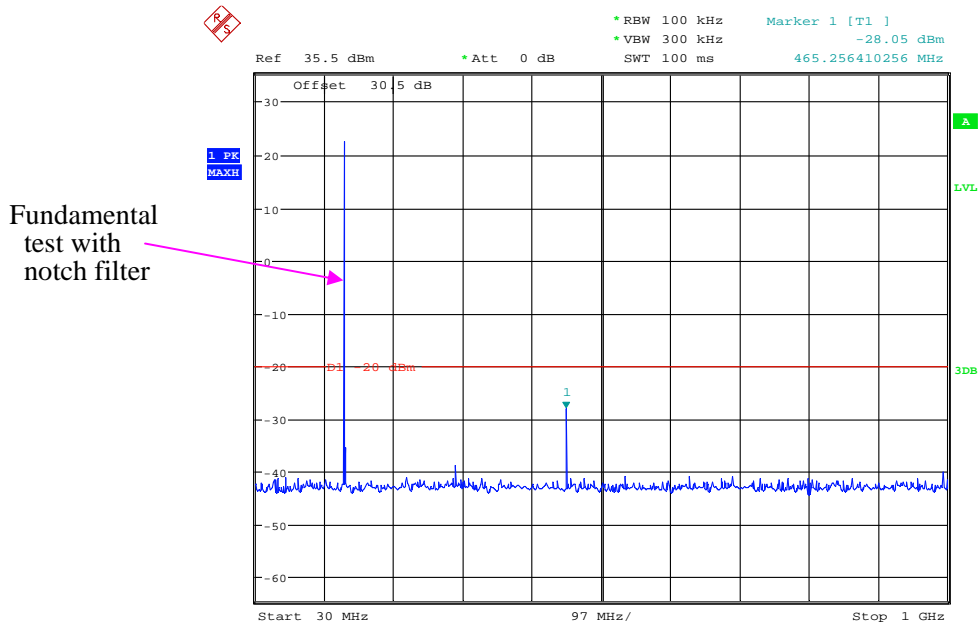

Date: 26.APR.2021 23:50:23

1 GHz – 5 GHz, Middle Channel

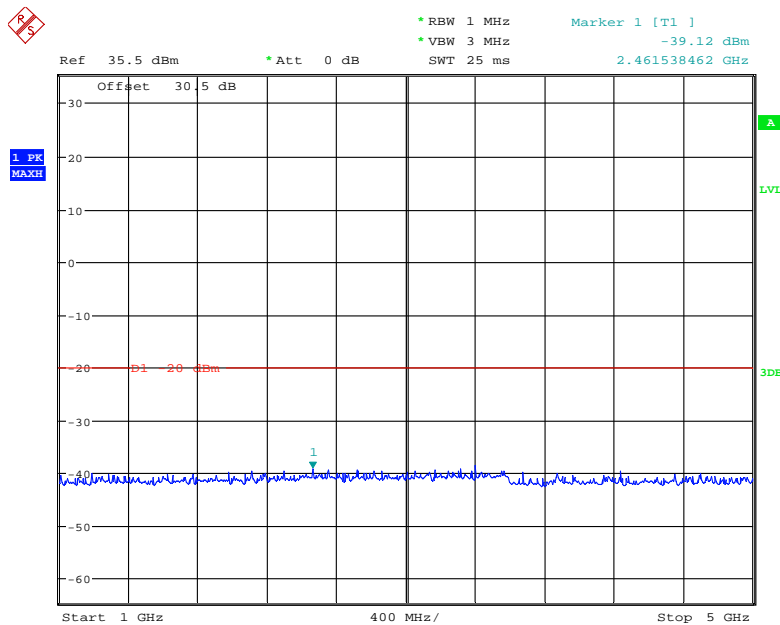

Date: 26.APR.2021 23:44:08

30MHz – 1 GHz, - High Channel

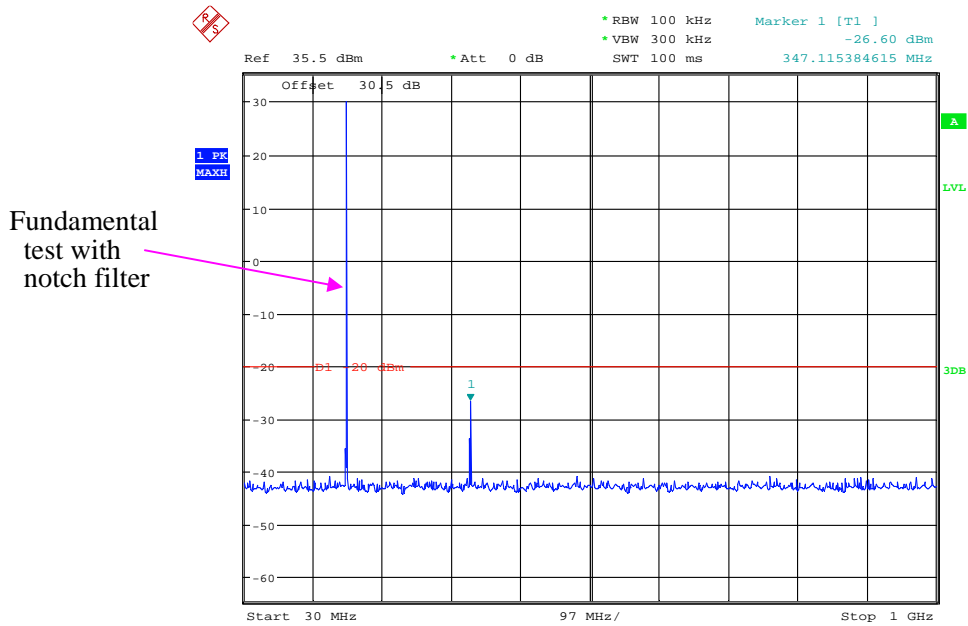

Date: 26.APR.2021 23:50:59

1 GHz – 5 GHz, High Channel

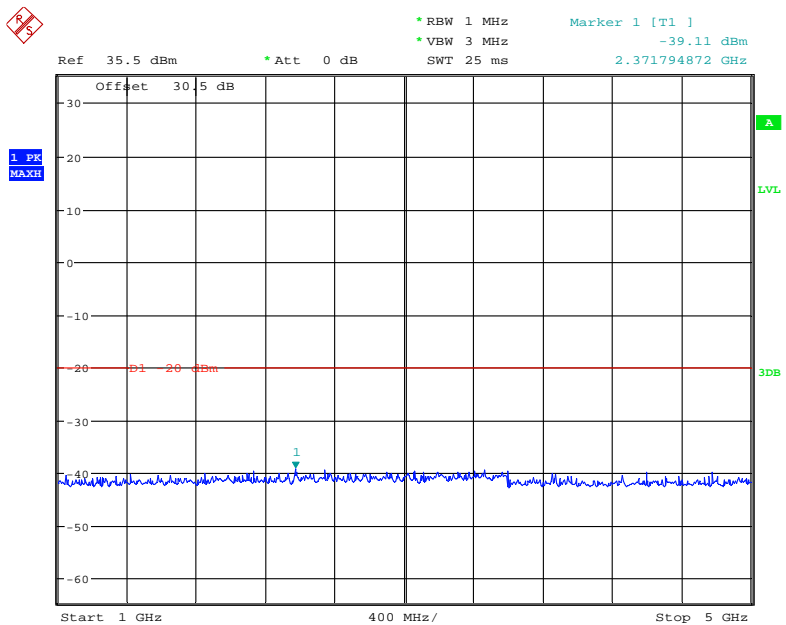

Date: 26.APR.2021 23:44:56

FCC §2.1053 & §90.210 - RADIATED SPURIOUS EMISSIONS

Applicable Standard

FCC §2.1053 and §90.210

Test Procedure

The transmitter was placed on a wooden turntable, and it was transmitting into a non-radiating load, which was also placed on the turntable.

The measurement antenna was placed at a distance of 3 meters from the EUT. During the tests, the antenna height and polarization as well as EUT azimuth were varied in order to identify the maximum level of emissions from the EUT. The test was performed by placing the EUT on 3-orthogonal axis.

The frequency range up to teeth harmonic of the fundamental frequency was investigated.

Remove the EUT and replace it with substitution antenna. A signal generator was connected to the substitution antenna by a non-radiating cable. The absolute levels of the spurious emissions were measured by the substitution.

Spurious emissions in dB =10 lg (TXpwr in Watts/0.001)-the absolute level

Spurious attenuation limit in dB =50+10 Log₁₀ (power out in Watts) for EUT with a 12.5 kHz channel bandwidth.

Test Data

Environmental Conditions

Temperature:	28.2~30.0 °C
Relative Humidity:	50.0~60.0 %
ATM Pressure:	101.0 kPa

The testing was performed by Zero Yan on 2021-04-29 for below 1GHz and Alan He on 2021-04-29 for above 1GHz.

Test Mode: Transmitting, worst case for highest power level.

Test Result: Pass. Please refer to the following tables and plots.

30MHz-2GHz:

Frequency (MHz)	Receiver Reading (dBµV)	Turn Table Angle Degree	Rx Antenna		Substituted			Absolute Level (dBm)	Limit (dBm)	Margin (dB)
			Height (m)	Polar (H/V)	Level (dBm)	Cable Loss (dB)	Antenna Gain (dBd/dBi)			
Analogue 136.15MHz										
272.3	49.20	233	1.6	H	-59.0	0.90	0.0	-59.90	-20	39.90
272.3	47.10	76	1.4	V	-58.2	0.90	0.0	-59.10	-20	39.10
1089.20	44.88	129	1.1	H	-63.9	1.60	6.20	-59.30	-20	39.30
1089.20	44.67	45	2.2	V	-64.9	1.60	6.20	-60.30	-20	40.30
Analogue 155.15MHz										
310.3	50.12	11	2.3	H	-57.9	0.94	0.0	-58.84	-20	38.84
310.3	48.21	246	1.3	V	-57.0	0.94	0.0	-57.94	-20	37.94
1086.05	45.11	97	1.6	H	-63.6	1.60	6.20	-59.00	-20	39.00
1086.05	46.12	162	2.0	V	-63.5	1.60	6.20	-58.90	-20	38.90
Analogue 173.15MHz										
346.3	55.12	279	2.0	H	-51.8	0.98	0.0	-52.78	-20	32.78
346.3	52.12	309	1.6	V	-51.7	0.98	0.0	-52.68	-20	32.68
1038.90	43.58	272	1.7	H	-65.6	1.50	5.60	-61.50	-20	41.50
1038.90	43.89	134	1.6	V	-66.2	1.50	5.60	-62.10	-20	42.10

Frequency (MHz)	Receiver Reading (dBµV)	Turn Table Angle Degree	Rx Antenna		Substituted			Absolute Level (dBm)	Limit (dBm)	Margin (dB)
			Height (m)	Polar (H/V)	Level (dBm)	Cable Loss (dB)	Antenna Gain (dBd/dBi)			
Digital 136.15MHz										
272.3	49.32	148	1.6	H	-58.9	0.90	0.0	-59.80	-20	39.80
272.3	47.21	283	1.3	V	-58.1	0.90	0.0	-59.00	-20	39.00
1089.20	43.34	319	2.0	H	-65.4	1.60	6.20	-60.80	-20	40.80
1089.20	43.14	165	1.5	V	-66.4	1.60	6.20	-61.80	-20	41.80
Digital 155.15 MHz										
310.3	50.54	326	1.3	H	-57.5	0.94	0.0	-58.44	-20	38.44
310.3	48.48	36	1.4	V	-56.7	0.94	0.0	-57.64	-20	37.64
1086.05	43.15	70	1.8	H	-65.6	1.60	6.20	-61.00	-20	41.00
1086.05	43.51	207	1.9	V	-66.1	1.60	6.20	-61.50	-20	41.50
Digital 173.15MHz										
346.3	54.89	92	2.2	H	-52.0	0.98	0.0	-52.98	-20	32.98
346.3	51.93	48	1.2	V	-51.9	0.98	0.0	-52.88	-20	32.88
1038.90	43.23	233	1.9	H	-66.0	1.50	5.60	-61.90	-20	41.90
1038.90	43.53	338	1.2	V	-66.6	1.50	5.60	-62.50	-20	42.50

Note:

Absolute Level = Substituted Level - Cable loss + Antenna Gain

Margin = Limit- Absolute Level

FCC §2.1055 & §90.213 - FREQUENCY STABILITY

Applicable Standard

FCC §2.1055 and §90.213

Test Procedure

Frequency Stability vs. Temperature: The equipment under test was connected to an external AC/DC power supply and the RF output was connected to communication test set via feed-through attenuators. The EUT was placed inside the temperature chamber. The power cable and RF output cable exited the chamber through an opening made for the purpose.

After the temperature stabilized for approximately 20 minutes, the frequency output was recorded from the counter.

Test Data

Environmental Conditions

Temperature:	25 °C
Relative Humidity:	52 %
ATM Pressure:	101.0 kPa

The testing was performed by Blaker Zhang on 2021-04-27.

Test Mode: Transmitting, worst case for middle power level.

***Test Result:** Pass. Please refer to the following tables and plots.*

AC

For Analog

Reference Frequency: 155.15MHz, Limit: ±2.5 ppm			
Test Environment		Frequency Measure with Time Elapsed	
Temperature (°C)	Voltage Supplied (V _{DC})	Measured Frequency (MHz)	Frequency Error (ppm)
Frequency Stability versus Input Temperature			
50	120	155.149976	-0.15
40	120	155.149984	-0.10
30	120	155.149986	-0.09
20	120	155.149972	-0.18
10	120	155.149975	-0.16
0	120	155.149974	-0.17
-10	120	155.149979	-0.14
-20	120	155.149983	-0.11
-30	120	155.149985	-0.10
Frequency Stability Versus Input Voltage			
20	102	155.149978	-0.14
20	138	155.149969	-0.20

For Digital

Reference Frequency: 155.15MHz, Limit: ±2.5 ppm			
Test Environment		Frequency Measure with Time Elapsed	
Temperature (°C)	Voltage Supplied (V _{DC})	Measured Frequency (MHz)	Frequency Error (ppm)
Frequency Stability versus Input Temperature			
50	120	155.149987	-0.08
40	120	155.149989	-0.07
30	120	155.149979	-0.14
20	120	155.149986	-0.09
10	120	155.149995	-0.03
0	120	155.149990	-0.06
-10	120	155.149986	-0.09
-20	120	155.149982	-0.12
-30	120	155.149988	-0.08
Frequency Stability Versus Input Voltage			
20	102	155.149981	-0.12
20	138	155.149977	-0.15

DC

For Analog

Reference Frequency:155.15MHz, Limit:2.5 ppm, 12.5kHz			
Test Environment		Frequency Measure with Time Elapsed	
Temperature (°C)	Voltage Supplied (V_{DC})	Measured Frequency (MHz)	Frequency Error (ppm)
Frequency Stability versus Input Temperature			
50	13.6	155.149935	-0.42
40	13.6	155.149947	-0.34
30	13.6	155.149965	-0.23
20	13.6	155.149927	-0.47
10	13.6	155.149956	-0.28
0	13.6	155.149942	-0.37
-10	13.6	155.149981	-0.12
-20	13.6	155.149978	-0.14
-30	13.6	155.149976	-0.15
Frequency Stability Versus Input Voltage			
20	11.6	155.149972	-0.18
20	15.6	155.149963	-0.24

For Digital

Reference Frequency: 155.15MHz, Limit: ±2.5 ppm			
Test Environment		Frequency Measure with Time Elapsed	
Temperature (°C)	Voltage Supplied (V_{DC})	Measured Frequency (MHz)	Frequency Error (ppm)
Frequency Stability versus Input Temperature			
50	13.6	155.149965	-0.23
40	13.6	155.149964	-0.23
30	13.6	155.149963	-0.24
20	13.6	155.149958	-0.27
10	13.6	155.149962	-0.24
0	13.6	155.149965	-0.23
-10	13.6	155.149964	-0.23
-20	13.6	155.149969	-0.20
-30	13.6	155.149970	-0.19
Frequency Stability Versus Input Voltage			
20	11.6	155.149968	-0.21
20	15.6	155.149956	-0.28

FCC §90.214 - TRANSIENT FREQUENCY BEHAVIOR

Applicable Standard

Regulations: FCC §90.214
Test method: ANSI C63.26-2015

Test Procedure

- a) Connect the EUT and test equipment as shown on the following block diagram.
- b) Set the Spectrum Analyzer to measure FM deviation, and tune the RF frequency to the transmitter assigned frequency.
- c) Set the signal generator to the assigned transmitter frequency and modulate it with a 1 kHz tone at ± 12.5 kHz deviation and set its output level to -100dBm.
- d) Turn on the transmitter.
- e) Supply sufficient attenuation via the RF attenuator to provide an input level to the Spectrum Analyzer that is 40 dB below the maximum allowed input power when the transmitter is operating at its rated power level. Note this power level on the Spectrum Analyzer as P_0 .
- f) Turn off the transmitter.
- g) Adjust the RF level of the signal generator to provide RF power equal to P_0 . This signal generator RF level shall be maintained throughout the rest of the measurement.
- h) Remove the attenuation 1, so the input power to the Spectrum Analyzer is increased by 30 dB when the transmitter is turned on.
- i) Adjust the vertical amplitude control of the spectrum analyzer to display the 1000 Hz at ± 4 divisions vertically centered on the display. Set trigger mode of the Spectrum Analyzer to "Video", and tune the "trigger level" on suitable level. Then set the "trigger offset" to -10ms for turn on and -15ms for turn off.
- j) Turn on the transmitter and the transient wave will be captured on the screen of Spectrum Analyzer. Observe the stored display. The instant when the 1 kHz test signal is completely suppressed is considered to be t_{on} . The trace should be maintained within the allowed divisions during the period t_1 and t_2 .
- k) Then turn off the transmitter, and another transient wave will be captured on the screen of Spectrum Analyzer. The trace should be maintained within the allowed divisions during the period t_3 .

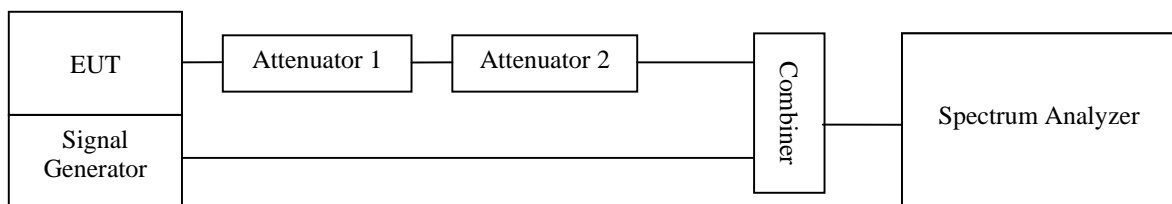

Test Data

Environmental Conditions

Temperature:	25 °C
Relative Humidity:	52 %
ATM Pressure:	101.0 kPa

The testing was performed by Blaker Zhang on 2021-04-27.

Test Result: Pass. Please refer to the following tables and plots.

Channel Separation (kHz)	Transient Period (ms)	Transient Frequency	Result
12.5	5 (t1)	<+/-12.5 kHz	Pass
	20(t2)	<+/-6.25 kHz	
	5 (t3)	<+/-12.5 kHz	

Channel: 460 MHz, 12.5 kHz

Turn on

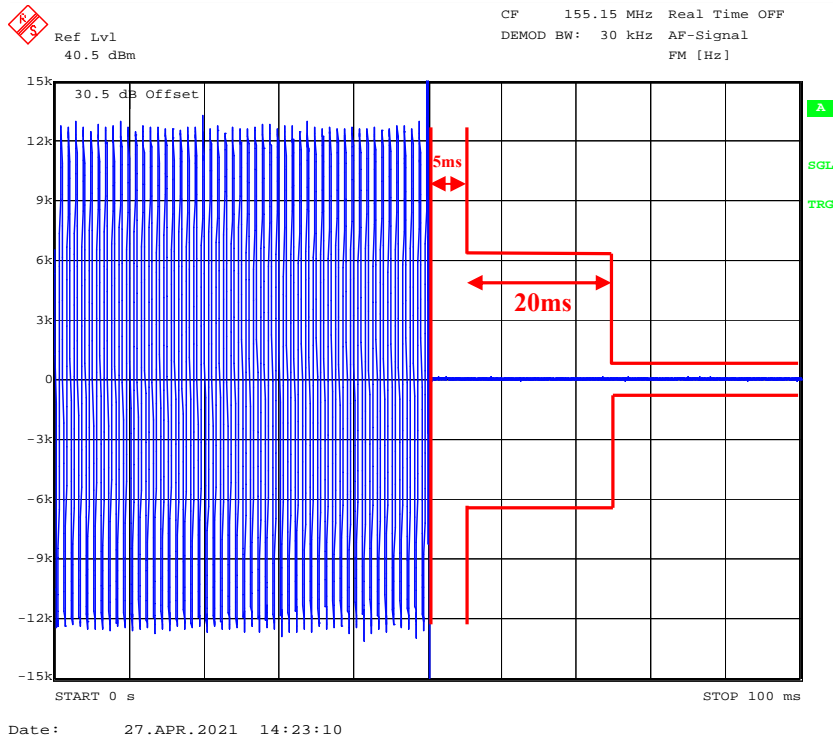

Turn off

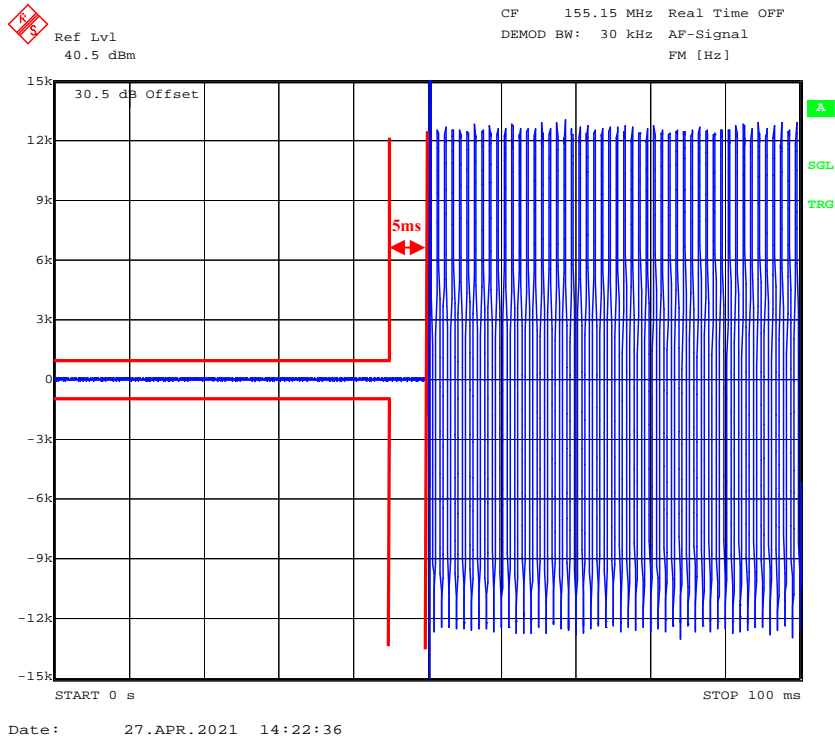

***** END OF REPORT *****