



FCC PART 15B, CLASS B TEST REPORT

For

CALTTA TECHNOLOGIES CO., LTD.

4/F, R&D Building 1, ZTE Industrial Park, Xili, Nanshan District, Shenzhen, Guangdong, China

FCC ID: 2AQV7PR900U1

Report Type: Original Report	Product Type: Digital Repeater,UHF DMR
Report Number: <u>RSZ190308009-00A</u>	
Report Date: <u>2019-05-14</u>	
Rocky Kang	
Reviewed By: <u>RF Engineer</u>	
Prepared By: Bay Area Compliance Laboratories Corp. (Shenzhen) 6/F., West Wing, Third Phase of Wanli Industrial Building, Shihua Road, Futian Free Trade Zone, Shenzhen, Guangdong, China Tel: +86-755-33320018 Fax: +86-755-33320008 www.baclcorp.com.cn	

Note: This report must not be used by the customer to claim product certification, approval, or endorsement by A2LA* or any agency of the Federal Government. * This report may contain data that are not covered by the A2LA accreditation and are marked with an asterisk “*”.

The information marked # is provided by the applicant, the laboratory is not responsible for its authenticity.

TABLE OF CONTENTS

GENERAL INFORMATION.....	3
PRODUCT DESCRIPTION FOR EQUIPMENT UNDER TEST (EUT).....	3
OBJECTIVE	3
RELATED SUBMITTAL(S)/GRANT(S).....	3
TEST METHODOLOGY	3
MEASUREMENT UNCERTAINTY.....	4
TEST FACILITY	4
SYSTEM TEST CONFIGURATION.....	5
DESCRIPTION OF TEST CONFIGURATION	5
EUT EXERCISE SOFTWARE	5
SPECIAL ACCESSORIES.....	5
EQUIPMENT MODIFICATIONS	5
SUPPORT EQUIPMENT LIST AND DETAILS	5
EXTERNAL I/O CABLE.....	5
BLOCK DIAGRAM OF TEST SETUP	6
SUMMARY OF TEST RESULTS	7
TEST EQUIPMENT LIST	8
FCC §15.107 – AC LINE CONDUCTED EMISSIONS.....	9
APPLICABLE STANDARD	9
EUT SETUP	9
EMI TEST RECEIVER SETUP.....	9
TEST PROCEDURE	9
CORRECTED FACTOR & MARGIN CALCULATION	10
TEST RESULTS SUMMARY	10
TEST DATA	10
FCC §15.109 - RADIATED SPURIOUS EMISSIONS	13
APPLICABLE STANDARD	13
EUT SETUP	13
EMI TEST RECEIVER SETUP.....	14
TEST PROCEDURE	14
CORRECTED AMPLITUDE & MARGIN CALCULATION	14
TEST RESULTS SUMMARY	14
TEST DATA	15

GENERAL INFORMATION

Product Description for Equipment under Test (EUT)

Product	Digital Repeater,UHF DMR
Tested Model	PR900 U(1)
Voltage Range	DC 13.6V/AC: 100V-240V, 50-60 Hz
Measure	146 mm (L) * 72 mm (W) * 10 mm (H)
Highest operating frequency	470 MHz
Date of Test	2019-04-01~ 2019-05-14
Sample serial number	321170910101
Received date	2019-03-08
Sample/EUT Status	Good condition

Objective

This test report is prepared on behalf of *CALTTA TECHNOLOGIES CO., LTD.* in accordance with Part 2-Subpart J, Part 15-Subparts A, B of the Federal Communication Commissions rules.

The objective of the manufacturer is to determine the compliance of the EUT with FCC Part 15 B.

Related Submittal(s)/Grant(s)

FCC Part 90 TNB submissions with FCC ID: 2AQV7PR900U1.

Test Methodology

All measurements contained in this report were conducted with ANSI C63.4-2014, American National Standard for Methods of Measurement of Radio-Noise Emissions from Low-Voltage Electrical and Electronic Equipment in the range of 9 kHz to 40 GHz.

All emissions measurement was performed at Bay Area Compliance Laboratories Corp. (Shenzhen). The radiated testing was performed at an antenna-to-EUT distance of 3 meters.

Measurement Uncertainty

All measurements involve certain levels of uncertainties, especially in field of EMC. The factors contributing to uncertainties are spectrum analyzer, cable loss, antenna factor calibration, antenna directivity, antenna factor variation with height, antenna phase center variation, antenna factor frequency interpolation, measurement distance variation, site imperfections, mismatch (average), and system repeatability.

Based on CISPR 16-4-2:2011, the expanded combined standard uncertainty of test at Bay Area Compliance Laboratories Corp. (Shenzhen) is shown as below. And the uncertainty will be taken into consideration for the test data recorded in the report

Parameter		uncertainty
Conducted Emissions		±1.95dB
Emissions, radiated	Below 1GHz	±4.75dB
	Above 1GHz	±4.88dB

Note: Otherwise required by the applicant or Product Regulations, Decision Rule in this report did not consider the uncertainty.

Test Facility

The Test site used by Bay Area Compliance Laboratories Corp. (Shenzhen) to collect test data is located on the 6/F., West Wing, Third Phase of Wanli Industrial Building, Shihua Road, Futian Free Trade Zone, Shenzhen, Guangdong, China.

The test site has been approved by the FCC under the KDB 974614 D01 and is listed in the FCC Public Access Link (PAL) database, FCC Registration No.: 342867, the FCC Designation No.: CN1221.

The test site has been registered with ISED Canada under ISED Canada Registration Number 3062B.

SYSTEM TEST CONFIGURATION

Description of Test Configuration

The system was configured for testing in a manufacturer testing fashion.

EUT operation mode: Ping IP (data transfer with computer)

EUT Exercise Software

No exercise software was used.

Special Accessories

No special accessory.

Equipment Modifications

No modification was made to the EUT tested.

Support Equipment List and Details

Manufacturer	Description	Model	Serial Number
Un-known	Control Cable	Un-known	Un-known
Un-known	PTT Cable	Un-known	Un-known
Un-known	USB Disk	Un-known	Un-known
AA-MCS	Attenuator	CAT-50-40-200-Nm-Nf	0602-010

External I/O Cable

Cable Description	Length (m)	From/Port	To
Shielding Detachable RF Cable	1.0	EUT	Attenuater
Unshielded Detachable RJ45 Cable	3.0	EUT	Laptop
Unshielded Un-detachable AC cable	1.0	EUT	LISN

Block Diagram of Test Setup

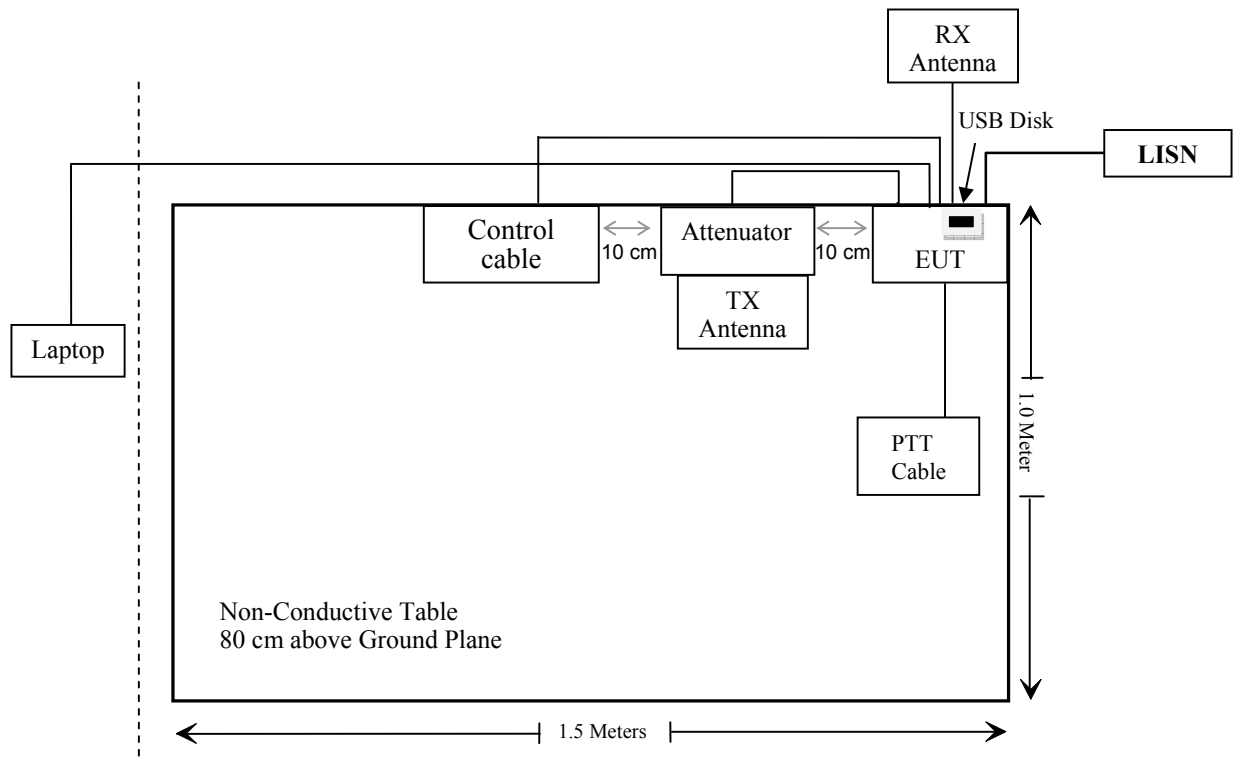

SUMMARY OF TEST RESULTS

FCC Rules	Description of Test	Results
§15.107	AC Line Conducted Emissions	Compliance
§15.109	Radiated Spurious Emissions	Compliance

TEST EQUIPMENT LIST

Manufacturer	Description	Model	Serial Number	Calibration Date	Calibration Due Date
AC Line Conducted Emission Test					
Rohde & Schwarz	EMI Test Receiver	ESCS30	100176	2018-07-11	2019-07-11
Rohde & Schwarz	LISN	ENV216	3560.6650.12-101613-Yb	2018-12-21	2019-12-21
Rohde & Schwarz	Transient Limiter	ESH3Z2	DE25985	2018-11-12	2019-11-12
Rohde & Schwarz	CE Test software	EMC 32	V8.53.0	NCR	NCR
Unknown	Conducted Emission Cable	78652	UF A210B-1-0720-504504	2018-11-12	2019-11-12
Radiated Emission Test					
A.H. System	Horn Antenna	SAS-200/571	135	2018-09-01	2021-08-31
Rohde & Schwarz	Signal Analyzer	FSV40	101473	2019-01-09	2020-01-08
Sunol Sciences	Broadband Antenna	JB1	A040904-1	2017-12-22	2020-12-21
COM-POWER	Pre-amplifier	PA-122	181919	2018-11-12	2019-11-12
Sonoma instrument	Amplifier	310N	186238	2018-11-12	2019-11-12
Rohde & Schwarz	EMI Test Receiver	ESR	1316.3003K03-101746-zn	2018-07-11	2019-07-11
Rohde & Schwarz	Spectrum Analyzer	FSU26	200120	2019-03-02	2020-03-01
Ducommun technologies	RF Cable	UFA147A-2362-100100	MFR64639-231029-003	2018-07-11	2021-07-10
Ducommun technologies	RF Cable	104PEA	218124002	2018-11-12	2019-11-12
Ducommun technologies	RF Cable	RG-214	1	2018-11-19	2019-05-21
Ducommun technologies	RF Cable	RG-214	2	2018-11-12	2019-11-12
Rohde & Schwarz	Auto test software	EMC 32	V9.10	NCR	NCR

* **Statement of Traceability:** Bay Area Compliance Laboratories Corp. (Shenzhen) attests that all calibrations have been performed in accordance to requirements that traceable to National Primary Standards and International System of Units (SI).

FCC §15.107 – AC LINE CONDUCTED EMISSIONS

Applicable Standard

According to FCC §15.107

EUT Setup

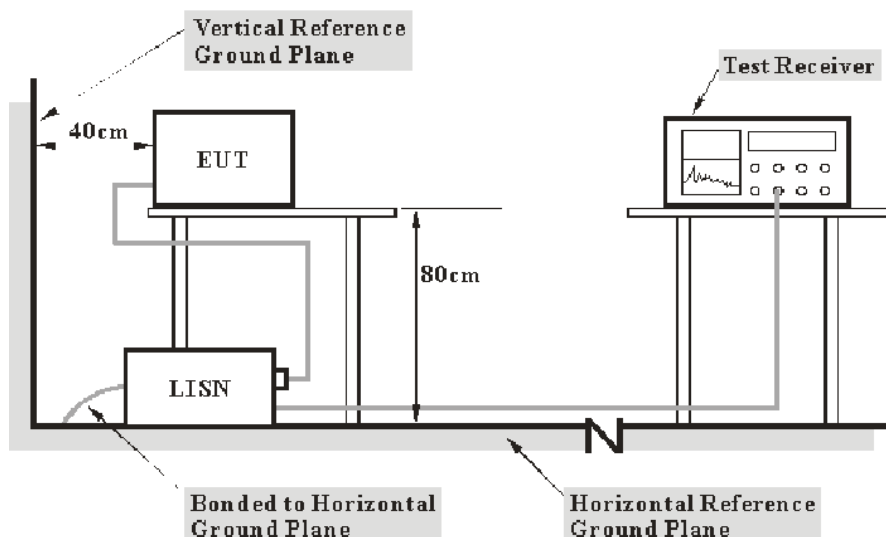

- Note: 1. Support units were connected to second LISN.
 2. Both of LISNs (AMN) 80 cm from EUT and at the least 80 cm from other units and other metal planes support units.

The measurement procedure of EUT setup is according with per ANSI C63.4-2014. The related limit was specified in FCC Part 15.107 Class B.

The spacing between the peripherals was 10 cm.

EMI Test Receiver Setup

The EMI test receiver was set to investigate the spectrum from 150 kHz to 30 MHz.

During the conducted emission test, the EMI test receiver was set with the following configurations:

Frequency Range	IF B/W
150 kHz – 30 MHz	9 kHz

Test Procedure

During the conducted emission test, the EUT was connected to the first LISN and the other relevant equipments were connected to the second LISN.

Maximizing procedure was performed on the six (6) highest emissions of the EUT.

All data was recorded in the Quasi-peak and average detection mode.

Corrected Factor & Margin Calculation

The Corrected factor is calculated by adding LISN/ISN VDF (Voltage Division Factor), Cable Loss and Transient Limiter Attenuation. The basic equation is as follows:

$$\text{Correction Factor} = \text{LISN VDF} + \text{Cable Loss} + \text{Transient Limiter Attenuation}$$

The “**Margin**” column of the following data tables indicates the degree of compliance with the applicable limit. For example, a margin of 7 dB means the emission is 7 dB below the limit. The equation for margin calculation is as follows:

$$\text{Margin} = \text{Limit} - \text{Corrected Amplitude}$$

Test Results Summary

According to the recorded data in following table, the EUT complied with the FCC Part 15.107,

Refer to CISPR16-4-2:2011 and CISPR 16-4-1:2009, the measured level is in compliance with the limit if

$$L_m + U_{(Lm)} \leq L_{lim} + U_{cispr}$$

In BAEL., $U_{(Lm)}$ is less than U_{cispr} , if L_m is less than L_{lim} , it implies that the EUT complies with the limit.

Test Data

Environmental Conditions

Temperature:	25 °C
Relative Humidity:	56 %
ATM Pressure:	101.0 kPa

The testing was performed by Haiguo Li on 2019-04-01.

EUT Operation Mode: Ping IP

AC 120V/60 Hz, Line

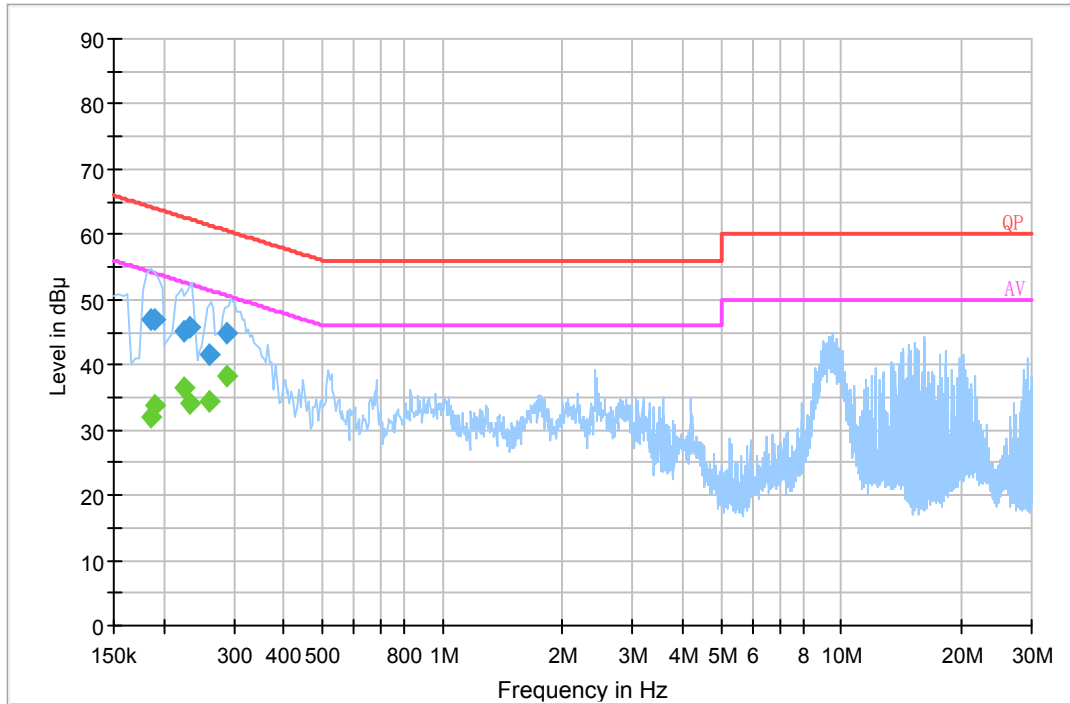

Frequency (MHz)	Corrected Amplitude (dBµV)	Correction Factor (dB)	Limit (dBµV)	Margin (dB)	Detector (PK/Ave./QP)
0.186500	46.9	20.0	64.2	17.3	QP
0.189500	47.0	20.0	64.1	17.1	QP
0.225500	45.1	20.0	62.6	17.5	QP
0.233500	45.8	20.0	62.3	16.5	QP
0.261500	41.6	20.0	61.4	19.8	QP
0.289500	44.8	20.1	60.5	15.7	QP
0.186500	32.1	20.0	54.2	22.1	Ave.
0.189500	33.7	20.0	54.1	20.4	Ave.
0.225500	36.5	20.0	52.6	16.1	Ave.
0.233500	34.2	20.0	52.3	18.1	Ave.
0.261500	34.4	20.0	51.4	17.0	Ave.
0.289500	38.3	20.1	50.5	12.2	Ave.

AC 120V/60 Hz, Neutral

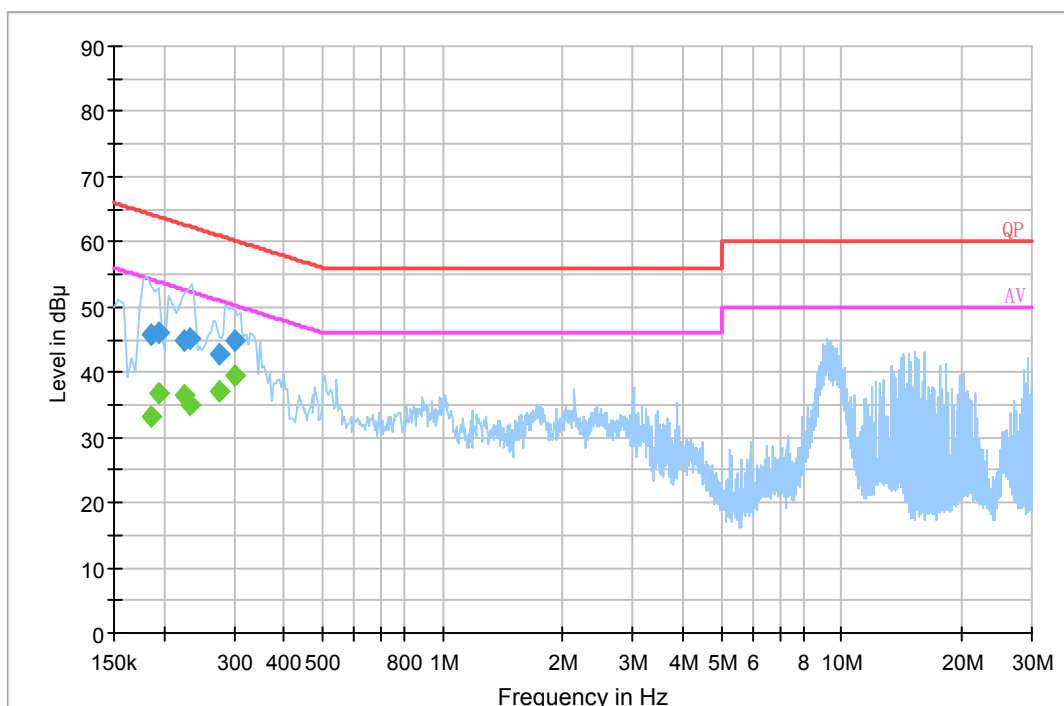

Frequency (MHz)	Corrected Amplitude (dBµV)	Correction Factor (dB)	Limit (dBµV)	Margin (dB)	Detector (PK/Ave./QP)
0.186500	45.7	20.0	64.2	18.5	QP
0.193500	45.9	20.0	63.9	18.0	QP
0.225500	44.9	20.0	62.6	17.7	QP
0.233500	45.3	20.0	62.3	17.0	QP
0.274500	42.6	20.0	61.0	18.4	QP
0.301470	45.0	20.1	60.2	15.2	QP
0.186500	33.1	20.0	54.2	21.1	Ave.
0.193500	36.9	20.0	53.9	17.0	Ave.
0.225500	36.5	20.0	52.6	16.1	Ave.
0.233500	35.0	20.0	52.3	17.3	Ave.
0.274500	37.0	20.0	51.0	14.0	Ave.
0.301470	39.3	20.1	50.2	10.9	Ave.

Note:

- 1) Correction Factor = LISN VDF (Voltage Division Factor) + Cable Loss + Transient Limiter Attenuation
- 2) Corrected Amplitude = Reading + Correction Factor
- 3) Margin = Limit – Corrected Amplitude

FCC §15.109 - RADIATED SPURIOUS EMISSIONS

Applicable Standard

FCC §15.109

EUT Setup

Below 1GHz:

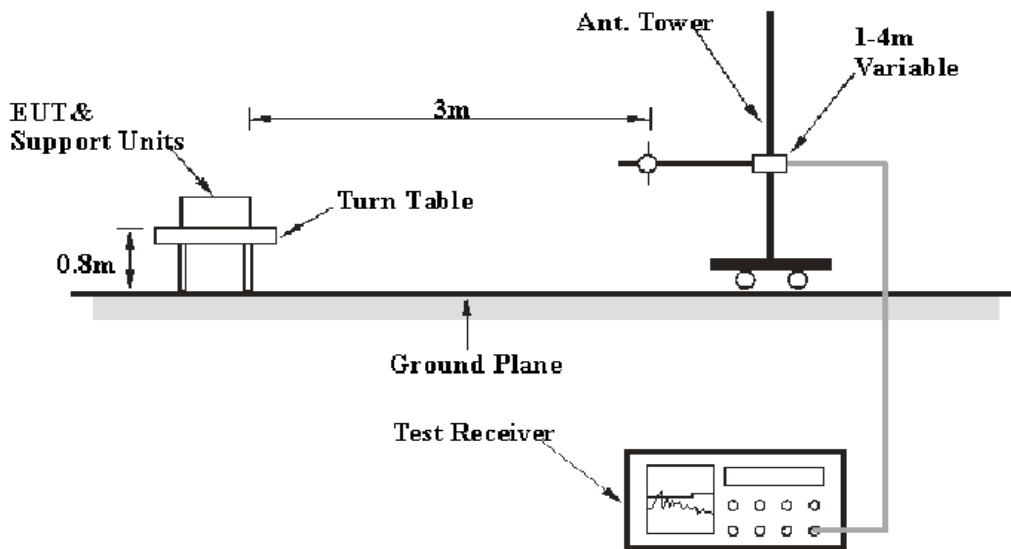

Above 1GHz:

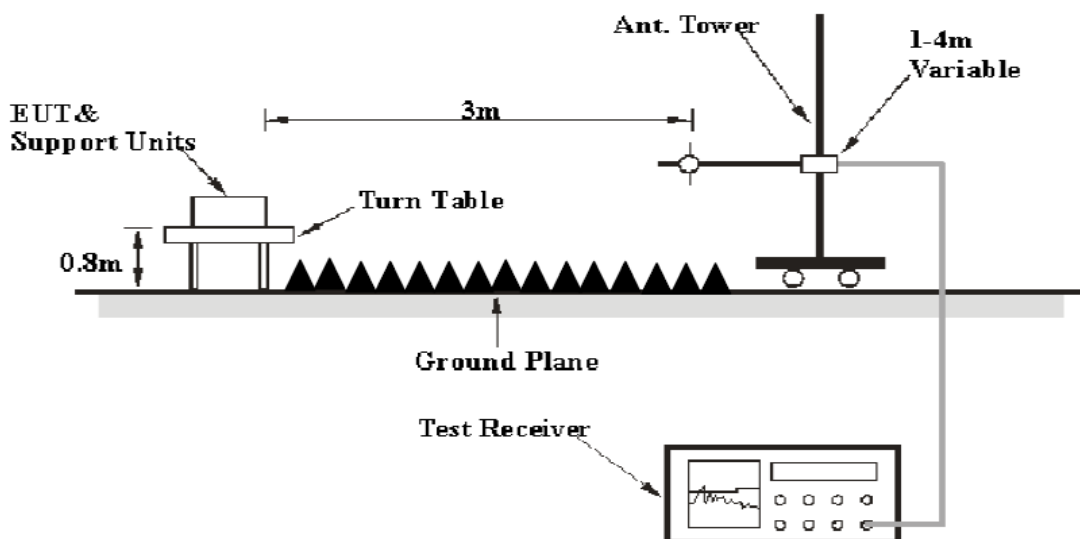

The radiated emission tests were performed in the 3 meters chamber test site, using the setup accordance with the ANSI C63.4-2014. The specification used was the FCC Part 15.109 Class B limits.

The external I/O cables were draped along the test table and formed a bundle 30 to 40 cm long in the middle.

The spacing between the peripherals was 10 cm.

EMI Test Receiver Setup

The system was investigated from 30 MHz to 2 GHz.

During the radiated emission test, the EMI test receiver was set with the following configurations:

Frequency Range	RBW	Video B/W	IF B/W	Measurement
30 MHz – 1000 MHz	100 kHz	300 kHz	120 kHz	QP
Above 1 GHz	1MHz	3 MHz	/	PK
	1MHz	10 Hz	/	Ave.

Test Procedure

Maximizing procedure was performed on the highest emissions to ensure that the EUT complied with all installation combinations.

All data was recorded in the Quasi-peak detector mode from 30 MHz to 1 GHz and PK and average detector modes for frequencies above 1 GHz.

Corrected Amplitude & Margin Calculation

The Corrected Amplitude is calculated by adding the Antenna Factor and Cable Loss, and subtracting the Amplifier Gain from the Meter Reading. The basic equation is as follows:

$$\text{Corrected Amplitude} = \text{Meter Reading} + \text{Antenna Factor} + \text{Cable Loss} - \text{Amplifier Gain}$$

The “**Margin**” column of the following data tables indicates the degree of compliance with the applicable limit. For example, a margin of 7 dB means the emission is 7 dB below the limit. The equation for margin calculation is as follows:

$$\text{Margin} = \text{Limit} - \text{Corrected Amplitude}$$

Test Results Summary

According to the data in the following table, the EUT complied with the FCC §15.109 Class B,

Refer to CISPR16-4-2:2011 and CISPR 16-4-1:2009, the measured level is in compliance with the limit if

$$L_m + U_{(L_m)} \leq L_{\text{lim}} + U_{\text{cispr}}$$

In BACL, $U_{(L_m)}$ is less than U_{cispr} , if L_m is less than L_{lim} , it implies that the EUT complies with the limit.

Test Data

Environmental Conditions

Temperature:	25 °C
Relative Humidity:	56 %
ATM Pressure:	101.0 kPa

The testing was performed by Yooube on 2019-04-10 and 2019-05-14.

EUT Operation Mode: Ping IP

**AC Power:
30 MHz~1 GHz:**

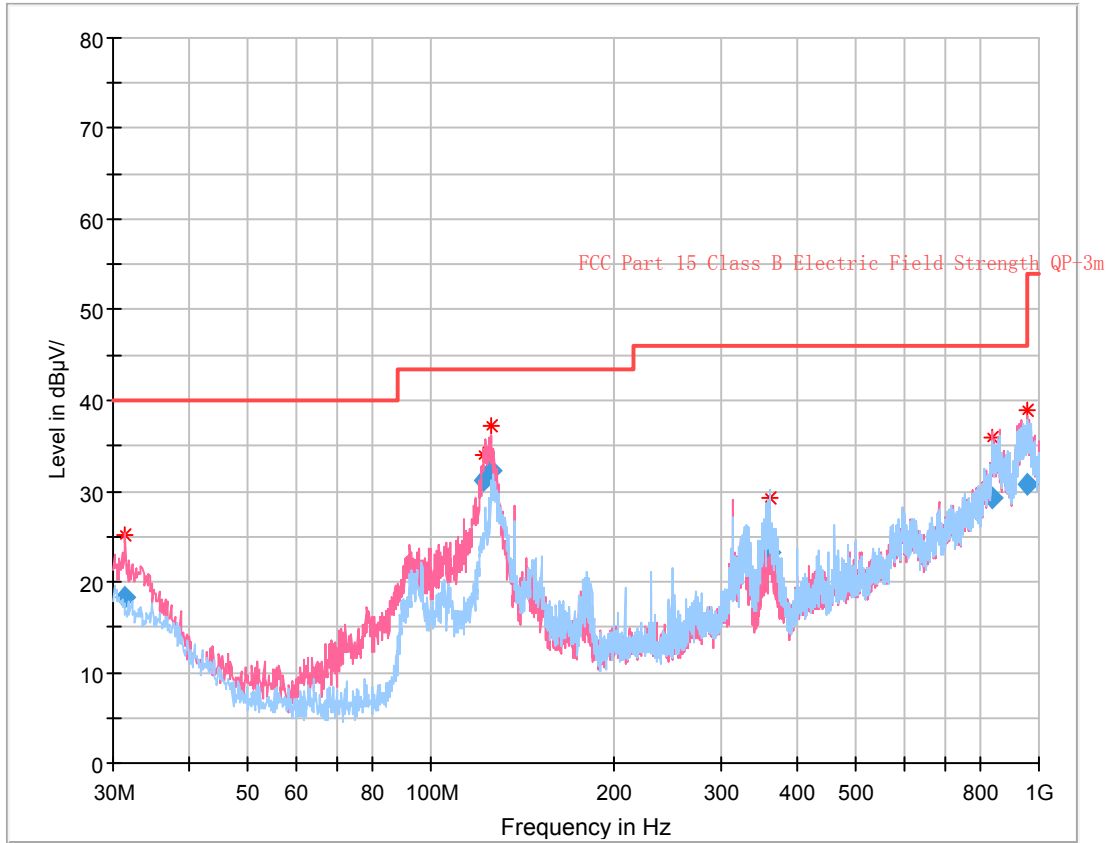

Frequency (MHz)	Corrected Amplitude (dBµV/m)	Antenna height (cm)	Antenna Polarity	Turntable position (degree)	Correction Factor (dB/m)	Limit (dBµV/m)	Margin (dB)
31.369250	18.20	100.0	V	192.0	-8.5	40.00	21.80
122.140250	31.25	100.0	V	161.0	-14.1	43.50	12.25
125.590375	32.16	100.0	V	162.0	-13.9	43.50	11.34
360.160000	23.21	109.0	H	281.0	-10.7	46.00	22.79
837.898750	29.34	246.0	V	231.0	5.7	46.00	16.66
958.289250	30.74	150.0	V	355.0	9.3	46.00	15.26

1 GHz – 2 GHz:

Frequency (MHz)	Receiver		Turntable Degree	Rx Antenna		Corrected Factor (dB/m)	Corrected Amplitude (dBuV/m)	FCC Part 15B	
	Reading (dBμV)	PK/QP/Ave.		Height (m)	Polar (H / V)			Limit (dBuV/m)	Margin (dB)
1054.30	43.43	PK	46	2.3	H	-4.79	38.64	74	35.36
1054.30	30.21	Ave.	46	2.3	H	-4.79	25.42	54	28.58
1054.30	42.56	PK	10	1.8	V	-4.79	37.77	74	36.23
1054.30	29.31	Ave.	10	1.8	V	-4.79	24.52	54	29.48
1979.00	43.66	PK	79	2.0	H	-1.60	42.06	74	31.94
1979.00	30.23	Ave.	79	2.0	H	-1.60	28.63	54	25.37
1979.00	42.55	PK	209	1.7	V	-1.60	40.95	74	33.05
1979.00	29.35	Ave.	209	1.7	V	-1.60	27.75	54	26.25

Pre-scan for peak

Horizontal – Peak (1-2 GHz)

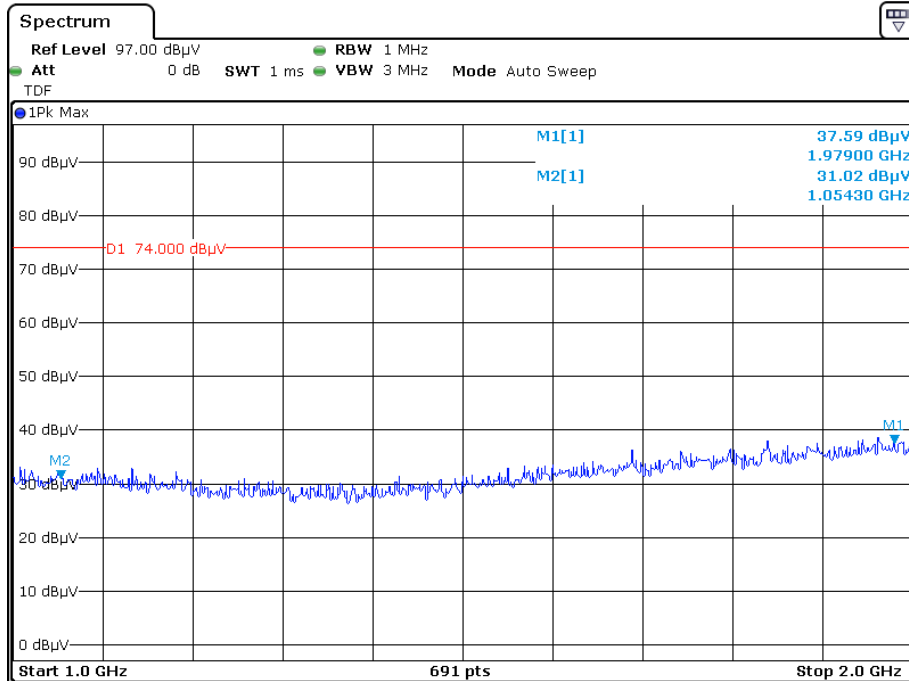

Date: 10.APR.2019 15:21:28

Vertical - Peak (1-2 GHz)

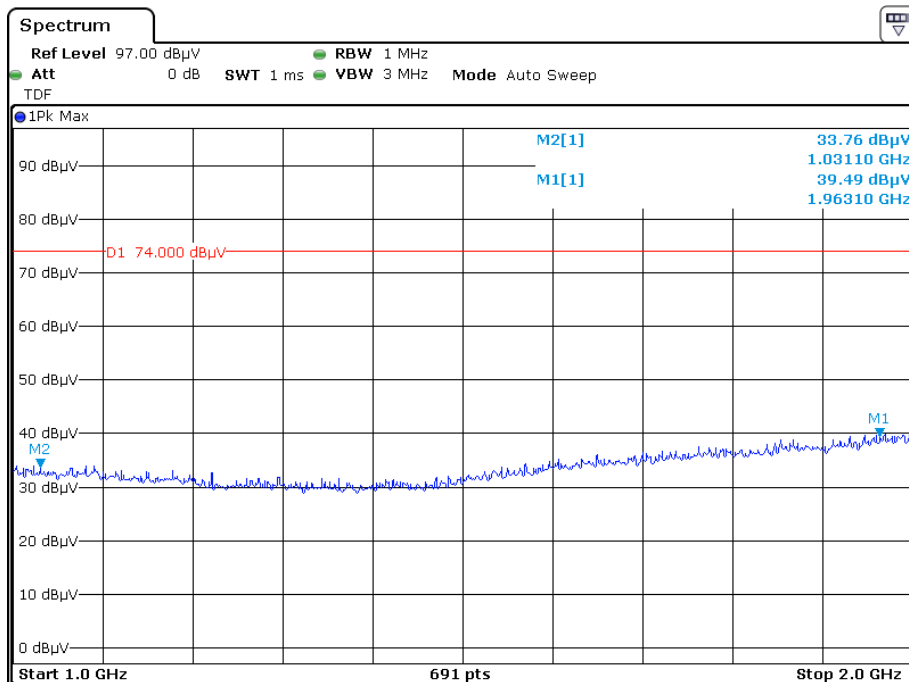

Date: 10.APR.2019 15:27:51

Horizontal – Average

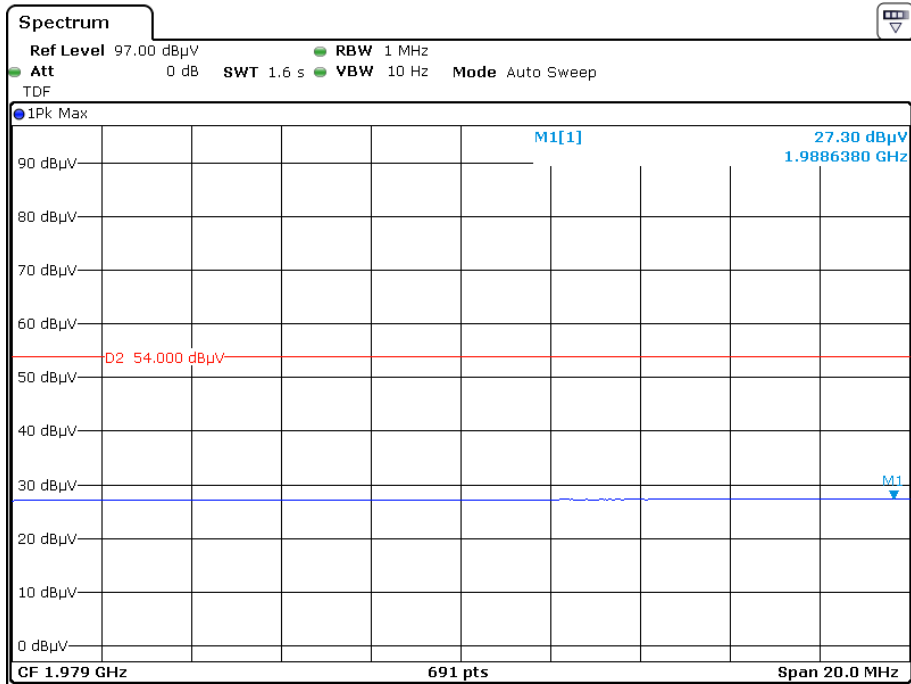

Date: 10.APR.2019 15:24:20

Vertical – Average

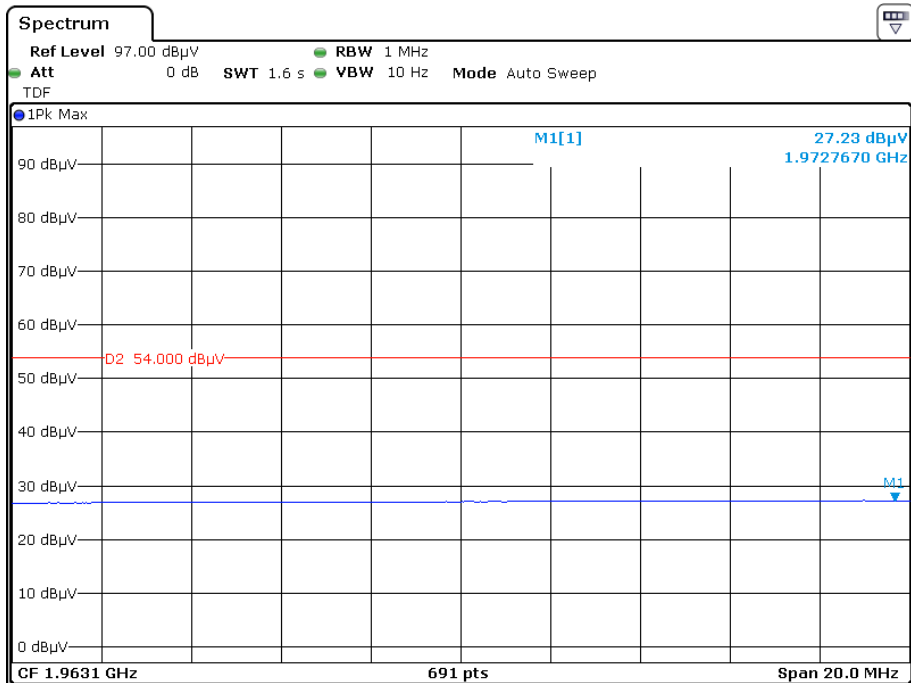

Date: 10.APR.2019 15:30:28

DC Power:

30 MHz~1 GHz:

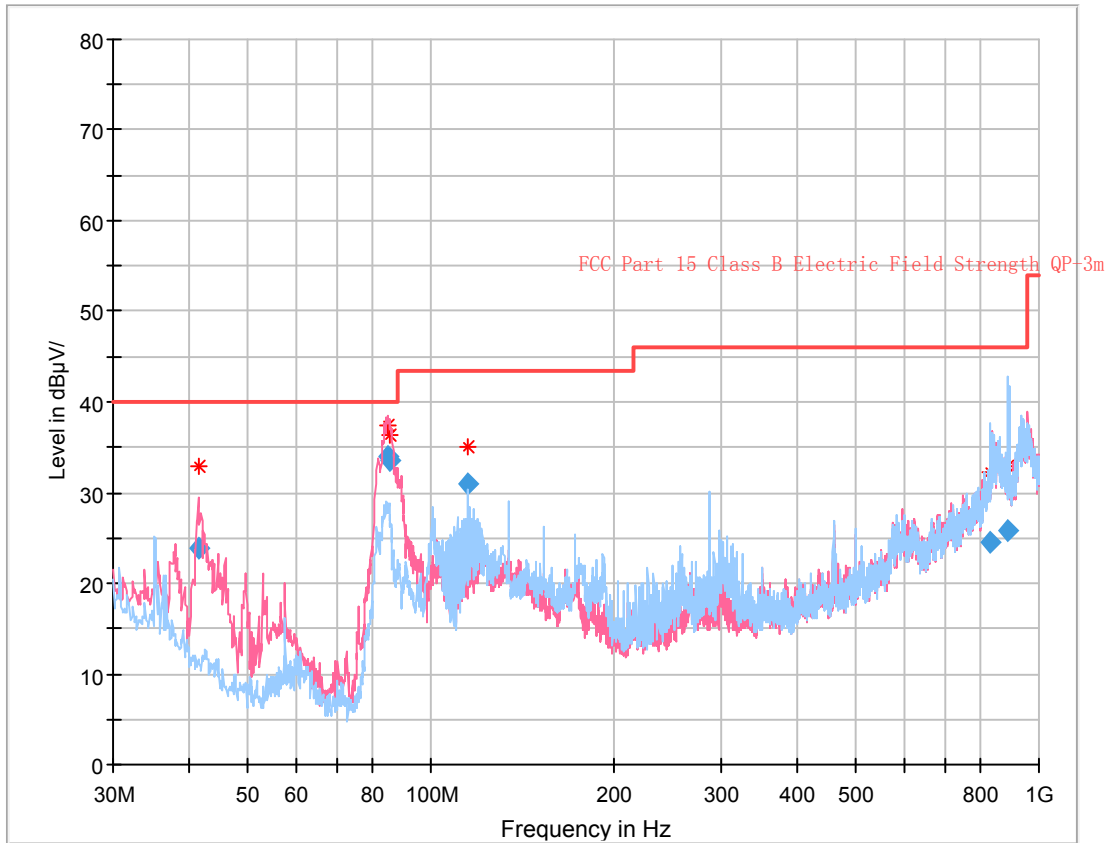

Frequency (MHz)	Corrected Amplitude (dBµV/m)	Antenna height (cm)	Antenna Polarity	Turntable position (degree)	Correction Factor (dB/m)	Limit (dBµV/m)	Margin (dB)
41.405875	23.92	100.0	V	77.0	-14.8	40.00	16.08
84.803500	33.96	164.0	V	300.0	-19.5	40.00	6.04
85.893375	33.45	150.0	V	283.0	-19.4	40.00	6.55
115.194625	30.88	291.0	H	65.0	-14.8	43.50	12.62
829.021750	24.62	293.0	H	74.0	4.8	46.00	21.38
890.864375	25.73	309.0	H	317.0	4.7	46.00	20.27

1 GHz – 2 GHz:

Frequency (MHz)	Receiver		Turntable Degree	Rx Antenna		Corrected Factor (dB/m)	Corrected Amplitude (dBuV/m)	FCC Part 15B	
	Reading (dBμV)	PK/QP/Ave.		Height (m)	Polar (H / V)			Limit (dBuV/m)	Margin (dB)
1135.23	43.62	PK	341	2.1	H	-5.43	38.19	74	35.81
1135.23	29.34	Ave.	341	2.1	H	-5.43	23.91	54	30.09
1135.23	42.54	PK	60	1.7	V	-5.43	37.11	74	36.89
1135.23	29.08	Ave.	60	1.7	V	-5.43	23.65	54	30.35
1959.92	43.39	PK	213	1.8	H	-1.39	42.00	74	32.00
1959.92	29.44	Ave.	213	1.8	H	-1.39	28.05	54	25.95
1959.92	42.31	PK	309	1.1	V	-1.39	40.92	74	33.08
1959.92	29.14	Ave.	309	1.1	V	-1.39	27.75	54	26.25

Note:

- 1) Correction Factor=Antenna factor (RX) + cable loss – amplifier factor
- 2) Corrected Amplitude = Correction Factor + Reading
- 3) Margin = Limit - Corrected Amplitude

Pre-scan for peak

Horizontal - Peak (1-2 GHz)

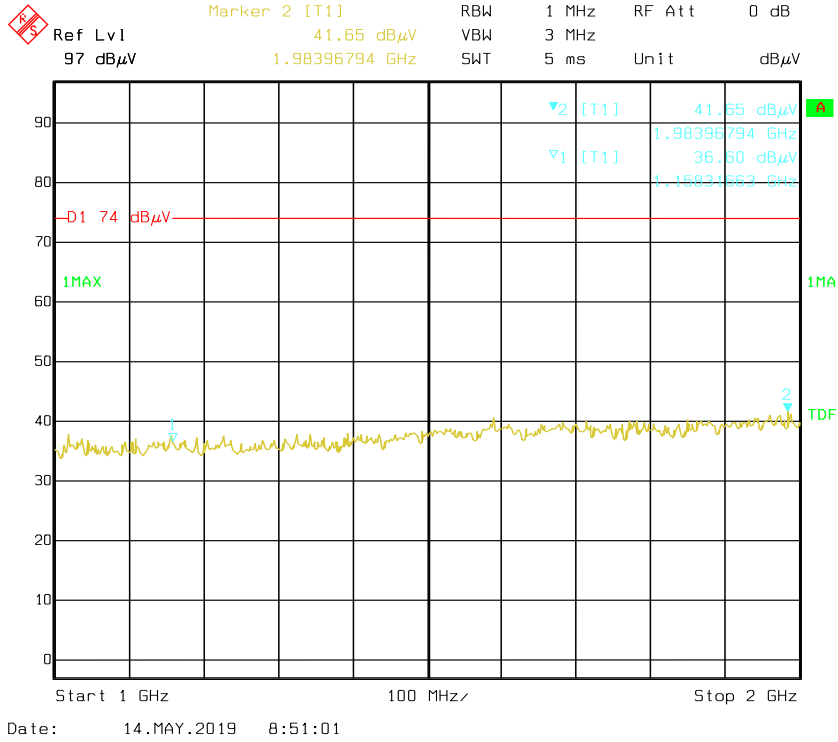

Vertical - Peak (1-2 GHz)

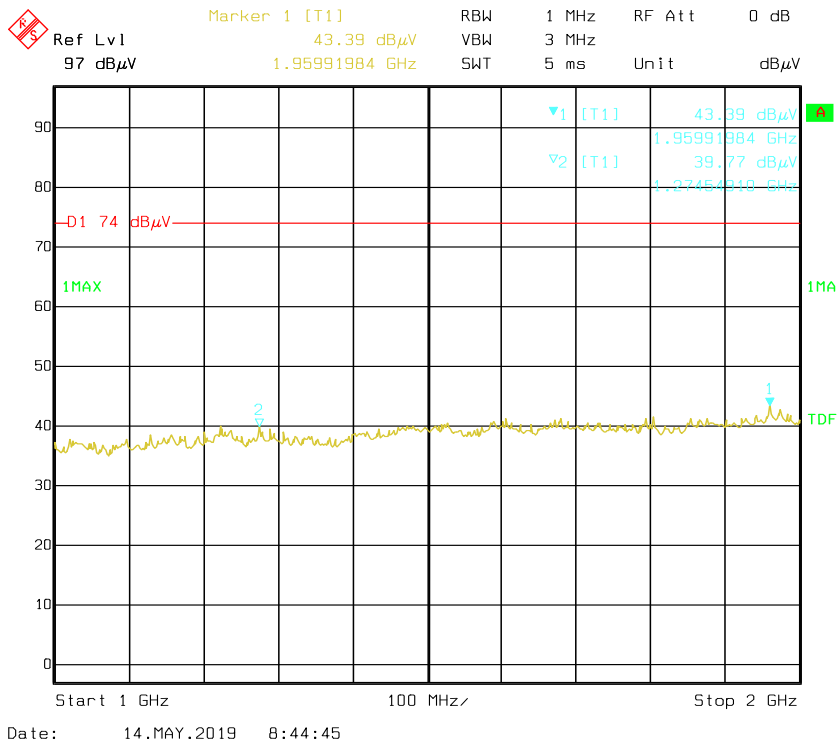

Horizontal – Average

Ref Lvl 97 dB μ V
Marker 2 [T1] 28.12 dB μ V
1.97404810 GHz
RBW 1 MHz
VBW 10 Hz
RF Att 0 dB
SWT 5 s
Unit dB μ V

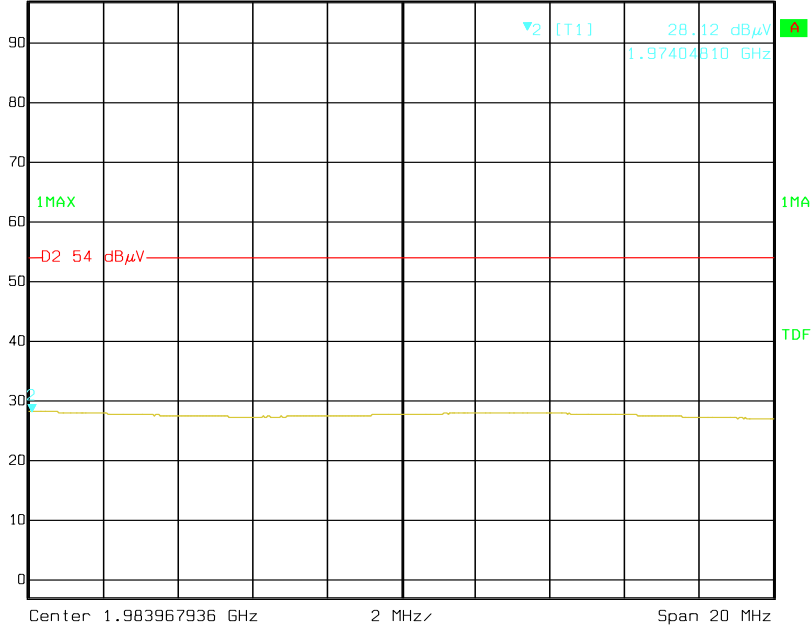

Date: 14.MAY.2019 8:53:07

Vertical – Average

Ref Lvl 97 dB μ V
Marker 1 [T1] 28.35 dB μ V
1.96991984 GHz
RBW 1 MHz
VBW 10 Hz
RF Att 0 dB
SWT 5 s
Unit dB μ V

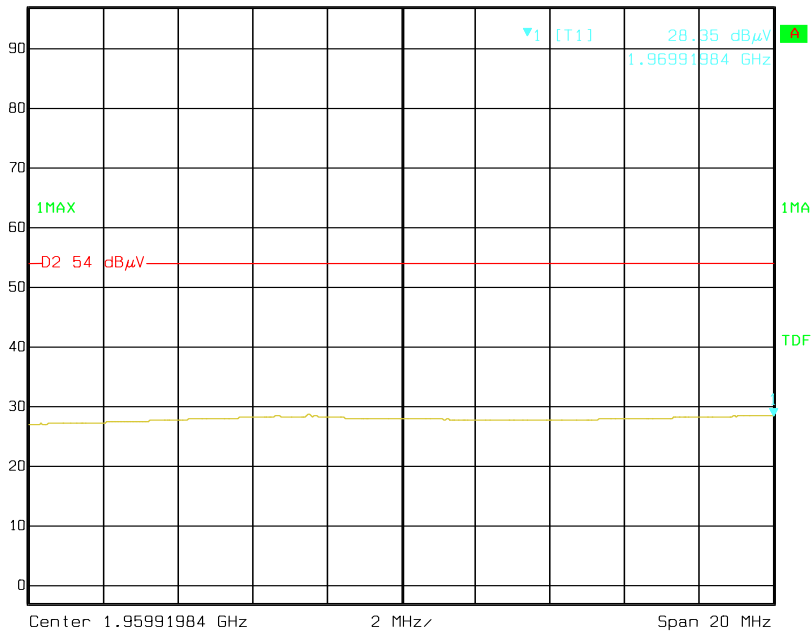

Date: 14.MAY.2019 8:47:08

***** END OF REPORT *****