



FCC REPORT

Report Reference No..... : CHTEW2206015801 Report verification: 

Project No..... : SHT2206032304EW

FCC ID..... : 2AQV7E360

Applicant's name..... : CALTTA TECHNOLOGIES CO., LTD.

Address..... : Floor 12,Building G2, international E-City, Nanshan District,
Shenzhen, China, 518055

Test item description : **Broadband Portable Radio**

Trade Mark : eChat, Caltta

Model/Type reference..... : e360

Listed Model(s) : -

Standard : **FCC CFR Title 47 Part 2**
FCC CFR Title 47 Part 22
FCC CFR Title 47 Part 27

Date of receipt of test sample..... : Dec. 10, 2020

Date of testing..... : Dec. 11, 2020- Dec. 28, 2020

Date of issue..... : Jun.29, 2022

Result..... : **Pass**

Compiled by
 (position+printed name+signature)... : File administrators Fanghui Zhu 

Supervised by
 (position+printed name+signature)... : Project Engineer Caspar Chen 

Approved by
 (position+printedname+signature).... : Manager Hans Hu 

Testing Laboratory Name : **Shenzhen Huatongwei International Inspection Co., Ltd.**

Address..... : 1/F, Bldg 3, Hongfa Hi-tech Industrial Park, Genuyu Road,
Tianliao, Gongming, Shenzhen, China

Shenzhen Huatongwei International Inspection Co., Ltd. All rights reserved.

This publication may be reproduced in whole or in part for non-commercial purposes as long as the Shenzhen Huatongwei International Inspection Co., Ltd. is acknowledged as copyright owner and source of the material. Shenzhen Huatongwei International Inspection Co., Ltd. takes no responsibility for and will not assume liability for damages resulting from the reader's interpretation of the reproduced material due to its placement and context.

The test report merely correspond to the test sample.

1.	<u>TEST STANDARDS AND REPORT VERSION</u>	3
1.1.	Applicable Standards	3
1.2.	Report version information	3
2.	<u>TEST DESCRIPTION</u>	4
3.	<u>SUMMARY</u>	5
3.1.	Client Information	5
3.2.	Product Description	6
3.3.	Operation state	7
3.4.	EUT operation mode	8
3.5.	EUT configuration	9
3.6.	Modifications	9
4.	<u>TEST ENVIRONMENT</u>	10
4.1.	Address of the test laboratory	10
4.2.	Test Facility	10
4.3.	Equipments Used during the Test	11
4.4.	Environmental conditions	12
4.5.	Statement of the measurement uncertainty	12
5.	<u>TEST CONDITIONS AND RESULTS</u>	13
5.1.	Conducted Output Power	13
5.2.	Peak-to-Average Ratio	14
5.3.	99% Occupied Bandwidth & 26 dB Bandwidth	15
5.4.	Band Edge	16
5.5.	Conducted Spurious Emissions	17
5.6.	Frequency stability VS Temperature measurement	18
5.7.	Frequency stability VS Voltage measurement	19
5.8.	ERP and EIRP	20
5.9.	Radiated Spurious Emission	26
6.	<u>TEST SETUP PHOTOS OF THE EUT</u>	35
7.	<u>EXTERNAL AND INTERNAL PHOTOS OF THE EUT</u>	35
8.	<u>APPENDIX REPORT</u>	35

1. TEST STANDARDS AND REPORT VERSION

1.1. Applicable Standards

The tests were performed according to following standards:

[FCC Rules Part 2](#): FREQUENCY ALLOCATIONS AND RADIO TREATY MATTERS; GENERAL RULES AND REGULATIONS

[FCC Rules Part 22](#): PUBLIC MOBILE SERVICES

[FCC Rules Part 27](#): MISCELLANEOUS WIRELESS COMMUNICATIONS SERVICES

[ANSI C63.26: 2015](#): American National Standard for Compliance Testing of Transmitters Used in Licensed Radio Services

[KDB 971168 D01 Power Meas License Digital Systems v03](#): MEASUREMENT GUIDANCE FOR CERTIFICATION OF LICENSED DIGITAL TRANSMITTERS

1.2. Report version information

Revision No.	Date of issue	Description
N/A	2022-06-29	Update report No. based on the report CHTEW20120156

2. Test Description

Test Item	Section in CFR 47	Result	Test Engineer
Conducted Output Power	Part 2.1046 Part 22.913(a) Part 27.50	Pass	Jiongsheng Feng
Peak-to-Average Ratio	Part 27.50	Pass	Jiongsheng Feng
99% Occupied Bandwidth & 26 dB Bandwidth	Part 2.1049 Part 22.917(b) Part 27.53	Pass	Jiongsheng Feng
Band Edge	Part 2.1051 Part 22.917 Part 27.53	Pass	Jiongsheng Feng
Conducted Spurious Emissions	Part 2.1051 Part 22.917 Part 27.53	Pass	Jiongsheng Feng
Frequency stability VS Temperature	Part 2.1055(a)(1)(b) Part 22.355 Part 27.54	Pass	Jiongsheng Feng
Frequency stability VS Voltage	Part 2.1055(d)(1)(2) Part 22.355 Part 27.54	Pass	Jiongsheng Feng
ERP and EIRP	Part 22.913(a) Part 27.50	Pass	Shower Dai
Radiated Spurious Emissions	Part 2.1053 Part 22.917 Part 27.53	Pass	Pan Xie

Note: The measurement uncertainty is not included in the test result.

3. SUMMARY

3.1. Client Information

Applicant:	CALTTA TECHNOLOGIES CO., LTD.
Address:	Floor 12,Building G2, international E-City, Nanshan District, Shenzhen, China, 518055
Manufacturer:	CALTTA TECHNOLOGIES CO., LTD.
Address:	Floor 12,Building G2, international E-City, Nanshan District, Shenzhen, China, 518055

3.2. Product Description

Name of EUT:	Broadband Portable Radio		
Trade Mark:	eChat, Caltta		
Model No.:	e360		
Listed Model(s):	-		
SIM Information:	Support One SIM Card		
Power supply:	DC 3.7V		
Adapter information:	Model:ES085H-X120100XYF Input:100-240Va.c. 50/60Hz 0.5A Output: 12.0Vd.c. 1.0A		
Battery information:	Battery 1	Moel: AB320 Technical data:3.7V, 5100mAh Manufacturer: FPR Connectivity Technology Inc	
	Battery 2(Add)	Model: AB260 Battery capacity: 5100mAh/18.87Wh Nominal voltage: 3.7V	
Hardware version:	e320MB_B		
Software version:	e360V1.0		
4G			
Operation Band:	<input type="checkbox"/> FDD Band 2	<input checked="" type="checkbox"/> FDD Band 4	<input checked="" type="checkbox"/> FDD Band 5
	<input checked="" type="checkbox"/> FDD Band 7	<input type="checkbox"/> FDD Band 12	<input type="checkbox"/> FDD Band 17
Transmit frequency:	FDD Band 4:	1710.7 MHz – 1754.3 MHz	
	FDD Band 5:	824.7 MHz – 848.3 MHz	
	FDD Band 7:	2502.5 MHz – 2567.5 MHz	
Receive frequency:	FDD Band 4:	2110.7 MHz – 2154.3 MHz	
	FDD Band 5:	869.7 MHz – 893.3 MHz	
	FDD Band 7:	2622.5 MHz – 2687.5 MHz	
Channel bandwidth:	FDD Band 4:	1.4MHz, 3MHz, 5MHz, 10MHz, 15MHz, 20MHz	
	FDD Band 5:	1.4MHz, 3MHz, 5MHz, 10MHz	
	FDD Band 7:	5MHz, 10MHz, 15MHz, 20MHz	
Power Class:	Class 3		
Modulation type:	QPSK, 16QAM		
Antenna type	Stick antenna		
Antenna Gain	Band4:1.9dBi; Band5:-0.2dBi; Band7:1.9dBi		

3.3. Operation state

➤ **Test frequency list**

FDD Band 4	Test Frequency ID	Bandwidth [MHz]	N _{UL}	Frequency of Uplink [MHz]	N _{DL}	Frequency of Downlink [MHz]
	Low Range	1.4	1996.7	1710.7	195.7	2110.7
		3	19965	1711.5	1965	2111.5
		5	19975	1712.5	1975	2112.5
		10	20000	1715	2000	2115
		15	20025	1717.5	2025	2117.5
	Mid Range	20	20050	1720	2050	2120
		1.4/3.5/10/15/20	20175	1732.5	2175	2132.5
	High Range	1.4	20393	1754.3	2393	2154.3
		3	20385	1753.5	2385	2153.5
		5	20375	1752.5	2375	2152.5
		10	20350	1750	2350	2150
		15	20325	1747.5	2325	2147.5
	20	20300	1745	2300	2145	

FDD Band 5	Test Frequency ID	Bandwidth [MHz]	N _{UL}	Frequency of Uplink [MHz]	N _{DL}	Frequency of Downlink [MHz]
	Low Range	1.4	20407	824.7	2407	865.7
		3	20415	825.5	2415	875.5
		5	20425	825.5	2425	877.5
		10 ⁽¹⁾	20450	829	2450	874
	Mid Range	1.4/3.5/10/15	20525	838.5	2525	881.5
		1.4	20543	849.3	2543	893.3
	High Range	3	20635	847.5	2635	882.5
		5	20625	848.5	2625	881.5
		10 ⁽¹⁾	20600	844	2600	885

NOTE 1: Bandwidth for which a relaxation of the specified UE receiver sensitivity requirement (TS 36.101 [27] Clause 7.3) is allowed.

FDD Band 7	Test Frequency ID	Bandwidth [MHz]	N _{UL}	Frequency of Uplink [MHz]	N _{DL}	Frequency of Downlink [MHz]
	Low Range	5	20775	2502.5	2775	2622.5
		10	20800	2505	2800	2625
		15	20825	2507.5	2825	2627.5
		20 ⁽¹⁾	20850	2510	2850	2630
	Mid Range	5/10/15/20 ⁽¹⁾	21100	2535	3100	2655
		5	21425	2567.5	3425	2687.5
	High Range	10	21400	2565	3400	2685
		15	21375	2562.5	3375	2682.5
		20 ⁽¹⁾	21350	2560	3350	2680

NOTE 1: Bandwidth for which a relaxation of the specified UE receiver sensitivity requirement (TS 36.101 [27] Clause 7.3) is allowed.

3.4. EUT operation mode

For RF test items

The EUT has been tested under typical operating condition. Testing was performed by configuring EUT to maximum output power status.

Test Items	Band	Bandwidth (MHz)						Modulation		RB #		
		1.4	3	5	10	15	20	QPSK	16QAM	1	Half	Full
Conducted Output Power	4	o	o	o	o	o	o	o	o	o	o	o
	5	o	o	o	o	-	-	o	o	o	o	o
	7	-	-	o	o	o	o	o	o	o	o	o
Peak-to-Average Ratio	4	o	o	o	o	o	o	o	o	o	-	o
	5	o	o	o	o	-	-	o	o	o	-	o
	7	-	-	o	o	o	o	o	o	o	-	o
99% Occupied Bandwidth & 26 dB Bandwidth	4	o	o	o	o	o	o	o	o	-	-	o
	5	o	o	o	o	-	-	o	o	-	-	o
	7	-	-	o	o	o	o	o	o	-	-	o
Band Edge	4	o	o	o	o	o	o	o	o	o	-	o
	5	o	o	o	o	-	-	o	o	o	-	o
	7	-	-	o	o	o	o	o	o	o	-	o
Conducted Spurious Emission	4	o	o	o	o	o	o	o	o	o	-	-
	5	o	o	o	o	-	-	o	o	o	-	-
	7	-	-	o	o	o	o	o	o	o	-	-
Frequency Stability	4	o	o	o	o	o	o	o	o	-	-	o
	5	o	o	o	o	-	-	o	o	-	-	o
	7	-	-	o	o	o	o	o	o	-	-	o
ERP and EIRP	4	o	o	o	o	o	o	o	o	o	-	-
	5	o	o	o	o	-	-	o	o	o	-	-
	7	-	-	o	o	o	o	o	o	o	-	-
Radiated Spurious Emission	4	o	o	o	o	o	o	o	o	o	-	-
	5	o	o	o	o	-	-	o	o	o	-	-
	7	-	-	o	o	o	o	o	o	o	-	-
Remark	1. The mark "o" means that this configuration is chosen for testing 2. The mark "-" means that this bandwidth is not test. 3. The device is investigated from 30MHz to 10 times of fundamental signal for radiated spurious emission test under different RB size/offset and modulations in exploratory test. Subsequently, only the worst case emissions are reported.											

3.5. EUT configuration

The following peripheral devices and interface cables were connected during the measurement:

- - supplied by the manufacturer
- - supplied by the lab

○ /	Manufacturer:	/
	Model No.:	/
○ /	Manufacturer:	/
	Model No.:	/

3.6. Modifications

No modifications were implemented to meet testing criteria.

4. TEST ENVIRONMENT

4.1. Address of the test laboratory

Laboratory: Shenzhen Huatongwei International Inspection Co., Ltd.

Address: 1/F, Bldg 3, Hongfa Hi-tech Industrial Park, Genyu Road, Tianliao, Gongming, Shenzhen, China

4.2. Test Facility

Laboratory Name	Shenzhen Huatongwei International Inspection Co., Ltd.	
Laboratory Location	1/F, Bldg 3, Hongfa Hi-tech Industrial Park, Genyu Road, Tianliao, Gongming, Shenzhen, China	
Connect information:	Tel: 86-755-26715499 E-mail: cs@szhtw.com.cn http://www.szhtw.com.cn	
Qualifications	Type	Accreditation Number
	FCC	762235

4.3. Equipments Used during the Test

Used	Test Equipment	Manufacturer	Equipment No.	Model No.	Serial No.	Last Cal. Date (YY-MM-DD)	Next Cal. Date (YY-MM-DD)
●	Signal and spectrum Analyzer	R&S	HTWE0242	FSV40	100048	2020/10/19	2021/10/18
●	Signal & Spectrum Analyzer	R&S	HTWE0262	FSW26	103440	2020/10/19	2021/10/18
●	Spectrum Analyzer	Agilent	HTWE0286	N9020A	MY50510187	2020/10/19	2021/10/18
●	Radio communication tester	R&S	HTWE0287	CMW500	137688-Lv	2020/10/19	2021/10/18
●	Test software	Tonscend	N/A	JS1120	N/A	N/A	N/A

● Radiated Spurious Emission

Used	Test Equipment	Manufacturer	Equipment No.	Model No.	Serial No.	Last Cal. Date (YY-MM-DD)	Next Cal. Date (YY-MM-DD)
●	Semi-Anechoic Chamber	Albatross projects	HTWE0122	SAC-3m-01	N/A	2018/09/27	2021/09/26
●	Spectrum Analyzer	R&S	HTWE0098	FSP40	100597	2020/10/20	2021/10/19
●	Loop Antenna	R&S	HTWE0170	HFH2-Z2	100020	2018/04/02	2021/04/01
●	Broadband Horn Antenna	SCHWARZBECK	HTWE0103	BBHA9170	BBHA9170472	2018/10/12	2021/10/11
●	Ultra-Broadband Antenna	SCHWARZBECK	HTWE0123	VULB9163	538	2018/04/04	2021/04/03
●	Horn Antenna	SCHWARZBECK	HTWE0126	9120D	1011	2020/04/01	2023/03/31
●	Pre-amplifier	CD	HTWE0071	PAP-0102	12004	2020/11/12	2021/11/11
●	Broadband Preamplifier	SCHWARZBECK	HTWE0201	BBV 9718	9718-248	2020/05/10	2021/05/09
●	RF Connection Cable	HUBER+SUHNER	HTWE0120-01	6m 18GHz S Serisa	N/A	2020/05/10	2021/05/09
●	RF Connection Cable	HUBER+SUHNER	HTWE0120-02	6m 3GHz RG Serisa	N/A	2020/05/10	2021/05/09
●	RF Connection Cable	HUBER+SUHNER	HTWE0120-03	6m 3GHz RG Serisa	N/A	2020/05/10	2021/05/09
●	RF Connection Cable	HUBER+SUHNER	HTWE0120-04	6m 3GHz RG Serisa	N/A	2020/05/10	2021/05/09
●	RF Connection Cable	HUBER+SUHNER	HTWE0121-01	6m 18GHz S Serisa	N/A	2020/05/10	2021/05/09
●	EMI Test Software	Audix	N/A	E3	N/A	N/A	N/A

● Auxiliary Equipment

Used	Test Equipment	Manufacturer	Equipment No.	Model No.	Serial No.	Last Cal. Date (YY-MM-DD)	Next Cal. Date (YY-MM-DD)
●	Climate chamber	ESPEC	HTWE0254	GPL-2	N/A	2020/10/21	2021/10/20
●	DC Power Supply	Gwinstek	HTWE0274	SPS-2415	GER835793	N/A	N/A

4.4. Environmental conditions

During the measurement the environmental conditions were within the listed ranges:

Voltage	VN=Nominal Voltage	DC 3.70V
	VL=Lower Voltage	DC 3.60V
	VH=Higher Voltage	DC 4.20V
Temperature	TN=Normal Temperature	25 °C
	Extreme Temperature	From -30° to + 50° centigrade
Humidity	30~60 %	
Air Pressure	950-1050 hPa	

4.5. Statement of the measurement uncertainty

The data and results referenced in this document are true and accurate. The reader is cautioned that there may be errors within the calibration limits of the equipment and facilities. The measurement uncertainty was calculated for all measurements listed in this test report acc. to TR-100028-01 "Electromagnetic compatibility and Radio spectrum Matters (ERM); Uncertainties in the measurement of mobile radio equipment characteristics; Part 1" and TR-100028-02 "Electromagnetic compatibility and Radio spectrum Matters (ERM); Uncertainties in the measurement of mobile radio equipment characteristics; Part 2" and is documented in the Shenzhen Huatongwei International Inspection Co., Ltd quality system acc. to DIN EN ISO/IEC 17025. Furthermore, component and process variability of devices similar to that tested may result in additional deviation. The manufacturer has the sole responsibility of continued compliance of the device.

Hereafter the best measurement capability for Shenzhen Huatongwei laboratory is reported:

Test Items	Measurement Uncertainty	Notes
Transmitter power conducted	0.51 dB	(1)
Transmitter power Radiated	2.66dB for <1GHz 3.44dB for >1GHz	(1)
Conducted spurious emissions 9kHz~40GHz	0.51 dB	(1)
Radiated spurious emissions	2.66dB for <1GHz 3.44dB for >1GHz	(1)
Occupied Bandwidth	15Hz for <1GHz 70Hz for >1GHz	(1)
Frequency error	15Hz for <1GHz 70Hz for >1GHz	(1)

(1) This uncertainty represents an expanded uncertainty expressed at approximately the 95% confidence level using a coverage factor of $k=1.96$.

5. TEST CONDITIONS AND RESULTS

5.1. Conducted Output Power

LIMIT

N/A

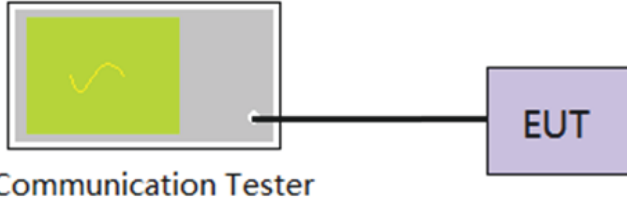
TEST CONFIGURATION**TEST PROCEDURE**

1. The EUT output port was connected to communication tester.
2. Set EUT at maximum power through communication tester.
3. Select lowest, middle, and highest channels for each band and different modulation.
4. Measure the maximum burst average power.

TEST MODE:

Please refer to the clause 3.3

TEST RESULTS **Passed** **Not Applicable**

Refer to appendix A on the section 8 appendix report

5.2. Peak-to-Average Ratio

LIMIT

13dB

TEST CONFIGURATION

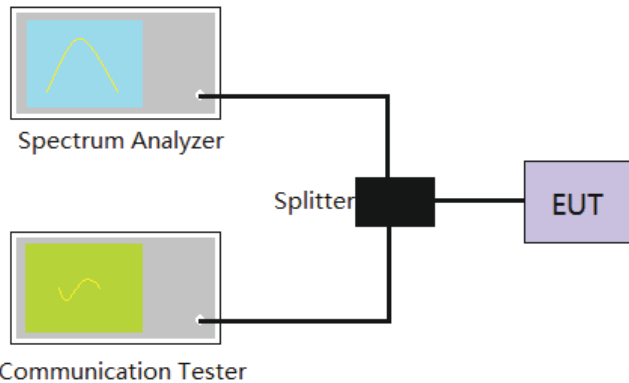

TEST PROCEDURE

1. The EUT was connected to the spectrum analyzer and communication tester via a power splitter
2. Set EUT in maximum power output.
3. Center Frequency = Carrier frequency, RBW > Emission bandwidth of signal
4. The signal analyzer was set to collect one million samples to generate the CCDF curve
5. The measurement interval was set depending on the type of signal analyzed.
 - i. For continuous signals (>98% duty cycle), the measurement interval was set to 1ms.
 - ii. For burst transmissions, the spectrum analyzer is set to use an internal " RF Burst" trigger that issynced with an incoming pulse and the measurement interval is set to less than the durationof the " on time" of one burst to ensure that energy is only captured during a time in whichthetransmitter is operating at maximum power
6. Record the maximum PAPR level associated with a probability of 0.1%.

TEST MODE:

Please refer to the clause 3.3

TEST RESULTS

Passed Not Applicable

Refer to appendix B on the section 8 appendix report

5.3. 99% Occupied Bandwidth & 26 dB Bandwidth

LIMIT

N/A

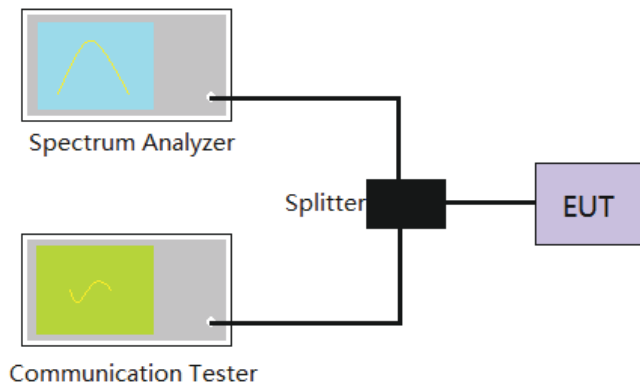
TEST CONFIGURATION**TEST PROCEDURE**

1. The EUT was connected to the spectrum analyzer and communication tester via a power splitter
2. Set EUT in maximum power output.
3. Spectrum analyzer setting as follow:
Center Frequency= Carrier frequency, RBW=1% to 5% of the anticipated OBW, VBW= 3 * RBW,
Detector=Peak,
Trace maximum hold.
4. Record the value of 99% Occupied bandwidth and 26dB bandwidth.

TEST MODE:

Please refer to the clause 3.3

TEST RESULTS **Passed** **Not Applicable**

Refer to appendix C on the section 8 appendix report

5.4. Band Edge

LIMIT

Part 22.917 and Part 27.53 specify that the power of any emission outside of the authorized operating frequency ranges must be attenuated below the transmitting power (P) by a factor of at least $43 + 10 \log(P)$ dB.

The specification that emissions shall be attenuated below the transmitter power (P) by at least $43 + 10 \log(P)$ dB, translates in the relevant power range (1 to 0.001 W) to -13 dBm. At 1 W the specified minimum attenuation becomes 43 dB and relative to a 30 dBm (1 W) carrier becomes a limit of -13 dBm. At 0.001 W (0 dBm) the minimum attenuation is 13 dB, which again yields a limit of -13 dBm. In this way a translation of the specification from relative to absolute terms is carried out.

LTE Band 7

Part 27.53 m(4) For mobile digital stations, the attenuation factor shall be not less than $40 + 10 \log(P)$ dB on all frequencies between the channel edge and 5 megahertz from the channel edge, $43 + 10 \log(P)$ dB on all frequencies between 5 megahertz and X megahertz from the channel edge, and $55 + 10 \log(P)$ dB on all frequencies more than X megahertz from the channel edge, where X is the greater of 6 megahertz or the actual emission bandwidth as defined in paragraph (m)(6) of this section. In addition, the attenuation factor shall not be less than $43 + 10 \log(P)$ dB on all frequencies between 2490.5 MHz and 2496 MHz and $55 + 10 \log(P)$ dB at or below 2490.5 MHz. Mobile Satellite Service licensees operating on frequencies below 2495 MHz may also submit a documented interference complaint against BRS licensees operating on channel BRS Channel 1 on the same terms and conditions as adjacent channel BRS or EBS licensees. Limit <-25 dBm

TEST CONFIGURATION

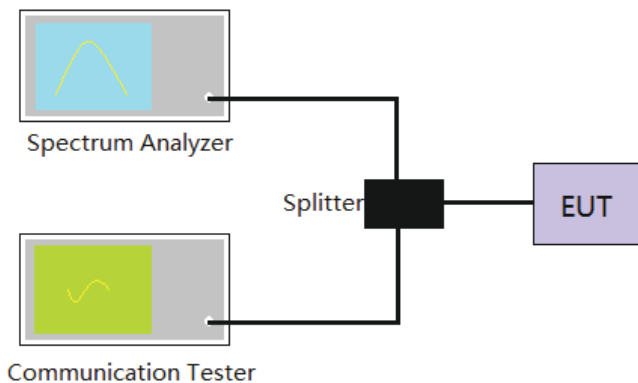

TEST PROCEDURE

1. The EUT was connected to the spectrum analyzer and communication tester via a power splitter
2. Set EUT in maximum power output.
3. The band edges of low and high channels were measured.
4. Spectrum analyzer setting as follow:
 - RBW= no less than 1% of the OBW, VBW =3 * RBW, Sweep time= Auto
5. Record the test plot.

TEST MODE:

Please refer to the clause 3.3

TEST RESULTS

Passed Not Applicable

Refer to appendix D on the section 8 appendix report

5.5. Conducted Spurious Emissions

LIMIT

Part 22.917 and Part 27.53 specify that the power of any emission outside of the authorized operating frequency ranges must be attenuated below the transmitting power (P) by a factor of at least $43 + 10 \log(P)$ dB.

The specification that emissions shall be attenuated below the transmitter power (P) by at least $43 + 10 \log(P)$ dB, translates in the relevant power range (1 to 0.001 W) to -13 dBm. At 1 W the specified minimum attenuation becomes 43 dB and relative to a 30 dBm (1 W) carrier becomes a limit of -13 dBm. At 0.001 W (0 dBm) the minimum attenuation is 13 dB, which again yields a limit of -13 dBm. In this way a translation of the specification from relative to absolute terms is carried out.

LTE Band 7

Part 27.53 m(4) For mobile digital stations, the attenuation factor shall be not less than $40 + 10 \log(P)$ dB on all frequencies between the channel edge and 5 megahertz from the channel edge, $43 + 10 \log(P)$ dB on all frequencies between 5 megahertz and X megahertz from the channel edge, and $55 + 10 \log(P)$ dB on all frequencies more than X megahertz from the channel edge, where X is the greater of 6 megahertz or the actual emission bandwidth as defined in paragraph (m)(6) of this section. In addition, the attenuation factor shall not be less than $43 + 10 \log(P)$ dB on all frequencies between 2490.5 MHz and 2496 MHz and $55 + 10 \log(P)$ dB at or below 2490.5 MHz. Mobile Satellite Service licensees operating on frequencies below 2495 MHz may also submit a documented interference complaint against BRS licensees operating on channel BRS Channel 1 on the same terms and conditions as adjacent channel BRS or EBS licensees. Limit < -25 dBm

TEST CONFIGURATION

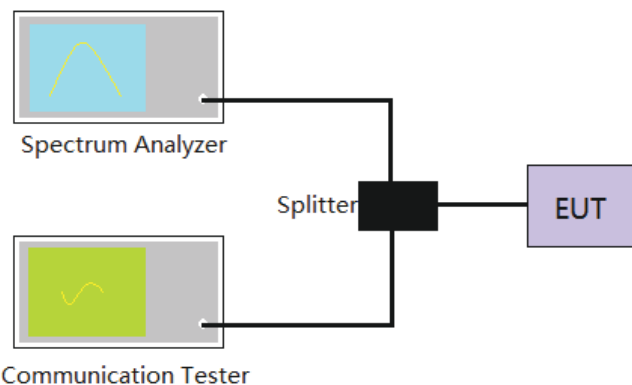

TEST PROCEDURE

1. The EUT was connected to the spectrum analyzer and communication tester via a power splitter
2. Set EUT in maximum power output.
3. Spectrum analyzer setting as follow:
 - Below 1GHz, RBW=100KHz, VBW = 300KHz, Detector=Peak, Sweep time= Auto
 - Above 1GHz, RBW=1MHz, VBW=3MHz, Detector=Peak, Sweep time= Auto
 - Scan frequency range up to 10th harmonic.
4. Record the test plot.

TEST MODE:

Please refer to the clause 3.3

TEST RESULTS

Passed **Not Applicable**

Refer to appendix E on the section 8 appendix report

5.6. Frequency stability VS Temperature measurement

LIMIT

2.5ppm

TEST CONFIGURATION

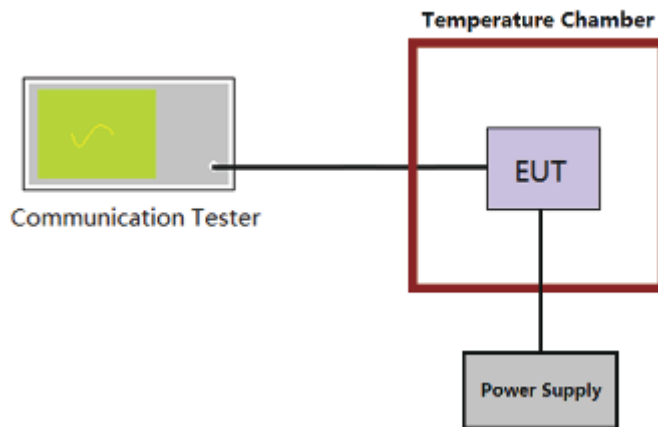

TEST PROCEDURE

1. The equipment under test was connected to an external DC power supply and input rated voltage.
2. The EUT output port was connected to communication tester.
3. The EUT was placed inside the temperature chamber.
4. Turn EUT off and set the chamber temperature to -30°C . After the temperature stabilized for approximately 30 minutes recorded the frequency.
5. Repeat step 4 measure with 10°C increased per stage until the highest temperature of $+50^{\circ}\text{C}$ reached.

TEST MODE:

Please refer to the clause 3.3

TEST RESULTS

Passed Not Applicable

Refer to appendix F on the section 8 appendix report

5.7. Frequency stability VS Voltage measurement

LIMIT

2.5ppm

TEST CONFIGURATION

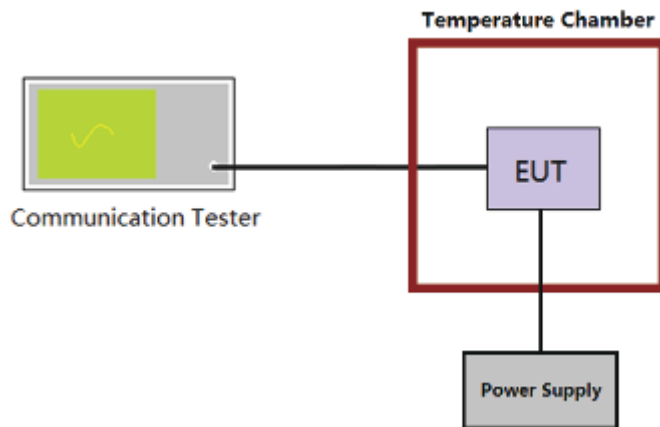

TEST PROCEDURE

1. The equipment under test was connected to an external DC power supply and input rated voltage.
2. The EUT output port was connected to communication tester.
3. The EUT was placed inside the temperature chamber at 25°C
4. The power supply voltage to the EUT was varied $\pm 15\%$ of the nominal value measured at the input to the EUT
5. Record the maximum frequency change.

TEST MODE:

Please refer to the clause 3.3

TEST RESULTS

Passed Not Applicable

Refer to appendix F on the section 8 appendix report

5.8. ERP and EIRP

LIMIT

LTE Band 7: 2W(33dBm) EIRP

LTE Band 4: 1W(30dBm) EIRP

LTE Band 5: 7W(38.50dBm) ERP

TEST CONFIGURATION

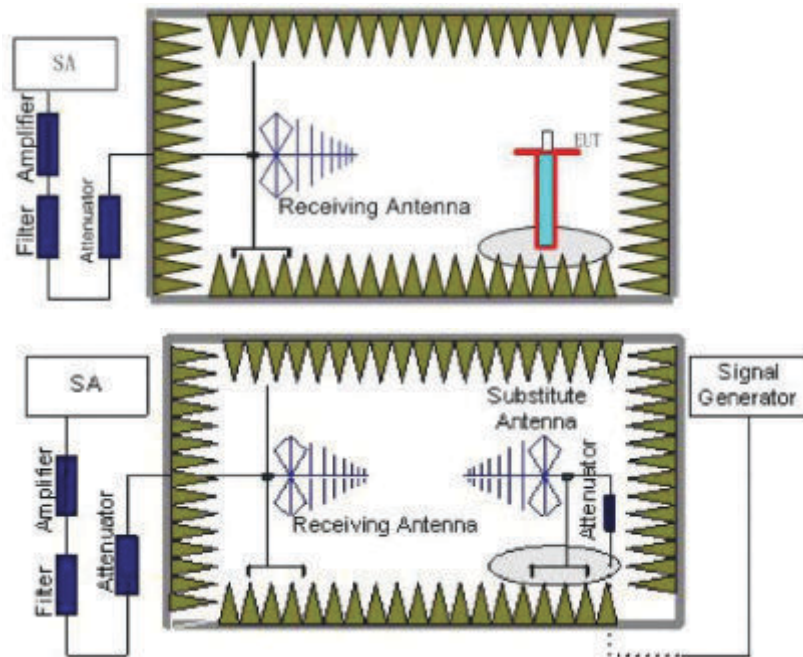

TEST PROCEDURE

1. Place the EUT in the center of the turntable.
 - a) For radiated emissions measurements performed at frequencies less than or equal to 1 GHz, the EUT shall be placed on a RF-transparent table at a nominal height of 80 cm above the reference ground plane
 - b) For radiated measurements performed at frequencies above 1 GHz, the EUT shall be placed on an RF transparent table at a nominal height of 1.5 m above the ground plane.
2. Unless the EUT uses an integral antenna, the EUT shall be terminated with a non-radiating transmitter load. In cases where the EUT uses an adjustable antenna, the antenna shall be adjusted through typical positions and lengths to maximize emissions levels.
3. The EUT shall be tested while operating on the frequency per manufacturer specification. Set the transmitter to operate in continuous transmit mode.
4. Receiver or Spectrum set as follow:
 - Below 1GHz, RBW=100kHz, VBW=300kHz, Detector=Peak, Sweep time=Auto
 - Above 1GHz, RBW=1MHz, VBW=3MHz, Detector=Peck, Sweep time=Auto
5. Each emission under consideration shall be evaluated:
 - a) Raise and lower the measurement antenna from 1 m to 4 m, as necessary to enable detection of the maximum emission amplitude relative to measurement antenna height.
 - b) Rotate the EUT through 360° to determine the maximum emission level relative to the axial position.
 - c) Return the turntable to the azimuth where the highest emission amplitude level was observed.
 - d) Vary the measurement antenna height again through 1 m to 4 m again to find the height associated with the maximum emission amplitude.
 - e) Record the measured emission amplitude level and frequency

6. Repeat step 5 for each emission frequency with the measurement antenna oriented in both the horizontal and vertical polarizations to determine the orientation that gives the maximum emissions amplitude.
7. Set-up the substitution measurement with the reference point of the substitution antenna located as near as possible to where the center of the EUT radiating element was located during the initial EUT measurement.
8. Maintain the previous measurement instrument settings and test set-up, with the exception that the EUT is removed and replaced by the substitution antenna.
9. Connect a signal generator to the substitution antenna; locate the signal generator so as to minimize any potential influences on the measurement results. Set the signal generator to the frequency where emissions are detected, and set an output power level such that the radiated signal can be detected by the measurement instrument, with sufficient dynamic range relative to the noise floor.
10. For each emission that was detected and measured in the initial test
 - a) Vary the measurement antenna height between 1 m to 4 m to maximize the received (measured) signal amplitude.
 - b) Adjust the signal generator output power level until the amplitude detected by the measurement instrument equals the amplitude level of the emission previously measured directly in step 5 and step 6.
 - c) Record the output power level of the signal generator when equivalence is achieved in step b).
11. Repeat step 8 through step 10 with the measurement antenna oriented in the opposite polarization.
12. Calculate the emission power in dBm referenced to a half-wave dipole using the following equation:
$$P_e = P_s(\text{dBm}) - \text{cable loss (dB)} + \text{antenna gain (dBd)}$$
where
 P_e = equivalent emission power in dBm
 P_s = source (signal generator) power in dBm
NOTE—dBd refers to the measured antenna gain in decibels relative to a half-wave dipole.
13. Correct the antenna gain of the substitution antenna if necessary to reference the emission power to a half-wave dipole. When using measurement antennas with the gain specified in dBi, the equivalent dipole-referenced gain can be determined from:
$$\text{gain (dBd)} = \text{gain (dBi)} - 2.15 \text{ dB.}$$
If necessary, the antenna gain can be calculated from calibrated antenna factor information
14. Provide the complete measurement results as a part of the test report.

TEST MODE:

Please refer to the clause 3.3

TEST RESULTS

Passed **Not Applicable**

LTE Band 4-1.4MHz					
Modulation	Channel	EIRP (dBm)		Limit (dBm)	Result
		Vertical	Horizontal		
QPSK	Low	22.19	20.40	<30.00	PASS
	Mid	22.62	20.78		
	High	22.65	20.46		
16QAM	Low	20.20	18.94		
	Mid	20.58	19.35		
	High	20.50	19.15		

LTE Band 4-3MHz					
Modulation	Channel	EIRP (dBm)		Limit (dBm)	Result
		Vertical	Horizontal		
QPSK	Low	22.56	20.40	<30.00	PASS
	Mid	22.55	20.56		
	High	22.37	20.33		
16QAM	Low	20.45	19.33		
	Mid	20.77	18.90		
	High	20.76	19.34		

LTE Band 4-5MHz					
Modulation	Channel	EIRP (dBm)		Limit (dBm)	Result
		Vertical	Horizontal		
QPSK	Low	23.10	20.87	<30.00	PASS
	Mid	23.36	21.23		
	High	23.36	20.95		
16QAM	Low	20.88	19.27		
	Mid	21.18	20.15		
	High	20.99	19.41		

LTE Band 4-10MHz					
Modulation	Channel	EIRP (dBm)		Limit (dBm)	Result
		Vertical	Horizontal		
QPSK	Low	22.71	20.73	<30.00	PASS
	Mid	23.04	21.08		
	High	23.06	20.77		
16QAM	Low	20.59	19.20		
	Mid	20.92	19.58		
	High	20.78	19.34		

LTE Band 4-15MHz						
Modulation	Channel	EIRP (dBm)		Limit (dBm)	Result	
		Vertical	Horizontal			
QPSK	Low	23.10	20.68	<30.00	PASS	
	Mid	22.99	20.83			
	High	22.80	20.62			
16QAM	Low	20.86	19.53		<30.00	PASS
	Mid	21.13	19.38			
	High	21.06	19.50			

LTE Band 4-20MHz						
Modulation	Channel	EIRP (dBm)		Limit (dBm)	Result	
		Vertical	Horizontal			
QPSK	Low	23.16	20.73	<30.00	PASS	
	Mid	23.20	20.92			
	High	22.97	20.67			
16QAM	Low	20.84	19.60		<30.00	PASS
	Mid	21.32	19.32			
	High	21.27	19.64			

LTE Band 5-1.4MHz					
Modulation	Channel	ERP (dBm)		Limit (dBm)	Result
		Vertical	Horizontal		
QPSK	Low	22.10	20.77	<38.50	PASS
	Mid	22.34	21.06		
	High	22.31	20.99		
16QAM	Low	20.70	19.38		
	Mid	20.75	19.83		
	High	20.78	19.59		

LTE Band 5-3MHz					
Modulation	Channel	ERP (dBm)		Limit (dBm)	Result
		Vertical	Horizontal		
QPSK	Low	23.00	20.38	<38.50	PASS
	Mid	22.74	20.64		
	High	22.25	20.41		
16QAM	Low	20.76	19.88		
	Mid	20.85	19.64		
	High	20.88	19.44		

LTE Band 5-5MHz					
Modulation	Channel	ERP (dBm)		Limit (dBm)	Result
		Vertical	Horizontal		
QPSK	Low	22.66	20.59	<38.50	PASS
	Mid	22.51	20.86		
	High	22.06	20.53		
16QAM	Low	21.16	19.90		
	Mid	21.05	20.17		
	High	21.01	20.02		

LTE Band 5-10MHz					
Modulation	Channel	ERP (dBm)		Limit (dBm)	Result
		Vertical	Horizontal		
QPSK	Low	22.60	20.61	<38.50	PASS
	Mid	22.46	20.88		
	High	22.03	20.54		
16QAM	Low	21.04	19.56		
	Mid	21.13	20.03		
	High	21.19	19.80		

LTE Band 7-5MHz					
Modulation	Channel	EIRP (dBm)		Limit (dBm)	Result
		Vertical	Horizontal		
QPSK	Low	21.20	19.39	<33.00	PASS
	Mid	21.36	19.37		
	High	21.22	19.03		
16QAM	Low	19.60	18.76		PASS
	Mid	19.77	18.69		
	High	19.66	18.68		

LTE Band 7-10MHz					
Modulation	Channel	EIRP (dBm)		Limit (dBm)	Result
		Vertical	Horizontal		
QPSK	Low	21.09	19.17	<33.00	PASS
	Mid	21.16	19.00		
	High	21.05	18.99		
16QAM	Low	19.97	18.84		PASS
	Mid	19.95	18.60		
	High	19.88	18.49		

LTE Band 7-15MHz					
Modulation	Channel	EIRP (dBm)		Limit (dBm)	Result
		Vertical	Horizontal		
QPSK	Low	21.09	19.23	<33.00	PASS
	Mid	21.23	19.36		
	High	21.09	19.23		
16QAM	Low	19.73	18.56		PASS
	Mid	19.87	18.47		
	High	19.76	18.47		

LTE Band 7-20MHz					
Modulation	Channel	EIRP (dBm)		Limit (dBm)	Result
		Vertical	Horizontal		
QPSK	Low	21.05	19.32	<33.00	PASS
	Mid	21.13	19.14		
	High	21.01	19.14		
16QAM	Low	20.04	18.93		PASS
	Mid	20.27	19.00		
	High	20.08	18.97		

5.9. Radiated Spurious Emission

LIMIT

LTE Band 4/5: -13dBm;

LTE Band 7: -25dBm

TEST CONFIGURATION

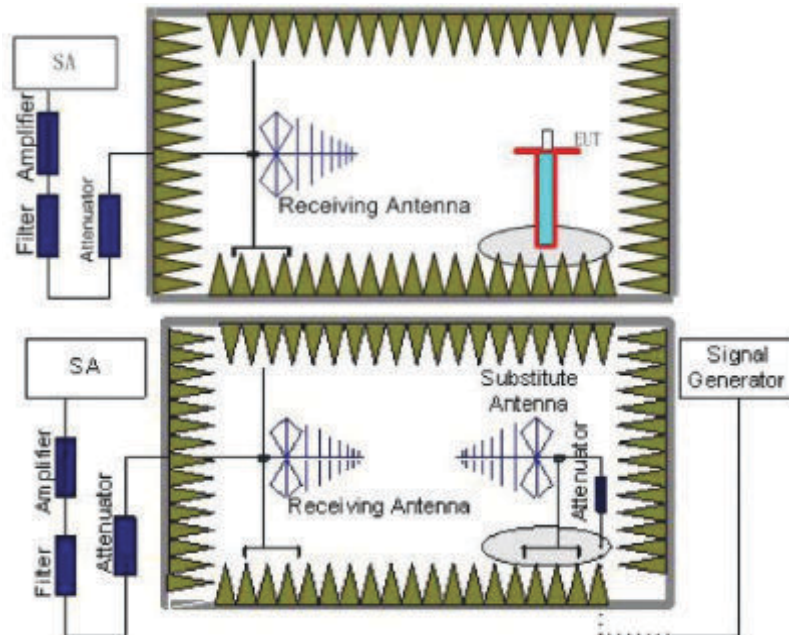

TEST PROCEDURE

1. Place the EUT in the center of the turntable.
 - a) For radiated emissions measurements performed at frequencies less than or equal to 1 GHz, the EUT shall be placed on a RF-transparent table at a nominal height of 80 cm above the reference ground plane
 - b) For radiated measurements performed at frequencies above 1 GHz, the EUT shall be placed on an RF transparent table at a nominal height of 1.5 m above the ground plane.
2. Unless the EUT uses an integral antenna, the EUT shall be terminated with a non-radiating transmitter load. In cases where the EUT uses an adjustable antenna, the antenna shall be adjusted through typical positions and lengths to maximize emissions levels.
3. The EUT shall be tested while operating on the frequency per manufacturer specification. Set the transmitter to operate in continuous transmit mode.
4. Receiver or Spectrum set as follow:
 - Below 1GHz, RBW=100kHz, VBW=300kHz, Detector=Peak, Sweep time=Auto
 - Above 1GHz, RBW=1MHz, VBW=3MHz, Detector=Peck, Sweep time=Auto
5. Each emission under consideration shall be evaluated:
 - a) Raise and lower the measurement antenna from 1 m to 4 m, as necessary to enable detection of the maximum emission amplitude relative to measurement antenna height.
 - b) Rotate the EUT through 360° to determine the maximum emission level relative to the axial position.
 - c) Return the turntable to the azimuth where the highest emission amplitude level was observed.
 - d) Vary the measurement antenna height again through 1 m to 4 m again to find the height associated with the maximum emission amplitude.
 - e) Record the measured emission amplitude level and frequency
6. Repeat step 5 for each emission frequency with the measurement antenna oriented in both the horizontal

and vertical polarizations to determine the orientation that gives the maximum emissions amplitude.

7. Set-up the substitution measurement with the reference point of the substitution antenna located as near as possible to where the center of the EUT radiating element was located during the initial EUT measurement.
8. Maintain the previous measurement instrument settings and test set-up, with the exception that the EUT is removed and replaced by the substitution antenna.
9. Connect a signal generator to the substitution antenna; locate the signal generator so as to minimize any potential influences on the measurement results. Set the signal generator to the frequency where emissions are detected, and set an output power level such that the radiated signal can be detected by the measurement instrument, with sufficient dynamic range relative to the noise floor.
10. For each emission that was detected and measured in the initial test
 - a) Vary the measurement antenna height between 1 m to 4 m to maximize the received (measured) signal amplitude.
 - b) Adjust the signal generator output power level until the amplitude detected by the measurement instrument equals the amplitude level of the emission previously measured directly in step 5 and step 6.
 - c) Record the output power level of the signal generator when equivalence is achieved in step b).
11. Repeat step 8 through step 10 with the measurement antenna oriented in the opposite polarization.
12. Calculate the emission power in dBm referenced to a half-wave dipole using the following equation:
$$P_e = P_s(\text{dBm}) - \text{cable loss (dB)} + \text{antenna gain (dBd)}$$
where
 P_e = equivalent emission power in dBm
 P_s = source (signal generator) power in dBm
NOTE—dBd refers to the measured antenna gain in decibels relative to a half-wave dipole.
13. Correct the antenna gain of the substitution antenna if necessary to reference the emission power to a half-wave dipole. When using measurement antennas with the gain specified in dBi, the equivalent dipole-referenced gain can be determined from:
$$\text{gain (dBd)} = \text{gain (dBi)} - 2.15 \text{ dB.}$$
If necessary, the antenna gain can be calculated from calibrated antenna factor information
14. Provide the complete measurement results as a part of the test report.

TEST MODE:

Please refer to the clause 3.3

TEST RESULTS

Passed **Not Applicable**

Note: only show the worse case for QPSK modulation.

LTE Band 4-1.4MHz					
Channel	Frequency (MHz)	Spurious Emission		Limit (dBm)	Result
		Polarization	Level (dBm)		
Low	3421.40	Vertical	-32.58	<-13.00	Pass
	5132.10	V	-38.36		
	6842.80	V	-38.03		
	3421.40	Horizontal	-34.40	<-13.00	Pass
	5132.10	H	-40.07		
	6842.80	H	-39.48		
Mid	3465.00	Vertical	-31.21	<-13.00	Pass
	5197.50	V	-37.07		
	6930.00	V	-36.82		
	3465.00	Horizontal	-32.73	<-13.00	Pass
	5197.50	H	-38.72		
	6930.00	H	-38.20		
High	3508.60	Vertical	-28.88	<-13.00	Pass
	5262.90	V	-34.95		
	7017.20	V	-34.80		
	3508.60	Horizontal	-30.81	<-13.00	Pass
	5262.90	H	-36.90		
	7017.20	H	-36.47		

LTE Band 4-3MHz					
Channel	Frequency (MHz)	Spurious Emission		Limit (dBm)	Result
		Polarization	Level (dBm)		
Low	3423.00	Vertical	-31.80	<-13.00	Pass
	5134.50	V	-37.56		
	6846.00	V	-37.38		
	3423.00	Horizontal	-33.13	<-13.00	Pass
	5134.50	H	-40.58		
	6846.00	H	-39.27		
Mid	3465.00	Vertical	-34.85	<-13.00	Pass
	5197.50	V	-40.61		
	6930.00	V	-39.74		
	3465.00	Horizontal	-38.99	<-13.00	Pass
	5197.50	H	-44.71		
	6930.00	H	-44.07		
High	3507.00	Vertical	-36.90	<-13.00	Pass
	5260.50	V	-42.48		
	7014.00	V	-41.51		
	3507.00	Horizontal	-41.83	<-13.00	Pass
	5260.50	H	-47.91		
	7014.00	H	-46.40		

LTE Band 4-5MHz					
Channel	Frequency (MHz)	Spurious Emission		Limit (dBm)	Result
		Polarization	Level (dBm)		
Low	3425.00	Vertical	-40.65	<-13.00	Pass
	5137.50	V	-45.23		
	6850.00	V	-45.24		
	3425.00	Horizontal	-43.33	<-13.00	Pass
	5137.50	H	-49.32		
	6850.00	H	-47.60		
Mid	3465.00	Vertical	-41.77	<-13.00	Pass
	5197.50	V	-46.29		
	6930.00	V	-46.23		
	3465.00	Horizontal	-44.65	<-13.00	Pass
	5197.50	H	-50.39		
	6930.00	H	-48.61		
High	3505.00	Vertical	-43.39	<-13.00	Pass
	5257.50	V	-47.77		
	7010.00	V	-47.63		
	3505.00	Horizontal	-45.71	<-13.00	Pass
	5257.50	H	-51.38		
	7010.00	H	-49.45		

LTE Band 4-10MHz					
Channel	Frequency (MHz)	Spurious Emission		Limit (dBm)	Result
		Polarization	Level (dBm)		
Low	3430.00	Vertical	-46.26	<-13.00	Pass
	5145.00	V	-49.52		
	6860.00	V	-48.70		
	3430.00	Horizontal	-45.97	<-13.00	Pass
	5145.00	H	-51.62		
	6860.00	H	-49.66		
Mid	3465.00	Vertical	-46.45	<-13.00	Pass
	5197.50	V	-49.70		
	6930.00	V	-49.23		
	3465.00	Horizontal	-46.18	<-13.00	Pass
	5197.50	H	-51.79		
	6930.00	H	-49.82		
High	3500.00	Vertical	-46.71	<-13.00	Pass
	5250.00	V	-49.94		
	7000.00	V	-49.46		
	3500.00	Horizontal	-46.38	<-13.00	Pass
	5250.00	H	-51.98		
	7000.00	H	-49.98		

LTE Band 4-15MHz					
Channel	Frequency (MHz)	Spurious Emission		Limit (dBm)	Result
		Polarization	Level (dBm)		
Low	3435.00	Vertical	-47.40	<-13.00	Pass
	5152.50	V	-50.64		
	6870.00	V	-50.01		
	3435.00	Horizontal	-48.67	<-13.00	Pass
	5152.50	H	-54.13		
	6870.00	H	-53.95		
Mid	3465.00	Vertical	-51.14	<-13.00	Pass
	5197.50	V	-54.15		
	6930.00	V	-53.31		
	3465.00	Horizontal	-51.57	<-13.00	Pass
	5197.50	H	-56.48		
	6930.00	H	-56.19		
High	3495.00	Vertical	-53.89	<-13.00	Pass
	5242.50	V	-56.65		
	6990.00	V	-55.69		
	3495.00	Horizontal	-54.02	<-13.00	Pass
	5242.50	H	-58.78		
	6990.00	H	-60.45		

LTE Band 4-20MHz					
Channel	Frequency (MHz)	Spurious Emission		Limit (dBm)	Result
		Polarization	Level (dBm)		
Low	3440.00	Vertical	-67.40	<-13.00	Pass
	5160.00	V	-59.72		
	6880.00	V	-58.30		
	3440.00	Horizontal	-56.63	<-13.00	Pass
	5160.00	H	-70.02		
	6880.00	H	-71.74		
Mid	3465.00	Vertical	-79.50	<-13.00	Pass
	5197.50	V	-65.49		
	6930.00	V	-63.72		
	3465.00	Horizontal	-64.28	<-13.00	Pass
	5197.50	H	-77.86		
	6930.00	H	-75.96		
High	3490.00	Vertical	-82.95	<-13.00	Pass
	5235.00	V	-67.71		
	6980.00	V	-65.74		
	3490.00	Horizontal	-66.20	<-13.00	Pass
	5235.00	H	-79.68		
	6980.00	H	-77.69		

Remark:

1. Remark"---" means that the emission level is too low to be measured
2. The emission levels of below 1 GHz are very lower than the limit and not show in test report.

LTE Band 5-1.4MHz					
Channel	Frequency (MHz)	Spurious Emission		Limit (dBm)	Result
		Polarization	Level (dBm)		
Low	1649.40	Vertical	-35.66	<-13.00	Pass
	2474.10	V	-43.25		
	3298.80	V	-43.77		
	1649.40	Horizontal	-38.28	<-13.00	Pass
	2474.10	H	-46.33		
	3298.80	H	-46.57		
Mid	1673.00	Vertical	-34.88	<-13.00	Pass
	2509.50	V	-42.52		
	3346.00	V	-42.92		
	1673.00	Horizontal	-37.48	<-13.00	Pass
	2509.50	H	-45.58		
	3346.00	H	-45.87		
High	1696.60	Vertical	-33.99	<-13.00	Pass
	2544.90	V	-41.80		
	3393.20	V	-42.24		
	1696.60	Horizontal	-34.39	<-13.00	Pass
	2544.90	H	-41.43		
	3393.20	H	-42.88		

LTE Band 5-3MHz					
Channel	Frequency (MHz)	Spurious Emission		Limit (dBm)	Result
		Polarization	Level (dBm)		
Low	1651.00	Vertical	-32.38	<-13.00	Pass
	2476.50	V	-40.28		
	3302.00	V	-40.95		
	1651.00	Horizontal	-33.33	<-13.00	Pass
	2476.50	H	-40.43		
	3302.00	H	-42.03		
Mid	1673.00	Vertical	-31.58	<-13.00	Pass
	2509.50	V	-39.53		
	3346.00	V	-40.25		
	1673.00	Horizontal	-31.91	<-13.00	Pass
	2509.50	H	-39.28		
	3346.00	H	-40.94		
High	1695.00	Vertical	-29.83	<-13.00	Pass
	2542.50	V	-37.94		
	3390.00	V	-38.74		
	1695.00	Horizontal	-30.61	<-13.00	Pass
	2542.50	H	-38.06		
	3390.00	H	-39.90		

LTE Band 5-5MHz					
Channel	Frequency (MHz)	Spurious Emission		Limit (dBm)	Result
		Polarization	Level (dBm)		
Low	1653.00	Vertical	-26.60	<-13.00	Pass
	2479.50	V	-35.93		
	3306.00	V	-36.09		
	1653.00	Horizontal	-31.39	<-13.00	Pass
	2479.50	H	-38.79		
	3306.00	H	-40.52		
Mid	1673.00	Vertical	-27.18	<-13.00	Pass
	2509.50	V	-36.48		
	3346.00	V	-36.61		
	1673.00	Horizontal	-31.54	<-13.00	Pass
	2509.50	H	-38.91		
	3346.00	H	-40.64		
High	1693.00	Vertical	-27.90	<-13.00	Pass
	2539.50	V	-37.13		
	3386.00	V	-37.23		
	1693.00	Horizontal	-30.20	<-13.00	Pass
	2539.50	H	-37.65		
	3386.00	H	-39.57		

LTE Band 5-10MHz					
Channel	Frequency (MHz)	Spurious Emission		Limit (dBm)	Result
		Polarization	Level (dBm)		
Low	1658.00	Vertical	-26.99	<-13.00	Pass
	2487.00	V	-36.35		
	3316.00	V	-36.57		
	1658.00	Horizontal	-31.24	<-13.00	Pass
	2487.00	H	-38.63		
	3316.00	H	-40.40		
Mid	1673.00	Vertical	-27.77	<-13.00	Pass
	2509.50	V	-37.09		
	3346.00	V	-37.26		
	1673.00	Horizontal	-31.43	<-13.00	Pass
	2509.50	H	-38.78		
	3346.00	H	-40.55		
High	1688.00	Vertical	-28.00	<-13.00	Pass
	2532.00	V	-37.30		
	3376.00	V	-37.46		
	1688.00	Horizontal	-31.61	<-13.00	Pass
	2532.00	H	-38.95		
	3376.00	H	-40.69		

Remark:

1. Remark"---" means that the emission level is too low to be measured
2. The emission levels of below 1 GHz are very lower than the limit and not show in test report.

LTE Band 7-5MHz					
Channel	Frequency (MHz)	Spurious Emission		Limit (dBm)	Result
		Polarization	Level (dBm)		
Low	5005.00	Vertical	-36.51	<-25.00	Pass
	7507.50	V	-40.90		
	10010.00	V	-41.29		
	5005.00	Horizontal	-39.25	<-25.00	Pass
	7507.50	H	-44.27		
	10010.00	H	-43.27		
Mid	5070.00	Vertical	-35.12	<-25.00	Pass
	7605.00	V	-38.85		
	10140.00	V	-39.58		
	5070.00	Horizontal	-35.48	<-25.00	Pass
	7605.00	H	-41.07		
	10140.00	H	-41.13		
High	5135.00	Vertical	-31.23	<-25.00	Pass
	7702.50	V	-35.31		
	10270.00	V	-36.21		
	5135.00	Horizontal	-32.89	<-25.00	Pass
	7702.50	H	-38.63		
	10270.00	H	-39.06		

LTE Band 7-10MHz					
Channel	Frequency (MHz)	Spurious Emission		Limit (dBm)	Result
		Polarization	Level (dBm)		
Low	5010.00	Vertical	-29.47	<-25.00	Pass
	7515.00	V	-33.81		
	10020.00	V	-34.94		
	5010.00	Horizontal	-34.35	<-25.00	Pass
	7515.00	H	-40.01		
	10020.00	H	-40.23		
Mid	5070.00	Vertical	-30.57	<-25.00	Pass
	7605.00	V	-34.84		
	10140.00	V	-35.91		
	5070.00	Horizontal	-36.12	<-25.00	Pass
	7605.00	H	-41.45		
	10140.00	H	-41.59		
High	5130.00	Vertical	-32.37	<-25.00	Pass
	7695.00	V	-36.48		
	10260.00	V	-37.47		
	5130.00	Horizontal	-37.29	<-25.00	Pass
	7695.00	H	-42.55		
	10260.00	H	-42.52		

LTE Band 7-15MHz					
Channel	Frequency (MHz)	Spurious Emission		Limit (dBm)	Result
		Polarization	Level (dBm)		
Low	5015.00	Vertical	-30.78	<-25.00	Pass
	7522.50	V	-35.13		
	10030.00	V	-36.32		
	5015.00	Horizontal	-39.74	<-25.00	Pass
	7522.50	H	-46.11		
	10030.00	H	-46.00		
Mid	5070.00	Vertical	-34.12	<-25.00	Pass
	7605.00	V	-38.08		
	10140.00	V	-38.48		
	5070.00	Horizontal	-38.34	<-25.00	Pass
	7605.00	H	-44.98		
	10140.00	H	-44.92		
High	5125.00	Vertical	-32.40	<-25.00	Pass
	7687.50	V	-36.52		
	10250.00	V	-36.99		
	5125.00	Horizontal	-37.20	<-25.00	Pass
	7687.50	H	-43.90		
	10250.00	H	-44.01		

LTE Band 7-20MHz					
Channel	Frequency (MHz)	Spurious Emission		Limit (dBm)	Result
		Polarization	Level (dBm)		
Low	5020.00	Vertical	-30.71	<-25.00	Pass
	7530.00	V	-34.41		
	10040.00	V	-35.19		
	5020.00	Horizontal	-35.57	<-25.00	Pass
	7530.00	H	-42.37		
	10040.00	H	-42.71		
Mid	5070.00	Vertical	-29.49	<-25.00	Pass
	7605.00	V	-33.26		
	10140.00	V	-34.11		
	5070.00	Horizontal	-33.45	<-25.00	Pass
	7605.00	H	-40.65		
	10140.00	H	-41.08		
High	5120.00	Vertical	-27.99	<-25.00	Pass
	7680.00	V	-31.89		
	10240.00	V	-32.81		
	5120.00	Horizontal	-35.72	<-25.00	Pass
	7680.00	H	-42.79		
	10240.00	H	-42.90		

Remark:

1. Remark"---" means that the emission level is too low to be measured
2. The emission levels of below 1 GHz are very lower than the limit and not show in test report.

6. TEST SETUP PHOTOS OF THE EUT

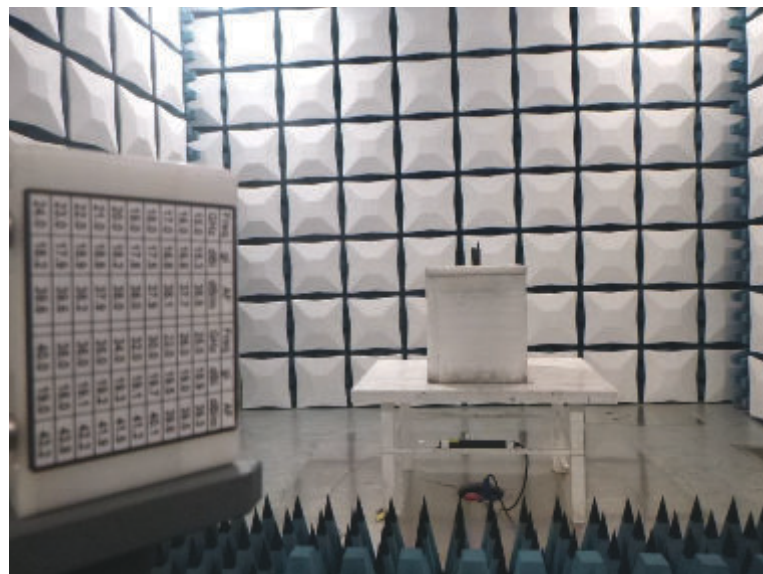
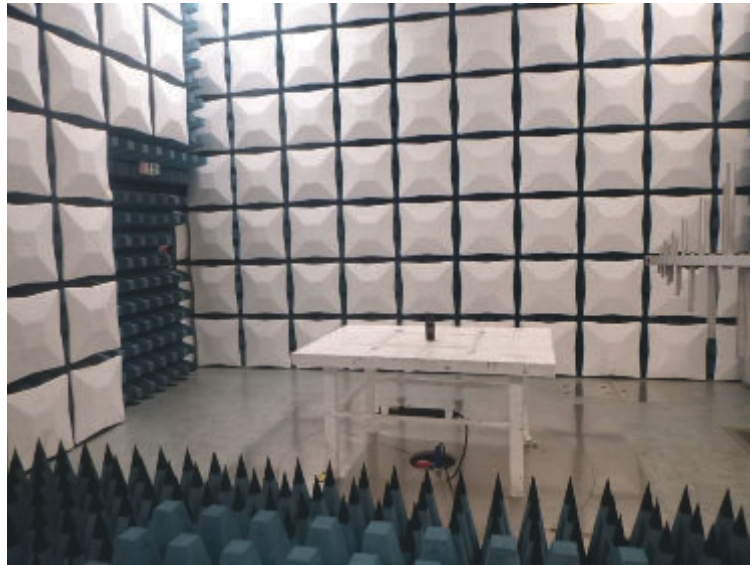

7. EXTERNAL AND INTERNAL PHOTOS OF THE EUT

Refere to the test report No.: CHTEW22060158

8. APPENDIX REPORT

APPENDIX REPORT

Project No.	SHT2206032304EW	Radio Specification	LTE
Test sample No.	YPHT20120285014	Model No.	e360
Start test date	2020/12/15	Finish date	2020/12/16
Temperature	24.5°C	Humidity	34%
Test Engineer	Jiongsheng.Feng	Auditor	Xiaodong Zhu

Appendix clause	Test item	Result
A	Conducted Output Power	PASS
B	Peak-to-Average Ratio	PASS
C	26 dB Bandwidth and Occupied Bandwidth	PASS
D	Band edge	PASS
E	Conducted Spurious Emission	PASS
F	Frequency Stability	PASS

8.1 Appendix A: Conducted Output Power

Test Result

Band	Bandwidth	Modulation	Channel	RB Configuration	Result(dBm)	Verdict
Band4	1.4MHz	QPSK	19957	1RB#0	23.74	PASS
Band4	1.4MHz	QPSK	19957	1RB#2	23.86	PASS
Band4	1.4MHz	QPSK	19957	1RB#5	23.96	PASS
Band4	1.4MHz	QPSK	19957	3RB#0	23.79	PASS
Band4	1.4MHz	QPSK	19957	3RB#1	23.98	PASS
Band4	1.4MHz	QPSK	19957	3RB#3	23.94	PASS
Band4	1.4MHz	QPSK	19957	6RB#0	22.81	PASS
Band4	1.4MHz	QPSK	20175	1RB#0	23.63	PASS
Band4	1.4MHz	QPSK	20175	1RB#2	23.80	PASS
Band4	1.4MHz	QPSK	20175	1RB#5	23.69	PASS
Band4	1.4MHz	QPSK	20175	3RB#0	23.74	PASS
Band4	1.4MHz	QPSK	20175	3RB#1	23.64	PASS
Band4	1.4MHz	QPSK	20175	3RB#3	23.84	PASS
Band4	1.4MHz	QPSK	20175	6RB#0	22.83	PASS
Band4	1.4MHz	QPSK	20393	1RB#0	23.79	PASS
Band4	1.4MHz	QPSK	20393	1RB#2	23.69	PASS
Band4	1.4MHz	QPSK	20393	1RB#5	23.93	PASS
Band4	1.4MHz	QPSK	20393	3RB#0	23.80	PASS
Band4	1.4MHz	QPSK	20393	3RB#1	23.83	PASS
Band4	1.4MHz	QPSK	20393	3RB#3	23.89	PASS
Band4	1.4MHz	QPSK	20393	6RB#0	22.83	PASS
Band4	1.4MHz	16QAM	19957	1RB#0	23.28	PASS
Band4	1.4MHz	16QAM	19957	1RB#2	23.45	PASS
Band4	1.4MHz	16QAM	19957	1RB#5	23.34	PASS
Band4	1.4MHz	16QAM	19957	3RB#0	22.74	PASS
Band4	1.4MHz	16QAM	19957	3RB#1	22.74	PASS
Band4	1.4MHz	16QAM	19957	3RB#3	22.76	PASS
Band4	1.4MHz	16QAM	19957	6RB#0	21.93	PASS
Band4	1.4MHz	16QAM	20175	1RB#0	22.51	PASS
Band4	1.4MHz	16QAM	20175	1RB#2	23.10	PASS
Band4	1.4MHz	16QAM	20175	1RB#5	22.97	PASS
Band4	1.4MHz	16QAM	20175	3RB#0	22.64	PASS
Band4	1.4MHz	16QAM	20175	3RB#1	22.72	PASS

Band4	1.4MHz	16QAM	20175	3RB#3	22.73	PASS
Band4	1.4MHz	16QAM	20175	6RB#0	21.82	PASS
Band4	1.4MHz	16QAM	20393	1RB#0	22.81	PASS
Band4	1.4MHz	16QAM	20393	1RB#2	22.87	PASS
Band4	1.4MHz	16QAM	20393	1RB#5	22.67	PASS
Band4	1.4MHz	16QAM	20393	3RB#0	22.80	PASS
Band4	1.4MHz	16QAM	20393	3RB#1	22.81	PASS
Band4	1.4MHz	16QAM	20393	3RB#3	22.57	PASS
Band4	1.4MHz	16QAM	20393	6RB#0	21.90	PASS
Band4	3MHz	QPSK	19965	1RB#0	23.81	PASS
Band4	3MHz	QPSK	19965	1RB#8	23.64	PASS
Band4	3MHz	QPSK	19965	1RB#14	23.94	PASS
Band4	3MHz	QPSK	19965	8RB#0	22.93	PASS
Band4	3MHz	QPSK	19965	8RB#4	23.10	PASS
Band4	3MHz	QPSK	19965	8RB#7	23.02	PASS
Band4	3MHz	QPSK	19965	15RB#0	22.97	PASS
Band4	3MHz	QPSK	20175	1RB#0	23.88	PASS
Band4	3MHz	QPSK	20175	1RB#8	23.63	PASS
Band4	3MHz	QPSK	20175	1RB#14	24.14	PASS
Band4	3MHz	QPSK	20175	8RB#0	22.92	PASS
Band4	3MHz	QPSK	20175	8RB#4	22.75	PASS
Band4	3MHz	QPSK	20175	8RB#7	22.89	PASS
Band4	3MHz	QPSK	20175	15RB#0	22.78	PASS
Band4	3MHz	QPSK	20385	1RB#0	23.71	PASS
Band4	3MHz	QPSK	20385	1RB#8	23.68	PASS
Band4	3MHz	QPSK	20385	1RB#14	23.75	PASS
Band4	3MHz	QPSK	20385	8RB#0	23.01	PASS
Band4	3MHz	QPSK	20385	8RB#4	22.97	PASS
Band4	3MHz	QPSK	20385	8RB#7	22.91	PASS
Band4	3MHz	QPSK	20385	15RB#0	23.08	PASS
Band4	3MHz	16QAM	19965	1RB#0	22.84	PASS
Band4	3MHz	16QAM	19965	1RB#8	22.98	PASS
Band4	3MHz	16QAM	19965	1RB#14	23.02	PASS
Band4	3MHz	16QAM	19965	8RB#0	22.02	PASS
Band4	3MHz	16QAM	19965	8RB#4	22.06	PASS
Band4	3MHz	16QAM	19965	8RB#7	22.03	PASS
Band4	3MHz	16QAM	19965	15RB#0	21.83	PASS
Band4	3MHz	16QAM	20175	1RB#0	23.10	PASS
Band4	3MHz	16QAM	20175	1RB#8	23.06	PASS

Band4	3MHz	16QAM	20175	1RB#14	23.15	PASS
Band4	3MHz	16QAM	20175	8RB#0	21.82	PASS
Band4	3MHz	16QAM	20175	8RB#4	21.82	PASS
Band4	3MHz	16QAM	20175	8RB#7	22.01	PASS
Band4	3MHz	16QAM	20175	15RB#0	21.75	PASS
Band4	3MHz	16QAM	20385	1RB#0	22.98	PASS
Band4	3MHz	16QAM	20385	1RB#8	22.91	PASS
Band4	3MHz	16QAM	20385	1RB#14	22.81	PASS
Band4	3MHz	16QAM	20385	8RB#0	22.03	PASS
Band4	3MHz	16QAM	20385	8RB#4	22.06	PASS
Band4	3MHz	16QAM	20385	8RB#7	22.01	PASS
Band4	3MHz	16QAM	20385	15RB#0	22.13	PASS
Band4	5MHz	QPSK	19975	1RB#0	23.82	PASS
Band4	5MHz	QPSK	19975	1RB#12	23.86	PASS
Band4	5MHz	QPSK	19975	1RB#24	23.71	PASS
Band4	5MHz	QPSK	19975	12RB#0	23.01	PASS
Band4	5MHz	QPSK	19975	12RB#6	23.02	PASS
Band4	5MHz	QPSK	19975	12RB#13	22.95	PASS
Band4	5MHz	QPSK	19975	25RB#0	23.02	PASS
Band4	5MHz	QPSK	20175	1RB#0	23.74	PASS
Band4	5MHz	QPSK	20175	1RB#12	24.07	PASS
Band4	5MHz	QPSK	20175	1RB#24	24.13	PASS
Band4	5MHz	QPSK	20175	12RB#0	22.98	PASS
Band4	5MHz	QPSK	20175	12RB#6	22.82	PASS
Band4	5MHz	QPSK	20175	12RB#13	22.87	PASS
Band4	5MHz	QPSK	20175	25RB#0	22.88	PASS
Band4	5MHz	QPSK	20375	1RB#0	23.66	PASS
Band4	5MHz	QPSK	20375	1RB#12	23.67	PASS
Band4	5MHz	QPSK	20375	1RB#24	23.79	PASS
Band4	5MHz	QPSK	20375	12RB#0	22.99	PASS
Band4	5MHz	QPSK	20375	12RB#6	22.84	PASS
Band4	5MHz	QPSK	20375	12RB#13	23.00	PASS
Band4	5MHz	QPSK	20375	25RB#0	22.96	PASS
Band4	5MHz	16QAM	19975	1RB#0	23.12	PASS
Band4	5MHz	16QAM	19975	1RB#12	23.00	PASS
Band4	5MHz	16QAM	19975	1RB#24	22.77	PASS
Band4	5MHz	16QAM	19975	12RB#0	21.90	PASS
Band4	5MHz	16QAM	19975	12RB#6	21.90	PASS
Band4	5MHz	16QAM	19975	12RB#13	21.99	PASS

Band4	5MHz	16QAM	19975	25RB#0	21.82	PASS
Band4	5MHz	16QAM	20175	1RB#0	22.79	PASS
Band4	5MHz	16QAM	20175	1RB#12	22.61	PASS
Band4	5MHz	16QAM	20175	1RB#24	22.89	PASS
Band4	5MHz	16QAM	20175	12RB#0	21.96	PASS
Band4	5MHz	16QAM	20175	12RB#6	21.77	PASS
Band4	5MHz	16QAM	20175	12RB#13	22.01	PASS
Band4	5MHz	16QAM	20175	25RB#0	22.04	PASS
Band4	5MHz	16QAM	20375	1RB#0	22.68	PASS
Band4	5MHz	16QAM	20375	1RB#12	22.26	PASS
Band4	5MHz	16QAM	20375	1RB#24	22.79	PASS
Band4	5MHz	16QAM	20375	12RB#0	21.78	PASS
Band4	5MHz	16QAM	20375	12RB#6	21.81	PASS
Band4	5MHz	16QAM	20375	12RB#13	22.16	PASS
Band4	5MHz	16QAM	20375	25RB#0	22.10	PASS
Band4	10MHz	QPSK	20000	1RB#0	24.04	PASS
Band4	10MHz	QPSK	20000	1RB#24	23.85	PASS
Band4	10MHz	QPSK	20000	1RB#49	23.62	PASS
Band4	10MHz	QPSK	20000	25RB#0	23.06	PASS
Band4	10MHz	QPSK	20000	25RB#12	23.05	PASS
Band4	10MHz	QPSK	20000	25RB#25	22.86	PASS
Band4	10MHz	QPSK	20000	50RB#0	22.94	PASS
Band4	10MHz	QPSK	20175	1RB#0	23.99	PASS
Band4	10MHz	QPSK	20175	1RB#24	23.97	PASS
Band4	10MHz	QPSK	20175	1RB#49	23.95	PASS
Band4	10MHz	QPSK	20175	25RB#0	22.94	PASS
Band4	10MHz	QPSK	20175	25RB#12	22.86	PASS
Band4	10MHz	QPSK	20175	25RB#25	22.87	PASS
Band4	10MHz	QPSK	20175	50RB#0	22.83	PASS
Band4	10MHz	QPSK	20350	1RB#0	23.80	PASS
Band4	10MHz	QPSK	20350	1RB#24	23.76	PASS
Band4	10MHz	QPSK	20350	1RB#49	23.76	PASS
Band4	10MHz	QPSK	20350	25RB#0	23.18	PASS
Band4	10MHz	QPSK	20350	25RB#12	23.15	PASS
Band4	10MHz	QPSK	20350	25RB#25	22.84	PASS
Band4	10MHz	QPSK	20350	50RB#0	22.99	PASS
Band4	10MHz	16QAM	20000	1RB#0	22.88	PASS
Band4	10MHz	16QAM	20000	1RB#24	22.07	PASS
Band4	10MHz	16QAM	20000	1RB#49	22.52	PASS

Band4	10MHz	16QAM	20000	25RB#0	22.00	PASS
Band4	10MHz	16QAM	20000	25RB#12	22.37	PASS
Band4	10MHz	16QAM	20000	25RB#25	21.98	PASS
Band4	10MHz	16QAM	20000	50RB#0	21.99	PASS
Band4	10MHz	16QAM	20175	1RB#0	22.99	PASS
Band4	10MHz	16QAM	20175	1RB#24	22.12	PASS
Band4	10MHz	16QAM	20175	1RB#49	22.32	PASS
Band4	10MHz	16QAM	20175	25RB#0	21.99	PASS
Band4	10MHz	16QAM	20175	25RB#12	22.00	PASS
Band4	10MHz	16QAM	20175	25RB#25	22.02	PASS
Band4	10MHz	16QAM	20175	50RB#0	21.93	PASS
Band4	10MHz	16QAM	20350	1RB#0	22.17	PASS
Band4	10MHz	16QAM	20350	1RB#24	22.98	PASS
Band4	10MHz	16QAM	20350	1RB#49	22.97	PASS
Band4	10MHz	16QAM	20350	25RB#0	22.15	PASS
Band4	10MHz	16QAM	20350	25RB#12	21.98	PASS
Band4	10MHz	16QAM	20350	25RB#25	21.79	PASS
Band4	10MHz	16QAM	20350	50RB#0	21.96	PASS
Band4	15MHz	QPSK	20025	1RB#0	24.02	PASS
Band4	15MHz	QPSK	20025	1RB#38	23.70	PASS
Band4	15MHz	QPSK	20025	1RB#74	23.87	PASS
Band4	15MHz	QPSK	20025	38RB#0	23.43	PASS
Band4	15MHz	QPSK	20025	38RB#18	22.46	PASS
Band4	15MHz	QPSK	20025	38RB#37	22.48	PASS
Band4	15MHz	QPSK	20025	75RB#0	22.93	PASS
Band4	15MHz	QPSK	20175	1RB#0	24.09	PASS
Band4	15MHz	QPSK	20175	1RB#38	23.77	PASS
Band4	15MHz	QPSK	20175	1RB#74	24.12	PASS
Band4	15MHz	QPSK	20175	38RB#0	23.29	PASS
Band4	15MHz	QPSK	20175	38RB#18	23.09	PASS
Band4	15MHz	QPSK	20175	38RB#37	23.41	PASS
Band4	15MHz	QPSK	20175	75RB#0	22.99	PASS
Band4	15MHz	QPSK	20325	1RB#0	23.66	PASS
Band4	15MHz	QPSK	20325	1RB#38	23.80	PASS
Band4	15MHz	QPSK	20325	1RB#74	24.15	PASS
Band4	15MHz	QPSK	20325	38RB#0	22.78	PASS
Band4	15MHz	QPSK	20325	38RB#18	22.76	PASS
Band4	15MHz	QPSK	20325	38RB#37	22.77	PASS
Band4	15MHz	QPSK	20325	75RB#0	23.10	PASS

Band4	15MHz	16QAM	20025	1RB#0	23.30	PASS
Band4	15MHz	16QAM	20025	1RB#38	23.13	PASS
Band4	15MHz	16QAM	20025	1RB#74	23.10	PASS
Band4	15MHz	16QAM	20025	38RB#0	22.35	PASS
Band4	15MHz	16QAM	20025	38RB#18	22.43	PASS
Band4	15MHz	16QAM	20025	38RB#37	22.38	PASS
Band4	15MHz	16QAM	20025	75RB#0	21.95	PASS
Band4	15MHz	16QAM	20175	1RB#0	23.13	PASS
Band4	15MHz	16QAM	20175	1RB#38	22.96	PASS
Band4	15MHz	16QAM	20175	1RB#74	23.17	PASS
Band4	15MHz	16QAM	20175	38RB#0	22.25	PASS
Band4	15MHz	16QAM	20175	38RB#18	22.17	PASS
Band4	15MHz	16QAM	20175	38RB#37	22.41	PASS
Band4	15MHz	16QAM	20175	75RB#0	22.11	PASS
Band4	15MHz	16QAM	20325	1RB#0	22.96	PASS
Band4	15MHz	16QAM	20325	1RB#38	23.29	PASS
Band4	15MHz	16QAM	20325	1RB#74	23.06	PASS
Band4	15MHz	16QAM	20325	38RB#0	22.77	PASS
Band4	15MHz	16QAM	20325	38RB#18	22.85	PASS
Band4	15MHz	16QAM	20325	38RB#37	22.76	PASS
Band4	15MHz	16QAM	20325	75RB#0	22.11	PASS
Band4	20MHz	QPSK	20050	1RB#0	24.43	PASS
Band4	20MHz	QPSK	20050	1RB#49	23.89	PASS
Band4	20MHz	QPSK	20050	1RB#99	24.01	PASS
Band4	20MHz	QPSK	20050	50RB#0	23.04	PASS
Band4	20MHz	QPSK	20050	50RB#25	22.87	PASS
Band4	20MHz	QPSK	20050	50RB#50	22.74	PASS
Band4	20MHz	QPSK	20050	100RB#0	22.83	PASS
Band4	20MHz	QPSK	20175	1RB#0	24.00	PASS
Band4	20MHz	QPSK	20175	1RB#49	23.87	PASS
Band4	20MHz	QPSK	20175	1RB#99	23.94	PASS
Band4	20MHz	QPSK	20175	50RB#0	22.94	PASS
Band4	20MHz	QPSK	20175	50RB#25	22.90	PASS
Band4	20MHz	QPSK	20175	50RB#50	22.99	PASS
Band4	20MHz	QPSK	20175	100RB#0	22.93	PASS
Band4	20MHz	QPSK	20300	1RB#0	24.22	PASS
Band4	20MHz	QPSK	20300	1RB#49	24.18	PASS
Band4	20MHz	QPSK	20300	1RB#99	24.25	PASS
Band4	20MHz	QPSK	20300	50RB#0	23.00	PASS

Band4	20MHz	QPSK	20300	50RB#25	23.07	PASS
Band4	20MHz	QPSK	20300	50RB#50	23.15	PASS
Band4	20MHz	QPSK	20300	100RB#0	23.02	PASS
Band4	20MHz	16QAM	20050	1RB#0	23.57	PASS
Band4	20MHz	16QAM	20050	1RB#49	23.09	PASS
Band4	20MHz	16QAM	20050	1RB#99	23.17	PASS
Band4	20MHz	16QAM	20050	50RB#0	21.89	PASS
Band4	20MHz	16QAM	20050	50RB#25	21.90	PASS
Band4	20MHz	16QAM	20050	50RB#50	21.74	PASS
Band4	20MHz	16QAM	20050	100RB#0	21.85	PASS
Band4	20MHz	16QAM	20175	1RB#0	22.91	PASS
Band4	20MHz	16QAM	20175	1RB#49	23.12	PASS
Band4	20MHz	16QAM	20175	1RB#99	23.24	PASS
Band4	20MHz	16QAM	20175	50RB#0	21.95	PASS
Band4	20MHz	16QAM	20175	50RB#25	21.94	PASS
Band4	20MHz	16QAM	20175	50RB#50	22.19	PASS
Band4	20MHz	16QAM	20175	100RB#0	22.00	PASS
Band4	20MHz	16QAM	20300	1RB#0	22.95	PASS
Band4	20MHz	16QAM	20300	1RB#49	23.19	PASS
Band4	20MHz	16QAM	20300	1RB#99	23.02	PASS
Band4	20MHz	16QAM	20300	50RB#0	22.20	PASS
Band4	20MHz	16QAM	20300	50RB#25	22.32	PASS
Band4	20MHz	16QAM	20300	50RB#50	22.17	PASS
Band4	20MHz	16QAM	20300	100RB#0	22.07	PASS
Band5	1.4MHz	QPSK	20407	1RB#0	24.39	PASS
Band5	1.4MHz	QPSK	20407	1RB#2	24.37	PASS
Band5	1.4MHz	QPSK	20407	1RB#5	24.38	PASS
Band5	1.4MHz	QPSK	20407	3RB#0	24.66	PASS
Band5	1.4MHz	QPSK	20407	3RB#1	24.43	PASS
Band5	1.4MHz	QPSK	20407	3RB#3	24.39	PASS
Band5	1.4MHz	QPSK	20407	6RB#0	23.47	PASS
Band5	1.4MHz	QPSK	20525	1RB#0	24.64	PASS
Band5	1.4MHz	QPSK	20525	1RB#2	24.71	PASS
Band5	1.4MHz	QPSK	20525	1RB#5	24.66	PASS
Band5	1.4MHz	QPSK	20525	3RB#0	24.54	PASS
Band5	1.4MHz	QPSK	20525	3RB#1	24.53	PASS
Band5	1.4MHz	QPSK	20525	3RB#3	24.66	PASS
Band5	1.4MHz	QPSK	20525	6RB#0	23.62	PASS
Band5	1.4MHz	QPSK	20643	1RB#0	24.28	PASS

Band5	1.4MHz	QPSK	20643	1RB#2	23.96	PASS
Band5	1.4MHz	QPSK	20643	1RB#5	23.92	PASS
Band5	1.4MHz	QPSK	20643	3RB#0	23.94	PASS
Band5	1.4MHz	QPSK	20643	3RB#1	23.94	PASS
Band5	1.4MHz	QPSK	20643	3RB#3	23.87	PASS
Band5	1.4MHz	QPSK	20643	6RB#0	23.97	PASS
Band5	1.4MHz	16QAM	20407	1RB#0	23.39	PASS
Band5	1.4MHz	16QAM	20407	1RB#2	23.62	PASS
Band5	1.4MHz	16QAM	20407	1RB#5	23.56	PASS
Band5	1.4MHz	16QAM	20407	3RB#0	23.45	PASS
Band5	1.4MHz	16QAM	20407	3RB#1	23.57	PASS
Band5	1.4MHz	16QAM	20407	3RB#3	23.60	PASS
Band5	1.4MHz	16QAM	20407	6RB#0	22.45	PASS
Band5	1.4MHz	16QAM	20525	1RB#0	23.56	PASS
Band5	1.4MHz	16QAM	20525	1RB#2	23.80	PASS
Band5	1.4MHz	16QAM	20525	1RB#5	23.68	PASS
Band5	1.4MHz	16QAM	20525	3RB#0	23.58	PASS
Band5	1.4MHz	16QAM	20525	3RB#1	23.56	PASS
Band5	1.4MHz	16QAM	20525	3RB#3	23.70	PASS
Band5	1.4MHz	16QAM	20525	6RB#0	22.54	PASS
Band5	1.4MHz	16QAM	20643	1RB#0	23.31	PASS
Band5	1.4MHz	16QAM	20643	1RB#2	23.22	PASS
Band5	1.4MHz	16QAM	20643	1RB#5	23.14	PASS
Band5	1.4MHz	16QAM	20643	3RB#0	22.97	PASS
Band5	1.4MHz	16QAM	20643	3RB#1	22.97	PASS
Band5	1.4MHz	16QAM	20643	3RB#3	22.90	PASS
Band5	1.4MHz	16QAM	20643	6RB#0	22.82	PASS
Band5	3MHz	QPSK	20415	1RB#0	24.55	PASS
Band5	3MHz	QPSK	20415	1RB#8	24.32	PASS
Band5	3MHz	QPSK	20415	1RB#14	24.35	PASS
Band5	3MHz	QPSK	20415	8RB#0	23.62	PASS
Band5	3MHz	QPSK	20415	8RB#4	23.45	PASS
Band5	3MHz	QPSK	20415	8RB#7	23.33	PASS
Band5	3MHz	QPSK	20415	15RB#0	23.64	PASS
Band5	3MHz	QPSK	20525	1RB#0	24.75	PASS
Band5	3MHz	QPSK	20525	1RB#8	24.68	PASS
Band5	3MHz	QPSK	20525	1RB#14	24.87	PASS
Band5	3MHz	QPSK	20525	8RB#0	23.56	PASS
Band5	3MHz	QPSK	20525	8RB#4	23.67	PASS

Band5	3MHz	QPSK	20525	8RB#7	23.71	PASS
Band5	3MHz	QPSK	20525	15RB#0	23.53	PASS
Band5	3MHz	QPSK	20635	1RB#0	24.58	PASS
Band5	3MHz	QPSK	20635	1RB#8	24.35	PASS
Band5	3MHz	QPSK	20635	1RB#14	24.26	PASS
Band5	3MHz	QPSK	20635	8RB#0	23.79	PASS
Band5	3MHz	QPSK	20635	8RB#4	23.74	PASS
Band5	3MHz	QPSK	20635	8RB#7	23.68	PASS
Band5	3MHz	QPSK	20635	15RB#0	23.71	PASS
Band5	3MHz	16QAM	20415	1RB#0	23.59	PASS
Band5	3MHz	16QAM	20415	1RB#8	23.53	PASS
Band5	3MHz	16QAM	20415	1RB#14	23.61	PASS
Band5	3MHz	16QAM	20415	8RB#0	22.46	PASS
Band5	3MHz	16QAM	20415	8RB#4	22.47	PASS
Band5	3MHz	16QAM	20415	8RB#7	22.68	PASS
Band5	3MHz	16QAM	20415	15RB#0	22.59	PASS
Band5	3MHz	16QAM	20525	1RB#0	23.77	PASS
Band5	3MHz	16QAM	20525	1RB#8	23.67	PASS
Band5	3MHz	16QAM	20525	1RB#14	23.69	PASS
Band5	3MHz	16QAM	20525	8RB#0	22.72	PASS
Band5	3MHz	16QAM	20525	8RB#4	22.72	PASS
Band5	3MHz	16QAM	20525	8RB#7	22.69	PASS
Band5	3MHz	16QAM	20525	15RB#0	22.54	PASS
Band5	3MHz	16QAM	20635	1RB#0	23.69	PASS
Band5	3MHz	16QAM	20635	1RB#8	23.56	PASS
Band5	3MHz	16QAM	20635	1RB#14	23.49	PASS
Band5	3MHz	16QAM	20635	8RB#0	22.91	PASS
Band5	3MHz	16QAM	20635	8RB#4	22.90	PASS
Band5	3MHz	16QAM	20635	8RB#7	22.83	PASS
Band5	3MHz	16QAM	20635	15RB#0	22.79	PASS
Band5	5MHz	QPSK	20425	1RB#0	24.40	PASS
Band5	5MHz	QPSK	20425	1RB#12	24.47	PASS
Band5	5MHz	QPSK	20425	1RB#24	24.38	PASS
Band5	5MHz	QPSK	20425	12RB#0	23.57	PASS
Band5	5MHz	QPSK	20425	12RB#6	23.43	PASS
Band5	5MHz	QPSK	20425	12RB#13	23.40	PASS
Band5	5MHz	QPSK	20425	25RB#0	23.48	PASS
Band5	5MHz	QPSK	20525	1RB#0	24.59	PASS
Band5	5MHz	QPSK	20525	1RB#12	24.75	PASS

Band5	5MHz	QPSK	20525	1RB#24	24.78	PASS
Band5	5MHz	QPSK	20525	12RB#0	23.54	PASS
Band5	5MHz	QPSK	20525	12RB#6	23.54	PASS
Band5	5MHz	QPSK	20525	12RB#13	23.68	PASS
Band5	5MHz	QPSK	20525	25RB#0	23.54	PASS
Band5	5MHz	QPSK	20625	1RB#0	24.31	PASS
Band5	5MHz	QPSK	20625	1RB#12	24.42	PASS
Band5	5MHz	QPSK	20625	1RB#24	24.34	PASS
Band5	5MHz	QPSK	20625	12RB#0	23.73	PASS
Band5	5MHz	QPSK	20625	12RB#6	23.65	PASS
Band5	5MHz	QPSK	20625	12RB#13	23.63	PASS
Band5	5MHz	QPSK	20625	25RB#0	23.73	PASS
Band5	5MHz	16QAM	20425	1RB#0	23.58	PASS
Band5	5MHz	16QAM	20425	1RB#12	23.67	PASS
Band5	5MHz	16QAM	20425	1RB#24	23.64	PASS
Band5	5MHz	16QAM	20425	12RB#0	22.53	PASS
Band5	5MHz	16QAM	20425	12RB#6	22.54	PASS
Band5	5MHz	16QAM	20425	12RB#13	22.44	PASS
Band5	5MHz	16QAM	20425	25RB#0	22.43	PASS
Band5	5MHz	16QAM	20525	1RB#0	23.57	PASS
Band5	5MHz	16QAM	20525	1RB#12	23.61	PASS
Band5	5MHz	16QAM	20525	1RB#24	23.54	PASS
Band5	5MHz	16QAM	20525	12RB#0	22.65	PASS
Band5	5MHz	16QAM	20525	12RB#6	22.73	PASS
Band5	5MHz	16QAM	20525	12RB#13	22.71	PASS
Band5	5MHz	16QAM	20525	25RB#0	22.64	PASS
Band5	5MHz	16QAM	20625	1RB#0	23.46	PASS
Band5	5MHz	16QAM	20625	1RB#12	23.47	PASS
Band5	5MHz	16QAM	20625	1RB#24	23.46	PASS
Band5	5MHz	16QAM	20625	12RB#0	22.71	PASS
Band5	5MHz	16QAM	20625	12RB#6	22.81	PASS
Band5	5MHz	16QAM	20625	12RB#13	22.69	PASS
Band5	5MHz	16QAM	20625	25RB#0	22.83	PASS
Band5	10MHz	QPSK	20450	1RB#0	23.51	PASS
Band5	10MHz	QPSK	20450	1RB#24	23.38	PASS
Band5	10MHz	QPSK	20450	1RB#49	23.68	PASS
Band5	10MHz	QPSK	20450	25RB#0	23.72	PASS
Band5	10MHz	QPSK	20450	25RB#12	23.58	PASS
Band5	10MHz	QPSK	20450	25RB#25	23.64	PASS

Band5	10MHz	QPSK	20450	50RB#0	23.62	PASS
Band5	10MHz	QPSK	20525	1RB#0	23.22	PASS
Band5	10MHz	QPSK	20525	1RB#24	23.14	PASS
Band5	10MHz	QPSK	20525	1RB#49	23.30	PASS
Band5	10MHz	QPSK	20525	25RB#0	23.62	PASS
Band5	10MHz	QPSK	20525	25RB#12	23.64	PASS
Band5	10MHz	QPSK	20525	25RB#25	23.77	PASS
Band5	10MHz	QPSK	20525	50RB#0	23.69	PASS
Band5	10MHz	QPSK	20600	1RB#0	23.58	PASS
Band5	10MHz	QPSK	20600	1RB#24	23.37	PASS
Band5	10MHz	QPSK	20600	1RB#49	23.08	PASS
Band5	10MHz	QPSK	20600	25RB#0	24.19	PASS
Band5	10MHz	QPSK	20600	25RB#12	23.71	PASS
Band5	10MHz	QPSK	20600	25RB#25	23.74	PASS
Band5	10MHz	QPSK	20600	50RB#0	23.79	PASS
Band5	10MHz	16QAM	20450	1RB#0	23.58	PASS
Band5	10MHz	16QAM	20450	1RB#24	23.58	PASS
Band5	10MHz	16QAM	20450	1RB#49	22.95	PASS
Band5	10MHz	16QAM	20450	25RB#0	22.67	PASS
Band5	10MHz	16QAM	20450	25RB#12	22.60	PASS
Band5	10MHz	16QAM	20450	25RB#25	22.71	PASS
Band5	10MHz	16QAM	20450	50RB#0	22.73	PASS
Band5	10MHz	16QAM	20525	1RB#0	23.09	PASS
Band5	10MHz	16QAM	20525	1RB#24	23.88	PASS
Band5	10MHz	16QAM	20525	1RB#49	23.35	PASS
Band5	10MHz	16QAM	20525	25RB#0	22.81	PASS
Band5	10MHz	16QAM	20525	25RB#12	22.60	PASS
Band5	10MHz	16QAM	20525	25RB#25	22.78	PASS
Band5	10MHz	16QAM	20525	50RB#0	22.70	PASS
Band5	10MHz	16QAM	20600	1RB#0	23.71	PASS
Band5	10MHz	16QAM	20600	1RB#24	23.62	PASS
Band5	10MHz	16QAM	20600	1RB#49	23.36	PASS
Band5	10MHz	16QAM	20600	25RB#0	22.86	PASS
Band5	10MHz	16QAM	20600	25RB#12	22.76	PASS
Band5	10MHz	16QAM	20600	25RB#25	22.81	PASS
Band5	10MHz	16QAM	20600	50RB#0	22.79	PASS
Band7	5MHz	QPSK	20775	1RB#0	22.77	PASS
Band7	5MHz	QPSK	20775	1RB#12	22.12	PASS
Band7	5MHz	QPSK	20775	1RB#24	22.03	PASS

Band7	5MHz	QPSK	20775	12RB#0	22.32	PASS
Band7	5MHz	QPSK	20775	12RB#6	22.33	PASS
Band7	5MHz	QPSK	20775	12RB#13	21.91	PASS
Band7	5MHz	QPSK	20775	25RB#0	22.09	PASS
Band7	5MHz	QPSK	21100	1RB#0	22.06	PASS
Band7	5MHz	QPSK	21100	1RB#12	22.14	PASS
Band7	5MHz	QPSK	21100	1RB#24	22.54	PASS
Band7	5MHz	QPSK	21100	12RB#0	22.27	PASS
Band7	5MHz	QPSK	21100	12RB#6	22.31	PASS
Band7	5MHz	QPSK	21100	12RB#13	22.41	PASS
Band7	5MHz	QPSK	21100	25RB#0	22.38	PASS
Band7	5MHz	QPSK	21425	1RB#0	22.54	PASS
Band7	5MHz	QPSK	21425	1RB#12	22.08	PASS
Band7	5MHz	QPSK	21425	1RB#24	22.34	PASS
Band7	5MHz	QPSK	21425	12RB#0	22.09	PASS
Band7	5MHz	QPSK	21425	12RB#6	22.71	PASS
Band7	5MHz	QPSK	21425	12RB#13	22.64	PASS
Band7	5MHz	QPSK	21425	25RB#0	22.41	PASS
Band7	5MHz	16QAM	20775	1RB#0	21.92	PASS
Band7	5MHz	16QAM	20775	1RB#12	21.23	PASS
Band7	5MHz	16QAM	20775	1RB#24	21.14	PASS
Band7	5MHz	16QAM	20775	12RB#0	21.48	PASS
Band7	5MHz	16QAM	20775	12RB#6	21.48	PASS
Band7	5MHz	16QAM	20775	12RB#13	21.03	PASS
Band7	5MHz	16QAM	20775	25RB#0	21.24	PASS
Band7	5MHz	16QAM	21100	1RB#0	21.91	PASS
Band7	5MHz	16QAM	21100	1RB#12	21.18	PASS
Band7	5MHz	16QAM	21100	1RB#24	21.45	PASS
Band7	5MHz	16QAM	21100	12RB#0	21.41	PASS
Band7	5MHz	16QAM	21100	12RB#6	21.44	PASS
Band7	5MHz	16QAM	21100	12RB#13	21.52	PASS
Band7	5MHz	16QAM	21100	25RB#0	21.13	PASS
Band7	5MHz	16QAM	21425	1RB#0	21.35	PASS
Band7	5MHz	16QAM	21425	1RB#12	21.27	PASS
Band7	5MHz	16QAM	21425	1RB#24	21.20	PASS
Band7	5MHz	16QAM	21425	12RB#0	21.58	PASS
Band7	5MHz	16QAM	21425	12RB#6	21.70	PASS
Band7	5MHz	16QAM	21425	12RB#13	21.64	PASS
Band7	5MHz	16QAM	21425	25RB#0	21.61	PASS

Band7	10MHz	QPSK	20800	1RB#0	22.68	PASS
Band7	10MHz	QPSK	20800	1RB#24	22.24	PASS
Band7	10MHz	QPSK	20800	1RB#49	21.68	PASS
Band7	10MHz	QPSK	20800	25RB#0	22.32	PASS
Band7	10MHz	QPSK	20800	25RB#12	22.31	PASS
Band7	10MHz	QPSK	20800	25RB#25	22.46	PASS
Band7	10MHz	QPSK	20800	50RB#0	22.02	PASS
Band7	10MHz	QPSK	21100	1RB#0	22.12	PASS
Band7	10MHz	QPSK	21100	1RB#24	22.48	PASS
Band7	10MHz	QPSK	21100	1RB#49	22.15	PASS
Band7	10MHz	QPSK	21100	25RB#0	22.51	PASS
Band7	10MHz	QPSK	21100	25RB#12	22.64	PASS
Band7	10MHz	QPSK	21100	25RB#25	22.66	PASS
Band7	10MHz	QPSK	21100	50RB#0	22.10	PASS
Band7	10MHz	QPSK	21400	1RB#0	22.87	PASS
Band7	10MHz	QPSK	21400	1RB#24	22.26	PASS
Band7	10MHz	QPSK	21400	1RB#49	22.46	PASS
Band7	10MHz	QPSK	21400	25RB#0	22.11	PASS
Band7	10MHz	QPSK	21400	25RB#12	22.88	PASS
Band7	10MHz	QPSK	21400	25RB#25	22.71	PASS
Band7	10MHz	QPSK	21400	50RB#0	22.75	PASS
Band7	10MHz	16QAM	20800	1RB#0	22.01	PASS
Band7	10MHz	16QAM	20800	1RB#24	22.06	PASS
Band7	10MHz	16QAM	20800	1RB#49	22.48	PASS
Band7	10MHz	16QAM	20800	25RB#0	21.48	PASS
Band7	10MHz	16QAM	20800	25RB#12	21.45	PASS
Band7	10MHz	16QAM	20800	25RB#25	21.65	PASS
Band7	10MHz	16QAM	20800	50RB#0	21.17	PASS
Band7	10MHz	16QAM	21100	1RB#0	22.72	PASS
Band7	10MHz	16QAM	21100	1RB#24	22.35	PASS
Band7	10MHz	16QAM	21100	1RB#49	22.17	PASS
Band7	10MHz	16QAM	21100	25RB#0	21.49	PASS
Band7	10MHz	16QAM	21100	25RB#12	21.74	PASS
Band7	10MHz	16QAM	21100	25RB#25	21.82	PASS
Band7	10MHz	16QAM	21100	50RB#0	21.19	PASS
Band7	10MHz	16QAM	21400	1RB#0	22.63	PASS
Band7	10MHz	16QAM	21400	1RB#24	22.56	PASS
Band7	10MHz	16QAM	21400	1RB#49	22.71	PASS
Band7	10MHz	16QAM	21400	25RB#0	21.44	PASS

Band7	10MHz	16QAM	21400	25RB#12	21.85	PASS
Band7	10MHz	16QAM	21400	25RB#25	21.74	PASS
Band7	10MHz	16QAM	21400	50RB#0	21.49	PASS
Band7	15MHz	QPSK	20825	1RB#0	22.57	PASS
Band7	15MHz	QPSK	20825	1RB#38	21.75	PASS
Band7	15MHz	QPSK	20825	1RB#74	22.70	PASS
Band7	15MHz	QPSK	20825	38RB#0	22.05	PASS
Band7	15MHz	QPSK	20825	38RB#18	22.14	PASS
Band7	15MHz	QPSK	20825	38RB#37	22.09	PASS
Band7	15MHz	QPSK	20825	75RB#0	22.04	PASS
Band7	15MHz	QPSK	21100	1RB#0	22.35	PASS
Band7	15MHz	QPSK	21100	1RB#38	22.14	PASS
Band7	15MHz	QPSK	21100	1RB#74	22.08	PASS
Band7	15MHz	QPSK	21100	38RB#0	22.24	PASS
Band7	15MHz	QPSK	21100	38RB#18	22.06	PASS
Band7	15MHz	QPSK	21100	38RB#37	22.41	PASS
Band7	15MHz	QPSK	21100	75RB#0	22.52	PASS
Band7	15MHz	QPSK	21375	1RB#0	22.30	PASS
Band7	15MHz	QPSK	21375	1RB#38	22.88	PASS
Band7	15MHz	QPSK	21375	1RB#74	22.65	PASS
Band7	15MHz	QPSK	21375	38RB#0	22.40	PASS
Band7	15MHz	QPSK	21375	38RB#18	22.13	PASS
Band7	15MHz	QPSK	21375	38RB#37	22.91	PASS
Band7	15MHz	QPSK	21375	75RB#0	22.36	PASS
Band7	15MHz	16QAM	20825	1RB#0	22.02	PASS
Band7	15MHz	16QAM	20825	1RB#38	22.09	PASS
Band7	15MHz	16QAM	20825	1RB#74	22.10	PASS
Band7	15MHz	16QAM	20825	38RB#0	22.02	PASS
Band7	15MHz	16QAM	20825	38RB#18	22.13	PASS
Band7	15MHz	16QAM	20825	38RB#37	22.12	PASS
Band7	15MHz	16QAM	20825	75RB#0	21.12	PASS
Band7	15MHz	16QAM	21100	1RB#0	22.41	PASS
Band7	15MHz	16QAM	21100	1RB#38	22.96	PASS
Band7	15MHz	16QAM	21100	1RB#74	22.83	PASS
Band7	15MHz	16QAM	21100	38RB#0	22.38	PASS
Band7	15MHz	16QAM	21100	38RB#18	22.99	PASS
Band7	15MHz	16QAM	21100	38RB#37	22.85	PASS
Band7	15MHz	16QAM	21100	75RB#0	21.36	PASS
Band7	15MHz	16QAM	21375	1RB#0	22.41	PASS

Band7	15MHz	16QAM	21375	1RB#38	22.25	PASS
Band7	15MHz	16QAM	21375	1RB#74	22.34	PASS
Band7	15MHz	16QAM	21375	38RB#0	22.28	PASS
Band7	15MHz	16QAM	21375	38RB#18	22.24	PASS
Band7	15MHz	16QAM	21375	38RB#37	22.49	PASS
Band7	15MHz	16QAM	21375	75RB#0	21.58	PASS
Band7	20MHz	QPSK	20850	1RB#0	22.27	PASS
Band7	20MHz	QPSK	20850	1RB#49	22.05	PASS
Band7	20MHz	QPSK	20850	1RB#99	22.36	PASS
Band7	20MHz	QPSK	20850	50RB#0	22.14	PASS
Band7	20MHz	QPSK	20850	50RB#25	22.46	PASS
Band7	20MHz	QPSK	20850	50RB#50	22.53	PASS
Band7	20MHz	QPSK	20850	100RB#0	22.22	PASS
Band7	20MHz	QPSK	21100	1RB#0	22.06	PASS
Band7	20MHz	QPSK	21100	1RB#49	22.31	PASS
Band7	20MHz	QPSK	21100	1RB#99	22.41	PASS
Band7	20MHz	QPSK	21100	50RB#0	22.63	PASS
Band7	20MHz	QPSK	21100	50RB#25	22.71	PASS
Band7	20MHz	QPSK	21100	50RB#50	22.36	PASS
Band7	20MHz	QPSK	21100	100RB#0	22.74	PASS
Band7	20MHz	QPSK	21350	1RB#0	22.97	PASS
Band7	20MHz	QPSK	21350	1RB#49	22.51	PASS
Band7	20MHz	QPSK	21350	1RB#99	22.34	PASS
Band7	20MHz	QPSK	21350	50RB#0	22.62	PASS
Band7	20MHz	QPSK	21350	50RB#25	22.47	PASS
Band7	20MHz	QPSK	21350	50RB#50	22.52	PASS
Band7	20MHz	QPSK	21350	100RB#0	22.24	PASS
Band7	20MHz	16QAM	20850	1RB#0	21.58	PASS
Band7	20MHz	16QAM	20850	1RB#49	21.23	PASS
Band7	20MHz	16QAM	20850	1RB#99	21.00	PASS
Band7	20MHz	16QAM	20850	50RB#0	21.26	PASS
Band7	20MHz	16QAM	20850	50RB#25	21.87	PASS
Band7	20MHz	16QAM	20850	50RB#50	21.72	PASS
Band7	20MHz	16QAM	20850	100RB#0	21.29	PASS
Band7	20MHz	16QAM	21100	1RB#0	21.18	PASS
Band7	20MHz	16QAM	21100	1RB#49	21.06	PASS
Band7	20MHz	16QAM	21100	1RB#99	21.29	PASS
Band7	20MHz	16QAM	21100	50RB#0	21.43	PASS
Band7	20MHz	16QAM	21100	50RB#25	21.58	PASS

Band7	20MHz	16QAM	21100	50RB#50	21.09	PASS
Band7	20MHz	16QAM	21100	100RB#0	21.84	PASS
Band7	20MHz	16QAM	21350	1RB#0	21.75	PASS
Band7	20MHz	16QAM	21350	1RB#49	21.77	PASS
Band7	20MHz	16QAM	21350	1RB#99	21.41	PASS
Band7	20MHz	16QAM	21350	50RB#0	21.44	PASS
Band7	20MHz	16QAM	21350	50RB#25	21.52	PASS
Band7	20MHz	16QAM	21350	50RB#50	21.65	PASS
Band7	20MHz	16QAM	21350	100RB#0	21.65	PASS

8.2 Appendix B: Peak-to-Average Ratio(CCDF)

Test Result

Band	Bandwidth	Modulation	Channel	RB Configuration	Result(dB)	Limit(dB)	Verdict
Band4	1.4MHz	QPSK	19957	1RB#0	3.42	13	PASS
Band4	1.4MHz	QPSK	19957	6RB#0	4.13	13	PASS
Band4	1.4MHz	QPSK	20175	1RB#0	3.88	13	PASS
Band4	1.4MHz	QPSK	20175	6RB#0	4.38	13	PASS
Band4	1.4MHz	QPSK	20393	1RB#0	4.12	13	PASS
Band4	1.4MHz	QPSK	20393	6RB#0	4.75	13	PASS
Band4	1.4MHz	16QAM	19957	1RB#0	4.36	13	PASS
Band4	1.4MHz	16QAM	19957	6RB#0	5.04	13	PASS
Band4	1.4MHz	16QAM	20175	1RB#0	4.88	13	PASS
Band4	1.4MHz	16QAM	20175	6RB#0	5.28	13	PASS
Band4	1.4MHz	16QAM	20393	1RB#0	5.09	13	PASS
Band4	1.4MHz	16QAM	20393	6RB#0	5.65	13	PASS
Band4	3MHz	QPSK	19965	1RB#0	3.51	13	PASS
Band4	3MHz	QPSK	19965	15RB#0	4.24	13	PASS
Band4	3MHz	QPSK	20175	1RB#0	4.03	13	PASS
Band4	3MHz	QPSK	20175	15RB#0	4.30	13	PASS
Band4	3MHz	QPSK	20385	1RB#0	4.05	13	PASS
Band4	3MHz	QPSK	20385	15RB#0	4.66	13	PASS
Band4	3MHz	16QAM	19965	1RB#0	4.36	13	PASS
Band4	3MHz	16QAM	19965	15RB#0	5.14	13	PASS
Band4	3MHz	16QAM	20175	1RB#0	4.71	13	PASS
Band4	3MHz	16QAM	20175	15RB#0	5.24	13	PASS
Band4	3MHz	16QAM	20385	1RB#0	4.87	13	PASS
Band4	3MHz	16QAM	20385	15RB#0	5.53	13	PASS
Band4	5MHz	QPSK	19975	1RB#0	3.46	13	PASS
Band4	5MHz	QPSK	19975	25RB#0	4.24	13	PASS
Band4	5MHz	QPSK	20175	1RB#0	3.96	13	PASS
Band4	5MHz	QPSK	20175	25RB#0	4.35	13	PASS
Band4	5MHz	QPSK	20375	1RB#0	3.77	13	PASS
Band4	5MHz	QPSK	20375	25RB#0	4.58	13	PASS
Band4	5MHz	16QAM	19975	1RB#0	4.22	13	PASS
Band4	5MHz	16QAM	19975	25RB#0	5.17	13	PASS
Band4	5MHz	16QAM	20175	1RB#0	4.96	13	PASS
Band4	5MHz	16QAM	20175	25RB#0	5.30	13	PASS
Band4	5MHz	16QAM	20375	1RB#0	4.72	13	PASS
Band4	5MHz	16QAM	20375	25RB#0	5.41	13	PASS
Band4	10MHz	QPSK	20000	1RB#0	4.53	13	PASS
Band4	10MHz	QPSK	20000	50RB#0	4.53	13	PASS

Band4	10MHz	QPSK	20175	1RB#0	4.02	13	PASS
Band4	10MHz	QPSK	20175	50RB#0	4.32	13	PASS
Band4	10MHz	QPSK	20350	1RB#0	2.76	13	PASS
Band4	10MHz	QPSK	20350	50RB#0	4.10	13	PASS
Band4	10MHz	16QAM	20000	1RB#0	4.35	13	PASS
Band4	10MHz	16QAM	20000	50RB#0	5.41	13	PASS
Band4	10MHz	16QAM	20175	1RB#0	4.97	13	PASS
Band4	10MHz	16QAM	20175	50RB#0	5.23	13	PASS
Band4	10MHz	16QAM	20350	1RB#0	3.52	13	PASS
Band4	10MHz	16QAM	20350	50RB#0	5.01	13	PASS
Band4	15MHz	QPSK	20025	1RB#0	4.36	13	PASS
Band4	15MHz	QPSK	20025	75RB#0	4.91	13	PASS
Band4	15MHz	QPSK	20175	1RB#0	4.13	13	PASS
Band4	15MHz	QPSK	20175	75RB#0	4.59	13	PASS
Band4	15MHz	QPSK	20325	1RB#0	2.29	13	PASS
Band4	15MHz	QPSK	20325	75RB#0	4.12	13	PASS
Band4	15MHz	16QAM	20025	1RB#0	3.93	13	PASS
Band4	15MHz	16QAM	20025	75RB#0	5.73	13	PASS
Band4	15MHz	16QAM	20175	1RB#0	5.19	13	PASS
Band4	15MHz	16QAM	20175	75RB#0	5.39	13	PASS
Band4	15MHz	16QAM	20325	1RB#0	2.98	13	PASS
Band4	15MHz	16QAM	20325	75RB#0	4.91	13	PASS
Band4	20MHz	QPSK	20050	1RB#0	2.93	13	PASS
Band4	20MHz	QPSK	20050	100RB#0	4.90	13	PASS
Band4	20MHz	QPSK	20175	1RB#0	4.19	13	PASS
Band4	20MHz	QPSK	20175	100RB#0	4.60	13	PASS
Band4	20MHz	QPSK	20300	1RB#0	2.48	13	PASS
Band4	20MHz	QPSK	20300	100RB#0	4.06	13	PASS
Band4	20MHz	16QAM	20050	1RB#0	3.87	13	PASS
Band4	20MHz	16QAM	20050	100RB#0	5.73	13	PASS
Band4	20MHz	16QAM	20175	1RB#0	5.21	13	PASS
Band4	20MHz	16QAM	20175	100RB#0	5.40	13	PASS
Band4	20MHz	16QAM	20300	1RB#0	3.24	13	PASS
Band4	20MHz	16QAM	20300	100RB#0	4.88	13	PASS
Band5	1.4MHz	QPSK	20407	1RB#0	3.41	13	PASS
Band5	1.4MHz	QPSK	20407	6RB#0	4.68	13	PASS
Band5	1.4MHz	QPSK	20525	1RB#0	3.67	13	PASS
Band5	1.4MHz	QPSK	20525	6RB#0	4.86	13	PASS
Band5	1.4MHz	QPSK	20643	1RB#0	3.60	13	PASS
Band5	1.4MHz	QPSK	20643	6RB#0	4.72	13	PASS
Band5	1.4MHz	16QAM	20407	1RB#0	4.28	13	PASS
Band5	1.4MHz	16QAM	20407	6RB#0	5.58	13	PASS
Band5	1.4MHz	16QAM	20525	1RB#0	4.66	13	PASS
Band5	1.4MHz	16QAM	20525	6RB#0	5.70	13	PASS
Band5	1.4MHz	16QAM	20643	1RB#0	4.62	13	PASS

Band5	1.4MHz	16QAM	20643	6RB#0	5.61	13	PASS
Band5	3MHz	QPSK	20415	1RB#0	3.45	13	PASS
Band5	3MHz	QPSK	20415	15RB#0	4.88	13	PASS
Band5	3MHz	QPSK	20525	1RB#0	3.65	13	PASS
Band5	3MHz	QPSK	20525	15RB#0	5.03	13	PASS
Band5	3MHz	QPSK	20635	1RB#0	3.66	13	PASS
Band5	3MHz	QPSK	20635	15RB#0	4.91	13	PASS
Band5	3MHz	16QAM	20415	1RB#0	4.33	13	PASS
Band5	3MHz	16QAM	20415	15RB#0	5.69	13	PASS
Band5	3MHz	16QAM	20525	1RB#0	4.57	13	PASS
Band5	3MHz	16QAM	20525	15RB#0	5.86	13	PASS
Band5	3MHz	16QAM	20635	1RB#0	4.43	13	PASS
Band5	3MHz	16QAM	20635	15RB#0	5.73	13	PASS
Band5	5MHz	QPSK	20425	1RB#0	3.62	13	PASS
Band5	5MHz	QPSK	20425	25RB#0	5.12	13	PASS
Band5	5MHz	QPSK	20525	1RB#0	3.62	13	PASS
Band5	5MHz	QPSK	20525	25RB#0	5.05	13	PASS
Band5	5MHz	QPSK	20625	1RB#0	3.63	13	PASS
Band5	5MHz	QPSK	20625	25RB#0	5.04	13	PASS
Band5	5MHz	16QAM	20425	1RB#0	4.47	13	PASS
Band5	5MHz	16QAM	20425	25RB#0	5.90	13	PASS
Band5	5MHz	16QAM	20525	1RB#0	4.30	13	PASS
Band5	5MHz	16QAM	20525	25RB#0	5.86	13	PASS
Band5	5MHz	16QAM	20625	1RB#0	4.56	13	PASS
Band5	5MHz	16QAM	20625	25RB#0	5.86	13	PASS
Band5	10MHz	QPSK	20450	1RB#0	3.48	13	PASS
Band5	10MHz	QPSK	20450	50RB#0	5.24	13	PASS
Band5	10MHz	QPSK	20525	1RB#0	3.62	13	PASS
Band5	10MHz	QPSK	20525	50RB#0	5.07	13	PASS
Band5	10MHz	QPSK	20600	1RB#0	3.56	13	PASS
Band5	10MHz	QPSK	20600	50RB#0	5.05	13	PASS
Band5	10MHz	16QAM	20450	1RB#0	4.28	13	PASS
Band5	10MHz	16QAM	20450	50RB#0	6.01	13	PASS
Band5	10MHz	16QAM	20525	1RB#0	4.50	13	PASS
Band5	10MHz	16QAM	20525	50RB#0	5.89	13	PASS
Band5	10MHz	16QAM	20600	1RB#0	4.40	13	PASS
Band5	10MHz	16QAM	20600	50RB#0	5.87	13	PASS
Band7	5MHz	QPSK	20775	1RB#0	4.81	13	PASS
Band7	5MHz	QPSK	20775	25RB#0	5.47	13	PASS
Band7	5MHz	QPSK	21100	1RB#0	4.37	13	PASS
Band7	5MHz	QPSK	21100	25RB#0	5.18	13	PASS
Band7	5MHz	QPSK	21425	1RB#0	3.47	13	PASS
Band7	5MHz	QPSK	21425	25RB#0	4.08	13	PASS
Band7	5MHz	16QAM	20775	1RB#0	5.71	13	PASS
Band7	5MHz	16QAM	20775	25RB#0	6.29	13	PASS

Band7	5MHz	16QAM	21100	1RB#0	5.34	13	PASS
Band7	5MHz	16QAM	21100	25RB#0	6.05	13	PASS
Band7	5MHz	16QAM	21425	1RB#0	4.25	13	PASS
Band7	5MHz	16QAM	21425	25RB#0	4.98	13	PASS
Band7	10MHz	QPSK	20800	1RB#0	4.86	13	PASS
Band7	10MHz	QPSK	20800	50RB#0	5.44	13	PASS
Band7	10MHz	QPSK	21100	1RB#0	4.23	13	PASS
Band7	10MHz	QPSK	21100	50RB#0	5.24	13	PASS
Band7	10MHz	QPSK	21400	1RB#0	4.12	13	PASS
Band7	10MHz	QPSK	21400	50RB#0	4.32	13	PASS
Band7	10MHz	16QAM	20800	1RB#0	5.83	13	PASS
Band7	10MHz	16QAM	20800	50RB#0	6.32	13	PASS
Band7	10MHz	16QAM	21100	1RB#0	5.24	13	PASS
Band7	10MHz	16QAM	21100	50RB#0	6.14	13	PASS
Band7	10MHz	16QAM	21400	1RB#0	5.04	13	PASS
Band7	10MHz	16QAM	21400	50RB#0	5.21	13	PASS
Band7	15MHz	QPSK	20825	1RB#0	4.86	13	PASS
Band7	15MHz	QPSK	20825	75RB#0	5.70	13	PASS
Band7	15MHz	QPSK	21100	1RB#0	3.39	13	PASS
Band7	15MHz	QPSK	21100	75RB#0	5.25	13	PASS
Band7	15MHz	QPSK	21375	1RB#0	4.43	13	PASS
Band7	15MHz	QPSK	21375	75RB#0	4.55	13	PASS
Band7	15MHz	16QAM	20825	1RB#0	5.73	13	PASS
Band7	15MHz	16QAM	20825	75RB#0	6.44	13	PASS
Band7	15MHz	16QAM	21100	1RB#0	4.37	13	PASS
Band7	15MHz	16QAM	21100	75RB#0	6.05	13	PASS
Band7	15MHz	16QAM	21375	1RB#0	5.27	13	PASS
Band7	15MHz	16QAM	21375	75RB#0	5.34	13	PASS
Band7	20MHz	QPSK	20850	1RB#0	4.86	13	PASS
Band7	20MHz	QPSK	20850	100RB#0	5.48	13	PASS
Band7	20MHz	QPSK	21100	1RB#0	3.39	13	PASS
Band7	20MHz	QPSK	21100	100RB#0	5.10	13	PASS
Band7	20MHz	QPSK	21350	1RB#0	4.86	13	PASS
Band7	20MHz	QPSK	21350	100RB#0	4.81	13	PASS
Band7	20MHz	16QAM	20850	1RB#0	5.92	13	PASS
Band7	20MHz	16QAM	20850	100RB#0	6.28	13	PASS
Band7	20MHz	16QAM	21100	1RB#0	4.32	13	PASS
Band7	20MHz	16QAM	21100	100RB#0	5.97	13	PASS
Band7	20MHz	16QAM	21350	1RB#0	5.65	13	PASS
Band7	20MHz	16QAM	21350	100RB#0	5.65	13	PASS

Test Graphs

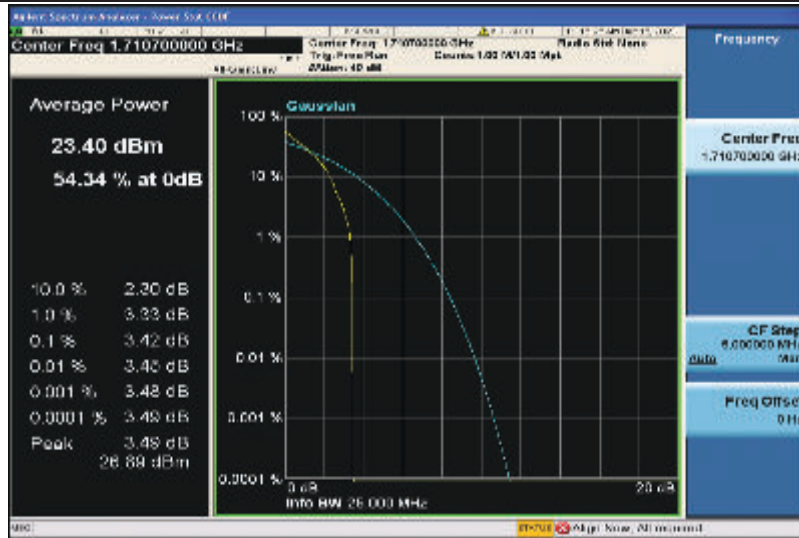

Band4-1.4MHz-QPSK-19957-1RB#0

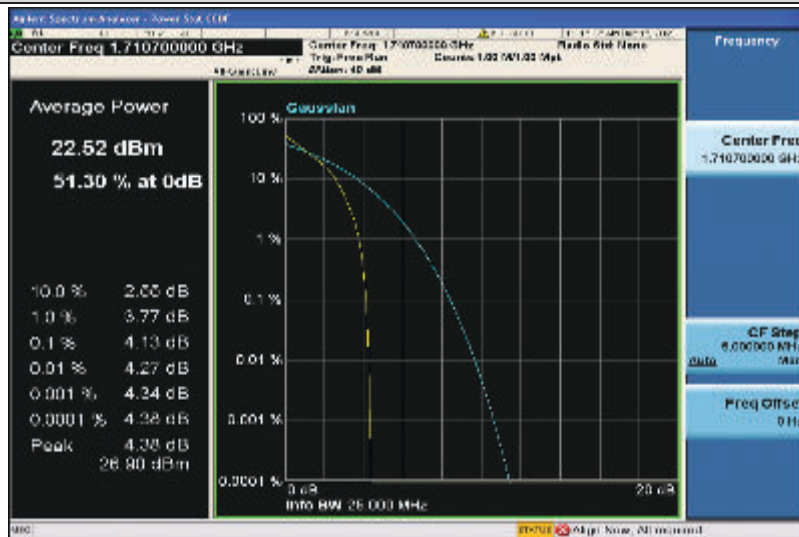

Band4-1.4MHz-QPSK-19957-6RB#0

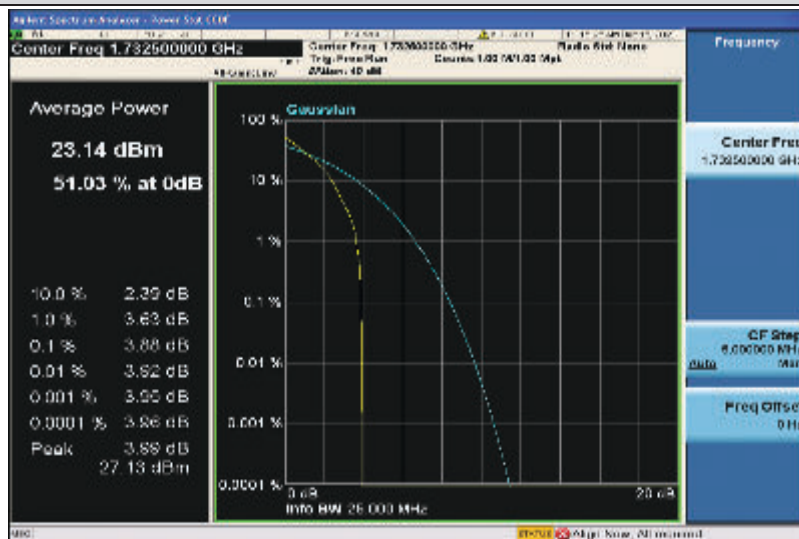

Band4-1.4MHz-QPSK-20175-1RB#0

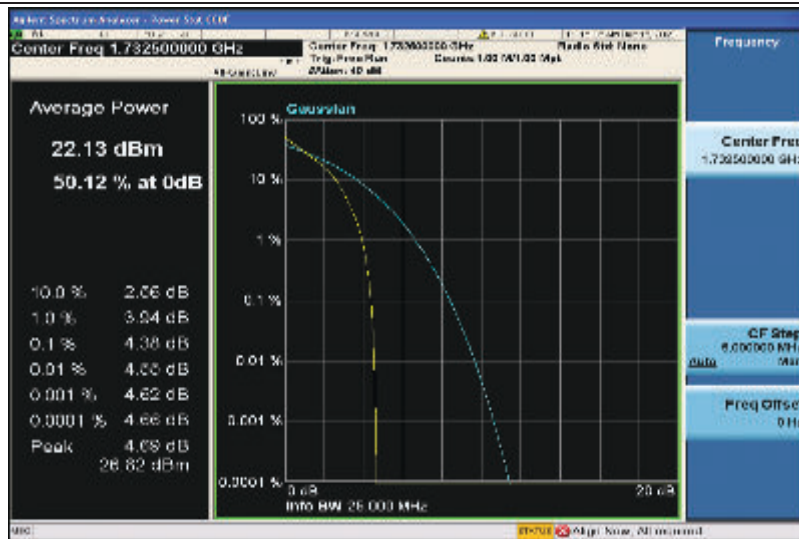

Band4-1.4MHz-QPSK-20175-6RB#0

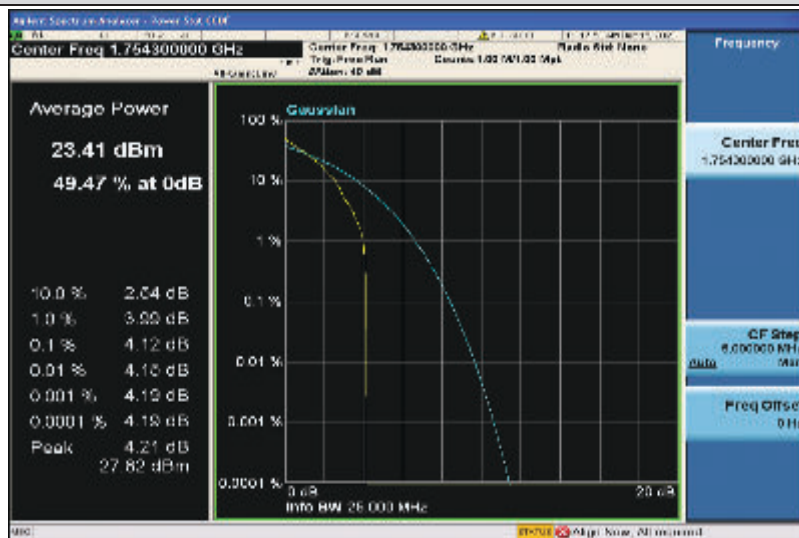

Band4-1.4MHz-QPSK-20393-1RB#0

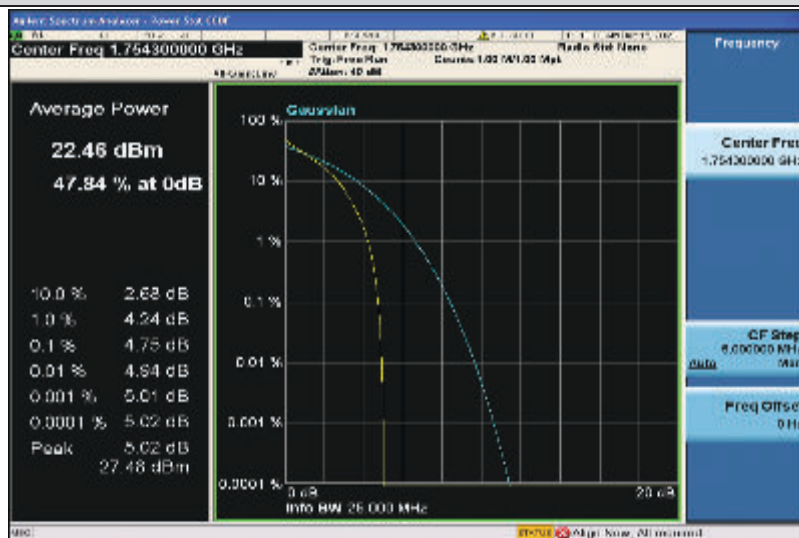

Band4-1.4MHz-QPSK-20393-6RB#0

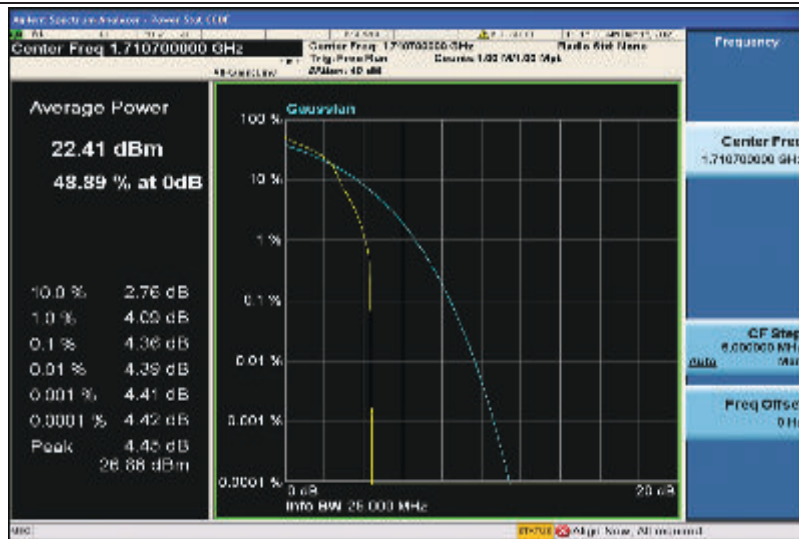

Band4-1.4MHz-16QAM-19957-1RB#0

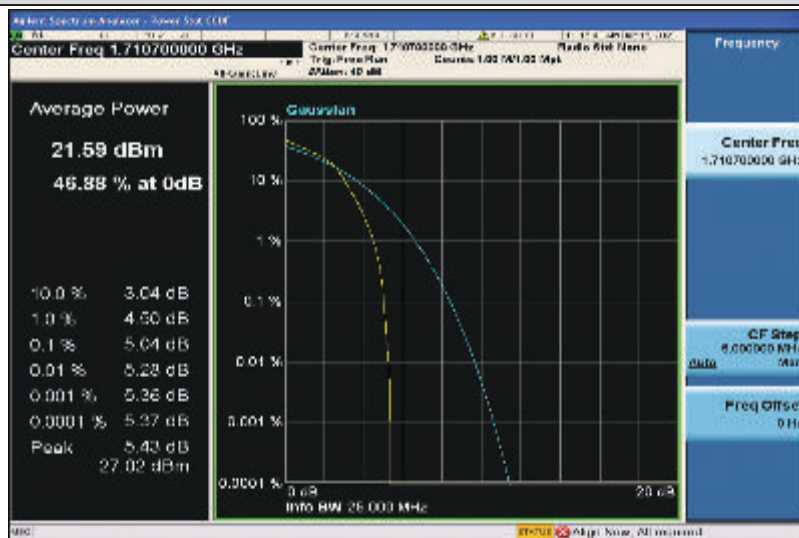

Band4-1.4MHz-16QAM-19957-6RB#0

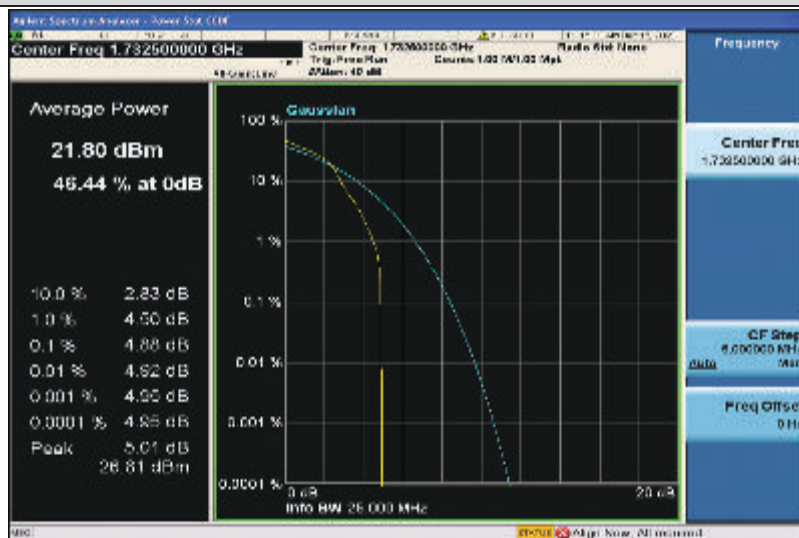

Band4-1.4MHz-16QAM-20175-1RB#0

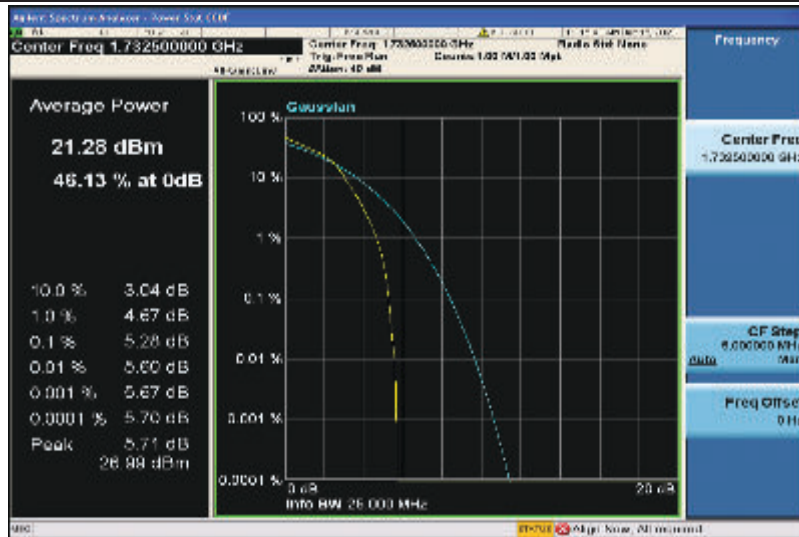

Band4-1.4MHz-16QAM-20175-6RB#0

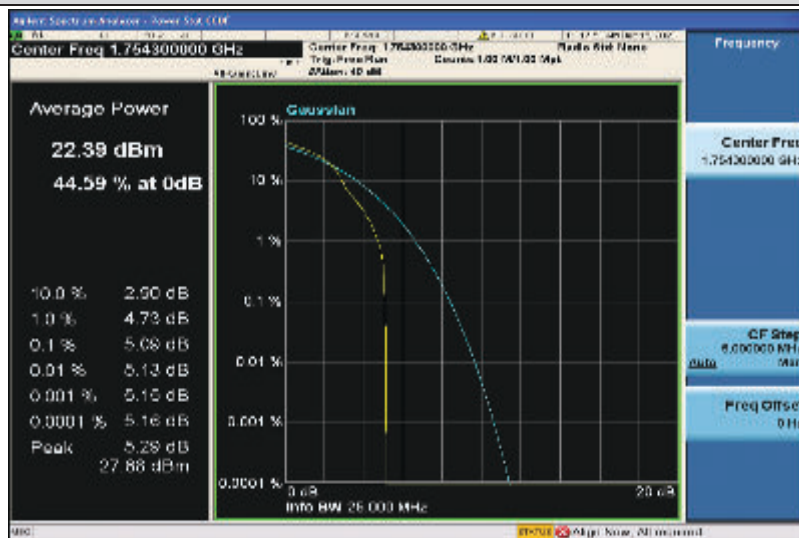

Band4-1.4MHz-16QAM-20393-1RB#0

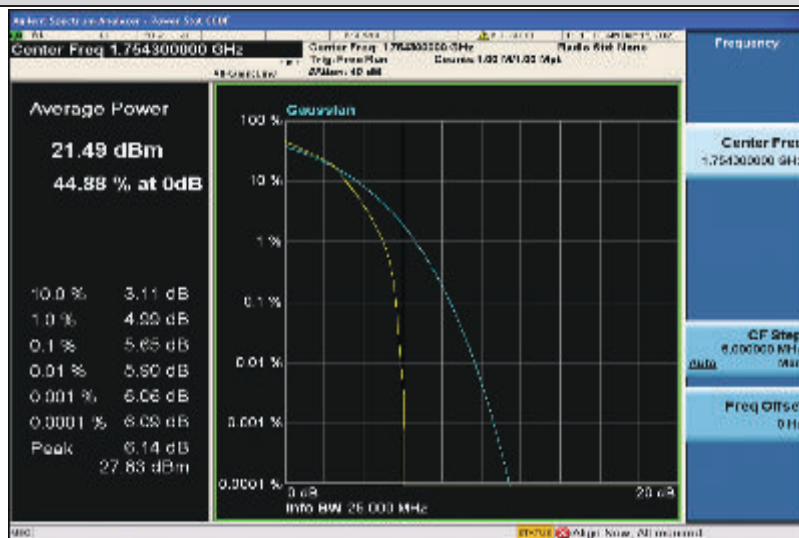

Band4-1.4MHz-16QAM-20393-6RB#0

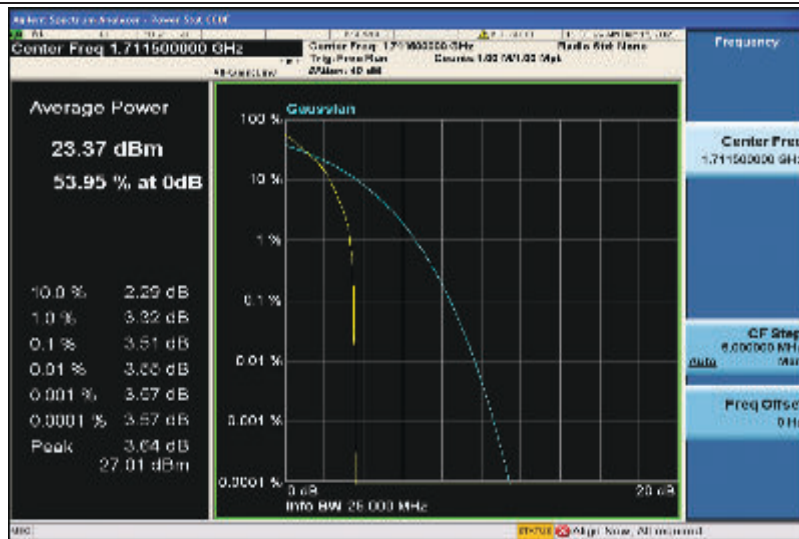

Band4-3MHz-QPSK-19965-1RB#0

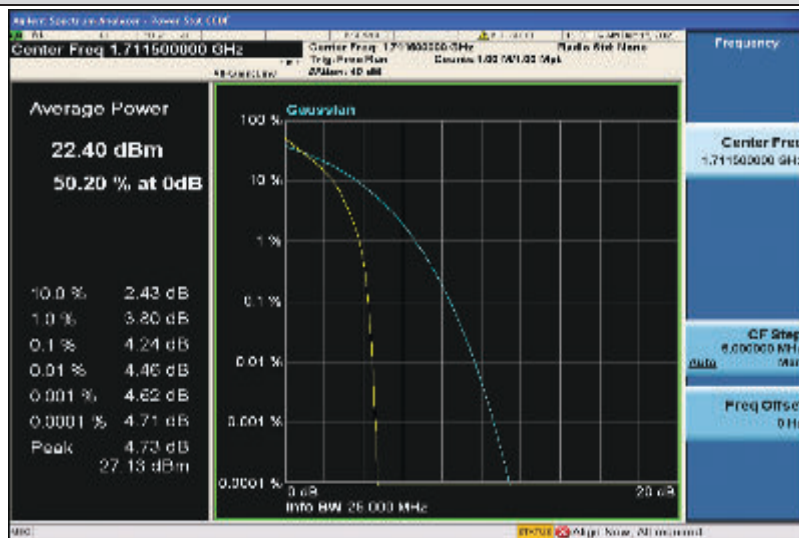

Band4-3MHz-QPSK-19965-15RB#0

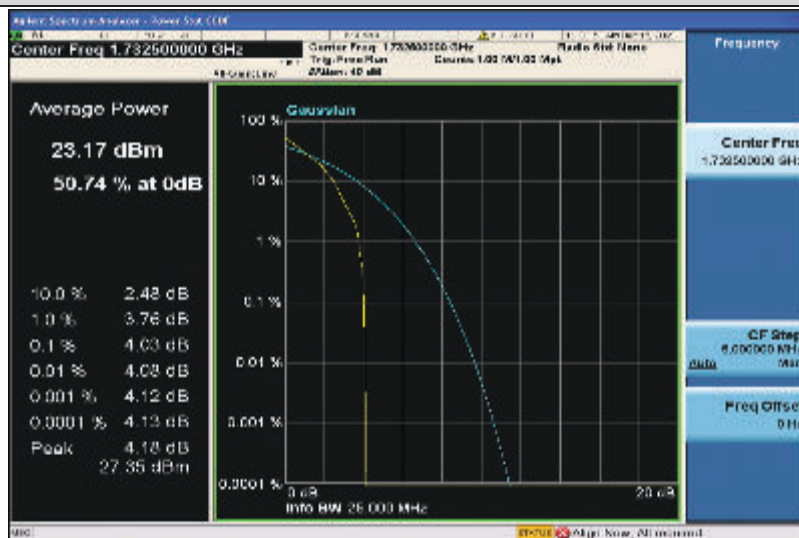

Band4-3MHz-QPSK-20175-1RB#0

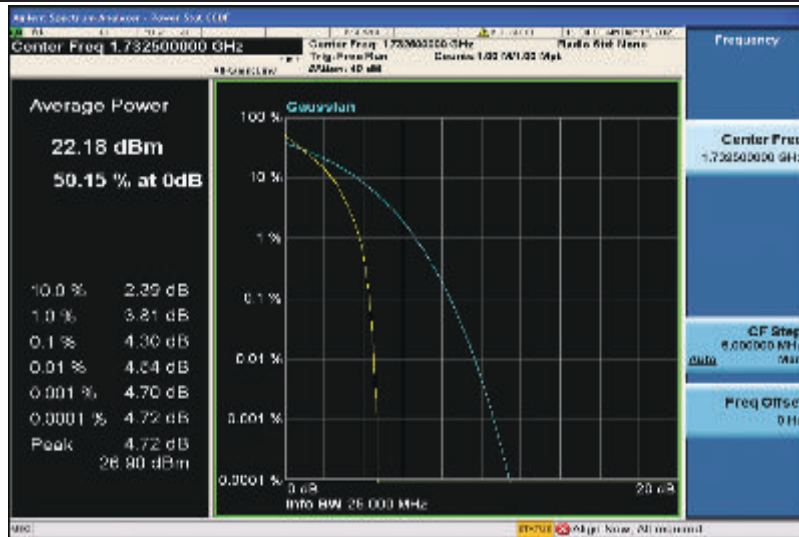

Band4-3MHz-QPSK-20175-15RB#0

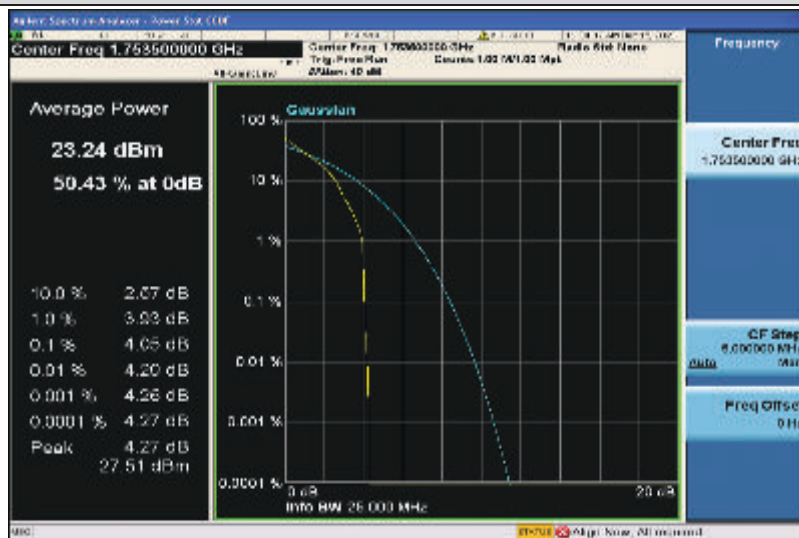

Band4-3MHz-QPSK-20385-1RB#0

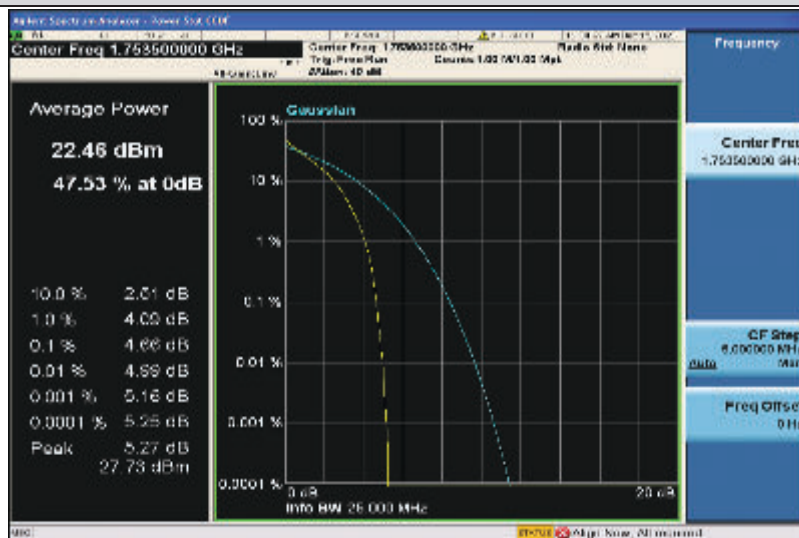

Band4-3MHz-QPSK-20385-15RB#0

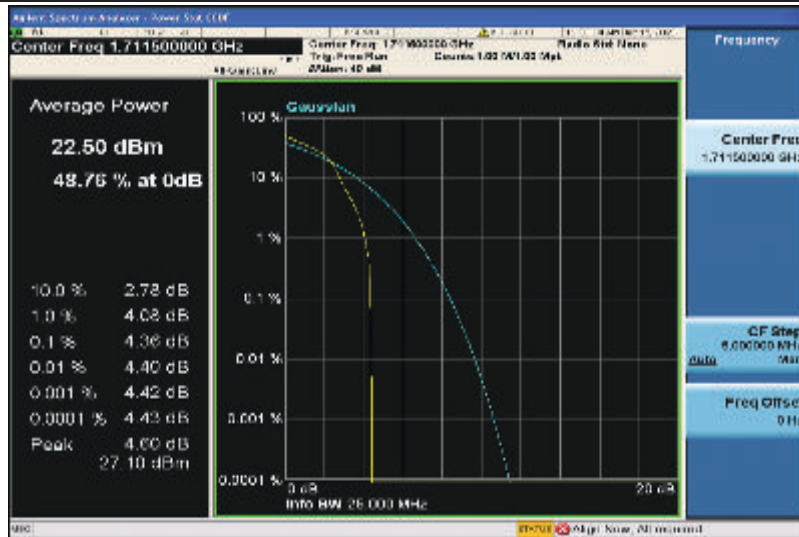

Band4-3MHz-16QAM-19965-1RB#0

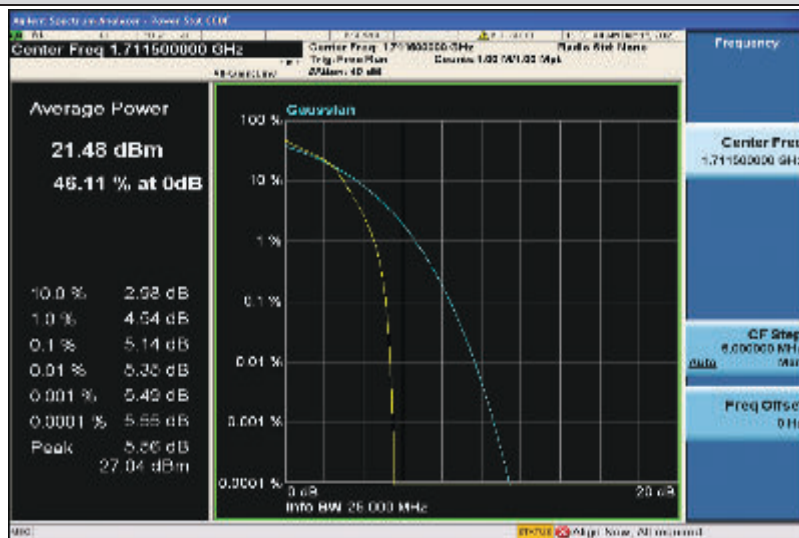

Band4-3MHz-16QAM-19965-15RB#0

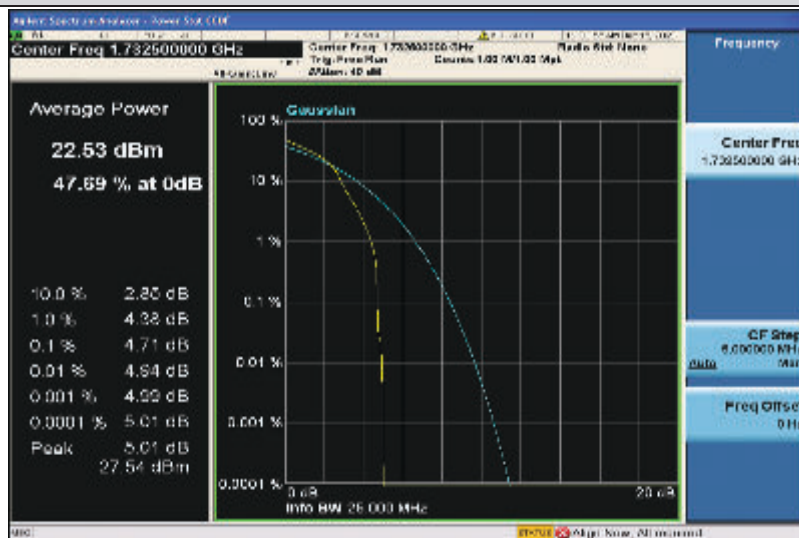

Band4-3MHz-16QAM-20175-1RB#0

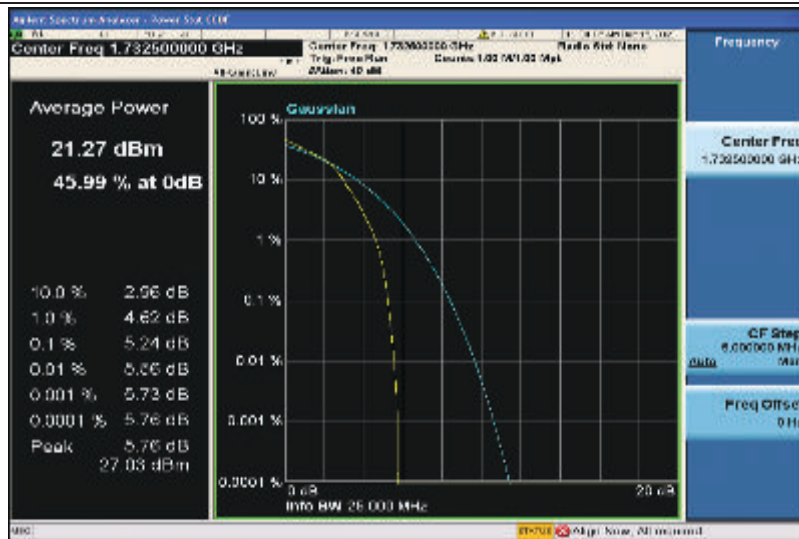

Band4-3MHz-16QAM-20175-15RB#0

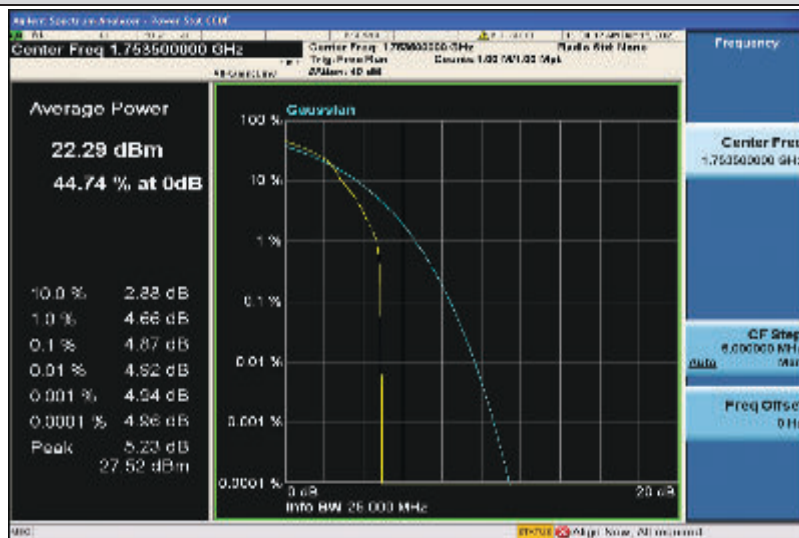

Band4-3MHz-16QAM-20385-1RB#0

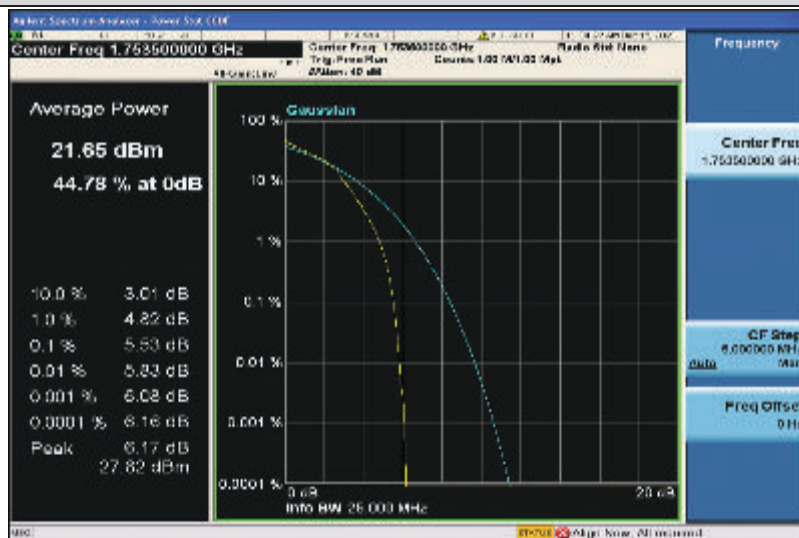

Band4-3MHz-16QAM-20385-15RB#0

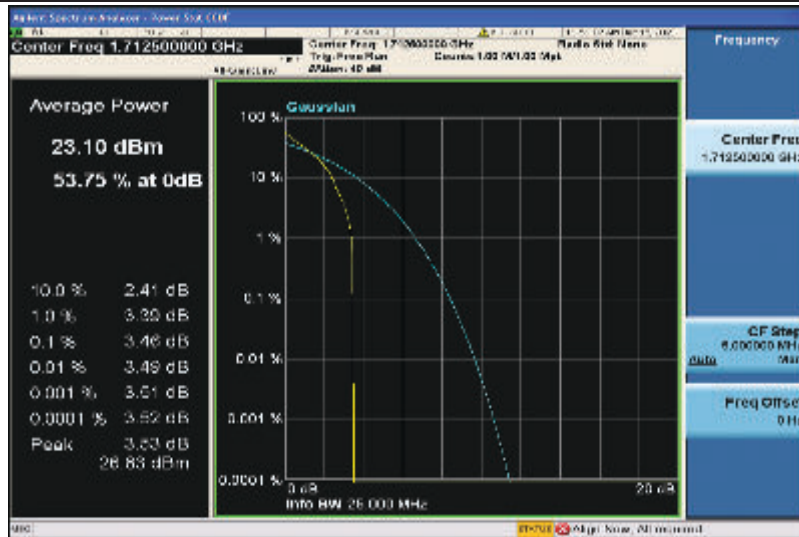

Band4-5MHz-QPSK-19975-1RB#0

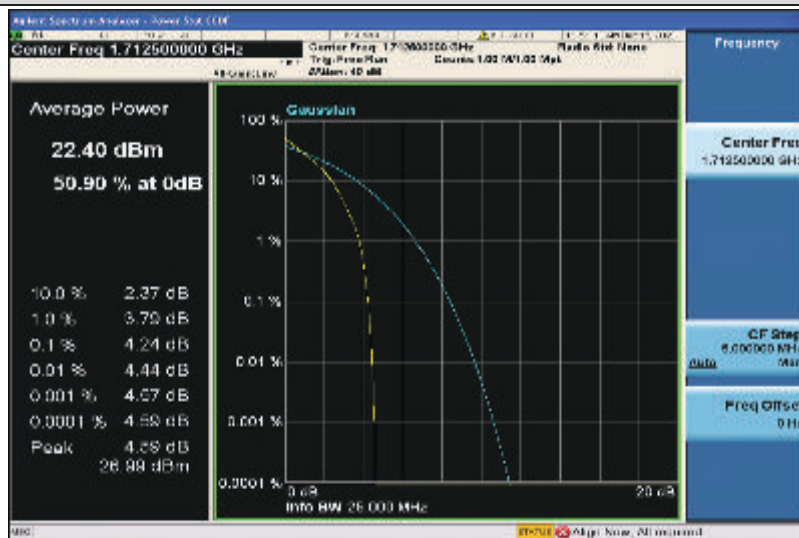

Band4-5MHz-QPSK-19975-25RB#0

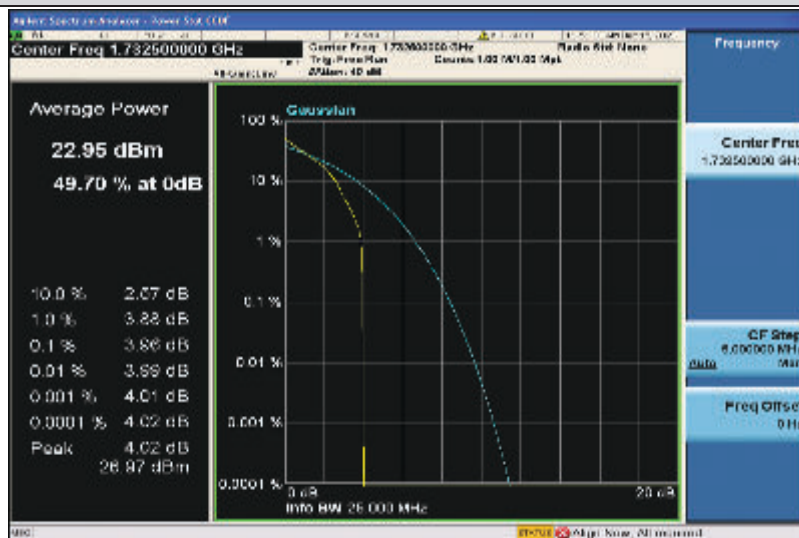

Band4-5MHz-QPSK-20175-1RB#0

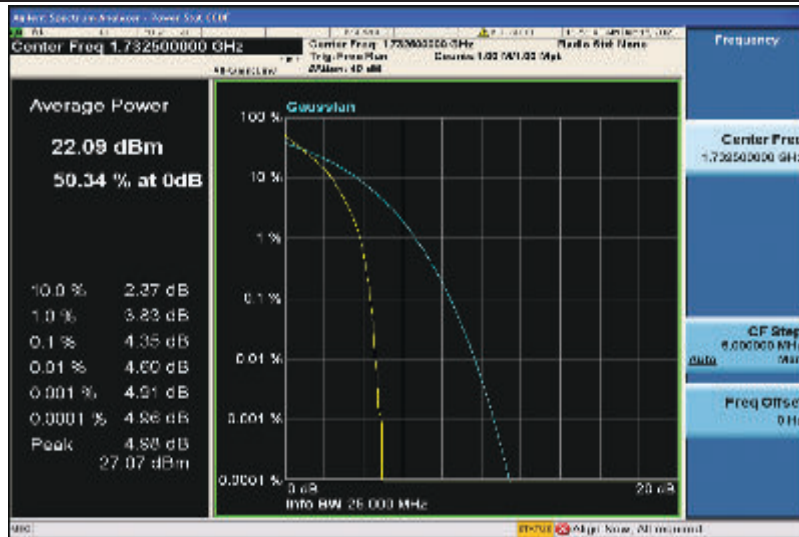

Band4-5MHz-QPSK-20175-25RB#0

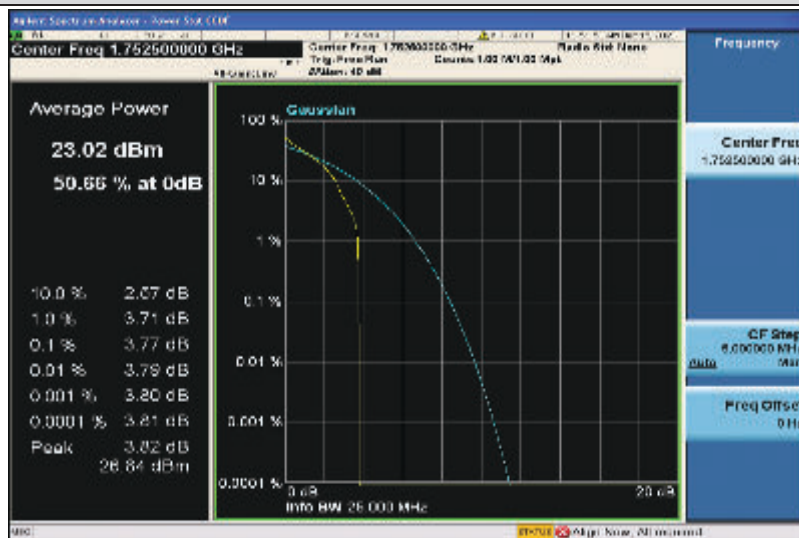

Band4-5MHz-QPSK-20375-1RB#0

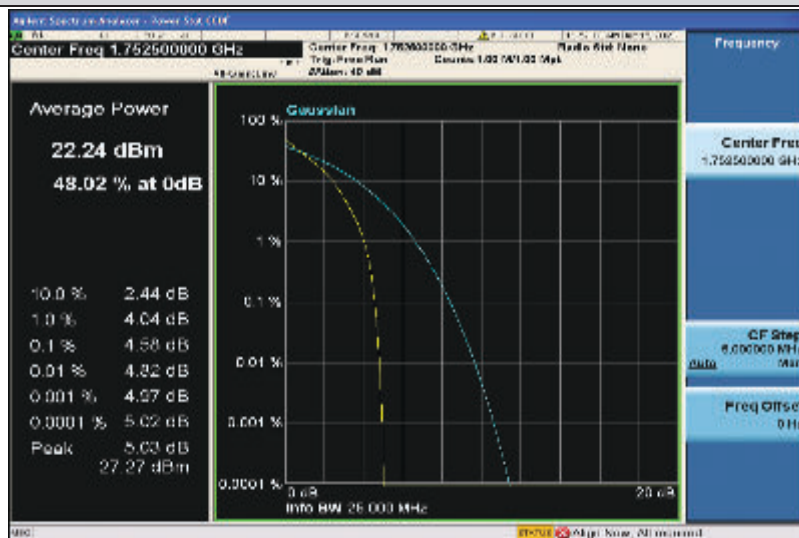

Band4-5MHz-QPSK-20375-25RB#0

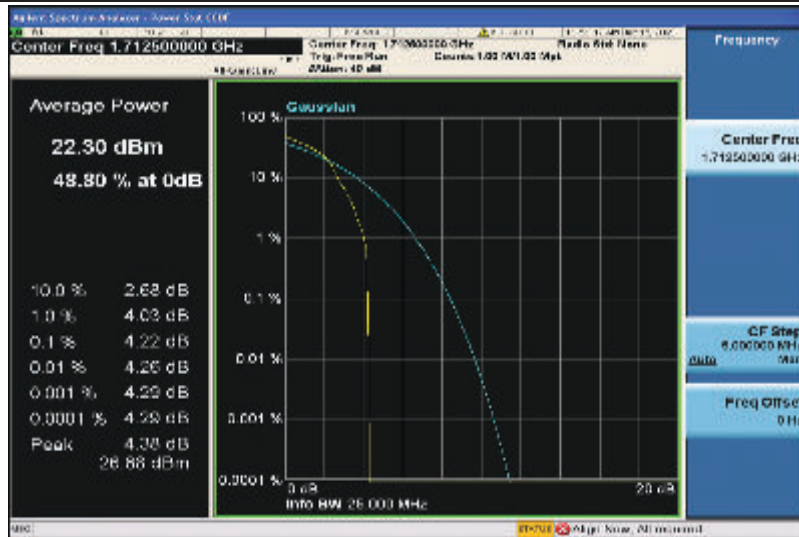

Band4-5MHz-16QAM-19975-1RB#0

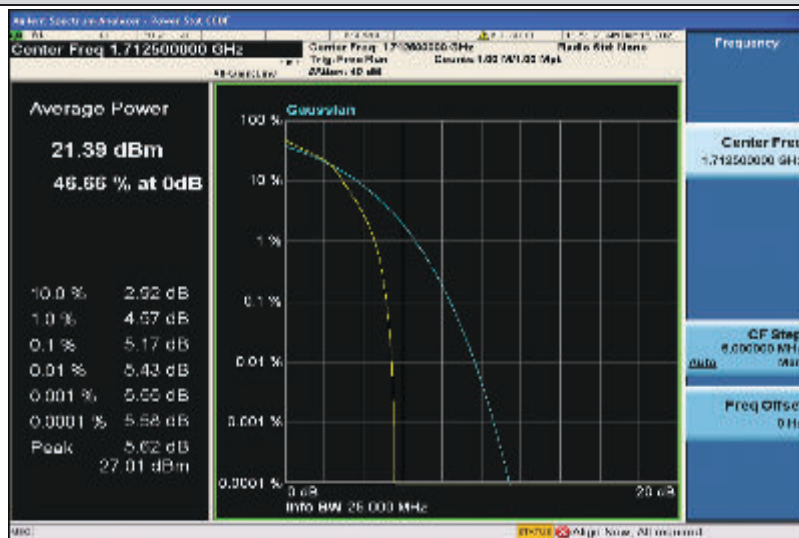

Band4-5MHz-16QAM-19975-25RB#0

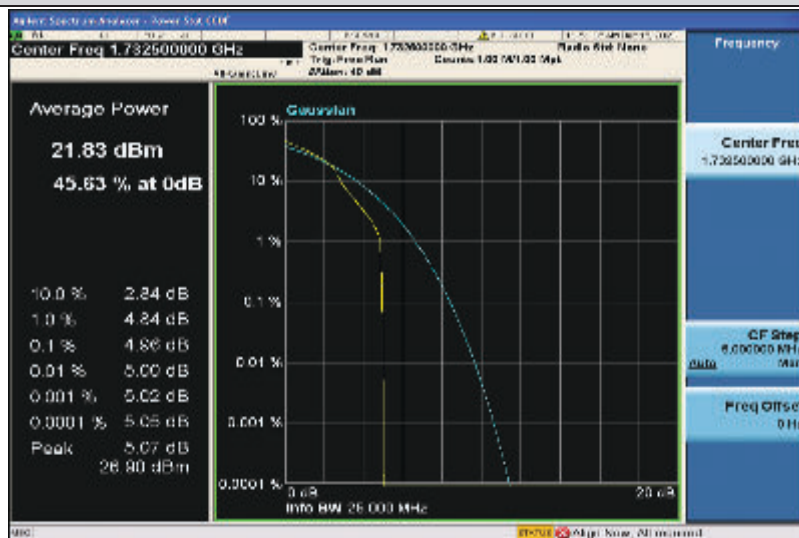

Band4-5MHz-16QAM-20175-1RB#0

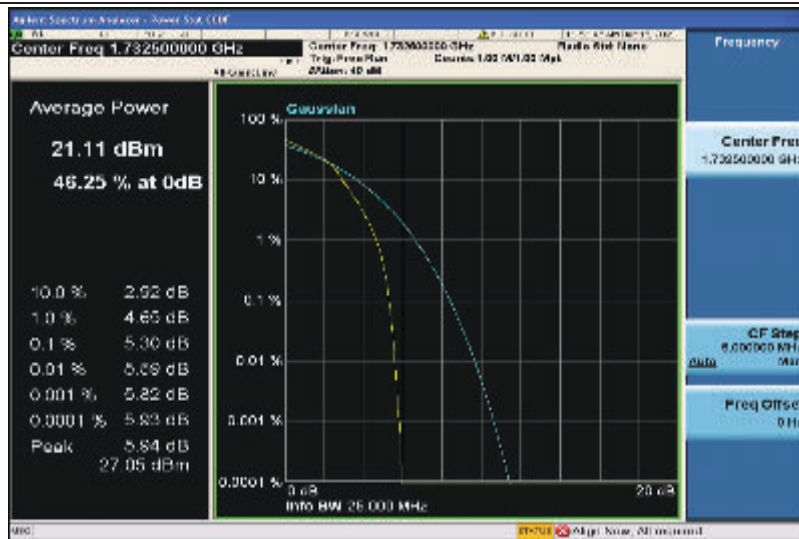

Band4-5MHz-16QAM-20175-25RB#0

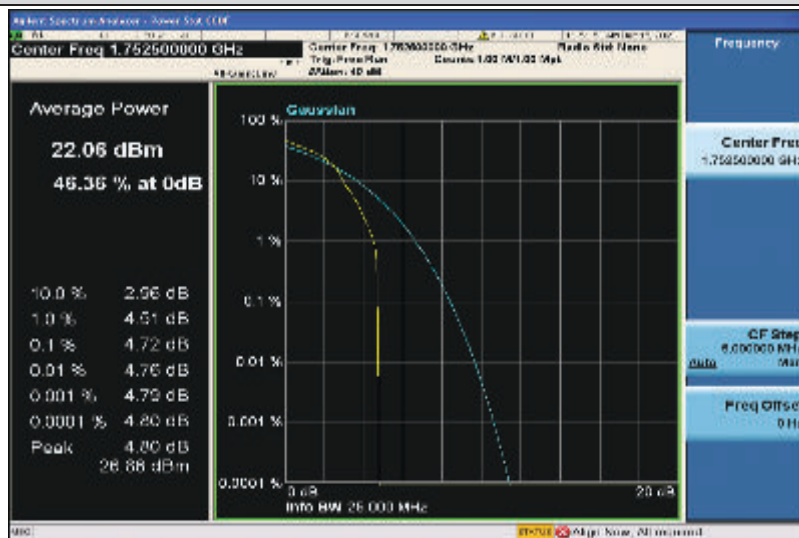

Band4-5MHz-16QAM-20375-1RB#0



Band4-5MHz-16QAM-20375-25RB#0

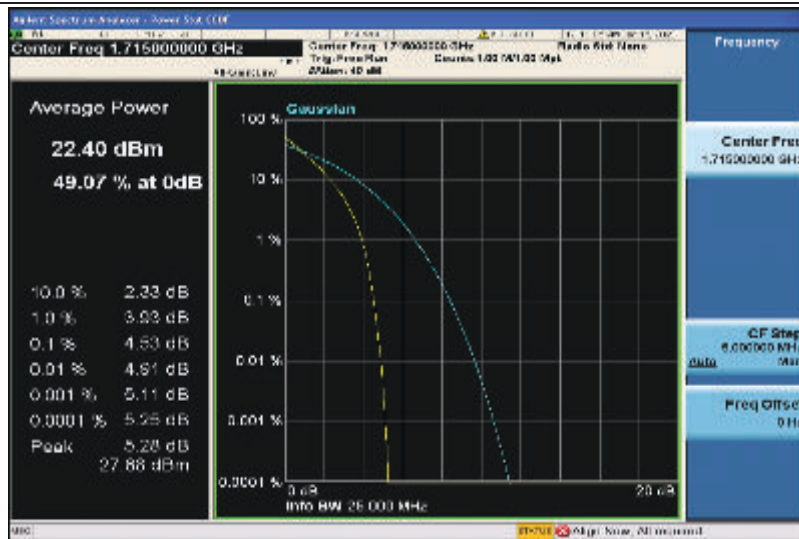

Band4-10MHz-QPSK-20000-1RB#0

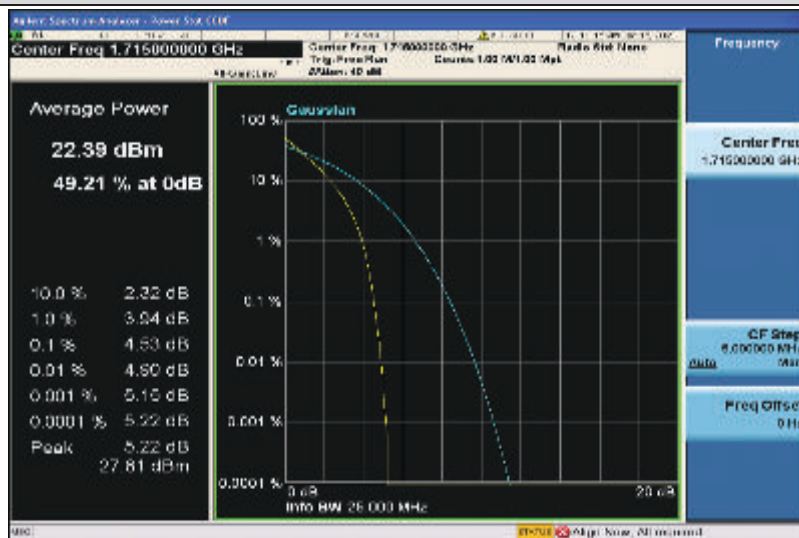

Band4-10MHz-QPSK-20000-50RB#0

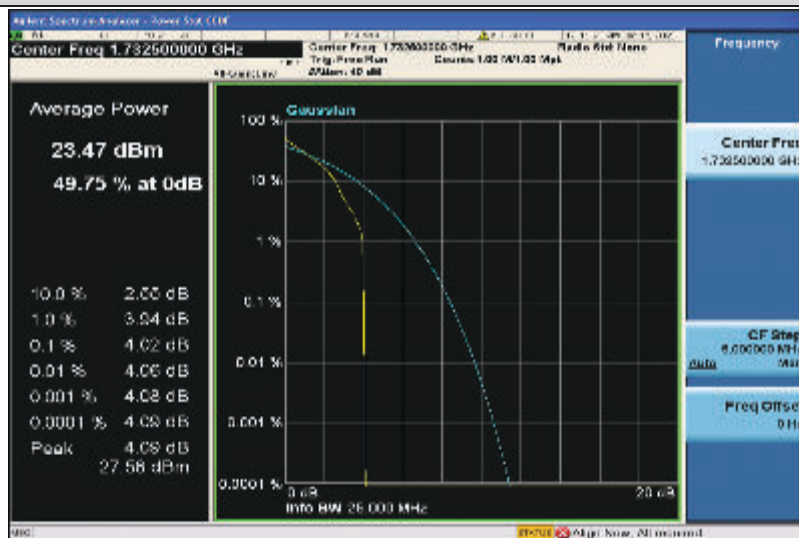

Band4-10MHz-QPSK-20175-1RB#0

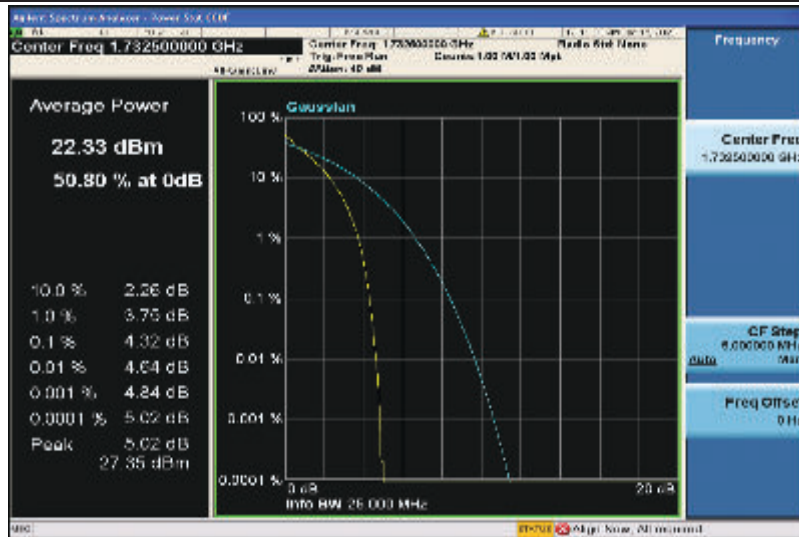

Band4-10MHz-QPSK-20175-50RB#0

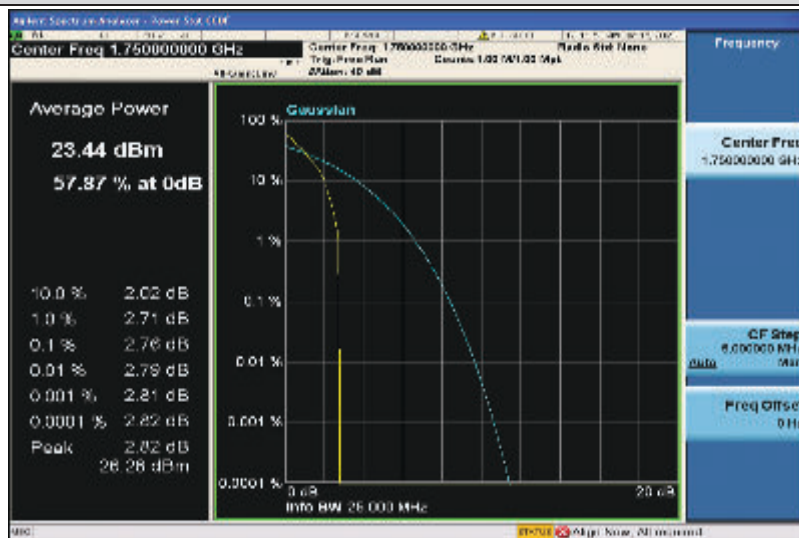

Band4-10MHz-QPSK-20350-1RB#0

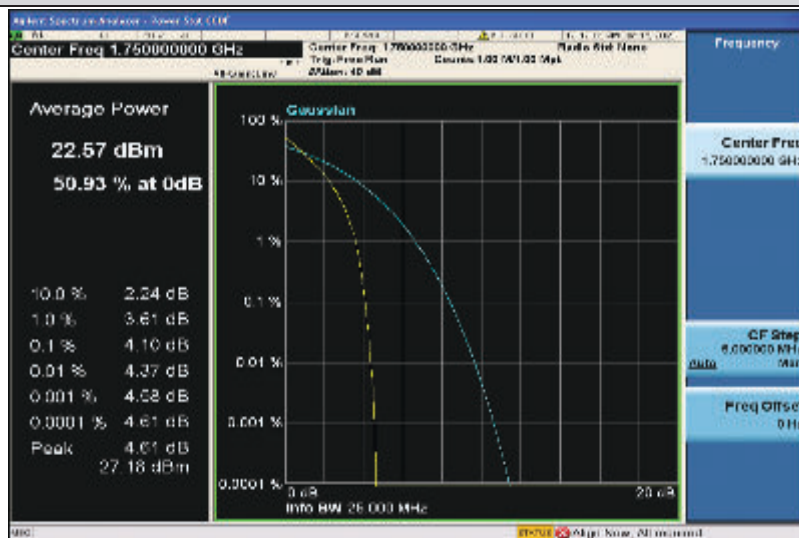

Band4-10MHz-QPSK-20350-50RB#0

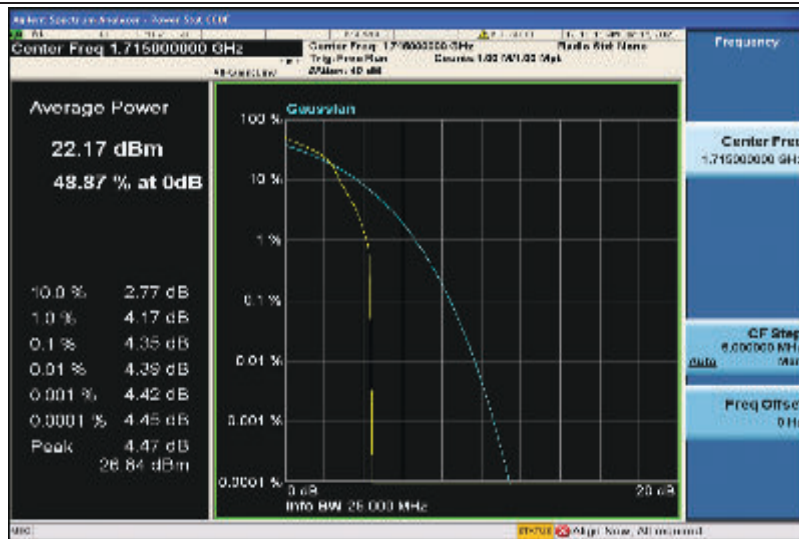

Band4-10MHz-16QAM-20000-1RB#0

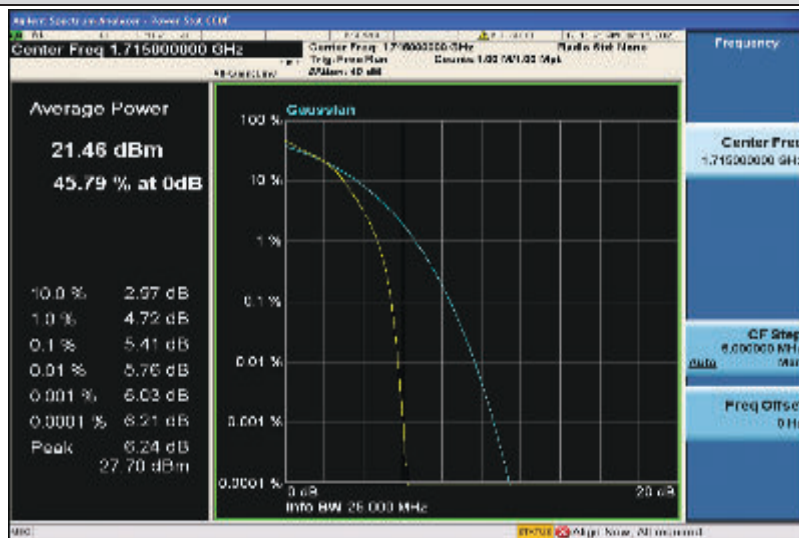

Band4-10MHz-16QAM-20000-50RB#0

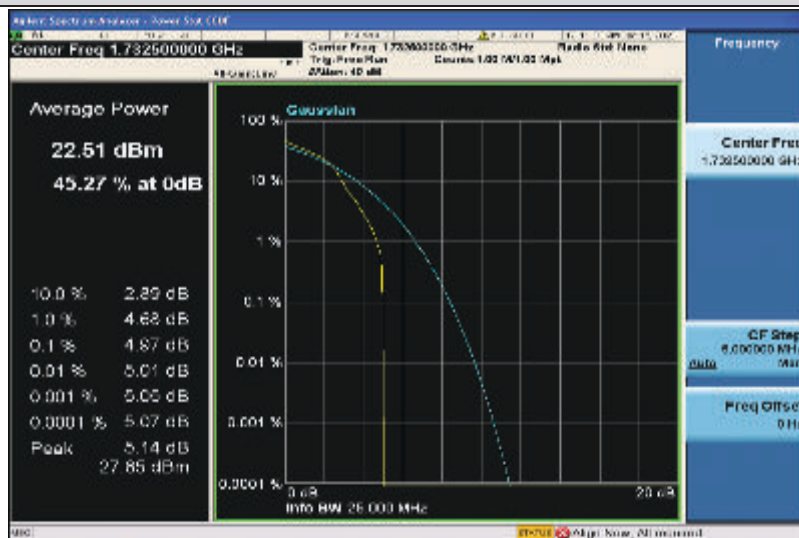

Band4-10MHz-16QAM-20175-1RB#0

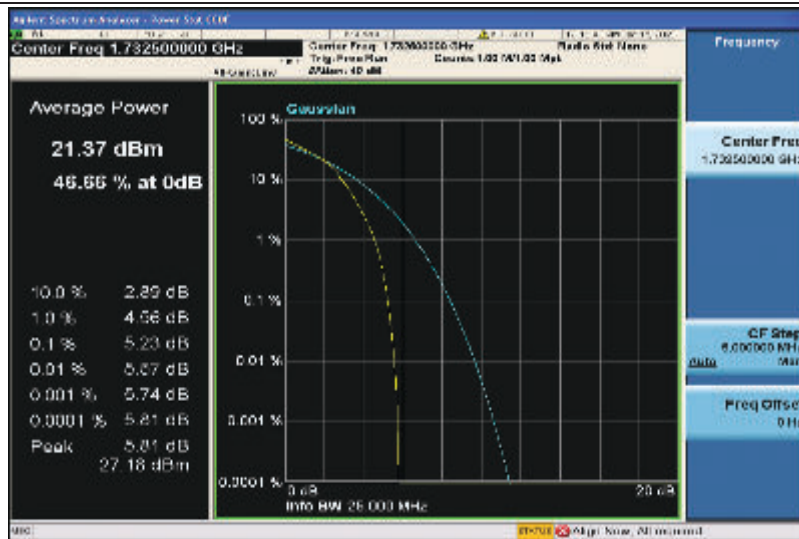

Band4-10MHz-16QAM-20175-50RB#0

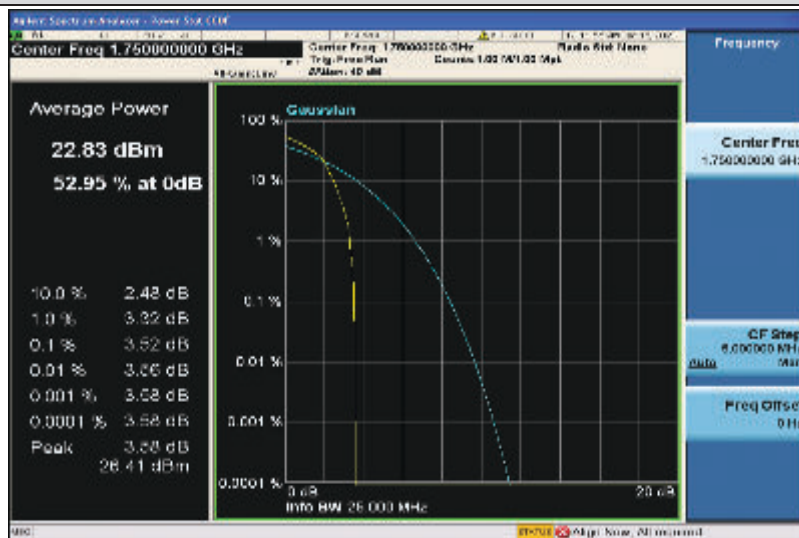

Band4-10MHz-16QAM-20350-1RB#0

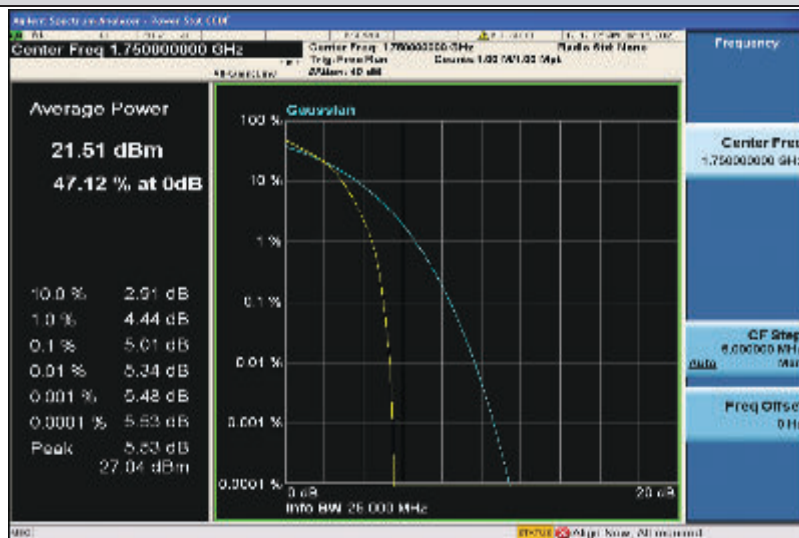

Band4-10MHz-16QAM-20350-50RB#0

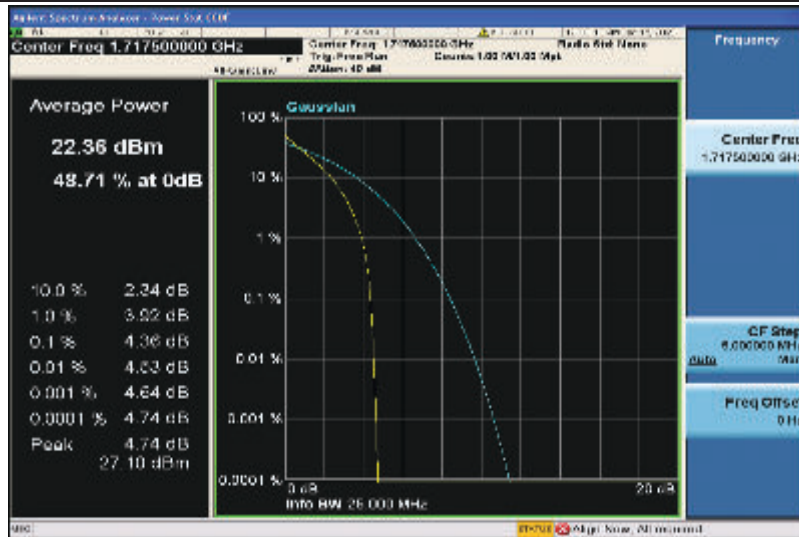

Band4-15MHz-QPSK-20025-1RB#0

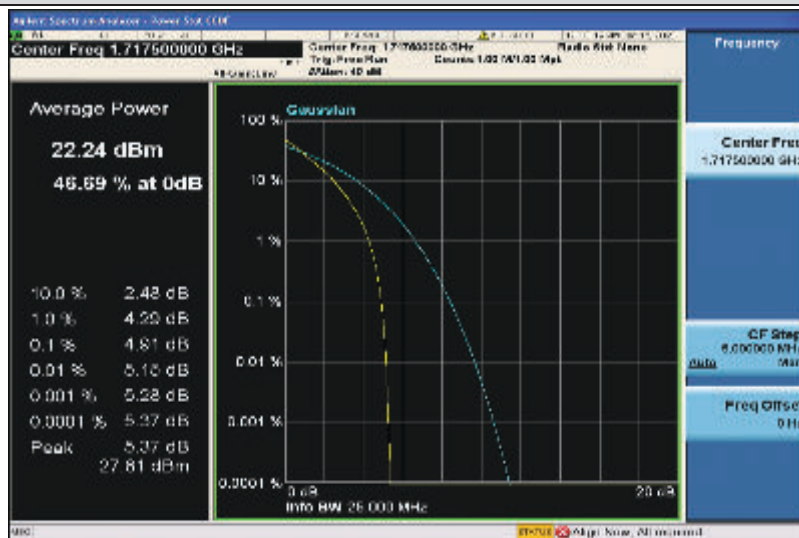

Band4-15MHz-QPSK-20025-75RB#0

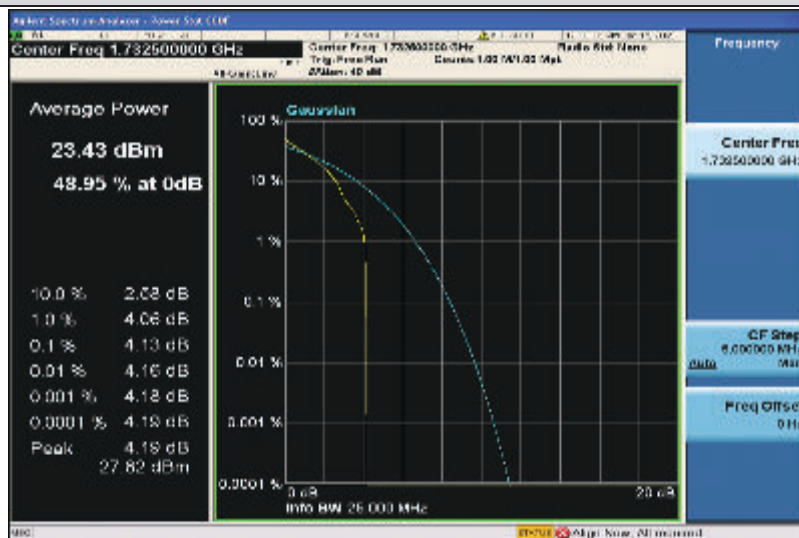

Band4-15MHz-QPSK-20175-1RB#0



Band4-15MHz-QPSK-20175-75RB#0

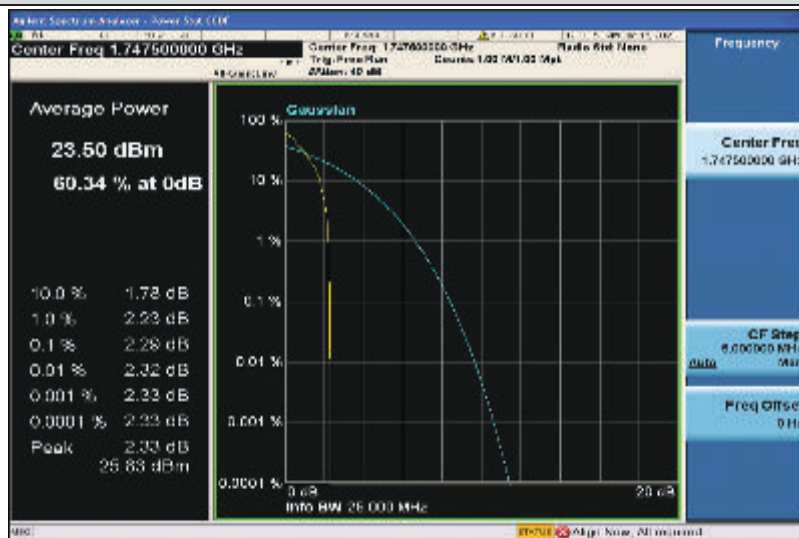

Band4-15MHz-QPSK-20325-1RB#0

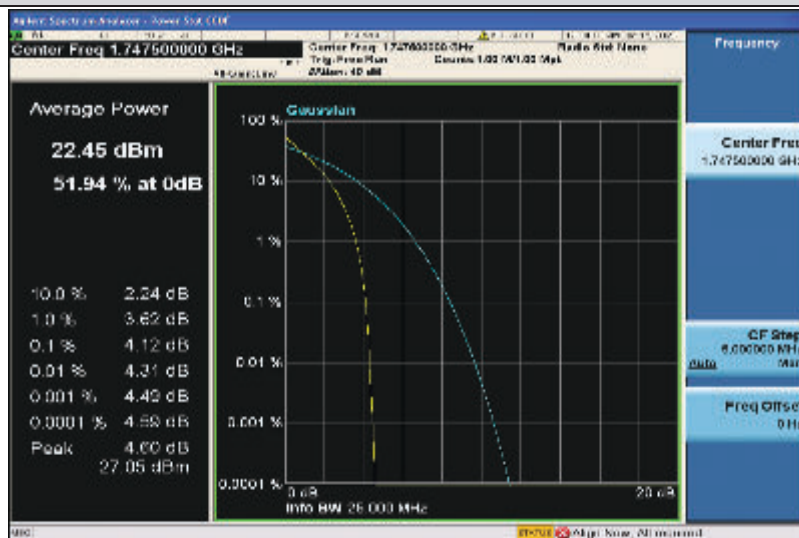

Band4-15MHz-QPSK-20325-75RB#0

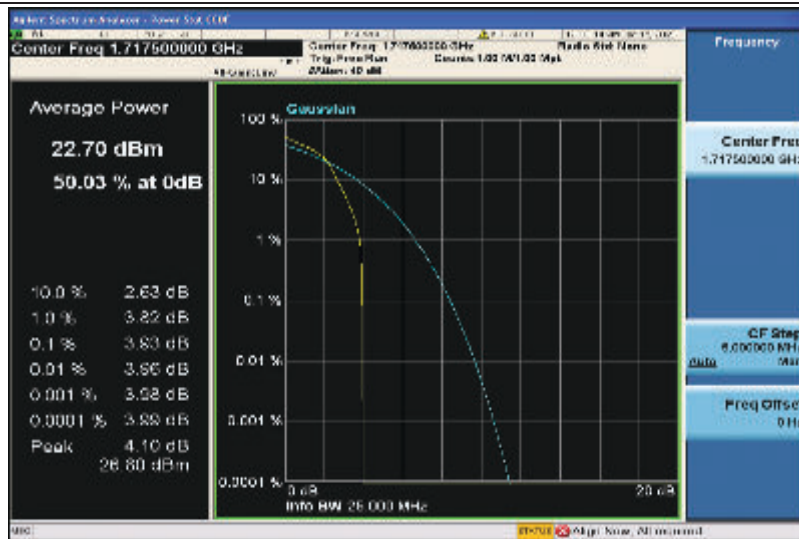

Band4-15MHz-16QAM-20025-1RB#0

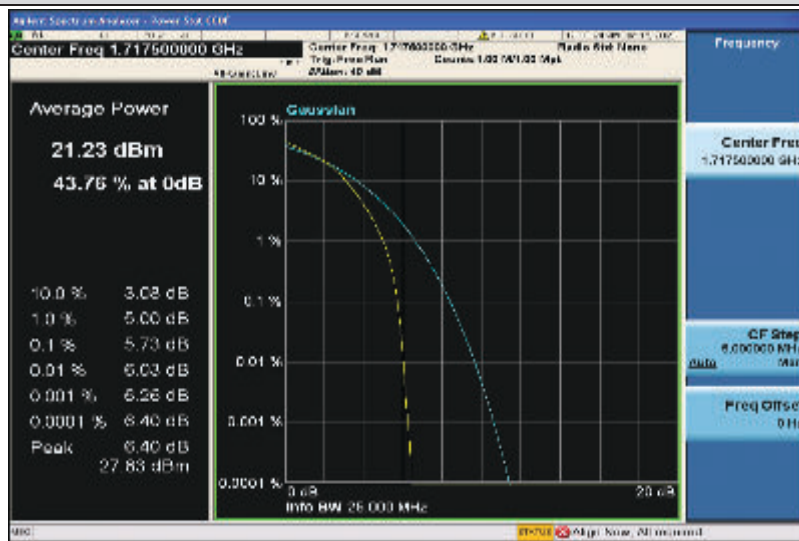

Band4-15MHz-16QAM-20025-75RB#0

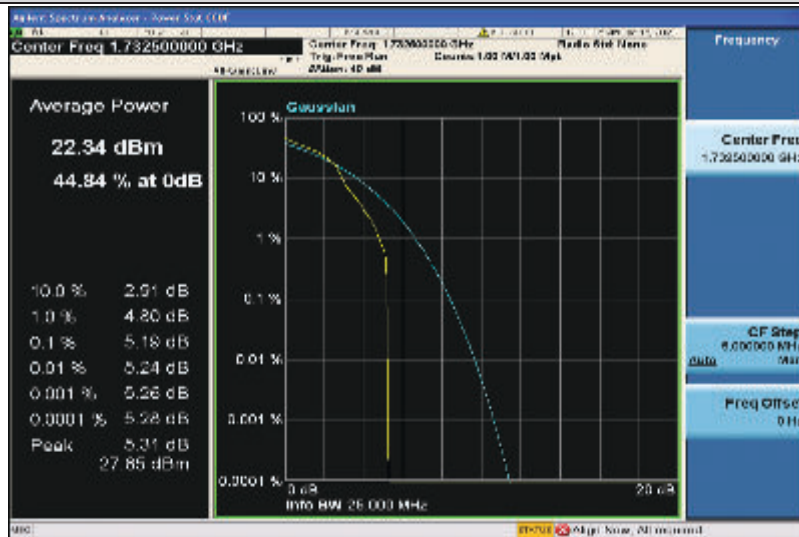

Band4-15MHz-16QAM-20175-1RB#0

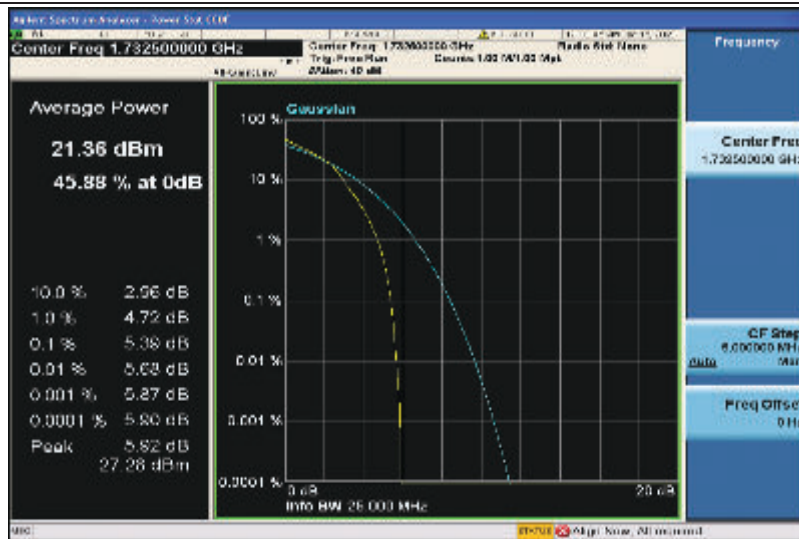

Band4-15MHz-16QAM-20175-75RB#0

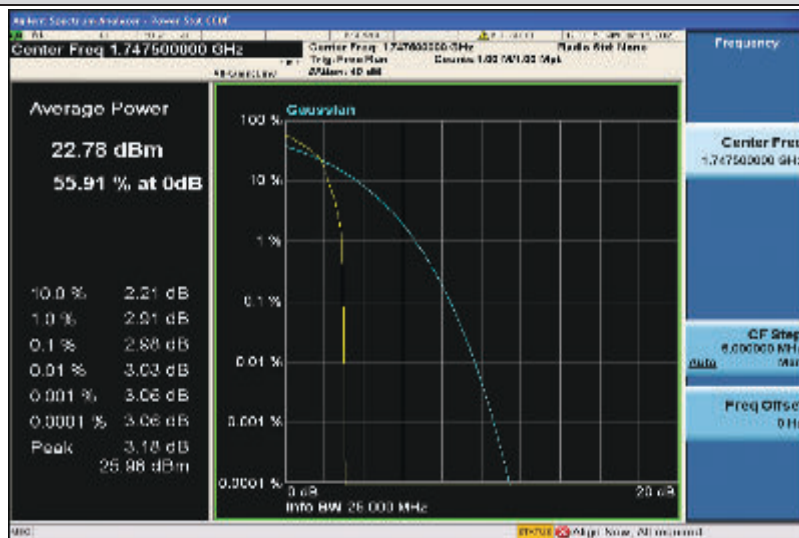

Band4-15MHz-16QAM-20325-1RB#0

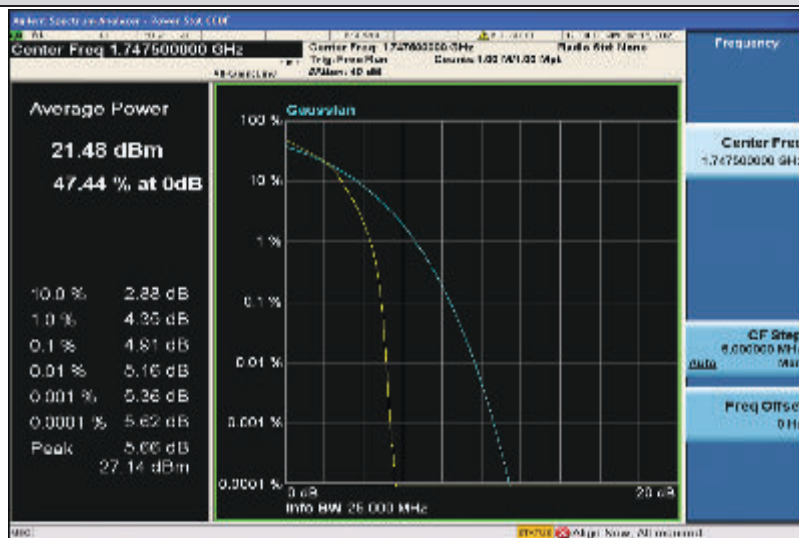

Band4-15MHz-16QAM-20325-75RB#0

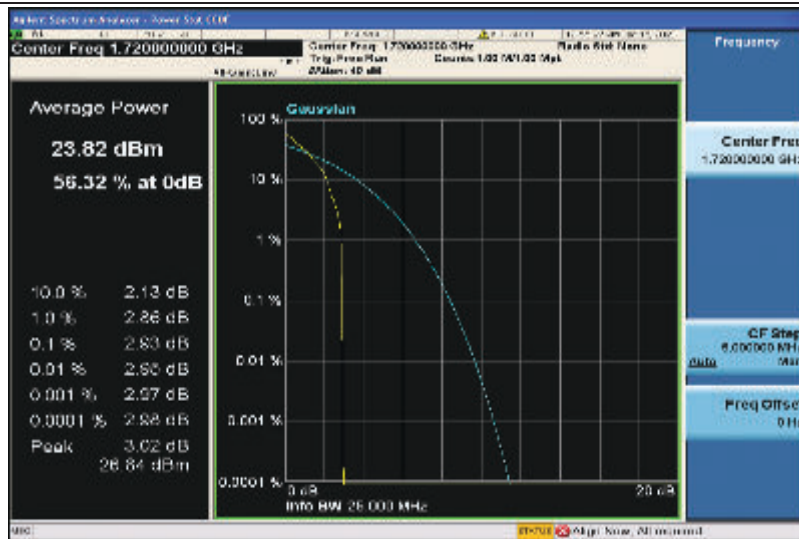

Band4-20MHz-QPSK-20050-1RB#0

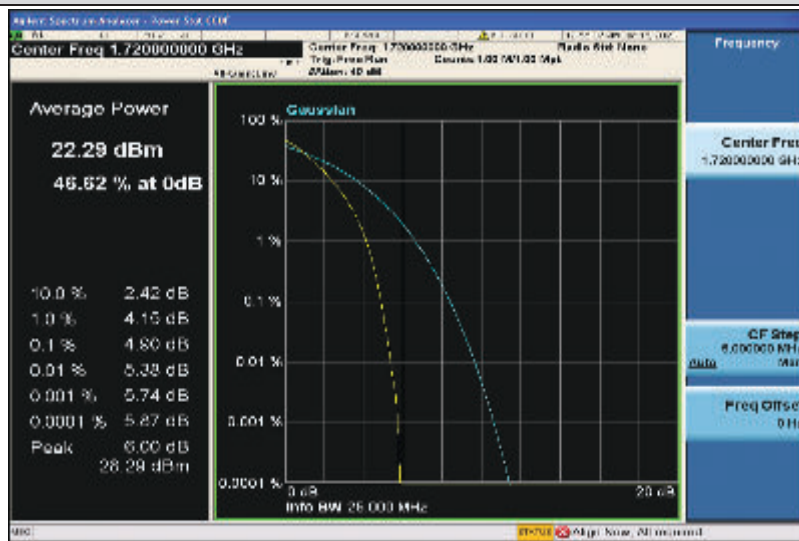

Band4-20MHz-QPSK-20050-100RB#0

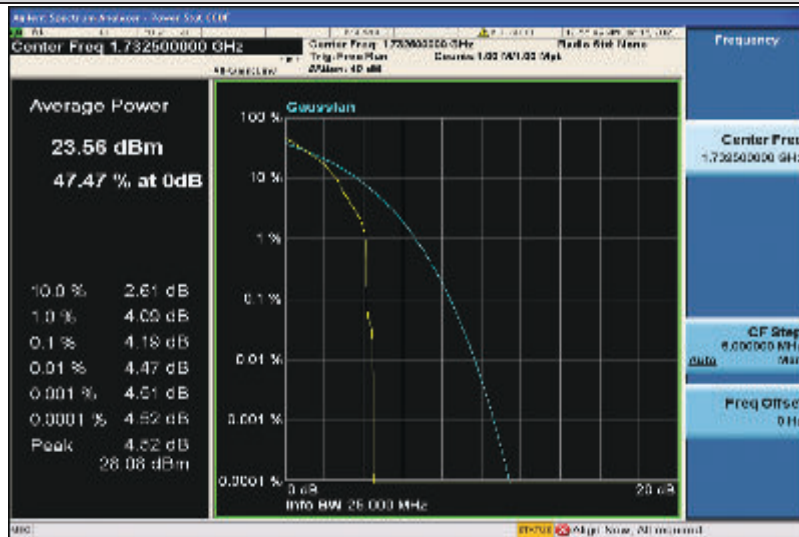

Band4-20MHz-QPSK-20175-1RB#0

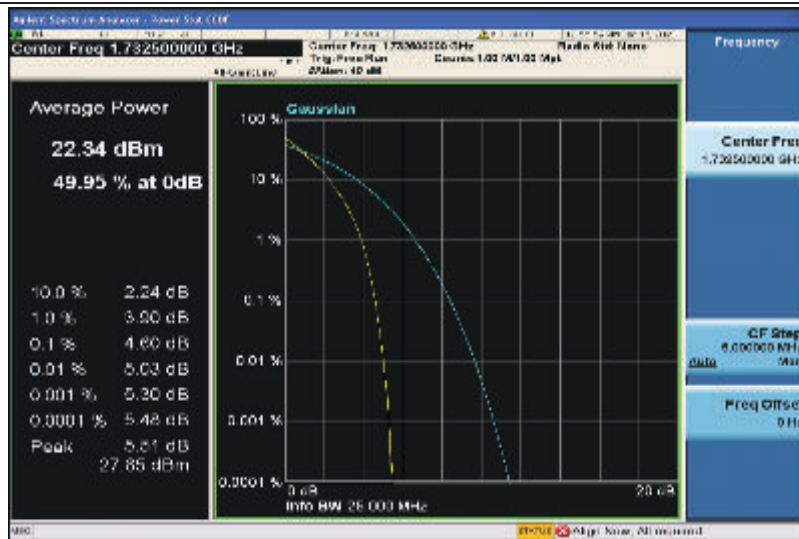

Band4-20MHz-QPSK-20175-100RB#0

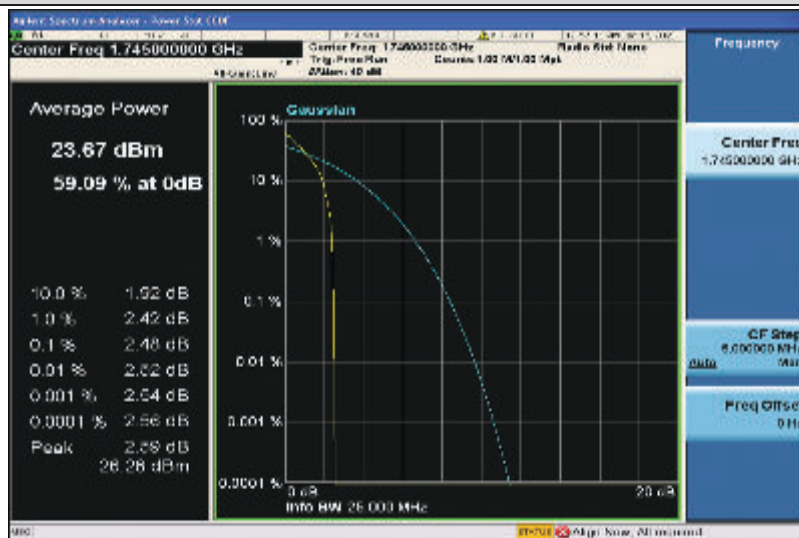

Band4-20MHz-QPSK-20300-1RB#0

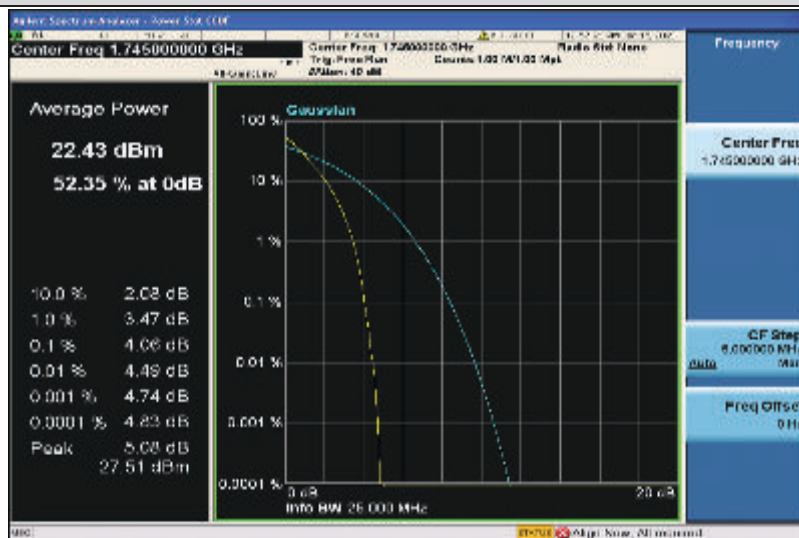

Band4-20MHz-QPSK-20300-100RB#0

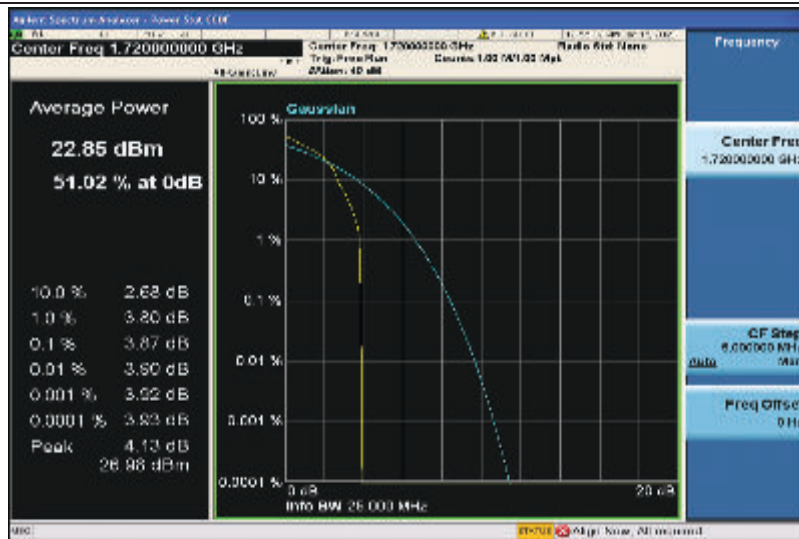

Band4-20MHz-16QAM-20050-1RB#0

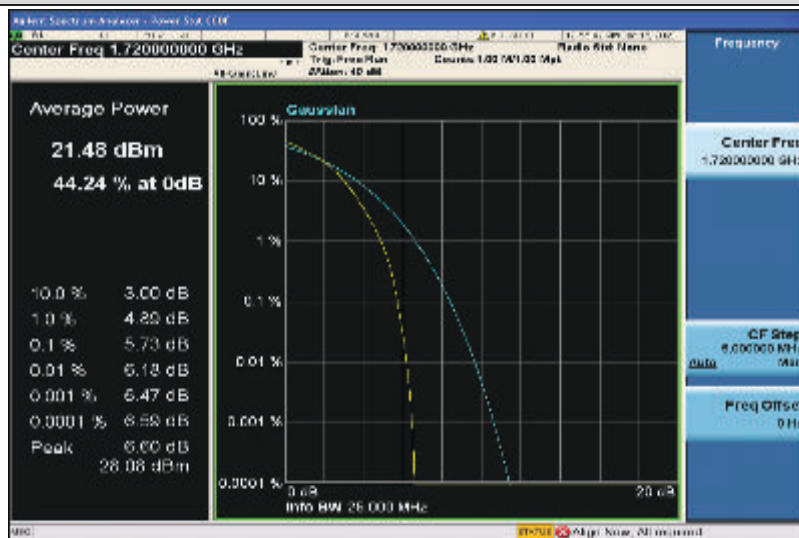

Band4-20MHz-16QAM-20050-100RB#0

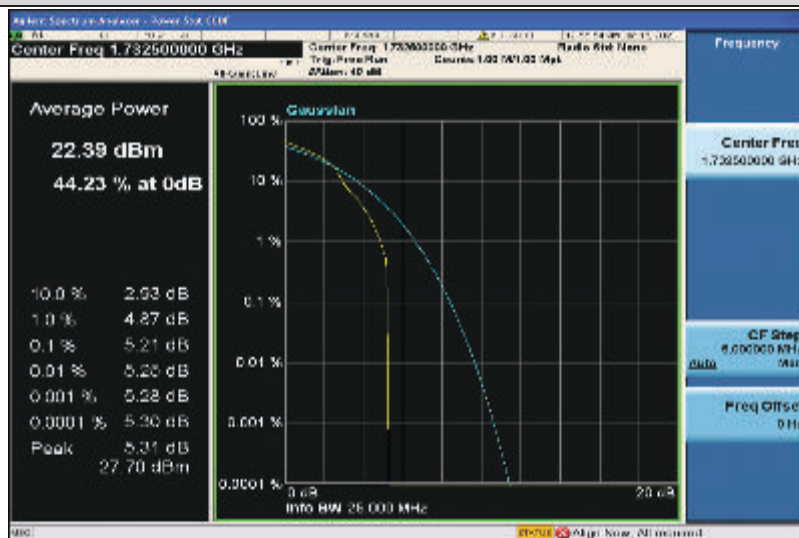

Band4-20MHz-16QAM-20175-1RB#0

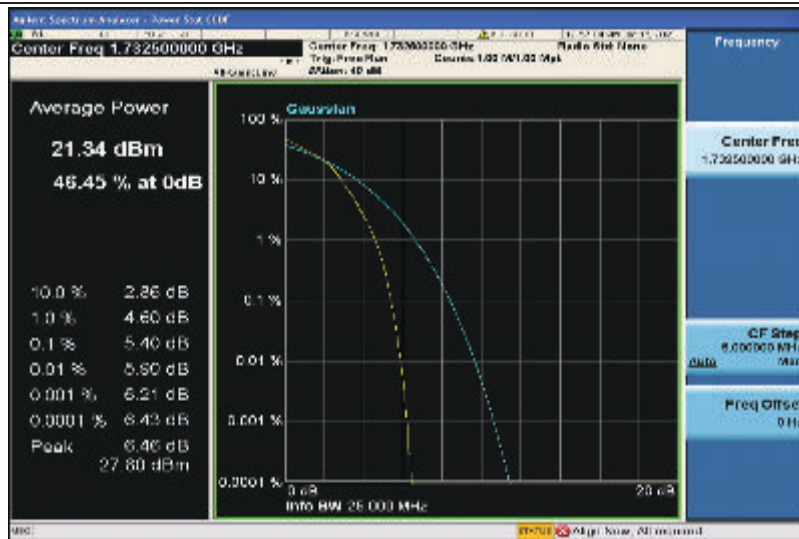

Band4-20MHz-16QAM-20175-100RB#0

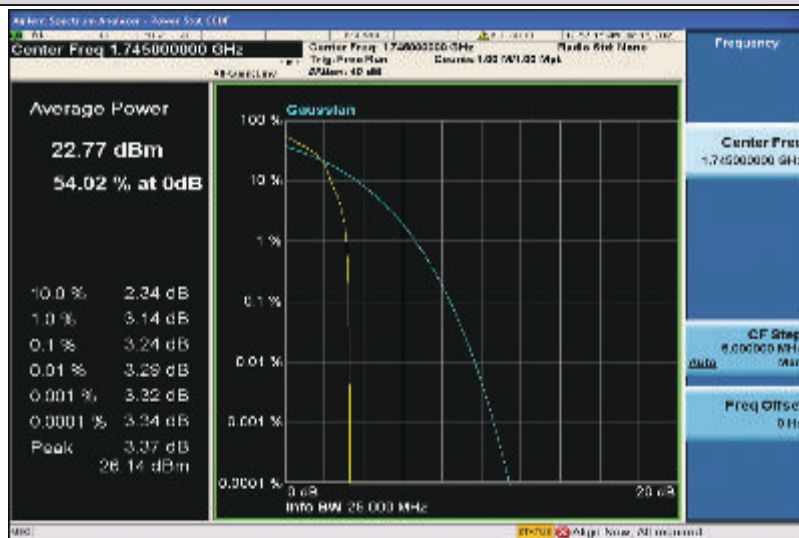

Band4-20MHz-16QAM-20300-1RB#0

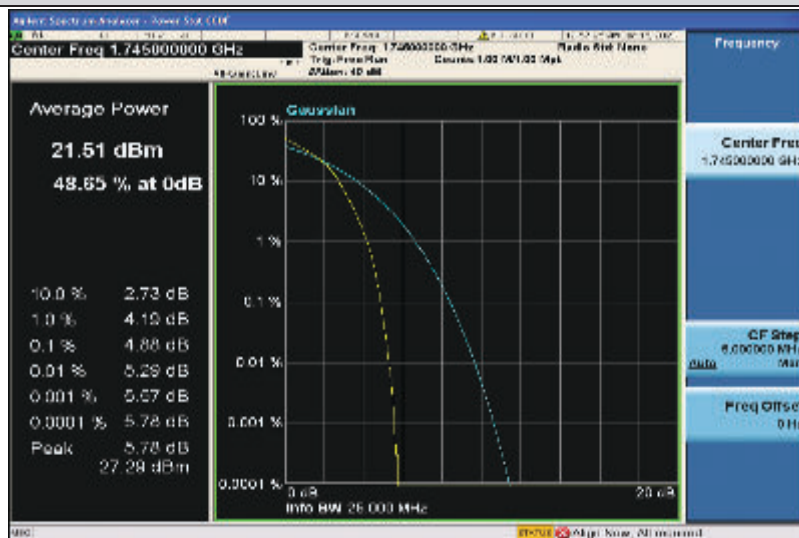

Band4-20MHz-16QAM-20300-100RB#0

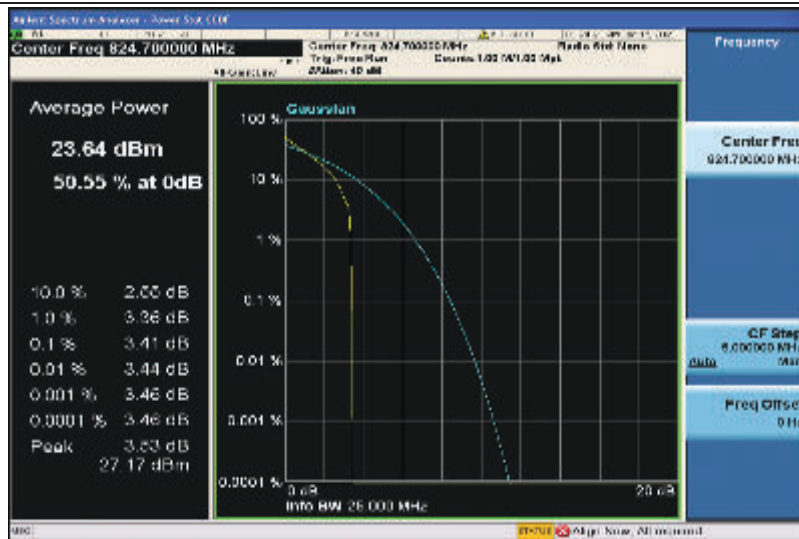

Band5-1.4MHz-QPSK-20407-1RB#0

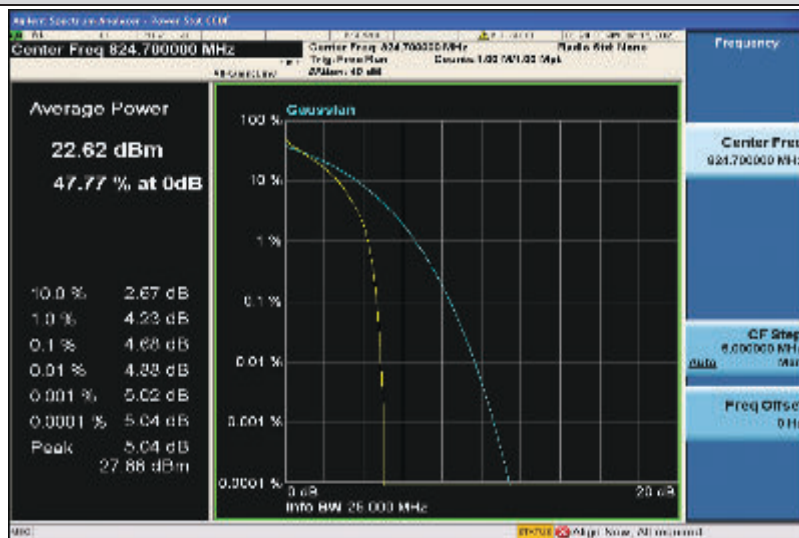

Band5-1.4MHz-QPSK-20407-6RB#0

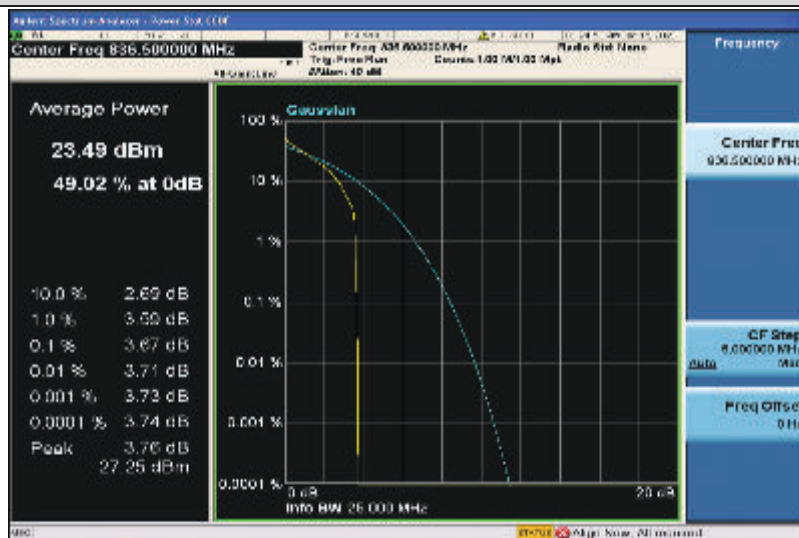

Band5-1.4MHz-QPSK-20525-1RB#0

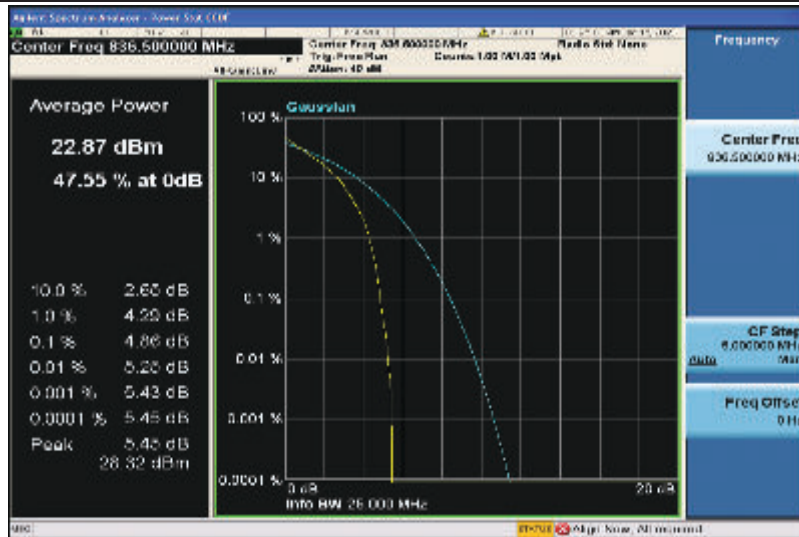

Band5-1.4MHz-QPSK-20525-6RB#0

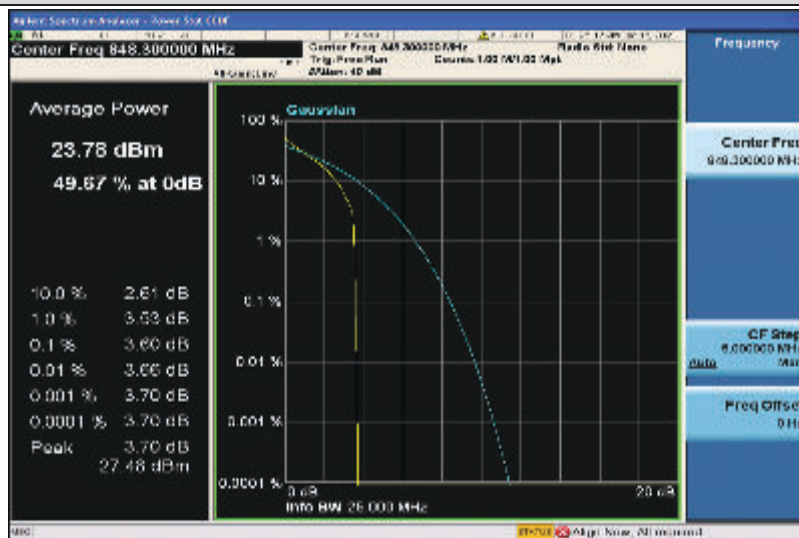

Band5-1.4MHz-QPSK-20643-1RB#0

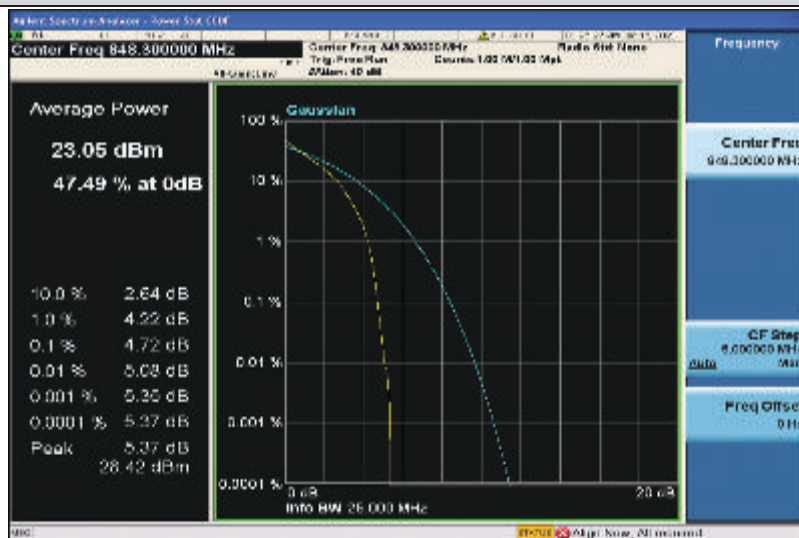

Band5-1.4MHz-QPSK-20643-6RB#0