

**FCC 47 CFR PART 15 SUBPART C**  
**Canada RSS-247 Issue2**  
**Canada RSS-Gen Issue5**

**TEST REPORT**

For

**Product Name: Coding Processor**

**Brand Name: Little Tinkerer**

**Model No.: MC1002**

**Series Model.: N/A**

**FCC ID: 2AQUSMC1002**

**IC: 24188-MC1002**

**Test Report Number:**

**C181022R01-RPB1**

Issued for

**Beijing Little Tinkerer Co. Ltd**

**Room 511, 5th Floor, Block B, Building 1, No. 2, Yongcheng North Road, Haidian District, Beijing**

Issued by

**Compliance Certification Services Inc.**

**Kun shan Laboratory**

**No.10 Weiye Rd., Innovation park, Eco&Tec,  
Development Zone, Kunshan City, Jiangsu, China**

**TEL: 86-512-57355888**

**FAX: 86-512-57370818**



**Note:** This report shall not be reproduced except in full, without the written approval of Compliance Certification Services Inc. This document may be altered or revised by Compliance Certification Services Inc. personnel only, and shall be noted in the revision section of the document. The client should not use it to claim product endorsement by A2LA or any government agencies. The test results in the report only apply to the tested sample.

## TABLE OF CONTENTS

<b>1</b>	<b>TEST RESULT CERTIFICATION .....</b>	<b>4</b>
<b>2</b>	<b>EUT DESCRIPTION .....</b>	<b>5</b>
<b>3</b>	<b>TEST METHODOLOGY .....</b>	<b>6</b>
	3.1 EUT CONFIGURATION .....	6
	3.2 EXERCISEEUT.....	6
	3.3 GENERAL TEST PROCEDURES.....	6
	3.4 TEST MODE .....	7
	3.5 RESTRICTED BANDS OF OPERATIONS .....	8
	3.6 ANTENNA DESCRIPTION.....	10
<b>4</b>	<b>INSTRUMENT CALIBRATION .....</b>	<b>11</b>
<b>5</b>	<b>FACILITIES AND ACCREDITATIONS .....</b>	<b>11</b>
	5.1 FACILTIES.....	11
	5.2 EQUIPMENT.....	11
	5.3 LABORATORY ACCREDITATIONS AND LISTING .....	11
	5.4 TABLE OF ACCREDITATIONS .....	12
	5.5 LIST OF MEASURING EQUIPMENT .....	13
	5.6 MEASUREMENT UNCERTAINTY .....	15
	5.7 SETUP CONFIGURATION .....	16
	5.8 SUPPORT EQUIPMENT .....	16
<b>6</b>	<b>FCC PART 15.247 &amp; RSS-247 REQUIREMENTS .....</b>	<b>17</b>
	6.1 MAXIMUM CONDUCTED OUTPUT POWER.....	17
	6.2 PEAK POWER SPECTRAL DENSITY .....	19
	6.3 6DB BANDWIDTH MEASUREMENT.....	22
	6.4 99% BANDWIDTH MEASUREMENT .....	25
	6.5 CONDUCTED BAND EDGES AND SPURIOUS EMISSION MEASUREMENT.....	28
	6.6 RADIATED BAND EDGE AND SPURIOUS EMISSION MEASUREMENT .....	35
	6.7 POWERLINE CONDUCTED EMISSIONS .....	47

## Revision History

Rev.	Issue Date	Report NO.	Effect Page	Contents
00	August 27, 2018	C180810R03-RPB1	ALL	N/A
01	October 23, 2018	C181022R01-PRB1	P1,P4,P5	Modify the Product Name, Model No., IC and FCC ID.

# 1 TEST RESULT CERTIFICATION

<b>Product Name:</b>	Coding Processor
<b>Trade Name:</b>	Little Tinkerer
<b>Model Name:</b>	MC1002
<b>Series Model:</b>	N/A
<b>Applicant Discrepancy:</b>	Initial
<b>Device Category:</b>	mobile unit
<b>Date of Test:</b>	August 23, 2018
<b>Applicant:</b>	<b>Beijing Little Tinkerer Co. Ltd</b> Room 511, 5th Floor, Block B, Building 1, No. 2, Yongcheng North Road, Haidian District, Beijing
<b>Manufacturer:</b>	<b>Beijing Little Tinkerer Co. Ltd</b> Room 511, 5th Floor, Block B, Building 1, No. 2, Yongcheng North Road, Haidian District, Beijing
<b>Application Type:</b>	Certification

APPLICABLE STANDARDS	
STANDARD	TEST RESULT
FCC 47 CFR Part 15 Subpart C	No non-compliance noted
Canada RSS-247 Issue2	No non-compliance noted
Canada RSS-Gen Issue5	No non-compliance noted

The above equipment was tested by Compliance Certification Services Inc. The test data, data evaluation, test procedures, and equipment configurations shown in this report were made in accordance with the procedures given in ANSI C63.10:2013 and the energy emitted by the sample EUT tested as described in this report is in compliance with the requirements of FCC Rules Part 15.207, 15.209, 15.247 and IC rules RSS-247 Issue2, RSS-Gen Issue5.

The test results of this report relate only to the tested sample EUT identified in this report.

**Approved by:**



**Tested by:**

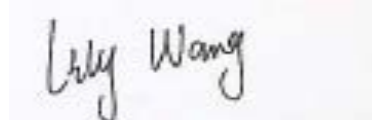

Jeff.Fang  
 RF Manager  
 Compliance Certification Services Inc.

Lily.Wang  
 Test Engineer  
 Compliance Certification Services Inc.

## 2 EUT DESCRIPTION

<b>Product Name:</b>	Coding Processor
<b>Trade Name:</b>	Little Tinkerer
<b>Model Name:</b>	MC1002
<b>Series Model:</b>	N/A
<b>Model Discrepancy:</b>	N/A
<b>EUT Power Rating:</b>	DC 4.5-5.5V
<b>Frequency Range :</b>	Bluetooth:2402 ~ 2480 MHz
<b>Transmit Power :</b>	Bluetooth LE4.2: -1.23dBm(0.753mW)
<b>Channel Spacing</b>	Bluetooth LE4.2: 2MHz
<b>Modulation type:</b>	Bluetooth LE4.2: GFSK
<b>Transmit Data Rate :</b>	Bluetooth LE4.2: 1 Mbps
<b>Number of Channels :</b>	Bluetooth LE4.2: 40 Channels
<b>Antenna Specification :</b>	PCB Antenna
<b>Antenna Specification:</b>	0 dBi

**Remark:**

- 1.The sample selected for test was engineering sample that approximated to production product and was provided by manufacturer.
- 2.This submittal(s) (test report) is intended for **FCC ID: 2AQUSMC1002** filing to comply with Section 15.207, 15.209 and 15.247 of the FCC Part 15, Subpart C Rules.
- 3.This submittal(s) (test report) is intended for **IC: 24188-MC1002** filing to comply with IC rules RSS-247 Issue2, RSS-Gen Issue5.

### 3 TEST METHODOLOGY

The tests documented in this report were performed in accordance with ANSI C63.10 and FCC CFR 47 2.1046, 2.1047, 2.1049, 2.1051, 2.1053, 2.1055, 2.1057, 15.207, 15.209, 15.247, KDB 558074 and IC rules RSS-247 Issue2, RSS-Gen Issue5.

#### 3.1 EUT CONFIGURATION

The EUT configuration for testing is installed on RF field strength measurement to meet the Commissions requirement and operating in a manner that intends to maximize its emission characteristics in a continuous normal application.

#### 3.2 EXERCISE EUT

The EUT was operated in the engineering mode to fix the TX frequency that was for the purpose of the measurements.

According to its specifications, the EUT must comply with the requirements of the Section 15.207, 15.209 and 15.247 under the FCC Rules Part 15 Subpart C.

#### 3.3 GENERAL TEST PROCEDURES

##### Conducted Emissions

The EUT is placed on the turntable, which is 0.8 m above ground plane. According to the requirements in Section 13.1.4.1 of ANSI C63.10 Conducted emissions from the EUT measured in the frequency range between 0.15 MHz and 30MHz using CISPR Quasi-peak and average detector modes.

##### Radiated Emissions

Under 1GHz

The EUT is placed on a turn table, which is 0.8 m above ground plane. The turntable shall rotate 360 degrees to determine the position of maximum emission level. EUT is set 3m away from the receiving antenna, which varied from 1m to 4m to find out the highest emission. And also, each emission was to be maximized by changing the polarization of receiving antenna both horizontal and vertical. In order to find out the maximum emissions, exploratory radiated emission measurements were made according to the requirements in Section 13.1.4.1 of ANSI C63.10.

Above 1GHz

The EUT is placed on a turn table, which is 1.5 m above ground plane. The turntable shall rotate 360 degrees to determine the position of maximum emission level. EUT is set 3m away from the receiving antenna, which varied from 1m to 4m to find out the highest emission. And also, each emission was to be maximized by changing the polarization of receiving antenna both horizontal and vertical. In order to find out the maximum emissions, exploratory radiated emission measurements were made according to the requirements in Section 13.1.4.1 of ANSI C63.10.

### 3.4 TEST MODE

Preliminary tests were performed in different data rate to find the worst radiated emission. The data rate shown in the table below is the worst-case rate with respect to the specific test item. Investigation has been done on all the possible configurations for searching the worst cases. The following table is a list of the test modes shown in this test report.

Test Items	Mode	Data Rate	Channel	Antenna
6dB Bandwidth	GFSK	1 Mbps	0/19/39	1
Peak Output Power	GFSK	1 Mbps	0/19/39	1
Power Spectral Density	GFSK	1 Mbps	0/19/39	1
Conducted Band Edges and Spurious Emission	GFSK	1 Mbps	0/19/39	1
Radiated Band Edges and Spurious Emission	GFSK	1 Mbps	0/19/39	1
AC Conducted Emission	CTX	-	-	-

Remark:

1. For radiated test cases below 1 GHz, the worst mode data rate channel 0 was reported only, because this data rate has the highest RF output power at preliminary tests.

### 3.5 RESTRICTED BANDS OF OPERATIONS

#### FCC PART 15.205 RESTRICTED BANDS OF OPERATIONS:

- (a) Except as shown in paragraph (d) of this section, only spurious emissions are permitted in any of the frequency bands listed below:

MHz	MHz	MHz	GHz
0.0900 - 0.1100	16.420 - 16.423	399.9 - 410.0	4.50 - 5.15
0.4950 - 0.505 <sup>(1)</sup>	16.69475 - 16.69525	608 - 614	5.35 - 5.46
2.1735 - 2.1905	16.80425 - 16.80475	960.0 - 1240	7.25 - 7.75
4.1250 - 4.1280	25.50 - 25.67	1300 - 1427	8.025 - 8.500
4.17725 - 4.17775	37.50 - 38.25	1435.0 - 1626.5	9.0 - 9.2
4.20725 - 4.20775	73.0 - 74.6	1645.5 - 1646.5	9.3 - 9.5
6.2150 - 6.2180	74.8 - 75.2	1660 - 1710	10.6 - 12.7
6.26775 - 6.26825	108.00 - 121.94	1718.8 - 1722.2	13.25 - 13.40
6.31175 - 6.31225	123 - 138	2200 - 2300	14.47 - 14.50
8.2910 - 8.2940	149.90 - 150.05	2310 - 2390	15.35 - 16.20
8.3620 - 8.3660	156.52475 - 156.52525	2483.5 - 2500.0	17.7 - 21.4
8.37625 - 8.38675	156.7 - 156.9	2655 - 2900	22.01 - 23.12
8.41425 - 8.41475	162.0125 - 167.1700	3260 - 3267	23.6 - 24.0
12.2900 - 12.2930	167.72 - 173.20	3332 - 3339	31.2 - 31.8
12.51975 - 12.52025	240 - 285	3345 - 3358	36.43 - 36.5 <sup>(2)</sup>
12.57675 - 12.57725	322.0 - 335.4	3600 - 4400	
13.3600 - 13.4100			

<sup>1</sup> Until February 1, 1999, this restricted band shall be 0.490-0.510 MHz.

<sup>2</sup> Above 38.6

- (b) Except as provided in paragraphs (d) and (e), the field strength of emissions appearing within these frequency bands shall not exceed the limits shown in Section 15.209. At frequencies equal to or less than 1000 MHz, compliance with the limits in Section 15.209 shall be demonstrated using measurement instrumentation employing a CISPR quasi-peak detector. Above 1000 MHz, compliance with the emission limits in Section 15.209 shall be demonstrated based on the average value of the measured emissions. The provisions in Section 15.35 apply to these measurements.



**RSS-Gen RESTRICTED BANDS OF OPERATIONS**

Except as shown RSS-Gen 8.10, only spurious emissions are permitted in any of the frequency bands listed below:

MHz	MHz	GHz
0.090 - 0.110	156.7 - 156.9	9.0 - 9.2
0.495 - 0.505	162.0125 - 167.17	9.3 - 9.5
2.1735 - 2.1905	167.72 - 173.2	10.6 - 12.7
3.020 - 3.026	240 - 285	13.25 - 13.4
4.125 - 4.128	322 - 335.4	14.47 - 14.5
4.17725 - 4.17775	399.9 - 410	15.35 - 16.2
4.20725 - 4.20775	608 - 614	17.7 - 21.4
5.677 - 5.683	960 - 1427	22.01 - 23.12
6.215 - 6.218	1435 - 1626.5	23.6 - 24.0
6.26775 - 6.26825	1645.5 - 1646.5	31.2 - 31.8
6.31175 - 6.31225	1660 - 1710	36.43 - 36.5
8.291 - 8.294	1718.8 - 1722.2	Above 38.6
8.362 - 8.366	2200 - 2300	
8.37625 - 8.38675	2310 - 2390	
8.41425 - 8.41475	2483.5 - 2500	
12.29 - 12.293	2655 - 2900	
12.51975 - 12.52025	3260 - 3267	
12.57675 - 12.57725	3332 - 3339	
13.36 - 13.41	3345.8 - 3358	
16.42 - 16.423	3500 - 4400	
16.69475 - 16.69525	4500 - 5150	
16.80425 - 16.80475	5350 - 5460	
25.5 - 25.67	7250 - 7750	
37.5 - 38.25	8025 - 8500	
73 - 74.6	4500 - 5150	
74.8 - 75.2	5350 - 5460	
108 - 138	7250 - 7750	
149.9 - 150.05	8025 - 8500	
156.52475 - 156.52525		

\* Certain frequency bands listed in table 7 and in bands above 38.6 GHz are designated for licence-exempt applications. These frequency bands and the requirements that apply to related devices are set out in the 200 and 300 series of RSSs.



## 4 INSTRUMENT CALIBRATION

The measuring equipment, which was utilized in performing the tests documented herein, has been calibrated in accordance with the manufacturer's recommendations for utilizing calibration equipment, which is traceable to recognized national standards. facilities and accreditations

## 5 FACILITIES AND ACCREDITATIONS

### 5.1 FACILTIES

All measurement facilities used to collect the measurement data are located at CCS China Kunshan Lab at 10#Weiye Rd, Innovation Park Eco. & Tec. Development Zone Kunshan city JiangSu, (215300), CHINA.

The sites are constructed in conformance with the requirements of ANSI C63.4 and CISPR Publication 22.

### 5.2 EQUIPMENT

Radiated emissions are measured with one or more of the following types of linearly polarized antennas: tuned dipole, biconical, log periodic, bi-log, and/or ridged waveguide, horn. Spectrum analyzers with pre-selectors and quasi-peak detectors are used to perform radiated measurements.

Conducted emissions are measured with Line Impedance Stabilization Networks and EMI Test Receivers.

Calibrated wideband preamplifiers, coaxial cables, and coaxial attenuators are also used for making measurements.

All receiving equipment conforms to CISPR Publication 16-1, "Radio Interference Measuring Apparatus and Measurement Methods."

### 5.3 LABORATORY ACCREDITATIONS AND LISTING

FCC –Designation Number: CN1172.

Compliance Certification Services Inc. Kun shan Laboratory has been registered and fully described in a report filed with the (FCC) Federal Communications Commission. The acceptance letter from the FCC is maintained in our files and the Designation Number: CN1172.

The test facilities are listed with Industry Canada, Laboratory Division, 2324E-1 for 10m chamber, 2324E-2 for 3m chamber.

## 5.4 TABLE OF ACCREDITATIONS

Our laboratories are accredited and approved by the following accreditation body according to ISO/IEC 17025.

<b>Taiwan</b>	TAF
<b>USA</b>	A2LA

The measuring facility of laboratories has been authorized or registered by the following approval agencies.

<b>Canada</b>	Industry Canada
<b>Japan</b>	VCCI
<b>Taiwan</b>	BSMI
<b>USA</b>	FCC

Copies of granted accreditation certificates are available for downloading from our web site, <http://www.ccsrf.com>

## 5.5 LIST OF MEASURING EQUIPMENT

Conducted Emissions Test Site					
Name of Equipment	Manufacturer	Model	Serial Number	Calibration Data	Calibration Due
Spectrum Analyzer	Agilent	E4446A	MY44020154	2017-9-4	2018-9-3
Spectrum Analyzer	RS	FSU26	200789	2018-7-13	2019-7-12
Power meter	Anritsu	ML2495A	1445010	2018-4-26	2019-4-25
Power sensor	Anritsu	MA2411B	1339220	2018-4-26	2019-4-25
Power SPLITTER	Mini-Circuits	ZN2PD-9G	SF078500430	N.C.R	N.C.R
DC Power Supply	AGILENT	E3632A	MY50340053	N.C.R	N.C.R
Cable	N/A	Cable-05	N/A	2018-4-24	2019-4-23
6dB Attenuator	N/A	N/A	N/A	2018-4-24	2019-4-23
Temp. / Humidity Gauge	Anymetre	TH603	CCS007	2017-10-24	2018-10-23
Test Software			EZ-EMC		

Conducted Emission					
Name of Equipment	Manufacturer	Model	Serial Number	Calibration Data	Calibration Due
EMI TEST RECEIVER	R&S	ESCI	100781	2018-2-26	2019-2-25
V (V-LISN)	SCHWARZBECK	NNLK 8129	8129-143	2017-10-29	2018-10-28
TWO-LINE V-NETWORK	R&S	ENV216	101604	2017-10-29	2018-10-28
Pulse LIMITER	R&S	ESH3-Z2	100524	2017-12-27	2018-12-26
Cable	Thermax	Cable-02	14	2017-12-27	2018-12-26
Test Software			EZ-EMC		

977 Chamber					
Name of Equipment	Manufacturer	Model	Serial Number	Calibration Data	Calibration Due
Spectrum Analyzer	Agilent	E4446A	MY44020154	2017-9-4	2018-9-3
Spectrum Analyzer	RS	FSU26	200789	2018-7-13	2019-7-12
EMI Test Receiver	R&S	ESCI	101378	2017-12-27	2018-12-26
Amplifier	COM-POWER	PAM-840A	461332	2017-11-29	2018-11-28
Amplifier	COM-POWER	PAM-118A	551044	2018-4-26	2019-4-25
Broad-Band Horn Antenna	SCHWARZBECK	BBHA 9170	9170-515	2018-2-27	2019-2-26
Bilog Antenna	Teseq	CBL6112D	35403	2017-11-5	2018-11-4
Loop Antenna	COM-POWER	AL-130R	10160008	2018-5-8	2019-5-7
Horn-antenna	SCHWARZBECK	9120D	D:266	2018-2-26	2019-2-25
Horn-antenna	SCHWARZBECK	9120D	D:267	2017-11-5	2018-11-4
Turn Table	CT	CT123	4165	N.C.R	N.C.R
Antenna Tower	CT	CTERG23	3256	N.C.R	N.C.R
Controller	CT	CT100	95637	N.C.R	N.C.R
Cable	REBES MICROWAVE	Cable-93	N/A	2017-10-29	2018-10-28
Cable	REBES MICROWAVE	Cable-94	N/A	2017-10-29	2018-10-28
Cable	REBES MICROWAVE	Cable-95	N/A	2017-10-29	2018-10-28
Cable	N/A	Cable-03	N/A	2018-4-24	2019-4-23
Cable	N/A	Cable-04	N/A	2018-4-24	2019-4-23
2.4G Filter	N/A	N/A	N/A	2018-4-24	2019-4-23
Test Software			EZ-EMC		

**Remark:** Each piece of equipment is scheduled for calibration once a year.

## 5.6 MEASUREMENT UNCERTAINTY

For the test methods, according to the present document, the measurement uncertainty figures shall be calculated in accordance with TR 100 028-1 [2] and shall correspond to an expansion factor (coverage factor)  $k = 1,96$  or  $k = 2$  (which provide confidence levels of respectively 95 % and 95,45 % in the case where the distributions characterizing the actual measurement uncertainties are normal (Gaussian)). Table 6 is based on such expansion factors.

**Table 6: Maximum measurement uncertainty**

Parameter	Uncertainty
RF output power, conducted	$\pm 1.129\text{dB}$
Unwanted Emissions, conducted	$\pm 2.406\text{dB}$
RF Power density, conducted	$\pm 2.379\text{dB}$
Conducted emissions	$\pm 2.582\text{dB}$
All emissions, radiated (Below 1GHz)	$\pm 4.725\text{dB}$
All emissions, radiated (Above 1GHz)	$\pm 4.818\text{dB}$
Temperature	$\pm 0.3\text{dB}$
Supply voltages	$\pm 0.2\%$

## 5.7 SETUP CONFIGURATION

See test photographs attached in Appendix 1 for the actual connections between EUT and support equipment.

## 5.8 SUPPORT EQUIPMENT

No.	Equipment	Brand	Model	Series No.	FCC ID
1	N/A	N/A	N/A	N/A	N/A



## 6 FCC PART 15.247 & RSS-247 REQUIREMENTS

### 6.1 Maximum conducted output power

#### Limit

1). According to FCC part 15.247, the maximum peak output power of the intentional radiator shall not exceed the following:

For systems using digital modulation in the 2400-2483.5MHz, the limit for peak output power is 30dBm. If transmitting antenna of directional gain greater than 6dBi is used, the peak output power from the intentional radiator shall be reduced below the above stated value by the amount in dB that the directional gain of the antenna exceeds 6 dBi. In case of point-to-point operation, the limit has to be reduced by 1dB for every 3dB that the directional gain of the antenna exceeds 6dBi.

2). According to RSS-247 section 5.4, For DTSSs employing digital modulation techniques operating in the bands 902-928 MHz and 2400-2483.5 MHz, the maximum peak conducted output power shall not exceed 1W. The e.i.r.p. shall not exceed 4 W, except as provided in section 5.4(e)

#### Test Configuration

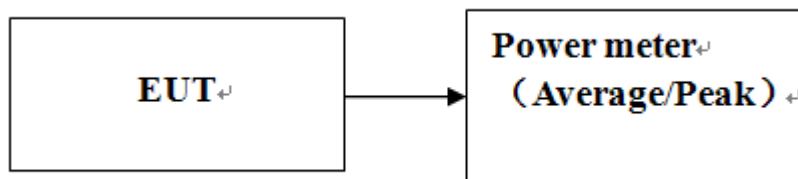

**Remark:** Each piece of equipment is scheduled for calibration once a year.

#### Test Procedure

1. The testing follows the Measurement Procedure of FCC KDB No. 558074 DTS D01 Meas. Guidance v04.
2. The RF output of EUT was connected to the power meter by RF cable and attenuator. The path loss was compensated to the results for each measurement.
3. Set to the maximum power setting and enable the EUT transmit continuously.
4. Measure the conducted output power and record the results in the test report.

**Test RESULTS**

*No non-compliance noted*

**BLE4.1 GFSK Modulation 1Mbps mode**

<b>Test mode:</b>	Bluetooth LE4.2	<b>Temperature:</b>	23°C
<b>Test By:</b>	Lily.Wang	<b>Test Date:</b>	2018-8-23

Channel	Frequency (MHz)	Peak Output Power (dBm)	Limit (dBm)	e.i.r.p. (dBm)	Limit (dBm)
Low	2402	-1.23	30.00	-1.23	36.00
Mid	2440	-1.55	30.00	-1.55	36.00
High	2480	-2.10	30.00	-2.10	36.00

Channel	Frequency (MHz)	Average Output Power (dBm)	e.i.r.p. (dBm)
Low	2402	-1.33	-1.33
Mid	2440	-1.63	-1.63
High	2480	-2.18	-2.18

**Note:**Duty factor has been offsetted with cableloss

## 6.2 PEAK POWER SPECTRAL DENSITY

### Limit

- 1). According to FCC part 15.247, the peak power spectral density shall not be greater than 8dBm in any 3kHz band at any time interval of continuous transmission.
- 2). According to RSS-247 section 5.2, The transmitter power spectral density conducted from the transmitter to the antenna shall not be greater than 8dBm in any 3kHz band during any time interval of continuous transmission.

### Test Configuration

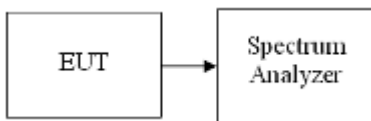

### Test Procedure

1. Place the EUT on the table and set it in transmitting mode. Remove the antenna from the EUT and then connect a low loss RF cable from the antenna port to the spectrum analyzer.
2. Set the spectrum analyzer as RBW = 3 kHz, VBW = 10 kHz, Span = 1.5 times the DTS bandwidth, Sweep = auto
3. Record the max reading.
4. Repeat the above procedure until the measurements for all frequencies are completed.

### Test Results of power Spectral Density

Test mode:	Bluetooth LE4.2	Temperature:	23°C
Test By:	Lily.Wang	Test Date:	2018-8-23

Channel	Frequency (MHz)	PSD/3kHz (dBm)	Limit (dBm)	Result
00	2402	-11.41	8	PASS
19	2440	-10.96		PASS
39	2480	-10.69		PASS

### Test Plot of power Spectral Density

#### Channel 00

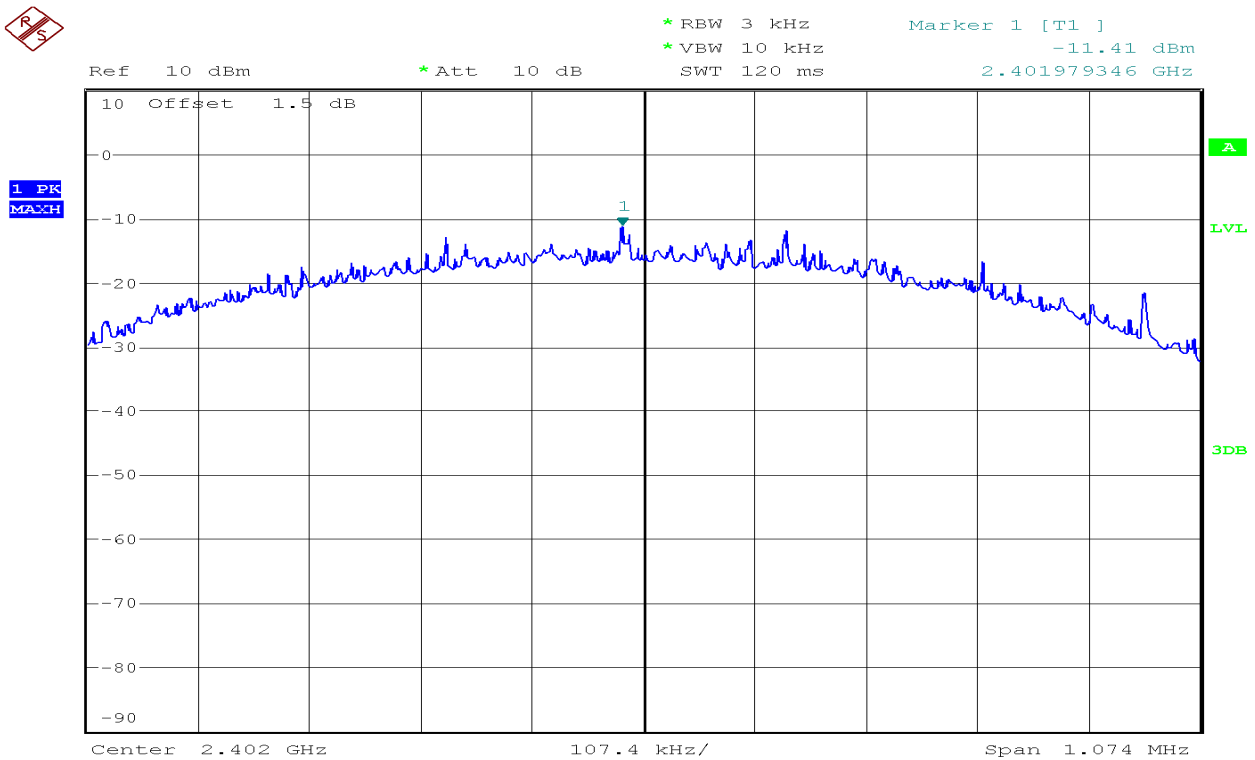

## Channel 19



Ref 10 dBm      \*Att 10 dB      \*RBW 3 kHz      Marker 1 [T1]      -10.96 dBm  
 \*VBW 10 kHz      2.439979058 GHz  
 SWT 125 ms

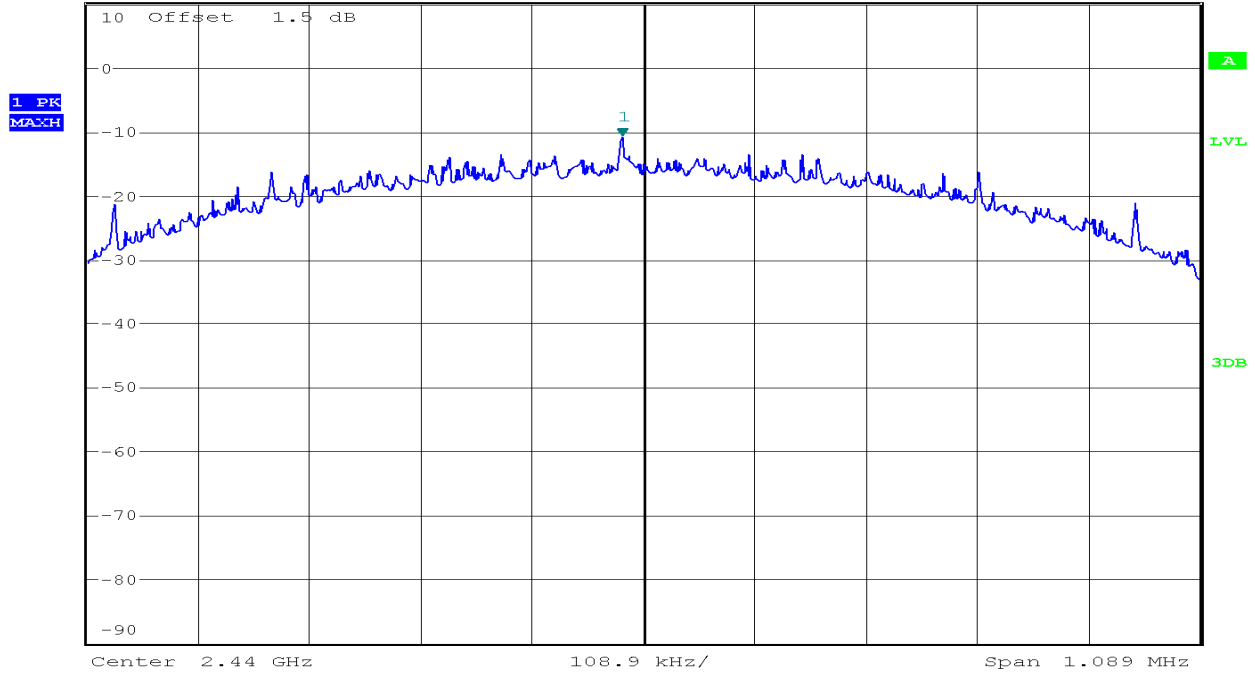

## Channel 39



Ref 10 dBm      \*Att 10 dB      \*RBW 3 kHz      Marker 1 [T1]      -10.69 dBm  
 \*VBW 10 kHz      2.479985769 GHz  
 SWT 125 ms

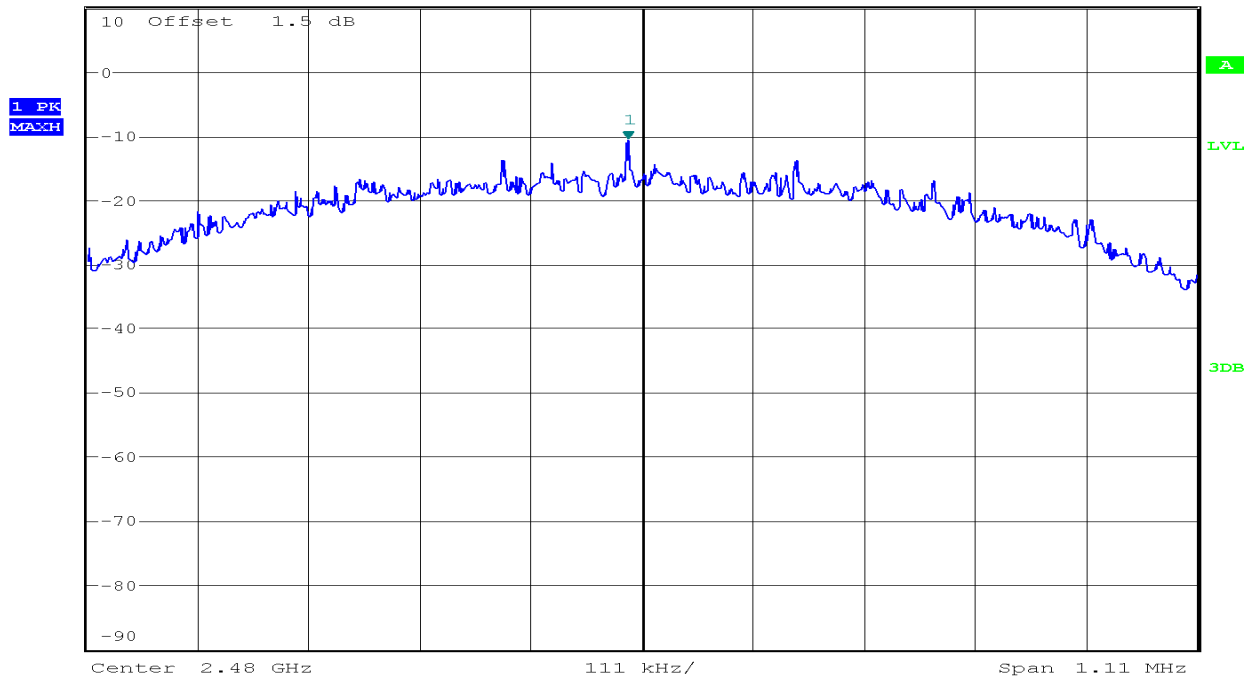

## 6.3 6dB Bandwidth Measurement

### Limit

- 1).According to FCC part 15.247,The minimum 6 dB bandwidth shall be at least 500 kHz.
- 2).According to RSS-247 section 5.2, DTSS include systems that employ digital modulation techniques resulting in spectral characteristics similar to direct sequence systems. The following applies to the bands 902-928 MHz and 2400-2483.5 MHz: The minimum 6 dB bandwidth shall be 500 kHz

### Test Configuration

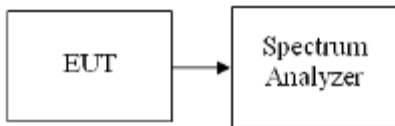

### Test Procedure

1. The RF output of EUT was connected to the spectrum analyzer by RF cable and attenuator. The path loss was compensated to the results for each measurement.
2. Set to the maximum power setting and enable the EUT transmit continuously.
3. Make the measurement with the spectrum analyzer's resolution bandwidth (RBW) = 100 kHz. Set the Video bandwidth (VBW) = 300 kHz. In order to make an accurate measurement. The 6 dB bandwidth must be greater than 500 kHz.
4. Measure and record the results in the test report.

## Test Results of Bandwidth

No non-compliance noted

Test mode:	Bluetooth LE4.2	Temperature:	23°C
Test By:	Lily.Wang	Test Date:	2018-8-23

Channel	Frequency (MHz)	6dB Bandwidth (MHz)	6dB Bandwidth Limit (MHz)	Result
00	2402	0.716	0.5	Pass
19	2440	0.726	0.5	Pass
39	2480	0.740	0.5	Pass

## Test Plot

### Channel 00

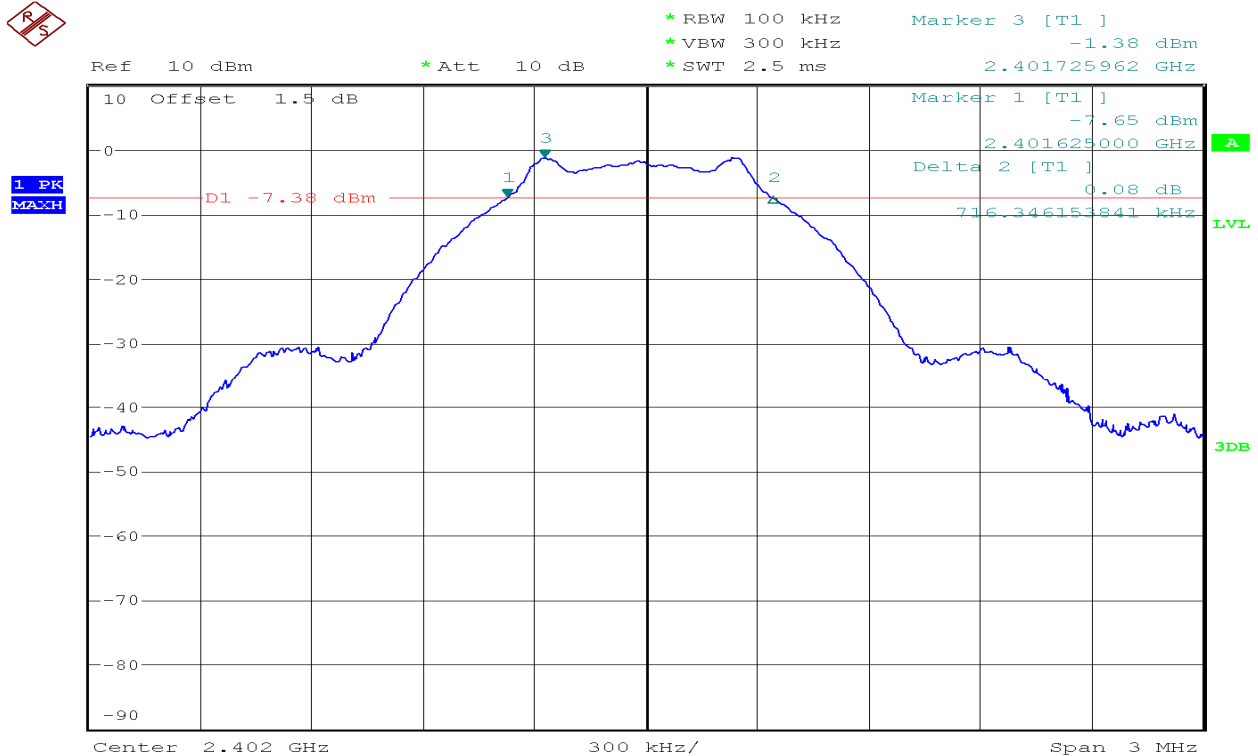

## Channel 19



1 PK  
MATCH

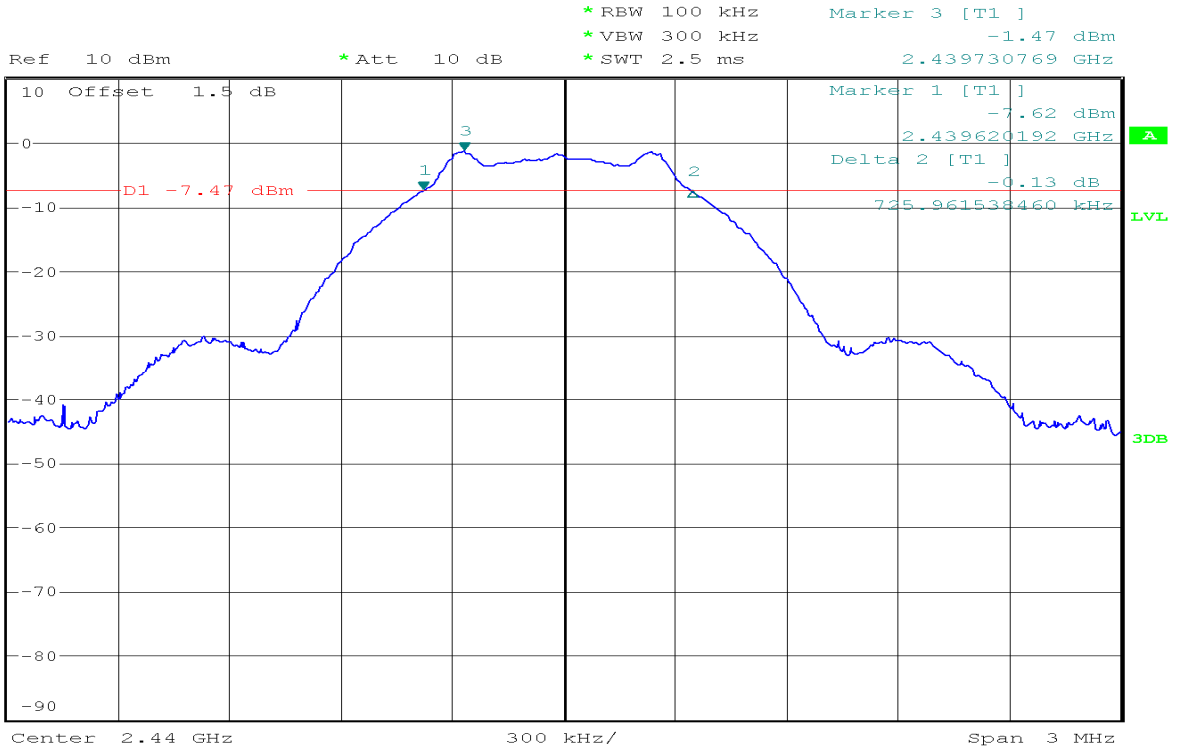

## Channel 39



1 PK  
MATCH

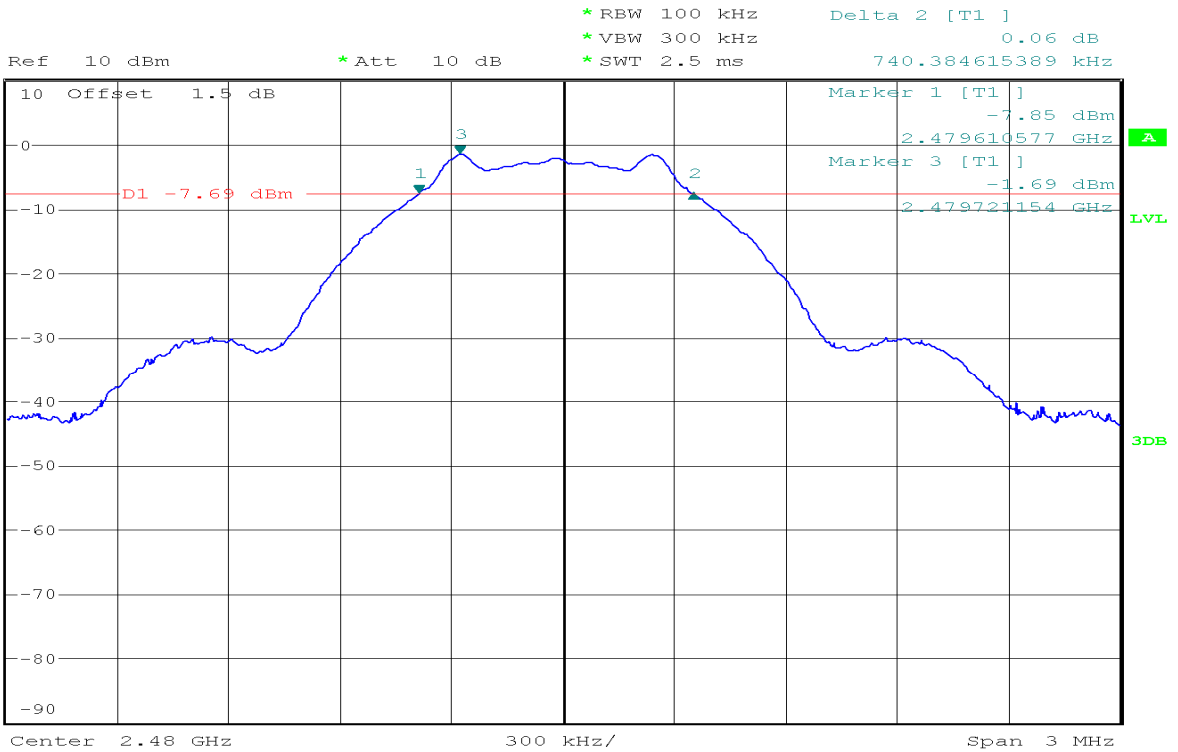



## 6.4 99% Bandwidth Measurement

### LIMIT

None; for reporting purposes only  
RSS-Gen 6.6

### Test Configuration

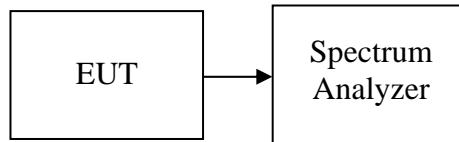

### TEST PROCEDURE

The transmitter output is connected to the spectrum analyzer. The RBW shall be in the range of 1% to 5% of the occupied bandwidth and VBW shall be approximately 3x RBW. The sweep time is coupled. The spectrum analyzer internal 99% bandwidth function is utilized.

## TEST RESULTS

No non-compliance noted

### Test Data

Test mode:	Bluetooth LE4.2	Temperature:	23°C
Test By:	Lily.Wang	Test Date:	2018-8-23

Channel	Frequency (MHz)	99% Bandwidth (MHz)
00	2402	1.024
19	2440	1.024
39	2480	1.029

### Test Plot

#### Channel 00

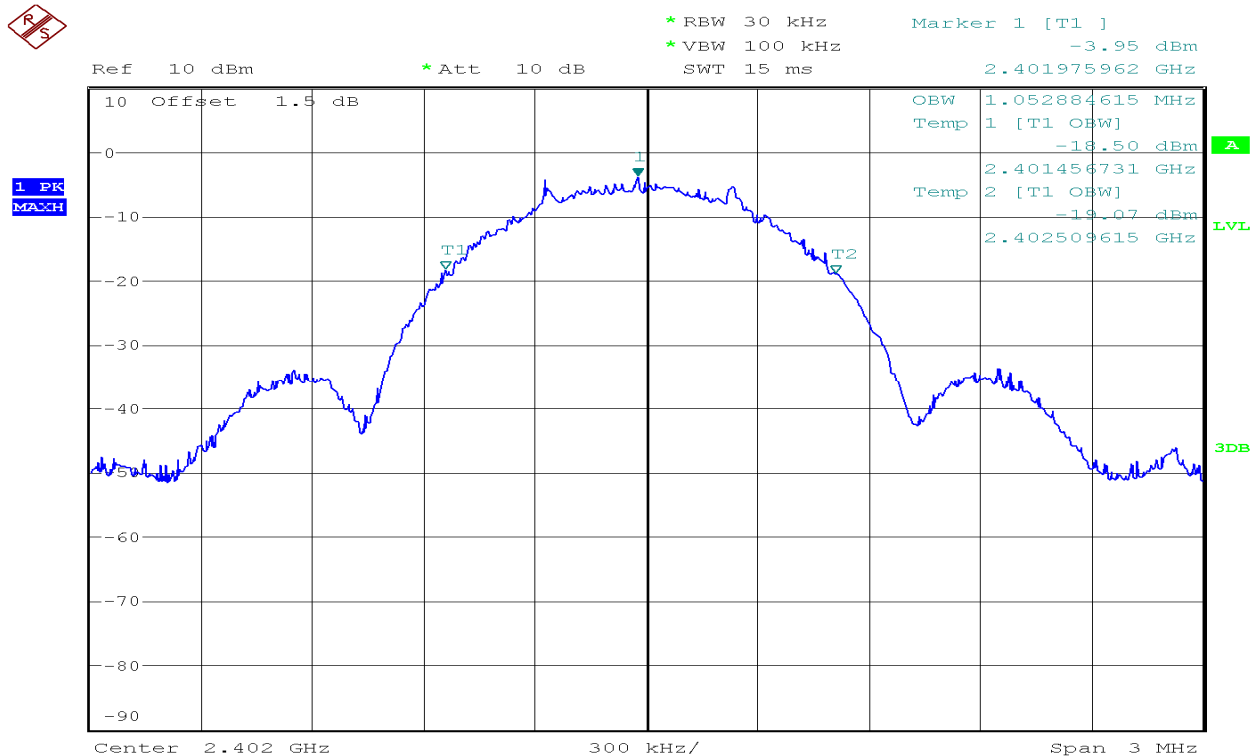

### Channel 19



Ref 10 dBm      \*Att 10 dB      \*RBW 30 kHz      Marker 1 [T1]      -4.04 dBm  
 \*VBW 100 kHz      SWT 15 ms      2.439985577 GHz

1 PK  
 MATCH

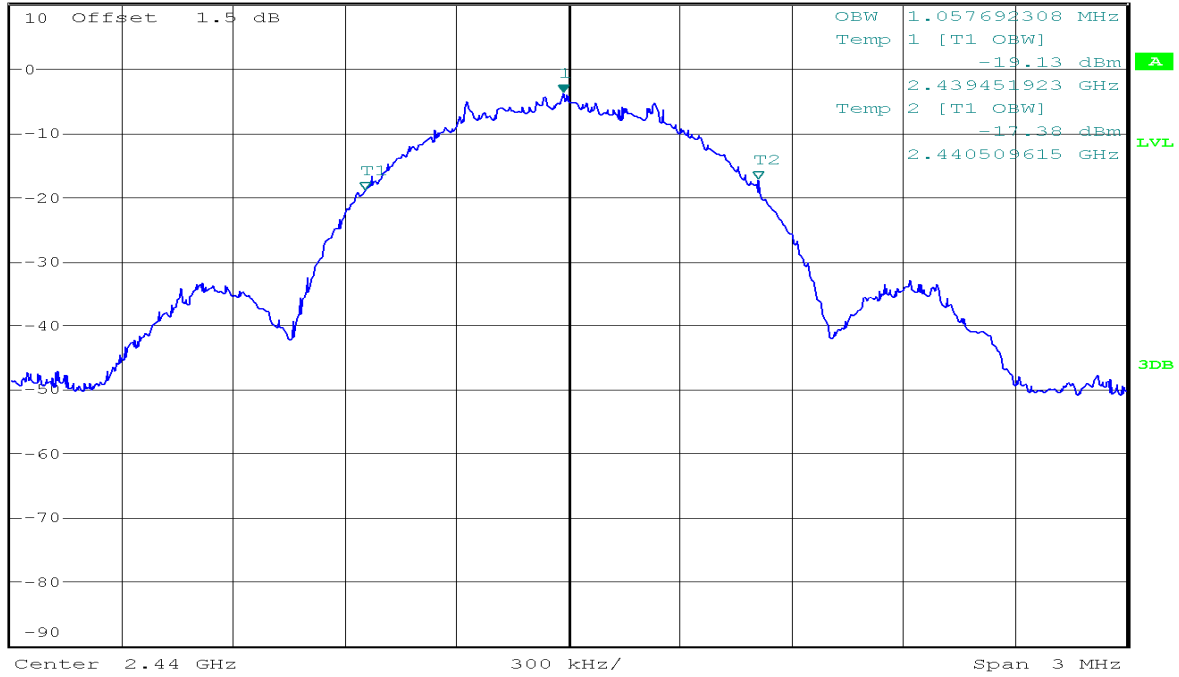

### Channel 39



Ref 10 dBm      \*Att 10 dB      \*RBW 30 kHz      Marker 1 [T1]      -4.06 dBm  
 \*VBW 100 kHz      SWT 15 ms      2.479966346 GHz

1 PK  
 MATCH

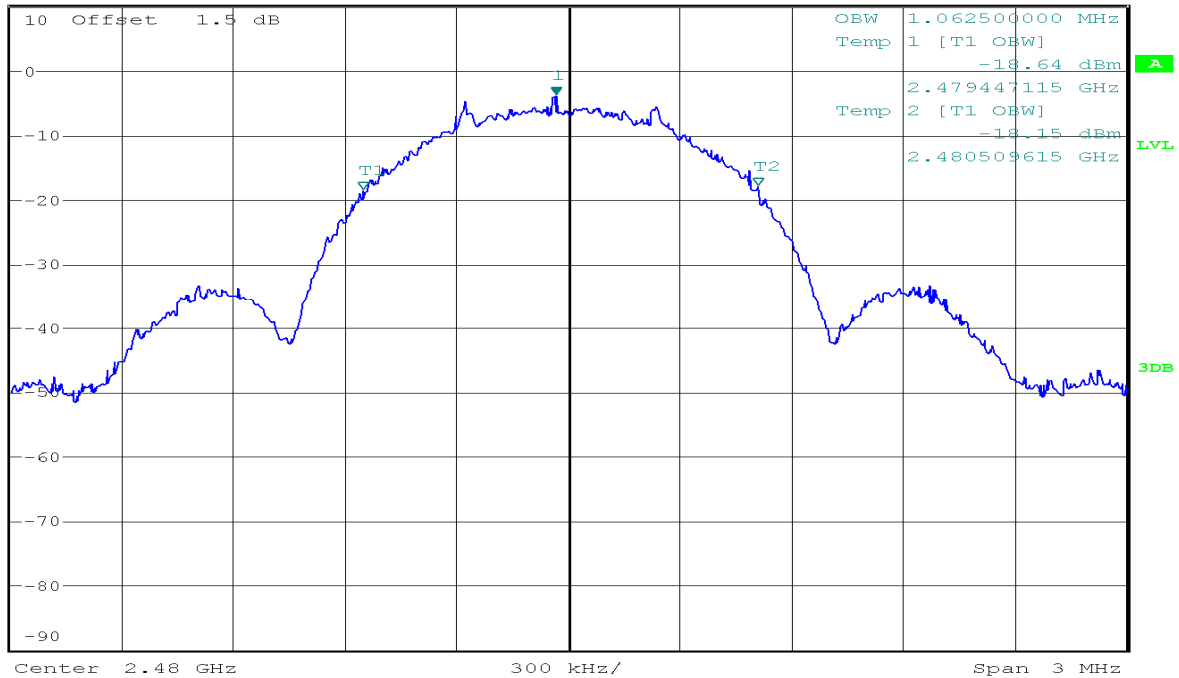

## 6.5 Conducted Band Edges and Spurious Emission Measurement

### LIMIT

1). According to §15.247(d), in any 100kHz bandwidth outside the frequency bands in which the spread spectrum intentional radiator is operating, the radio frequency power that is produced by the intentional radiator shall be at least 20 dB below that in the 100kHz bandwidth within the band that contains the highest level of the desired power, based on either an RF conducted or a radiated measurement, provided the transmitter demonstrates compliance with the peak conducted power limits. In addition, radiated emissions which fall in the restricted bands, as defined in §15.205(a), must also comply with the radiated emission limits specified in 15.209(a) (see Section 15.205(c)).

2). According to RSS-247 section 5.5, In any 100kHz bandwidth outside the frequency band in which the spread spectrum or digitally modulated device is operating, the RF power that is produced shall be at least 20 dB below that in the 100kHz bandwidth within the band that contains the highest level of the desired power, based on either an RF conducted or a radiated measurement, provided that the transmitter demonstrates compliance with the peak conducted power limits. If the transmitter complies with the conducted power limits based on the use of root-mean-square averaging over a time interval, as permitted under section 5.4(d), the attenuation required shall be 30 dB instead of 20dB. Attenuation below the general field strength limits specified in RSS-Gen is not required.

### Test Configuration

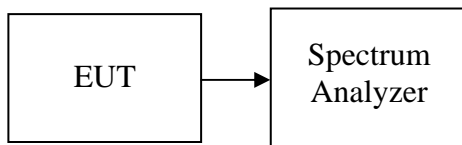

### TEST PROCEDURE

Conducted RF measurements of the transmitter output were made to confirm that the EUT antenna port conducted emissions meet the specified limit and to identify any spurious signals that require further investigation or measurements on the radiated emissions site.

The transmitter output is connected to the spectrum analyzer. The resolution bandwidth is set to 100 kHz. The video bandwidth is set to 300 kHz.

Measurements are made over the 30MHz to 40GHz range with the transmitter set to the lowest, middle, and highest channels.

### TEST RESULTSD

*No non-compliance noted*

## Test Plot OUT-OF-BAND SPURIOUS EMISSIONS-CONDUCTED MEASUREMENT

CH Low



Ref 10 dBm      \*Att 10 dB      \*RBW 100 kHz      Marker 1 [T1]      -1.25 dBm  
 \*VBW 300 kHz      2.402228913 GHz  
 SWT 2.5 ms

1 PK  
 MACH

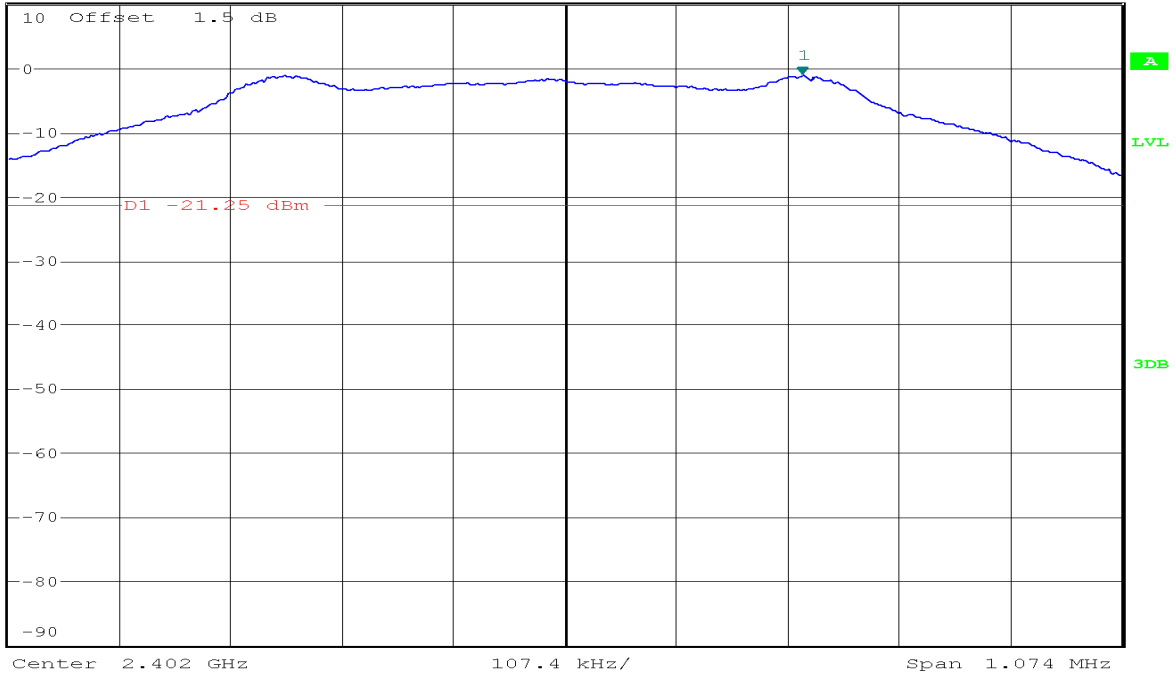

Ref 10 dBm      \*Att 10 dB      \*RBW 100 kHz      Marker 1 [T1]      -48.06 dBm  
 \*VBW 300 kHz      2.400000000 GHz  
 SWT 15 ms

1 PK  
 MACH

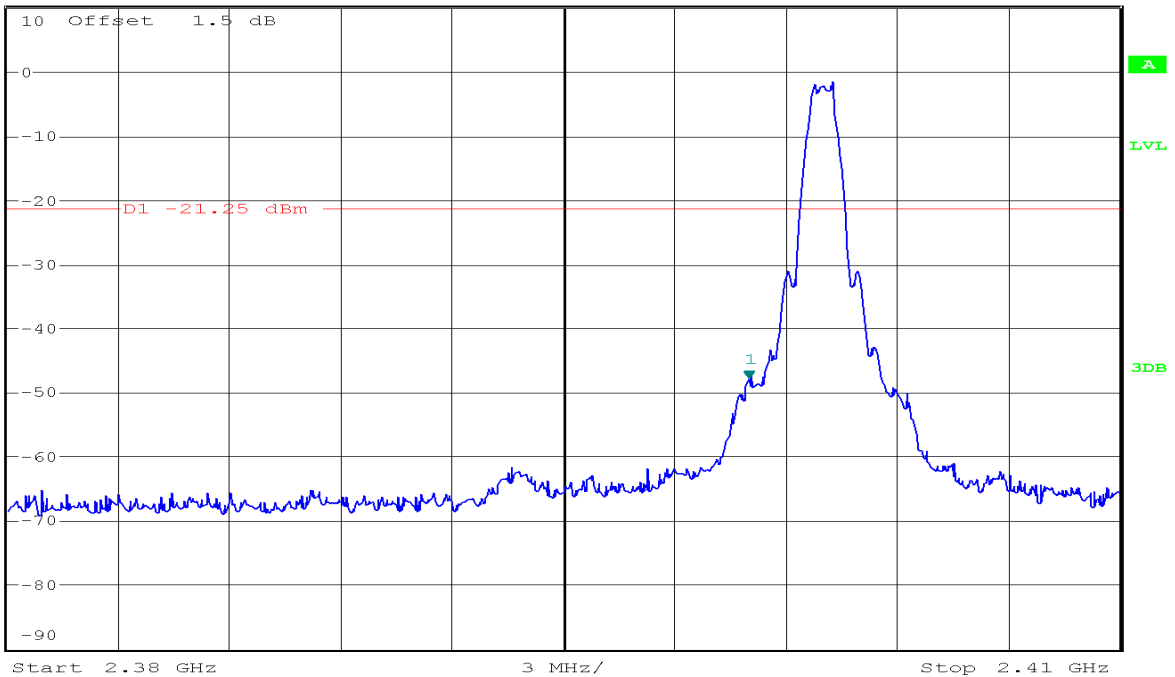



Ref 10 dBm \*Att 10 dB \*RBW 100 kHz Marker 4 [T1 ]  
 \*VBW 300 kHz -44.22 dBm  
 SWT 300 ms 1.895769231 GHz

1 PK  
 MATCH

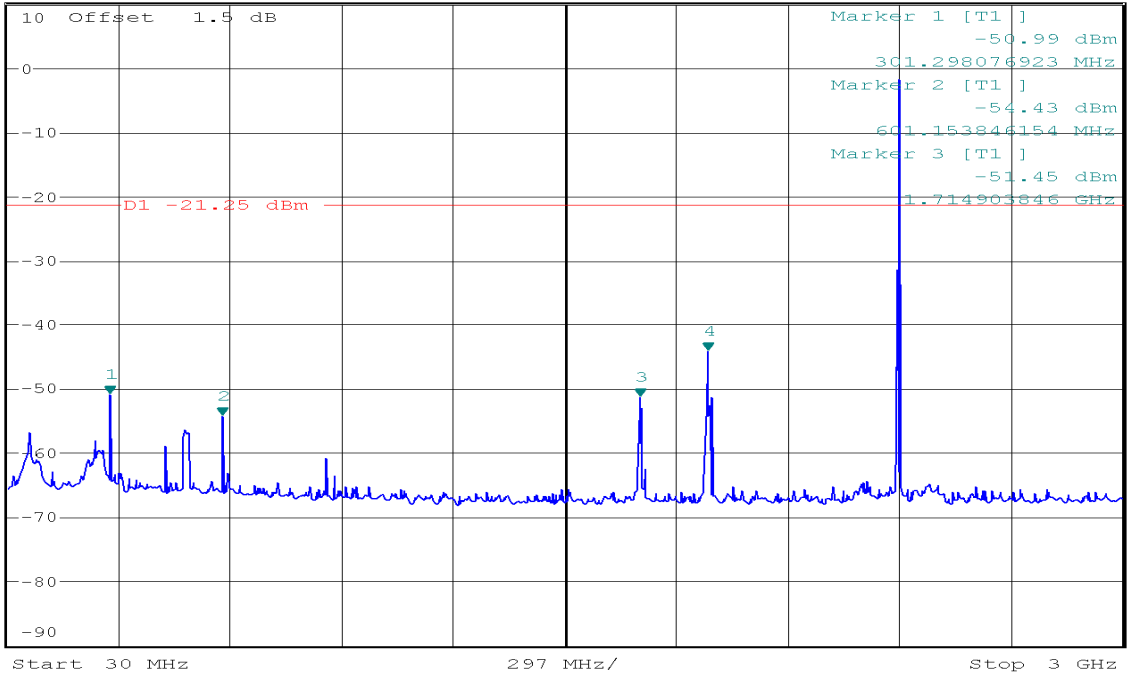

Ref 10 dBm \*Att 10 dB \*RBW 100 kHz Marker 4 [T1 ]  
 \*VBW 300 kHz -55.55 dBm  
 SWT 2.3 s 11.988782051 GHz

1 PK  
 MATCH

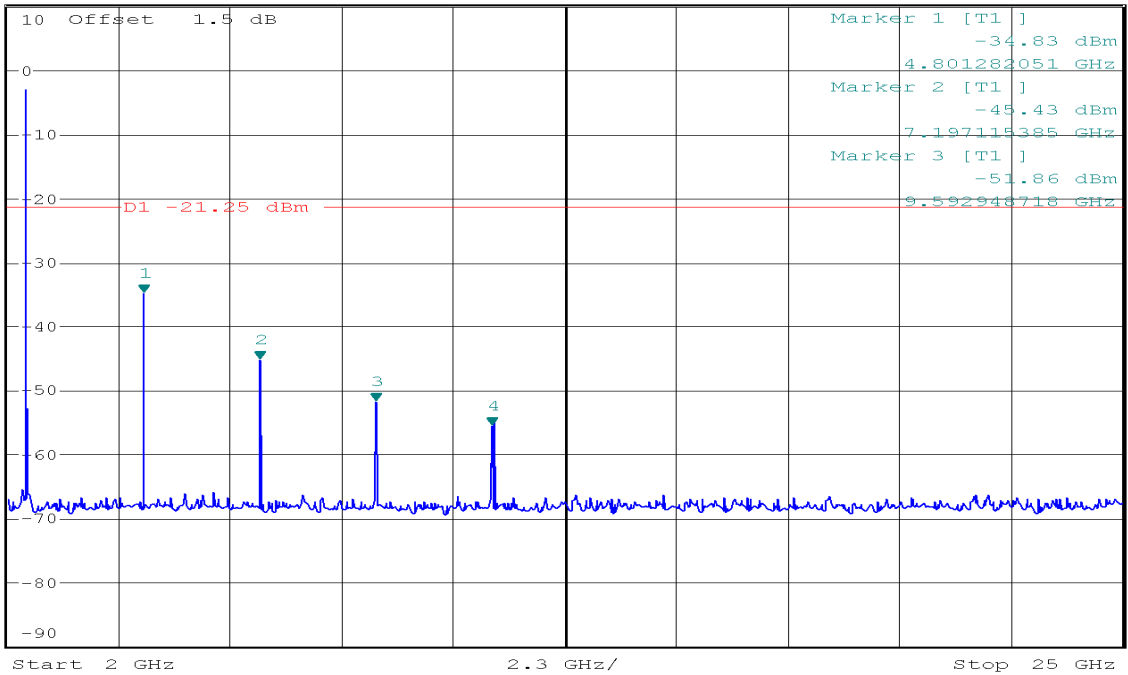

## CH Mid



Ref 10 dBm      \*Att 10 dB      \*RBW 100 kHz      Marker 1 [T1]      -1.34 dBm  
 \*VBW 300 kHz      2.439724260 GHz  
 SWT 2.5 ms

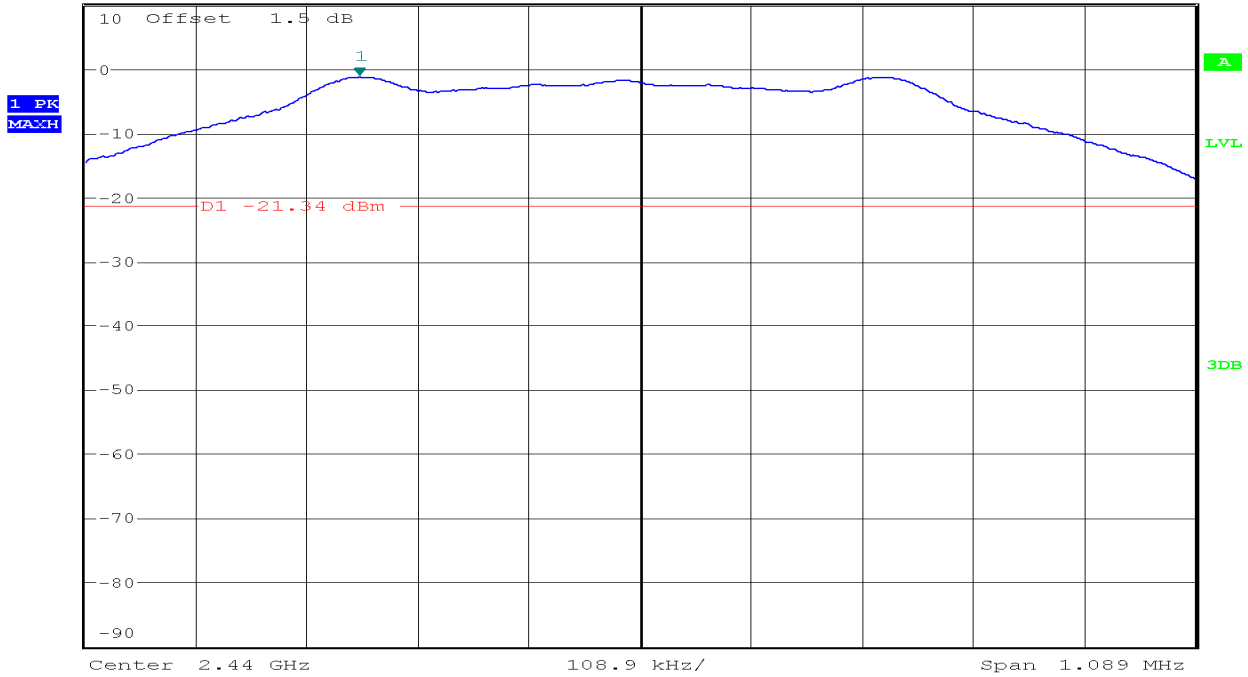

Ref 10 dBm      \*Att 10 dB      \*RBW 100 kHz      Marker 2 [T1]      -54.45 dBm  
 \*VBW 300 kHz      610.673076923 MHz  
 SWT 300 ms

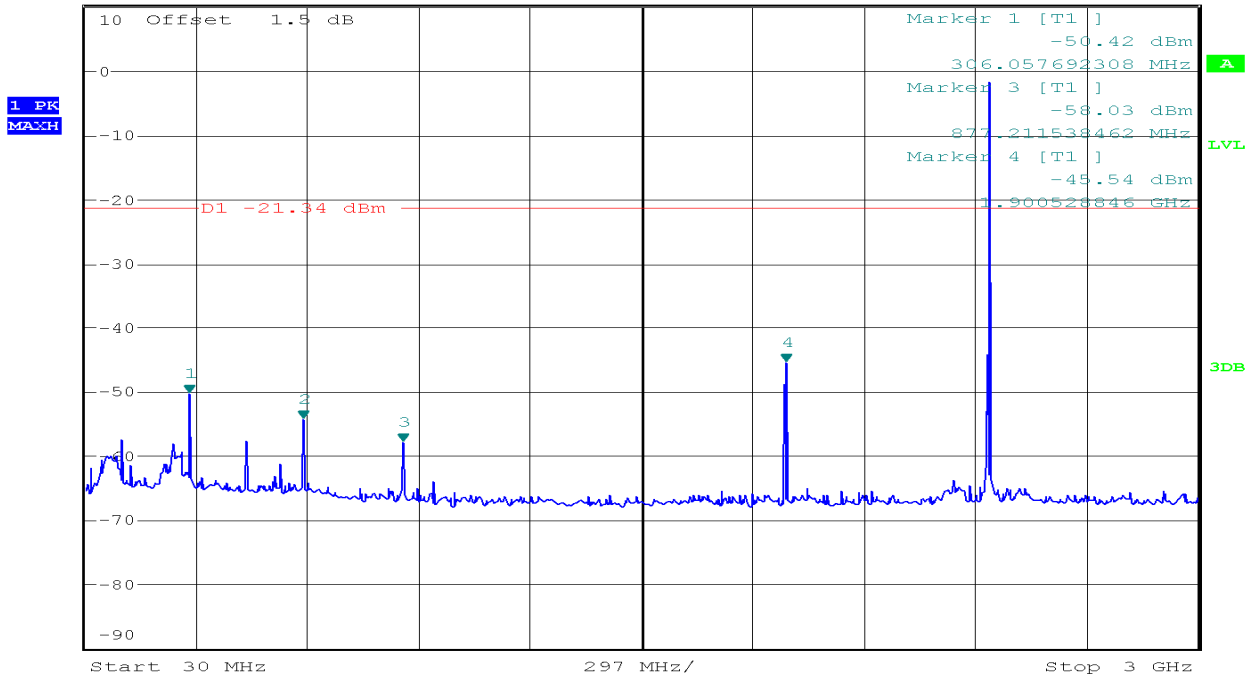



Ref 10 dBm      \*Att 10 dB      \*RBW 100 kHz      Marker 4 [T1]      -49.54 dBm  
 \*VBW 300 kHz      SWT 2.3 s      12.209935897 GHz

1 PK  
 MAXH

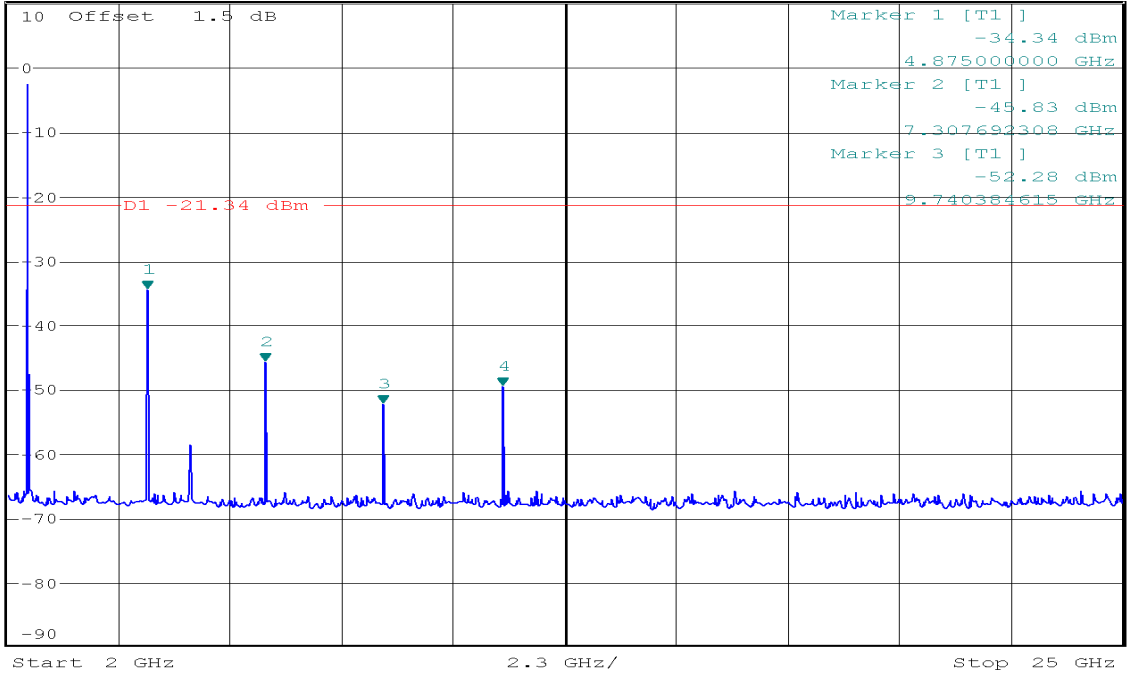

## CH High



Ref 10 dBm      \*Att 10 dB      \*RBW 100 kHz      Marker 1 [T1]      -1.64 dBm  
 \*VBW 300 kHz      SWT 2.5 ms      2.480240144 GHz

1 PK  
 MAXH

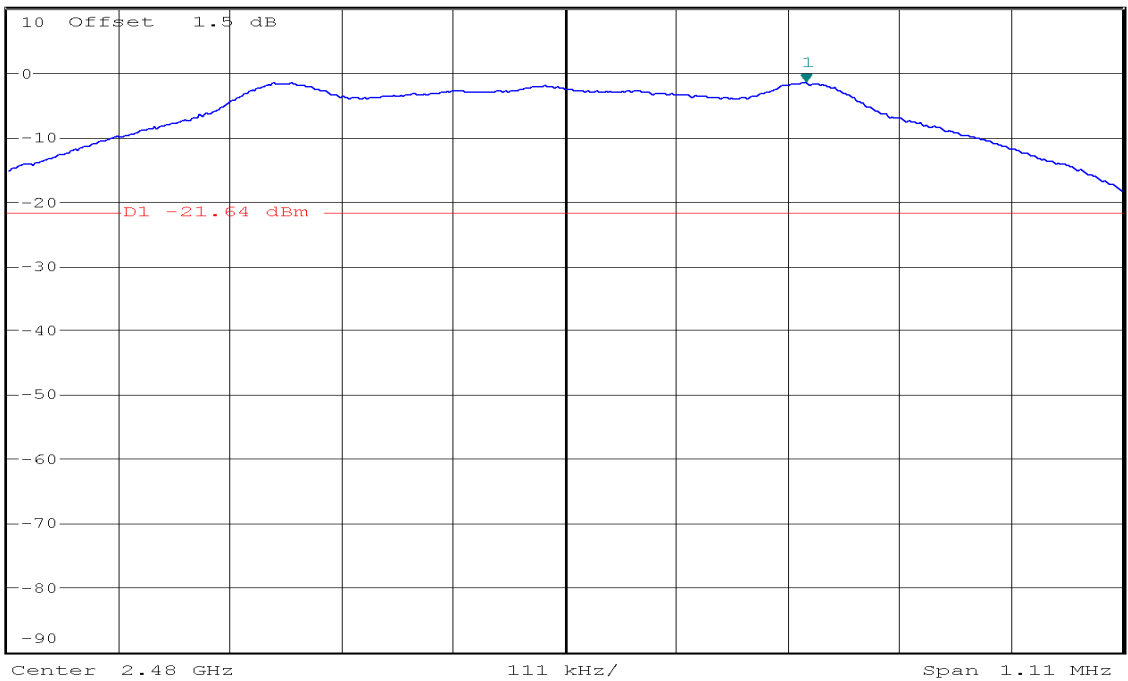





\*RBW 100 kHz      Marker 1 [T1 ]  
 \*VBW 300 kHz      -59.98 dBm  
 \*Att 10 dB      SWT 15 ms      2.483500000 GHz

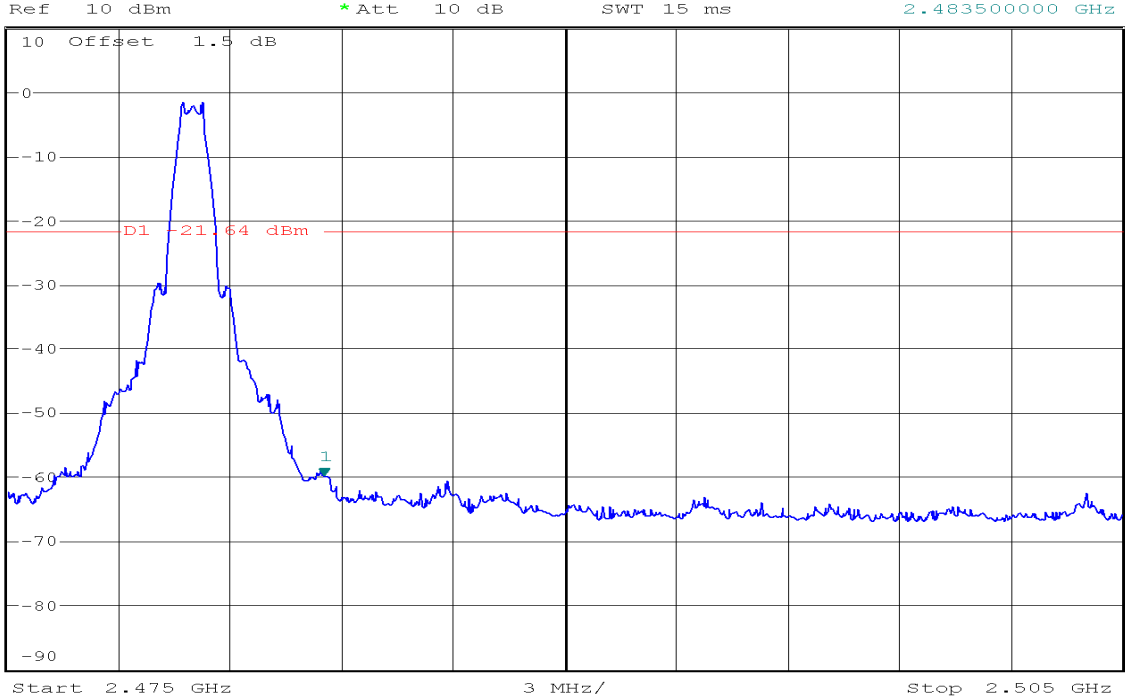

\*RBW 100 kHz      Marker 4 [T1 ]  
 \*VBW 300 kHz      -51.21 dBm  
 \*Att 10 dB      SWT 300 ms      1.900528846 GHz

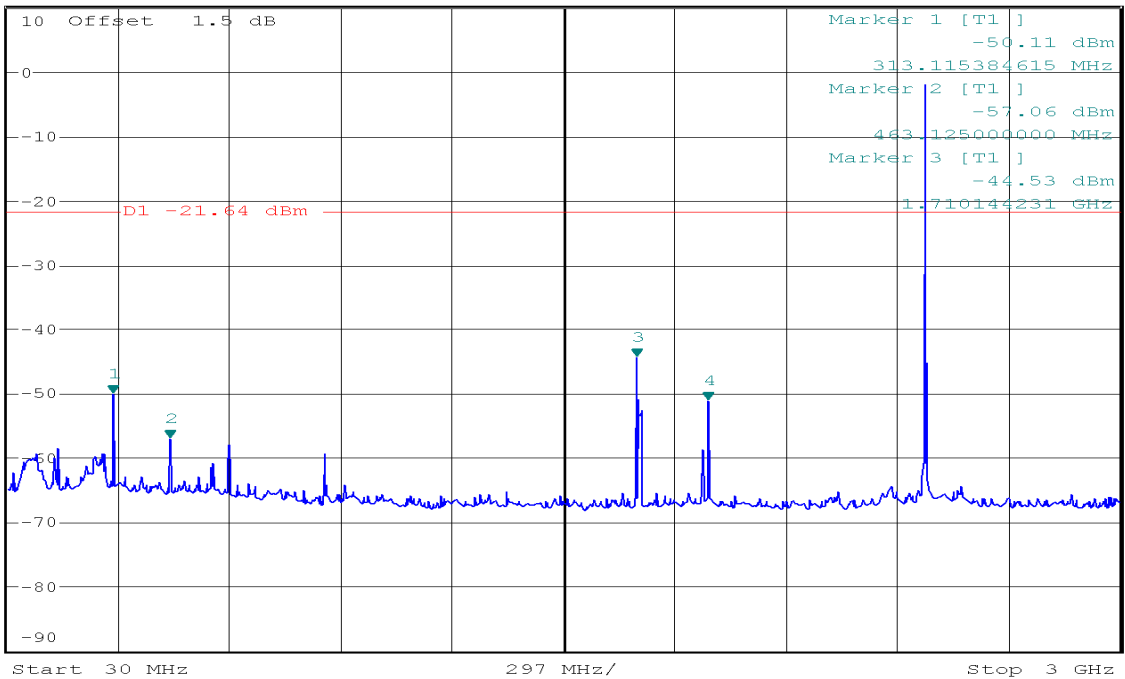

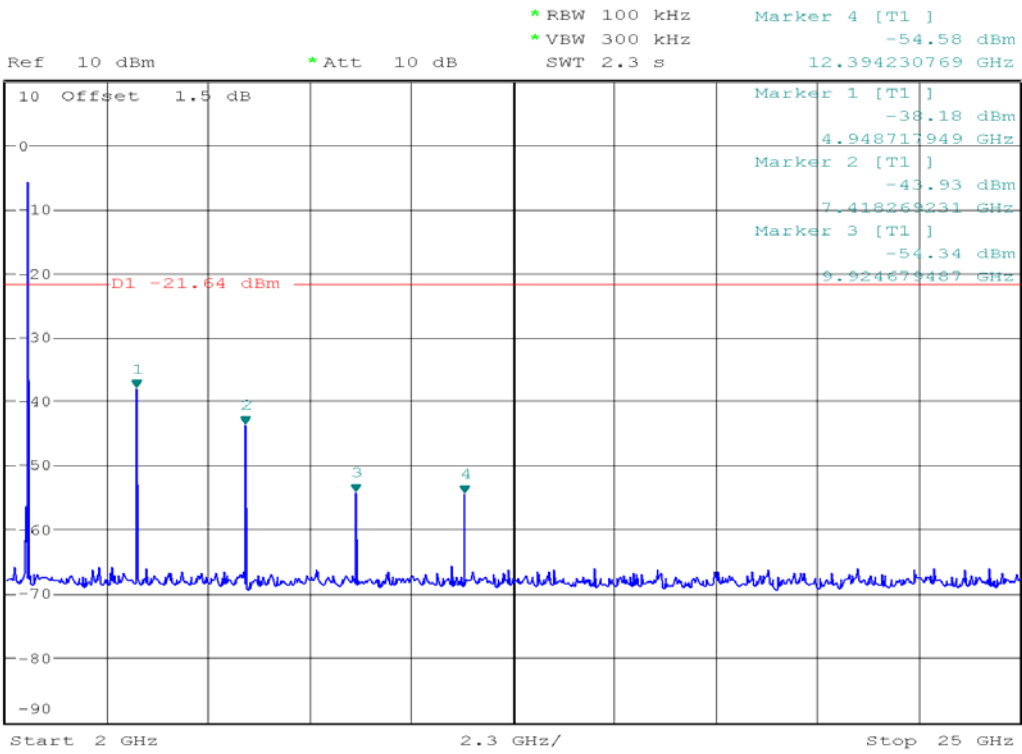

## 6.6 Radiated Band Edge and Spurious Emission Measurement

### LIMIT

1). According to FCC rules:

In any 100 kHz bandwidth outside the intentional radiator frequency band, all harmonics/spurious must be at least 20 dB below the highest emission level within the authorized band. If the output power of this device was measured by spectrum analyzer, the attenuation under this paragraph shall be 30 dB instead of 20 dB. In addition, radiated emissions which fall in the restricted bands must also comply with the FCC section 15.209 limits as below.

Frequency (MHz)	Field Strength (mV/m)	Measurement Distance (m)
30-88	100*	3
88-216	150*	3
216-960	200*	3
Above 960	500	3

**Remark:** Except as provided in paragraph (g), fundamental emissions from intentional radiators operating under this Section shall not be located in the frequency bands 54-72 MHz, 76-88 MHz, 174-216 MHz or 470-806 MHz. However, operation within these frequency bands is permitted under other sections of this Part, e.g., Sections 15.231 and 15.241.

In the above emission table, the tighter limit applies at the band edges.

Frequency (Hz)	Field Strength ( $\mu\text{V}/\text{m}$ at 3-meter)	Field Strength (dB $\mu\text{V}/\text{m}$ at 3-meter)
30-88	100	40
88-216	150	43.5
216-960	200	46
Above 960	500	54

2). According to IC rules:

According to RSS-Gen section 8.9, Except where otherwise indicated in the applicable RSS, radiated emissions shall comply with the field strength limits shown in table below. Additionally, the level of any transmitter unwanted emission shall not exceed the level of the transmitter's fundamental emission.

Frequency	Magnetic field strength (H-Field) ( $\mu\text{A/m}$ )	Measurement distance (m)
9 - 490 kHz 1	6.37/F (F in kHz)	300
490 - 1705 kHz	63.7/F (F in kHz)	30
1.705 - 30 MHz	0.08	30

**Note:** The emission limits for the bands 9-90 kHz and 110-490 kHz are based on measurements employing a linear average detector. Transmitting devices are not permitted in restricted frequency bands unless stated otherwise in the relevant RSS.

In the emission table above, the tighter limit applies at the band edges.

Frequency (MHz)	Field Strength ( $\mu\text{v/m}$ at 3 metres)
30-88	100
88-216	150
216-960	200
Above 960*	500

**Note:** Transmitting devices are not permitted in restricted frequency bands unless stated otherwise in the specific RSS.

## Test Configuration

### Below 30MHz

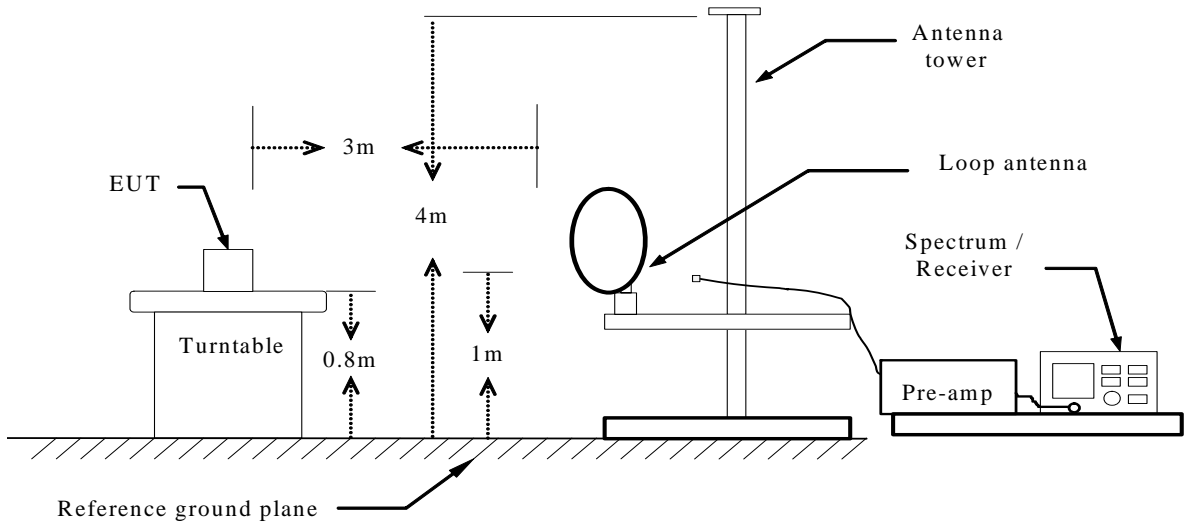

### Below 1 GHz

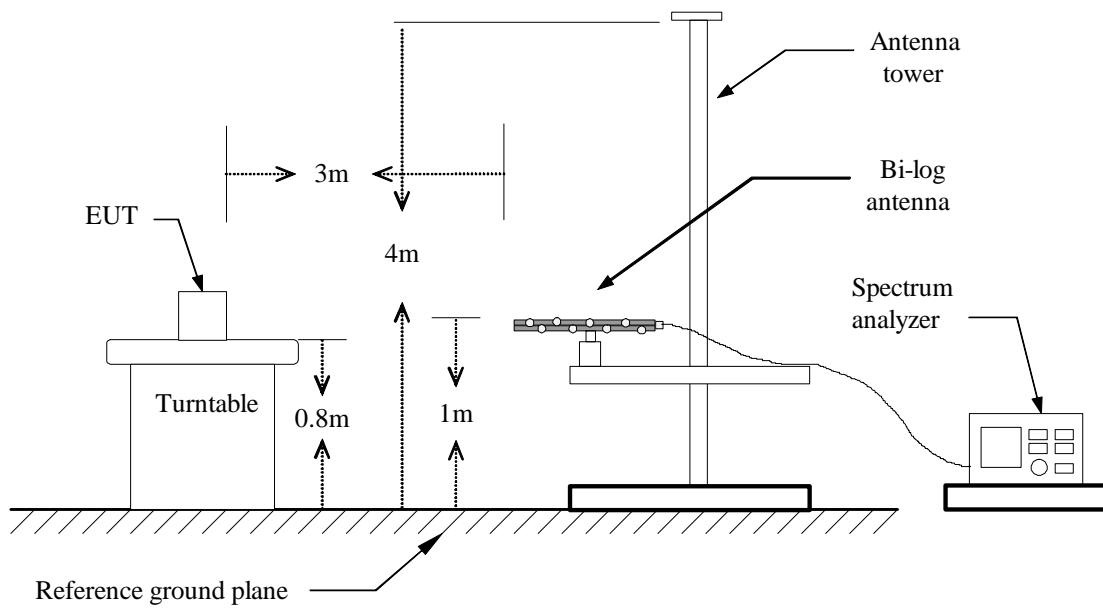

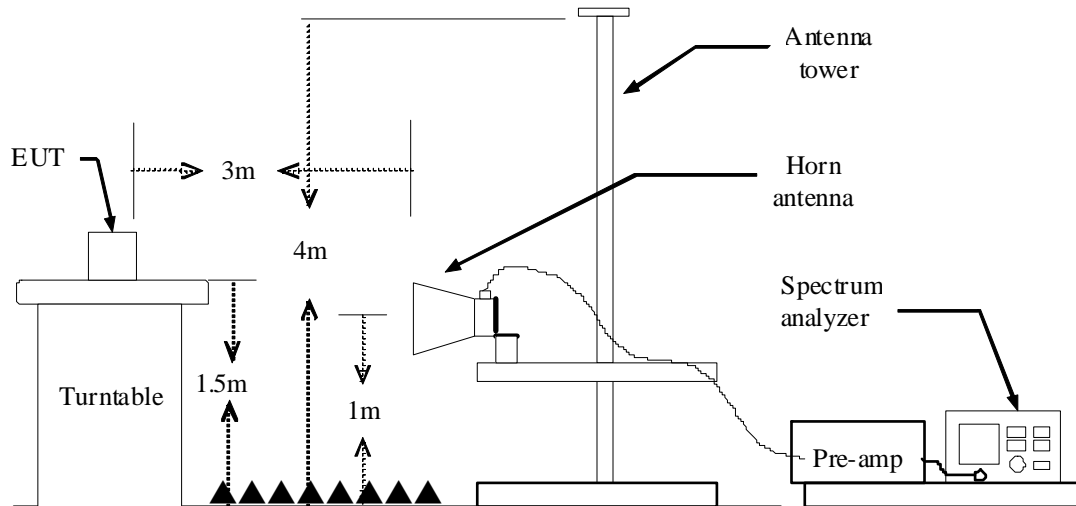
**Above 1 GHz****TEST PROCEDURE**

1. The EUT is placed on a turntable above ground plane, which is 0.8 meter for frequency below 1GHz and 1.5 meter for frequency above 1GHz.
2. The turntable shall be rotated for 360 degrees to determine the position of maximum emission level.
3. EUT is set 3m away from the receiving antenna, which is varied from 1m to 4m to find out the highest emissions.
4. Maximum procedure was performed on the six highest emissions to ensure EUT compliance.
5. And also, each emission was to be maximized by changing the polarization of receiving antenna both horizontal and vertical.
6. Set the spectrum analyzer in the following setting as:

Below 1GHz:

RBW=100kHz / VBW=300kHz / Sweep=AUTO

Above 1GHz:

PEAK: RBW=VBW=1MHz / Sweep=AUTO

AVERAGE: RBW=1MHz / Sweep=AUTO

VBW=10Hz, when duty cycle is no less than 98 percent.

VBW  $\geq 1/T$ , when duty cycle is less than 98 percent, where T is the minimum transmission duration over which the transmitter is on and is transmitting at its Maximum power control level for the tested mode of operation.

Configuration	Duty Cycle (%)	VBW
BLE	100	10Hz

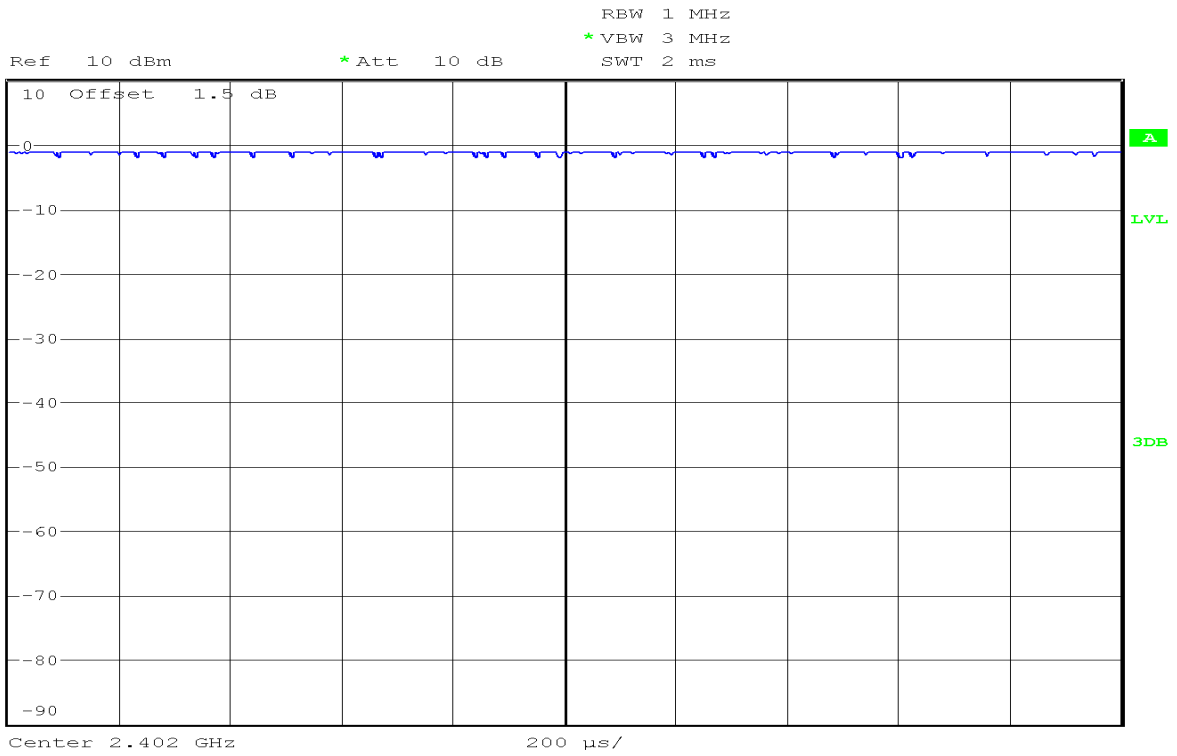

### RESTRICTED BANDEDGE (BLE4.2 on Channel 0, Horizontal)

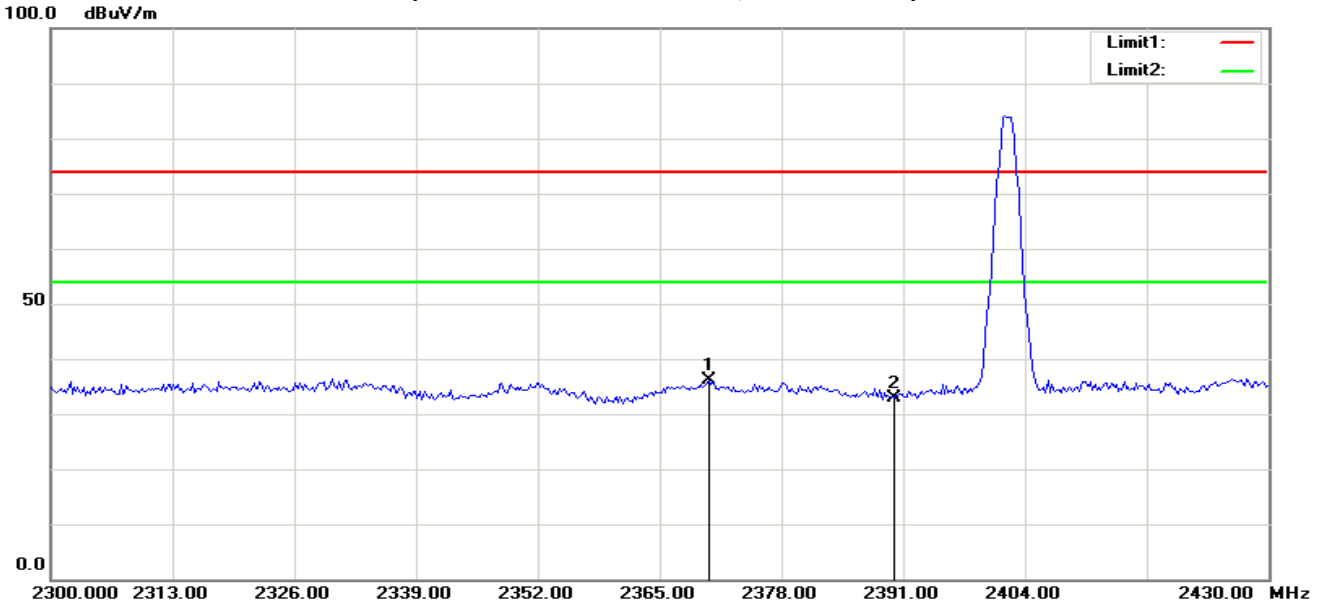

No.	Frequency (MHz)	Reading (dBuV)	Correct Factor(dB/m)	Result (dBuV/m)	Limit (dBuV/m)	Margin (dB)	Height (cm)	Degree (deg.)	Remark
1	2370.208	45.31	-9.07	36.24	74.00	-37.76	100	360	peak
2	2390.000	41.89	-8.95	32.94	74.00	-41.06	100	236	peak

### RESTRICTED BANDEDGE (BLE4.2 on Channel 0, Vertical)

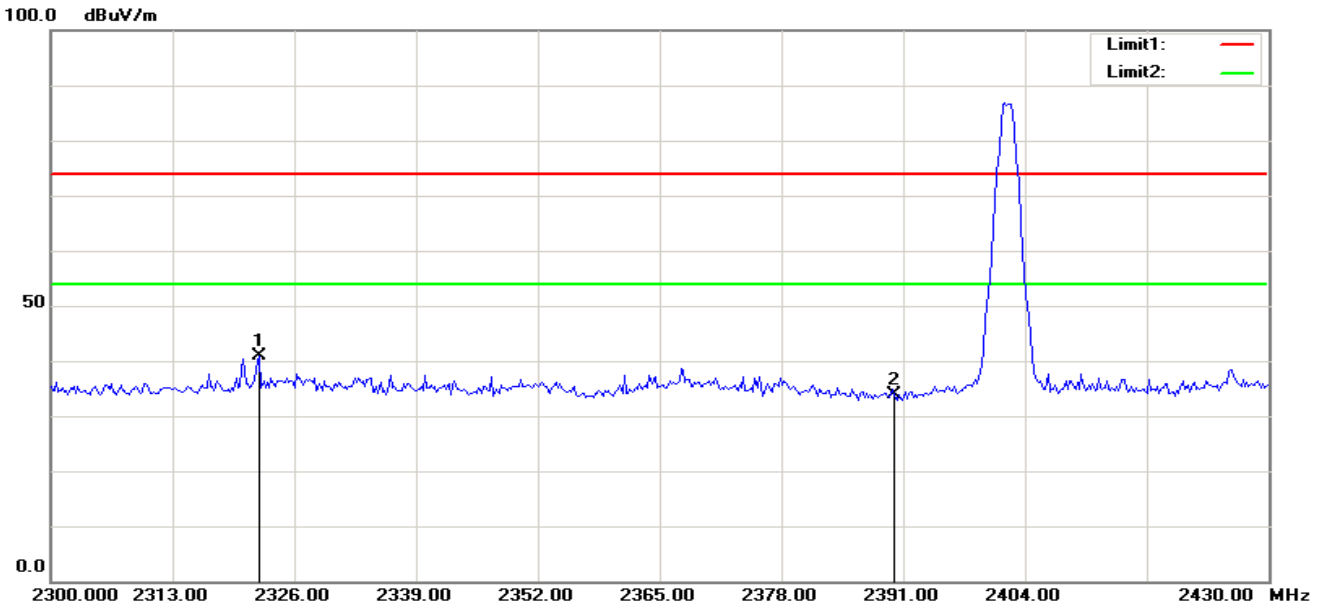

No.	Frequency (MHz)	Reading (dBuV)	Correct Factor(dB/m)	Result (dBuV/m)	Limit (dBuV/m)	Margin (dB)	Height (cm)	Degree (deg.)	Remark
1	2322.292	50.19	-9.38	40.81	74.00	-33.19	100	29	peak
2	2390.000	42.81	-8.95	33.86	74.00	-40.14	100	205	peak



## RESTRICTED BANDEDGE (BLE4.2 on Channel 39, Horizontal)

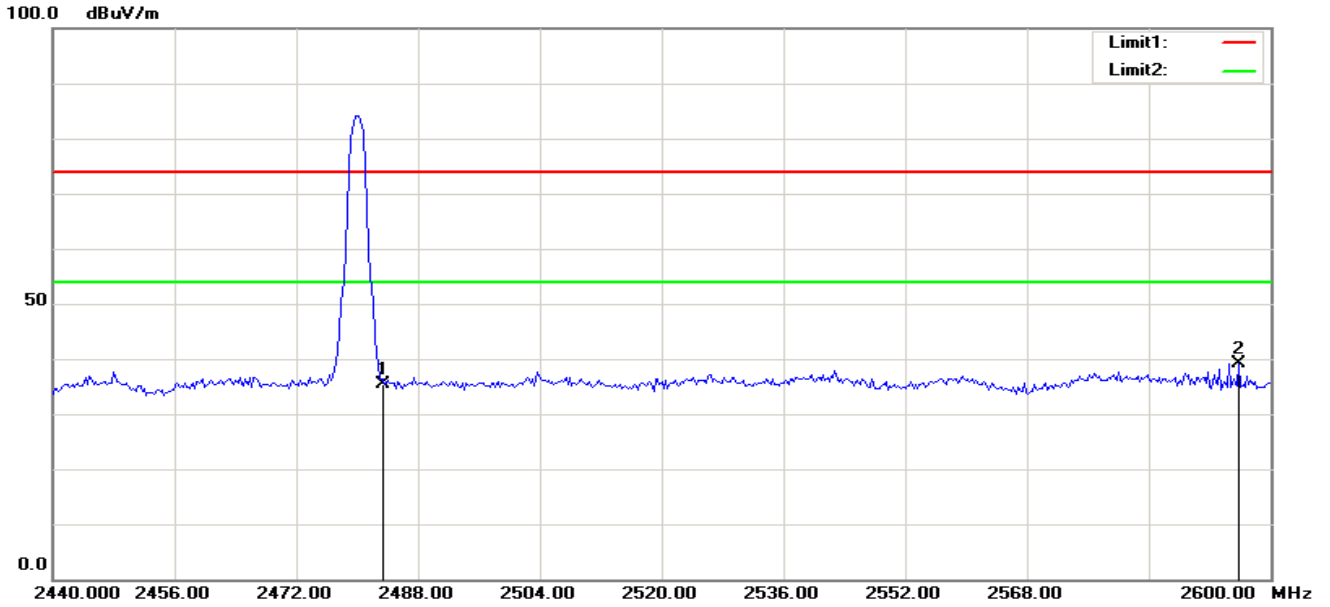

No.	Frequency (MHz)	Reading (dBuV)	Correct Factor(dB/m)	Result (dBuV/m)	Limit (dBuV/m)	Margin (dB)	Height (cm)	Degree (deg.)	Remark
1	2483.500	43.69	-8.35	35.34	74.00	-38.66	100	267	peak
2	2595.897	46.87	-7.76	39.11	74.00	-34.89	100	247	peak

## RESTRICTED BANDEDGE (BLE4.2 on Channel 39, Vertical)

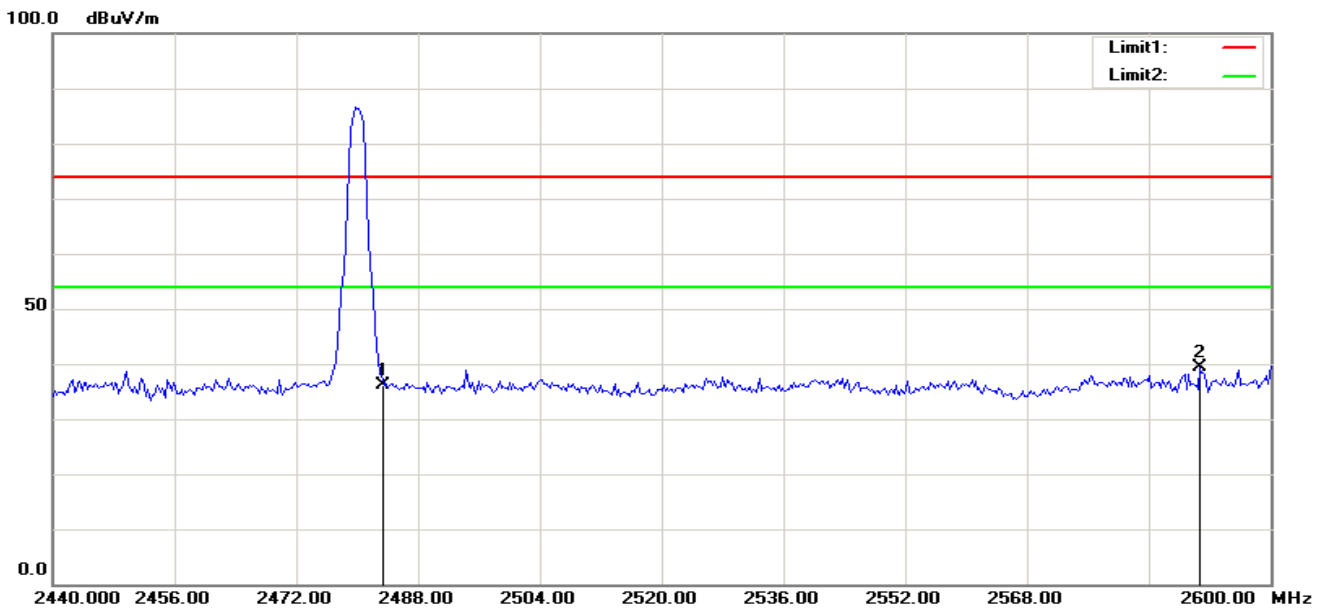

No.	Frequency (MHz)	Reading (dBuV)	Correct Factor(dB/m)	Result (dBuV/m)	Limit (dBuV/m)	Margin (dB)	Height (cm)	Degree (deg.)	Remark
1	2483.500	44.53	-8.35	36.18	74.00	-37.82	100	115	peak
2	2590.769	47.09	-7.79	39.30	74.00	-34.70	100	7	peak

## Test Result of Radiated Emission

### Below 30MHz

The interference of the frequency value is lower than the limit below 20 db, measured as the background noise values and will not be recorded.

### 30MHz-1GHz

<b>Operation Mode:</b>	Bluetooth LE4.2, CH00	<b>Test Date:</b>	2018-8-23
<b>Temperature:</b>	25°C	<b>Tested by:</b>	Lily.Wang
<b>Humidity:</b>	48% RH	<b>Polarity:</b>	Hor.

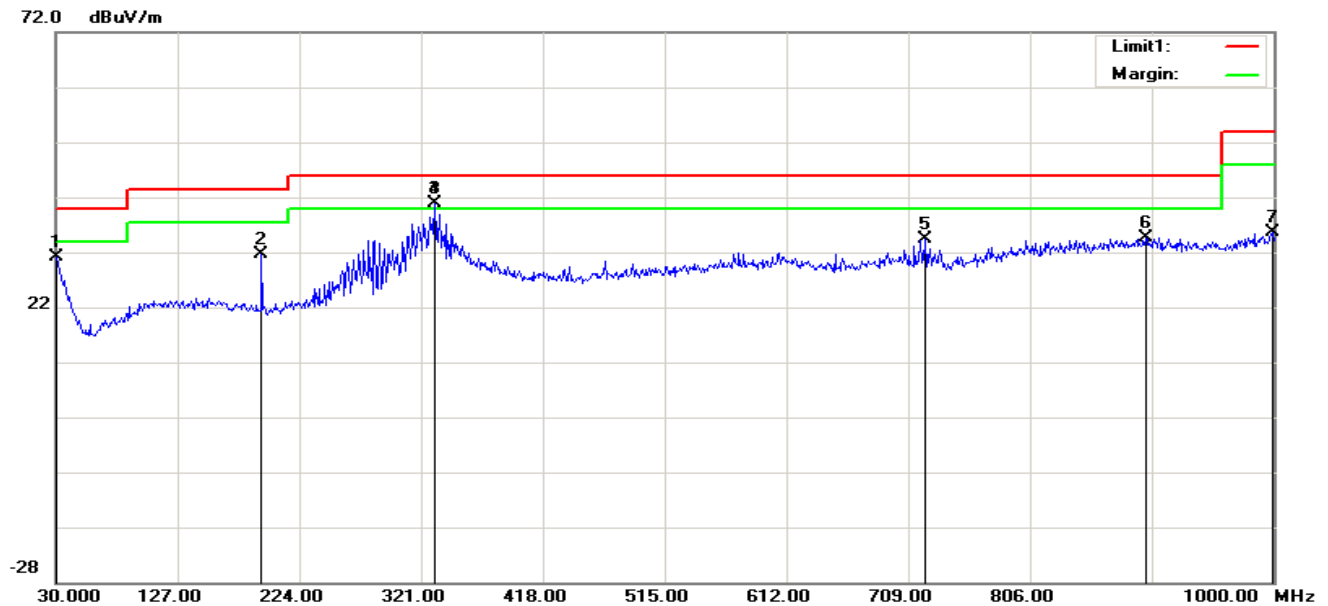

Frequency (MHz)	Ant. Pol. (H/V)	Reading (dBuV)	Correction Factor (dB/m)	Result (dBuV/m)	Limit (dBuV/m)	Margin (dB)	Remark
30.9700	H	5.95	25.09	31.04	40.00	-8.96	peak
193.9300	H	14.46	17.24	31.70	43.50	-11.80	peak
331.8270	H	16.87	24.08	40.95	46.00	-5.05	QP
722.5800	H	8.89	25.60	34.49	46.00	-11.51	peak
898.1500	H	5.65	28.95	34.60	46.00	-11.40	peak
999.0300	H	5.79	29.93	35.72	54.00	-18.28	peak

<b>Operation Mode:</b>	Bluetooth LE4.2, CH00	<b>Test Date:</b>	2018-8-23
<b>Temperature:</b>	25°C	<b>Tested by:</b>	Lily.Wang
<b>Humidity:</b>	48% RH	<b>Polarity:</b>	Ver.

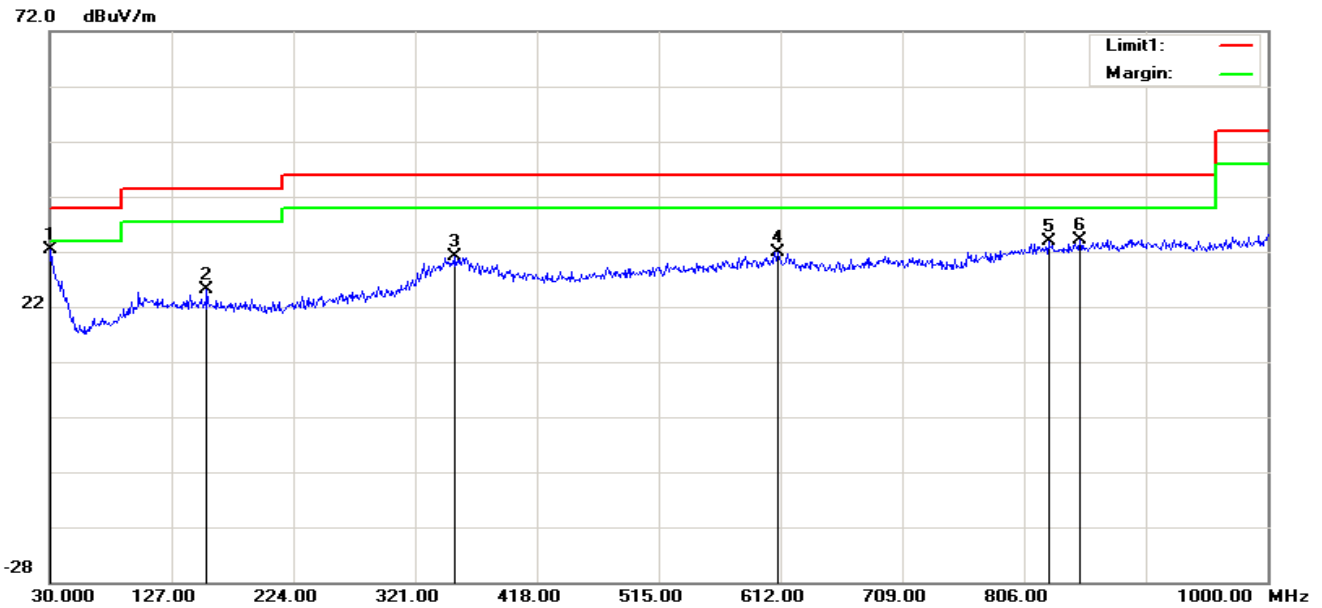

Frequency (MHz)	Ant. Pol. (H/V)	Reading (dBuV)	Correction Factor (dB/m)	Result (dBuV/m)	Limit (dBuV/m)	Margin (dB)	Remark
30.9700	V	7.35	25.09	32.44	40.00	-7.56	peak
155.1300	V	7.38	17.77	25.15	43.50	-18.35	peak
353.0100	V	4.86	26.16	31.02	46.00	-14.98	peak
610.0600	V	6.12	25.74	31.86	46.00	-14.14	peak
825.4000	V	5.94	28.04	33.98	46.00	-12.02	peak
850.6200	V	5.63	28.49	34.12	46.00	-11.88	peak

**Notes:**

1. Measurements above show only up to maximum emissions noted, if no specific emissions from the EUT are recorded (ie: margin>20dB from the applicable limit) and considered that's already beyond the background noise floor.
2. Radiated emissions measured in frequency range from 9 KHz to 1000MHz were made with an instrument using Peak detector mode.
3. Data of measurement within this frequency range shown " --- " in the table above means the reading of emissions are attenuated more than 20dB below the permissible limits or the field strength is too small to be measured.
4. The IF bandwidth of SPA between 30MHz to 1GHz was 100kHz.

### Above 1 GHz

**Operation Mode:** Bluetooth LE4.2      **Test Date:** 2018-8-23  
**Test Channel:** CH00      **Tested by:** Lily.Wang  
**Temperature:** 25°C      **Polarity:** Ver. / Hor.

### Horizontal

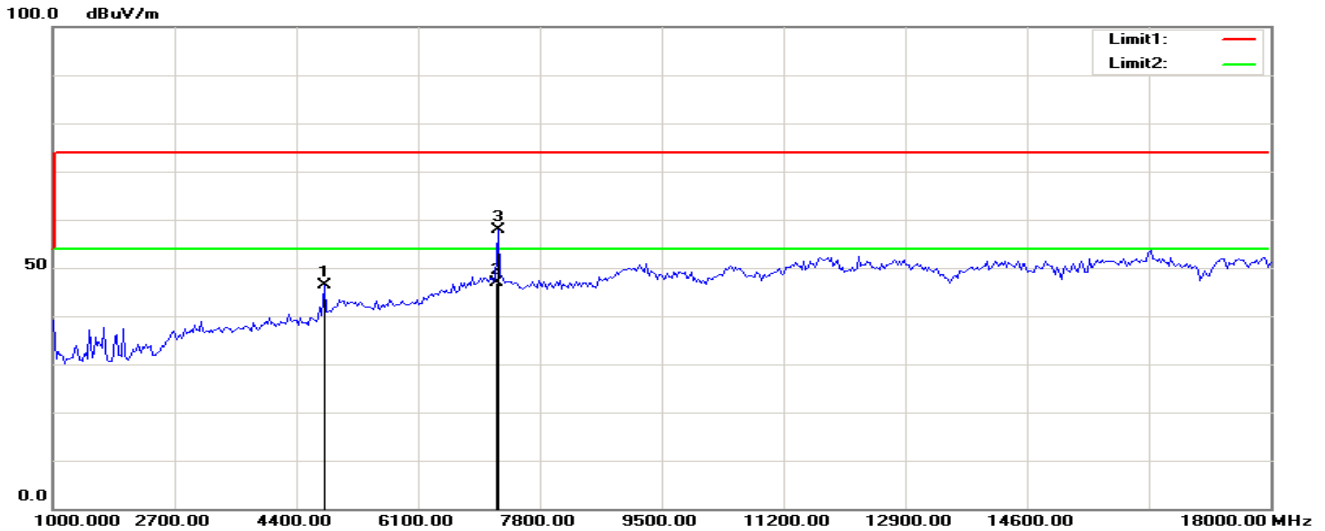

No.	Frequency (MHz)	Reading (dBuV)	Correct Factor(dB/m)	Result (dBuV/m)	Limit (dBuV/m)	Margin (dB)	Height (cm)	Degree (deg.)	Remark
1	4786.859	47.48	-1.13	46.35	74.00	-27.65	100	256	peak
2	7205.458	40.39	6.53	46.92	54.00	-7.08	100	360	AVG
3	7211.538	51.32	6.52	57.84	74.00	-16.16	100	360	peak

### Vertical

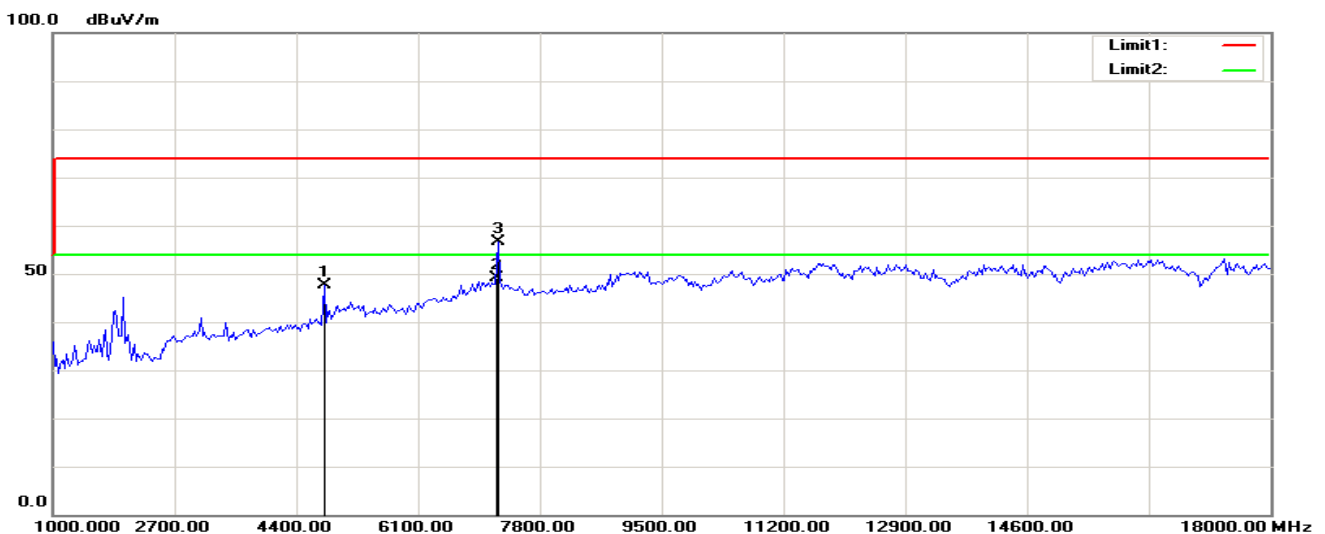

No.	Frequency (MHz)	Reading (dBuV)	Correct Factor(dB/m)	Result (dBuV/m)	Limit (dBuV/m)	Margin (dB)	Height (cm)	Degree (deg.)	Remark
1	4786.859	48.79	-1.13	47.66	74.00	-26.34	100	70	peak
2	7205.400	42.52	6.53	49.05	54.00	-4.95	100	69	AVG
3	7211.538	50.00	6.52	56.52	74.00	-17.48	100	68	peak

**Operation Mode:** Bluetooth LE4.2      **Test Date:** 2018-8-23  
**Test Channel:** CH19      **Tested by:** Lily.Wang  
**Temperature:** 25°C      **Polarity:** Ver. / Hor.

### Horizontal

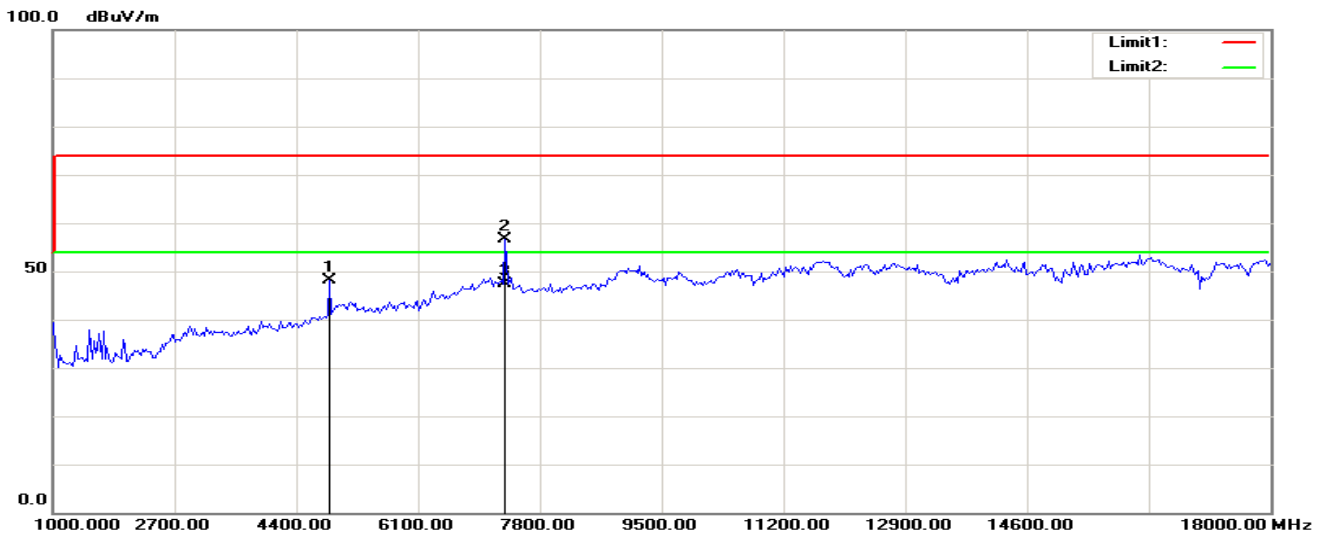

No.	Frequency (MHz)	Reading (dBuV)	Correct Factor(dB/m)	Result (dBuV/m)	Limit (dBuV/m)	Margin (dB)	Height (cm)	Degree (deg.)	Remark
1	4868.590	48.58	-0.43	48.15	74.00	-25.85	100	255	peak
2	7320.513	50.22	6.33	56.55	74.00	-17.45	200	360	peak
3	7320.523	40.97	6.33	47.30	54.00	-6.70	200	360	AVG

### Vertical

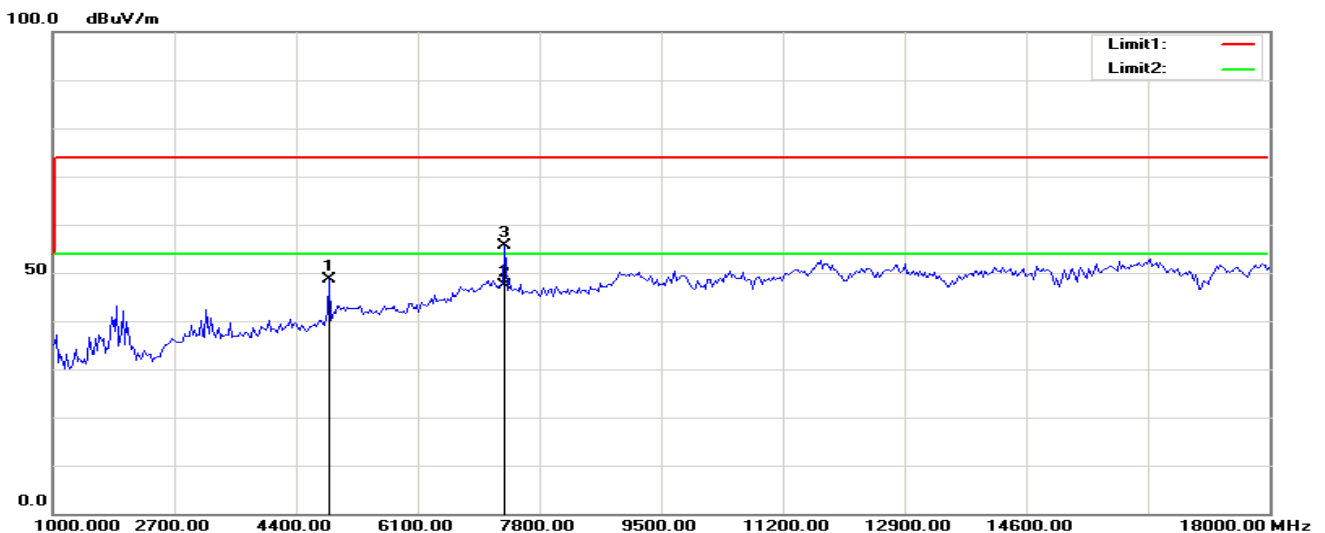

No.	Frequency (MHz)	Reading (dBuV)	Correct Factor(dB/m)	Result (dBuV/m)	Limit (dBuV/m)	Margin (dB)	Height (cm)	Degree (deg.)	Remark
1	4868.590	49.09	-0.43	48.66	74.00	-25.34	100	61	peak
2	7320.495	41.00	6.33	47.33	54.00	-6.67	200	312	AVG
3	7320.513	49.26	6.33	55.59	74.00	-18.41	200	320	peak

**Operation Mode:** Bluetooth LE4.2      **Test Date:** 2018-8-23  
**Test Channel:** CH39      **Tested by:** Lily.Wang  
**Temperature:** 25°C      **Polarity:** Ver. / Hor.

### Horizontal

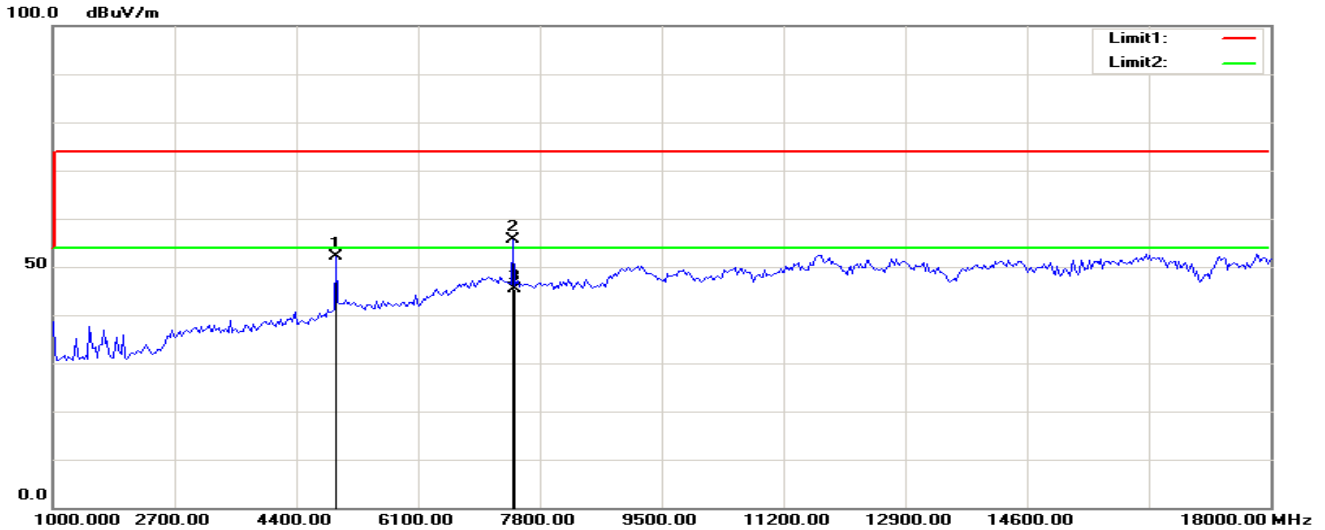

No.	Frequency (MHz)	Reading (dBuV)	Correct Factor(dB/m)	Result (dBuV/m)	Limit (dBuV/m)	Margin (dB)	Height (cm)	Degree (deg.)	Remark
1	4950.320	51.83	0.26	52.09	74.00	-21.91	100	258	peak
2	7429.487	49.39	6.14	55.53	74.00	-18.47	200	339	peak
3	7440.764	39.27	6.12	45.39	54.00	-8.61	200	340	AVG

### Vertical

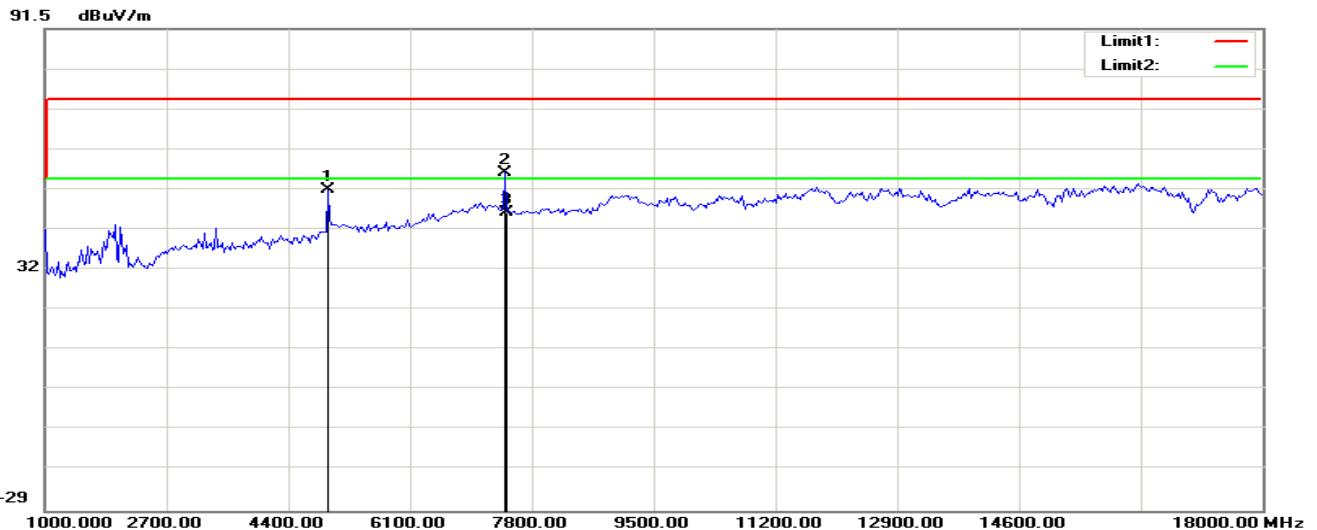

No.	Frequency (MHz)	Reading (dBuV)	Correct Factor(dB/m)	Result (dBuV/m)	Limit (dBuV/m)	Margin (dB)	Height (cm)	Degree (deg.)	Remark
1	4950.320	51.26	0.26	51.52	74.00	-22.48	100	208	peak
2	7429.487	49.60	6.14	55.74	74.00	-18.26	200	217	peak
3	7440.570	39.48	6.12	45.60	54.00	-8.40	100	215	AVG

#### Above 18GHz

The interference of the frequency value is lower than the limit below 20 db, measured as the background noise values and will not be recorded.

## 6.7 POWERLINE CONDUCTED EMISSIONS

### LIMIT

1). According to FCC rules:

For an intentional radiator which is designed to be connected to the public utility (AC) power line, the radio frequency voltage that is conducted back onto the AC power line on any frequency or frequencies within the band 150 kHz to 30 MHz shall not exceed 250 microvolts (The limit decreases linearly with the logarithm of the frequency in the range 0.15 MHz to 0.50 MHz). The limits at specific frequency range is listed as follows:

Frequency Range (MHz)	Limits (dB $\mu$ V)	
	Quasi-peak	Average
0.15 to 0.50	66 to 56*	56 to 46*
0.50 to 5	56	46
5 to 30	60	50

\* Decreases with the logarithm of the frequency.

Compliance with this provision shall be based on the measurement of the radio frequency voltage between each power line (LINE and NEUTRAL) and ground at the power terminals.

### Test Configuration

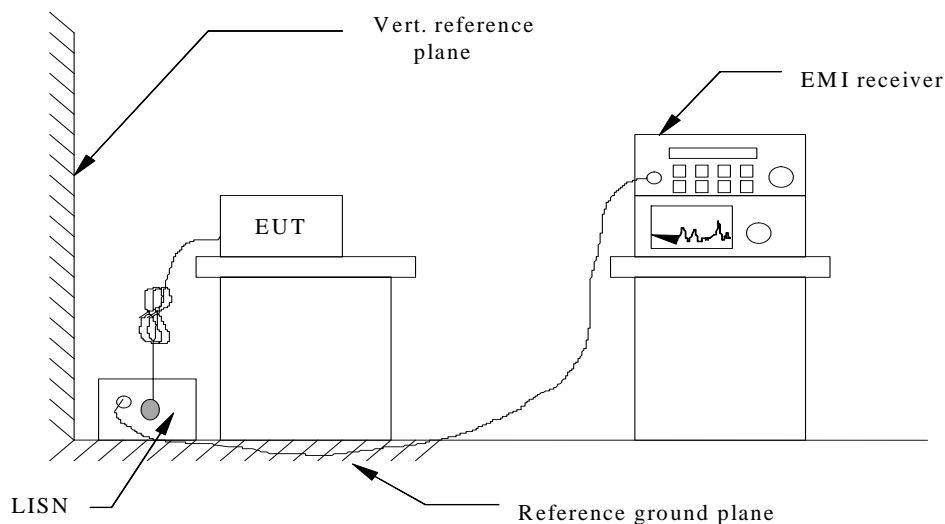

See test photographs attached in Appendix 1 for the actual connections between EUT and support equipment.

2). According to IC rules:

Unless stated otherwise in the applicable RSS, for radio apparatus that are designed to be connected to the public utility AC power network, the radio frequency voltage that is conducted back onto the AC power line on any frequency or frequencies within the range 150 kHz to 30 MHz shall not exceed the limits in table 4, as measured using a 50  $\mu$ H / 50  $\Omega$  line impedance stabilization network. This requirement applies for the radio frequency voltage measured between each power line and the ground terminal of each AC power-line mains cable of the EUT.

For an EUT that connects to the AC power lines indirectly, through another device, the requirement for compliance with the limits in table 4 shall apply at the terminals of the AC power-line mains cable of a representative support device, while it provides power to the EUT. The lower limit applies at the boundary between the frequency ranges. The device used to power the EUT shall be representative of typical applications.

Frequency (MHz)	Conducted limit (dB $\mu$ V)	Frequency (MHz)
	Quasi-peak	Average
0.15-0.5	66 to 56 <sup>1</sup>	56 to 46 <sup>1</sup>
0.5-5	56	46
5-30	60	50

**Note 1:** The level decreases linearly with the logarithm of the frequency

### **TEST PROCEDURE**

1. The EUT was placed on a table, which is 0.8m above ground plane.
2. Maximum procedure was performed on the six highest emissions to ensure EUT compliance.
3. Repeat above procedures until all frequency measured were complete.

### **TEST RESULTS**

N/A, The EUT powered by two AA batteries.

**END OF REPORT**