



Smart On/Off Switch

• WF30 •



- Switch x1
- Wiring x1
- Screws x2
- Faceplate x1

Specifications:

Model: WF30
 Power: 120VAC, 60Hz
 Wireless Frequency: 2.4GHz
 Wireless Standard: IEEE802.11b/g/n
 Maximum Load: 960W Incandescent,
 ½ HP Motor or 1800W (15A) Resistive
 Temperature Range: 32-104° F (0-40° C)

For indoor use.

IMPORTANT!

The fixture controlled by the Z-Wave In-wall Smart Switch must not exceed 960 watts (Incandescent); 1800W (15A) Resistive or ½ HP Motor. The switch is designed only for using with permanently installed fixtures.

Pre-installation preparation

Tools You Will Need

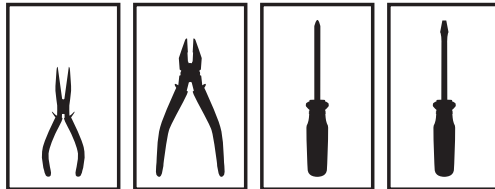

Single switch wiring

Before you start; you may wish to change the paddle color to match your wallplate or decor. Please proceed to <To Change Color Of The Paddle>.

(1) Shut off power to the circuit at circuit breaker or fuse box.

IMPORTANT! Verify power is OFF to switch box before continuing.

Turn OFF the power to the branch circuit for the switch and lighting fixture at the service panel. All wiring connections must be made with the POWER OFF to avoid personal injury and/or damage to the switch.

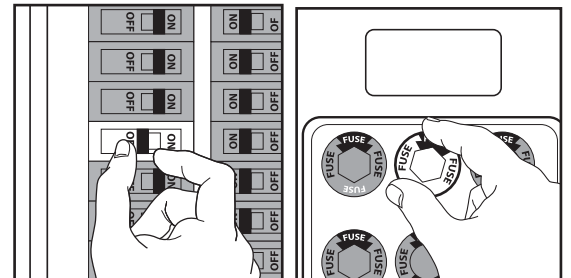

(2) Remove wall plate, Remove the switch mounting screws.

(3) Carefully remove the switch from the switch box. DO NOT disconnect the wires.

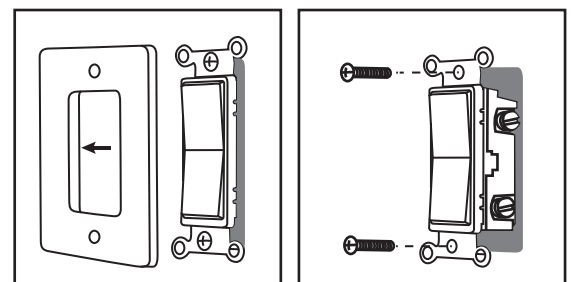

Understanding circuit diagrams

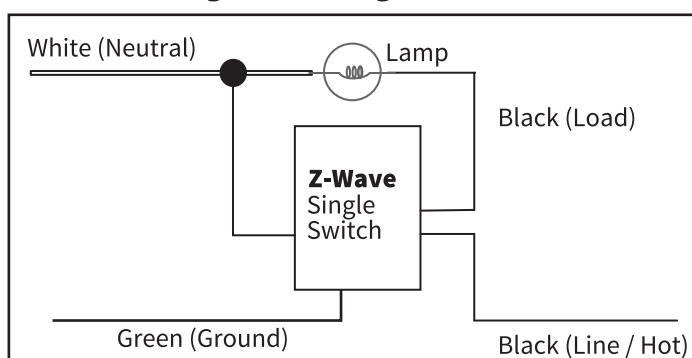

Identify the wires.

- A. LINE (Hot) — Black (connected to power)
- B. NEUTRAL — White
- C. LOAD — Black (connected to lighting)
- D. GROUND — Green/Bare
- E. TRAVELER — Red/Other (only in 3-way in stallions)

▲ Common

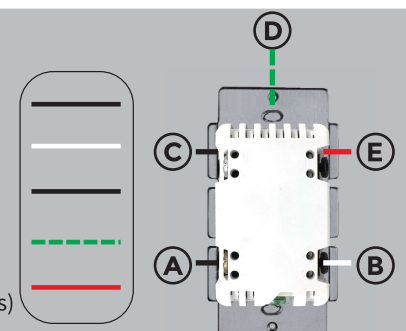

Single switch

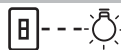

Before

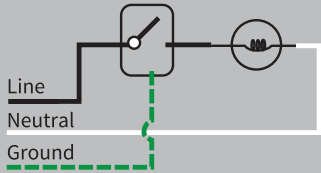
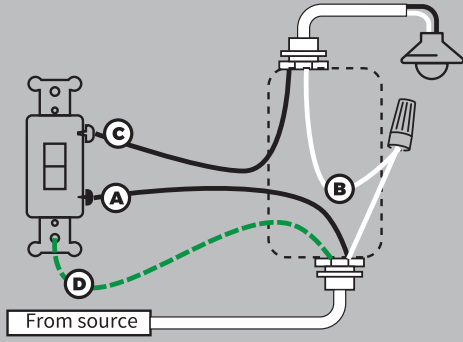

Now

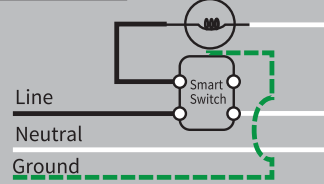
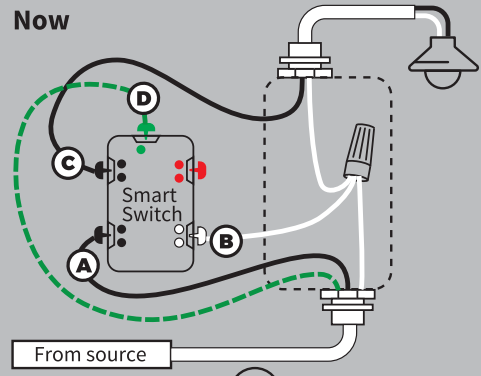

3-Way switch option 1



Before

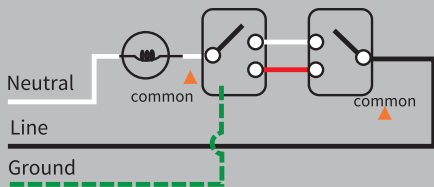
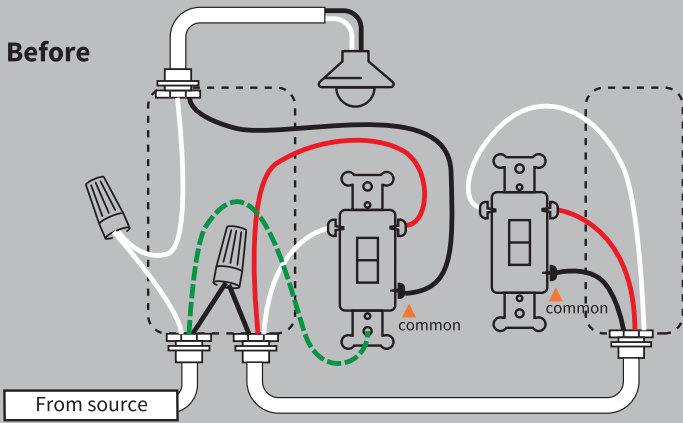

Now

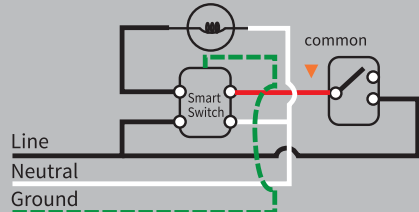
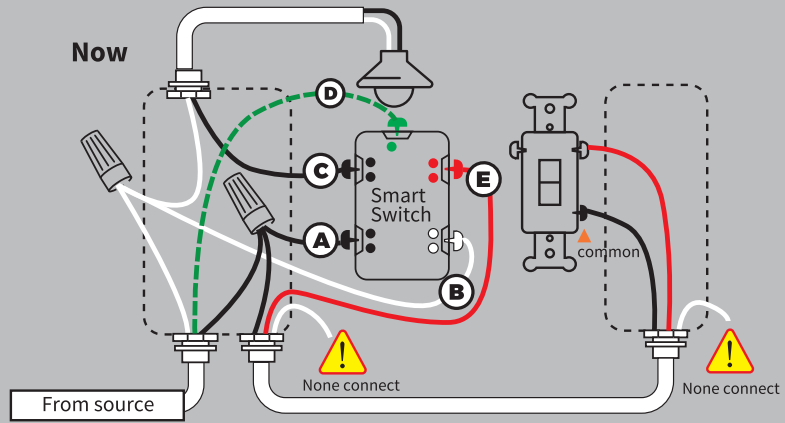

3-Way switch option 2



Before

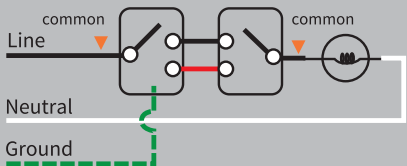
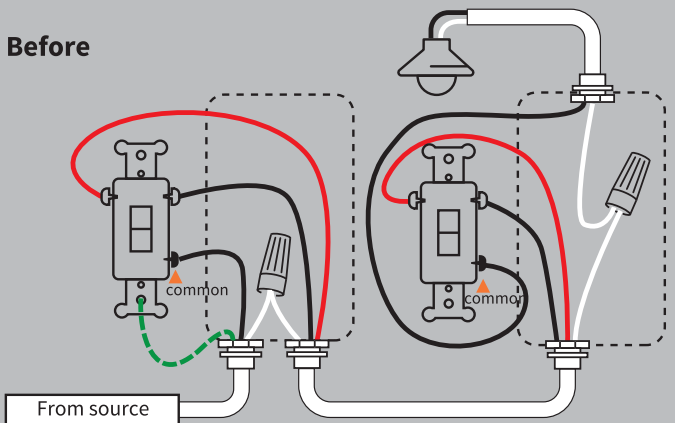

Now

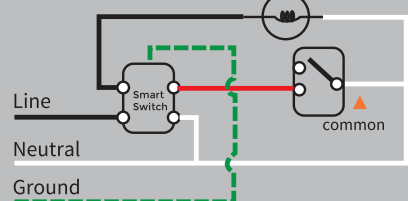
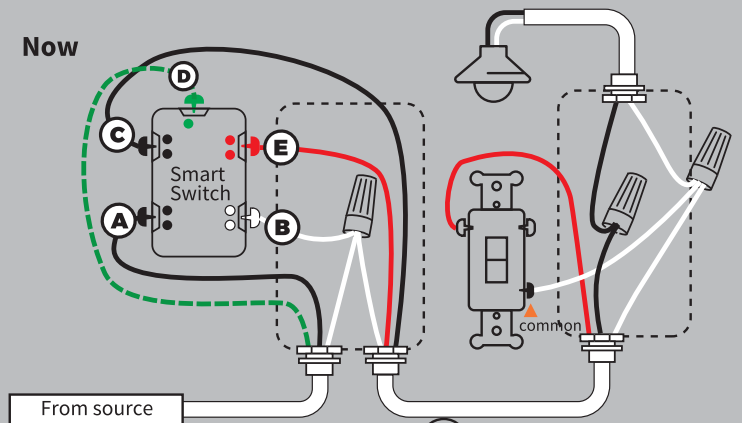

FCC Caution.

This device complies with part 15 of the FCC Rules. Operation is subject to the following two conditions: (1) This device may not cause harmful interference, and (2) this device must accept any interference received, including interference that may cause undesired operation.

Any Changes or modifications not expressly approved by the party responsible for compliance could void the user's authority to operate the equipment.

Note: This equipment has been tested and found to comply with the limits for a Class B digital device, pursuant to part 15 of the FCC Rules. These limits are designed to provide reasonable protection against harmful interference in a residential installation. This equipment generates uses and can radiate radio frequency energy and, if not installed and used in accordance with the instructions, may cause harmful interference to radio communications. However, there is no guarantee that interference will not occur in a particular installation. If this equipment does cause harmful interference to radio or television reception, which can be determined by turning the equipment off and on, the user is encouraged to try to correct the interference by one or more of the following measures:

-Reorient or relocate the receiving antenna.

-Increase the separation between the equipment and receiver.

-Connect the equipment into an outlet on a circuit different from that to which the receiver is connected.

-Consult the dealer or an experienced radio/TV technician for help.

***RF warning for Mobile device:**

This equipment should be installed and operated with minimum distance 20cm between the radiator& your body.