



FCC TEST REPORT

for

FCC ID : 2AQURNL69

Product: Laser Light Projector

Model: NL69

Report No.: PTC22032204201E-FC01

Issued for

NIE-TECH Co., Ltd

**Jinlian commercial center 9001, Jinxiu road No.273, Changan Town,Dongguan
City, GuangDongProv., CHINA**

Issued by

Precise Testing & Certification Co., Ltd.

Building 1, No. 6, Tongxin Road, Dongcheng Street, Dongguan, Guangdong, China.

TEL: +86-769-3880 8222

FAX: +86-769-3882 6111

Note: This report shall not be reproduced except in full, without the written approval of Precise Testing & Certification Co., Ltd. This document may be altered or revised by Precise Testing & Certification Co., Ltd. personnel only, and shall be noted in the revision section of the document. The test results presented in this report only relate to the tested sample.



TABLE OF CONTENTS

1. TEST CERTIFICATION	3
2. TEST SUMMARY	4
3. TEST SITE	5
3.1. TEST FACILITY.....	5
3.2. MEASUREMENT UNCERTAINTY.....	5
3.3. LIST OF TEST AND MEASUREMENT INSTRUMENTS.....	6
4. EUT DESCRIPTION	7
5. TEST METHODOLOGY	8
5.1. TEST MODE.....	8
5.2. EUT SYSTEM OPERATION.....	8
6. SETUP OF EQUIPMENT UNDER TEST	9
6.1. DESCRIPTION OF SUPPORT UNITS.....	9
6.2. CONFIGURATION OF SYSTEM UNDER TEST.....	9
7. CONDUCTED EMISSION MEASUREMENT	10
7.1. LIMITS.....	10
7.2. TEST PROCEDURES.....	10
7.3. TEST SETUP.....	11
7.4. TEST RESULT.....	11
8. RADIATED EMISSION MEASUREMENT	14
8.1. LIMITS.....	14
8.2. TEST PROCEDURE.....	15
8.3. TEST SETUP.....	16
8.4. TEST RESULT.....	16
9. PHOTOGRAPHS OF THE TEST CONFIGURATION	21
10. PHOTOGRAPHS OF EUT	22
11. LABELING REQUIREMENTS	33
12. INFORMATION TO USER	34



1. TEST CERTIFICATION

Product:	Laser Light Projector
Model:	NL69
Applicant :	NIE-TECH Co., Ltd
Address:	Jinlian commercial center 9001, Jinxiu road No.273, Changan Town,Dongguan City, GuangDongProv., CHINA
Manufacturer:	NIE-TECH Co., Ltd
Address:	Jinlian commercial center 9001, Jinxiu road No.273, Changan Town,Dongguan City, GuangDongProv., CHINA
Test Date:	Marh 23,2022 to April 11, 2022
Issued Date:	April 11, 2022
Test Voltage:	AC 120V/60Hz
Applicable Standards:	FCC Part 15, Subpart B Class B ANSI C63.4:2014

The above equipment has been tested by Precise Testing & Certification Co., Ltd. and found compliance with the requirements in the technical standards mentioned above. The test results presented in this report only relate to the product/system tested. The Other similar equipment will not necessarily produce the same results due to production tolerance and measurement uncertainties.

Test Engineer:

Carson Zhong / Engineer

Technical Manager:

Ronnie Liu / Manager



2. TEST SUMMARY

EMISSION			
Standard	Item	Result	Remarks
FCC 47 CFR Part 15 Class B	Conducted Emission (Main Port)	PASS	Complied with limit
	Radiated Emission	PASS	Complied with limit

Note: 1) The test result verdict is decided by the limit of test standard.

2) The information of measurement uncertainty is available upon the customer's request.



3. TEST SITE

3.1. TEST FACILITY

Precise Testing & Certification Co., Ltd.

Address: Building 1, No. 6, Tongxin Road, Dongcheng Street, Dongguan, Guangdong, China.

☆ CNAS Registration No.: CNAS L5772

☆ FCC Registration No.: 790290

☆ A2LA Certificate No.: 4408.01

☆ IC Registration No.: 12191A-1

3.2. MEASUREMENT UNCERTAINTY

Parameter	Uncertainty
Temperature	$\pm 1^{\circ} \text{C}$
Humidity	$\pm 5\%$
DC and Low Frequency Voltages	$\pm 3\%$
Conducted Emission(150KHz-30MHz)	$\pm 3.60\text{dB}$
Radiated Emission(30MHz-1GHz)	$\pm 4.76\text{dB}$
Radiated Emission (1GHz-18GHz)	$\pm 4.44\text{dB}$

Note 1: This uncertainty represents an expanded uncertainty expressed at approximately the 95% confidence level using a coverage factor of k=2.



3.3. LIST OF TEST AND MEASUREMENT INSTRUMENTS

3.3.1. For conducted emission at the mains terminals test

Name of Equipment	Manufacturer	Model	Serial No.	Calibration Due
EMI Test Receiver	Rohde&Schwarz	ESCI	101417	Aug. 18, 2022
Artificial Mains Network	Rohde&Schwarz	ENV216	102453	Aug. 22, 2022
ISN	SCHWARZBECK	NTFM8131	00257	Aug. 22, 2022
Test S/W	Tonscend	JS32-CE/4.0.0.3		

3.3.2. For radiated emission test (30MHz-1GHz)

Name of Equipment	Manufacturer	Model	Serial No.	Calibration Due
EMI Test Receiver	Rohde&Schwarz	ESCI	101417	Aug. 18, 2022
Bilog Antenna	SCHWARZBECK	VULB 9160	9160-3355	Aug. 19, 2022
Preamplifier (low frequency)	SCHWARZBECK	BBV 9475	9745-0013	Aug. 22, 2022
Test S/W	Emtek	e3/1.0.0.0		

3.3.3. For radiated emission test (1GHz above)

Name of Equipment	Manufacturer	Model	Serial No.	Calibration Due
EMI Test Receiver	Rohde&Schwarz	ESCI	101417	Aug. 18, 2022
Spectrum Analyzer	Agilent	E4407B	MY45109572	Aug. 28, 2022
Horn Antenna	SCHWARZBECK	9120D	9120D-1246	Aug. 19, 2022
High NOISE AMPLIFIER	ZHINAN	ZN3380C	15002	Aug. 18, 2022
Test S/W	Emtek	e3/1.0.0.0		



4. EUT DESCRIPTION

Product	Laser Light Projector
Model	NL69
Supplied Voltage	Adapter:JT-6V 1A Input:AC 120V/60Hz Output:DC 6V,0.6A
Power	N/A

I/O PORT

I/O PORT TYPES	Q'TY	TESTED WITH
AC Port	1	<input checked="" type="checkbox"/>
DC Port	1	<input type="checkbox"/>

Models Difference

Different colors.



5. TEST METHODOLOGY

5.1. TEST MODE

The EUT was tested together with the thereafter additional components, and a configuration, which produced the worst emission levels, was selected and recorded in this report.

The following test mode(s) were assessed.

Test Items		Test Mode
Emission	Conducted Emission	Lighting
	Radiated Emission	Lighting

5.2. EUT SYSTEM OPERATION

1. Set up EUT with the support equipment.
2. Make sure the EUT work normally during the test.



6. SETUP OF EQUIPMENT UNDER TEST

6.1. DESCRIPTION OF SUPPORT UNITS

The EUT has been tested as an independent unit together with other necessary accessories or support units. The following support units or accessories were used to form a representative test configuration during the tests.

No.	Equipment	Model	Serial No.	Trade Name
1.	N/A	N/A	N/A	N/A

Note: 1) All the equipment/cables were placed in the worst-case configuration to maximize the emission during the test.

2) Grounding was established in accordance with the manufacturer's requirements and conditions for the intended use.

6.2. CONFIGURATION OF SYSTEM UNDER TEST

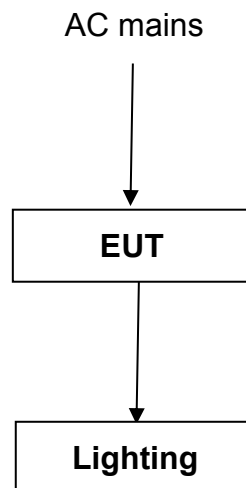

(EUT: Laser Light Projector)



7. CONDUCTED EMISSION MEASUREMENT

7.1. LIMITS

FREQUENCY (MHz)	Class A		Class B	
	Quasi-peak dB(μ V)	Average dB(μ V)	Quasi-peak dB(μ V)	Average dB(μ V)
0.15 - 0.5	79	66	66-56	56-46
0.5 - 5.0	73	60	56	46
5.0 - 30.0	73	60	60	50

Note: 1) The lower limit shall apply at the transition frequencies.

2) The limit decreases in line with the logarithm of the frequency in the range of 0.15 to 0.50 MHz.

3) All emanations from a class A/B digital device or system, including any network of conductors and apparatus connected thereto, shall not exceed the level of field strengths specified above.

7.2. TEST PROCEDURES

The EUT and Support equipment, if needed, was set up as per the test configuration to simulate typical usage per the user's manual. When the EUT is a tabletop system, a wooden table with a height of 0.8 meters is used and is placed on the ground plane. When the EUT is floor standing equipment, it is placed on the ground plane, which has a 3-12 mm non-conductive covering to insulate the EUT from the ground plane. The EUT should be 0.8 m apart from the AMN, where the mains cable supplied by the manufacturer is longer than 1 m, the excess should be folded at the centre into a bundle no longer than 0.4 m, Details please refer to test setup photography.

The Receiver scanned from 150 kHz to 30 MHz for emissions in each of the test modes. During the above scans, the emissions were maximized by cable manipulation.

A scan was taken on both of the power lines, Line and neutral, recording at least the six highest emissions. Emission frequency and amplitude were recorded into a computer in which correction factors were used to calculate the emission level and compare reading to the applicable limit. The test data of the worst-case condition(s) was recorded.

Note: Test Software Name: e3, Software Version: 1.0.0.0.

7.3. TEST SETUP

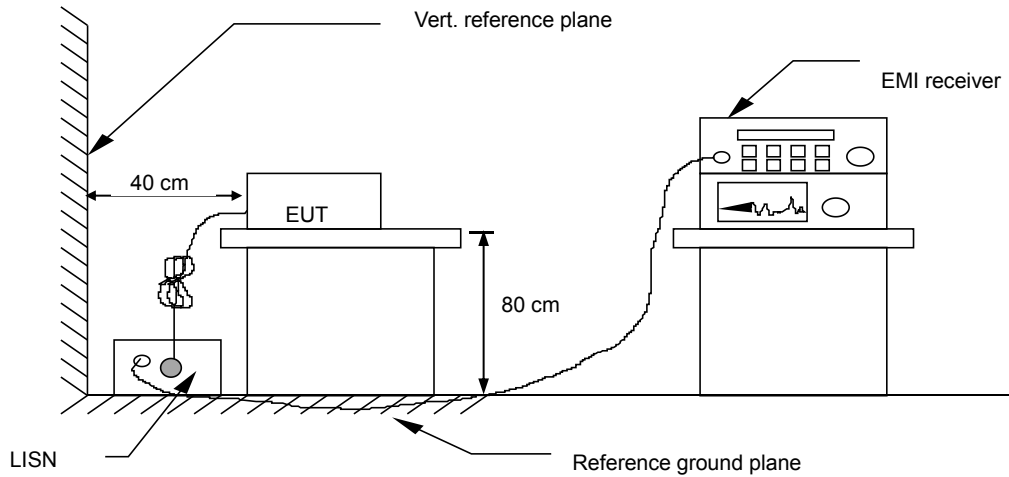

For the actual test configuration, please refer to the related item – Photographs of the Test Configuration.

7.4. TEST RESULT

Product name	Laser Light Projector	Tested By	HRD
Model	NL69	Detector Function	Peak / Quasi-peak/AV
Test Mode	Lighting	6 dB Bandwidth	9 kHz
Environmental Conditions	25°C, 60 % RH, 101.5 kPa	Test Result	Pass

Note:

L = Line Line, N = Neutral Line

Freq. = Emission frequency in MHz

Reading level (dB μ V) = Receiver reading

Corr. Factor (dB) = attenuator + Cable loss

Level (dB μ V) = Reading level (dB μ V) + Corr. Factor (dB)

Limit (dB μ V) = Limit stated in standard

Over Limit (dB) = Level (dB μ V) – Limit (dB μ V)

QP = Quasi-Peak

AV = Average



Please refer to the following diagram:

Line:

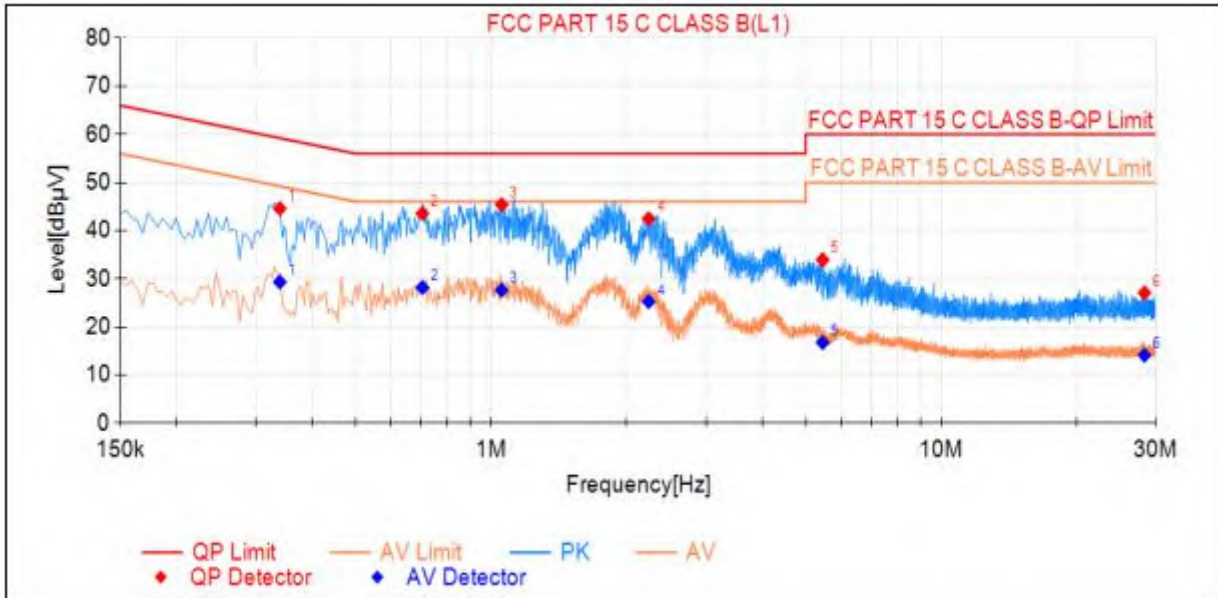

Final Data List								
NO.	Freq. [MHz]	QP Value [dBµV]	QP Limit [dBµV]	QP Margin [dB]	AV Value [dBµV]	AV Limit [dBµV]	AV Margin [dB]	Verdict
1	0.339	44.58	59.23	14.65	29.34	49.23	19.89	PASS
2	0.7035	43.56	56.00	12.44	28.20	46.00	17.80	PASS
3	1.0545	45.40	56.00	10.60	27.63	46.00	18.37	PASS
4	2.238	42.49	56.00	13.51	25.27	46.00	20.73	PASS
5	5.451	33.94	60.00	26.06	16.78	50.00	33.22	PASS
6	28.293	27.09	60.00	32.91	14.12	50.00	35.88	PASS



Neutral:

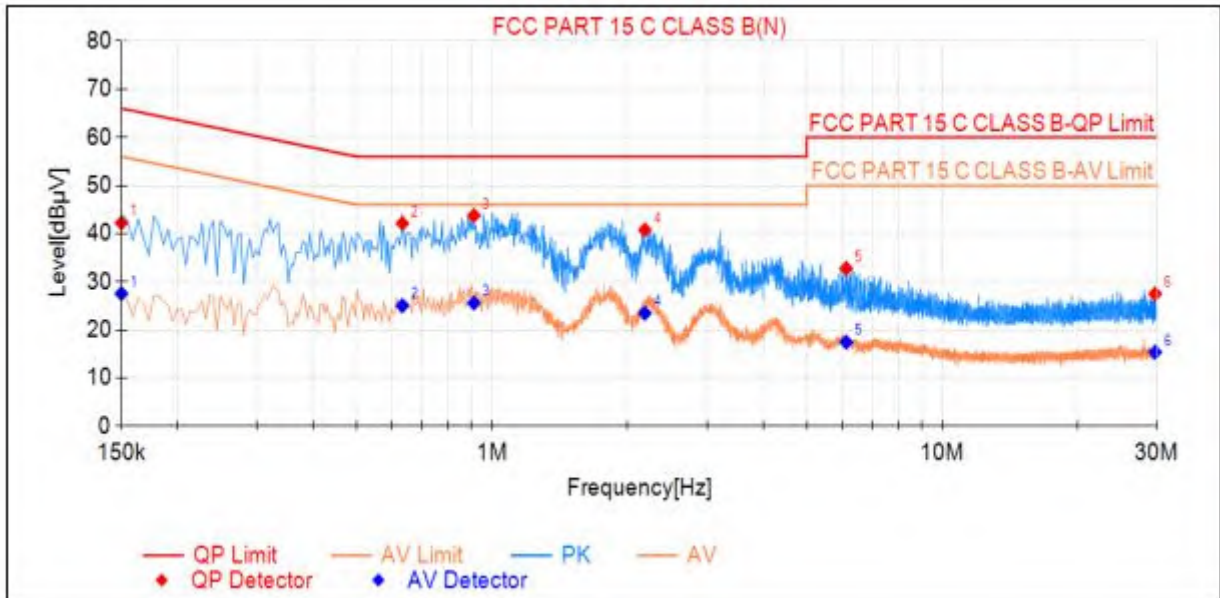

Final Data List

NO.	Freq. [MHz]	QP Value [dBµV]	QP Limit [dBµV]	QP Margin [dB]	AV Value [dBµV]	AV Limit [dBµV]	AV Margin [dB]	Verdict
1	0.15	42.23	66.00	23.77	27.56	56.00	28.44	PASS
2	0.6315	42.13	56.00	13.87	25.04	46.00	20.96	PASS
3	0.9105	43.78	56.00	12.22	25.60	46.00	20.40	PASS
4	2.184	40.77	56.00	15.23	23.48	46.00	22.52	PASS
5	6.117	32.78	60.00	27.22	17.47	50.00	32.53	PASS
6	29.7375	27.50	60.00	32.50	15.37	50.00	34.63	PASS



8. RADIATED EMISSION MEASUREMENT

8.1. LIMITS

Maximum permissible level of Radiated Emission measured at 3 meter distance.

FREQUENCY (MHz)	dB μ V/m (At 3m)	
	Class A digital device	Class B digital device
30~88	49.00	40.00
88~216	53.50	43.50
216~960	56.40	46.00
960~1000	59.50	54.00

Note: 1) The lower limit shall apply at the transition frequencies.

2) Emission level (dB μ V/m) = 20 log Emission level (μ V/m).

Requirements for radiated emissions at frequencies above 1 GHz for class A&B equipment

FREQUENCY (MHz)	dB μ V/m (At 3m)		
	Detector type/ bandwidth	Class A digital device	Class B digital device
1000~6000	Average/ 1 MHz	60	54
1000~6000	Peak/ 1 MHz	80	74

Note: 1)An FSOATS may be a SAC/OATS with RF absorber on the RGP or a FAR.



8.2. TEST PROCEDURE

The equipment was set up as per the test configuration to simulate typical usage per the user's manual. When the EUT is a tabletop system, a wooden turntable with a height of 0.8 meters is used which is placed on the ground plane. When the EUT is floor standing equipment, it is placed on the ground plane which has a 0.1 m non-conductive covering to insulate the EUT from the ground plane.

The antenna was placed at 3 meter away from the EUT. The antenna connected to the spectrum analyzer via a cable and at times a pre-amplifier would be used.

The analyzer / receiver quickly scanned from 30 MHz to 6000 MHz. The EUT test program was started. Emissions were scanned and measured rotating the EUT to 360 degrees and positioning the antenna 1 to 4 meters above the ground plane, in both the vertical and the horizontal polarization, to maximize the emission reading level.

During the above scans, the emissions were maximized by cable manipulation. Each modes is measured, recorded at least the six highest emissions. The emission frequency, amplitude, antenna position, polarization and turntable position were recorded into a computer in which correction factors were used to calculate the emission level and compare reading to the applicable limit and only Q.P. reading is presented.

The test data of the worst-case condition(s) was recorded.

Note: Test Software Name: e3, Software Version: 8.2.1.0.

8.3. TEST SETUP

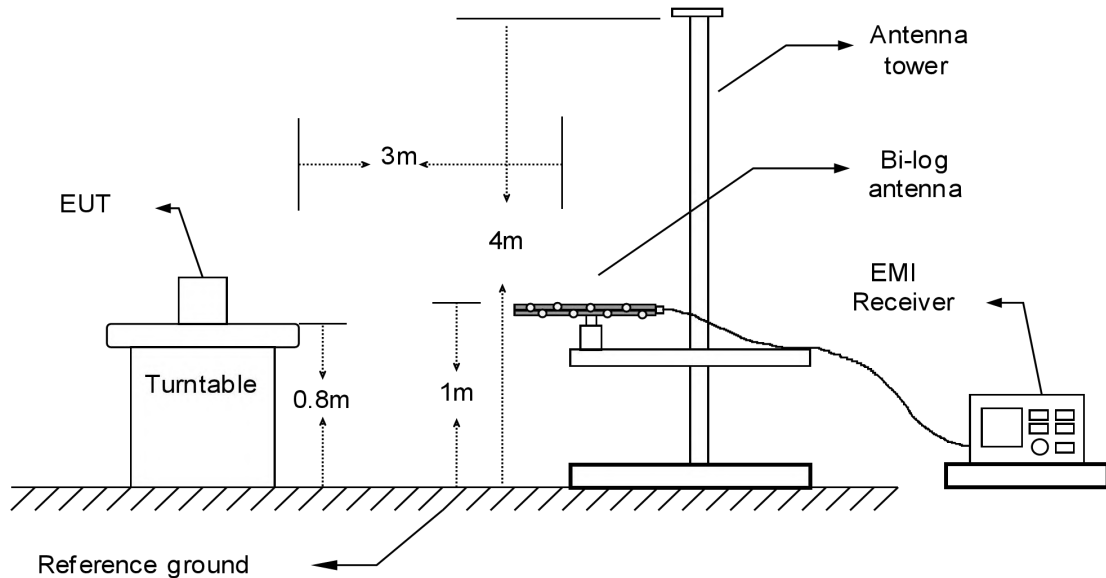

For the actual test configuration, please refer to the related item – Photographs of the Test Configuration

8.4. TEST RESULT

Product name	Laser Light Projector	Antenna Distance	3 m
Model	NL69	Antenna Pole	Vertical / Horizontal
Test Mode	Lighting	Detector Function	Peak / Quasi-peak
Environmental Conditions	24.5°C, 52 % RH, 101.3 kPa	6 dB Bandwidth	120 kHz
Tested by	YXZ	Test Result	Pass

Note:

Freq. = Emission frequency in MHz

Reading level (dB μ V) = Receiver reading(dB μ V)

Corr.Factor (dB/m)=Antenna factor(dB/m)+Cable loss(dB)-Preamp Factor(dB)

Measurement (dB μ V/m)=Reading level(dB μ V)+ Corr. Factor (dB/m)

Limit (dB μ V/m) = Limit stated in standard

Over Limit (dB) = Measurement (dB μ V/m) – Limit (dB μ V/m)

QP = Quasi-Peak

The highest frequency of the EUT internal source is greater than 108MHz, so the frequency is measured to 6GHz.



Please refer to the following diagram: (Radiated Emission test Result below 1G)

Vertical:

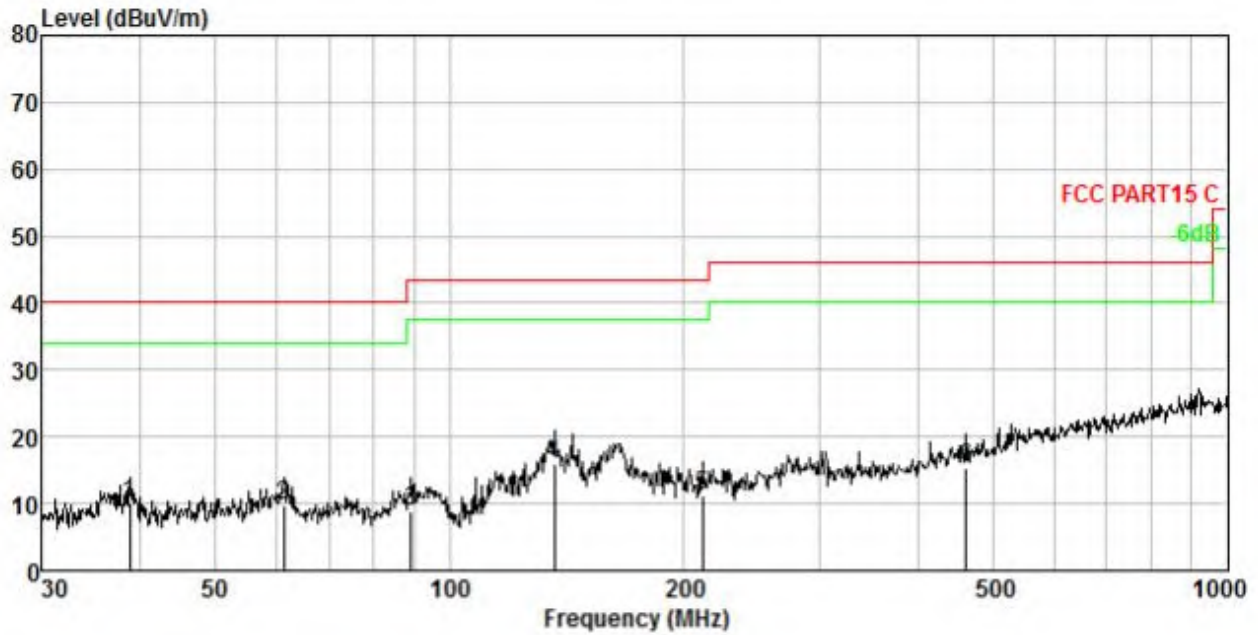

No.	Freq MHz	Cable Loss dB	ANT Factor dB/m	Receiver Reading dBuV	Preamp Factor dB	Emission Level dBuV/m	Limit dBuV/m	Over Limit dB	Remark
1.	38.888	1.65	12.12	26.16	29.91	10.02	40.00	-29.98	QP
2.	61.346	2.43	11.51	25.73	29.94	9.73	40.00	-30.27	QP
3.	89.276	3.08	9.13	26.66	29.98	8.89	43.50	-34.61	QP
4.	136.460	3.81	13.08	28.94	30.01	15.82	43.50	-27.68	QP
5.	211.527	4.56	11.38	25.26	30.08	11.12	43.50	-32.38	QP
6.	462.346	5.91	16.21	24.15	30.83	15.44	46.00	-30.56	QP



Horizontal:

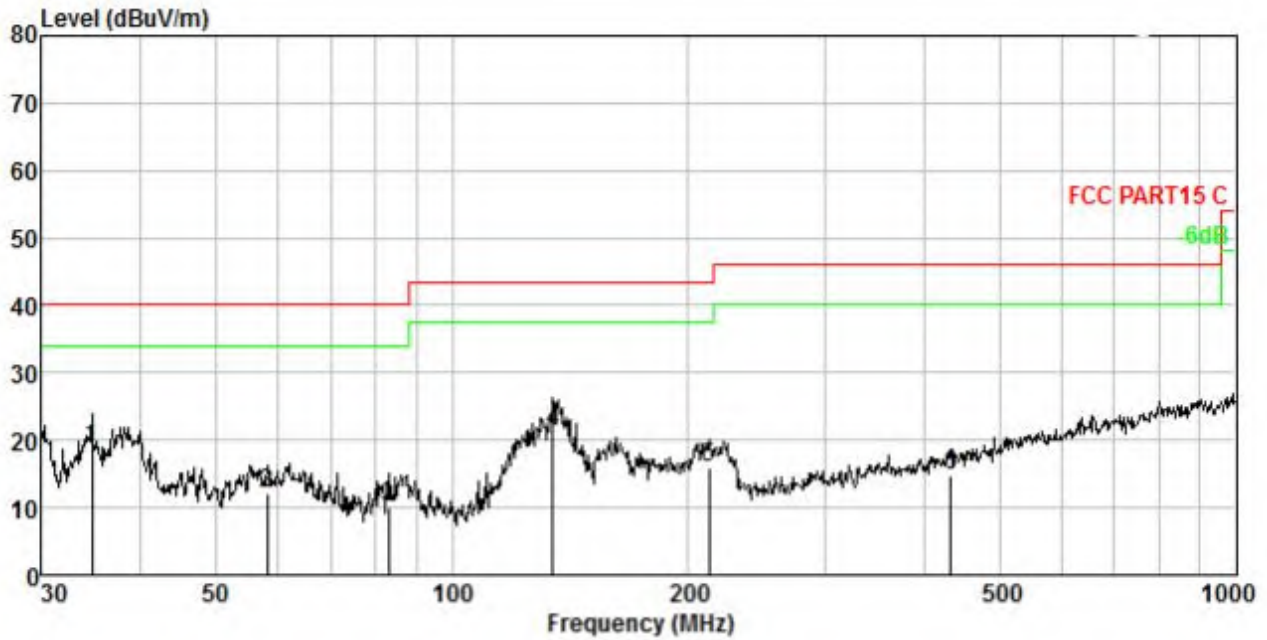

No.	Freq MHz	Cable Loss dB	ANT Factor dB/m	Receiver Reading dBuV	Preamp Factor dB	Emission Level dBuV/m	Limit dBuV/m	Over Limit dB	Remark
1.	34.760	1.46	12.18	35.15	29.90	18.89	40.00	-21.11	QP
2.	58.203	2.34	11.84	27.94	29.94	12.18	40.00	-27.82	QP
3.	82.938	2.95	8.82	28.17	29.97	9.97	40.00	-30.03	QP
4.	134.559	3.78	12.97	34.46	30.01	21.20	43.50	-22.30	QP
5.	213.015	4.57	11.42	30.11	30.08	16.02	43.50	-27.48	QP
6.	432.546	5.79	15.53	24.19	30.77	14.74	46.00	-31.26	QP



Please refer to the following diagram: (Radiated Emission test Result Above 1G)

Vertical:

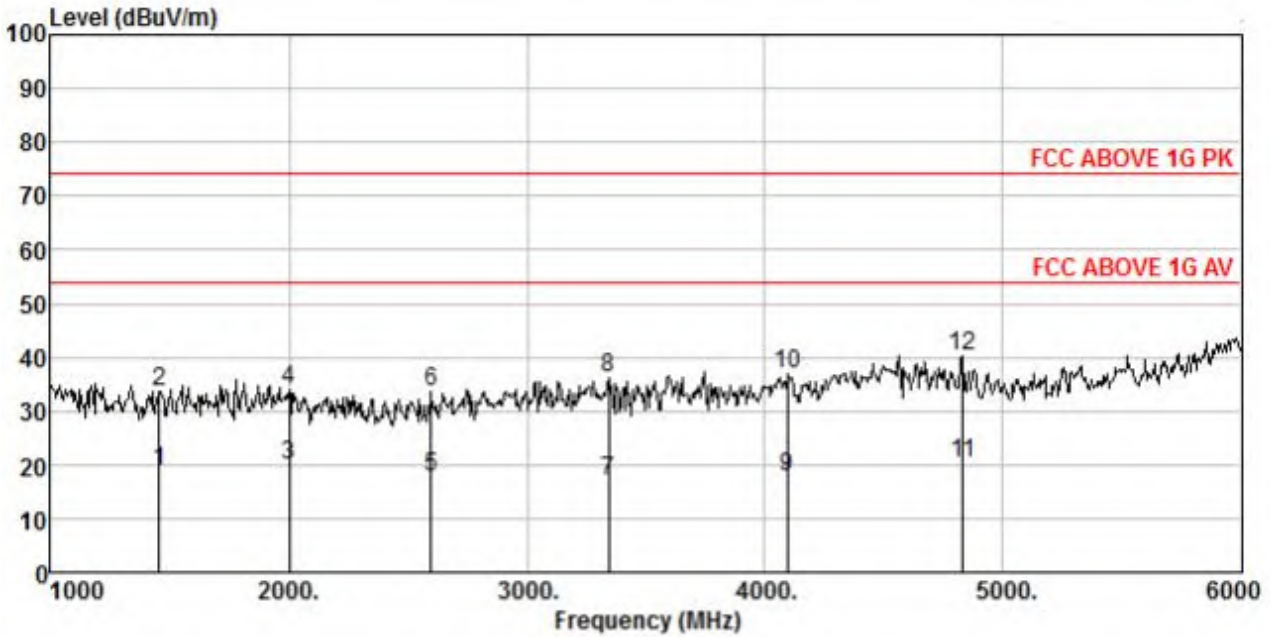

No.	Freq MHz	Cable Loss dB	ANT Factor dB/m	Receiver Reading dBUV	Preamp Factor dB	Emission Level dBUV/m	Limit dBUV/m	Over Limit dB	Remark
1.	1457.200	1.83	25.34	19.05	27.56	18.66	54.00	-35.34	Average
2.	1457.200	1.83	25.34	34.01	27.56	33.62	74.00	-40.38	Peak
3.	2002.800	2.44	26.11	19.31	28.05	19.81	54.00	-34.19	Average
4.	2002.800	2.44	26.11	33.31	28.05	33.81	74.00	-40.19	Peak
5.	2598.000	2.93	28.07	15.19	28.54	17.65	54.00	-36.35	Average
6.	2598.000	2.93	28.07	31.15	28.54	33.61	74.00	-40.39	Peak
7.	3342.000	3.41	30.05	12.46	28.83	17.09	54.00	-36.91	Average
8.	3342.000	3.41	30.05	31.46	28.83	36.09	74.00	-37.91	Peak
9.	4092.200	3.79	31.41	11.34	28.72	17.82	54.00	-36.18	Average
10.	4092.200	3.79	31.41	30.34	28.72	36.82	74.00	-37.18	Peak
11.	4830.000	4.10	32.30	12.18	28.45	20.13	54.00	-33.87	Average
12.	4830.000	4.10	32.30	32.19	28.45	40.14	74.00	-33.86	Peak



Horizontal:

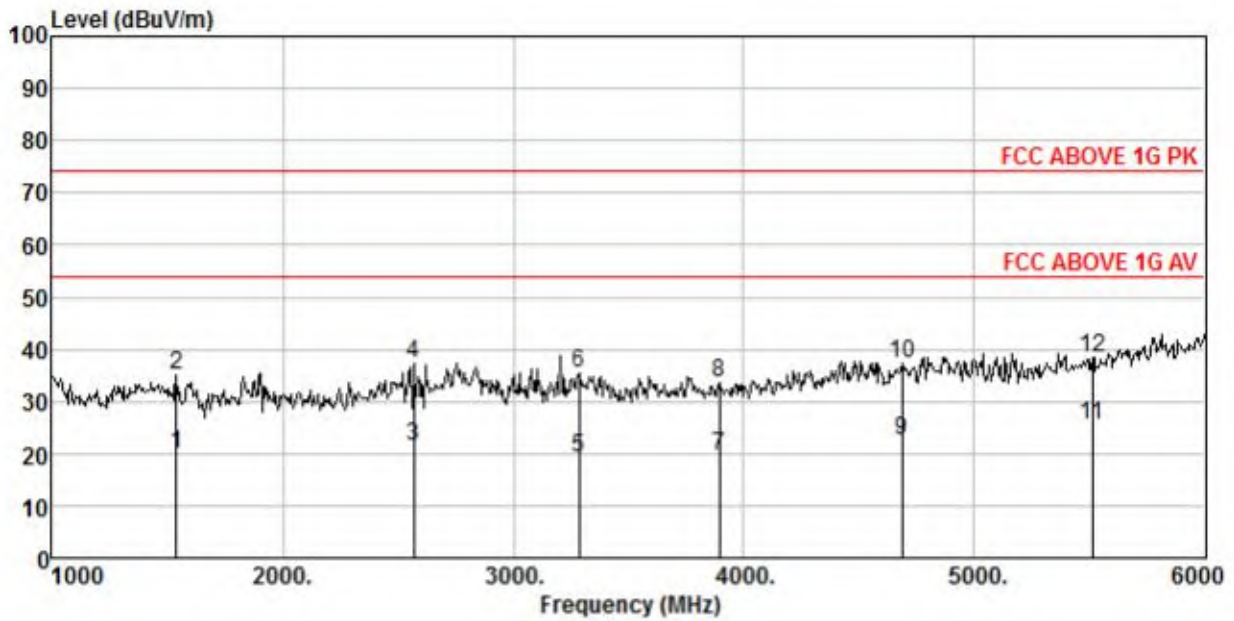

No.	Freq MHz	Cable Loss dB	ANT Factor dB/m	Receiver Reading dBuV	Preamp Factor dB	Emission Level dBuV/m	Limit dBuV/m	Over Limit dB	Remark
1.	1537.800	1.94	25.45	20.13	27.63	19.89	54.00	-34.11	Average
2.	1537.800	1.94	25.45	35.11	27.63	34.87	74.00	-39.13	Peak
3.	2567.000	2.91	27.97	19.08	28.51	21.45	54.00	-32.55	Average
4.	2567.000	2.91	27.97	35.08	28.51	37.45	74.00	-36.55	Peak
5.	3286.200	3.37	29.94	14.82	28.84	19.29	54.00	-34.71	Average
6.	3286.200	3.37	29.94	30.84	28.84	35.31	74.00	-38.69	Peak
7.	3893.800	3.70	31.10	13.40	28.76	19.44	54.00	-34.56	Average
8.	3893.800	3.70	31.10	27.46	28.76	33.50	74.00	-40.50	Peak
9.	4687.400	4.05	32.12	14.69	28.50	22.36	54.00	-31.64	Average
10.	4687.400	4.05	32.12	29.66	28.50	37.33	74.00	-36.67	Peak
11.	5512.000	4.72	33.22	15.61	28.21	25.34	54.00	-28.66	Average
12.	5512.000	4.72	33.22	28.63	28.21	38.36	74.00	-35.64	Peak

9. PHOTOGRAPHS OF THE TEST CONFIGURATION CONDUCTED EMISSION TEST



RADIATED EMISSION TEST (30MHz-1GHz)

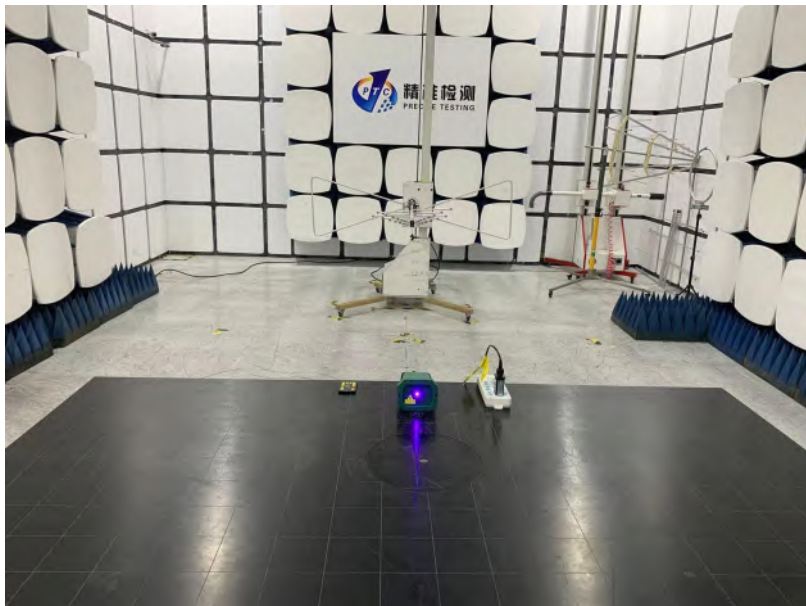



RADIATED EMISSION TEST (1GHz-6GHz)

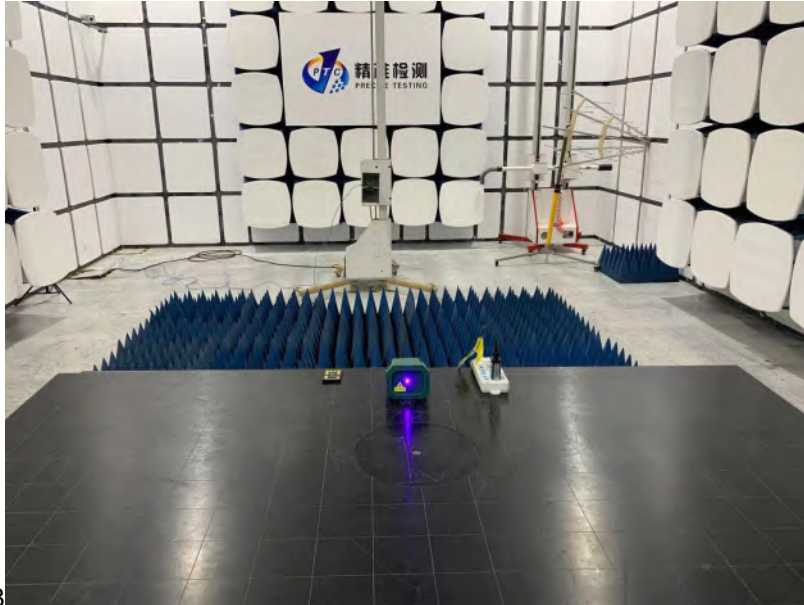

8

10. PHOTOGRAPHS OF EUT

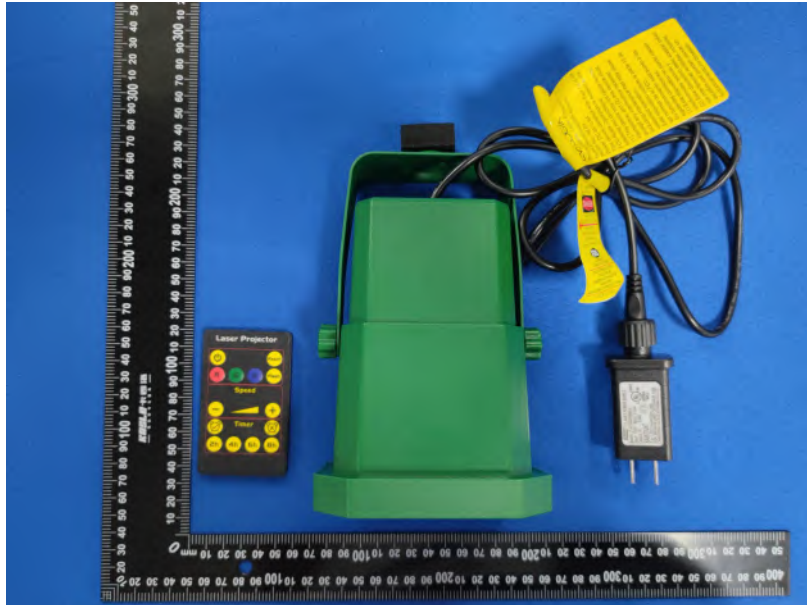





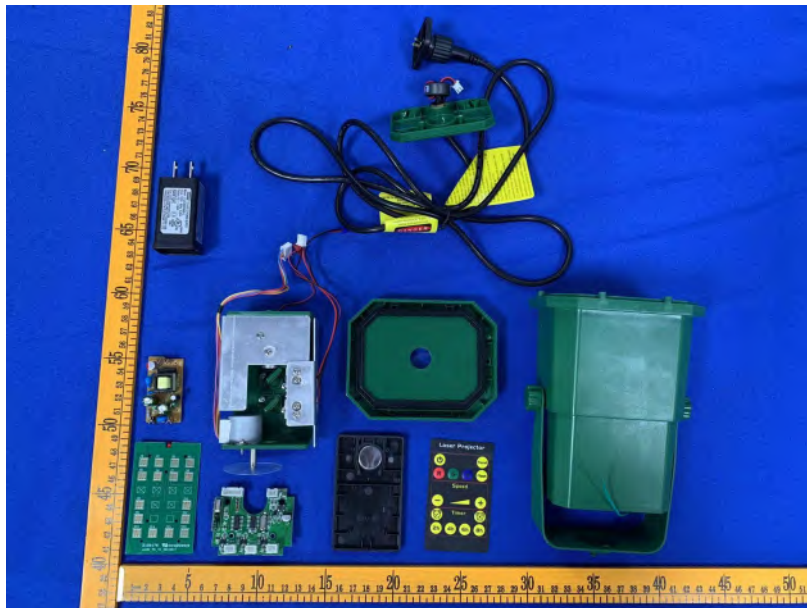



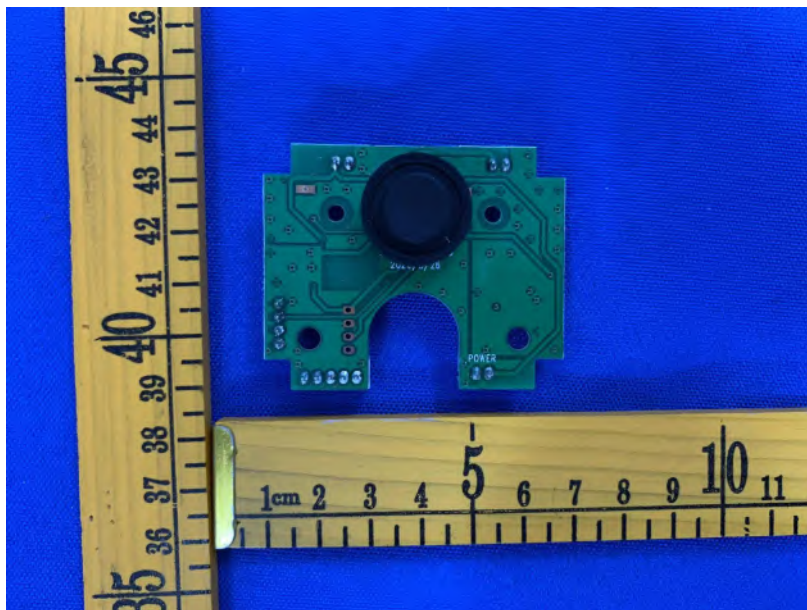

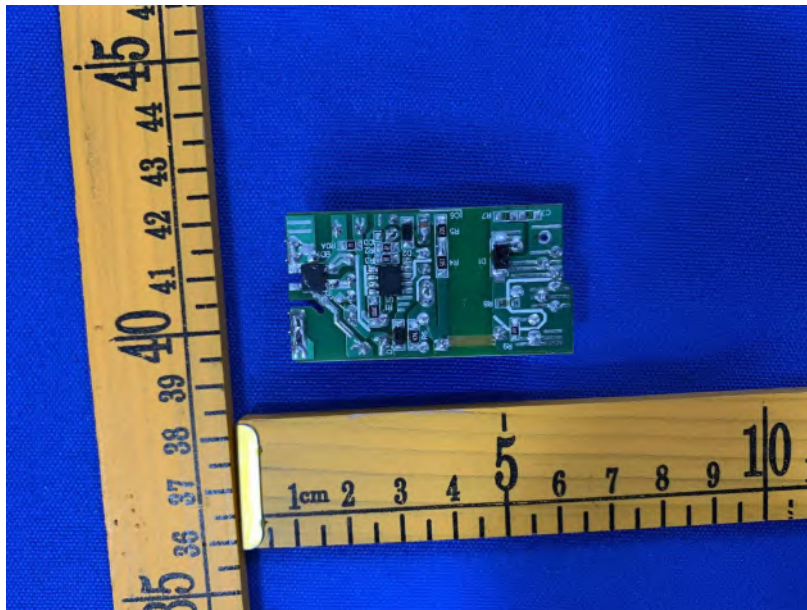
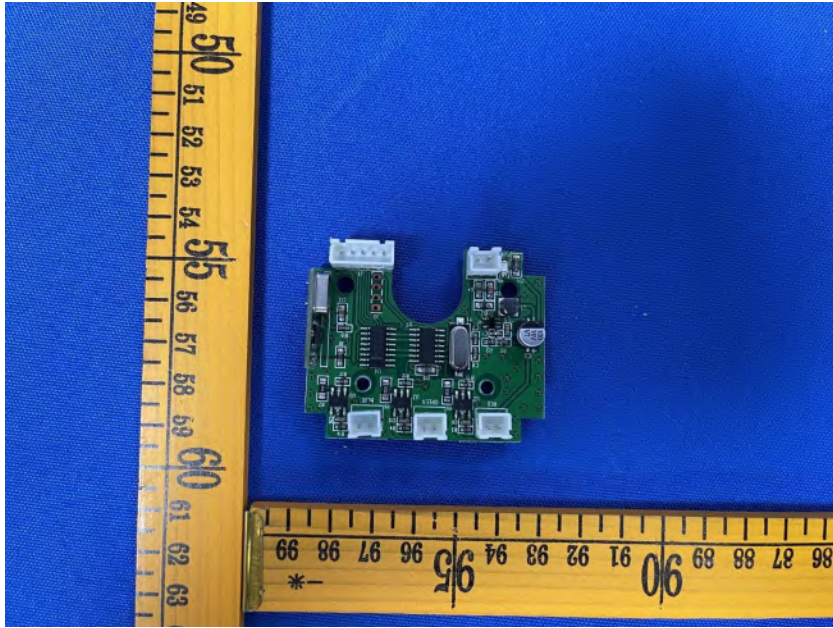

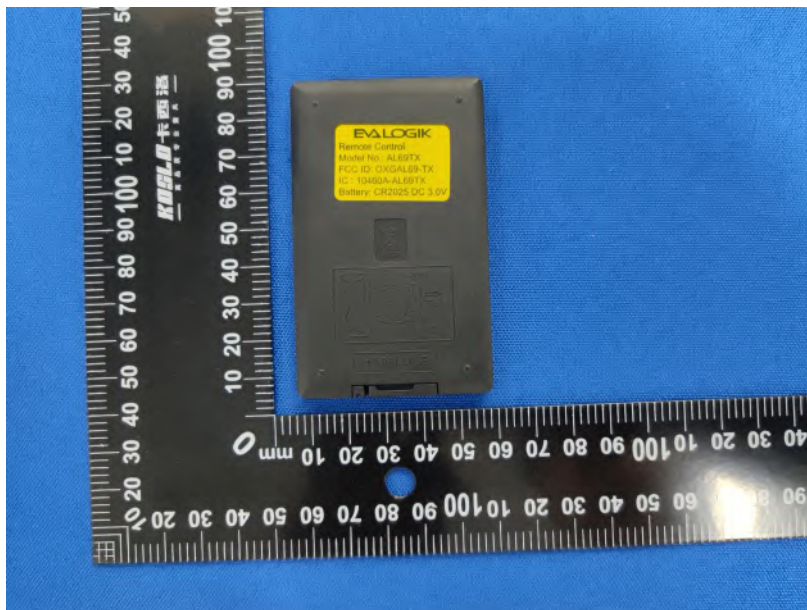
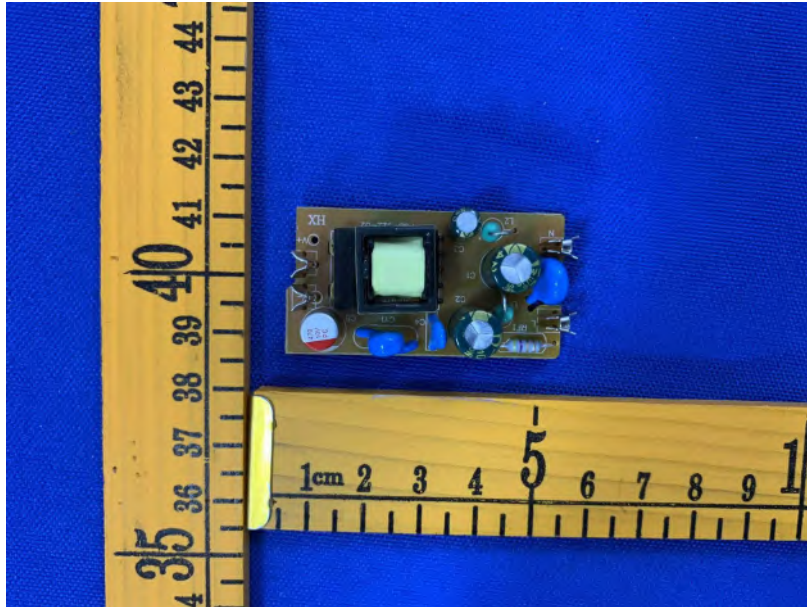

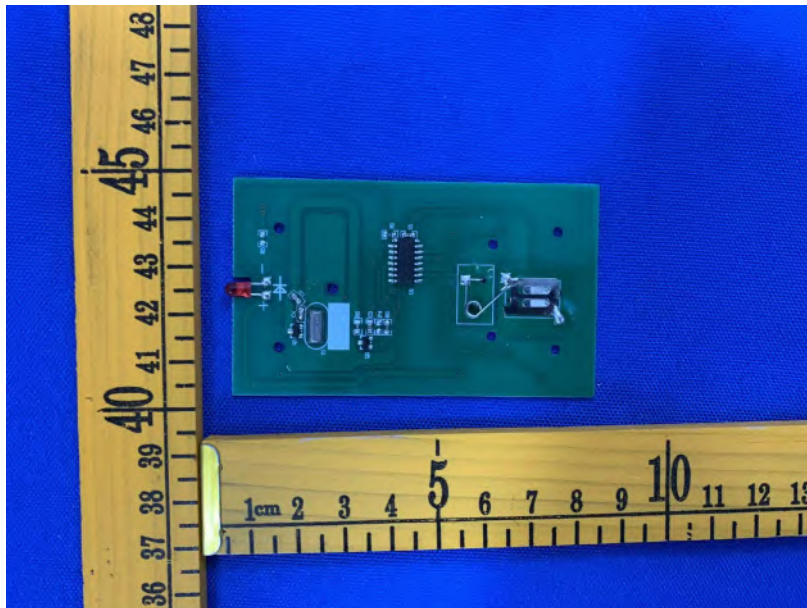
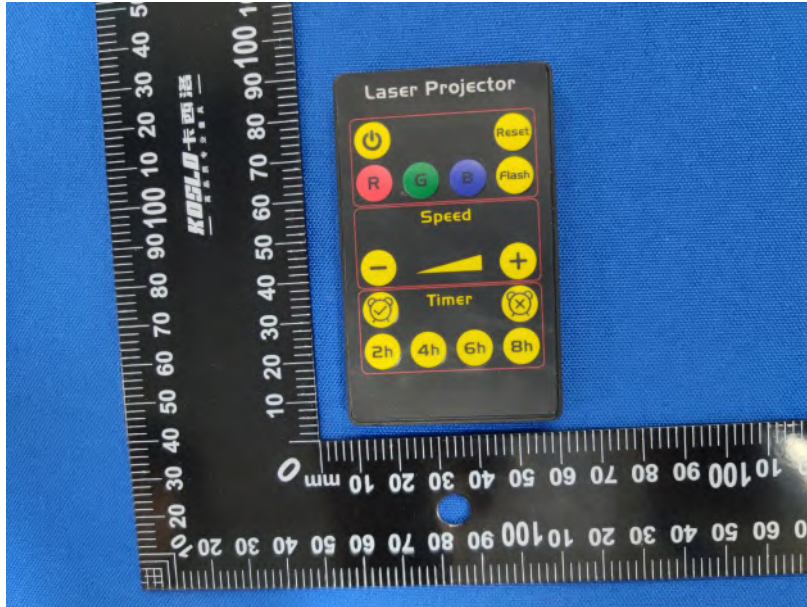



11. LABELING REQUIREMENTS

According to FCC Part 15 Section 15.19, a device subject to certification or Supplier's Declaration of Conformity shall be labelled as follows:

“This device complies with part 15 of the FCC Rules. Operation is subject to the following two conditions: (1) This device may not cause harmful interference, and (2) this device must accept any interference received, including interference that may cause undesired operation.”

The device shall bear the statement in a conspicuous location on the device.

Devices subject to authorization under Supplier's Declaration of Conformity may be labeled with the FCC logo on a voluntary basis as a visual indication that the product complies with the applicable FCC requirements.

Note: The Commission concluded that if the labeling and regulatory information cannot be displayed to the intended recipient “in a manner that effects its purpose,” the device is incapable of digitally displaying the required information as required by the E-LABEL Act. Electronic labeling information must be electronically displayed in a manner that is “clearly legible without the aid of magnification” Similarly, because electronic labels cannot be easily removed or replaced if they are to be effective, manufacturers that choose to display required labeling information electronically must ensure that the information may not be removed or modified by anyone other than the responsible party.



12. INFORMATION TO USER

If a product must be tested and authorized under Supplier's Declaration of Conformity, a compliance information statement shall be supplied with product at the time of marketing or importation, containing the following information:

- (1) Identification of the product, e.g., name and model number;
- (2) A compliance statement as applicable, e.g., for devices subject to part 15 of this chapter as specified in 15.19(a)(3) of this chapter, that the product complies with the rules; and
- (3) The identification, by name, address and telephone number or Internet contact information, of the responsible party. The responsible party for Supplier's Declaration of Conformity must be located within the United States.

According to FCC Part 15 section 15.21, the users manual or instruction manual for an intentional or unintentional radiator shall caution the user that:

“Changes or modifications not expressly approved by the party responsible for compliance could void the user's authority to operate the equipment”.

Also, refer to FCC Part 15 section 15.105, the instructions furnished the user shall include the following or similar statement, placed in a prominent location in the text of the manual:

“Note: This equipment has been tested and found to comply with the limits for a Class B digital device, pursuant to part 15 of the FCC Rules. These limits are designed to provide reasonable protection against harmful interference in a residential installation. This equipment generates uses and can radiate radio frequency energy and, if not installed and used in accordance with the instructions, may cause harmful interference to radio communications. However, there is no guarantee that interference will not occur in a particular installation. If this equipment does cause harmful interference to radio or television reception, which can be determined by turning the equipment off and on, the user is encouraged to try to correct the interference by one or more of the following measures:

- Reorient or relocate the receiving antenna.**
- Increase the separation between the equipment and receiver.**
- Connect the equipment into an outlet on a circuit different from that to which the receiver is connected.**
- Consult the dealer or an experienced radio/TV technician for help.”**

*******THE END REPORT*******