

11. Radiated Band Edge Compliance

11.1. Block diagram of test setup

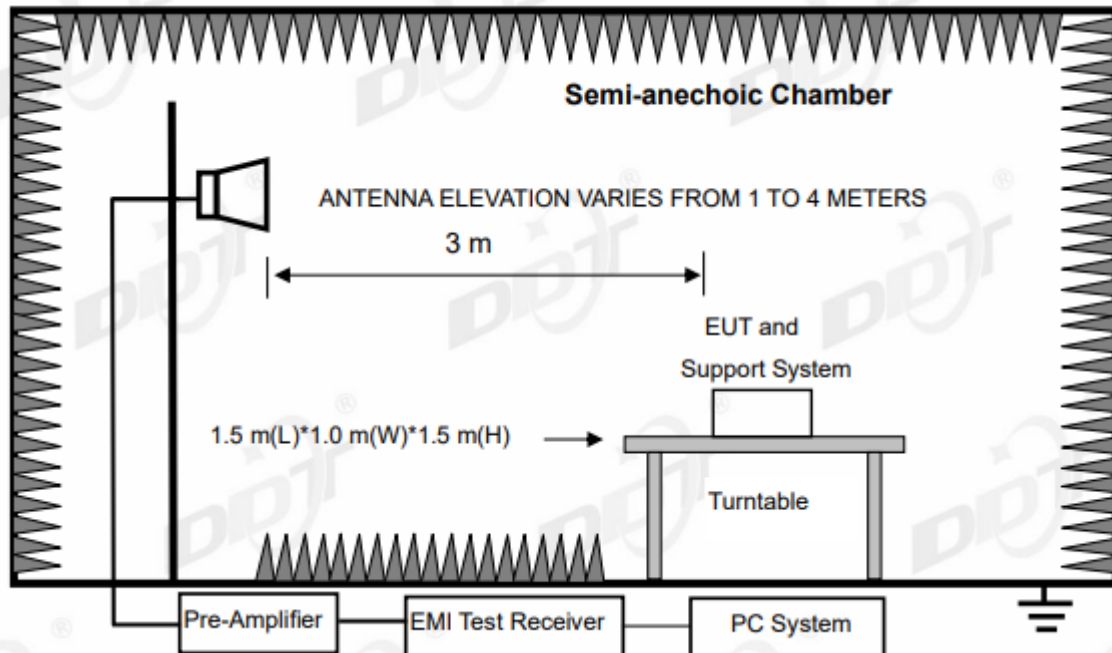

11.2. Limit

All restricted frequency bands shall not exceed the limits shown in 15.209, all the other emissions outside operation frequency band 2400 MHz to 2483.5 MHz shall be at least 20dB below the fundamental emissions or comply with 15.209 limits.

11.3. Test procedure

Same with Radiated Spurious Emissions except change investigated frequency range from 2310 MHz to 2430 MHz and 2445 MHz to 2500 MHz.

11.4. Test result

Pass. (See below detailed test result)

TR-4-E-009 Radiated Emission Test Result

Test Date: 2023-04-10 **Tested By:** Bairong
EUT: Smart Light Switch **Model Number:** 50367
Test Mode: Tx mode **Power Supply:** AC 120V/60HZ
Condition: Temp:22.2°C;Humi:54.0% **Test Site:** DDT 3# Chamber
File Path: d:\ts\2023 report data\Q23030729-2E 50367\IC ABOVE 1G 2.4GWIFI\35
Memo: 11B 2412

Test Graph

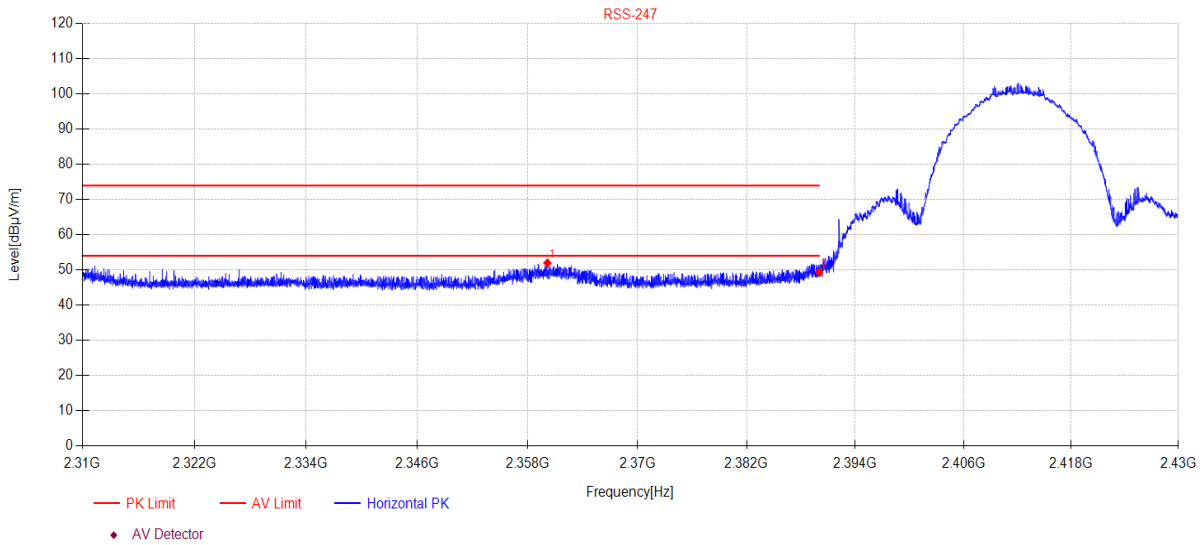

Suspected Data List										
NO	Freq. [MHz]	Reading [dBµV]	Cable Loss [dB]	Antenna Factor [dB]	AMP [dB]	Level [dBµV/m]	Limit [dBµV/m]	Margin [dB]	Detector	Polarity
1	2360.18	50.88	3.75	27.42	-30.10	51.95	74.00	22.05	PK	Horizontal
2	2390.00	48.24	3.78	27.48	-30.13	49.37	74.00	24.63	PK	Horizontal

Note:

1. Level = Reading + Cable Loss + Antenna Factor + AMP
2. If Peak Result complies with AV limit, AV Result is deemed to comply with AV limit.
3. Test setup: RBW: 1 MHz, VBW: 3 MHz, Sweep time: auto.

TR-4-E-009 Radiated Emission Test Result

Test Date: 2023-04-10 **Tested By:** Bairong
EUT: Smart Light Switch **Model Number:** 50367
Test Mode: Tx mode **Power Supply:** AC 120V/60HZ
Condition: Temp:22.2°C;Humi:54.0% **Test Site:** DDT 3# Chamber
File Path: d:\ts\2023 report data\Q23030729-2E 50367\IC ABOVE 1G 2.4GWIFI\36
Memo: 11B 2412

Test Graph

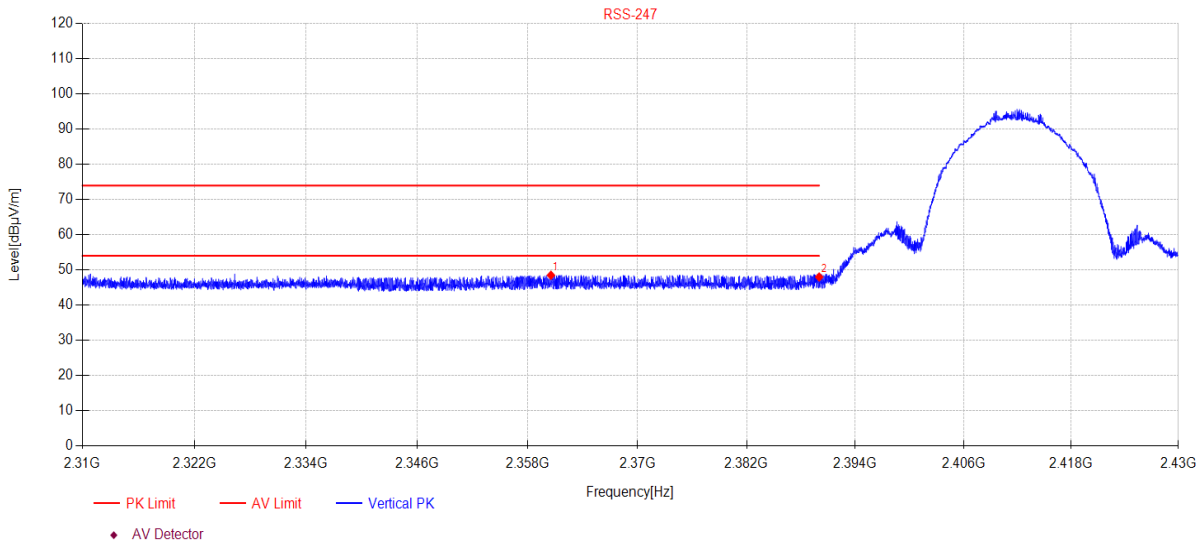

Suspected Data List										
NO	Freq. [MHz]	Reading [dBµV]	Cable Loss [dB]	Antenna Factor [dB]	AMP [dB]	Level [dBµV/m]	Limit [dBµV/m]	Margin [dB]	Detector	Polarity
1	2360.57	47.41	3.75	27.42	-30.10	48.48	74.00	25.52	PK	Vertical
2	2390.00	46.85	3.78	27.48	-30.13	47.98	74.00	26.02	PK	Vertical

Note:

1. Level = Reading + Cable Loss + Antenna Factor + AMP
2. If Peak Result complies with AV limit, AV Result is deemed to comply with AV limit.
3. Test setup: RBW: 1 MHz, VBW: 3 MHz, Sweep time: auto.

TR-4-E-009 Radiated Emission Test Result

Test Date: 2023-04-10 **Tested By:** Bairong
EUT: Smart Light Switch **Model Number:** 50367
Test Mode: Tx mode **Power Supply:** AC 120V/60HZ
Condition: Temp:22.2°C;Humi:54.0% **Test Site:** DDT 3# Chamber
File Path: d:\ts\2023 report data\Q23030729-2E 50367\IC ABOVE 1G 2.4GWIFI49
Memo: 11B 2462

Test Graph

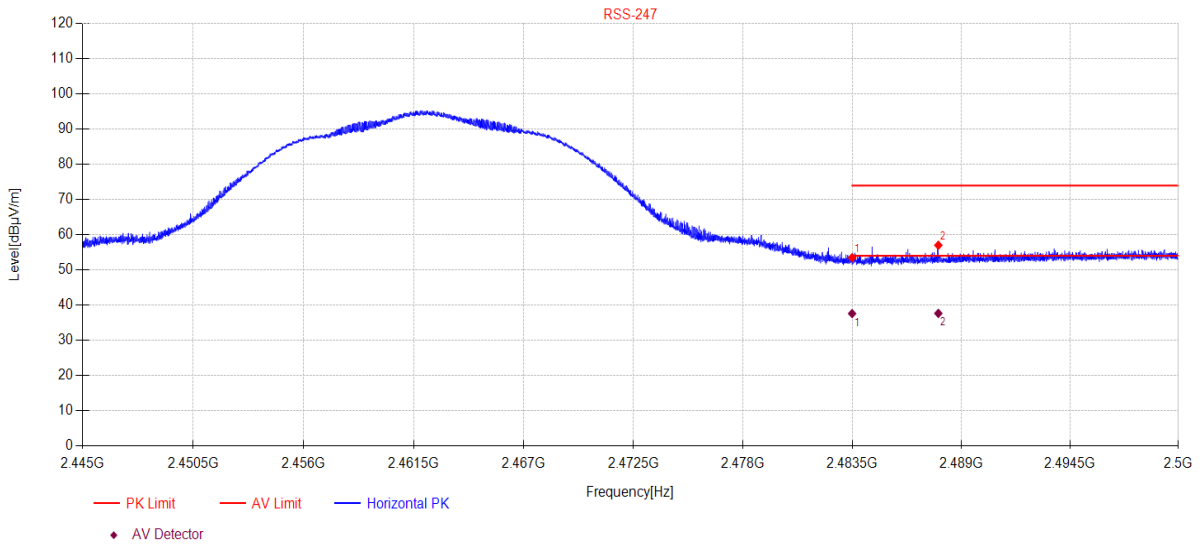

Suspected Data List										
NO.	Freq. [MHz]	Reading [dBµV]	Cable Loss [dB]	Antenna Factor [dB]	AMP [dB]	Level [dBµV/m]	Limit [dBµV/m]	Margin [dB]	Detector	Polarity
1	2483.50	52.11	3.88	27.73	-30.23	53.49	74.00	20.51	PK	Horizontal
2	2487.85	55.62	3.88	27.75	-30.24	57.01	74.00	16.99	PK	Horizontal

Final Data List										
NO.	Freq. [MHz]	Reading [dBµV/m]	Cable Loss [dB]	Antenna Factor [dB]	AMP [dB]	Level [dBµV/m]	Limit [dBµV/m]	Margin [dB]	Detector	Polarity
1	2483.50	36.21	3.88	27.73	-30.23	37.59	54.00	16.41	AV	Horizontal
2	2487.85	36.25	3.88	27.75	-30.24	37.64	54.00	16.36	AV	Horizontal

Note:

1. Level = Reading + Cable Loss + Antenna Factor + AMP
2. If Peak Result complies with AV limit, AV Result is deemed to comply with AV limit.
3. Test setup: RBW: 1 MHz, VBW: 3 MHz, Sweep time: auto.

TR-4-E-009 Radiated Emission Test Result

Test Date: 2023-04-10 **Tested By:** Bairong
EUT: Smart Light Switch **Model Number:** 50367
Test Mode: Tx mode **Power Supply:** AC 120V/60HZ
Condition: Temp:22.2°C;Humi:54.0% **Test Site:** DDT 3# Chamber
File Path: d:\ts\2023 report data\Q23030729-2E 50367\IC ABOVE 1G 2.4GWIFI\50
Memo: 11B 2462

Test Graph

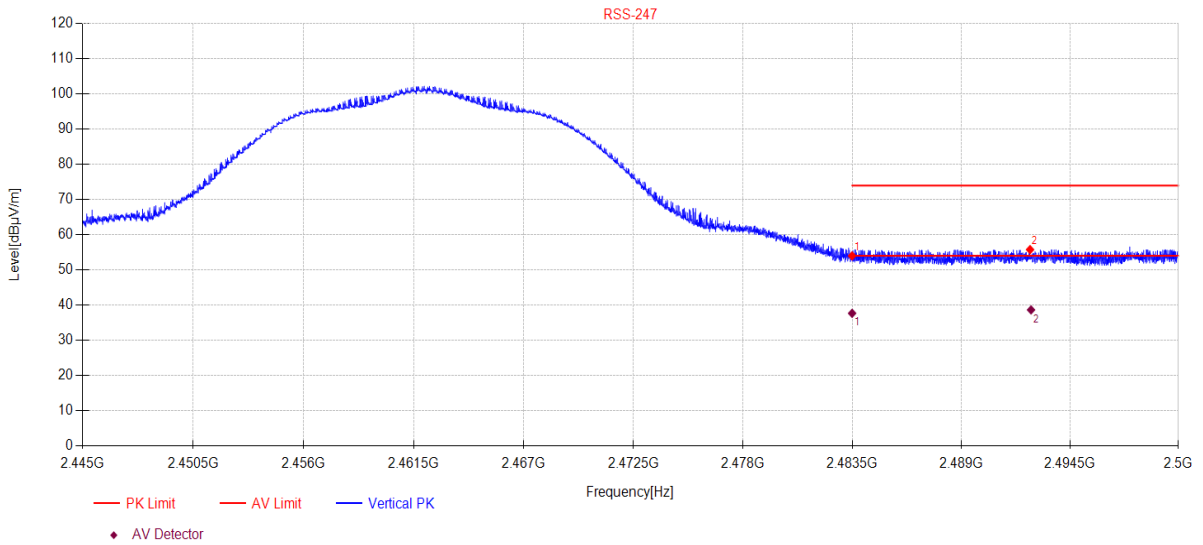

Suspected Data List										
NO.	Freq. [MHz]	Reading [dBµV]	Cable Loss [dB]	Antenna Factor [dB]	AMP [dB]	Level [dBµV/m]	Limit [dBµV/m]	Margin [dB]	Detector	Polarity
1	2483.50	52.62	3.88	27.73	-30.23	54.00	74.00	20.00	PK	Vertical
2	2492.49	54.35	3.89	27.77	-30.24	55.77	74.00	18.23	PK	Vertical

Final Data List										
NO.	Freq. [MHz]	Reading [dBµV/m]	Cable Loss [dB]	Antenna Factor [dB]	AMP [dB]	Level [dBµV/m]	Limit [dBµV/m]	Margin [dB]	Detector	Polarity
1	2483.50	36.29	3.88	27.73	-30.23	37.67	54.00	16.33	AV	Vertical
2	2492.54	36.32	4.78	27.77	-30.24	38.63	54.00	15.37	AV	Vertical

Note:

1. Level = Reading + Cable Loss + Antenna Factor + AMP
2. If Peak Result complies with AV limit, AV Result is deemed to comply with AV limit.
3. Test setup: RBW: 1 MHz, VBW: 3 MHz, Sweep time: auto.

TR-4-E-009 Radiated Emission Test Result

Test Date: 2023-04-10 **Tested By:** Bairong
EUT: Smart Light Switch **Model Number:** 50367
Test Mode: Tx mode **Power Supply:** AC 120V/60HZ
Condition: Temp:22.2°C;Humi:54.0% **Test Site:** DDT 3# Chamber
File Path: d:\ts\2023 report data\Q23030729-2E 50367\IC ABOVE 1G 2.4GWIFI\37
Memo: 11G 2412

Test Graph

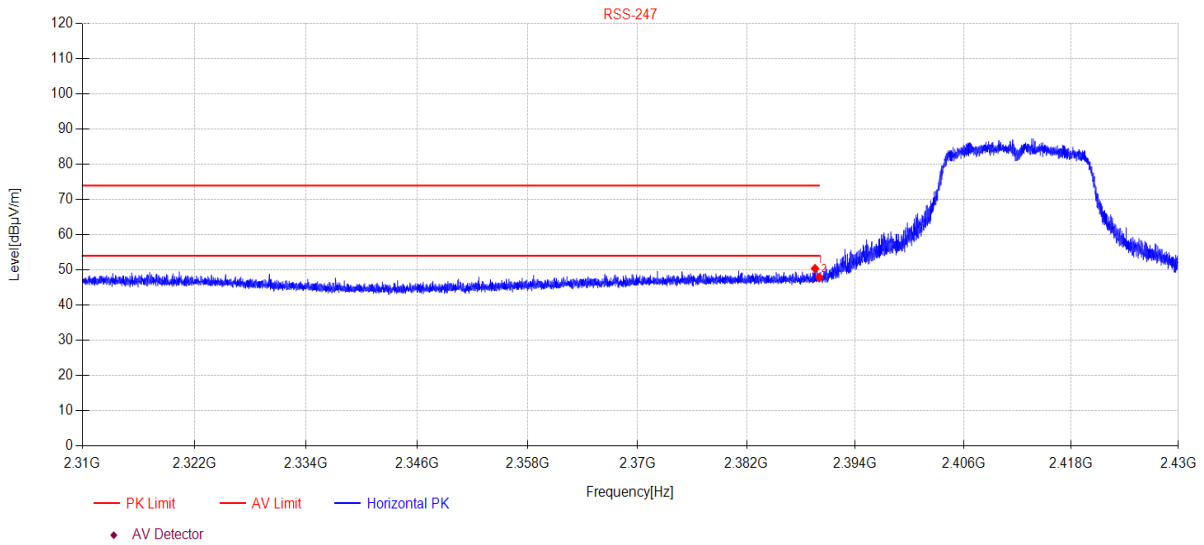

Suspected Data List										
NO	Freq. [MHz]	Reading [dBµV]	Cable Loss [dB]	Antenna Factor [dB]	AMP [dB]	Level [dBµV/m]	Limit [dBµV/m]	Margin [dB]	Detector	Polarity
1	2389.55	49.26	3.78	27.48	-30.13	50.39	74.00	23.61	PK	Horizontal
2	2390.00	46.79	3.78	27.48	-30.13	47.92	74.00	26.08	PK	Horizontal

Note:

1. Level = Reading + Cable Loss + Antenna Factor + AMP
2. If Peak Result complies with AV limit, AV Result is deemed to comply with AV limit.
3. Test setup: RBW: 1 MHz, VBW: 3 MHz, Sweep time: auto.

TR-4-E-009 Radiated Emission Test Result

Test Date: 2023-04-10 **Tested By:** Bairong
EUT: Smart Light Switch **Model Number:** 50367
Test Mode: Tx mode **Power Supply:** AC 120V/60HZ
Condition: Temp:22.2°C;Humi:54.0% **Test Site:** DDT 3# Chamber
File Path: d:\ts\2023 report data\Q23030729-2E 50367\IC ABOVE 1G 2.4GWIFI\38
Memo: 11G 2412

Test Graph

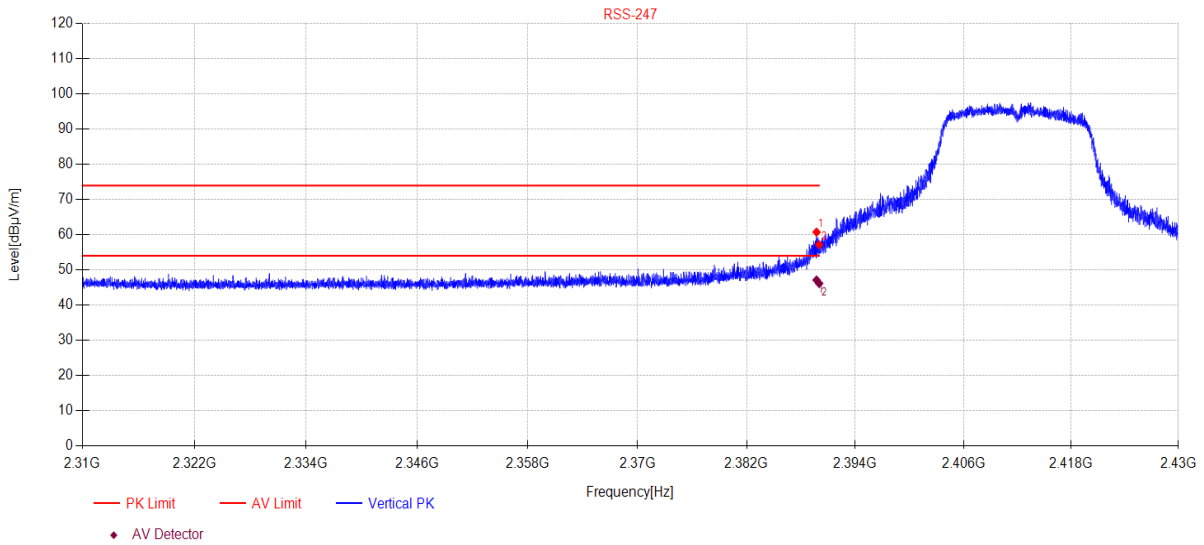

Suspected Data List										
NO	Freq. [MHz]	Reading [dBµV]	Cable Loss [dB]	Antenna Factor [dB]	AMP [dB]	Level [dBµV/m]	Limit [dBµV/m]	Margin [dB]	Detector	Polarity
1	2389.72	59.61	3.78	27.48	-30.13	60.74	74.00	13.26	PK	Vertical
2	2390.00	56.05	3.78	27.48	-30.13	57.18	74.00	16.82	PK	Vertical

Final Data List										
NO	Freq. [MHz]	Reading [dBµV/m]	Cable Loss [dB]	Antenna Factor [dB]	AMP [dB]	Level [dBµV/m]	Limit [dBµV/m]	Margin [dB]	Detector	Polarity
1	2389.72	45.06	3.78	27.48	-30.13	47.11	54.00	6.89	AV	Vertical
2	2390.00	45.03	3.78	27.48	-30.13	46.16	54.00	7.84	AV	Vertical

Note:

1. Level = Reading + Cable Loss + Antenna Factor + AMP
2. If Peak Result complies with AV limit, AV Result is deemed to comply with AV limit.
3. Test setup: RBW: 1 MHz, VBW: 3 MHz, Sweep time: auto.

TR-4-E-009 Radiated Emission Test Result

Test Date: 2023-04-10 **Tested By:** Bairong
EUT: Smart Light Switch **Model Number:** 50367
Test Mode: Tx mode **Power Supply:** AC 120V/60HZ
Condition: Temp:22.2°C;Humi:54.0% **Test Site:** DDT 3# Chamber
File Path: d:\ts\2023 report data\Q23030729-2E 50367\IC ABOVE 1G 2.4GWIFI\51
Memo: 11G 2462

Test Graph

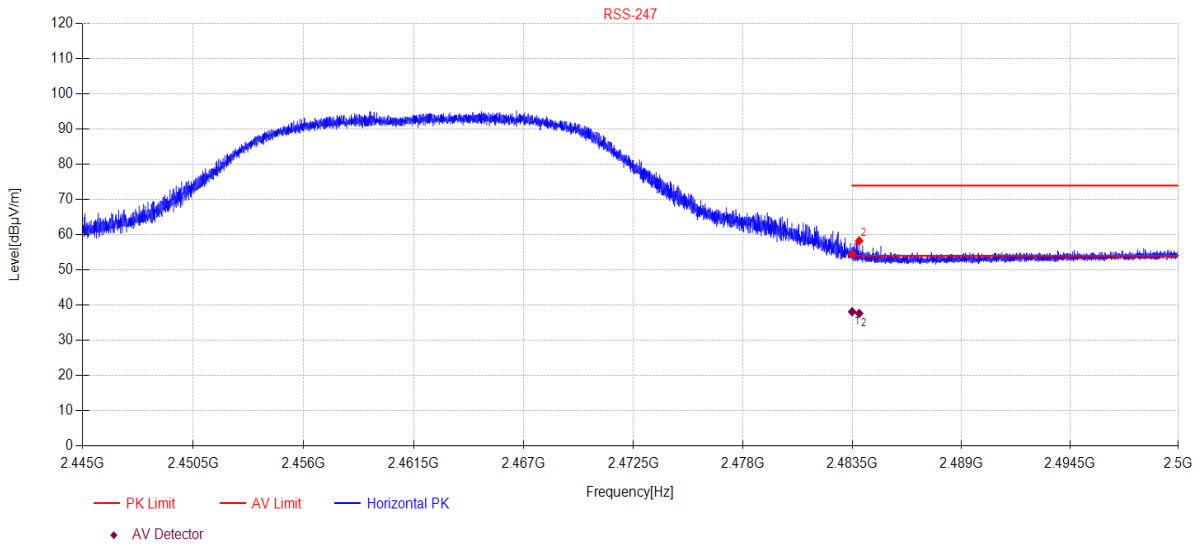

Suspected Data List										
NO.	Freq. [MHz]	Reading [dBµV]	Cable Loss [dB]	Antenna Factor [dB]	AMP [dB]	Level [dBµV/m]	Limit [dBµV/m]	Margin [dB]	Detector	Polarity
1	2483.50	53.03	3.88	27.73	-30.23	54.41	74.00	19.59	PK	Horizontal
2	2483.86	56.88	3.88	27.74	-30.23	58.27	74.00	15.73	PK	Horizontal

Final Data List										
NO.	Freq. [MHz]	Reading [dBµV/m]	Cable Loss [dB]	Antenna Factor [dB]	AMP [dB]	Level [dBµV/m]	Limit [dBµV/m]	Margin [dB]	Detector	Polarity
1	2483.50	36.74	3.88	27.73	-30.23	38.12	54.00	15.88	AV	Horizontal
2	2483.86	36.24	3.88	27.74	-30.23	37.63	54.00	16.37	AV	Horizontal

Note:

- Level = Reading + Cable Loss + Antenna Factor + AMP
- If Peak Result complies with AV limit, AV Result is deemed to comply with AV limit.
- Test setup: RBW: 1 MHz, VBW: 3 MHz, Sweep time: auto.

TR-4-E-009 Radiated Emission Test Result

Test Date: 2023-04-10 **Tested By:** Bairong
EUT: Smart Light Switch **Model Number:** 50367
Test Mode: Tx mode **Power Supply:** AC 120V/60HZ
Condition: Temp:22.2°C;Humi:54.0% **Test Site:** DDT 3# Chamber
File Path: d:\ts\2023 report data\Q23030729-2E 50367\IC ABOVE 1G 2.4GWIFI\52
Memo: 11G 2462

Test Graph

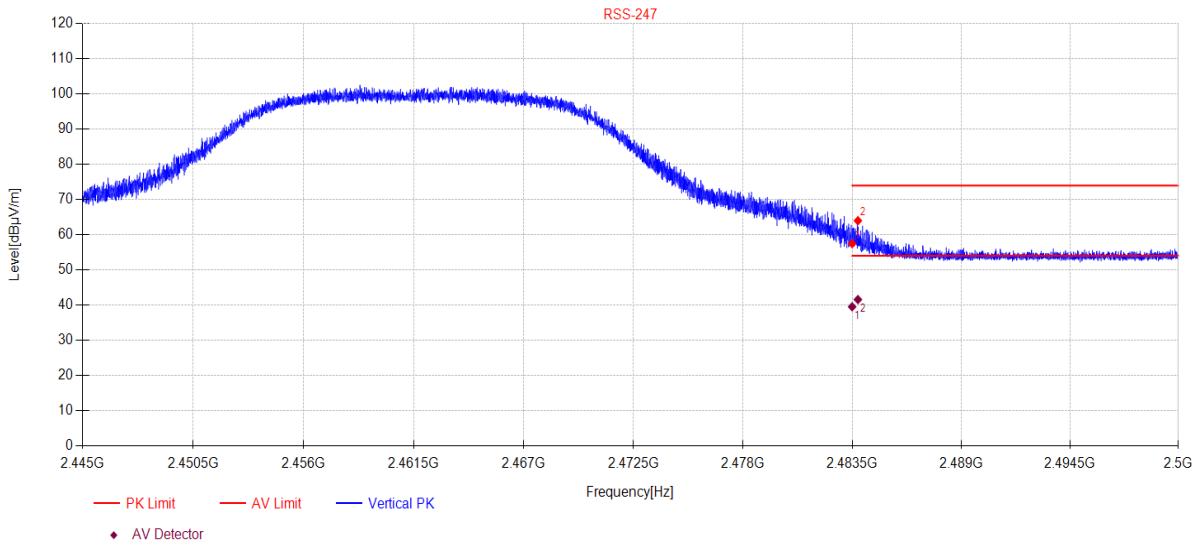

Suspected Data List										
NO.	Freq. [MHz]	Reading [dBµV]	Cable Loss [dB]	Antenna Factor [dB]	AMP [dB]	Level [dBµV/m]	Limit [dBµV/m]	Margin [dB]	Detector	Polarity
1	2483.50	56.11	3.88	27.73	-30.23	57.49	74.00	16.51	PK	Vertical
2	2483.79	62.60	3.88	27.74	-30.23	63.99	74.00	10.01	PK	Vertical

Final Data List										
NO.	Freq. [MHz]	Reading [dBµV/m]	Cable Loss [dB]	Antenna Factor [dB]	AMP [dB]	Level [dBµV/m]	Limit [dBµV/m]	Margin [dB]	Detector	Polarity
1	2483.50	38.14	3.88	27.73	-30.23	39.52	54.00	14.48	AV	Vertical
2	2483.79	39.28	3.88	27.74	-30.23	41.57	54.00	12.43	AV	Vertical

Note:

1. Level = Reading + Cable Loss + Antenna Factor + AMP
2. If Peak Result complies with AV limit, AV Result is deemed to comply with AV limit.
3. Test setup: RBW: 1 MHz, VBW: 3 MHz, Sweep time: auto.

TR-4-E-009 Radiated Emission Test Result

Test Date: 2023-04-10 **Tested By:** Bairong
EUT: Smart Light Switch **Model Number:** 50367
Test Mode: Tx mode **Power Supply:** AC 120V/60HZ
Condition: Temp:22.2°C;Humi:54.0% **Test Site:** DDT 3# Chamber
File Path: d:\ts\2023 report data\Q23030729-2E 50367\IC ABOVE 1G 2.4GWIFI\39
Memo: 11N20 2412

Test Graph

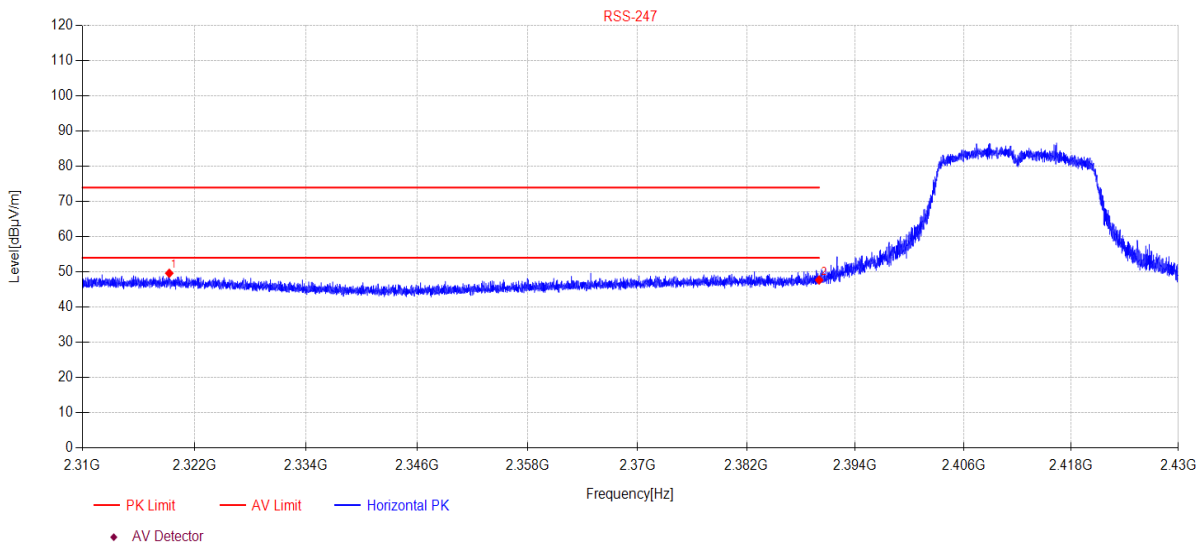

Suspected Data List										
NO	Freq. [MHz]	Reading [dBµV]	Cable Loss [dB]	Antenna Factor [dB]	AMP [dB]	Level [dBµV/m]	Limit [dBµV/m]	Margin [dB]	Detector	Polarity
1	2319.30	48.62	3.71	27.34	-30.05	49.62	74.00	24.38	PK	Horizontal
2	2390.00	46.55	3.78	27.48	-30.13	47.68	74.00	26.32	PK	Horizontal

Note:

1. Level = Reading + Cable Loss + Antenna Factor + AMP
2. If Peak Result complies with AV limit, AV Result is deemed to comply with AV limit.
3. Test setup: RBW: 1 MHz, VBW: 3 MHz, Sweep time: auto.

TR-4-E-009 Radiated Emission Test Result

Test Date: 2023-04-10 **Tested By:** Bairong
EUT: Smart Light Switch **Model Number:** 50367
Test Mode: Tx mode **Power Supply:** AC 120V/60HZ
Condition: Temp:22.2°C;Humi:54.0% **Test Site:** DDT 3# Chamber
File Path: d:\ts\2023 report data\Q23030729-2E 50367\IC ABOVE 1G 2.4GWIFI40
Memo: 11N20 2412

Test Graph

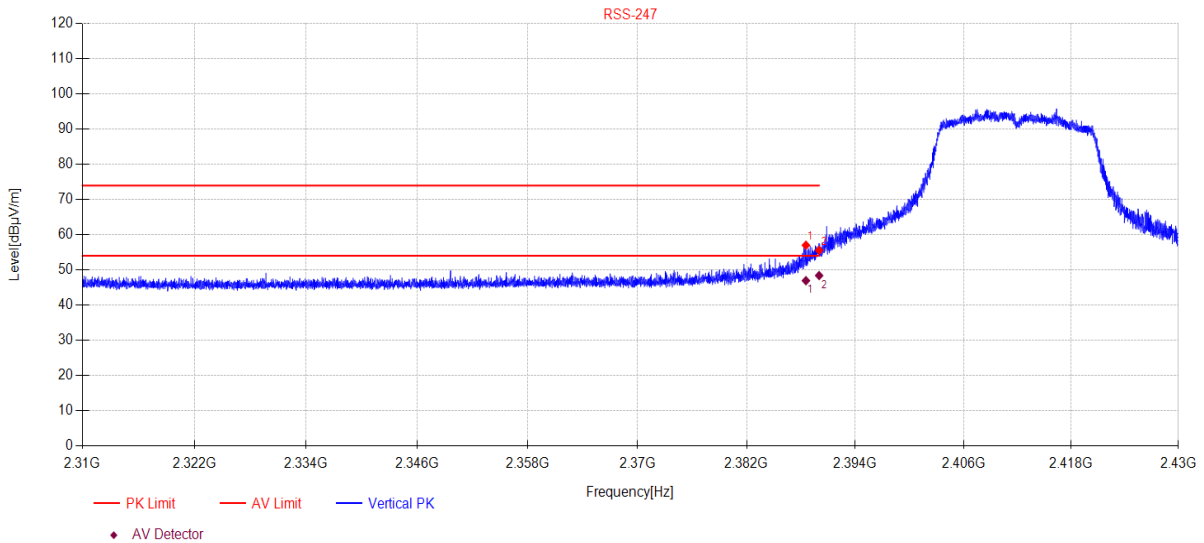

Suspected Data List										
NO	Freq. [MHz]	Reading [dBµV]	Cable Loss [dB]	Antenna Factor [dB]	AMP [dB]	Level [dBµV/m]	Limit [dBµV/m]	Margin [dB]	Detector	Polarity
1	2388.54	55.89	3.78	27.48	-30.13	57.02	74.00	16.98	PK	Vertical
2	2390.00	54.45	3.78	27.48	-30.13	55.58	74.00	18.42	PK	Vertical

Final Data List										
NO	Freq. [MHz]	Reading [dBµV/m]	Cable Loss [dB]	Antenna Factor [dB]	AMP [dB]	Level [dBµV/m]	Limit [dBµV/m]	Margin [dB]	Detector	Polarity
1	2388.54	45.82	3.78	27.48	-30.13	46.95	54.00	7.05	AV	Vertical
2	2390.00	46.34	3.78	27.48	-30.13	48.39	54.00	5.61	AV	Vertical

Note:

1. Level = Reading + Cable Loss + Antenna Factor + AMP
2. If Peak Result complies with AV limit, AV Result is deemed to comply with AV limit.
3. Test setup: RBW: 1 MHz, VBW: 3 MHz, Sweep time: auto.

TR-4-E-009 Radiated Emission Test Result

Test Date: 2023-04-10 **Tested By:** Bairong
EUT: Smart Light Switch **Model Number:** 50367
Test Mode: Tx mode **Power Supply:** AC 120V/60HZ
Condition: Temp:22.2°C;Humi:54.0% **Test Site:** DDT 3# Chamber
File Path: d:\ts\2023 report data\Q23030729-2E 50367\IC ABOVE 1G 2.4GWIFI\53
Memo: 11N20 2462

Test Graph

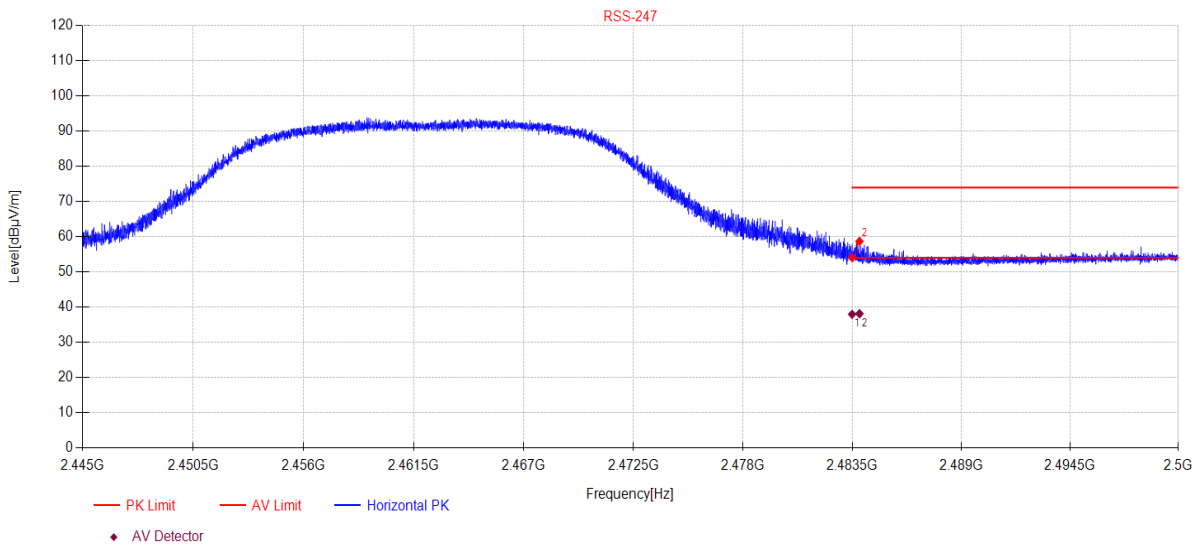

Suspected Data List										
NO.	Freq. [MHz]	Reading [dBµV]	Cable Loss [dB]	Antenna Factor [dB]	AMP [dB]	Level [dBµV/m]	Limit [dBµV/m]	Margin [dB]	Detector	Polarity
1	2483.50	52.69	3.88	27.73	-30.23	54.07	74.00	19.93	PK	Horizontal
2	2483.87	57.30	3.88	27.74	-30.23	58.69	74.00	15.31	PK	Horizontal

Final Data List										
NO.	Freq. [MHz]	Reading [dBµV/m]	Cable Loss [dB]	Antenna Factor [dB]	AMP [dB]	Level [dBµV/m]	Limit [dBµV/m]	Margin [dB]	Detector	Polarity
1	2483.50	36.57	3.88	27.73	-30.23	37.95	54.00	16.05	AV	Horizontal
2	2483.87	36.74	3.88	27.74	-30.23	38.13	54.00	15.87	AV	Horizontal

Note:

1. Level = Reading + Cable Loss + Antenna Factor + AMP
2. If Peak Result complies with AV limit, AV Result is deemed to comply with AV limit.
3. Test setup: RBW: 1 MHz, VBW: 3 MHz, Sweep time: auto.

TR-4-E-009 Radiated Emission Test Result

Test Date: 2023-04-10 **Tested By:** Bairong
EUT: Smart Light Switch **Model Number:** 50367
Test Mode: Tx mode **Power Supply:** AC 120V/60HZ
Condition: Temp:22.2°C;Humi:54.0% **Test Site:** DDT 3# Chamber
File Path: d:\ts\2023 report data\Q23030729-2E 50367\IC ABOVE 1G 2.4GWIFI\54
Memo: 11N20 2462

Test Graph

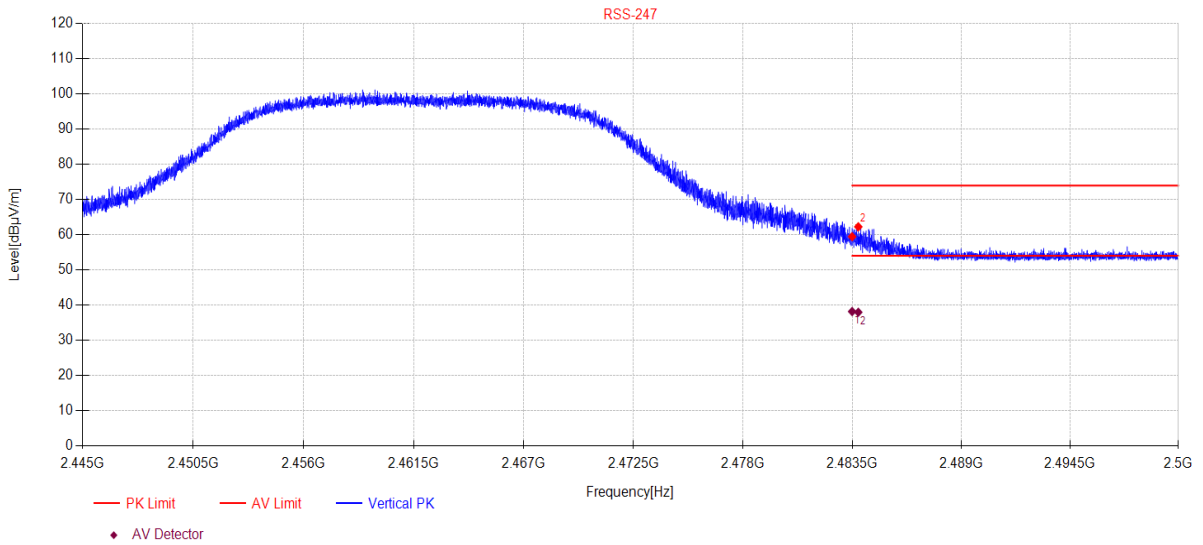

Suspected Data List										
NO.	Freq. [MHz]	Reading [dBµV]	Cable Loss [dB]	Antenna Factor [dB]	AMP [dB]	Level [dBµV/m]	Limit [dBµV/m]	Margin [dB]	Detector	Polarity
1	2483.50	58.08	3.88	27.73	-30.23	59.46	74.00	14.54	PK	Vertical
2	2483.81	60.86	3.88	27.74	-30.23	62.25	74.00	11.75	PK	Vertical

Final Data List										
NO.	Freq. [MHz]	Reading [dBµV/m]	Cable Loss [dB]	Antenna Factor [dB]	AMP [dB]	Level [dBµV/m]	Limit [dBµV/m]	Margin [dB]	Detector	Polarity
1	2483.50	36.79	3.88	27.73	-30.23	38.17	54.00	15.83	AV	Vertical
2	2483.81	36.58	3.88	27.74	-30.23	37.97	54.00	16.03	AV	Vertical

Note:

- Level = Reading + Cable Loss + Antenna Factor + AMP
- If Peak Result complies with AV limit, AV Result is deemed to comply with AV limit.
- Test setup: RBW: 1 MHz, VBW: 3 MHz, Sweep time: auto.

TR-4-E-009 Radiated Emission Test Result

Test Date: 2023-04-10 **Tested By:** Bairong
EUT: Smart Light Switch **Model Number:** 50367
Test Mode: Tx mode **Power Supply:** AC 120V/60HZ
Condition: Temp:22.2°C;Humi:54.0% **Test Site:** DDT 3# Chamber
File Path: d:\ts\2023 report data\Q23030729-2E 50367\IC ABOVE 1G 2.4GWIFI45
Memo: 11N40 2422

Test Graph

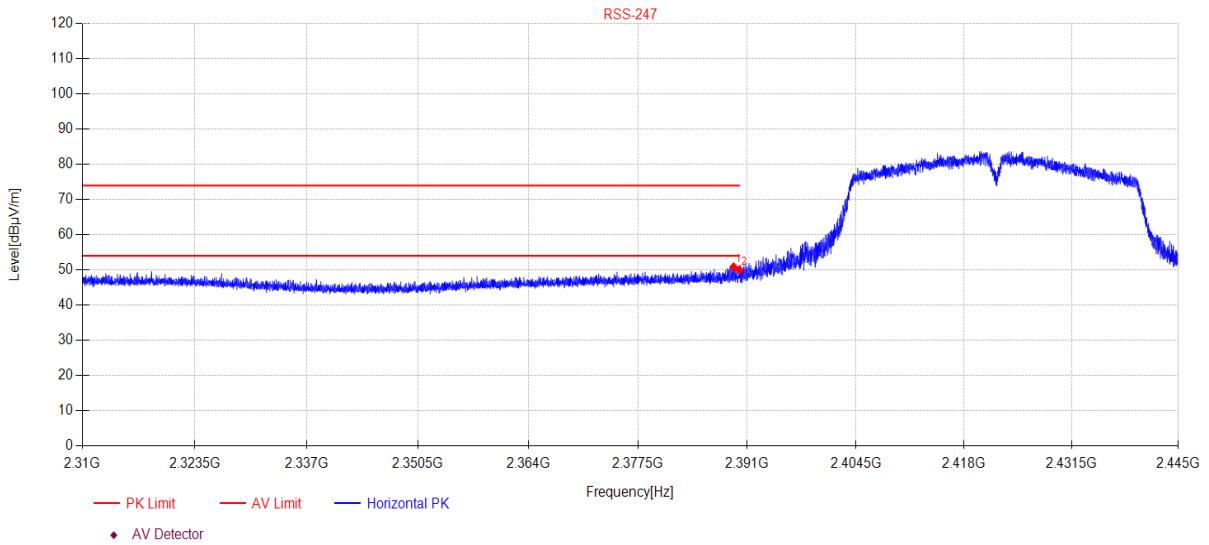

Suspected Data List										
NO.	Freq. [MHz]	Reading [dBμV]	Cable Loss [dB]	Antenna Factor [dB]	AMP [dB]	Level [dBμV/m]	Limit [dBμV/m]	Margin [dB]	Detector	Polarity
1	2389.30	49.71	3.78	27.48	-30.13	50.84	74.00	23.16	PK	Horizontal
2	2390.00	48.85	3.78	27.48	-30.13	49.98	74.00	24.02	PK	Horizontal

Note:

1. Level = Reading + Cable Loss + Antenna Factor + AMP
2. If Peak Result complies with AV limit, AV Result is deemed to comply with AV limit.
3. Test setup: RBW: 1 MHz, VBW: 3 MHz, Sweep time: auto.

TR-4-E-009 Radiated Emission Test Result

Test Date: 2023-04-10 **Tested By:** Bairong
EUT: Smart Light Switch **Model Number:** 50367
Test Mode: Tx mode **Power Supply:** AC 120V/60HZ
Condition: Temp:22.2°C;Humi:54.0% **Test Site:** DDT 3# Chamber
File Path: d:\ts\2023 report data\Q23030729-2E 50367\IC ABOVE 1G 2.4GWIFI46
Memo: 11N40 2422

Test Graph

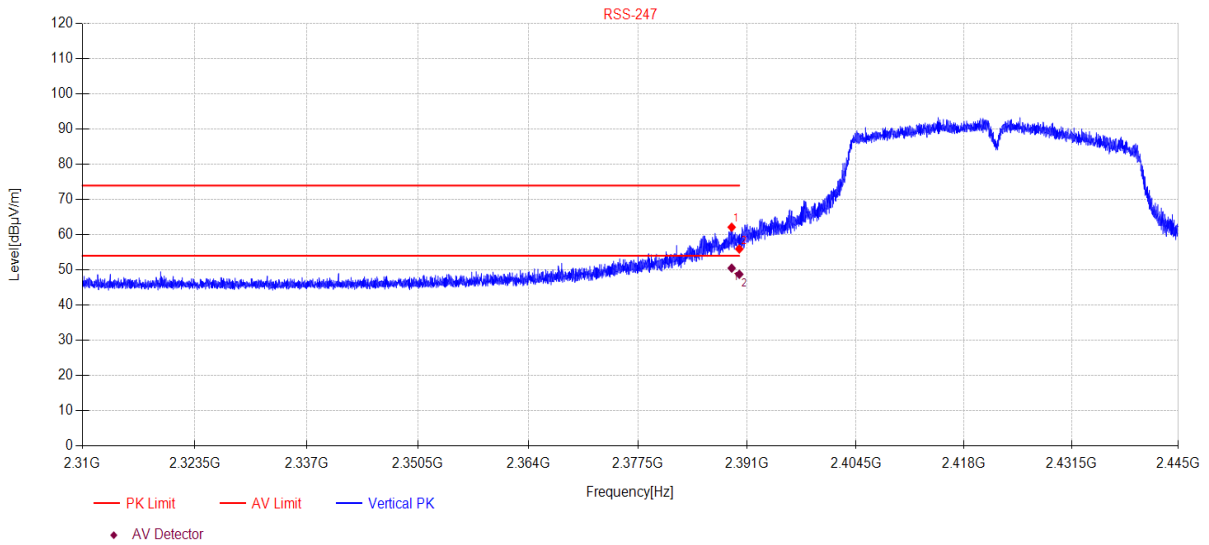

Suspected Data List										
NO.	Freq. [MHz]	Reading [dBμV]	Cable Loss [dB]	Antenna Factor [dB]	AMP [dB]	Level [dBμV/m]	Limit [dBμV/m]	Margin [dB]	Detector	Polarity
1	2389.06	61.01	3.78	27.48	-30.13	62.14	74.00	11.86	PK	Vertical
2	2390.00	54.81	3.78	27.48	-30.13	55.94	74.00	18.06	PK	Vertical

Final Data List										
NO.	Freq. [MHz]	Reading [dBμV/m]	Cable Loss [dB]	Antenna Factor [dB]	AMP [dB]	Level [dBμV/m]	Limit [dBμV/m]	Margin [dB]	Detector	Polarity
1	2389.06	48.44	3.78	27.48	-30.13	50.49	54.00	3.51	AV	Vertical
2	2390.00	47.62	3.78	27.48	-30.13	48.75	54.00	5.25	AV	Vertical

Note:

- Level = Reading + Cable Loss + Antenna Factor + AMP
- If Peak Result complies with AV limit, AV Result is deemed to comply with AV limit.
- Test setup: RBW: 1 MHz, VBW: 3 MHz, Sweep time: auto.

TR-4-E-009 Radiated Emission Test Result

Test Date: 2023-04-10 **Tested By:** Bairong
EUT: Smart Light Switch **Model Number:** 50367
Test Mode: Tx mode **Power Supply:** AC 120V/60HZ
Condition: Temp:22.2°C;Humi:54.0% **Test Site:** DDT 3# Chamber
File Path: d:\ts\2023 report data\Q23030729-2E 50367\IC ABOVE 1G 2.4GWIFI\59
Memo: 11N40 2452

Test Graph

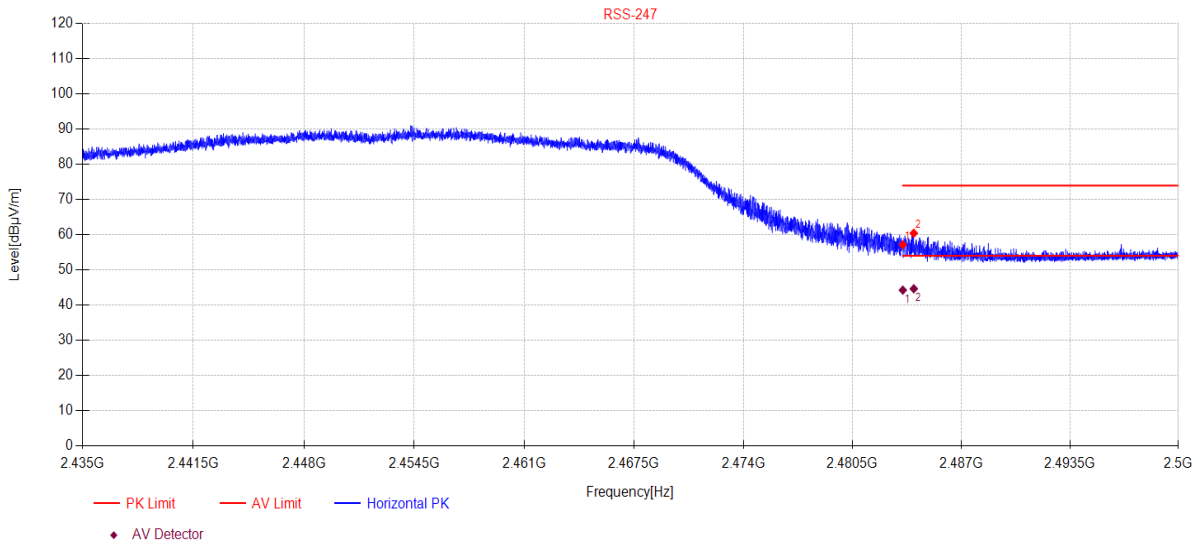

Suspected Data List										
NO.	Freq. [MHz]	Reading [dBµV]	Cable Loss [dB]	Antenna Factor [dB]	AMP [dB]	Level [dBµV/m]	Limit [dBµV/m]	Margin [dB]	Detector	Polarity
1	2483.50	55.77	3.88	27.73	-30.23	57.15	74.00	16.85	PK	Horizontal
2	2484.15	59.04	3.88	27.74	-30.23	60.43	74.00	13.57	PK	Horizontal

Final Data List										
NO.	Freq. [MHz]	Reading [dBµV/m]	Cable Loss [dB]	Antenna Factor [dB]	AMP [dB]	Level [dBµV/m]	Limit [dBµV/m]	Margin [dB]	Detector	Polarity
1	2483.50	42.87	3.88	27.73	-30.23	44.25	54.00	9.75	AV	Horizontal
2	2484.15	43.25	3.88	27.74	-30.23	44.64	54.00	9.36	AV	Horizontal

Note:

1. Level = Reading + Cable Loss + Antenna Factor + AMP
2. If Peak Result complies with AV limit, AV Result is deemed to comply with AV limit.
3. Test setup: RBW: 1 MHz, VBW: 3 MHz, Sweep time: auto.

TR-4-E-009 Radiated Emission Test Result

Test Date: 2023-04-10 **Tested By:** Bairong
EUT: Smart Light Switch **Model Number:** 50367
Test Mode: Tx mode **Power Supply:** AC 120V/60HZ
Condition: Temp:22.2°C;Humi:54.0% **Test Site:** DDT 3# Chamber
File Path: d:\ts\2023 report data\Q23030729-2E 50367\IC ABOVE 1G 2.4GWIFI\60
Memo: 11N40 2452

Test Graph

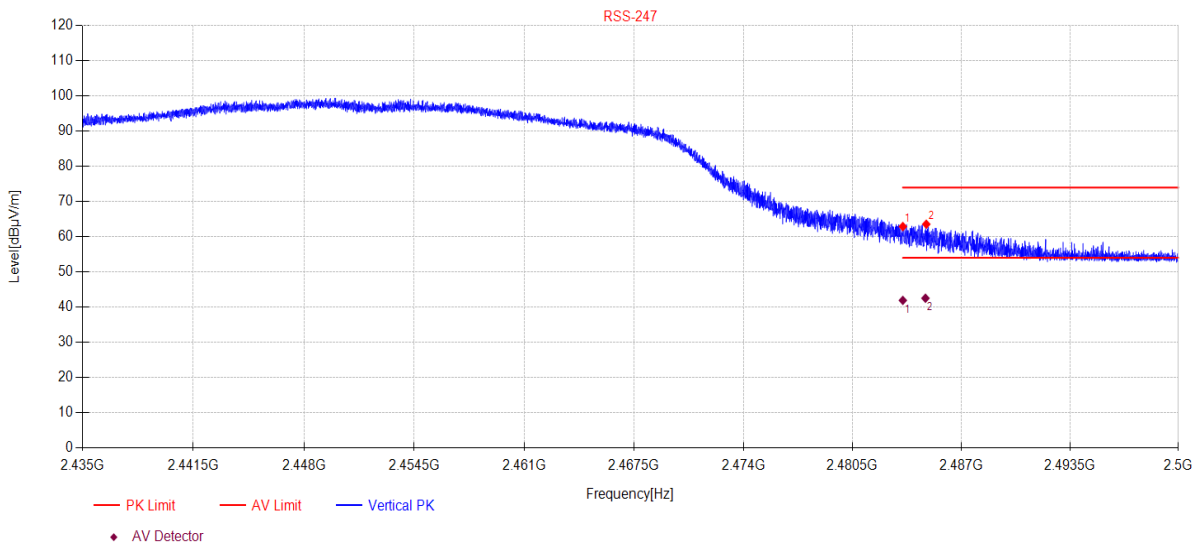

Suspected Data List										
NO.	Freq. [MHz]	Reading [dBµV]	Cable Loss [dB]	Antenna Factor [dB]	AMP [dB]	Level [dBµV/m]	Limit [dBµV/m]	Margin [dB]	Detector	Polarity
1	2483.50	61.52	3.88	27.73	-30.23	62.90	74.00	11.10	PK	Vertical
2	2484.90	62.17	3.88	27.74	-30.23	63.56	74.00	10.44	PK	Vertical

Final Data List										
NO.	Freq. [MHz]	Reading [dBµV/m]	Cable Loss [dB]	Antenna Factor [dB]	AMP [dB]	Level [dBµV/m]	Limit [dBµV/m]	Margin [dB]	Detector	Polarity
1	2483.50	40.52	3.88	27.73	-30.23	41.90	54.00	12.10	AV	Vertical
2	2484.85	40.23	4.78	27.74	-30.23	42.52	54.00	11.48	AV	Vertical

Note:

1. Level = Reading + Cable Loss + Antenna Factor + AMP
2. If Peak Result complies with AV limit, AV Result is deemed to comply with AV limit.
3. Test setup: RBW: 1 MHz, VBW: 3 MHz, Sweep time: auto.

TR-4-E-009 Radiated Emission Test Result

Test Date: 2023-04-10 **Tested By:** Bairong
EUT: Smart Light Switch **Model Number:** 50367
Test Mode: Tx mode **Power Supply:** AC 120V/60HZ
Condition: Temp:22.2°C;Humi:54.0% **Test Site:** DDT 3# Chamber
File Path: d:\ts\2023 report data\Q23030729-2E 50367\IC ABOVE 1G 2.4GWIFI41
Memo: 11AX20 2412

Test Graph

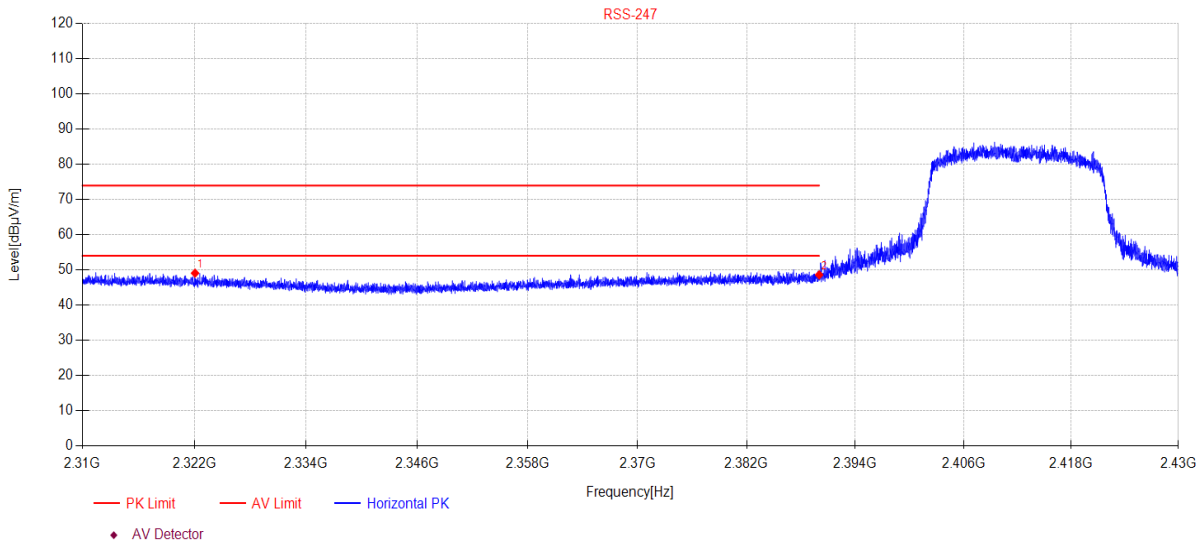

Suspected Data List

NO	Freq. [MHz]	Reading [dBµV]	Cable Loss [dB]	Antenna Factor [dB]	AMP [dB]	Level [dBµV/m]	Limit [dBµV/m]	Margin [dB]	Detector	Polarity
1	2322.06	48.08	3.71	27.34	-30.05	49.08	74.00	24.92	PK	Horizontal
2	2390.00	47.46	3.78	27.48	-30.13	48.59	74.00	25.41	PK	Horizontal

Note:

- Level = Reading + Cable Loss + Antenna Factor + AMP
- If Peak Result complies with AV limit, AV Result is deemed to comply with AV limit.
- Test setup: RBW: 1 MHz, VBW: 3 MHz, Sweep time: auto.

TR-4-E-009 Radiated Emission Test Result

Test Date: 2023-04-10 **Tested By:** Bairong
EUT: Smart Light Switch **Model Number:** 50367
Test Mode: Tx mode **Power Supply:** AC 120V/60HZ
Condition: Temp:22.2°C;Humi:54.0% **Test Site:** DDT 3# Chamber
File Path: d:\ts\2023 report data\Q23030729-2E 50367\IC ABOVE 1G 2.4GWIFI42
Memo: 11AX20 2412

Test Graph

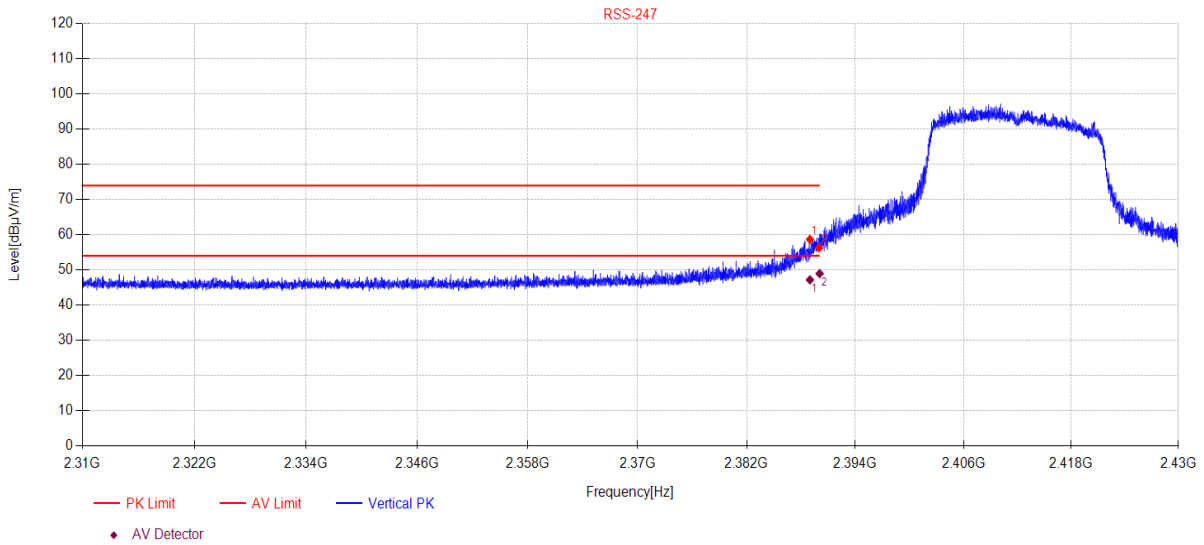

Suspected Data List										
NO	Freq. [MHz]	Reading [dBµV]	Cable Loss [dB]	Antenna Factor [dB]	AMP [dB]	Level [dBµV/m]	Limit [dBµV/m]	Margin [dB]	Detector	Polarity
1	2388.98	57.57	3.78	27.48	-30.13	58.70	74.00	15.30	PK	Vertical
2	2390.00	55.18	3.78	27.48	-30.13	56.31	74.00	17.69	PK	Vertical

Final Data List										
NO	Freq. [MHz]	Reading [dBµV/m]	Cable Loss [dB]	Antenna Factor [dB]	AMP [dB]	Level [dBµV/m]	Limit [dBµV/m]	Margin [dB]	Detector	Polarity
1	2388.98	46.04	3.78	27.48	-30.13	47.17	54.00	6.83	AV	Vertical
2	2390.05	46.89	4.70	27.48	-30.13	48.94	51.97	3.03	AV	Vertical

Note:

1. Level = Reading + Cable Loss + Antenna Factor + AMP
2. If Peak Result complies with AV limit, AV Result is deemed to comply with AV limit.
3. Test setup: RBW: 1 MHz, VBW: 3 MHz, Sweep time: auto.

TR-4-E-009 Radiated Emission Test Result

Test Date: 2023-04-10 **Tested By:** Bairong
EUT: Smart Light Switch **Model Number:** 50367
Test Mode: Tx mode **Power Supply:** AC 120V/60HZ
Condition: Temp:22.2°C;Humi:54.0% **Test Site:** DDT 3# Chamber
File Path: d:\ts\2023 report data\Q23030729-2E 50367\IC ABOVE 1G 2.4GWIFI\55
Memo: 11AX20 2462

Test Graph

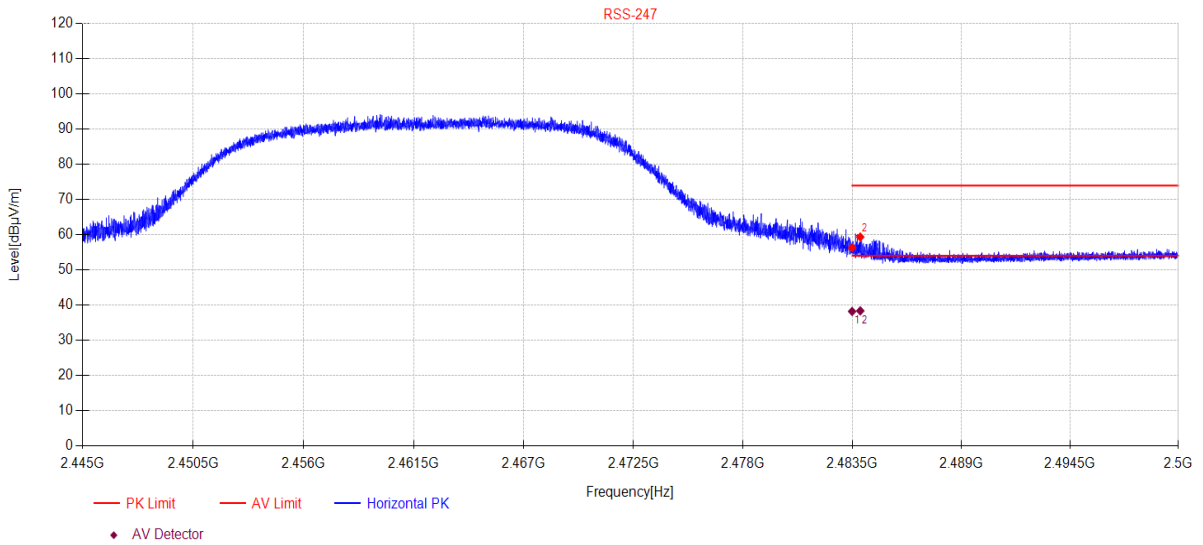

Suspected Data List										
NO.	Freq. [MHz]	Reading [dBµV]	Cable Loss [dB]	Antenna Factor [dB]	AMP [dB]	Level [dBµV/m]	Limit [dBµV/m]	Margin [dB]	Detector	Polarity
1	2483.50	54.92	3.88	27.73	-30.23	56.30	74.00	17.70	PK	Horizontal
2	2483.91	57.97	3.88	27.74	-30.23	59.36	74.00	14.64	PK	Horizontal

Final Data List										
NO.	Freq. [MHz]	Reading [dBµV/m]	Cable Loss [dB]	Antenna Factor [dB]	AMP [dB]	Level [dBµV/m]	Limit [dBµV/m]	Margin [dB]	Detector	Polarity
1	2483.50	36.82	3.88	27.73	-30.23	38.20	54.00	15.80	AV	Horizontal
2	2483.91	36.97	3.88	27.74	-30.23	38.36	54.00	15.64	AV	Horizontal

Note:

1. Level = Reading + Cable Loss + Antenna Factor + AMP
2. If Peak Result complies with AV limit, AV Result is deemed to comply with AV limit.
3. Test setup: RBW: 1 MHz, VBW: 3 MHz, Sweep time: auto.

TR-4-E-009 Radiated Emission Test Result

Test Date: 2023-04-10 **Tested By:** Bairong
EUT: Smart Light Switch **Model Number:** 50367
Test Mode: Tx mode **Power Supply:** AC 120V/60HZ
Condition: Temp:22.2°C;Humi:54.0% **Test Site:** DDT 3# Chamber
File Path: d:\ts\2023 report data\Q23030729-2E 50367\IC ABOVE 1G 2.4GWIFI\56
Memo: 11AX20 2462

Test Graph

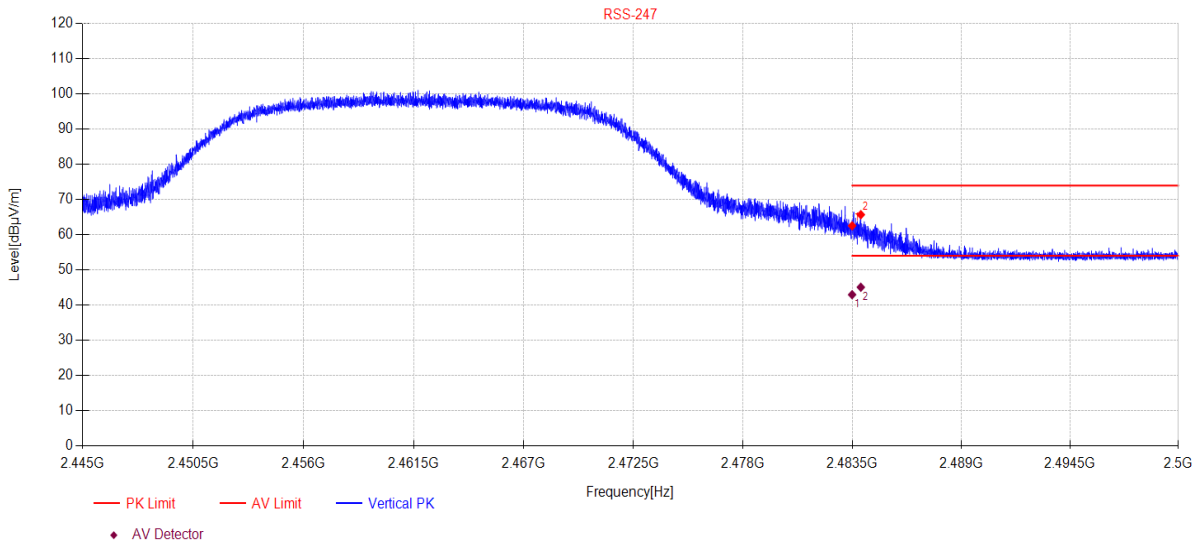

Suspected Data List										
NO.	Freq. [MHz]	Reading [dBµV]	Cable Loss [dB]	Antenna Factor [dB]	AMP [dB]	Level [dBµV/m]	Limit [dBµV/m]	Margin [dB]	Detector	Polarity
1	2483.50	61.17	3.88	27.73	-30.23	62.55	74.00	11.45	PK	Vertical
2	2483.94	64.32	3.88	27.74	-30.23	65.71	74.00	8.29	PK	Vertical

Final Data List										
NO.	Freq. [MHz]	Reading [dBµV/m]	Cable Loss [dB]	Antenna Factor [dB]	AMP [dB]	Level [dBµV/m]	Limit [dBµV/m]	Margin [dB]	Detector	Polarity
1	2483.50	41.58	3.88	27.73	-30.23	42.96	54.00	11.04	AV	Vertical
2	2483.94	42.78	3.88	27.74	-30.23	45.07	54.00	8.93	AV	Vertical

Note:

1. Level = Reading + Cable Loss + Antenna Factor + AMP
2. If Peak Result complies with AV limit, AV Result is deemed to comply with AV limit.
3. Test setup: RBW: 1 MHz, VBW: 3 MHz, Sweep time: auto.

TR-4-E-009 Radiated Emission Test Result

Test Date: 2023-04-10 **Tested By:** Bairong
EUT: Smart Light Switch **Model Number:** 50367
Test Mode: Tx mode **Power Supply:** AC 120V/60HZ
Condition: Temp:22.2°C;Humi:54.0% **Test Site:** DDT 3# Chamber
File Path: d:\ts\2023 report data\Q23030729-2E 50367\IC ABOVE 1G 2.4GWIFI43
Memo: 11AX20 2412 RU0

Test Graph

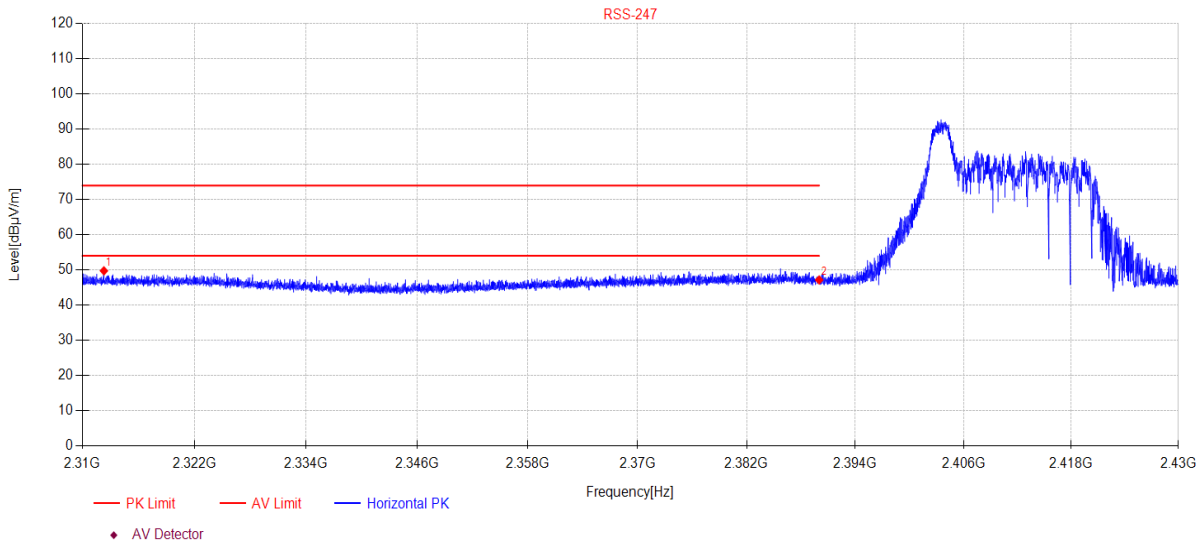

Suspected Data List										
NO	Freq. [MHz]	Reading [dBµV]	Cable Loss [dB]	Antenna Factor [dB]	AMP [dB]	Level [dBµV/m]	Limit [dBµV/m]	Margin [dB]	Detector	Polarity
1	2312.30	48.76	3.70	27.32	-30.04	49.74	74.00	24.26	PK	Horizontal
2	2390.00	46.02	3.78	27.48	-30.13	47.15	74.00	26.85	PK	Horizontal

Note:

1. Level = Reading + Cable Loss + Antenna Factor + AMP
2. If Peak Result complies with AV limit, AV Result is deemed to comply with AV limit.
3. Test setup: RBW: 1 MHz, VBW: 3 MHz, Sweep time: auto.

TR-4-E-009 Radiated Emission Test Result

Test Date: 2023-04-10 **Tested By:** Bairong
EUT: Smart Light Switch **Model Number:** 50367
Test Mode: Tx mode **Power Supply:** AC 120V/60HZ
Condition: Temp:22.2°C;Humi:54.0% **Test Site:** DDT 3# Chamber
File Path: d:\ts\2023 report data\Q23030729-2E 50367\IC ABOVE 1G 2.4GWIFI44
Memo: 11AX20 2412 RU0

Test Graph

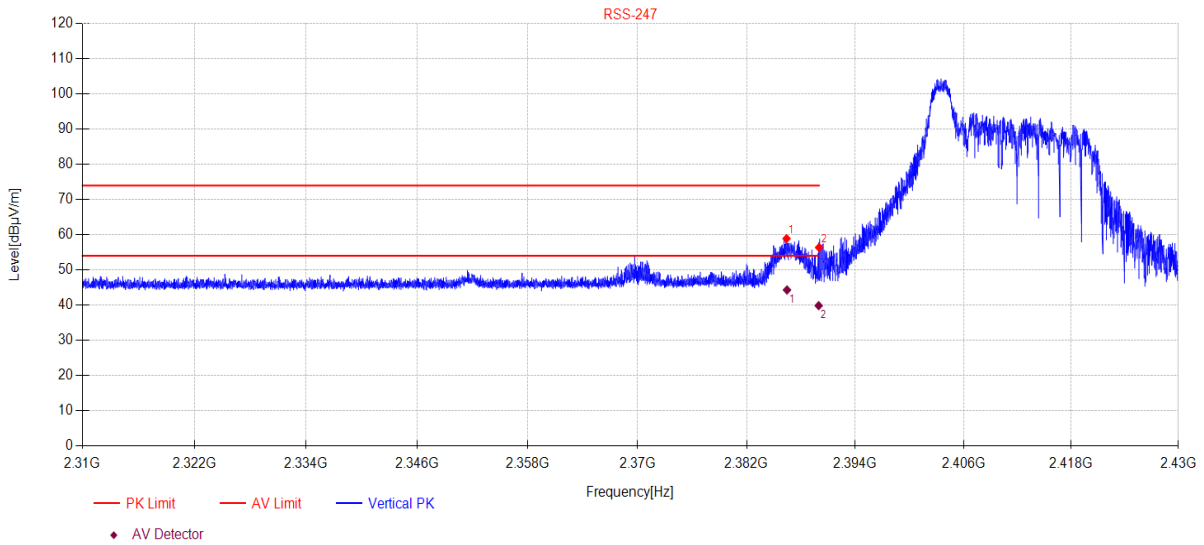

Suspected Data List										
NO	Freq. [MHz]	Reading [dBµV]	Cable Loss [dB]	Antenna Factor [dB]	AMP [dB]	Level [dBµV/m]	Limit [dBµV/m]	Margin [dB]	Detector	Polarity
1	2386.40	57.78	3.78	27.47	-30.13	58.90	74.00	15.10	PK	Vertical
2	2390.00	55.24	3.78	27.48	-30.13	56.37	74.00	17.63	PK	Vertical

Final Data List										
NO	Freq. [MHz]	Reading [dBµV/m]	Cable Loss [dB]	Antenna Factor [dB]	AMP [dB]	Level [dBµV/m]	Limit [dBµV/m]	Margin [dB]	Detector	Polarity
1	2386.45	42.26	4.70	27.47	-30.13	44.30	54.00	9.70	AV	Vertical
2	2389.95	37.79	4.70	27.48	-30.13	39.84	54.00	14.16	AV	Vertical

Note:

1. Level = Reading + Cable Loss + Antenna Factor + AMP
2. If Peak Result complies with AV limit, AV Result is deemed to comply with AV limit.
3. Test setup: RBW: 1 MHz, VBW: 3 MHz, Sweep time: auto.

TR-4-E-009 Radiated Emission Test Result

Test Date: 2023-04-10 **Tested By:** Bairong
EUT: Smart Light Switch **Model Number:** 50367
Test Mode: Tx mode **Power Supply:** AC 120V/60HZ
Condition: Temp:22.2°C;Humi:54.0% **Test Site:** DDT 3# Chamber
File Path: d:\ts\2023 report data\Q23030729-2E 50367\IC ABOVE 1G 2.4GWIFI\57
Memo: 11AX20 2462 RU16

Test Graph

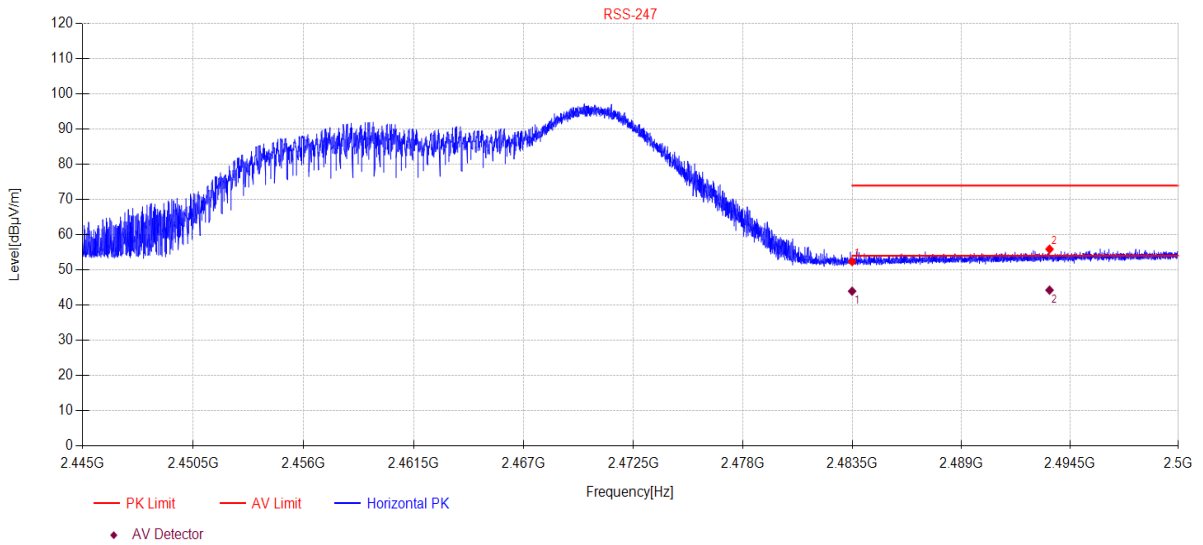

Suspected Data List										
NO.	Freq. [MHz]	Reading [dBµV]	Cable Loss [dB]	Antenna Factor [dB]	AMP [dB]	Level [dBµV/m]	Limit [dBµV/m]	Margin [dB]	Detector	Polarity
1	2483.50	51.00	3.88	27.73	-30.23	52.38	74.00	21.62	PK	Horizontal
2	2493.47	54.47	3.89	27.77	-30.24	55.89	74.00	18.11	PK	Horizontal

Final Data List										
NO.	Freq. [MHz]	Reading [dBµV/m]	Cable Loss [dB]	Antenna Factor [dB]	AMP [dB]	Level [dBµV/m]	Limit [dBµV/m]	Margin [dB]	Detector	Polarity
1	2483.50	42.57	3.88	27.73	-30.23	43.95	54.00	10.05	AV	Horizontal
2	2493.47	42.83	3.89	27.77	-30.24	44.25	54.00	9.75	AV	Horizontal

Note:

1. Level = Reading + Cable Loss + Antenna Factor + AMP
2. If Peak Result complies with AV limit, AV Result is deemed to comply with AV limit.
3. Test setup: RBW: 1 MHz, VBW: 3 MHz, Sweep time: auto.

TR-4-E-009 Radiated Emission Test Result

Test Date: 2023-04-10 **Tested By:** Bairong
EUT: Smart Light Switch **Model Number:** 50367
Test Mode: Tx mode **Power Supply:** AC 120V/60HZ
Condition: Temp:22.2°C;Humi:54.0% **Test Site:** DDT 3# Chamber
File Path: d:\ts\2023 report data\Q23030729-2E 50367\IC ABOVE 1G 2.4GWIFI\58
Memo: 11AX20 2462 RU16

Test Graph

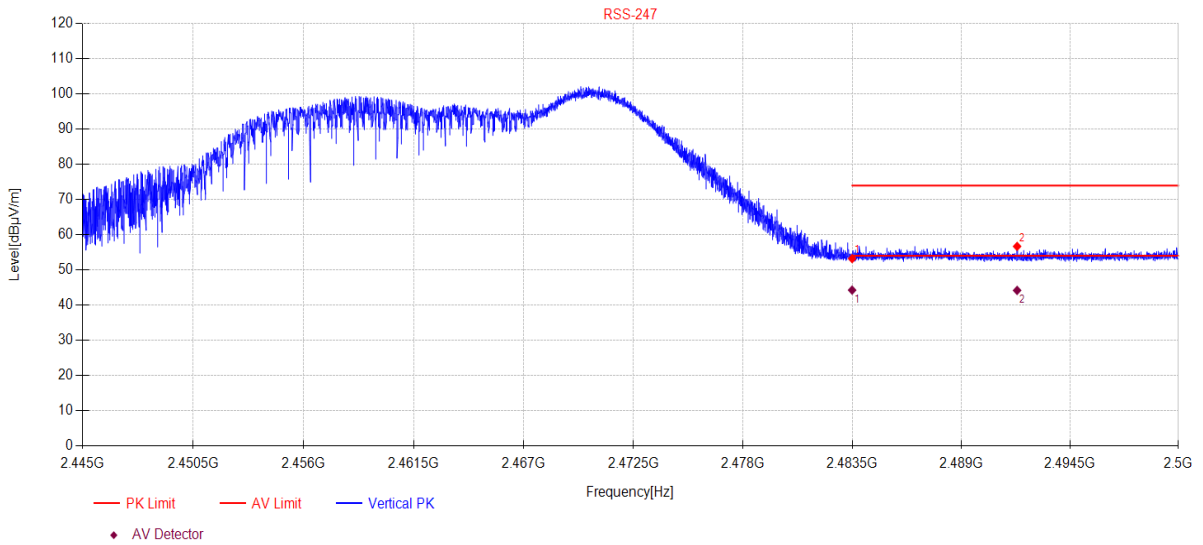

Suspected Data List										
NO.	Freq. [MHz]	Reading [dBµV]	Cable Loss [dB]	Antenna Factor [dB]	AMP [dB]	Level [dBµV/m]	Limit [dBµV/m]	Margin [dB]	Detector	Polarity
1	2483.50	51.83	3.88	27.73	-30.23	53.21	74.00	20.79	PK	Vertical
2	2491.83	55.27	3.89	27.77	-30.24	56.69	74.00	17.31	PK	Vertical

Final Data List										
NO.	Freq. [MHz]	Reading [dBµV/m]	Cable Loss [dB]	Antenna Factor [dB]	AMP [dB]	Level [dBµV/m]	Limit [dBµV/m]	Margin [dB]	Detector	Polarity
1	2483.50	42.88	3.88	27.73	-30.23	44.26	54.00	9.74	AV	Vertical
2	2491.83	42.76	3.89	27.77	-30.24	44.18	54.00	9.82	AV	Vertical

Note:

1. Level = Reading + Cable Loss + Antenna Factor + AMP
2. If Peak Result complies with AV limit, AV Result is deemed to comply with AV limit.
3. Test setup: RBW: 1 MHz, VBW: 3 MHz, Sweep time: auto.

12. Power Line Conducted Emission

12.1. Block diagram of test setup

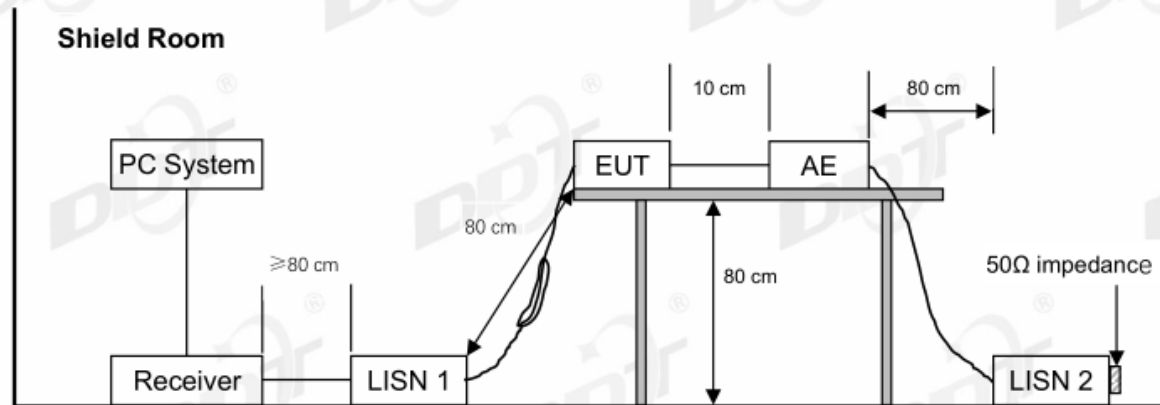

12.2. Power Line Conducted Emission Limits

Frequency	Quasi-Peak Level dB(μ V)	Average Level dB(μ V)
150 kHz ~ 500 kHz	66 ~ 56*	56 ~ 46*
500 kHz ~ 5 MHz	56	46
5 MHz ~ 30 MHz	60	50

Note 1: * Decreasing linearly with logarithm of frequency.

Note 2: The lower limit shall apply at the transition frequencies.

12.3. Test procedure

The EUT and Support equipment, if needed, were put placed on a non-metallic table, 80cm above the ground plane.

All support equipment power received from a second LISN.

Emissions were measured on each current carrying line of the EUT using an EMI Test Receiver connected to the LISN powering the EUT.

The Receiver scanned from 150 kHz to 30 MHz for emissions in each of the test modes.

During the above scans, the emissions were maximized by cable manipulation.

The test mode(s) described in clause 2.4 were scanned during the preliminary test.

After the preliminary scan, we found the test mode producing the highest emission level.

The EUT configuration and worse cable configuration of the above highest emission levels were recorded for reference of the final test.

EUT and support equipment were set up on the test bench as per the configuration with highest emission level in the preliminary test.

A scan was taken on both power lines, Neutral and Line, recording at least the six highest emissions.

Emission frequency and amplitude were recorded into a computer in which correction factors were used to calculate the emission level and compare reading to the applicable limit.

The test data of the worst-case condition(s) was recorded.

The bandwidth of test receiver is set at 9 kHz.

12.4. Test result

Pass. (See below detailed test result)

Note1: All emissions not reported below are too low against the prescribed limits.

Note2: “----” means peak detection; “-----” means average detection

Note3: Pre-test AC conducted emission at both voltage AC 120V/60Hz and AC 240V/60Hz, recorded worse case.

TR-4-E-010 Conducted Emission Test Result

Test Site	: DDT 5# Shield Room	D:\2023 report data\Q23030729-2E 50367\FCC CE.EM6	
Test Date	: 2023-04-14	Tested By	: Junchang Du
EUT	: Smart Light Switch	Model Number	: 50367
Power Supply	: AC 120V/60Hz	Test Mode	: Tx mode
Condition	: Temp:24.5°C,Humi:55.5%	LISN	: 2022 ENV216 2#/NEUTRAL
Memo	:		

Data: 2

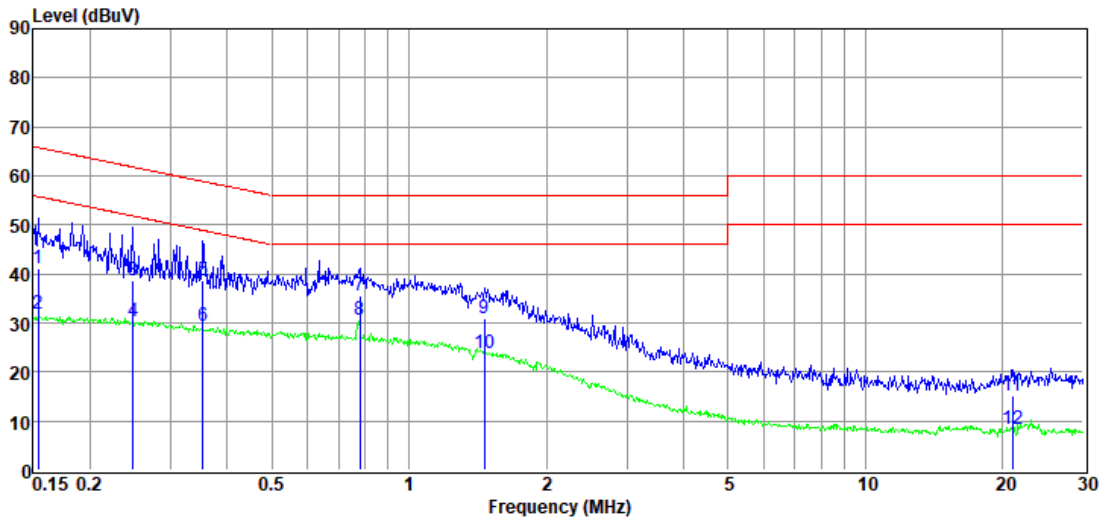

Item (Mark)	Freq. (MHz)	Read Level (dBμV)	LISN Factor (dB)	Cable Loss (dB)	Pulse Limiter Factor (dB)	Result Level (dBμV)	Limit Line (dBμV)	Over Limit (dB)	Detector	Phase
1	0.15	20.53	9.71	0.03	10.90	41.17	65.78	-24.61	QP	NEUTRAL
2	0.15	11.21	9.71	0.03	10.90	31.85	55.78	-23.93	Average	NEUTRAL
3	0.25	17.96	9.80	0.03	10.83	38.62	61.82	-23.20	QP	NEUTRAL
4	0.25	9.73	9.80	0.03	10.83	30.39	51.82	-21.43	Average	NEUTRAL
5	0.35	18.05	9.80	0.03	10.75	38.63	58.87	-20.24	QP	NEUTRAL
6	0.35	8.66	9.80	0.03	10.75	29.24	48.87	-19.63	Average	NEUTRAL
7	0.78	15.12	9.83	0.04	10.47	35.46	56.00	-20.54	QP	NEUTRAL
8	0.78	10.43	9.83	0.04	10.47	30.77	46.00	-15.23	Average	NEUTRAL
9	1.46	10.97	9.85	0.06	10.16	31.04	56.00	-24.96	QP	NEUTRAL
10	1.46	3.79	9.85	0.06	10.16	23.86	46.00	-22.14	Average	NEUTRAL
11	21.04	-4.91	9.74	0.30	10.03	15.16	60.00	-44.84	QP	NEUTRAL
12	21.04	-11.60	9.74	0.30	10.03	8.47	50.00	-41.53	Average	NEUTRAL

- Note: 1. Result Level = Read Level + LISN Factor + Pulse Limiter Factor + Cable loss.
 2. If QP Result complies with AV limit, AV Result is deemed to comply with AV limit.
 3. Test setup: RBW: 200 Hz (9 kHz—150 kHz), 9 kHz (150 kHz—30 MHz).
 4. Step size: 80Hz (0.009MHz-0.15MHz), 4 kHz (0.15MHz-30MHz), Scan time: auto.

TR-4-E-010 Conducted Emission Test Result

Test Site : DDT 5# Shield Room

D:\2023 report data\Q23030729-2E 50367\FCC CE.EM6

Test Date : 2023-04-14

Tested By : Junchang Du

EUT : Smart Light Switch

Model Number : 50367

Power Supply : AC 120V/60Hz

Test Mode : Tx mode

Condition : Temp:24.5°C,Humi:55.5%

LISN : 2022 ENV216 2#/LINE

Memo :

Data: 4

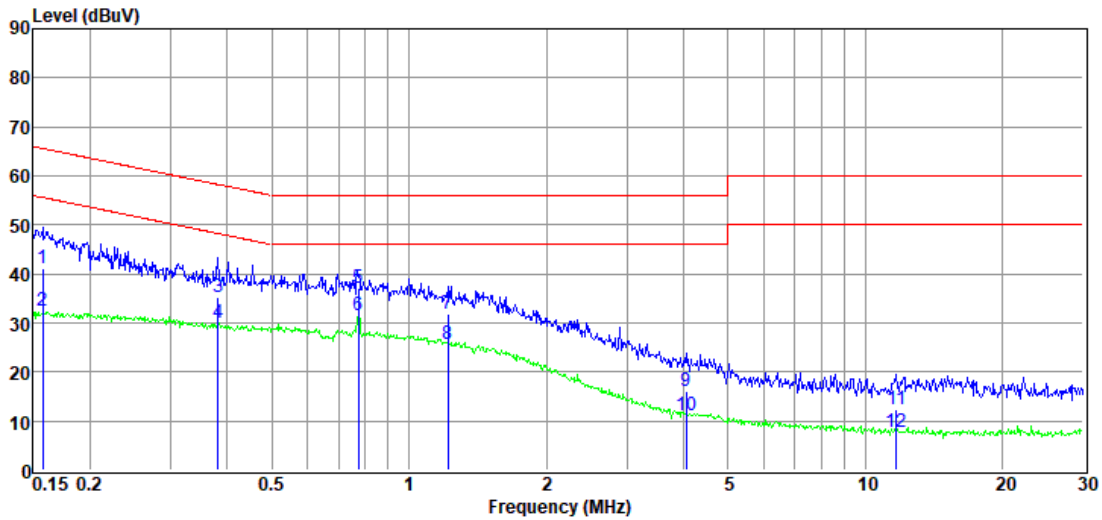

Item (Mark)	Freq. (MHz)	Read Level (dBμV)	LISN Factor (dB)	Cable Loss (dB)	Pulse Limiter Factor (dB)	Result Level (dBμV)	Limit Line (dBμV)	Over Limit (dB)	Detector	Phase
1	0.16	20.55	9.80	0.03	10.89	41.27	65.60	-24.33	QP	LINE
2	0.16	11.85	9.80	0.03	10.89	32.57	55.60	-23.03	Average	LINE
3	0.38	14.75	9.80	0.03	10.74	35.32	58.25	-22.93	QP	LINE
4	0.38	9.55	9.80	0.03	10.74	30.12	48.25	-18.13	Average	LINE
5	0.78	16.71	9.77	0.04	10.47	36.99	56.00	-19.01	QP	LINE
6	0.78	11.18	9.77	0.04	10.47	31.46	46.00	-14.54	Average	LINE
7	1.22	11.87	9.62	0.05	10.25	31.79	56.00	-24.21	QP	LINE
8	1.22	5.73	9.62	0.05	10.25	25.65	46.00	-20.35	Average	LINE
9	4.05	-3.52	9.31	0.13	10.02	15.94	56.00	-40.06	QP	LINE
10	4.05	-8.40	9.31	0.13	10.02	11.06	46.00	-34.94	Average	LINE
11	11.68	-7.40	9.58	0.21	10.02	12.41	60.00	-47.59	QP	LINE
12	11.68	-12.16	9.58	0.21	10.02	7.65	50.00	-42.35	Average	LINE

- Note: 1. Result Level = Read Level + LISN Factor + Pulse Limiter Factor + Cable loss.
 2. If QP Result complies with AV limit, AV Result is deemed to comply with AV limit.
 3. Test setup: RBW: 200 Hz (9 kHz—150 kHz), 9 kHz (150 kHz—30 MHz).
 4. Step size: 80Hz (0.009MHz-0.15MHz), 4 kHz (0.15MHz-30MHz), Scan time: auto.

13. Antenna Requirements

13.1. Limit

For intentional device, according to FCC 47 CFR Section 15.203, an intentional radiator shall be designed to ensure that no antenna other than that furnished by the responsible party shall be used with the device. And according to FCC 47 CFR Section 15.247 (b), if transmitting antennas of directional gain greater than 6 dBi are used, the power shall be reduced by the amount in dB that the directional gain of the antenna exceeds 6 dBi.

13.2. Result

The antenna used for this product is PCB antenna and that no antenna other than that furnished by the responsible party shall be used with the device, the maximum peak gain of the transmit antenna is 1.26 dBi.