

FCC AND ISED CERTIFICATION TEST REPORT

FOR

Applicant	:	Globe Electric Company Inc.
Address	:	150 Oneida, Montreal, Quebec, Canada, H9R 1A8
Equipment under Test	:	LED COLOUR CHANGING CYLINDER SURFACE LIGHT KIT
Model No.	:	32000003
Trade Mark	:	Globe
FCC ID	:	2AQUQGE32003
IC	:	8290A-GE32003
Manufacturer	:	Globe Electric Company Inc.
Address	:	150 Oneida, Montreal, Quebec, Canada, H9R 1A8

Issued By: Dongguan Dongdian Testing Service Co., Ltd.

Add.: No. 17, Zongbu Road 2, Songshan Lake Sci&Tech, Industry Park,
Dongguan City, Guangdong Province, China, 523808

Tel.: +86-0769-38826678, **E-mail:** ddt@dgddt.com, <http://www.dgddt.com>

REPORT

Table of Contents

	Test report declares.....	4
1.	Summary of Test Results.....	6
2.	General Test Information	7
2.1.	Description of EUT	7
2.2.	Accessories of EUT.....	7
2.3.	Assistant equipment used for test.....	7
2.4.	Block diagram of EUT configuration for test.....	7
2.5.	Test environment conditions	7
2.6.	Deviations of test standard.....	8
2.7.	Test laboratory	8
2.8.	Measurement uncertainty.....	8
3.	Equipment Used During Test.....	9
4.	20 dB Bandwidth	10
4.1.	Block diagram of test setup.....	10
4.2.	Limits	10
4.3.	Test procedure	10
4.4.	Test result.....	10
4.5.	Original test data	11
5.	Radiated Emission	12
5.1.	Block diagram of test setup.....	12
5.2.	Limit.....	13
5.3.	Test procedure	14
5.4.	Test result.....	15
6.	Band Edge Compliance	25
6.1.	Block diagram of test setup.....	25
6.2.	Limit.....	25
6.3.	Test procedure	25
6.4.	Test result.....	25
7.	Power Line Conducted Emission.....	30
7.1.	Block diagram of test setup.....	30
7.2.	Power line conducted emission limits	30
7.3.	Test procedure	30
7.4.	Test result.....	31
8.	Antenna Requirements	34
8.1.	Limit.....	34
8.2.	Result	34
9.	Test Setup Photograph	35

10. Photos of the EUT 37

Test Report Declare

Applicant	:	Globe Electric Company Inc.
Address	:	150 Oneida, Montreal, Quebec, Canada, H9R 1A8
Equipment under Test	:	LED COLOUR CHANGING CYLINDER SURFACE LIGHT KIT
Model No.	:	32000003
Trade mark	:	Globe
Manufacturer	:	Globe Electric Company Inc.
Address	:	150 Oneida, Montreal, Quebec, Canada, H9R 1A8

Test Standard Used:

FCC Rules and Regulations Part 15 Subpart C, RSS-210 Issue 10 December 2019, Amendment (April 2020).

Test procedure used:

ANSI C63.10:2013, RSS-Gen Issue 5, Apr. 2018, Amendment 2 (February 2021).

We Declare:

The equipment described above is tested by Dongguan Dongdian Testing Service Co., Ltd. and in the configuration tested the equipment complied with the standards specified above. The test results are contained in this test report and Dongguan Dongdian Testing Service Co., Ltd. is assumed of full responsibility for the accuracy and completeness of these tests.

After test and evaluation, our opinion is that the equipment provided for test compliance with the requirement of the above FCC&ISED standards.

Report No:	DDT-R23012904-2E01		
Date of Receipt:	Jan. 18, 2023	Date of Test:	Jan. 18, 2023 ~ Feb. 22, 2023

Prepared By:

Bobo Chen

Bobo Chen/Engineer

Approved By:



Damon Hu/EMC Manager

Note: This report applies to above tested sample only. This report shall not be reproduced in parts without written approval of Dongguan Dongdian Testing Service Co., Ltd.

Revision History

Rev.	Revisions	Issue Date	Revised By
---	Initial issue	Feb. 03, 2023	

1. Summary of Test Results

The EUT have been tested according to the applicable standards as referenced below.		
Description of Test Item	Standard	Results
20 dB Bandwidth	FCC Part 15: 15.215 ANSI C63.10:2013	Pass
Radiated Emission	FCC Part 15: 15.209 FCC Part 15: 15.249 ANSI C63.10:2013 RSS-210 Issue 10 RSS-Gen Issue 5	Pass
Band Edge Compliance	FCC Part 15: 15.205 FCC Part 15: 15.249 ANSI C63.10:2013 RSS-210 Issue 10 RSS-Gen Issue 5	Pass
Power Line Conducted Emission	FCC Part 15: 15.207 ANSI C63.10:2013 RSS-Gen Issue 5	Pass
Antenna Requirement	FCC Part 15: 15.203 RSS-Gen Issue 5 clause 6.8	Pass

2. General Test Information

2.1. Description of EUT

EUT* Name	: LED COLOUR CHANGING CYLINDER SURFACE LIGHT KIT
Model Number	: 32000003
EUT function description	: Please reference user manual of this device
Power Supply	: AC 120V/60Hz
Radio Specification	: 5.8GHz Wireless
Operation Frequency	: 5730 MHz - 5860 MHz
Modulation	: FMCW
Antenna	: 2.6 dBi
Sample Number	: SS23012904-02

Note: EUT is the abbreviation of equipment under test.

Operation Frequency 5730-5860MHz					
Frequency	5730 MHz	Frequency	5800 MHz	Frequency	5860 MHz
Note. In section 15.31(m), regards to the operating frequency range over 10 MHz, the Lowest frequency, the middle frequency and the highest frequency were selected to perform the test.					

Tested mode, information		
Mode	Setting Tx Power	Frequency (MHz)
FMCW Tx mode	/	5730
	/	5800
	/	5860

2.2. Accessories of EUT

Accessories	Manufacturer	Model number	Description
N/A	N/A	N/A	N/A

2.3. Assistant equipment used for test

Assistant equipment	Manufacturer	Model number	EMC Compliance	SN
N/A	N/A	N/A	N/A	N/A

2.4. Block diagram of EUT configuration for test



2.5. Test environment conditions

During the measurement the environmental conditions were within the listed ranges:

Temperature range:	21-25 °C
Humidity range:	40-75%
Pressure range:	86-106 kPa

2.6. Deviations of test standard

No deviation.

2.7. Test laboratory

Dongguan Dongdian Testing Service Co., Ltd.

Add.: No. 17, Zongbu Road 2, Songshan Lake Sci&Tech, Industry Park, Dongguan City, Guangdong Province, China, 523808.

Tel.: +86-0769-38826678, <http://www.dgddt.com>, Email: ddt@dgddt.com.

CNAS Accreditation No. L6451; A2LA Accreditation Number: 3870.01

FCC Designation Number: CN1182, Test Firm Registration Number: 540522

Innovation, Science and Economic Development Canada Site Registration Number: 10288A

Conformity Assessment Body identifier: CN0048

VCCI facility registration number: C-20087, T-20088, R-20123, R-20155, G-20118

2.8. Measurement uncertainty

Test Item	Uncertainty
Bandwidth	1.1%
Peak Output Power (Conducted) (Spectrum analyzer)	0.86 dB (10 MHz ≤ f < 3.6 GHz); 1.38 dB (3.6 GHz ≤ f < 8 GHz)
Peak Output Power (Conducted) (Power Sensor)	0.74 dB
Power Spectral Density	0.74 dB (10 MHz ≤ f < 3.6 GHz); 1.38 dB (3.6 GHz ≤ f < 8 GHz)
Frequencies Stability	6.7 × 10 ⁻⁸ (Antenna couple method) 5.5 × 10 ⁻⁸ (Conducted method)
Conducted spurious emissions	0.86 dB (10 MHz ≤ f < 3.6 GHz); 1.40 dB (3.6 GHz ≤ f < 8 GHz) 1.66 dB (8 GHz ≤ f < 26.5 GHz)
Uncertainty for radio frequency (RBW < 20 kHz)	3×10 ⁻⁸
Temperature	0.4 °C
Humidity	2 %
Uncertainty for Radiation Emission test (9 kHz – 30 MHz)	3.44 dB
Uncertainty for Radiation Emission test (30 MHz - 1 GHz)	4.70 dB (Antenna Polarize: V) 4.84 dB (Antenna Polarize: H)
Uncertainty for Radiation Emission test (1 GHz - 40 GHz)	4.10 dB (1 - 6 GHz) 4.40 dB (6 GHz - 18 GHz) 3.54 dB (18 GHz - 26 GHz) 4.30 dB (26 GHz - 40 GHz)
Uncertainty for Power line conduction emission test	3.34dB (150KHz-30MHz) 3.72dB (9KHz-150KHz)
Note: This uncertainty represents an expanded uncertainty expressed at approximately the 95% confidence level using a coverage factor of k=2.	

3. Equipment Used During Test

Equipment	Manufacturer	Model No.	Serial No.	Last Cal.	Cal. Interval
☑RF Connected Test (Tonscend RF Measurement System 3#)					
Signal & Spectrum analyzer	R&S	FSV40	101407	Jul. 21, 2022	1 Year
☑Radiation 3#chamber					
EMI Test Receiver	R&S	ESU26	100472	May 19, 2022	1 Year
Spectrum analyzer	Agilent	E4447A	MY50180031	May 17, 2022	1 Year
Active Loop antenna	Schwarzbeck	FMZB-1519	1519-038	Sep. 29, 2022	1 Year
Trilog Broadband Antenna	Schwarzbeck	VULB 9163	01429	Jul. 22, 2022	1 Year
Double Ridged Horn Antenna	Schwarzbeck	BBHA9120 D	02468	Sep. 29, 2022	1 Year
Broad Band Horn Antenna	Schwarzbeck	BBHA 9170	790	May 06, 2022	1 Year
Pre-amplifier	COM-POWER	PAM-118A	18040084	Aug.17, 2022	1 Year
Pre-amplifier	COM-POWER	PAM-840A	461369	Apr. 11, 2022	1 Year
RE Cable	N/A	W23.02 CP1-X2 + W23.09 AP1-X8+ JCT26S-NJ- NJ-1.5M+ JCT26S-NJ- NJ-1.5M	4.5M+8M+1.5M+1.5M	Aug.17, 2022	1 Year
RF Cable	Yuhu Technology	JCTB810-NJ- NJ-9M	21123964	May. 19, 2022	1 Year
RF Cable	Yuhu Technology	ZT26S-SMAJ -SMAJ-1M	21073466	Aug.17, 2022	1 Year
Test software	Tonscend	JS32-RE	V 5.0.0.1	N/A	N/A
Test software	Audix	E3	V 6.1.1.1	N/A	N/A
☑Power Line Conducted Emissions Test 1#					
Test Receiver	R&S	ESCI	100551	Aug. 26, 2022	1 Year
LISN 1	R&S	ENV216	101109	Aug. 26, 2022	1 Year
LISN 2	R&S	ESH2-Z5	100309	Aug. 26, 2022	1 Year
Pulse Limiter	R&S	ESH3-Z2	101242	Aug. 26, 2022	1 Year
CE Cable 1	HUBSER	N/A	W10.01	Aug. 26, 2022	1 Year
Test software	Audix	E3	V 6.11111b	N/A	N/A
Test Receiver	R&S	ESCI	100551	Aug. 26, 2022	1 Year

4. 20 dB Bandwidth

4.1. Block diagram of test setup

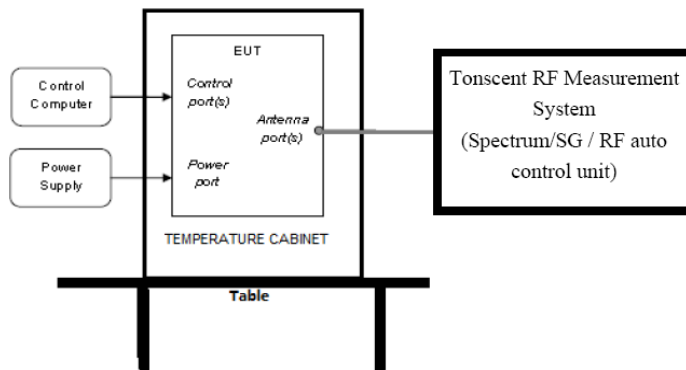

4.2. Limits

Intentional radiators operating under the alternative provisions to the general emission limits, as contained in § 15.217 through 15.257 and in Subpart E of this part, must be designed to ensure that the 20 dB bandwidth of the emission, or whatever bandwidth may otherwise be specified in the specific rule section under which the equipment operates, is contained within the frequency band designated in the rule section under which the equipment is operated.

4.3. Test procedure

- (1) Connect EUT's antenna output to spectrum analyzer by RF cable.
- (2) Set the spectrum analyzer as follows:

RBW:	300kHz
VBW:	approximately three times RBW
Detector Mode:	Peak
Sweep time:	auto
Trace mode	Max hold
- (3) Allow the trace to stabilize, measure the 20 dB bandwidth of signal.

4.4. Test result

Test Mode	Freq. (MHz)	20 dB bandwidth Result (MHz)	Verdict
FMCW Tx mode	5730	1.058	Pass
	5800	1.074	Pass
	5860	1.090	Pass

4.5. Original test data

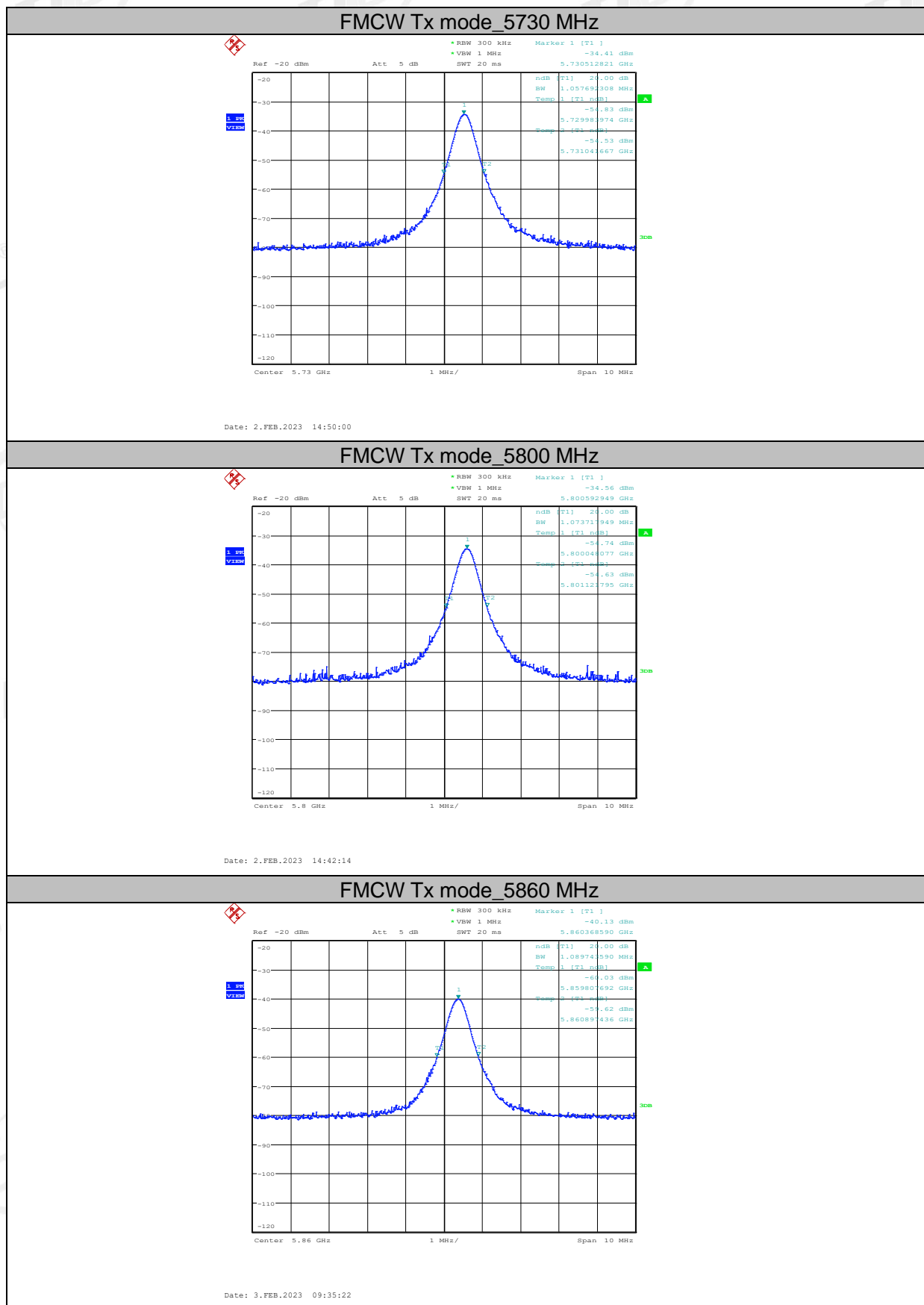

5. Radiated Emission

5.1. Block diagram of test setup

In 3 m Anechoic Chamber, test setup diagram for 9 kHz - 30 MHz:

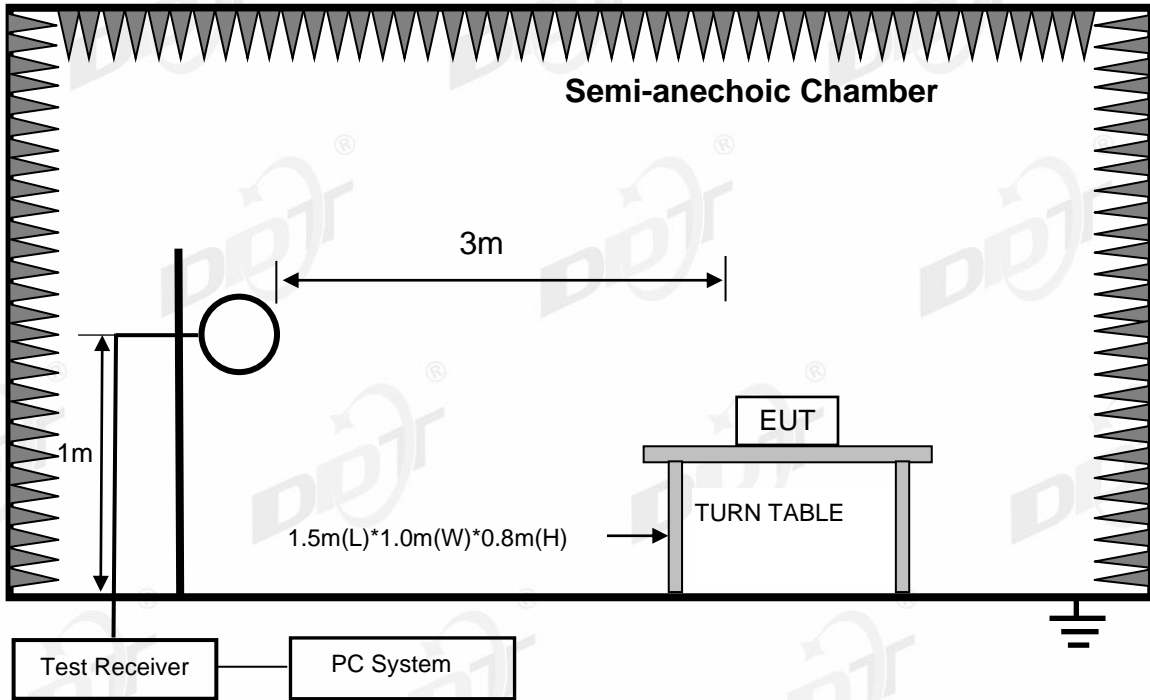

In 3 m Anechoic Chamber, test setup diagram for 30 MHz - 1 GHz:

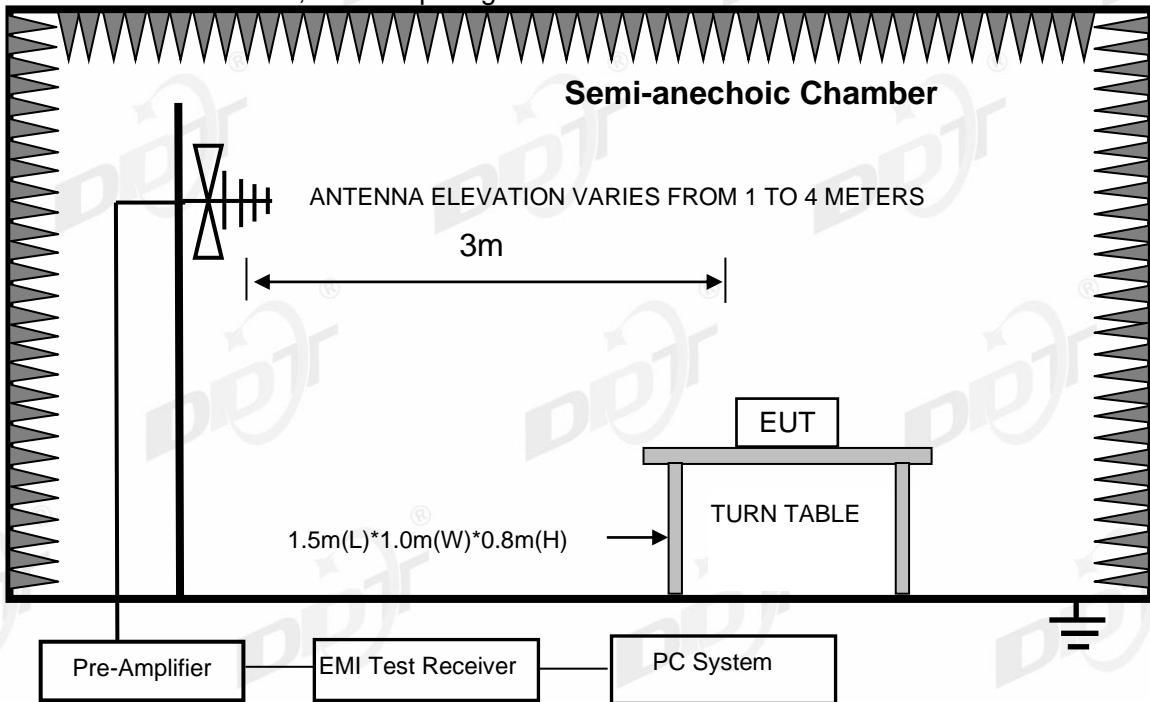

In 3 m Anechoic Chamber, test setup diagram for frequency above 1 GHz:

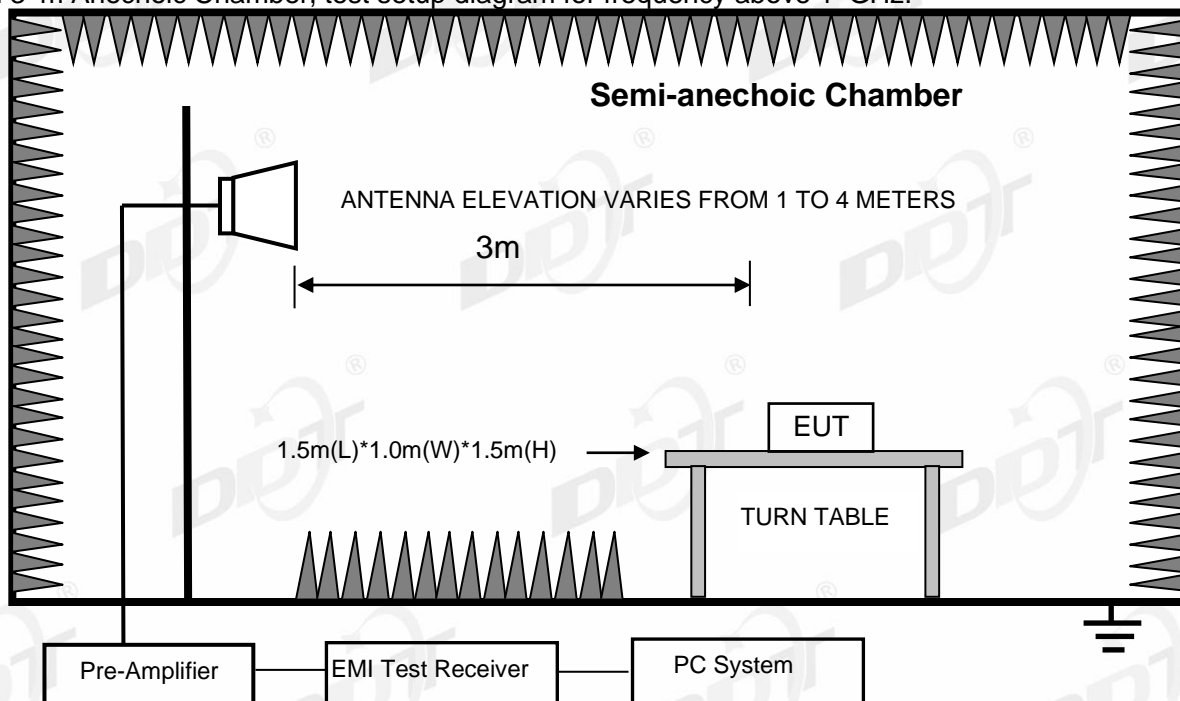

Note: For harmonic emissions test an appropriate high pass filter was inserted in the input port of AMP.

5.2. Limit

FREQUENCY MHz	DISTANCE Meters	FIELD STRENGTHS LIMIT	
		μV/m	dB(μV)/m
30 ~ 88	3	100	40.0
88 ~ 216	3	150	43.5
216 ~ 960	3	200	46.0
960 ~ 1000	3	500	54.0
Above 1000 MHz	3	74.0 dB(μV)/m (Peak) 54.0 dB(μV)/m (Average)	
Field Strength of Fundamental emission for 5725 MHz - 5875 MHz	3	94.0 dB(μV)/m (Average) 114.0 dB(μV)/m (Peak)	
Field Strength of Harmonics	3	74.0 dB(μV)/m (Peak) 54.0 dB(μV)/m (Average)	

Remark:

- (1) Emission level $dB_{\mu V} = 20 \log$ Emission level $\mu V/m$
- (2) The smaller limit shall apply at the cross point between two frequency bands.
- (3) Distance is the distance in meters between the measuring instrument, antenna and the closest point of any part of the device or system.
- (4) The emission limits shown in the above table are based on measurements employing a CISPR quasi-peak detector except for the frequency bands 9-90 kHz, 110-490 kHz and above 1000 MHz, radiated emission limits in these three bands are based on measurements employing an average detector.

5.3. Test procedure

- (1) EUT was placed on a non-metallic table, 80 cm above the ground plane inside a semi-anechoic chamber.
- (2) Setup EUT and assistant system according clause 2.3
- (3) Test antenna was located 3 m from the EUT on an adjustable mast. Below pre-scan procedure was first performed in order to find prominent radiated emissions.
 - (a) Change work frequency or channel of device if practicable.
 - (b) Change modulation type of device if practicable.
 - (c) Change power supply range from 85% to 115% of the rated supply voltage
 - (d) Rotated EUT though three orthogonal axes to determine the attitude of EUT arrangement produces highest emissions
- (4) Spectrum frequency from 9 kHz to 40 GHz (tenth harmonic of fundamental frequency) was investigated, and no any obvious emission were detected from 9 kHz to 30 MHz and 18 GHz to 40 GHz, so below final test was performed with frequency range from 30 MHz to 18 GHz.
- (5) For final emissions measurements at each frequency of interest, the EUT were rotated and the antenna height was varied between 1 m and 4 m in order to maximize the emission. Measurements in both horizontal and vertical polarities were made and the data was recorded. In order to find the maximum emission, the relative positions of equipments and all of the interface cables were changed according to ANSI C63.10:2013 on Radiated Emission test.
- (6) For emissions from 30 MHz to 1 GHz, Quasi-Peak values were measured with EMI Receiver and the bandwidth of Receiver is 120 kHz.
- (7) For emissions above 1 GHz, both Peak and Average level were measured with Spectrum Analyzer, and the RBW is set at 1 MHz, VBW is set at 3 MHz for Peak measure; according ANSI C63.10:2013 clause 4.1.4.2.2 procedure for average measure.
- (8) For fundamental frequency test, set spectrum analyzer's RBW = 3 MHz, VBW = 10 MHz. Peak detector for PK, according ANSI C63.10:2013 clause 4.1.4.2.2 procedure for average measure.

5.4. Test result

Pass. (See below detailed test result)

All the emissions except fundamental emission from 9 kHz to 40 GHz were comply with 15.209 limit.

Note1: According exploratory test no any obvious emission was detected from 9 kHz to 30 MHz and 18 GHz to 40 GHz, so the final test was performed with frequency range from 30 MHz to 18 GHz and recorded in below.

Note2: For emissions below 1 GHz, according exploratory explorer test, when change Tx mode and channel, have no distinct influence on emissions level, so for emissions below 1 GHz, the final test was only performed with EUT working in FMCW, Tx 5730 MHz mode.

Note3: For emissions above 1 GHz. If peak results comply with AV limit, AV Result is deemed to comply with AV limit.

Field Strength of the Fundamental Signal

Frequency (MHz)	PK Level (dBuV/m)	PK Limit Line (dBuV/m)	Over Limit (dB)	Polarization
5730	89.80	114.00	-24.20	Horizontal
5800	88.69	114.00	-25.31	Horizontal
5860	86.21	114.00	-27.79	Horizontal
5730	90.67	114.00	-23.33	Vertical
5800	90.05	114.00	-23.95	Vertical
5860	89.94	114.00	-24.06	Vertical

Frequency (MHz)	AV Level (dBuV/m)	AV Limit Line (dBuV/m)	Over Limit (dB)	Polarization
5730	88.67	94.00	-5.33	Horizontal
5800	88.01	94.00	-5.99	Horizontal
5860	85.50	94.00	-8.50	Horizontal
5730	90.21	94.00	-3.79	Vertical
5800	89.76	94.00	-4.24	Vertical
5860	89.82	94.00	-4.18	Vertical

Note: Final level = Reading + Cable Loss + Antenna Factor + AMP

Radiated Emission test (below 1 GHz)

TR-4-E-009 Radiated Emission Test Result

Test Date: 2023-02-15 **Tested By:** Bairong
EUT: LED COLOUR CHANGING CYLINDER SURFACE LIGHT KIT **Model Number:** 32000003
Test Mode: Tx mode **Power Supply:** AC 120V/60Hz
Condition: Temp:22.8°C;Humi:43.8%;Press:100.2kPa **Test Site:** DDT 3# Chamber
File Path: d:\ts\2022 report data\Q23012904-2E 3200003\FCC BELOW 1G\20230215-190153_H
Memo:

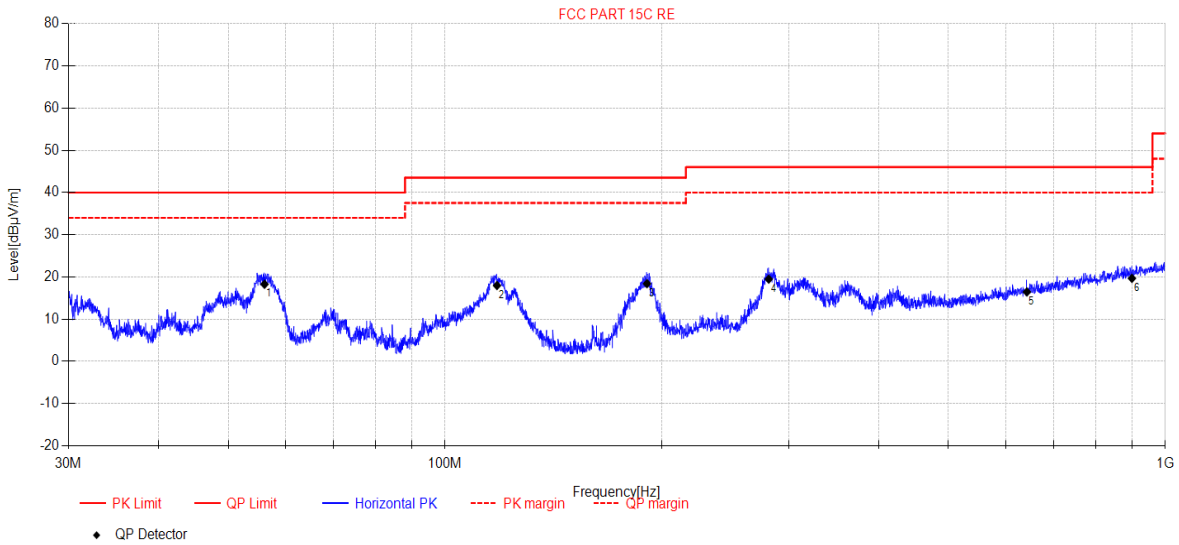

Final Data List										
NO.	Freq. [MHz]	Reading [dBµV/m]	Antenna Factor [dB]	Cable Loss [dB]	AMP [dB]	Result [dBµV/m]	Limit [dBµV/m]	Margin [dB]	Detector	Polarity
1	56.15	37.18	12.48	0.88	-32.27	18.27	40.00	21.73	QP	Horizontal
2	118.07	39.58	9.09	1.51	-32.22	17.96	43.50	25.54	QP	Horizontal
3	190.74	38.45	10.27	1.94	-32.26	18.40	43.50	25.10	QP	Horizontal
4	281.47	36.5	12.90	2.36	-32.28	19.48	46.00	26.52	QP	Horizontal
5	642.47	26.39	19.15	3.68	-32.78	16.44	46.00	29.56	QP	Horizontal
6	898.90	25.08	22.40	4.43	-32.24	19.67	46.00	26.33	QP	Horizontal

- Note:
1. Result = Reading + Cable Loss + Antenna Factor + AMP
 2. If Peak Result complies with QP limit, QP Result is deemed to comply with QP limit.
 3. Test setup: RBW: 120 kHz, VBW: 300 kHz, Sweep time: auto.

TR-4-E-009 Radiated Emission Test Result

Test Date: 2023-02-15 **Tested By:** Bairong
EUT: LED COLOUR CHANGING CYLINDER SURFACE LIGHT KIT **Model Number:** 32000003
Test Mode: Tx mode **Power Supply:** AC 120V/60Hz
Condition: Temp:22.8°C;Humi:43.8%;Press:100.2kPa **Test Site:** DDT 3# Chamber
File Path: d:\ts\2022 report data\Q23012904-2E 3200003\FCC BELOW 1G\20230215-190238_V

Memo:

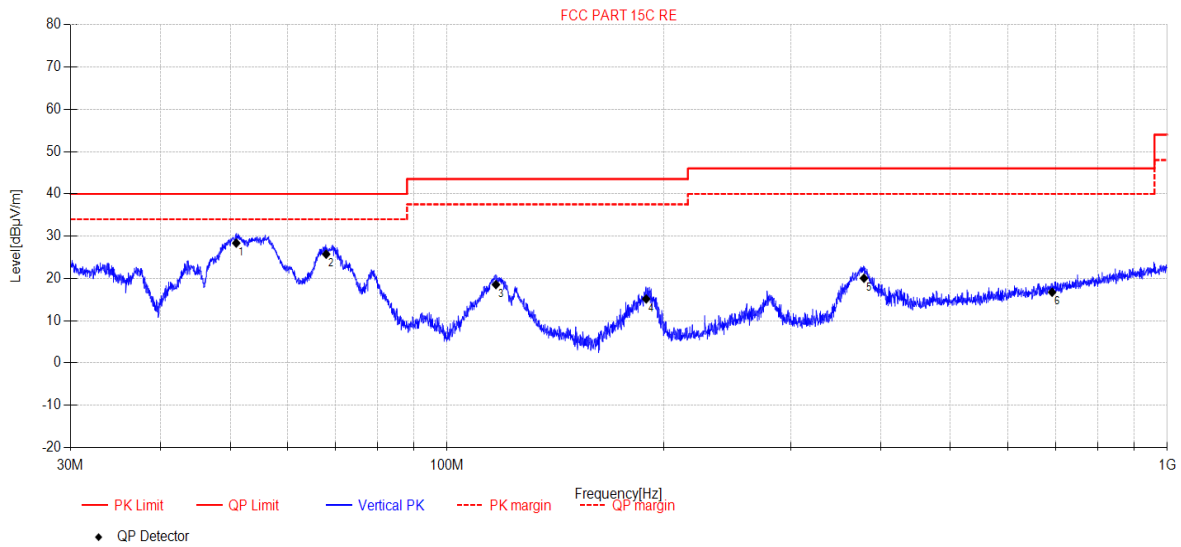

Final Data List										
NO.	Freq. [MHz]	Reading [dBµV/m]	Antenna Factor [dB]	Cable Loss [dB]	AMP [dB]	Result [dBµV/m]	Limit [dBµV/m]	Margin [dB]	Detector	Polarity
1	50.97	46.71	13.10	0.82	-32.28	28.35	40.00	11.65	QP	Vertical
2	67.95	47.09	9.89	1.02	-32.27	25.73	40.00	14.27	QP	Vertical
3	116.92	39.94	9.32	1.50	-32.22	18.54	43.50	24.96	QP	Vertical
4	189.00	35.37	10.10	1.93	-32.26	15.14	43.50	28.36	QP	Vertical
5	379.19	34.63	15.00	2.77	-32.35	20.05	46.00	25.95	QP	Vertical
6	692.04	25.84	19.94	3.81	-32.85	16.74	46.00	29.26	QP	Vertical

Note:

1. Result = Reading + Cable Loss + Antenna Factor + AMP
2. If Peak Result complies with QP limit, QP Result is deemed to comply with QP limit.
3. Test setup: RBW: 120 kHz, VBW: 300 kHz, Sweep time: auto.

Radiated Emission test (above 1 GHz)

TR-4-E-009 Radiated Emission Test Result

Test Date: 2023-02-02 **Tested By:** Bairong
EUT: LED COLOUR CHANGING CYLINDER SURFACE LIGHT KIT **Model Number:** 32000003
Test Mode: Tx mode **Power Supply:** AC 120V/60Hz
Condition: Temp:22.8°C;Humi:43.8%;Press:100.2kPa **Test Site:** DDT 3# Chamber
File Path: d:\ts\2022 report data\Q23012904-2E 3200003\FCC ABOVE 1G\21
Memo: 5730MHz

Test Graph

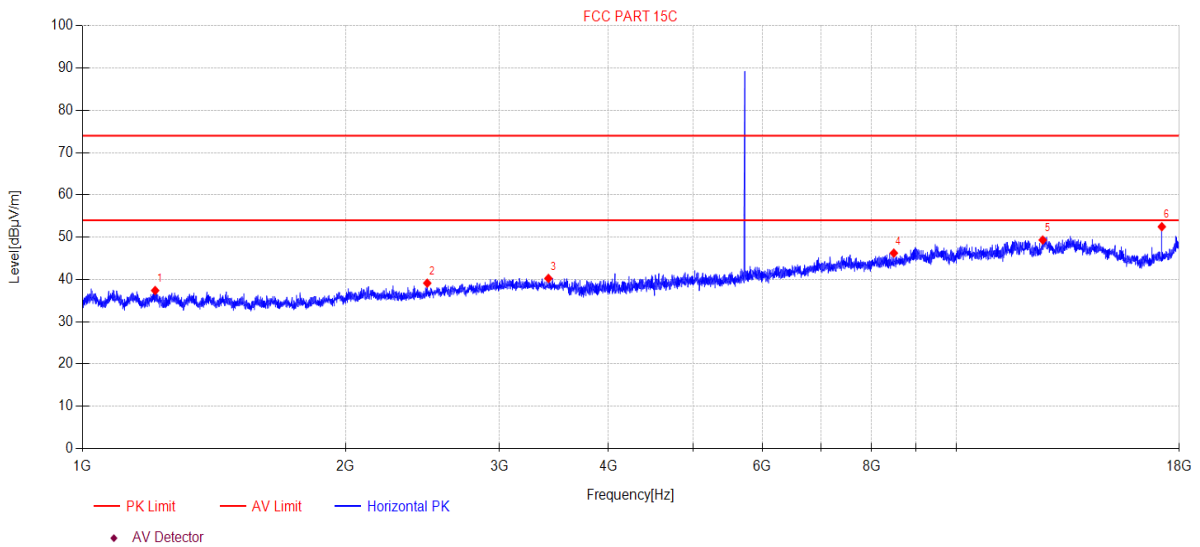

Suspected Data List										
NO.	Freq. [MHz]	Reading [dBµV]	Cable Loss [dB]	Antenna Factor [dB]	AMP [dB]	Level [dBµV/m]	Limit [dBµV/m]	Margin [dB]	Detector	Polarity
1	1211.20	48.13	2.15	25.62	-38.52	37.38	74.00	36.62	PK	Horizontal
2	2480.95	48.49	3.15	27.72	-40.23	39.13	74.00	34.87	PK	Horizontal
3	3414.38	48.04	3.76	29.50	-41.05	40.25	74.00	33.75	PK	Horizontal
4	8483.16	44.07	4.92	37.47	-40.23	46.23	74.00	27.77	PK	Horizontal
5	12560.49	43.46	6.16	39.16	-39.46	49.32	74.00	24.68	PK	Horizontal
6	17191.58	45.82	8.44	38.59	-40.38	52.47	74.00	21.53	PK	Horizontal

Note:

1. Level = Reading + Cable Loss + Antenna Factor + AMP
2. If Peak Result complies with AV limit, AV Result is deemed to comply with AV limit.
3. Test setup: RBW: 1 MHz, VBW: 3 MHz, Sweep time: auto.

TR-4-E-009 Radiated Emission Test Result

Test Date: 2023-02-02 **Tested By:** Bairong
EUT: LED COLOUR CHANGING CYLINDER SURFACE LIGHT KIT **Model Number:** 32000003
Test Mode: Tx mode **Power Supply:** AC 120V/60Hz
Condition: Temp:22.8°C;Humi:43.8%;Press:100.2kPa **Test Site:** DDT 3# Chamber
File Path: d:\ts\2022 report data\Q23012904-2E 3200003\FCC ABOVE 1G\22
Memo: 5730MHz

Test Graph

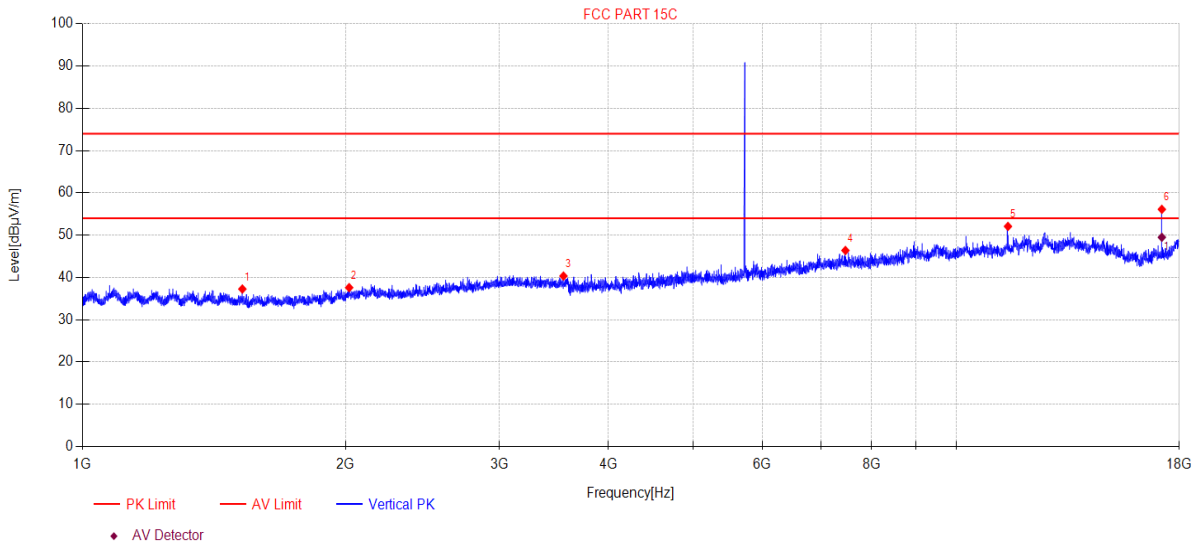

Suspected Data List										
NO.	Freq. [MHz]	Reading [dBµV]	Cable Loss [dB]	Antenna Factor [dB]	AMP [dB]	Level [dBµV/m]	Limit [dBµV/m]	Margin [dB]	Detector	Polarity
1	1524.05	48.45	2.35	25.45	-38.99	37.26	74.00	36.74	PK	Vertical
2	2019.54	47.93	2.67	26.72	-39.72	37.60	74.00	36.40	PK	Vertical
3	3552.28	48.09	3.78	29.60	-41.13	40.34	74.00	33.66	PK	Vertical
4	7468.03	46.30	4.62	36.46	-41.00	46.38	74.00	27.62	PK	Vertical
5	11460.90	47.02	5.77	39.04	-39.76	52.07	74.00	21.93	PK	Vertical
6	17191.58	49.46	8.44	38.59	-40.38	56.11	74.00	17.89	PK	Vertical

Final Data List										
NO.	Freq. [MHz]	Reading [dBµV/m]	Cable Loss [dB]	Antenna Factor [dB]	AMP [dB]	Level [dBµV/m]	Limit [dBµV/m]	Margin [dB]	Detector	Polarity
1	17191.45	42.85	8.44	38.59	-40.38	49.50	54.00	4.50	AV	Vertical

Note:

- Level = Reading + Cable Loss + Antenna Factor + AMP
- If Peak Result complies with AV limit, AV Result is deemed to comply with AV limit.
- Test setup: RBW: 1 MHz, VBW: 3 MHz, Sweep time: auto.

TR-4-E-009 Radiated Emission Test Result

Test Date: 2023-02-02 **Tested By:** Bairong
EUT: LED COLOUR CHANGING CYLINDER SURFACE LIGHT KIT **Model Number:** 32000003
Test Mode: Tx mode **Power Supply:** AC 120V/60Hz
Condition: Temp:22.8°C;Humi:43.8%;Press:100.2kPa **Test Site:** DDT 3# Chamber
File Path: d:\ts\2022 report data\Q23012904-2E 3200003\FCC ABOVE 1G\25
Memo: 5800MHz

Test Graph

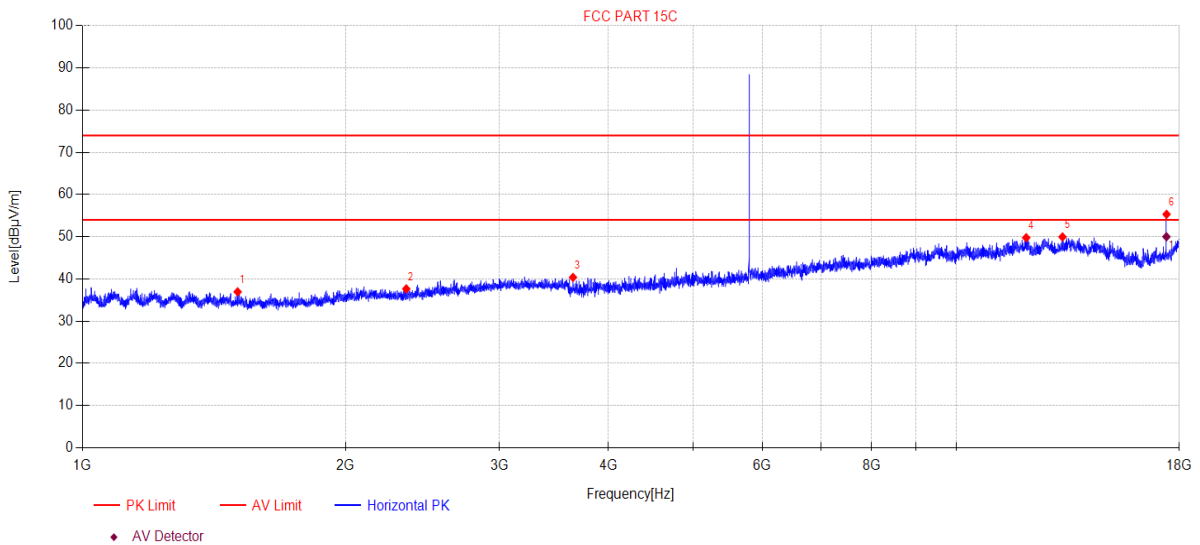

Suspected Data List										
NO.	Freq. [MHz]	Reading [dBµV]	Cable Loss [dB]	Antenna Factor [dB]	AMP [dB]	Level [dBµV/m]	Limit [dBµV/m]	Margin [dB]	Detector	Polarity
1	1505.23	48.08	2.34	25.49	-38.96	36.95	74.00	37.05	PK	Horizontal
2	2347.71	47.32	3.01	27.40	-40.08	37.65	74.00	36.35	PK	Horizontal
3	3642.73	47.98	3.80	29.79	-41.19	40.38	74.00	33.62	PK	Horizontal
4	12024.14	43.86	5.88	38.95	-38.92	49.77	74.00	24.23	PK	Horizontal
5	13231.20	43.42	6.44	39.93	-39.83	49.96	74.00	24.04	PK	Horizontal
6	17406.55	48.28	8.59	38.91	-40.46	55.32	74.00	18.68	PK	Horizontal

Final Data List										
NO.	Freq. [MHz]	Reading [dBµV/m]	Cable Loss [dB]	Antenna Factor [dB]	AMP [dB]	Level [dBµV/m]	Limit [dBµV/m]	Margin [dB]	Detector	Polarity
1	17401.17	42.96	8.59	38.91	-40.46	50.00	54.00	4.00	AV	Horizontal

Note:

- Level = Reading + Cable Loss + Antenna Factor + AMP
- If Peak Result complies with AV limit, AV Result is deemed to comply with AV limit.
- Test setup: RBW: 1 MHz, VBW: 3 MHz, Sweep time: auto.

TR-4-E-009 Radiated Emission Test Result

Test Date: 2023-02-02 **Tested By:** Bairong
EUT: LED COLOUR CHANGING CYLINDER SURFACE LIGHT KIT **Model Number:** 32000003
Test Mode: Tx mode **Power Supply:** AC 120V/60Hz
Condition: Temp:22.8°C;Humi:43.8%;Press:100.2kPa **Test Site:** DDT 3# Chamber
File Path: d:\ts\2022 report data\Q23012904-2E 3200003\FCC ABOVE 1G\26
Memo: 5800MHz

Test Graph

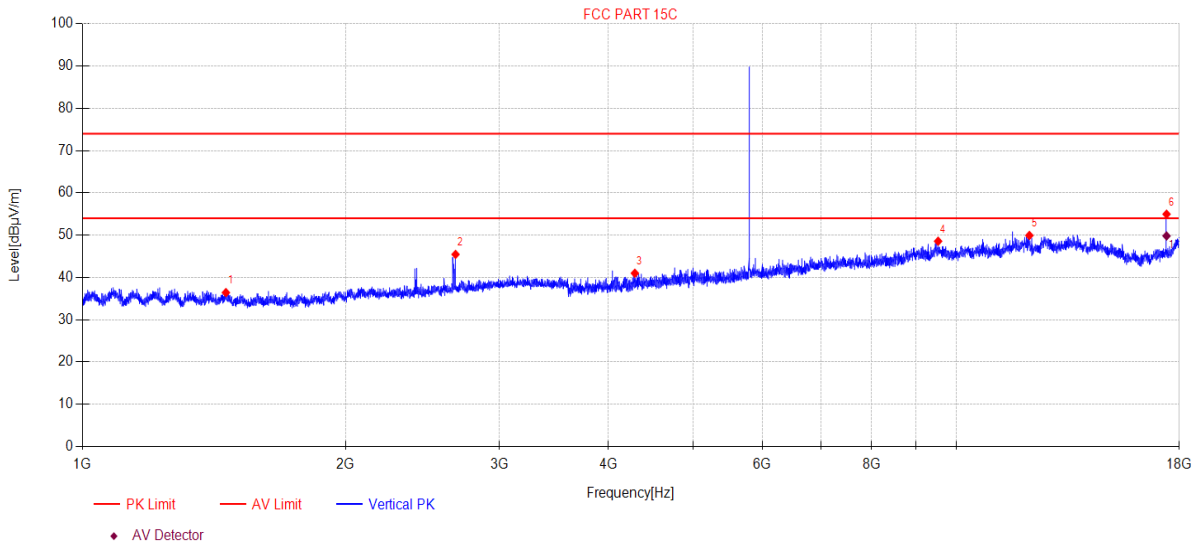

Suspected Data List										
NO.	Freq. [MHz]	Reading [dBµV]	Cable Loss [dB]	Antenna Factor [dB]	AMP [dB]	Level [dBµV/m]	Limit [dBµV/m]	Margin [dB]	Detector	Polarity
1	1459.40	47.42	2.31	25.58	-38.89	36.42	74.00	37.58	PK	Vertical
2	2673.01	54.29	3.35	28.25	-40.44	45.45	74.00	28.55	PK	Vertical
3	4287.63	47.11	3.92	31.28	-41.31	41.00	74.00	33.00	PK	Vertical
4	9533.79	44.97	5.23	38.40	-40.04	48.56	74.00	25.44	PK	Vertical
5	12125.34	43.93	5.93	39.10	-39.03	49.93	74.00	24.07	PK	Vertical
6	17406.55	47.93	8.59	38.91	-40.46	54.97	74.00	19.03	PK	Vertical

Final Data List										
NO.	Freq. [MHz]	Reading [dBµV/m]	Cable Loss [dB]	Antenna Factor [dB]	AMP [dB]	Level [dBµV/m]	Limit [dBµV/m]	Margin [dB]	Detector	Polarity
1	17405.53	42.78	8.59	38.91	-40.46	49.82	54.00	4.18	AV	Vertical

Note:

- Level = Reading + Cable Loss + Antenna Factor + AMP
- If Peak Result complies with AV limit, AV Result is deemed to comply with AV limit.
- Test setup: RBW: 1 MHz, VBW: 3 MHz, Sweep time: auto.

TR-4-E-009 Radiated Emission Test Result

Test Date: 2023-02-02 **Tested By:** Bairong
EUT: LED COLOUR CHANGING CYLINDER SURFACE LIGHT KIT **Model Number:** 32000003
Test Mode: Tx mode **Power Supply:** AC 120V/60Hz
Condition: Temp:22.8°C;Humi:43.8%;Press:100.2kPa **Test Site:** DDT 3# Chamber
File Path: d:\ts\2022 report data\Q23012904-2E 3200003\FCC ABOVE 1G\29
Memo: 5860MHz

Test Graph

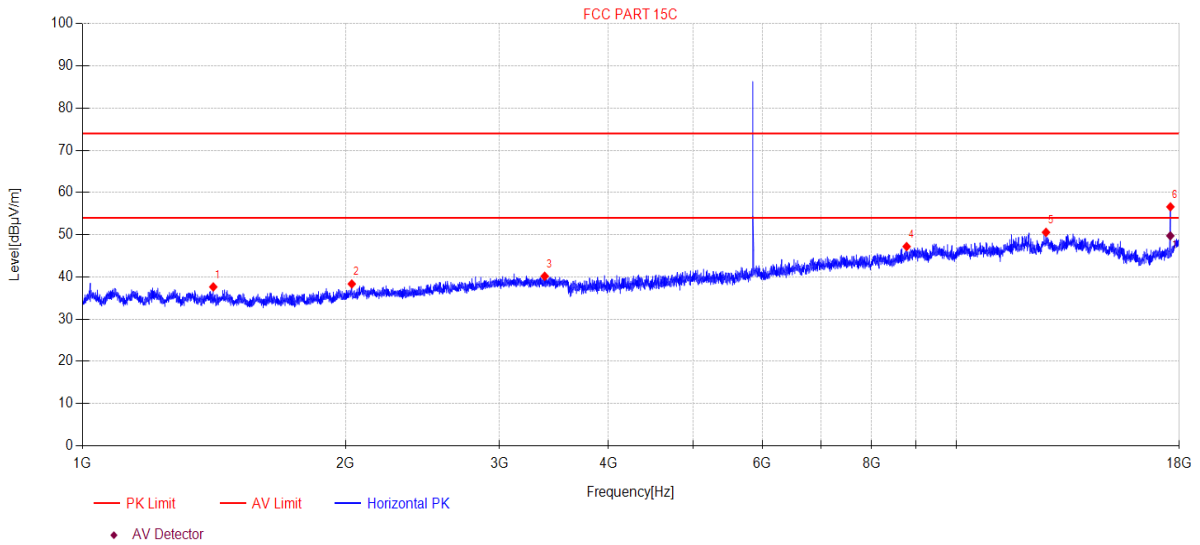

Suspected Data List										
NO.	Freq. [MHz]	Reading [dBµV]	Cable Loss [dB]	Antenna Factor [dB]	AMP [dB]	Level [dBµV/m]	Limit [dBµV/m]	Margin [dB]	Detector	Polarity
1	1411.69	48.57	2.28	25.60	-38.82	37.63	74.00	36.37	PK	Horizontal
2	2033.59	48.61	2.68	26.80	-39.74	38.35	74.00	35.65	PK	Horizontal
3	3380.99	47.94	3.75	29.50	-41.03	40.16	74.00	33.84	PK	Horizontal
4	8774.92	43.99	4.97	38.00	-39.76	47.20	74.00	26.80	PK	Horizontal
5	12669.87	44.59	6.21	39.34	-39.57	50.57	74.00	23.43	PK	Horizontal
6	17583.52	49.06	8.72	39.35	-40.53	56.60	74.00	17.40	PK	Horizontal

Final Data List										
NO.	Freq. [MHz]	Reading [dBµV/m]	Cable Loss [dB]	Antenna Factor [dB]	AMP [dB]	Level [dBµV/m]	Limit [dBµV/m]	Margin [dB]	Detector	Polarity
1	17580.31	42.20	8.72	39.35	-40.53	49.74	54.00	4.26	AV	Horizontal

Note:

- Level = Reading + Cable Loss + Antenna Factor + AMP
- If Peak Result complies with AV limit, AV Result is deemed to comply with AV limit.
- Test setup: RBW: 1 MHz, VBW: 3 MHz, Sweep time: auto.

TR-4-E-009 Radiated Emission Test Result

Test Date: 2023-02-02 **Tested By:** Bairong
EUT: LED COLOUR CHANGING CYLINDER SURFACE LIGHT KIT **Model Number:** 32000003
Test Mode: Tx mode **Power Supply:** AC 120V/60Hz
Condition: Temp:22.8°C;Humi:43.8%;Press:100.2kPa **Test Site:** DDT 3# Chamber
File Path: d:\ts\2022 report data\Q23012904-2E 3200003\FCC ABOVE 1G\30
Memo: 5860MHz

Test Graph

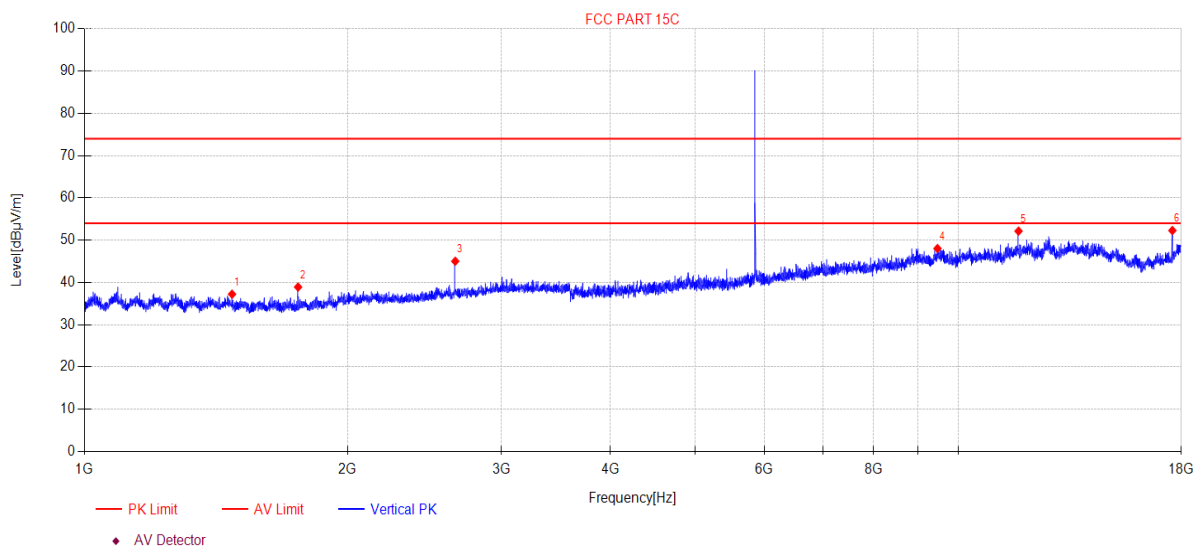

Suspected Data List

NO.	Freq. [MHz]	Reading [dBµV]	Cable Loss [dB]	Antenna Factor [dB]	AMP [dB]	Level [dBµV/m]	Limit [dBµV/m]	Margin [dB]	Detector	Polarity
1	1475.51	48.27	2.32	25.55	-38.91	37.23	74.00	36.77	PK	Vertical
2	1755.91	50.33	2.50	25.41	-39.33	38.91	74.00	35.09	PK	Vertical
3	2656.84	53.90	3.33	28.21	-40.42	45.02	74.00	28.98	PK	Vertical
4	9467.89	44.38	5.21	38.40	-39.96	48.03	74.00	25.97	PK	Vertical
5	11722.19	46.86	5.82	38.80	-39.34	52.14	74.00	21.86	PK	Vertical
6	17583.52	44.74	8.72	39.35	-40.53	52.28	74.00	21.72	PK	Vertical

Note:

- Level = Reading + Cable Loss + Antenna Factor + AMP
- If Peak Result complies with AV limit, AV Result is deemed to comply with AV limit.
- Test setup: RBW: 1 MHz, VBW: 3 MHz, Sweep time: auto.

6. Band Edge Compliance

6.1. Block diagram of test setup

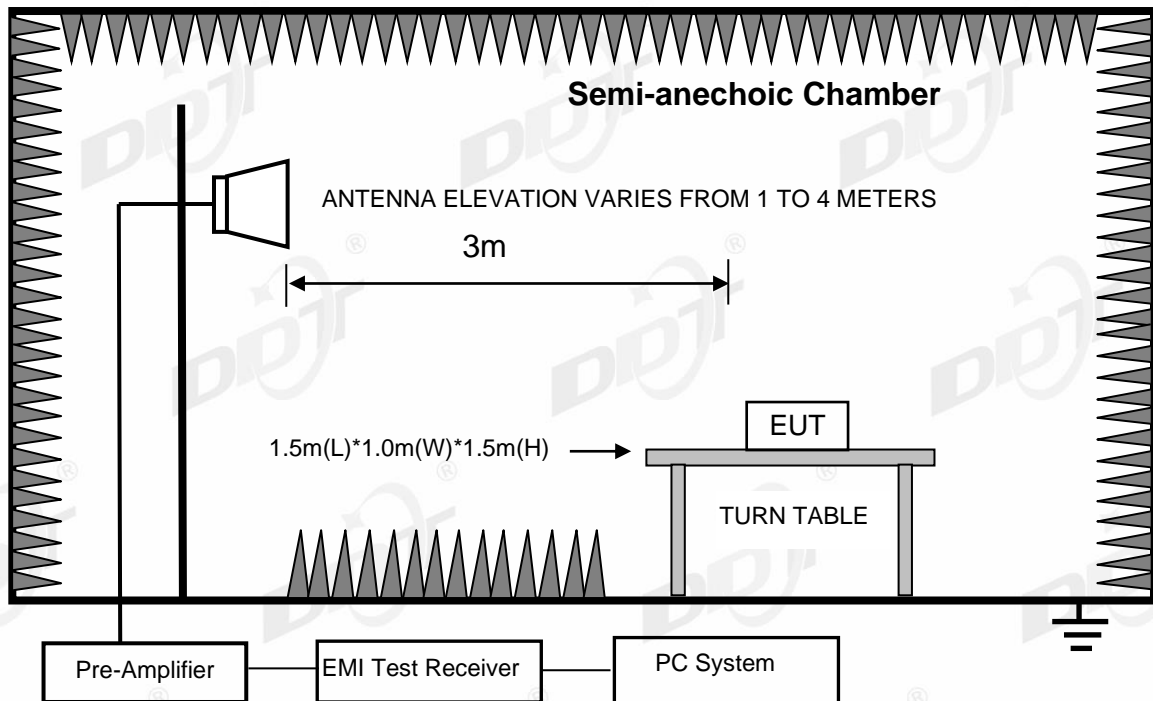

6.2. Limit

Emissions radiated outside of the specified frequency bands, except for harmonics, shall be attenuated by at least 50 dB below the level of the fundamental or to the general radiated emission limits in §15.209, whichever is the lesser attenuation.

6.3. Test procedure

Same with clause 5.3 except change investigated frequency range from 5700 MHz to 5750 MHz and 5800 MHz to 5900 MHz.

Remark: All restriction band have been tested, and only the worst case is shown in report.

6.4. Test result

Pass. (See below detailed test result)

TR-4-E-009 Radiated Emission Test Result

Test Date: 2023-01-31 **Tested By:** Bairong
EUT: LED COLOUR CHANGING CYLINDER SURFACE LIGHT KIT **Model Number:** 32000003
Test Mode: Tx mode **Power Supply:** AC 120V/60Hz
Condition: Temp:22.8°C;Humi:43.8%;Press:100.2kPa **Test Site:** DDT 3# Chamber
File Path: d:\ts\2022 report data\20230118 5.8G\FCC ABOVE 1G\17
Memo: 5730MHz

Test Graph

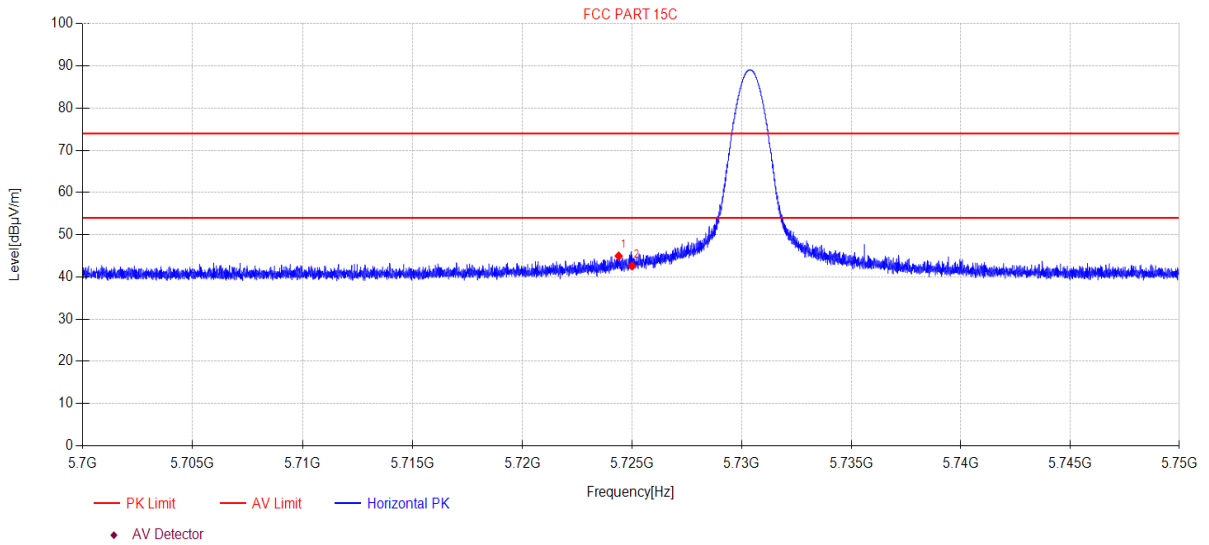

Suspected Data List										
NO.	Freq. [MHz]	Reading [dBµV]	Cable Loss [dB]	Antenna Factor [dB]	AMP [dB]	Level [dBµV/m]	Limit [dBµV/m]	Margin [dB]	Detector	Polarity
1	5724.39	47.95	4.36	33.45	-40.81	44.95	74.00	29.05	PK	Horizontal
2	5725.00	45.60	4.36	33.45	-40.81	42.60	74.00	31.40	PK	Horizontal

Note:

- Level = Reading + Cable Loss + Antenna Factor + AMP
- If Peak Result complies with AV limit, AV Result is deemed to comply with AV limit.
- Test setup: RBW: 1 MHz, VBW: 3 MHz, Sweep time: auto.

TR-4-E-009 Radiated Emission Test Result

Test Date: 2023-01-31 **Tested By:** Bairong
EUT: LED COLOUR CHANGING CYLINDER SURFACE LIGHT KIT **Model Number:** 32000003
Test Mode: Tx mode **Power Supply:** AC 120V/60Hz
Condition: Temp:22.8°C;Humi:43.8%;Press:100.2kPa **Test Site:** DDT 3# Chamber
File Path: d:\ts\2022 report data\20230118 5.8G\FCC ABOVE 1G\18
Memo: 5730MHz

Test Graph

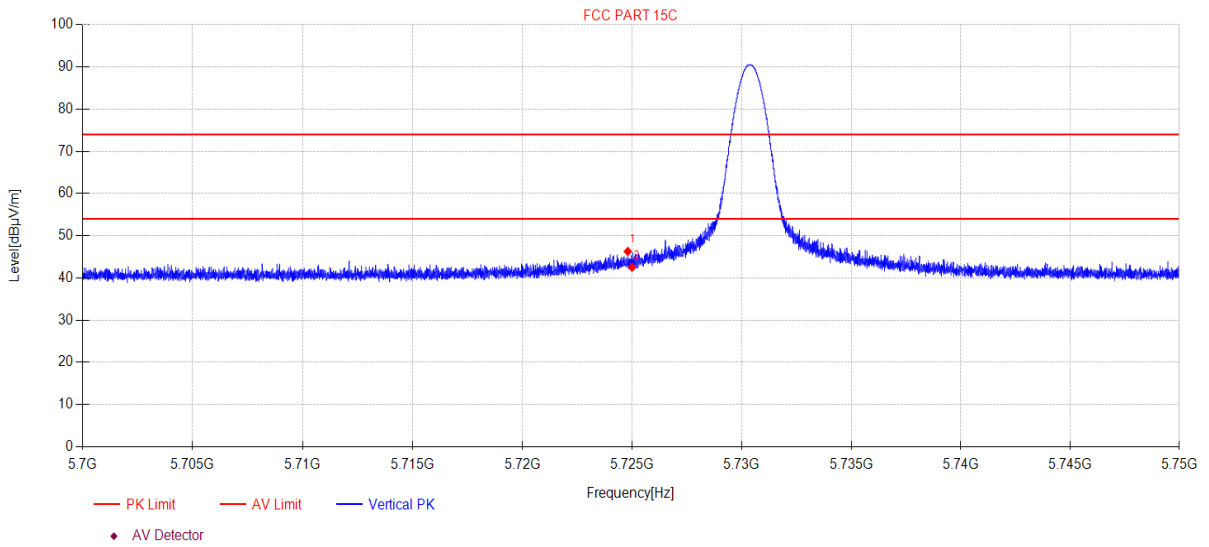

Suspected Data List										
NO.	Freq. [MHz]	Reading [dBµV]	Cable Loss [dB]	Antenna Factor [dB]	AMP [dB]	Level [dBµV/m]	Limit [dBµV/m]	Margin [dB]	Detector	Polarity
1	5724.81	49.28	4.36	33.45	-40.81	46.28	74.00	27.72	PK	Vertical
2	5725.00	45.53	4.36	33.45	-40.81	42.53	74.00	31.47	PK	Vertical

Note:

1. Level = Reading + Cable Loss + Antenna Factor + AMP
2. If Peak Result complies with AV limit, AV Result is deemed to comply with AV limit.
3. Test setup: RBW: 1 MHz, VBW: 3 MHz, Sweep time: auto.

TR-4-E-009 Radiated Emission Test Result

Test Date: 2023-01-31 **Tested By:** Bairong
EUT: LED COLOUR CHANGING CYLINDER SURFACE LIGHT KIT **Model Number:** 32000003
Test Mode: Tx mode **Power Supply:** AC 120V/60Hz
Condition: Temp:22.8°C;Humi:43.8%;Press:100.2kPa **Test Site:** DDT 3# Chamber
File Path: d:\ts\2022 report data\20230118 5.8G\FCC ABOVE 1G\19
Memo: 5860MHz

Test Graph

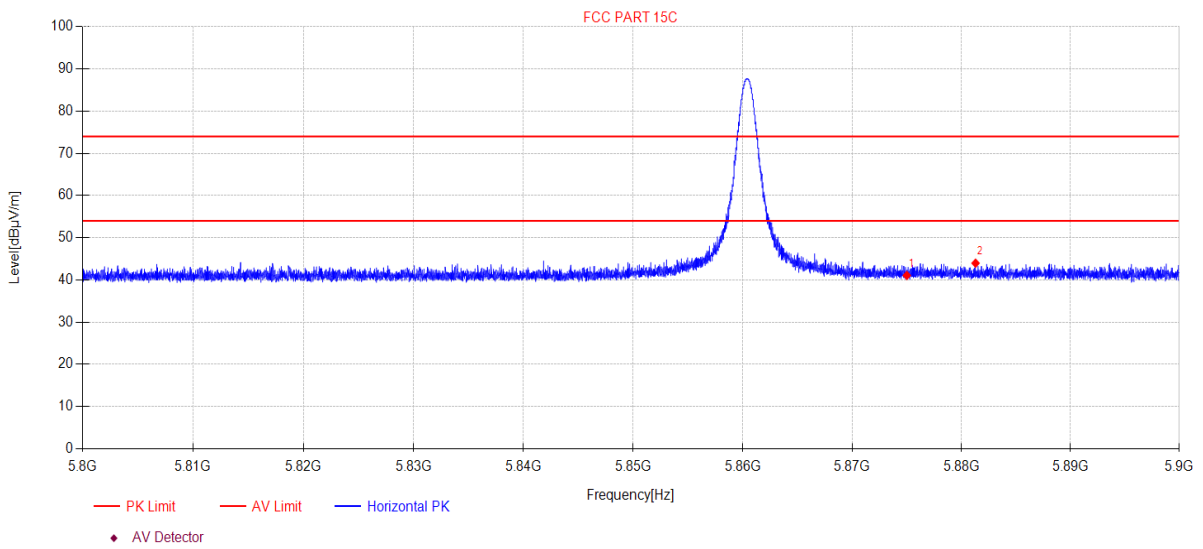

Suspected Data List										
NO.	Freq. [MHz]	Reading [dBµV]	Cable Loss [dB]	Antenna Factor [dB]	AMP [dB]	Level [dBµV/m]	Limit [dBµV/m]	Margin [dB]	Detector	Polarity
1	5875.00	43.56	4.41	33.85	-40.75	41.07	74.00	32.93	PK	Horizontal
2	5881.30	46.45	4.41	33.86	-40.75	43.97	74.00	30.03	PK	Horizontal

Note:

- Level = Reading + Cable Loss + Antenna Factor + AMP
- If Peak Result complies with AV limit, AV Result is deemed to comply with AV limit.
- Test setup: RBW: 1 MHz, VBW: 3 MHz, Sweep time: auto.

TR-4-E-009 Radiated Emission Test Result

Test Date: 2023-01-31 **Tested By:** Bairong
EUT: LED COLOUR CHANGING CYLINDER SURFACE LIGHT KIT **Model Number:** 32000003
Test Mode: Tx mode **Power Supply:** AC 120V/60Hz
Condition: Temp:22.8°C;Humi:43.8%;Press:100.2kPa **Test Site:** DDT 3# Chamber
File Path: d:\ts\2022 report data\20230118 5.8G\FCC ABOVE 1G\20
Memo: 5860MHz

Test Graph

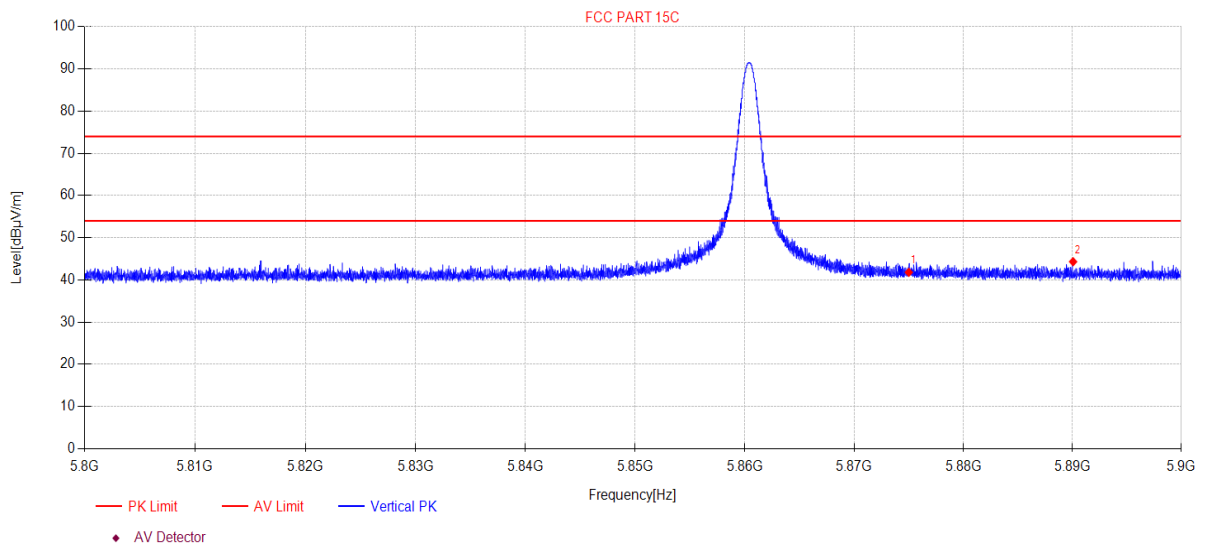

Suspected Data List										
NO.	Freq. [MHz]	Reading [dBµV]	Cable Loss [dB]	Antenna Factor [dB]	AMP [dB]	Level [dBµV/m]	Limit [dBµV/m]	Margin [dB]	Detector	Polarity
1	5875.00	44.29	4.41	33.85	-40.75	41.80	74.00	32.20	PK	Vertical
2	5890.06	46.76	4.42	33.88	-40.74	44.32	74.00	29.68	PK	Vertical

Note:

1. Level = Reading + Cable Loss + Antenna Factor + AMP
2. If Peak Result complies with AV limit, AV Result is deemed to comply with AV limit.
3. Test setup: RBW: 1 MHz, VBW: 3 MHz, Sweep time: auto.

7. Power Line Conducted Emission

7.1. Block diagram of test setup

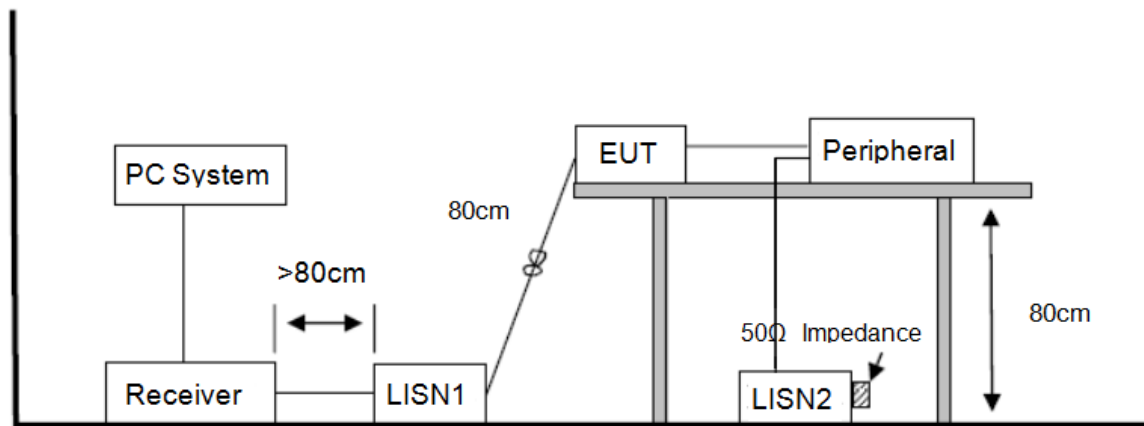

7.2. Power line conducted emission limits

Frequency	Quasi-Peak Level dB(μ V)	Average Level dB(μ V)
150 kHz ~ 500 kHz	66 ~ 56*	56 ~ 46*
500 kHz ~ 5 MHz	56	46
5 MHz ~ 30 MHz	60	50

Note 1: * Decreasing linearly with logarithm of frequency.

Note 2: The lower limit shall apply at the transition frequencies.

7.3. Test procedure

The EUT and Support equipment, if needed, were put placed on a non-metallic table, 80 cm above the ground plane.

Configuration EUT to simulate typical usage as described in clause 2.4 and test equipment as described in clause 7.1 of this report.

All I/O cables were positioned to simulate typical actual usage as per ANSI C63.10.

All support equipment power received from a second LISN.

Emissions were measured on each current carrying line of the EUT using an EMI Test Receiver connected to the LISN powering the EUT.

The Receiver scanned from 150 kHz to 30 MHz for emissions in each of the test modes.

During the above scans, the emissions were maximized by cable manipulation.

The test mode(s) described in clause 2.4 were scanned during the preliminary test.

After the preliminary scan, we found the test mode producing the highest emission level. The EUT configuration and worse cable configuration of the above highest emission levels were recorded for reference of the final test.

EUT and support equipment were set up on the test bench as per the configuration with highest emission level in the preliminary test.

A scan was taken on both power lines, Neutral and Line, recording at least the six highest emissions.

Emission frequency and amplitude were recorded into a computer in which correction factors were used to calculate the emission level and compare reading to the applicable limit.

The test data of the worst-case condition(s) was recorded.

The bandwidth of test receiver is set at 9 kHz.

7.4. Test result

Pass. (See below detailed test result)

Note1: All emissions not reported below are too low against the prescribed limits.

Note2: “-----” means Peak detection; “-----” means Average detection.

Note3: Pre-test AC conducted emission at both voltage AC 120V/60Hz and AC 240V/60Hz, recorded worst case.

TR-4-E-010 Conducted Emission Test Result

Test Site : DDT 1# Shield Room D:\2023 CE report data\Q23012904-2E\FCC.EM6
Test Date : 2023-02-15 **Tested By** : Johnson Huang
EUT : LED COLOUR CHANGING CYLINDER SURFACE LIGHT KIT **Model Number** : 32000003
Power Supply : AC 120V/60Hz **Test Mode** : Tx mode
Condition : TEMP:23.4°C, RH:54.1%, BP:101.2kPa **LISN** : 2021 1# ENV216/LINE
Memo :

Data: 6

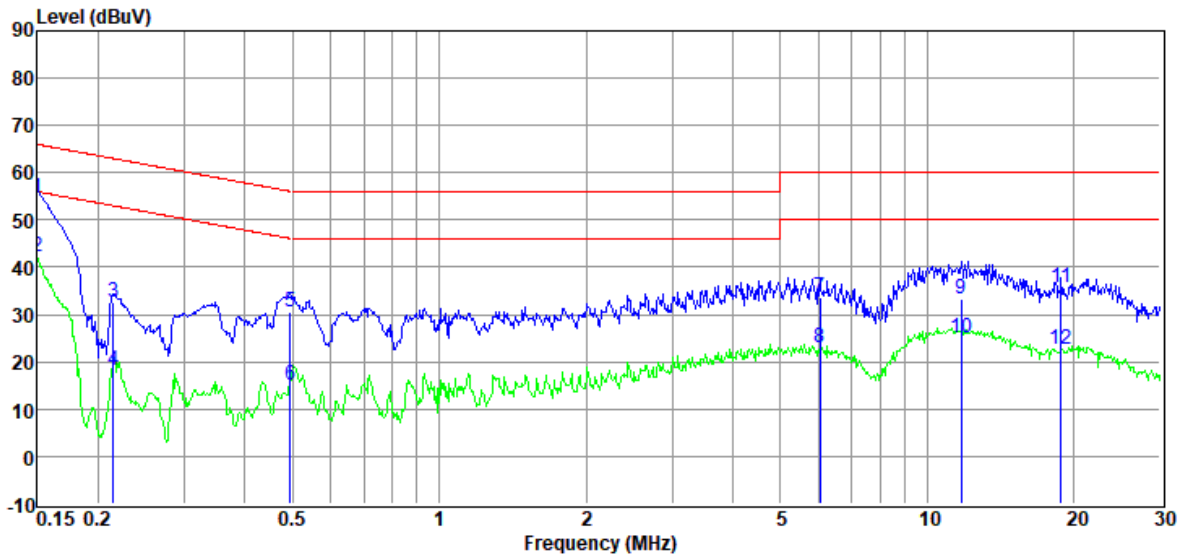

Item (Mark)	Freq. (MHz)	Read Level (dBUV)	LISN Factor (dB)	Cable Loss (dB)	Pulse Limiter Factor (dB)	Result Level (dBUV)	Limit Line (dBUV)	Over Limit (dB)	Detector	Phase
1	0.15	34.94	9.60	0.01	9.94	54.49	66.00	-11.51	QP	LINE
2	0.15	22.66	9.60	0.01	9.94	42.21	56.00	-13.79	Average	LINE
3	0.22	12.92	9.78	0.01	9.90	32.61	63.01	-30.40	QP	LINE
4	0.22	-1.37	9.78	0.01	9.90	18.32	53.01	-34.69	Average	LINE
5	0.49	11.13	9.60	0.01	9.92	30.66	56.10	-25.44	QP	LINE
6	0.49	-4.57	9.60	0.01	9.92	14.96	46.10	-31.14	Average	LINE
7	6.02	14.15	9.53	0.06	9.92	33.66	60.00	-26.34	QP	LINE
8	6.02	3.41	9.53	0.06	9.92	22.92	50.00	-27.08	Average	LINE
9	11.75	13.62	9.62	0.10	9.96	33.30	60.00	-26.70	QP	LINE
10	11.75	5.40	9.62	0.10	9.96	25.08	50.00	-24.92	Average	LINE
11	18.82	16.04	9.64	0.13	9.94	35.75	60.00	-24.25	QP	LINE
12	18.82	2.91	9.64	0.13	9.94	22.62	50.00	-27.38	Average	LINE

Note:

1. Result Level = Read Level + LISN Factor + Pulse Limiter Factor + Cable loss.
2. If QP Result complies with AV limit, AV Result is deemed to comply with AV limit.
3. Test setup: RBW: 200 Hz (9 kHz—150 kHz), 9 kHz (150 kHz—30 MHz).
4. Step size: 80Hz (0.009MHz-0.15MHz), 4 kHz (0.15MHz-30MHz), Scan time: auto.

TR-4-E-010 Conducted Emission Test Result

Test Site : DDT 1# Shield Room D:\2023 CE report data\Q23012904-2E\FCC.EM6
Test Date : 2023-02-15 **Tested By** : Johnson Huang
EUT : LED COLOUR CHANGING CYLINDER SURFACE LIGHT KIT **Model Number** : 32000003
Power Supply : AC 120V/60Hz **Test Mode** : Tx mode
Condition : TEMP:23.4°C, RH:54.1%, BP:101.2kPa **LISN** : 2021 1# ENV216/NEUTRAL
Memo :

Data: 8

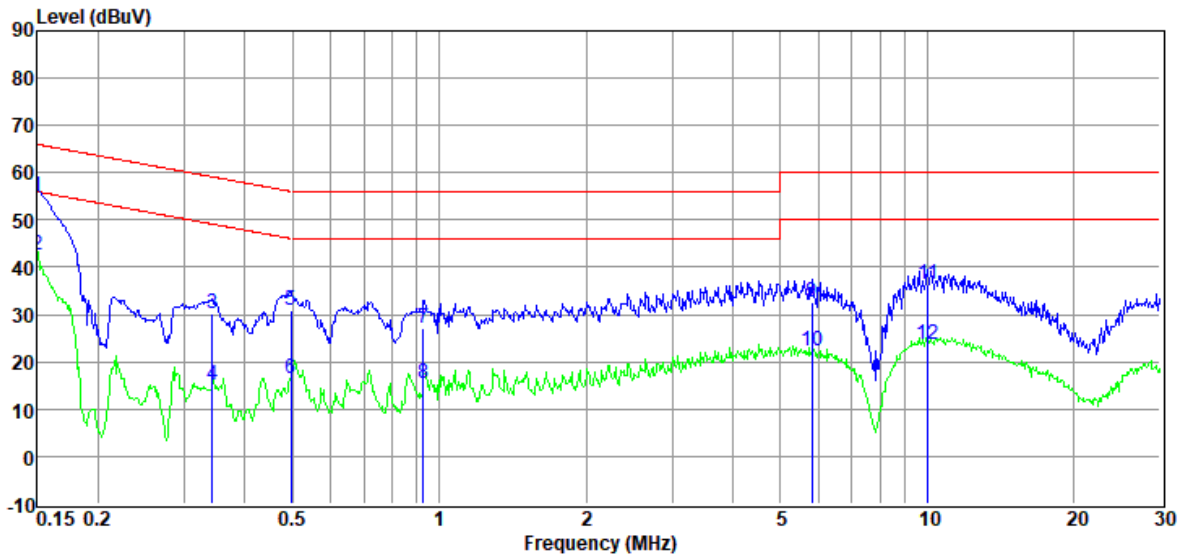

Item (Mark)	Freq. (MHz)	Read Level (dBUV)	LISN Factor (dB)	Cable Loss (dB)	Pulse Limiter Factor (dB)	Result Level (dBUV)	Limit Line (dBUV)	Over Limit (dB)	Detector	Phase
1	0.15	35.30	9.80	0.01	9.94	55.05	66.00	-10.95	QP	NEUTRAL
2	0.15	22.86	9.80	0.01	9.94	42.61	56.00	-13.39	Average	NEUTRAL
3	0.34	10.73	9.62	0.01	9.91	30.27	59.13	-28.86	QP	NEUTRAL
4	0.34	-4.59	9.62	0.01	9.91	14.95	49.13	-34.18	Average	NEUTRAL
5	0.50	11.53	9.50	0.01	9.92	30.96	56.05	-25.09	QP	NEUTRAL
6	0.50	-2.89	9.50	0.01	9.92	16.54	46.05	-29.51	Average	NEUTRAL
7	0.93	7.46	9.72	0.02	9.91	27.11	56.00	-28.89	QP	NEUTRAL
8	0.93	-4.13	9.72	0.02	9.91	15.52	46.00	-30.48	Average	NEUTRAL
9	5.81	12.97	9.67	0.06	9.92	32.62	60.00	-27.38	QP	NEUTRAL
10	5.81	2.67	9.67	0.06	9.92	22.32	50.00	-27.68	Average	NEUTRAL
11	10.02	16.44	9.80	0.09	9.96	36.29	60.00	-23.71	QP	NEUTRAL
12	10.02	3.96	9.80	0.09	9.96	23.81	50.00	-26.19	Average	NEUTRAL

Note:

1. Result Level = Read Level + LISN Factor + Pulse Limiter Factor + Cable loss.
2. If QP Result complies with AV limit, AV Result is deemed to comply with AV limit.
3. Test setup: RBW: 200 Hz (9 kHz—150 kHz), 9 kHz (150 kHz—30 MHz).
4. Step size: 80Hz (0.009MHz-0.15MHz), 4 kHz (0.15MHz-30MHz), Scan time: auto.

8. Antenna Requirements

8.1. Limit

For intentional device, according to FCC 47 CFR Section 15.203, an intentional radiator shall be designed to ensure that no antenna other than that furnished by the responsible party shall be used with the device. And according to FCC 47 CFR Section 15.247 (b), if transmitting antennas of directional gain greater than 6 dBi are used, the power shall be reduced by the amount in dB that the directional gain of the antenna exceeds 6 dBi.

For intentional device, according to RSS-Gen issue 5 section 6.8.

The applicant for equipment certification shall provide a list of all antenna types that may be used with the transmitter, where applicable (i.e. for transmitters with detachable antenna), indicating the maximum permissible antenna gain (in dBi) and the required impedance for each antenna.

The test report shall demonstrate the compliance of the transmitter with the limit for maximum equivalent isotropically radiated power (e.i.r.p.) specified in the applicable RSS, when the transmitter is equipped with any antenna type, selected from this list.

8.2. Result

The antenna used for this product is PCB antenna and that no antenna other than that furnished by the responsible party shall be used with the device, the maximum peak gain of the transmit antenna is 2.6 dBi.

9. Test Setup Photograph





10. Photos of the EUT

Please refer to appendix I.

END OF REPORT