



■ Report No.:DDT-R23031611-7E01

■ Issued Date: Mar. 31, 2023

# FCC AND ISED CERTIFICATION TEST REPORT

FOR

<b>Applicant</b>	:	Globe Electric Company Inc.
<b>Address</b>	:	150 Oneida, Montreal, Quebec, Canada, H9R 1A8
<b>Equipment under Test</b>	:	SMART DOORBELL KIT
<b>Model No.</b>	:	GB156TX
<b>Trade Mark</b>	:	Globe
<b>FCC ID</b>	:	2AQUQGB156TX
<b>IC</b>	:	8290A-GB156TX
<b>Manufacturer</b>	:	Globe Electric Company Inc.
<b>Address</b>	:	150 Oneida, Montreal, Quebec, Canada, H9R 1A8

**Issued By: Dongguan Dongdian Testing Service Co., Ltd.**

**Add.:** No. 17, Zongbu Road 2, Songshan Lake Sci&Tech, Industry Park,  
Dongguan City, Guangdong Province, China, 523808

**Tel.:** +86-0769-38826678, **E-mail:** ddt@dgddt.com, <http://www.dgddt.com>

# REPORT

## Table of Contents

	Test report declares.....	4
1.	Summary of Test Results.....	6
2.	General Test Information .....	7
2.1.	Description of EUT .....	7
2.2.	Accessories of EUT.....	7
2.3.	Assistant equipment used for test.....	7
2.4.	Block diagram of EUT configuration for test .....	7
2.5.	Test environment conditions .....	7
2.6.	Deviations of test standard.....	8
2.7.	Test laboratory .....	8
2.8.	Measurement uncertainty.....	8
3.	Equipment Used During Test.....	9
4.	On Time and Duty Cycle.....	10
4.1.	Block diagram of test setup.....	10
4.2.	Limits .....	10
4.3.	Test Procedure.....	10
4.4.	Test Result .....	10
4.5.	Original test data .....	11
5.	20dB Bandwidth and 99% Bandwidth.....	12
5.1.	Block diagram of test setup.....	12
5.2.	Limits .....	12
5.3.	Test Procedure.....	12
5.4.	Test Result .....	12
5.5.	Original test data .....	13
6.	Stop transmitting time test.....	14
6.1.	Block diagram of test setup.....	14
6.2.	Limits .....	14
6.3.	Test Procedure.....	14
6.4.	Test Result .....	14
6.5.	Original test data .....	14
7.	Radiated Emission .....	15
7.1.	Block diagram of test setup.....	15
7.2.	Limit .....	16
7.3.	Test Procedure.....	18
7.4.	Test result.....	19
8.	Power Line Conducted Emission .....	26
8.1.	Block diagram of test setup.....	26

8.2.	Power line conducted emission limits .....	26
8.3.	Test procedure .....	26
8.4.	Test result.....	27
9.	Antenna Requirements .....	30
9.1.	Limit.....	30
9.2.	Result .....	30
10.	Test Setup Photograph .....	31
11.	Photos of the EUT .....	34

## Test Report Declare

<b>Applicant</b>	:	Globe Electric Company Inc.
<b>Address</b>	:	150 Oneida, Montreal, Quebec, Canada, H9R 1A8
<b>Equipment under Test</b>	:	SMART DOORBELL KIT
<b>Model No.</b>	:	GB156TX
<b>Trade Mark</b>	:	Globe
<b>Manufacturer</b>	:	Globe Electric Company Inc.
<b>Address</b>	:	150 Oneida, Montreal, Quebec, Canada, H9R 1A8

### Test Standard Used:

FCC Rules and Regulations Part 15 Subpart C, RSS-210 Issue 10 February 2019.

### Test Procedure Used:

ANSI C63.10:2013, RSS-Gen Issue 5, Apr. 2018, Amendment 2 (February 2021)

### We Declare:

The equipment described above is tested by Dongguan Dongdian Testing Service Co., Ltd. and in the configuration tested the equipment complied with the standards specified above. The test results are contained in this test report and Dongguan Dongdian Testing Service Co., Ltd. is assumed of full responsibility for the accuracy and completeness of these tests.

**After test and evaluation, our opinion is that the equipment provided for test compliance with the requirement of the above FCC&ISED standards.**

<b>Report No.:</b>	DDT-R23031611-7E01		
<b>Date of Receipt:</b>	Mar. 16, 2023	<b>Date of Test:</b>	Mar. 16, 2023 ~ Mar. 31, 2023

**Prepared By:**

*Tiger Mo*

**Tiger Mo/Engineer**

**Approved By:**



**Damon Hu/EMC Manager**

Note: This report applies to above tested sample only. This report shall not be reproduced in parts without written approval of Dongguan Dongdian Testing Service Co., Ltd.

### Revision History

Rev.	Revisions	Issue Date	Revised By
---	Initial issue	Mar. 31, 2023	

## 1. Summary of Test Results

The EUT have been tested according to the applicable standards as referenced below.		
Description of Test Item	Standard	Verdict
20dB Bandwidth and 99% Bandwidth	FCC Part 15: 15.231 ANSI C63.10:2013 RSS-210 Issue 10 RSS-Gen Issue 5	PASS
Stop Transmitting Time Test	FCC Part 15C: 15.231(a) RSS-210 Issue 10	PASS
Radiated Emission	FCC Part 15: 15.209 FCC Part 15: 15.231(b) ANSI C63.10:2013 RSS-210 Issue 10 RSS-Gen Issue 5	PASS
Power Line Conducted Emissions	FCC Part 15: 15.207 ANSI C63.10:2013 RSS-210 Issue 10 RSS-Gen Issue 5	PASS
Antenna requirement	FCC Part 15: 15.203 RSS-210 Issue 10 RSS-Gen Issue 5	PASS

Note: N/A is an abbreviation for Not Applicable.

## 2. General Test Information

### 2.1. Description of EUT

EUT Name	: SMART DOORBELL KIT
Model Number	: GB156TX
EUT Function Description	: Please reference user manual of this device
Power Supply	: AC 16V/60Hz 0.6A From transformer
Operation Frequency	: 315 MHz
Modulation	: OOK
Antenna Gain	: Spring antenna, maximum PK gain: -2 dBi
Sample Number	: S23031611-24 for conductive S23031611-25 for radiation

Note: EUT is the ab. of equipment under test.

### 2.2. Accessories of EUT

Description of Accessories	Manufacturer	Model number	Description	Remark
N/A	N/A	N/A	N/A	N/A

### 2.3. Assistant equipment used for test

Assistant equipment	Manufacturer	Model number	EMC Compliance	SN
transformer	ZHEJIANG BERNAL ELECTRICCO.,LTD	122	Input: AC120V/60Hz Output: AC16V/60Hz	N/A

### 2.4. Block diagram of EUT configuration for test

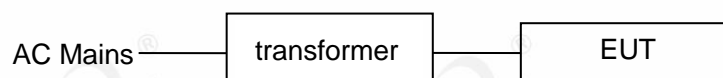

The pathloss of external cable: 0.5dB (According to the manufacturer's claims)

Tested mode, channel, information		
Mode	Channel	Frequency (MHz)
TX mode	/	315

### 2.5. Test environment conditions

Temperature range:	+15°C to +35 °C
Humidity range:	20% to 75%
Pressure range:	86 kPa to106 kPa

## 2.6. Deviations of test standard

No deviation.

## 2.7. Test laboratory

Dongguan Dongdian Testing Service Co., Ltd.

Add.: No. 17, Zongbu Road 2, Songshan Lake Sci&Tech, Industry Park, Dongguan City, Guangdong Province, China, 523808.

Tel.: +86-0769-38826678, <http://www.dgddt.com>, Email: [ddt@dgddt.com](mailto:ddt@dgddt.com).

CNAS Accreditation No. L6451; A2LA Accreditation Number: 3870.01

FCC Designation Number: CN1182, Test Firm Registration Number: 540522

Innovation, Science and Economic Development Canada Site Registration Number: 10288A

Conformity Assessment Body identifier: CN0048

VCCI facility registration number: C-20087, T-20088, R-20123, R-20155, G-20118

## 2.8. Measurement uncertainty

Test Item	Uncertainty
Bandwidth	1.1%
Peak Output Power (Conducted) (Spectrum analyzer)	0.86 dB (10 MHz ≤ f < 3.6 GHz);
	1.38 dB (3.6 GHz ≤ f < 8 GHz)
Peak Output Power (Conducted) (Power Sensor)	0.74 dB
Power Spectral Density	0.74 dB (10 MHz ≤ f < 3.6 GHz);
	1.38 dB (3.6 GHz ≤ f < 8 GHz)
Frequencies Stability	6.7 x 10 <sup>-8</sup> (Antenna couple method)
	5.5 x 10 <sup>-8</sup> (Conducted method)
Conducted spurious emissions	0.86 dB (10 MHz ≤ f < 3.6 GHz);
	1.40 dB (3.6 GHz ≤ f < 8 GHz)
	1.66 dB (8 GHz ≤ f < 26.5 GHz)
Uncertainty for radio frequency (RBW < 20 kHz)	3x10 <sup>-8</sup>
Temperature	0.4 °C
Humidity	2 %
Uncertainty for Radiation Emission test (9 kHz – 30 MHz)	3.44 dB
Uncertainty for Radiation Emission test (30 MHz - 1 GHz)	4.70 dB (Antenna Polarize: V)
	4.84 dB (Antenna Polarize: H)
Uncertainty for Radiation Emission test (1 GHz - 40 GHz)	4.10 dB (1 - 6 GHz)
	4.40 dB (6 GHz - 18 GHz)
	3.54 dB (18 GHz - 26 GHz)
	4.30 dB (26 GHz - 40 GHz)
Uncertainty for Power line conduction emission test	3.34dB (150KHz-30MHz)
	3.72dB (9KHz-150KHz)

Note: This uncertainty represents an expanded uncertainty expressed at approximately the 95% confidence level using a coverage factor of k=2.



### 3. Equipment Used During Test

Equipment	Manufacturer	Model No.	Serial No.	Last Cal.	Cal. Interval
<b>☒RF Connected Test (Tonscend RF Measurement System 2#)</b>					
Spectrum analyzer	R&S	FSU26	200071	Apr. 26, 2022	Apr. 25, 2023
Test Software	JS Tonscend	JS1120-3	Ver.3.2.22	N/A	N/A
<b>☒Radiation 3#chamber</b>					
EMI Test Receiver	R&S	ESU26	100472	May 19, 2022	1 Year
Spectrum analyzer	Agilent	E4447A	MY50180031	May 17, 2022	1 Year
Active Loop antenna	Schwarzbeck	FMZB-1519	1519-038	Sep. 29, 2022	1 Year
Trilog Broadband Antenna	Schwarzbeck	VULB 9163	01429	Jul. 22, 2022	1 Year
Double Ridged Horn Antenna	Schwarzbeck	BBHA9120 D	02468	Sep. 29, 2022	1 Year
Broad Band Horn Antenna	Schwarzbeck	BBHA 9170	790	May 06, 2022	1 Year
Pre-amplifier	COM-POWER	PAM-118A	18040084	Aug. 17, 2022	1 Year
Pre-amplifier	COM-POWER	PAM-840A	461369	Apr. 11, 2022	1 Year
RE Cable	N/A	W23.02 CP1-X2 + W23.09 AP1-X8+ JCT26S-NJ-NJ-1.5M+ JCT26S-NJ-NJ-1.5M	4.5M+8M+1.5M+1.5M	Aug.17, 2022	1 Year
RF Cable	Yuhu Technology	JCTB810-NJ-NJ-9M	21123964	May 19, 2022	1 Year
RF Cable	Yuhu Technology	ZT26S-SMAJ-SMAJ-1M	21073466	Aug. 17, 2022	1 Year
Test software	Tonscend	JS32-RE	V 5.0.0.1	N/A	N/A
<b>☒Power Line Conducted Emissions Test 1#</b>					
Test Receiver	R&S	ESCI	100551	Aug. 26, 2022	1 Year
LISN 1	R&S	ENV216	101109	Aug. 26, 2022	1 Year
LISN 2	R&S	ESH2-Z5	100309	Aug. 26, 2022	1 Year
Pulse Limiter	R&S	ESH3-Z2	101242	Aug. 26, 2022	1 Year
CE Cable 1	HUBSER	N/A	W10.01	Aug. 26, 2022	1 Year
Test software	Audix	E3	V 6.11111b	N/A	N/A
Test Receiver	R&S	ESCI	100551	Aug. 26, 2022	1 Year

## 4. On Time and Duty Cycle

### 4.1. Block diagram of test setup

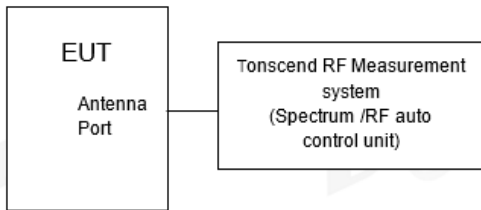

### 4.2. Limits

None: for reporting purposes only.

### 4.3. Test Procedure

Set the Centre frequency of the spectrum analyzer to the transmitting frequency;

Set the span=0 MHz, RBW=1 MHz, VBW=1 MHz, Sweep time=100 ms;

Trace mode = Single hold.

### 4.4. Test Result

Test Channel[MHz]	Duty Cycle[%]	20log( $\Delta$ ) Factor[dB]
315	17.59	-15.09

Note 1: The transmitter duty cycle was measured using a spectrum analyser in the time domain and calculated by below Equation:

$$\Delta = (0.317 \times 29) + (1.042 \times 2) = 11.277 \text{ ms}$$

$$\delta(\text{dB}) = 20 \log(\Delta) = 20 \log(11.277/64.10) = -15.09 \text{ dB}$$

$\delta$  is the duty cycle correction factor (dB)

$\Delta$  is the duty cycle (dimensionless)

Note 2: In cases where the pulse train exceeds 0.1 s, the measured field strength shall be determined during a 0.1 s interval

### 4.5. Original test data



## 5. 20dB Bandwidth and 99% Bandwidth

### 5.1. Block diagram of test setup

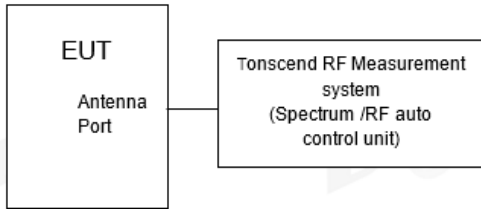

### 5.2. Limits

The bandwidth of the emission shall be no wider than 0.25% of the center frequency of devices operation above 70MHz and below 900MHz.

### 5.3. Test Procedure

- (1) Connect EUT's antenna output to spectrum analyzer by RF cable.
- (2) The bandwidth of the fundamental frequency was measured by spectrum analyzer with 3kHz RBW and 10kHz VBW. The 20dB bandwidth is defined as the total spectrum the power of which is higher than peak power minus 20dB.

### 5.4. Test Result

Frequency (MHz)	20 dB Bandwidth (kHz)	99% Bandwidth (kHz)	Limit (kHz)	Verdict
315	18.43	62.5	787.5	PASS

### 5.5. Original test data

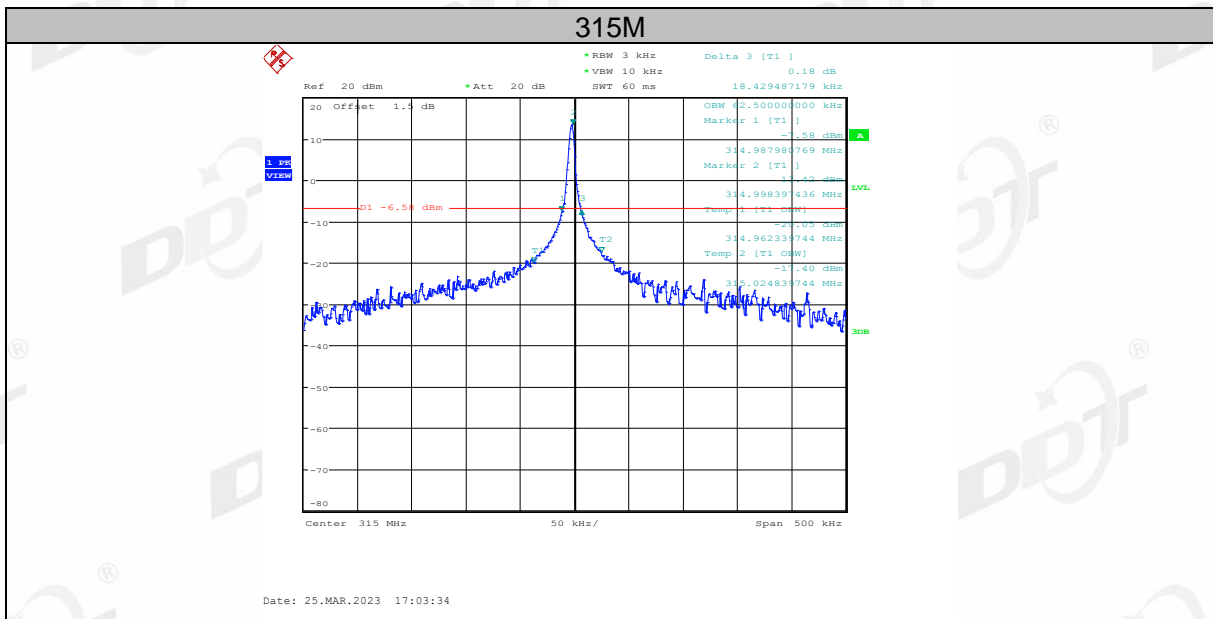

## 6 Stop transmitting time test

### 6.1. Block diagram of test setup

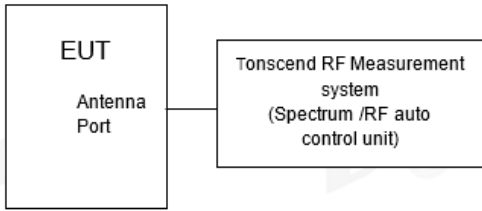

### 6.2. Limits

15.231(a), A manually operated transmitter shall employ a switch that will automatically deactivate the transmitter within not more than 5 seconds of being released.

### 6.3. Test Procedure

- (1) The EUT's RF signal was coupled to spectrum analyzer by antenna connected to spectrum analyzer.
- (2) Set the spectrum to zero span mode, and centered of EUT frequency.
- (3) Measure the stop transmitting time after release EUT button.

### 6.4. Test Result

Frequency (MHz)	Burst Duration[s]	Limit [s]	Verdict
315	1.20	≤5	PASS

### 6.5. Original test data

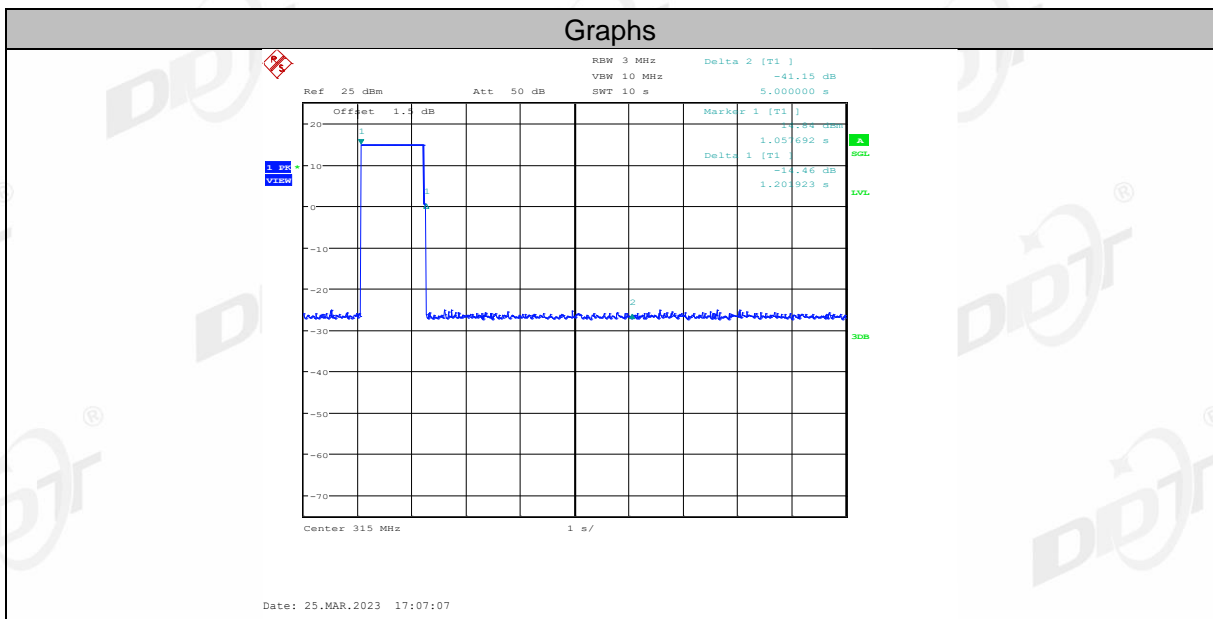

## 7. Radiated Emission

### 7.1. Block diagram of test setup

In 3 m Anechoic Chamber, test setup diagram for 9 kHz - 30 MHz:

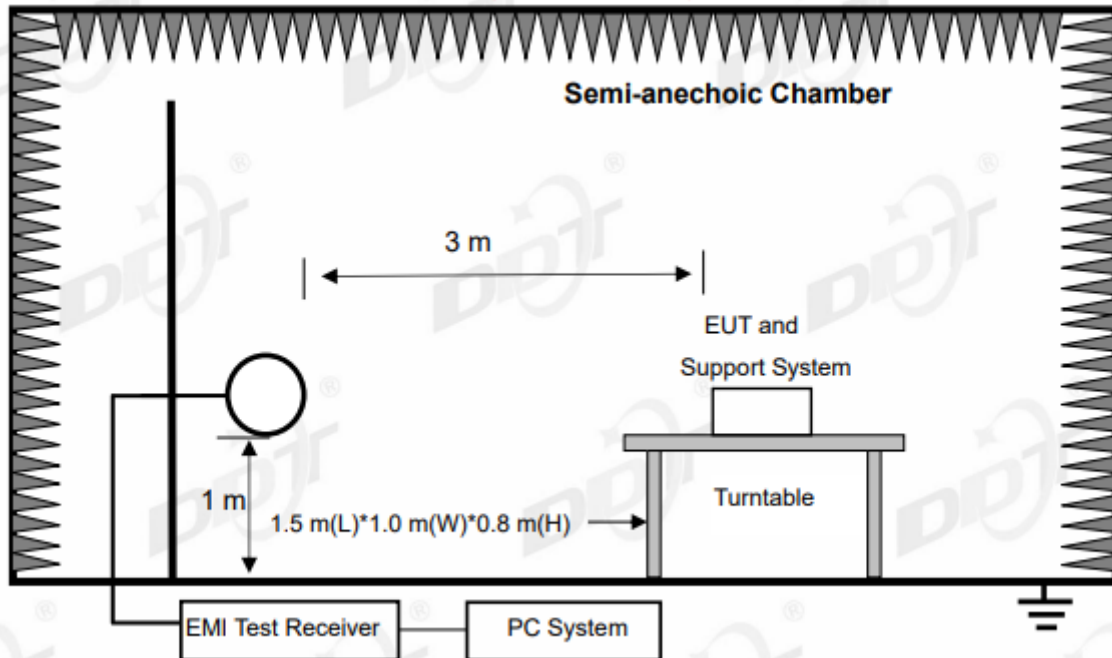

In 3 m Anechoic Chamber, test setup diagram for 30 MHz - 1 GHz:

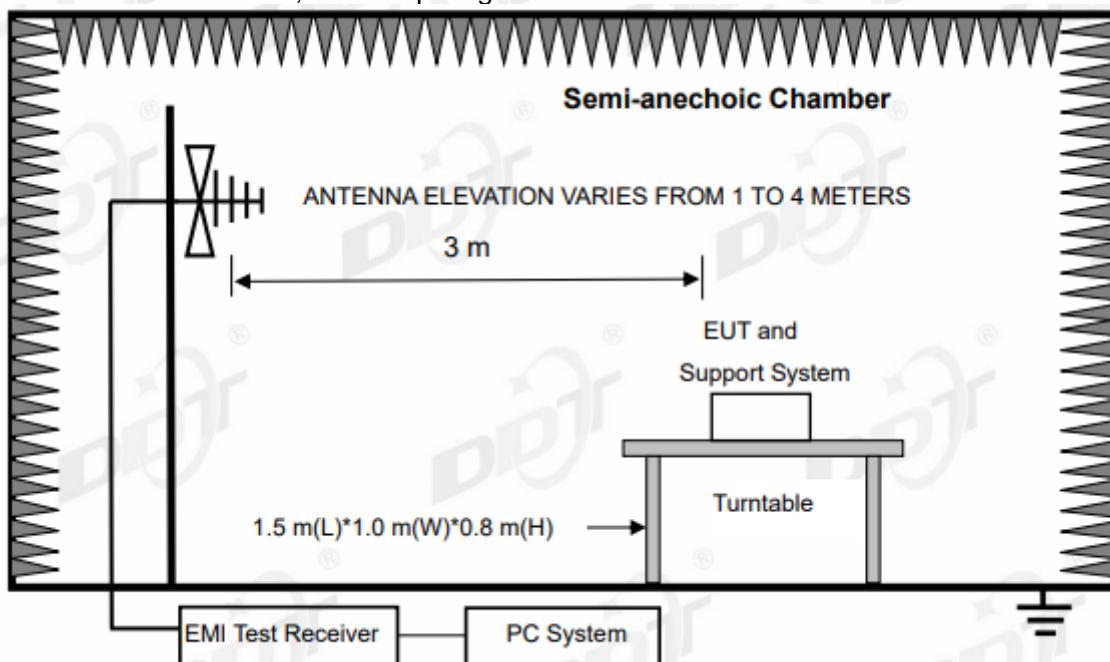

In 3 m Anechoic Chamber, test setup diagram for frequency above 1 GHz:

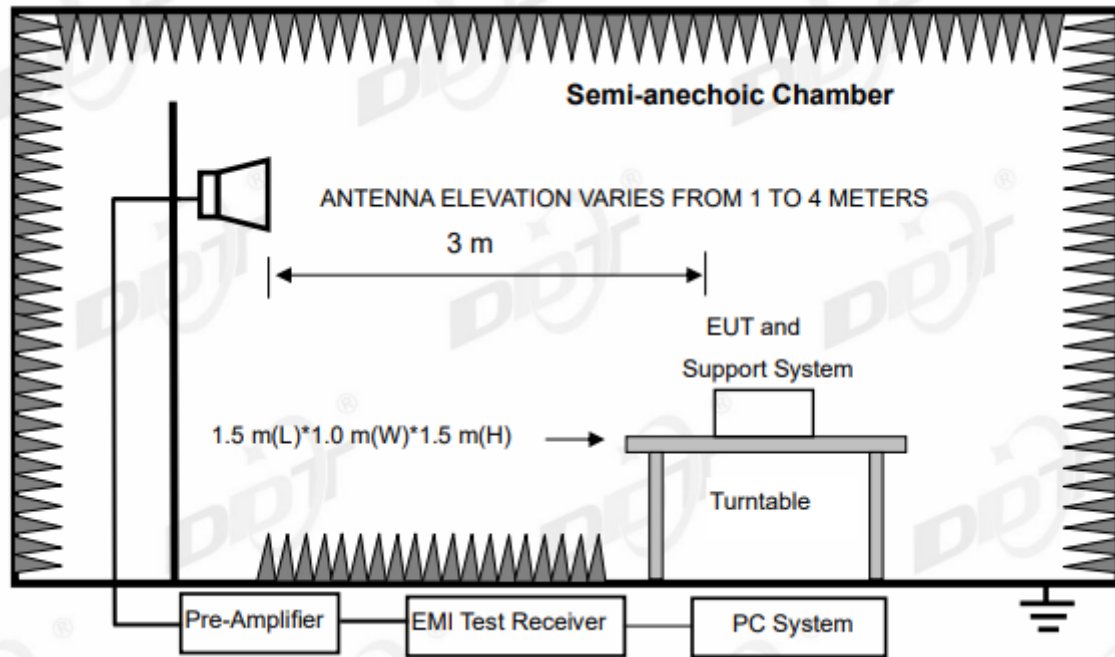

Note: For harmonic emissions test an appropriate high pass filter was inserted in the input port of AMP.

## 7.2. Limit

(1) FCC 15.205 Restricted frequency band

MHz	MHz	MHz	GHz
0.090-0.110	16.42-16.423	399.9-410	4.5-5.15
<sup>1</sup> 0.495-0.505	16.69475-16.69525	608-614	5.35-5.46
2.1735-2.1905	16.80425-16.80475	960-1240	7.25-7.75
4.125-4.128	25.5-25.67	1300-1427	8.025-8.5
4.1772&4.17775	37.5-38.25	1435-1626.5	9.0-9.2
4.2072&4.20775	73-74.6	1645.5-1646.5	9.3-9.5
6.215-6.218	74.8-75.2	1660-1710	10.6-12.7
6.26775-6.26825	108-121.94	1718.8-1722.2	13.25-13.4
6.31175-6.31225	123-138	2200-2300	14.47-14.5
8.291-8.294	149.9-150.05	2310-2390	15.35-16.2
8.362-8.366	156.52475-156.52525	2483.5-2500	17.7-21.4
8.37625-8.38675	156.7-156.9	2690-2900	22.01-23.12
8.41425-8.41475	162.0125-167.17	3260-3267	23.6-24.0
12.29-12.293	167.72-173.2	3332-3339	31.2-31.8
12.51975-12.52025	240-285	3345.8-3358	36.43-36.5
12.57675-12.57725	322-335.4	3600-4400	( <sup>2</sup> )
13.36-13.41			

<sup>1</sup>Until February 1, 1999, this restricted band shall be 0.490-0.510 MHz.

<sup>2</sup>Above 38.6



## RSS-Gen section 8.10 Restricted frequency bands\*

MHz	MHz	MHz	GHz
0.090-0.110	12.51975-12.52025	240-285	3.5-4.4
0.495-0.505	12.57675-12.57725	322-335.4	4.5-5.15
2.1735-2.1905	13.36-13.41	399.9-410	5.35-5.46
3.020-3.026	16.42-16.423	608-614	7.25-7.75
4.125-4.128	16.69475-16.69525	960-1427	8.025-8.5
4.1772&4.17775	16.80425-16.80475	1435-1626.5	9.0-9.2
4.2072&4.20775	25.5-25.67	1645.5-1646.5	9.3-9.5
5.677-5.683	37.5-38.25	1660-1710	10.6-12.7
6.215-6.218	73-74.6	1718.8-1722.2	13.25-13.4
6.26775-6.26825	74.8-75.2	2200-2300	14.47-14.5
6.31175-6.31225	108-138	2310-2390	15.35-16.2
8.291-8.294	149.9-150.05	2483.5-2500	17.7-21.4
8.362-8.366	156.52475-156.52525	2655-2900	22.01-23.12
8.37625-8.38675	156.7-156.9	3260-3267	23.6-24.0
8.41425-8.41475	162.0125-167.17	3332-3339	31.2-31.8
12.29-12.293	167.72-173.2	3345.8-3358	36.43-36.5
			Above 38.6

\* Certain frequency bands listed in table and in bands above 38.6 GHz are designated for licence-exempt applications. These frequency bands and the requirements that apply to related devices are set out in the 200 and 300 series of RSSs.

## (2) FCC 15.209 Limit &amp; RSS-Gen section 8.9 Limit

FREQUENCY MHz	DISTANCE Meters	FIELD STRENGTHS LIMIT	
		$\mu\text{V}/\text{m}$	$\text{dB}(\mu\text{V})/\text{m}$
0.009 ~ 0.490	300	2400/F(kHz)	67.6-20log(F)
0.490 ~ 1.705	30	24000/F(kHz)	87.6-20log(F)
1.705 ~ 30.0	30	30	29.54
30 ~ 88	3	100	40.0
88 ~ 216	3	150	43.5
216 ~ 960	3	200	46.0
960 ~ 1000	3	500	54.0
Above 1000	3	74.0 dB( $\mu\text{V}$ )/m (Peak) 54.0 dB( $\mu\text{V}$ )/m (Average)	

## (3) FCC 15.231 section (b) limit

Fundamental Frequency (MHz)	Field Strength of Fundamental	Field strength of spurious emission
315	AV:75.62dBuV/m @3m PK:95.62dBuV/m @3m	AV:55.62dBuV/m @3m PK:75.62dBuV/m @3m

Note: (1) The emission limits shown in the above table are based on measurements employing a CISPR QP detector except for the frequency bands 9 - 90 kHz, 110 - 490 kHz and above 1000 MHz. Radiated emissions limits in these three bands are based on measurements employing an average detector.

(2) At frequencies below 30 MHz, measurement may be performed at a distance closer than

that specified, and the limit at closer measurement distance can be extrapolated by below formula:

$$\text{Limit}_{3\text{m}}(\text{dBuV/m}) = \text{Limit}_{30\text{m}}(\text{dBuV/m}) + 40\text{Log}(30\text{m}/3\text{m})$$

#### (4) Limit for this EUT

The emissions appearing within 15.205 restricted frequency bands shall not exceed the limits shown in 15.209, and the emissions appearing within RSS-Gen section 8.10 Restricted frequency bands shall not exceed the limits shown in RSS-Gen section 8.9, all the other emissions shall be at least 20 dB below the fundamental emissions or comply with 15.209 limits and RSS-Gen section 8.9 limits.

### 7.3. Test Procedure

- (1) EUT was placed on a non-metallic table, 80 cm above the ground plane inside a semi-anechoic chamber for below 1 G and 150 cm above the ground plane inside a semi-anechoic chamber for above 1 G.
- (2) Test antenna was located 3 m from the EUT on an adjustable mast, and the antenna used as below table.

Test frequency range	Test antenna used	Test antenna distance
9 kHz - 30 MHz	Active Loop antenna	3 m
30 MHz - 1 GHz	Trilog Broadband Antenna	3 m
1 GHz - 18 GHz	Double Ridged Horn Antenna (1 GHz - 18 GHz)	3 m
18 GHz - 40 GHz	Horn Antenna (18 GHz - 40 GHz)	1 m

According ANSI C63.10:2013 clause 6.4.6 and 6.5.3, for measurements below 30 MHz, Antenna was located 3 m from EUT, the loop antenna was positioned in three antenna orientations (parallel, perpendicular, and round-parallel), for each measurement antenna alignment, the EUT shall be rotated through 0° to 360° on a turntable, and the lowest height of the magnetic antenna shall be 1 m above the ground. For measurement above 30 MHz, the Trilog Broadband Antenna or Horn Antenna was located 3 m from EUT, Measurements were made with the antenna positioned in both the horizontal and vertical planes of Polarization, and the measurement antenna was varied from 1 m to 4 m. in height above the reference ground plane to obtain the maximum signal strength.

- (3) Below pre-scan procedure was first performed in order to find prominent frequency spectrum radiated emissions from 9 kHz to 25 GHz:
  - (a) Scanning the peak frequency spectrum with the antenna specified in step (3), and the EUT was rotated 360 degree, the antenna height was varied from 1 m to 4 m (Except loop antenna, it's fixed 1 m above ground.)
  - (b) Change work frequency or channel of device if practicable.
  - (c) Change modulation type of device if practicable.
  - (d) Change power supply range from 85% to 115% of the rated supply voltage

(e) Rotated EUT through three orthogonal axes to determine the attitude of EUT arrangement produces highest emissions.

Spectrum frequency from 9 kHz to 25 GHz (tenth harmonic of fundamental frequency) was investigated, and no any obvious emission were detected from 9 kHz to 30 MHz and 18 GHz to 25 GHz, so below final test was performed with frequency range from 30 MHz to 18 GHz.

(4) For final emissions measurements at each frequency of interest, the EUT was rotated and the antenna height was varied between 1 m and 4 m in order to maximize the emission. Measurements in both horizontal and vertical polarities were made and the data was recorded.

In order to find the maximum emission, the relative positions of equipments and all of the interface cables were changed according to ANSI C63.10:2013 on Radiated Emission test.

(5) The emissions from 9 kHz to 1 GHz were measured based on CISPR QP detector except for the frequency bands 9 - 90 kHz, 110 - 490 kHz, for emissions from 9 kHz - 90 kHz, 110 kHz - 490 kHz and above 1 GHz were measured based on average detector, for emissions above 1 GHz, peak emissions also be measured and need comply with Peak limit.

(6) The emissions from 9 kHz to 1 GHz, QP or average values were measured with EMI receiver with below RBW

Frequency band	RBW
9 kHz - 150 kHz	200 Hz
150 kHz - 30 MHz	9 kHz
30 MHz - 1 GHz	120 kHz

For emissions above 1 GHz, both Peak and Average level were measured with Spectrum Analyzer, and the RBW is set at 1 MHz, VBW is set at 3 MHz for Peak measure; According ANSI C63.10:2013 clause 4.1.4.2.2 procedure for average measure.

#### 7.4. Test result

Pass. (See below detailed test result)

All the emissions except fundamental emission from 9 kHz to 25 GHz were comply with 15.209 limits and RSS-Gen section 8.9 limits.

Note1: According exploratory test, the emission levels are 20 dB below the limit detected from 9 kHz to 30 MHz and 18 GHz to 25 GHz, so the final test was performed with frequency range from 30 MHz to 18 GHz and recorded in below.

Note2: 30 MHz ~ 25 GHz: (Scan with 315M, the worst case is reported)

Note3: For emissions below 1 GHz, according exploratory explorer test, when change Tx mode and channel, have no distinct influence on emissions level, so for emissions below 1 GHz, the final test was only performed with EUT working in OOK 315 MHz mode.

Note4: For emissions above 1 GHz. If peak results comply with AV limit, AV Result is deemed to comply with AV limit.

Radiated Emission test (below 1 GHz)

TR-4-E-009 Radiated Emission Test Result

**Test Date:** 2023-03-24      **Tested By:** Bairong  
**EUT:** SMART DOORBELL KIT      **Model Number:** GB156TX  
**Test Mode:** TX Mode      **Power Supply:** AC 16V/60Hz 0.6A From transformer  
**Condition:** Temp:24.0°C;Humi:61.2%      **Test Site:** DDT 3# Chamber  
**File Path:** d:\ts\2023 report date\Q23031611-7E 18000156TX\FCC BELOW 1G\20230324-103900\_H  
**Memo:** 315MHz

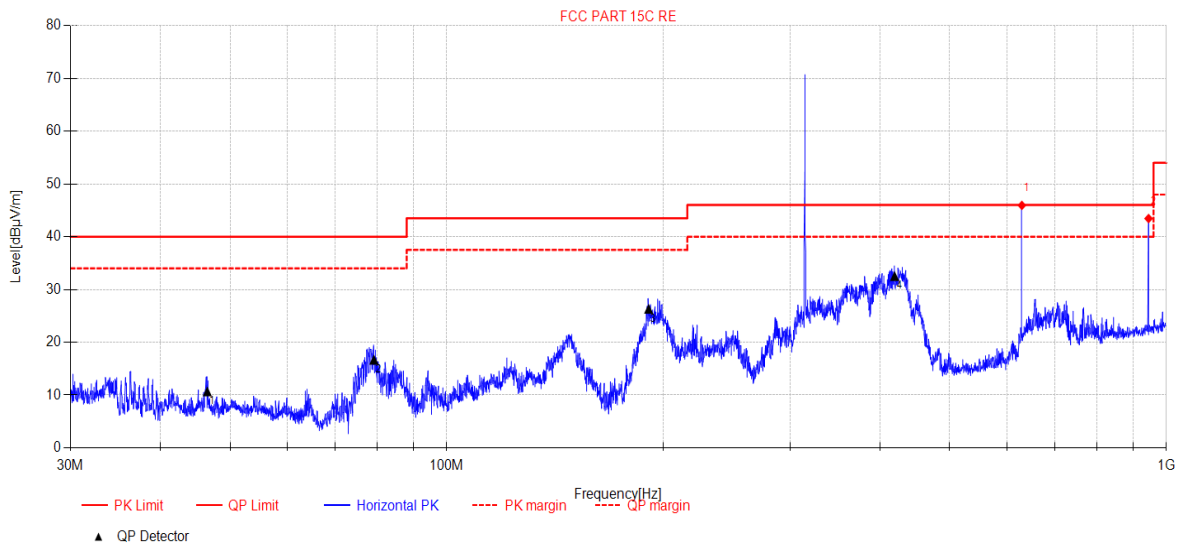

Suspected Data List										
NO	Freq.[MHz]	Reading [dBµV]	Antenna Factor [dB]	Cable loss[dB]	AMP [dB]	Level[dB µV/m]	Limit[dB µV/m]	Margin[ dB]	Detector	Polarity
1	46.50	28.81	13.15	0.92	-32.28	10.60	40.00	29.40	QP	Horizontal
2	79.23	40.50	7.02	1.36	-32.26	16.62	40.00	23.38	QP	Horizontal
3	190.87	45.93	10.29	2.29	-32.26	26.25	43.50	17.25	QP	Horizontal
4	419.18	45.72	15.68	3.45	-32.39	32.46	46.00	13.54	QP	Horizontal
5	629.98	55.41	19.00	4.29	-32.76	45.94	75.62	29.68	PK	Horizontal
6	629.98	55.41	19.00	4.29	-32.76	30.85	55.62	24.77	AV	Horizontal
7	944.79	47.21	22.60	5.35	-31.71	43.45	75.62	32.17	PK	Horizontal
8	944.79	47.21	22.60	5.35	-31.71	28.36	55.62	27.26	AV	Horizontal

Note:

1. Result Level = Reading + Cable loss + Antenna Factor + AMP
2. If Peak Result complies with QP limit, QP Result is deemed to comply with QP limit.
3. Test setup: RBW: 120 kHz, VBW: 300 kHz, Sweep time: auto.
4. Main frequency over the limit is fundamental.

# TR-4-E-009 Radiated Emission Test Result

**Test Date:** 2023-03-24      **Tested By:** Bairong  
**EUT:** SMART DOORBELL KIT      **Model Number:** GB156TX  
**Test Mode:** TX Mode      **Power Supply:** AC 16V/60Hz 0.6A From transformer  
**Condition:** Temp:24.0°C;Humi:61.2%      **Test Site:** DDT 3# Chamber  
**File Path:** d:\ts\2023 report date\Q23031611-7E 18000156TX\FCC BELOW 1G\20230324-104513\_V  
**Memo:** 315MHz

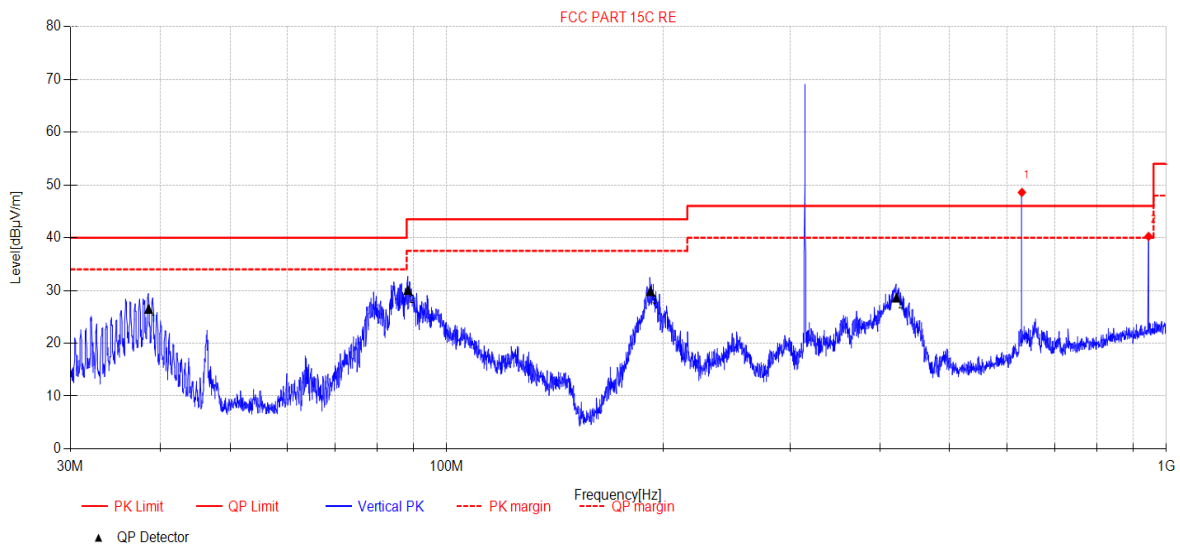

Suspected Data List										
NO	Freq.[MHz]	Reading [dBµV]	Antenna Factor [dB]	Cable loss[dB]	AMP [dB]	Level[dB µV/m]	Limit[dB µV/m]	Margin[dB]	Detector	Polarity
1	38.53	46.09	11.81	0.82	-32.28	26.44	40.00	13.56	QP	Vertical
2	88.32	51.84	8.96	1.49	-32.25	30.04	43.50	13.46	QP	Vertical
3	191.94	49.41	10.39	2.29	-32.26	29.83	43.50	13.67	QP	Vertical
4	421.54	41.81	15.73	3.45	-32.40	28.59	46.00	17.41	QP	Vertical
5	629.98	58.06	19.00	4.29	-32.76	48.59	75.62	27.03	PK	Vertical
6	629.98	58.06	19.00	4.29	-32.76	33.50	55.62	22.12	AV	Vertical
7	944.79	44.00	22.60	5.35	-31.71	40.24	75.62	35.38	PK	Vertical
8	944.79	44.00	22.60	5.35	-31.71	25.15	55.62	30.47	AV	Vertical

**Note:**

1. Result Level = Reading + Cable loss + Antenna Factor + AMP
2. If Peak Result complies with QP limit, QP Result is deemed to comply with QP limit.
3. Test setup: RBW: 120 kHz, VBW: 300 kHz, Sweep time: auto.
4. Main frequency over the limit is fundamental.

# TR-4-E-009 Radiated Emission Test Result

**Test Date:** 2023-03-24      **Tested By:** Bairong  
**EUT:** SMART DOORBELL KIT      **Model Number:** GB156TX  
**Test Mode:** TX Mode      **Power Supply:** AC 16V/60Hz 0.6A From transformer  
**Condition:** Temp:24.0°C;Humi:61.2%      **Test Site:** DDT 3# Chamber  
**File Path:** d:\ts\2023 report date\Q23031611-7E 18000156TX\FCC BELOW 1G\20230324-104700\_H  
**Memo:** 315MHz

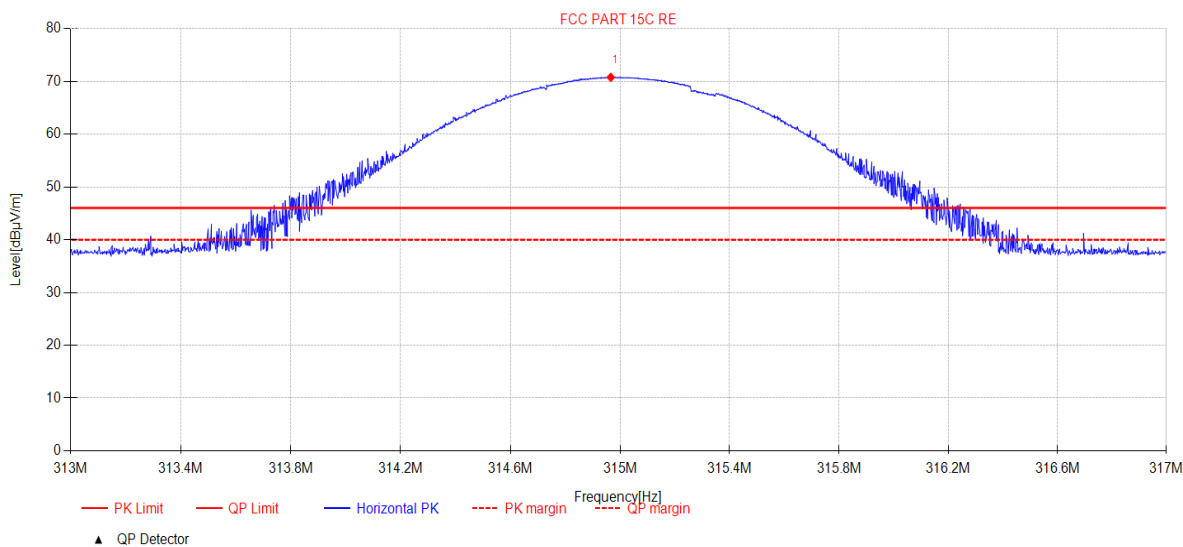

Suspected Data List										
NO	Freq.[MHz]	Reading [dBµV]	Antenna Factor [dB]	Cable loss[dB]	AMP [dB]	Level[dB µV/m]	Limit[dB µV/m]	Margin[dB]	Detector	Polarity
1	314.97	86.92	13.70	2.50	-32.33	70.79	95.62	24.83	PK	Horizontal
2	314.97	86.92	13.70	2.50	-32.33	55.70	75.62	19.92	AV	Horizontal

**Note:**

1. Result Level = Reading + Cable loss + Antenna Factor + AMP
2. If Peak Result complies with QP limit, QP Result is deemed to comply with QP limit.
3. Test setup: RBW: 120 kHz, VBW: 300 kHz, Sweep time: auto.

# TR-4-E-009 Radiated Emission Test Result

**Test Date:** 2023-03-24      **Tested By:** Bairong  
**EUT:** SMART DOORBELL KIT      **Model Number:** GB156TX  
**Test Mode:** TX Mode      **Power Supply:** AC 16V/60Hz 0.6A From transformer  
**Condition:** Temp:24.0°C;Humi:61.2%      **Test Site:** DDT 3# Chamber  
**File Path:** d:\ts\2023 report date\Q23031611-7E 18000156TX\FCC BELOW 1G\20230324-104819\_V  
**Memo:** 315MHz

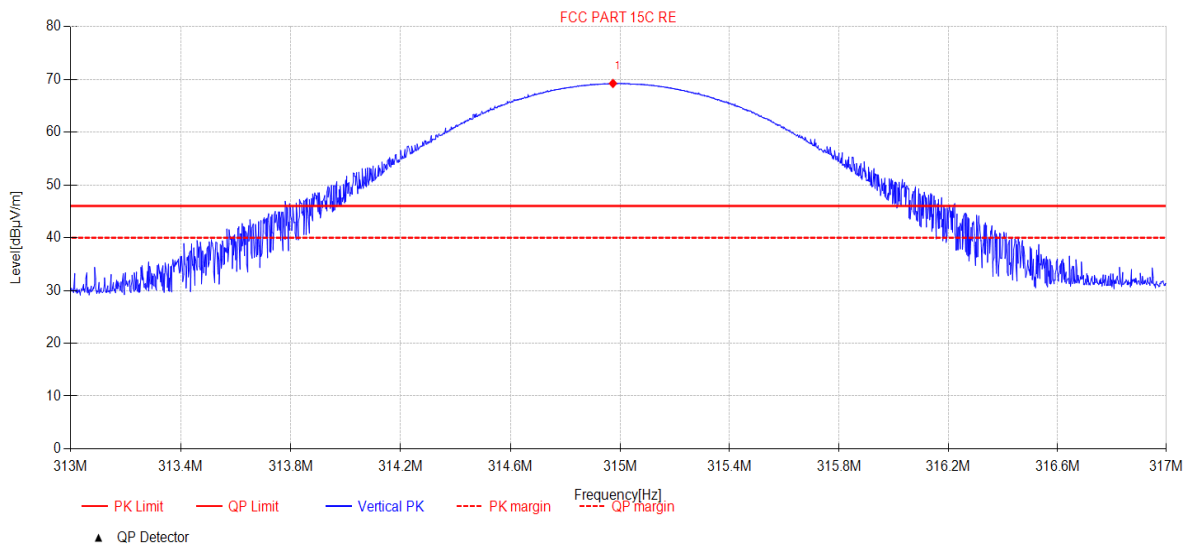

Suspected Data List										
NO	Freq.[MHz]	Reading [dBµV]	Antenna Factor [dB]	Cable loss[dB]	AMP [dB]	Level[dB µV/m]	Limit[dB µV/m]	Margin[ dB]	Detector	Polarity
1	314.97	85.37	13.70	2.50	-32.33	69.24	95.62	26.38	PK	Vertical
2	314.97	85.37	13.70	2.50	-32.33	54.15	75.62	21.47	AV	Vertical

**Note:**

1. Result Level = Reading + Cable loss + Antenna Factor + AMP
2. If Peak Result complies with QP limit, QP Result is deemed to comply with QP limit.
3. Test setup: RBW: 120 kHz, VBW: 300 kHz, Sweep time: auto.

## Radiated Emission test (above 1 GHz)

## TR-4-E-009 Radiated Emission Test Result

**Test Date:** 2023-03-23      **Tested By:** Bairong  
**EUT:** SMART DOORBELL KIT      **Model Number:** GB156TX  
**Test Mode:** TX Mode      **Power Supply:** AC 16V/60Hz 0.6A From transformer  
**Condition:** Temp:24.0°C;Humi:61.2%      **Test Site:** DDT 3# Chamber  
**File Path:** d:\ts\2023 report date\Q23031611-7E 18000156TX\FCC ABOVE 1G\1  
**Memo:** 315MHz

## Test Graph

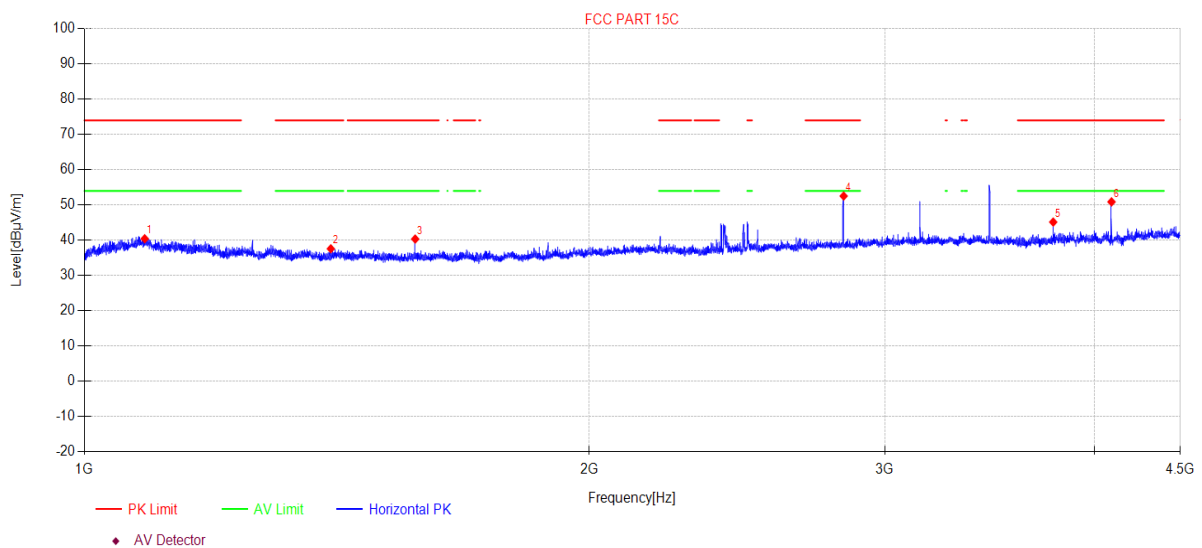

## Suspected Data List

NO.	Freq. [MHz]	Reading [dBμV]	Cable Loss [dB]	Antenna Factor [dB]	AMP [dB]	Level [dBμV/m]	Limit [dBμV/m]	Margin [dB]	Detector	Polarity
1	1086.40	50.64	2.59	25.50	-38.33	40.40	74.00	33.60	PK	Horizontal
2	1402.47	47.89	2.87	25.60	-38.80	37.56	74.00	36.44	PK	Horizontal
3	1574.65	50.97	3.01	25.40	-39.06	40.32	74.00	33.68	PK	Horizontal
4	2835.08	60.26	4.24	28.64	-40.62	52.52	74.00	21.98	PK	Horizontal
5	3779.61	50.90	5.29	30.22	-41.27	45.14	74.00	28.86	PK	Horizontal
6	4094.44	55.76	5.58	30.89	-41.37	50.86	74.00	23.14	PK	Horizontal

## Note:

- Level = Reading + Cable Loss + Antenna Factor + AMP
- If Peak Result complies with AV limit, AV Result is deemed to comply with AV limit.
- Test setup: RBW: 1 MHz, VBW: 3 MHz, Sweep time: auto.



# TR-4-E-009 Radiated Emission Test Result

**Test Date:** 2023-03-23      **Tested By:** Bairong  
**EUT:** SMART DOORBELL KIT      **Model Number:** GB156TX  
**Test Mode:** TX Mode      **Power Supply:** AC 16V/60Hz 0.6A From transformer  
**Condition:** Temp:24.0°C;Humi:61.2%      **Test Site:** DDT 3# Chamber  
**File Path:** d:\ts\2023 report date\Q23031611-7E 18000156TX\FCC ABOVE 1G\2  
**Memo:** 315MHz

## Test Graph

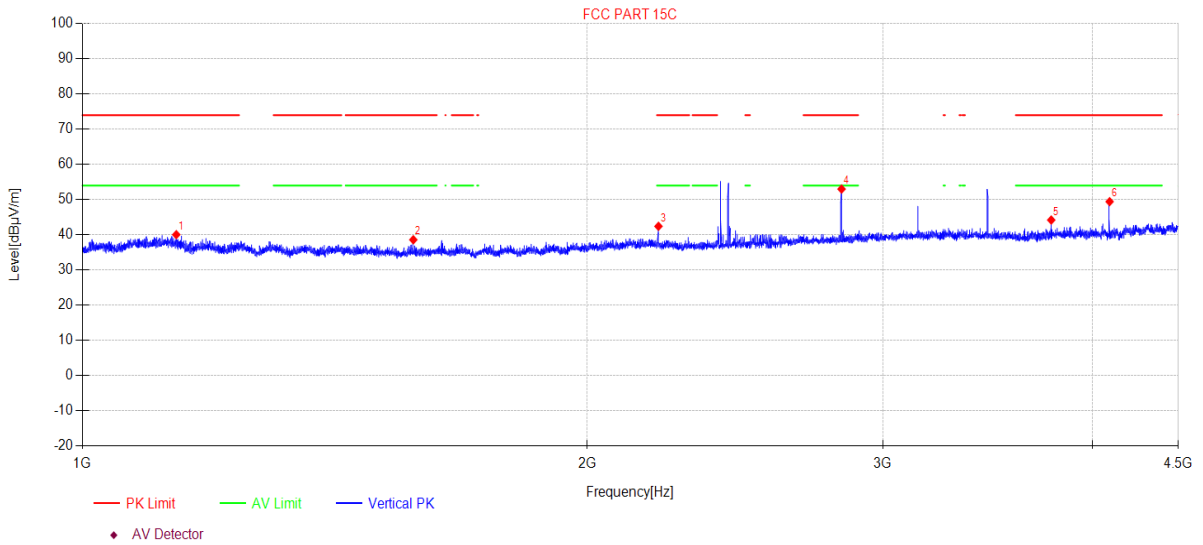

Suspected Data List										
NO.	Freq. [MHz]	Reading [dBµV]	Cable Loss [dB]	Antenna Factor [dB]	AMP [dB]	Level [dBµV/m]	Limit [dBµV/m]	Margin [dB]	Detector	Polarity
1	1137.56	50.21	2.64	25.58	-38.41	40.02	74.00	33.98	PK	Vertical
2	1574.89	49.22	3.01	25.40	-39.06	38.57	74.00	35.43	PK	Vertical
3	2204.75	51.52	3.59	27.21	-39.93	42.39	74.00	31.61	PK	Vertical
4	2834.66	60.73	4.24	28.64	-40.62	52.99	74.00	21.01	PK	Vertical
5	3779.61	49.94	5.29	30.22	-41.27	44.18	74.00	29.82	PK	Vertical
6	4095.06	54.31	5.58	30.89	-41.37	49.41	74.00	24.59	PK	Vertical

**Note:**

1. Level = Reading + Cable Loss + Antenna Factor + AMP
2. If Peak Result complies with AV limit, AV Result is deemed to comply with AV limit.
3. Test setup: RBW: 1 MHz, VBW: 3 MHz, Sweep time: auto.

## 8. Power Line Conducted Emission

### 8.1. Block diagram of test setup

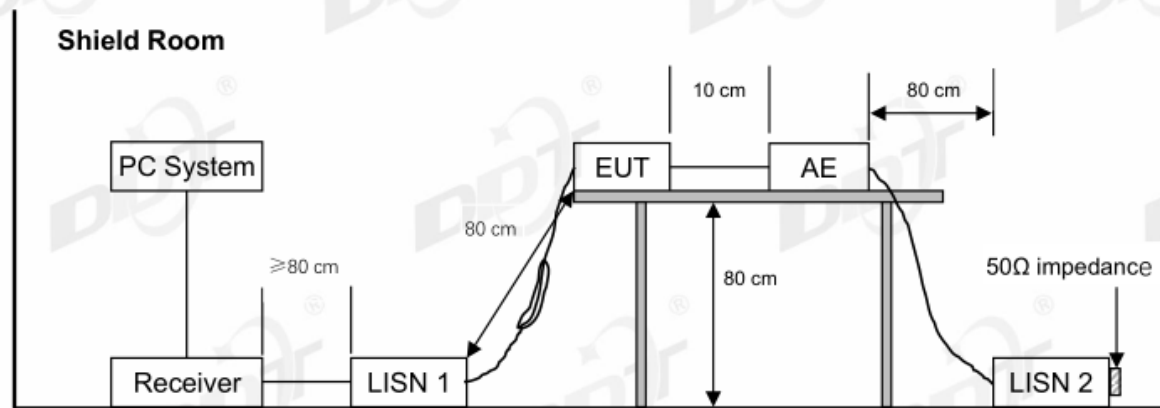

### 8.2. Power line conducted emission limits

Frequency	Quasi-Peak Level dB( $\mu$ V)	Average Level dB( $\mu$ V)
150 kHz ~ 500 kHz	66 ~ 56*	56 ~ 46*
500 kHz ~ 5 MHz	56	46
5 MHz ~ 30 MHz	60	50

Note 1: \* Decreasing linearly with logarithm of frequency.

Note 2: The lower limit shall apply at the transition frequencies.

### 8.3. Test procedure

The EUT and Support equipment, if needed, were put placed on a non-metallic table, 80 cm above the ground plane.

All support equipment power received from a second LISN.

Emissions were measured on each current carrying line of the EUT using an EMI Test Receiver connected to the LISN powering the EUT.

The Receiver scanned from 150 kHz to 30 MHz for emissions in each of the test modes.

During the above scans, the emissions were maximized by cable manipulation.

The test mode(s) described in clause 2.4 were scanned during the preliminary test.

After the preliminary scan, we found the test mode producing the highest emission level.

The EUT configuration and worse cable configuration of the above highest emission levels were recorded for reference of the final test.

EUT and support equipment were set up on the test bench as per the configuration with highest emission level in the preliminary test.

A scan was taken on both power lines, Neutral and Line, recording at least the six highest emissions.

Emission frequency and amplitude were recorded into a computer in which correction factors were used to calculate the emission level and compare reading to the applicable limit.

The test data of the worst-case condition(s) was recorded.

The bandwidth of test receiver is set at 9 kHz.

#### **8.4. Test result**

**Pass. (See below detailed test result)**

Note1: All emissions not reported below are too low against the prescribed limits.

Note2: "----" means Peak detection; "----" means Average detection.

Note3: Pre-test AC conducted emission at both voltage AC 120V/60Hz and AC 240V/50Hz, recorded worse case.

# TR-4-E-010 Conducted Emission Test Result

**Test Site** : DDT 5# Shield Room D:\2023 report data\Q23031611-7E\FCC CE.EM6  
**Test Date** : 2023-03-30 **Tested By** : Junchang Du  
**EUT** : SMART DOORBELL KIT **Model Number** : GB156TX  
**Power Supply** : AC 16V/60Hz 0.6A From transformer **Test Mode** : Working mode  
**Condition** : Temp:24.5°C,Humi:55.5% **LISN** : 2022 ENV216 2#/NEUTRAL  
**Memo** : 315MHz

Data: 2

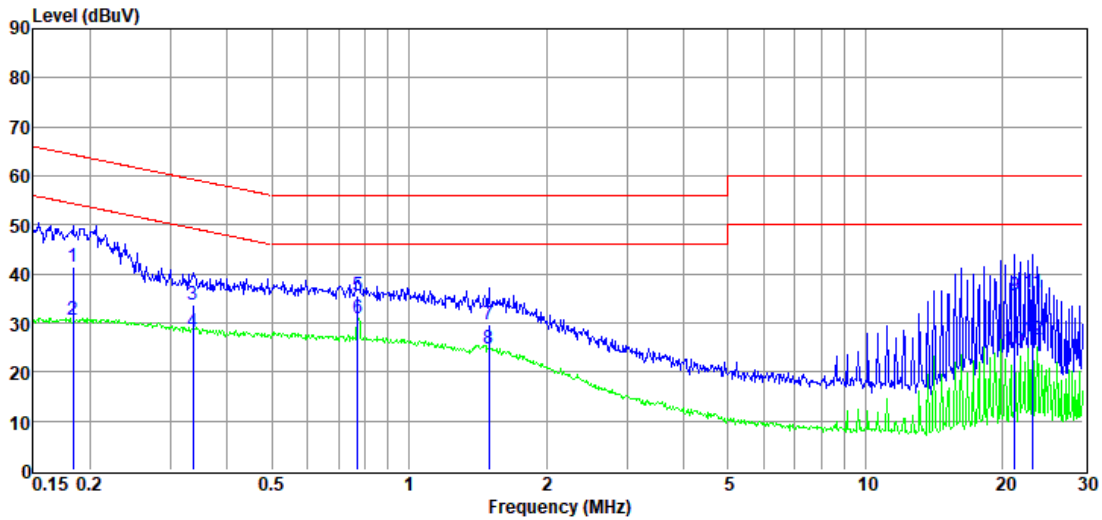

Item (Mark)	Freq. (MHz)	Read Level (dBμV)	LISN Factor (dB)	Cable Loss (dB)	Pulse Limiter Factor (dB)	Result Level (dBμV)	Limit Line (dBμV)	Over Limit (dB)	Detector	Phase
1	0.18	20.67	9.77	0.03	10.88	41.35	64.33	-22.98	QP	NEUTRAL
2	0.18	9.99	9.77	0.03	10.88	30.67	54.33	-23.66	Average	NEUTRAL
3	0.34	13.14	9.80	0.03	10.76	33.73	59.31	-25.58	QP	NEUTRAL
4	0.34	7.68	9.80	0.03	10.76	28.27	49.31	-21.04	Average	NEUTRAL
5	0.77	15.35	9.83	0.04	10.47	35.69	56.00	-20.31	QP	NEUTRAL
6	0.77	10.71	9.83	0.04	10.47	31.05	46.00	-14.95	Average	NEUTRAL
7	1.50	9.73	9.84	0.06	10.15	29.78	56.00	-26.22	QP	NEUTRAL
8	1.50	4.78	9.84	0.06	10.15	24.83	46.00	-21.17	Average	NEUTRAL
9	21.26	15.58	9.75	0.30	10.03	35.66	60.00	-24.34	QP	NEUTRAL
10	21.26	4.48	9.75	0.30	10.03	24.56	50.00	-25.44	Average	NEUTRAL
11	23.26	15.95	9.81	0.32	10.03	36.11	60.00	-23.89	QP	NEUTRAL
12	23.26	6.53	9.81	0.32	10.03	26.69	50.00	-23.31	Average	NEUTRAL

- Note: 1. Result Level = Read Level + LISN Factor + Pulse Limiter Factor + Cable loss.  
 2. If QP Result complies with AV limit, AV Result is deemed to comply with AV limit.  
 3. Test setup: RBW: 200 Hz (9 kHz—150 kHz), 9 kHz (150 kHz—30 MHz).  
 4. Step size: 80Hz (0.009MHz-0.15MHz), 4 kHz (0.15MHz-30MHz), Scan time: auto.

# TR-4-E-010 Conducted Emission Test Result

**Test Site** : DDT 5# Shield Room D:\2023 report data\Q23031611-7E\FCC CE.EM6  
**Test Date** : 2023-03-30 **Tested By** : Junchang Du  
**EUT** : SMART DOORBELL KIT **Model Number** : GB156TX  
**Power Supply** : AC 16V/60Hz 0.6A From transformer **Test Mode** : Working mode  
**Condition** : Temp:24.5°C,Humi:55.5% **LISN** : 2022 ENV216 2#/LINE  
**Memo** : 315MHz

Data: 4

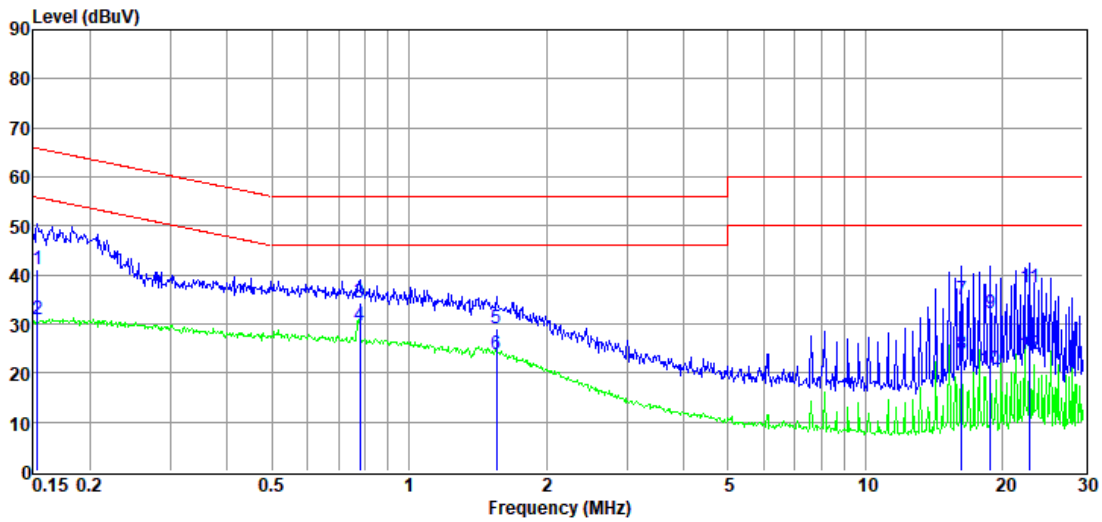

Item (Mark)	Freq. (MHz)	Read Level (dBuV)	LISN Factor (dB)	Cable Loss (dB)	Pulse Limiter Factor (dB)	Result Level (dBuV)	Limit Line (dBuV)	Over Limit (dB)	Detector	Phase
1	0.15	20.52	9.80	0.03	10.90	41.25	65.82	-24.57	QP	LINE
2	0.15	10.13	9.80	0.03	10.90	30.86	55.82	-24.96	Average	LINE
3	0.78	14.10	9.77	0.04	10.47	34.38	56.00	-21.62	QP	LINE
4	0.78	9.40	9.77	0.04	10.47	29.68	46.00	-16.32	Average	LINE
5	1.55	9.38	9.51	0.07	10.13	29.09	56.00	-26.91	QP	LINE
6	1.55	4.24	9.51	0.07	10.13	23.95	46.00	-22.05	Average	LINE
7	16.23	15.01	9.65	0.26	10.03	34.95	60.00	-25.05	QP	LINE
8	16.23	3.78	9.65	0.26	10.03	23.72	50.00	-26.28	Average	LINE
9	18.82	12.16	9.54	0.28	10.03	32.01	60.00	-27.99	QP	LINE
10	18.82	0.77	9.54	0.28	10.03	20.62	50.00	-29.38	Average	LINE
11	22.90	17.55	9.57	0.32	10.03	37.47	60.00	-22.53	QP	LINE
12	22.90	3.99	9.57	0.32	10.03	23.91	50.00	-26.09	Average	LINE

- Note: 1. Result Level = Read Level + LISN Factor + Pulse Limiter Factor + Cable loss.  
 2. If QP Result complies with AV limit, AV Result is deemed to comply with AV limit.  
 3. Test setup: RBW: 200 Hz (9 kHz—150 kHz), 9 kHz (150 kHz—30 MHz).  
 4. Step size: 80Hz (0.009MHz-0.15MHz), 4 kHz (0.15MHz-30MHz), Scan time: auto.

## 9. Antenna Requirements

### 9.1. Limit

For intentional device, according to FCC 47 CFR Section 15.203, an intentional radiator shall be designed to ensure that no antenna other than that furnished by the responsible party shall be used with the device. And according to FCC 47 CFR Section 15.247 (b), if transmitting antennas of directional gain greater than 6 dBi are used, the power shall be reduced by the amount in dB that the directional gain of the antenna exceeds 6 dBi.

For intentional device, according to RSS-Gen issue 5 section 6.8.

The applicant for equipment certification shall provide a list of all antenna types that may be used with the transmitter, where applicable (i.e. for transmitters with detachable antenna), indicating the maximum permissible antenna gain (in dBi) and the required impedance for each antenna. The test report shall demonstrate the compliance of the transmitter with the limit for maximum equivalent isotropically radiated power (e.i.r.p.) specified in the applicable RSS, when the transmitter is equipped with any antenna type, selected from this list.

### 9.2. Result

The antenna used for this product is Spring antenna and that no antenna other than that furnished by the responsible party shall be used with the device, the maximum peak gain of the transmit antenna is -2 dBi.

## 11. Photos of the EUT

Please refer to appendix I.

**END OF REPORT**