









How to set up your rest routine

Manual Setting

When the device is turned on, long press the Rest Button  to start the below setting.



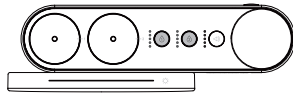
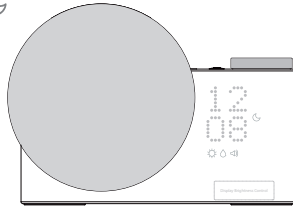



1. The Light Icon  is on. Adjust the time of lighting by rotating the Dial Button for the period of 0-60 minutes. Light click the Dial Button to confirm the setting.
2. The Music Icon  flashes. Adjust the volume by rotating the Dial Button for the range of 1-10 degree. Meanwhile, select the music by clicking Music Selection Button . Light click the Dial Button to confirm the setting.
3. The Time Icon flashes. Adjust the play time of music by rotating the Dial Button. The range is "0-8 hours" and "all the time" (the Infinity Icon ). Light click the Dial Button to confirm the setting.
4. The Essential Oil Icon  flashes. Short press the Pump 1  or Pump 2  Button to set the 1# or 2# pump and select the spray degree. Long press Pump 1 or Pump 2 Button to cancel the customized setting. Rotating the Dial Button to set the misting time. The range is "0-8 hours" and "all the time" (the Infinity Icon ). Light click the Dial Button to confirm the setting.





Note: Above "0" value means no working.

How to set up your Sunrise routine

Manual Setting

1. When the device is turned on, long press the Sunrise 1 Button  or Sunrise 2 Button  to start the setting. Adjust the alarm time by rotating the Dial Button. Light click the Dial Button to confirm the setting.
2. The Light Icon  is on. Adjust the working time of the light by rotating the Dial Button. The optional time range is 0-60 minutes. Light click the Dial Button to confirm the setting.
3. The Music Icon  flashes. Adjust the volume by rotating the Dial Button. Click the Music Selection Button to select different music. Light click the Dial Button to confirm the setting.
4. The Essential Oil Icon  flashes. Short press the Pump 1  or Pump 2  Button to set the 1# or 2# pump and select the spray degree. Long press Pump 1 or Pump 2 Button to cancel the customized setting. Rotating the Dial Button to set the misting time. The range is 0-60 minutes. Light click the Dial Button to confirm the setting.

Start Sunrise Mode

1. Short press the Sunrise 1 Button , the Sunrise 1 Icon will appear on the screen. The diffuser will enter the working of Sunrise 1 Mode. When the customized alarm time of Sunrise 1 Mode arrives, the lights, music and misting will start the working of Sunrise 1 Mode.
2. Short press the Sunrise 2 Button . The working principle is the same as above.
3. When the alarm time arrives, the music will sound. Short press the Dial Button to enter snooze mode: the music will stop and will sound again in 9 minutes.
4. Long press the Dial Button to turn off the current working sunrise mode. If no operation for 1 hour, the sunrise mode will be automatically turned off.

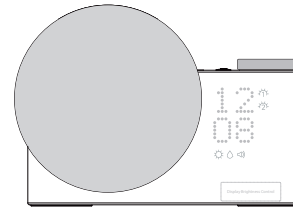
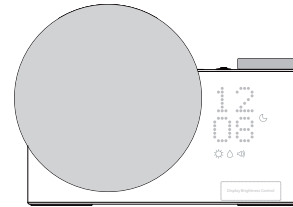
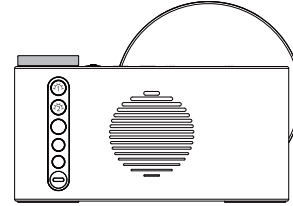

AromaConnect Wake-Up Light Diffuser

Quick Start

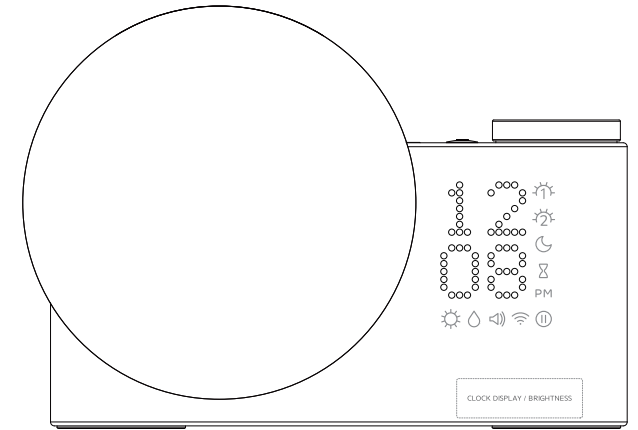

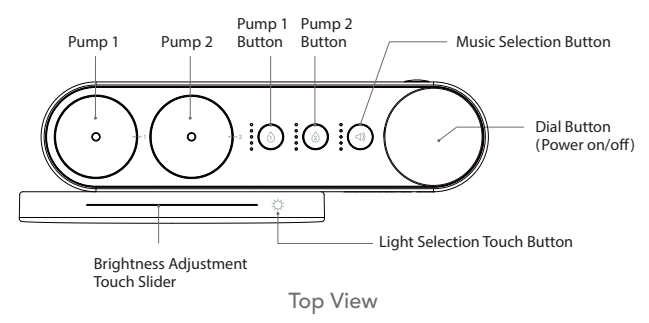
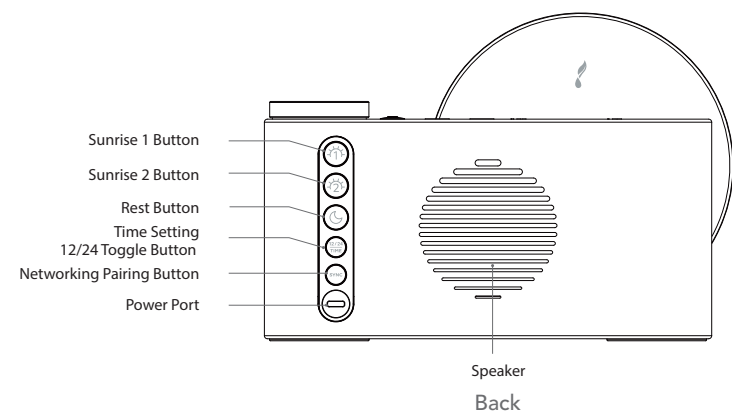
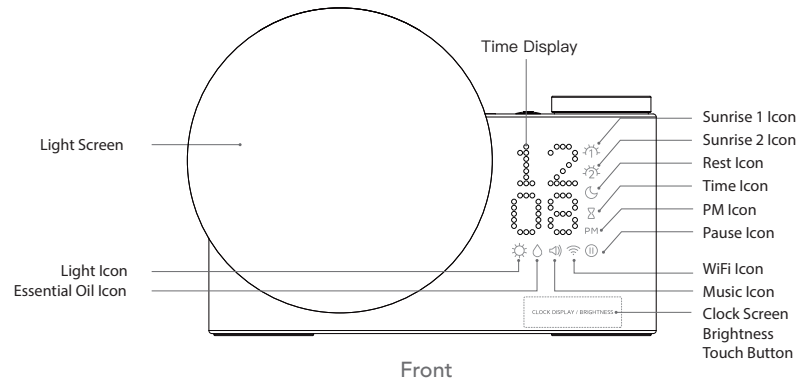

General Settings

Power on/off.

1. Connecting with power, short press the Dial Button to turn on the device.
2. If the device is operating, long press the Dial Button, everything will power off except for the clock.

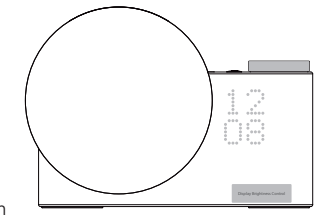

Shift between 12/24 hour format and set time.

1. The default is 12-hour format. The PM Icon will appear in the lower right corner of the screen in the afternoon.
2. Short press Time Setting 12/24 Toggle Button $\frac{12/24}{TIME}$, the 24 Icon will flash 3 times, and then shift into 24-hour format.
3. Long press $\frac{12/24}{TIME}$ to enter setting. Rotate the Dial Button to set the clock/minute, and short press the Dial Button to confirm the setting.

Note: The time will be updated automatically when connecting to WiFi.

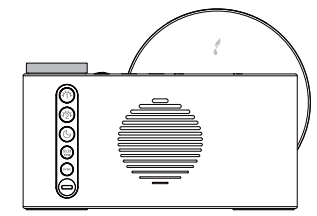

Sunrise 1 or 2 Mode

Short press Sunrise 1 Button \uparrow / Sunrise 2 Button \uparrow to turn on/off the corresponding sunrise mode. The Sunrise 1/Sunrise 2 Icon will appear on the screen.

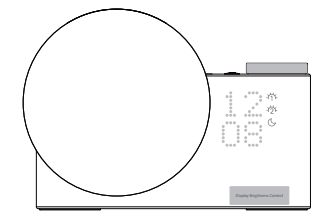

Rest Mode

1. When you are ready to start your rest routine, short press the Rest Button ☾ , and then short press the Dial Button. The Rest Icon will flash 3 times. The device will enter Rest Mode.
2. If the rest routine is operating, you need to long press the Dial Button to turn off the rest routine.

WiFi Networking

1. Long press the Networking Pairing Button SYNC to enter WiFi Paring Mode. The WiFi Icon WiFi will flash. Use the AromaConnect APP to configure the network for the device.
2. After the network is successfully configured, the WiFi icon is automatically hidden.
3. Please make sure connect your device to a 2.4GHZ WiFi network.

Note: During the network configuration process, Bluetooth will be turned on to assist network configuration.

Factory Reset

In the state of network configuration, long press the Networking Pairing Button SYNC, the WiFi Icon will appear. Press the Dial Button and SYNC Button for 3 seconds at the same time, the blue light flashes, and the device will restore factory settings.

Manual Adjustment

Lighting Adjustment

1. Connecting to power, short press the Dial Button to turn on the device. The clock display are lit.
2. Short press the Light Selection Touch Button ☀ to turn on the light screen. Press it again to change the light color. Long press it to turn off the light screen.
3. Toggle the Brightness Adjustment Touch Slider to adjust the light screen brightness.

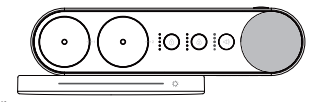

Music Adjustment

1. Built-in 10 music. The 1st music is default. And the white small indicator light next to the Music Selection Button is on.
2. Light press the Music Selection Button 🔊 to switch different music.
3. The volume has 1-10 degree. The 5 degree is default. Rotate the Dial Button to adjust the volume.
4. Long press the Music Selection Button 🔊 to shut down the music.

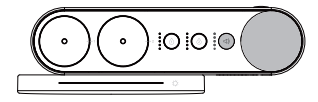

Misting Adjustment

1. The misting has 1-5 degree. The 1# pump with 1st degree is default.
2. Short press Pump 1 1 / Pump 2 2 Button, to start the 1#/2# pump and select the spray degree.
3. Long press Pump 1/Pump 2 Button, to shut down the 1#/2# pump.

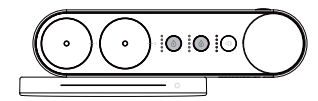

FCC Statement

This device complies with part 15 of the FCC rules. Operation is subject to the following two conditions: (1) this device may not cause harmful interference, and (2) this device must accept any interference received, including interference that may cause undesired operation.

Caution: Changes or modifications not expressly approved by the party responsible for Compliance could void the user's authority to operate the equipment.

NOTE: This equipment has been tested and found to comply with the limits for a Class B digital device, pursuant to part 15 of the FCC Rules. These limits are designed to provide reasonable protection against harmful interference in a residential installation. This equipment generates uses and can radiate radio frequency energy and, if not installed and used in accordance with the instructions, may cause harmful interference to radio communications. However, there is no guarantee that interference will not occur in a particular installation. If this equipment does cause harmful interference to radio or television reception, which can be determined by turning the equipment off and on, the user is encouraged to try to correct the interference by one or more of the following measures:

- Reorient or relocate the receiving antenna.
- Increase the separation between the equipment and receiver.
- Connect the equipment into an outlet on a circuit different from that to which the receiver is connected.
- Consult the dealer or an experienced radio/TV technician for help important announcement .

Radiation Exposure Statement

To comply with FCC RF exposure compliance requirements, this grant is applicable to only mobile configurations. The antennas used for this transmitter must be installed to provide a separation distance of at least 20 cm from all persons and must not be co-located or operating in conjunction with any other antenna or transmitter.

ISED Statement

- English: This device contains licence-exempt transmitter(s)/receiver(s) that comply with Innovation, Science and Economic Development Canada's licence-exempt RSS(s). Operation is subject to the following two conditions:

(1) This device may not cause interference.

(2) This device must accept any interference, including interference that may cause undesired operation of the device.

The digital apparatus complies with Canadian CAN ICES-3 (B)/NMB-3(B).

French: Cet appareil contient des émetteurs/récepteurs exempts de licence qui sont conformes aux RSS exempts de licence d'Innovation, Sciences et Développement économique Canada.

L'exploitation est soumise aux deux conditions suivantes :

(1) Cet appareil ne doit pas provoquer d'interférences.

(2) Cet appareil doit accepter toute interférence, y compris les interférences susceptibles de provoquer un fonctionnement indésirable de l'appareil.

l'appareil numérique du ciem conforme canadien peut - 3 (b) / nmb - 3 (b).

This device meets the exemption from the routine evaluation limits in section 2.5 of RSS 102 and compliance with RSS 102 RF exposure, users can obtain Canadian information on RF exposure and compliance.

cet appareil est conforme à l'exemption des limites d'évaluation courante dans la section 2.5 du cnr - 102 et conformité avec rss 102 de l'exposition aux rf, les utilisateurs peuvent obtenir des données canadiennes sur l'exposition aux champs rf et la conformité.

This equipment complies with Canada radiation exposure limits set forth for an uncontrolled environment. Cet équipement est conforme aux limites d'exposition aux rayonnements du Canada établies pour un environnement non contrôlé.

RF Exposure Statement

This equipment should be installed and operated with minimum distance 20cm between the radiator & your body.

Cet équipement doit être installé et utilisé à une distance minimale de 20 cm entre le radiateur et votre corps.