



Product Service

**Choose certainty.
Add value.**

Report On

FCC Testing of the CBRSYS6500 in accordance with FCC CFR 47 Part 2 and
FCC CFR 47 Part 24

COMMERCIAL-IN-CONFIDENCE

FCC ID: 2AQSOCBRSYS6500

PREPARED BY

Nikolai Viktorov
Test Personnel

APPROVED BY

Scott Drysdale
Authorised Signatory

DATED

December 18,
2018

October 2018



CONTENTS

Section		Page No
1	REPORT INFORMATION	3
1.1	Report Details	4
1.2	Brief Summary of Results	5
1.3	Configuration Description	6
1.4	Declaration of Build Status	7
2	MAIN EUT	7
1.5	Product Information	8
1.6	Test Setup	10
1.7	Test Conditions	11
1.8	Deviation From The Standard	11
1.9	Modification Record	11
1.10	Alternative Test Site	11
1.11	Additional Information	11
3	TEST DETAILS	12
2.1	Maximum Peak Output Power and Peak to Average Ratio - Conducted	13
2.2	Occupied Bandwidth	19
2.3	Band Edge	22
2.4	Transmitter Spurious Emissions	25
2.5	Frequency Stability	32
4	TEST EQUIPMENT USED	33
3.1	Test Equipment Used	34
3.2	Measurement Uncertainty	35
5	ACCREDITATION, DISCLAIMERS AND COPYRIGHT	36
4.1	Accreditation, Disclaimers and Copyright	37



Product Service

SECTION 1

REPORT INFORMATION



Product Service

1.1 REPORT DETAILS

Manufacturer	Octasic inc.
Address	300-401 Molson St, Montreal, QC, H1Y 3L1
Product Name	CBRSYS6500 (CBRRFE6400+CBRSYS6000)
Product Number	CBRSYS6000 - CBRSYS6008-RE-3E CBRRFE6400 - CBRRFE6407-NC100-EE1
Serial Number(s)	CBRSYS6000 – F-00190 CBRRFE6400 – K-15468
Hardware Version	CBRSYS6000 - 3.0 CBRRFE6400 - 3.1
Test Specification/Issue/Date	FCC CFR 47 Part 2: 2016 FCC CFR 47 Part 24: 2016
Start of Test	October 12, 2018
Finish of Test	December 17, 2018
Name of Test Personnel(s)	Scott Drysdale and Nikolai Viktorov
Related Document(s)	KDB 971168 D01 v02r02 KDB 662911 D01 v02r01



Product Service

1.2 BRIEF SUMMARY OF RESULTS

A brief summary of results for each configuration, in accordance with FCC CFR 47 Part 2 and FCC CFR 47 Part 24 is shown below.

Section	Specification Clause		Test Description	Result
	FCC CFR 47 Part 2	FCC CFR 47 Part 24		
2.1	2.1046	24.232 (a)	Maximum Peak Output Power, ERP, and Peak to Average Ratio - Conducted	Pass
2.2	2.1049	24.238 (b)	Occupied Bandwidth	Pass
2.3	2.1051	24.238 (b)	Band Edge	Pass
2.4	2.1051	24.238 (a)	Transmitter Spurious Emissions	Pass
2.5	2.1055	24.235	Frequency Stability	Pass
-	-	15.111	Receiver Spurious Emissions	N/A ¹

N/A¹ – Not Applicable, as this is a transceiver.



Product Service

1.3 CONFIGURATION DESCRIPTION

The CBRSYS6500 supports Single Mode operation from a single port configuration.

The CBRSYS6500 supports UMTS in Band 2 (1930 MHz – 1990 MHz).

TX test cases: Maximum Conducted Output Power, Spurious Emissions at Antenna Terminals (± 1 MHz) and Conducted Spurious Emissions, measurements were performed on the RF Port. The test limits shown are representative of the worst case. All testing was performed with the EUT transmitting at maximum RF power unless as designated setting by client, otherwise stated.

The EUT was powered via a 120V 60Hz power supply.

UMTS B2 (1930 MHz – 1990 MHz) Channel Configurations

All tests

RAT	No. of Carriers	Carrier Bandwidth (MHz)	Carrier Frequency Configuration (MHz)		
			Bottom (BRFBW)	Middle (MRFBW)	Top (TRFBW)
U	1	5	1932.4 + 1937.4	1960	1982.5 + 1987.6



Product Service

1.4 DECLARATION OF BUILD STATUS

MAIN EUT	
MANUFACTURING DESCRIPTION	CBRSYS6500
MANUFACTURER	Octasic inc.
TYPE	Portable Base Station Unit with Transportable Amplification Unit
PART NUMBER	CBRSYS6000 - CBRSYS6008-RE-3E CBRRFE6400 - CBRRFE6407-NC100-EE1
SERIAL NUMBER	CBRSYS6000 – F-00190 CBRRFE6400 – K-15468
HARDWARE VERSION	CBRSYS6000 - 3.0 CBRRFE6400 - 3.1
TRANSMITTER OPERATING RANGE	B2 1930 – 1990 MHz
RECEIVER OPERATING RANGE	B2 1850 – 1910 MHz
COUNTRY OF ORIGIN	CBRSYS6000 - India CBRRFE6400 - Canada
EMISSION DESIGNATOR(S): (i.e. G1D, GXW)	UMTS: G7W
MODULATION TYPES: (i.e. GMSK, QPSK)	UMTS: QPSK
HIGHEST INTERNALLY GENERATED FREQUENCY	1.990 GHz
OUTPUT POWER (W or dBm)	20W
FCC ID	2AQSOBRSYS65000
TECHNICAL DESCRIPTION (a brief description of the intended use and operation)	The Transportable Amplification Unit (TAU) is a powerful multiband RF front-end (RFE) designed for use as a Transportable Amplification Unit (TAU) in conjunction with a Portable Base station Unit (PBU). The EUT fits in a standard 19" 6U rack.



Product Service

1.5 PRODUCT INFORMATION

1.5.1 Technical Description

The Equipment Under Test (EUT) operates from a 120V 60Hz supply.

The CBRRFE6400 Transportable Amplification Unit (TAU) is a powerful multiband RF front-end (RFE) designed for use as a Transportable Amplification Unit (TAU) in conjunction with a Portable Base station Unit (PBU) such as the CBRSYS6000. The TAU ships in a ruggedized case and fits in a standard 19" 6U rack.

Depending on band configuration it can support up to 8 bands. It has a high sensitivity multiband receiver and an interference mitigation and suppression mechanism to maintain sensitivity in the presence of interference. The transmitter can transmit up to 100W peak per band. The TAU has automatic RF power control per band for coverage optimization and a standby mode to optimize power consumption.

The CBRSYS6000 Portable Base station Unit (PBU) is multi-channel, software-defined radio (SDR) based base station system for wireless applications like Network in a Box (NIB). It is designed to fit in a standard 19" 3U rack—two PBUs can be fit in a standard 3U rack and ships in a ruggedized 3U rackmount case.

The PBU has a basic RF front end that internally combines the TX signals and splits the RX signals of each SDR. It can be coupled with a high-power RF front end Transportable Amplification Unit (TAU) such as the CBRRFE6400 for a complete system. The PBU is controlled over wired Ethernet and has a USB service port for maintenance access to the serial ports of each SDR. The PBU has built-in fans for thermal management.

The Equipment Under Test (EUT) is shown in the photograph below. A full technical description can be found in the Manufacturer's documentation.

Equipment Under Test



1.6 TEST SETUP

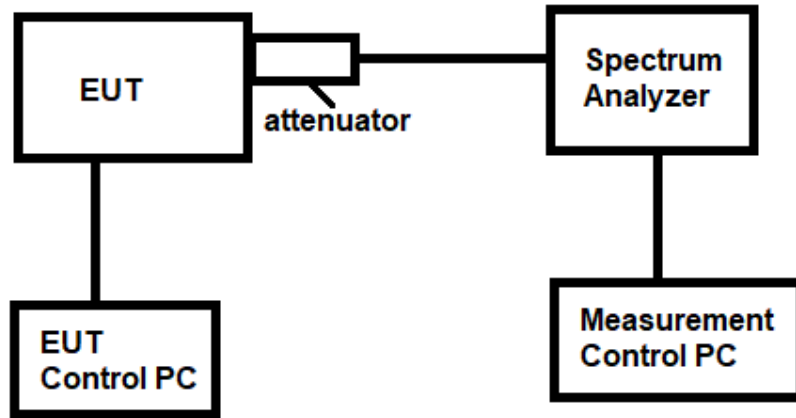



Product Service

1.7 TEST CONDITIONS

For all tests, the EUT was set up in accordance with the relevant test standard and to represent typical operating conditions. Tests were applied with the EUT situated in a shielded enclosure, test laboratories or a chamber as appropriate.

The EUT was powered from a 120V 60Hz supply.

FCC Measurement Facility Accreditation Designation Number: CA6845 - TÜV SÜD Canada (Laval)

1.8 DEVIATION FROM THE STANDARD

No deviations from the applicable test standards or test plan were made during testing.

1.9 MODIFICATION RECORD

No modifications were made to the EUT during testing.

1.10 ALTERNATIVE TEST SITE

Under our Accreditation, TÜV SÜD Canada, Laval conducted the following tests at the TÜV SÜD Canada, Ottawa location.

1.11 ADDITIONAL INFORMATION

The CBRSYS6000 Portable Base station Unit (PBU) is multi-channel, software-defined radio (SDR) based base station system for wireless applications like Network in a Box (NIB). It is designed to fit in a standard 19" 3U rack—two PBUs can be fit in a standard 3U rack and ships in a ruggedized 3U rackmount case.

Depending on band configuration it can support up to 8 bands. It has a high sensitivity multiband receiver and an interference mitigation and suppression mechanism to maintain sensitivity in the presence of interference. The transmitter can transmit up to 100W peak per band.



Product Service

SECTION 2 TEST DETAILS



Product Service

1.12 MAXIMUM PEAK OUTPUT POWER AND PEAK TO AVERAGE RATIO - CONDUCTED

1.12.1 Specification Reference

FCC CFR 47 Part 2, Clause 2.1046
FCC CFR 47 Part 24, Clause 24.232 (a)

1.12.2 Date of Test and Modification State

November 20, 2018 - Modification State 0

1.12.3 Test Equipment Used

The major items of test equipment used for the above tests are identified in Section 3.1.

1.12.4 Environmental Conditions

Ambient Temperature	21°C
Relative Humidity	30%

1.12.5 Test Method

All measurements were made in accordance with FCC KDB 971168 D01, clause 5.2.1 and summed in accordance with FCC KDB 662911 D01.

1.12.6 Test Results



Product Service

Maximum Target Output Power 40 dBm

Antenna	UMTS Modulation	UMTS Carrier Bandwidth	Peak to Average Ratio (PAR) / Output Power		
			Channel Position B		
			PAR (dB)	Average Power	
dBm	dBm/MHz				
A	QPSK	5.0 MHz	7.56	35.38	30.04

UMTS Modulation QPSK - UMTS Carrier Bandwidth 5.0 MHz - Antenna A

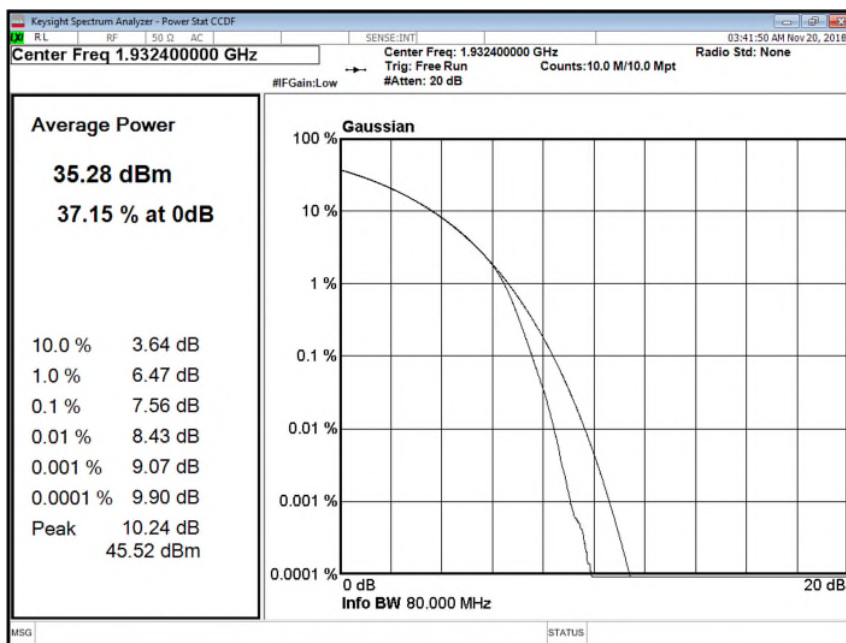



Product Service

Maximum Target Output Power 43 dBm

Antenna	UMTS Modulation	UMTS Carrier Bandwidth	Peak to Average Ratio (PAR) / Output Power		
			Channel Position B2		
			PAR (dB)	Average Power	
dBm	dBm/MHz				
A	QPSK	5.0 MHz	7.48	42.18	37.01

UMTS Modulation QPSK - UMTS Carrier Bandwidth 5.0 MHz - Antenna A

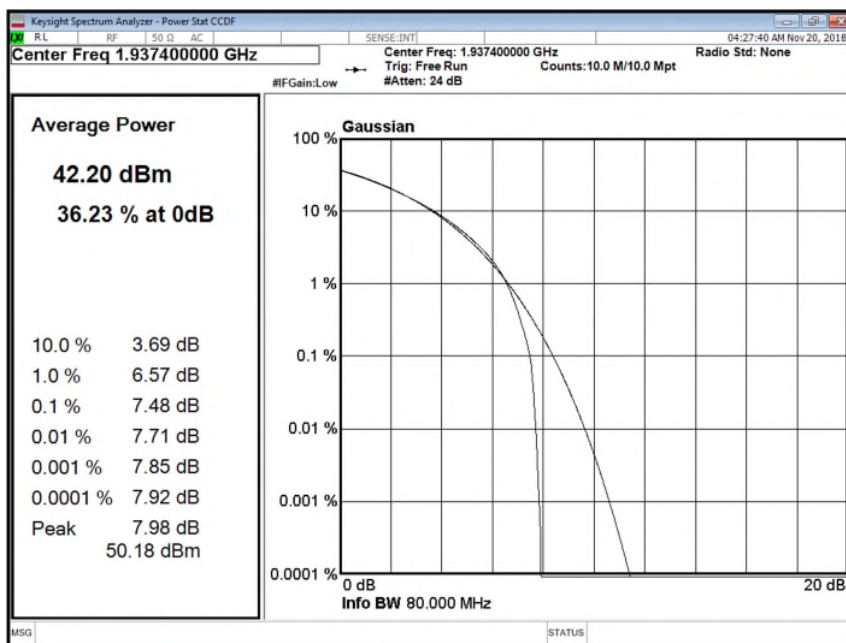



Product Service

Maximum Target Output Power 43 dBm

Antenna	UMTS Modulation	UMTS Carrier Bandwidth	Peak to Average Ratio (PAR) / Output Power		
			Channel Position M		
			PAR (dB)	Average Power	
dBm	dBm/MHz				
A	QPSK	5.0 MHz	7.15	42.87	37.62

UMTS Modulation QPSK - UMTS Carrier Bandwidth 5.0 MHz - Antenna A

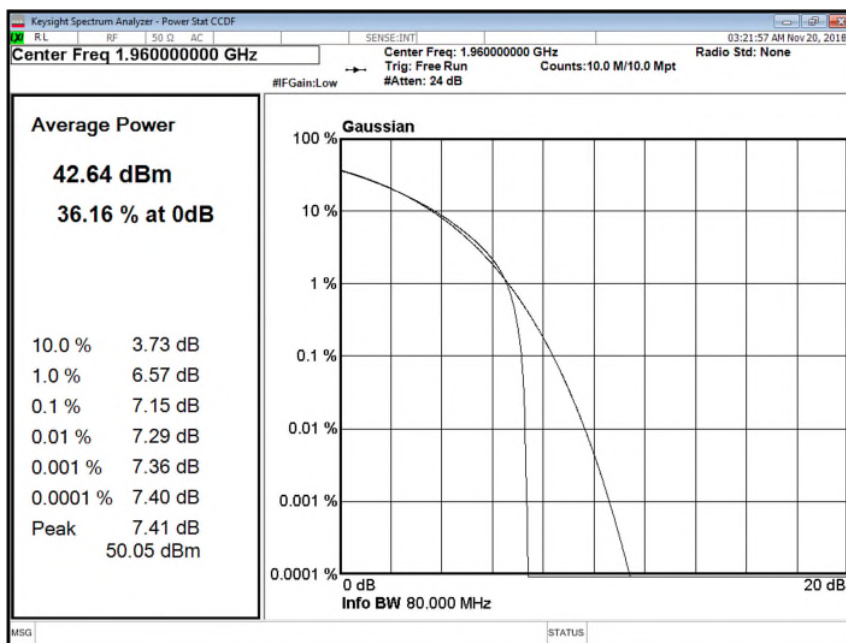



Product Service

Maximum Target Output Power 43 dBm

Antenna	UMTS Modulation	UMTS Carrier Bandwidth	Peak to Average Ratio (PAR) / Output Power		
			Channel Position T2		
			PAR (dB)	Average Power	
dBm	dBm/MHz				
A	QPSK	5.0 MHz	7.64	41.35	36.15

UMTS Modulation QPSK - UMTS Carrier Bandwidth 5.0 MHz - Antenna A

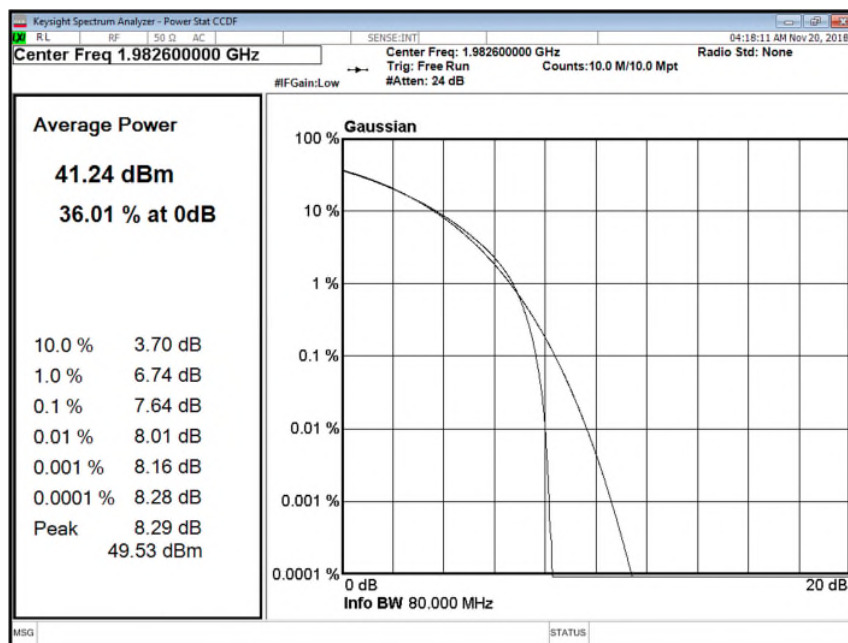



Product Service

Maximum Target Output Power 40 dBm

Antenna	UMTS Modulation	UMTS Carrier Bandwidth	Peak to Average Ratio (PAR) / Output Power		
			Channel Position T		
			PAR (dB)	Average Power	
				dBm	dBm/MHz
A	QPSK	5.0 MHz	7.71	36.43	31.01

UMTS Modulation QPSK - UMTS Carrier Bandwidth 5.0 MHz - Antenna A

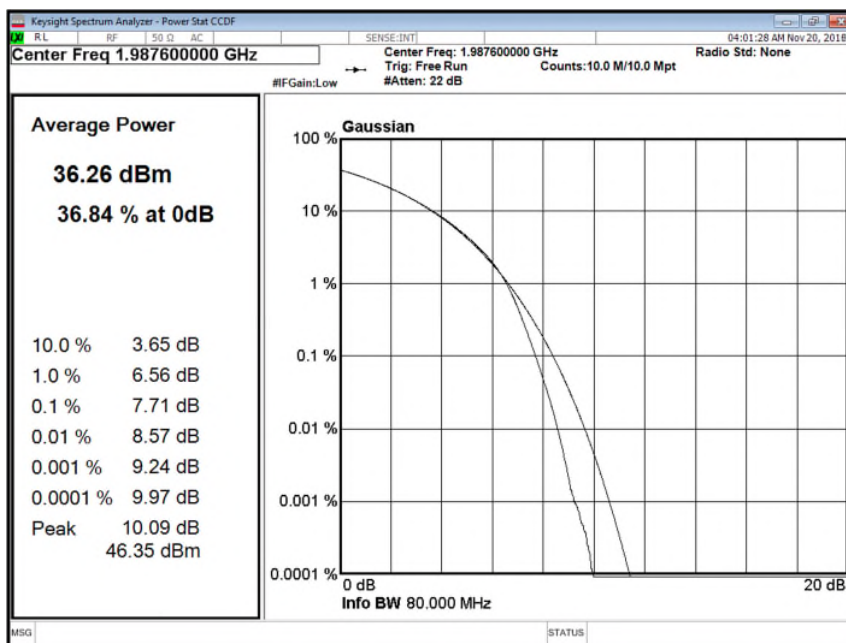

Limit	
Peak to Average Ratio	13 dB



Product Service

1.13 OCCUPIED BANDWIDTH

1.13.1 Specification Reference

FCC CFR 47 Part 2, Clause 2.1049
FCC CFR 47 Part 24, Clause 24.238 (b)

1.13.2 Date of Test and Modification State

November 20, 2018 - Modification State 0

1.13.3 Test Equipment Used

The major items of test equipment used for the above tests are identified in Section 3.1.

1.13.4 Environmental Conditions

Ambient Temperature 21°C
Relative Humidity 30%

1.13.5 Test Method

All measurements were made in accordance with FCC KDB 971168 D01.

1.13.6 Test Results

Maximum Target Output Power B:40 dBm M:43 dBm T:40 dBm

Antenna	UMTS Modulation	UMTS Carrier Bandwidth	Result (KHz)					
			Channel Position B		Channel Position M		Channel Position T	
			Occupied Bandwidth	-26 dB Bandwidth	Occupied Bandwidth	-26 dB Bandwidth	Occupied Bandwidth	-26 dB Bandwidth
A	QPSK	5.0 MHz	4158.47	4667.09	4226.19	6354.37	4164.18	4669.76



Product Service

Antenna A - Bandwidth QPSK – Channel B

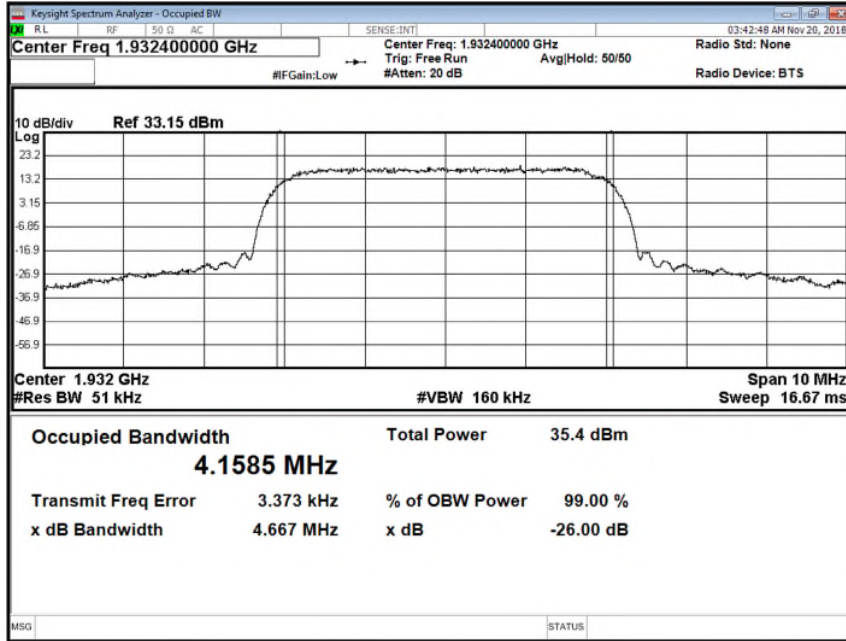

Antenna A - Bandwidth QPSK - Channel M

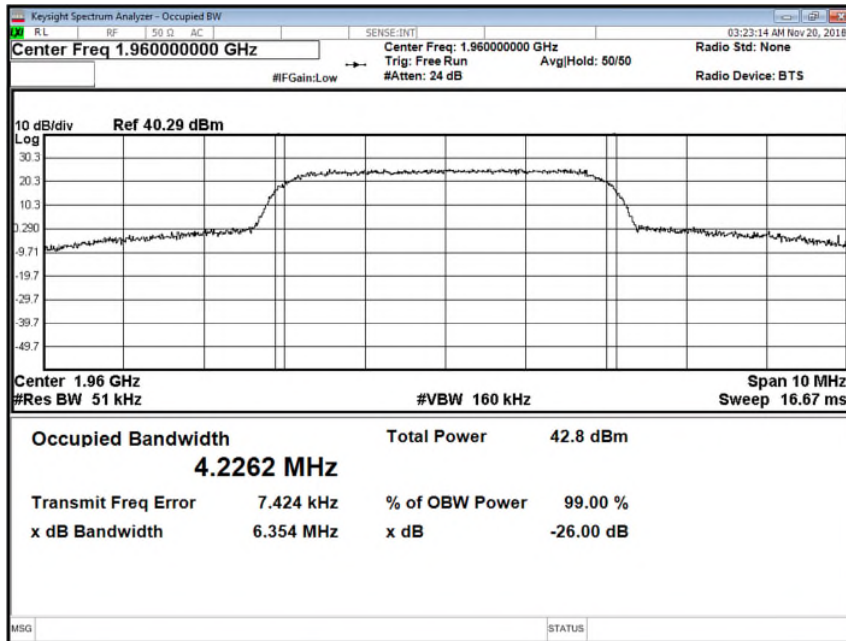



Product Service

Antenna A - Bandwidth QPSK - Channel T

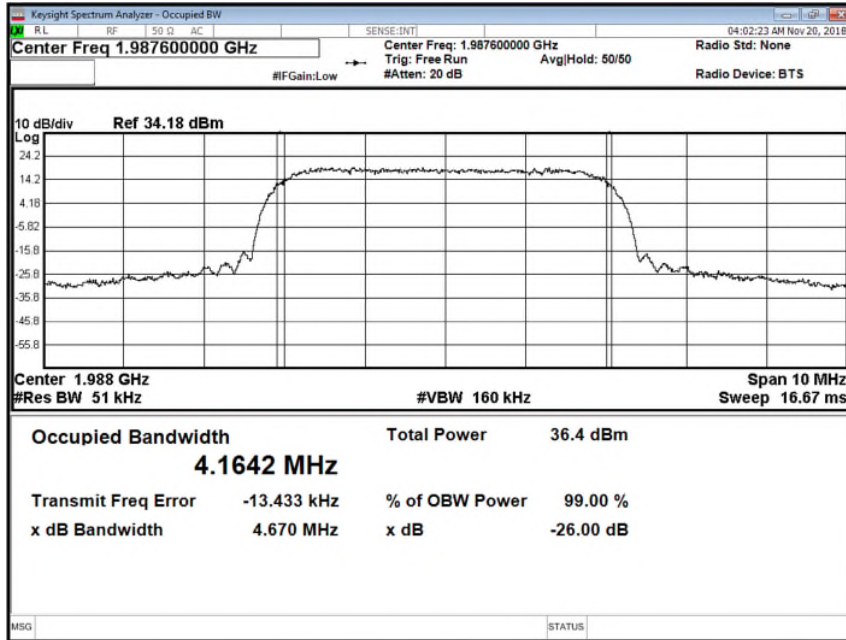



Product Service

1.14 BAND EDGE

1.14.1 Specification Reference

FCC CFR 47 Part 2, Clause 2.1051
FCC CFR 47 Part 24, Clause 24.238 (b)

1.14.2 Date of Test and Modification State

November 20, 2018 - Modification State 0

1.14.3 Test Equipment Used

The major items of test equipment used for the above tests are identified in Section 3.1.

1.14.4 Environmental Conditions

Ambient Temperature 21°C
Relative Humidity 30%

1.14.5 Test Method

All measurements were made in accordance with FCC KDB 971168 D01 Clause 6. The EUT was connected to a Spectrum Analyser via an attenuator and switching box. The path loss between the EUT and the Spectrum Analyser was measured using a Network Analyser. The measured path loss was entered as a Reference Level Offset in the Spectrum Analyser. The Spectrum Analyser RBW was adjusted to be at least 1% of the measured 26dB Bandwidth. Using an RMS detector, the frequency spectrum up to 1MHz away from the Band Edge was investigated. The EUT has one transmit port, testing was performed on this port with a test limit of $43+10\log(P) = -13$ dBm.

1.14.6 Test Results

Maximum Target Output Power T:40 dBm B:40dBm

Antenna	UMTS Modulation	UMTS Carrier Bandwidth	Band Edge (MHz)	
			Channel Position B	Channel Position T
A	QPSK	5.0 MHz	1932.4	1987.6



Product Service

Antenna A - UMTS Modulation QPSK - Channel B, 5MHz

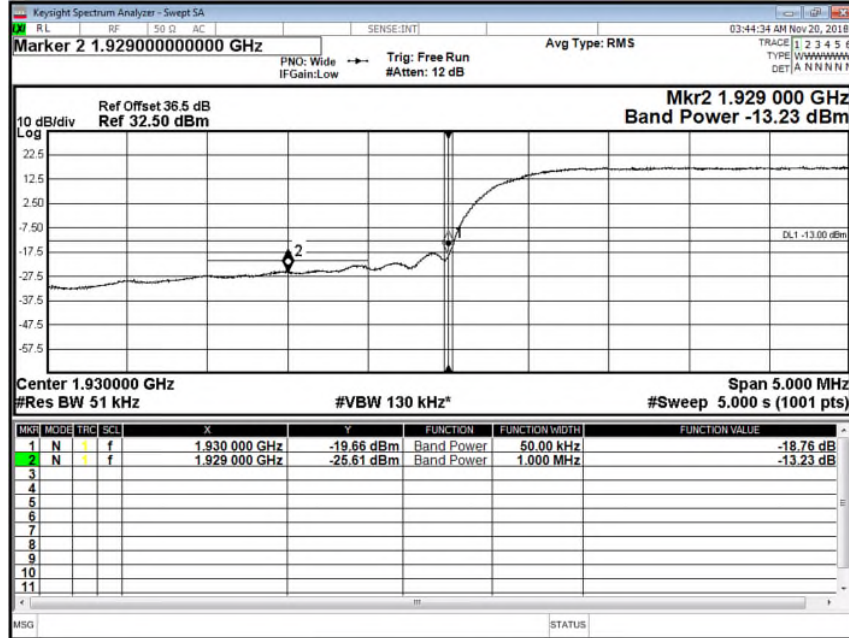

Antenna A - UMTS Modulation QPSK - Channel T, 5MHz

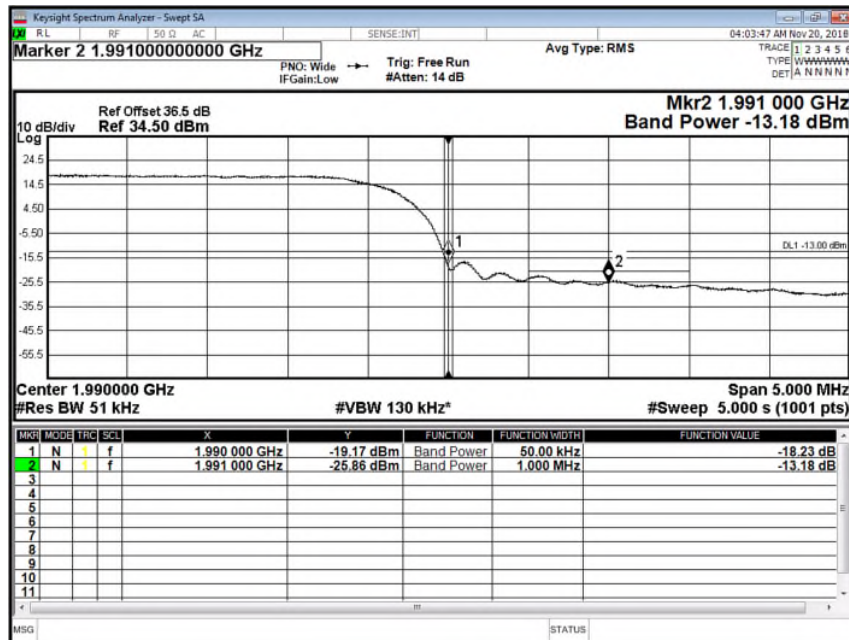



Product Service

Maximum Target Output Power T2:43dBm B2:43dBm

Antenna	UMTS Modulation	UMTS Carrier Bandwidth	Band Edge (MHz)	
			Channel Position B2	Channel Position T2
A	QPSK	5.0 MHz	1937.4	1982.6

Antenna A - UMTS Modulation QPSK - Channel B2, 5MHz

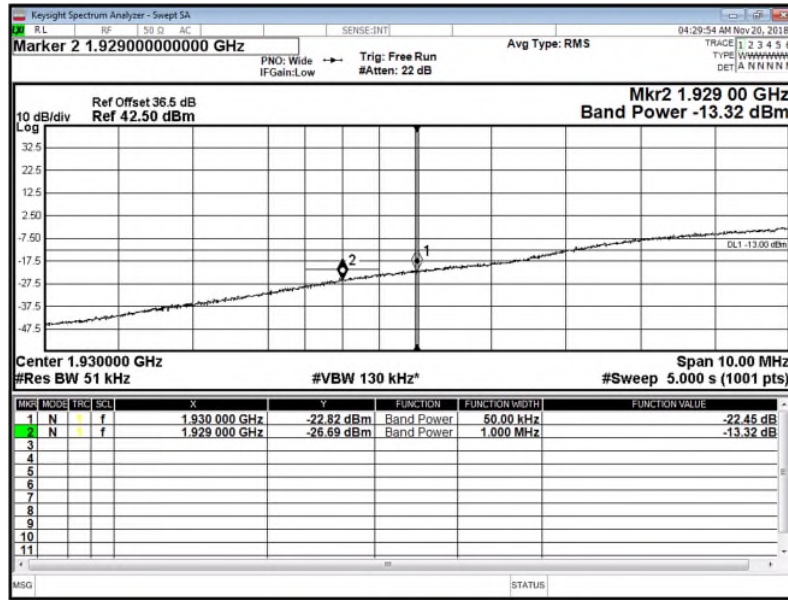

Antenna A - UMTS Modulation QPSK - Channel T2, 5MHz

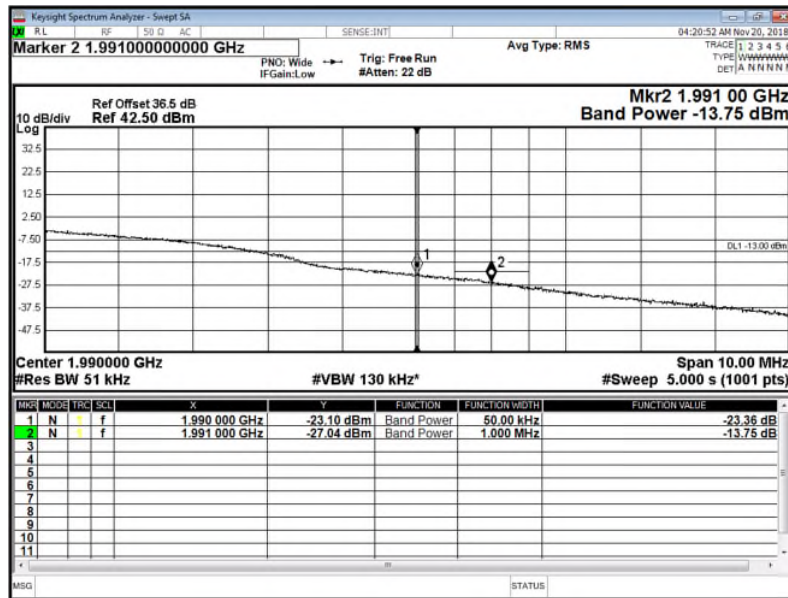

Limit	-13 dBm
-------	---------



Product Service

1.15 TRANSMITTER SPURIOUS EMISSIONS

1.15.1 Specification Reference

FCC CFR 47 Part 2, Clause 2.1051
FCC CFR 47 Part 24, Clause 24.238 (a)

1.15.2 Date of Test and Modification State

November 20, 2018 - Modification State 0

1.15.3 Test Equipment Used

The major items of test equipment used for the above tests are identified in Section 3.1.

1.15.4 Environmental Conditions

Ambient Temperature	21°C
Relative Humidity	30%

1.15.5 Test Method

All measurements were made in accordance with FCC KDB 971168 D01 Clause 6. The EUT was connected to a Spectrum Analyser via an attenuator and switching box. Prior to testing, a Network Analyser was used to calibrate the path loss between the EUT and the Spectrum Analyser. The worst-case path loss in the measured ranges was entered as a reference level offset. Over the measured ranges, the RBW was set to 1MHz with a VBW of 3MHz. All measurement results are specified as average with an RMS detector being used in conjunction with a trace setting of Max Hold. Measurements were performed in configurations of the EUT as reported below.

The EUT has one transmit port, testing was performed on this port with a test limit of $43+10\log(P) = -13$ dBm.

1.15.6 Test Results



Product Service

Maximum Target Output Power B:40 dBm, M:43 dBm, T:40 dBm
UMTS 5 MHz Bandwidth setting

Antenna A - UMTS Modulation QPSK - Channel B

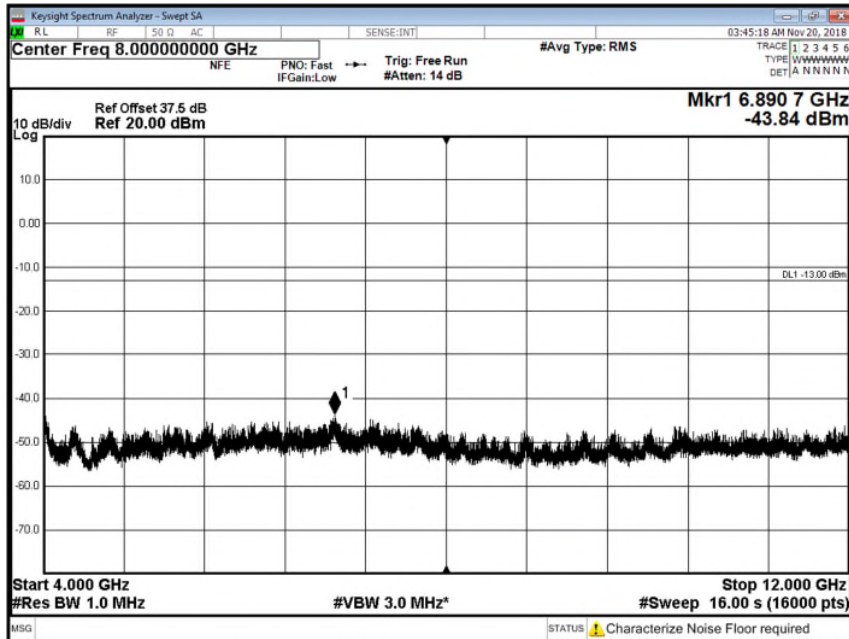
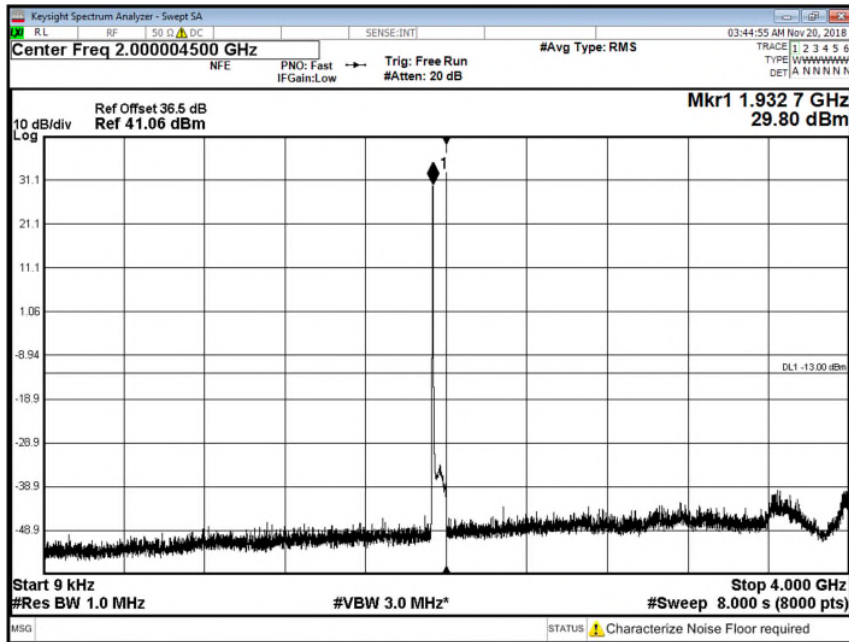



Product Service

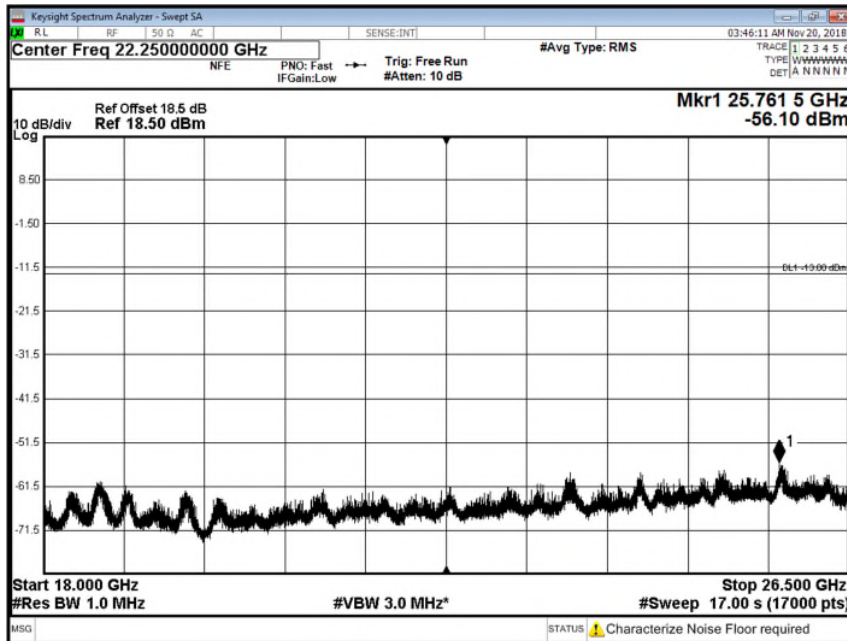
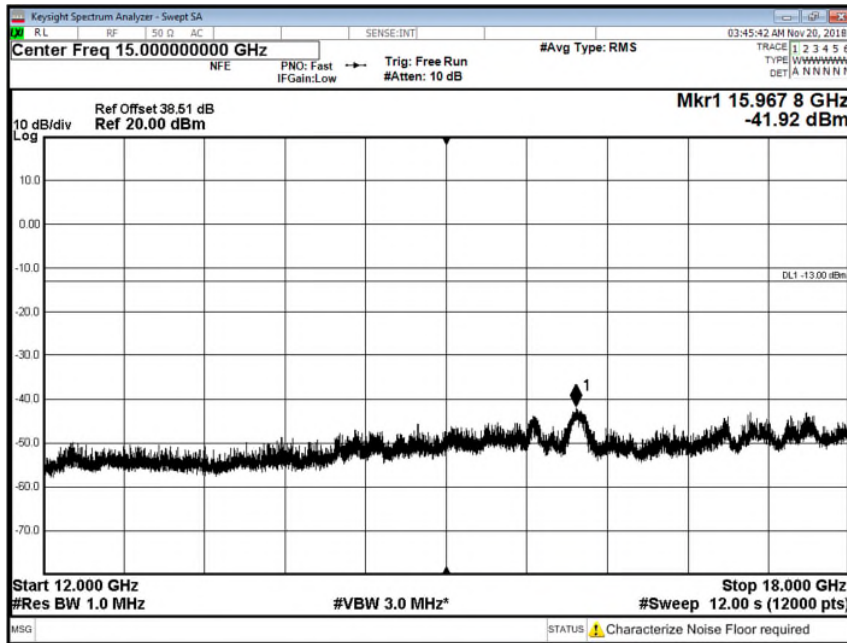



Product Service

Antenna A - UMTS Modulation QPSK - Channel M

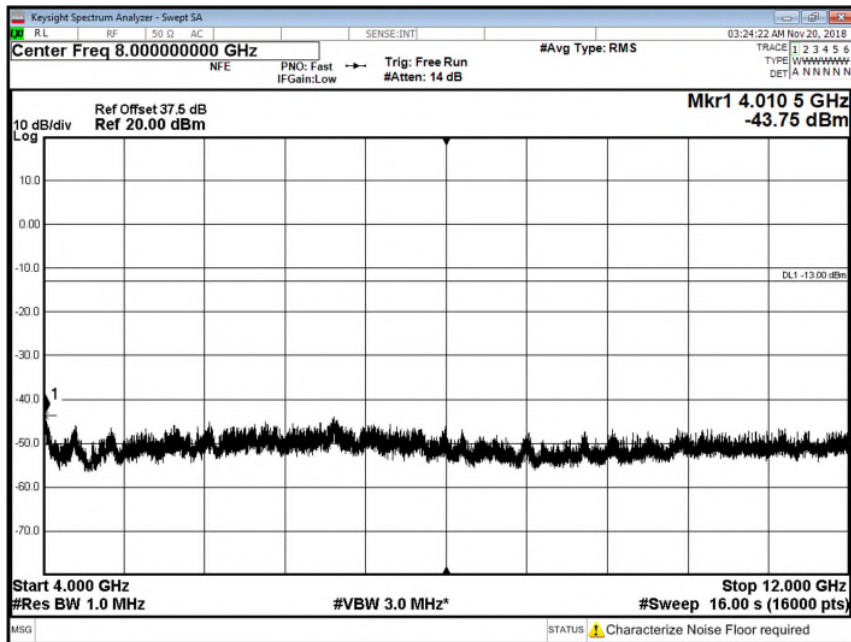
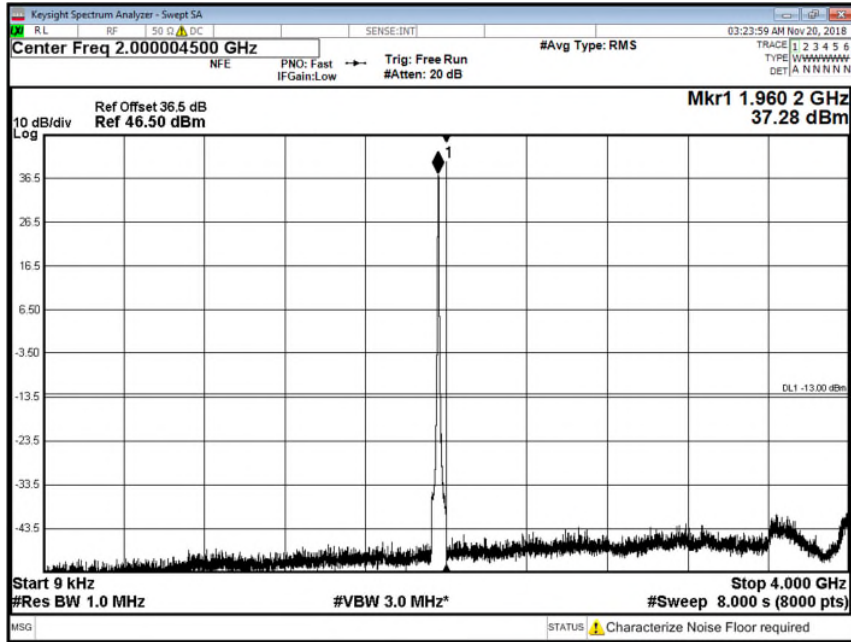



Product Service

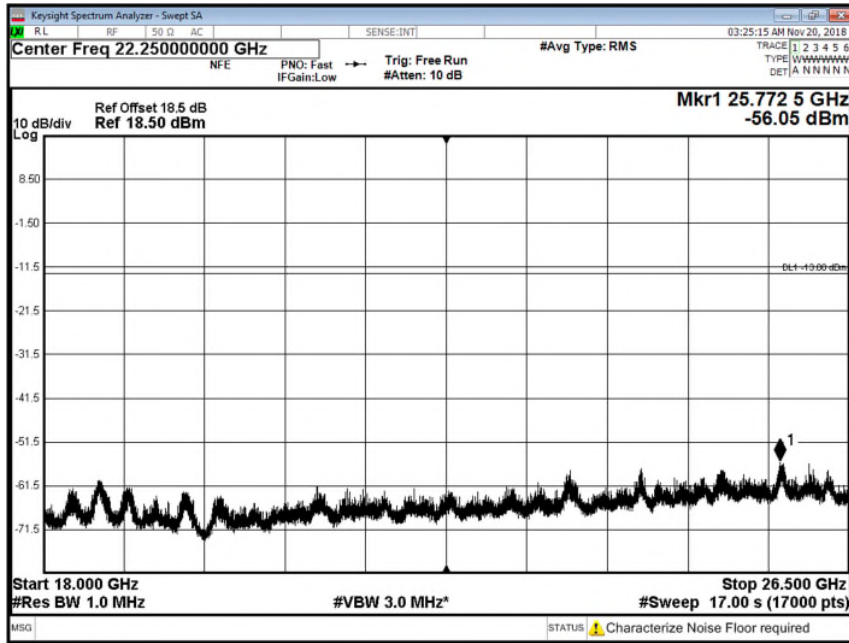
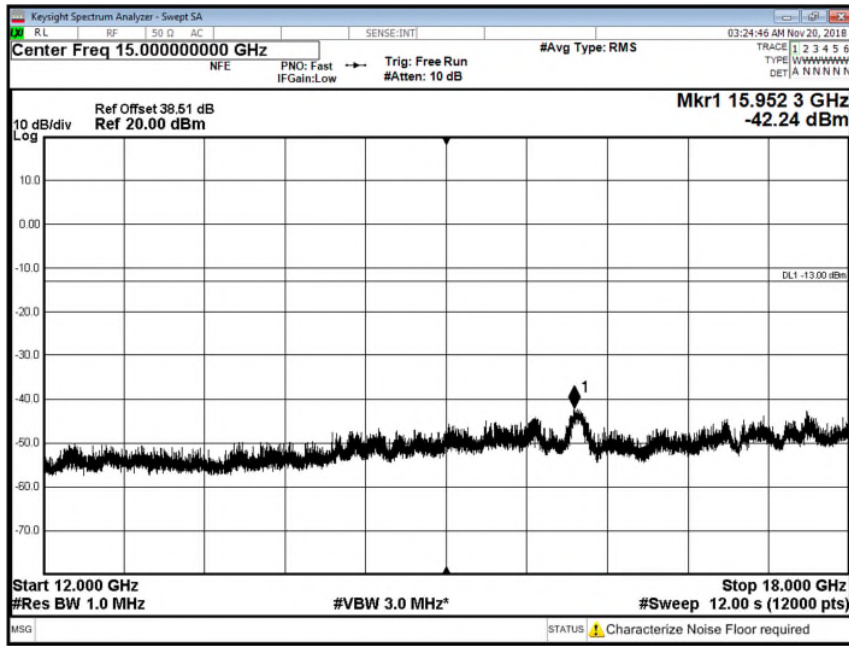



Product Service

Antenna A - UMTS Modulation QPSK - Channel T

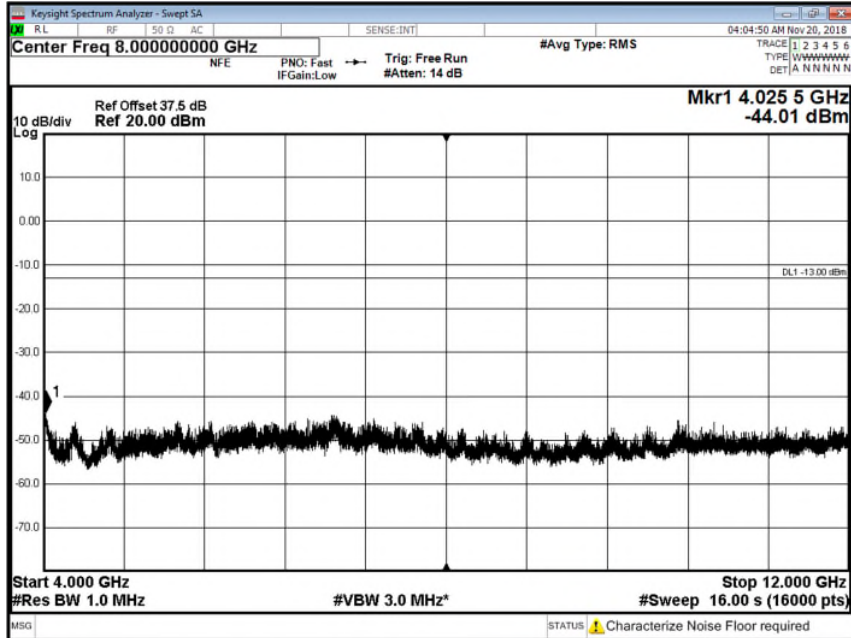
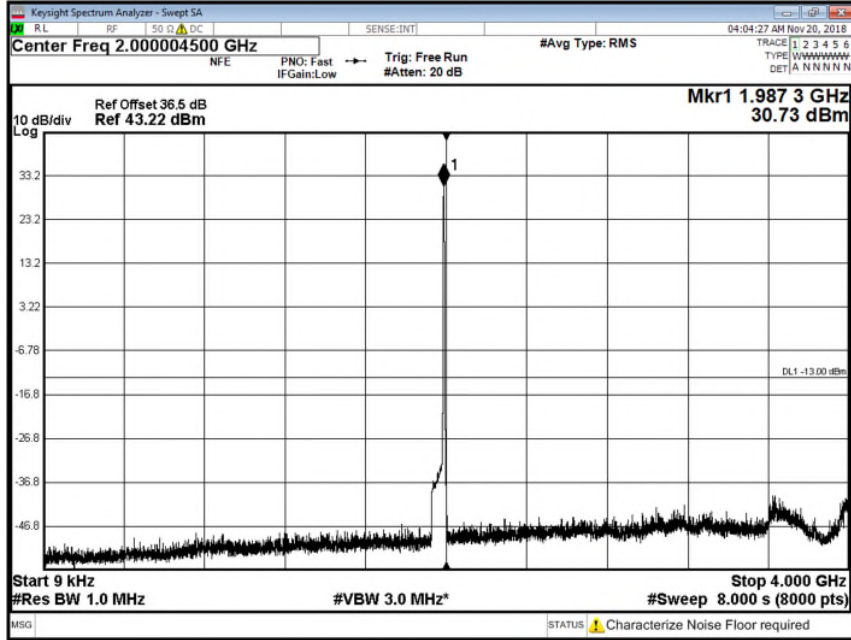



Product Service

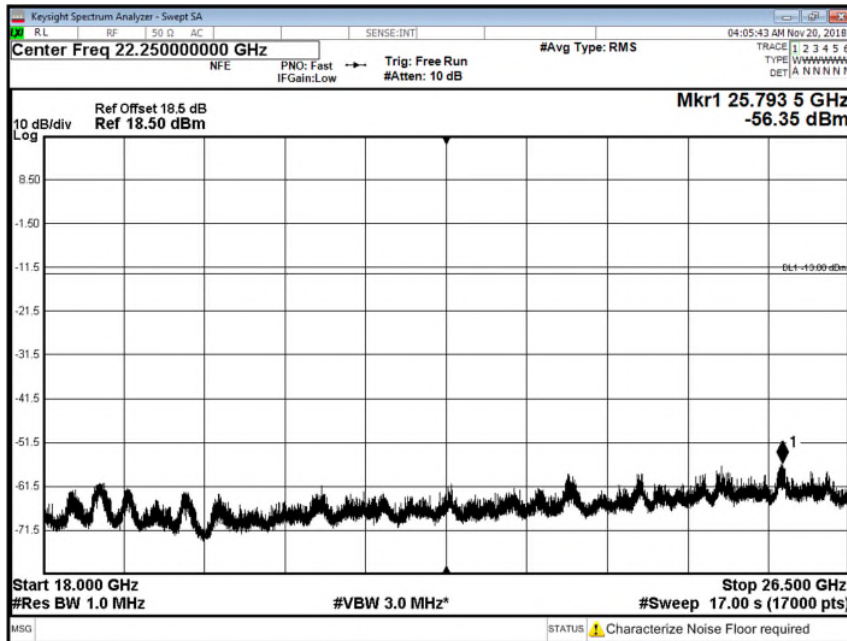
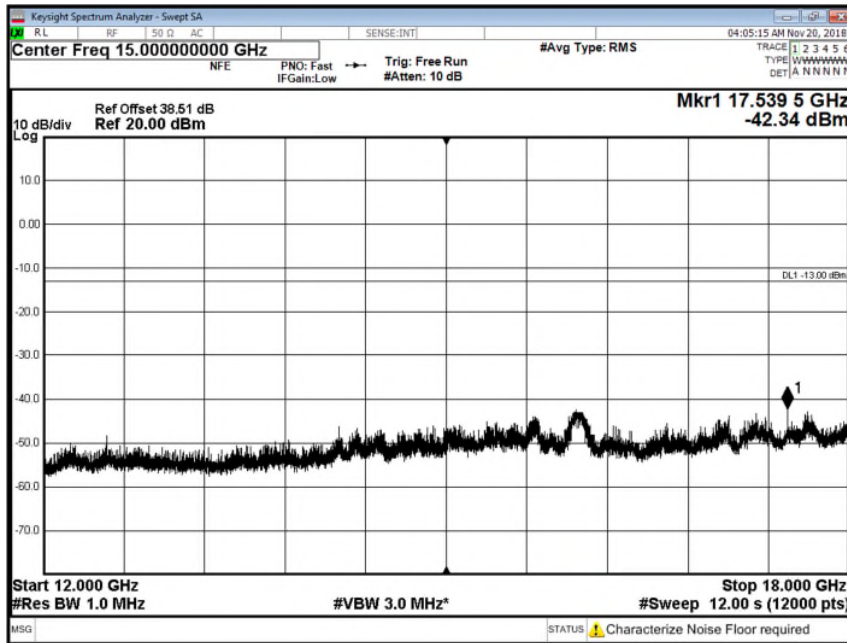

Limit	-13dBm
-------	--------



Product Service

1.16 FREQUENCY STABILITY

1.16.1 Specification Reference

FCC CFR 47 Part 2, Clause 2.1055
FCC CFR 47 Part 24, Clause 24.235

1.16.2 Date of Test and Modification State

October 12 and 15th, 2018 - Modification State 0

1.16.3 Test Equipment Used

The major items of test equipment used for the above tests are identified in Section 3.1.

1.16.4 Environmental Conditions

Ambient Temperature 23°C
Relative Humidity 36%

1.16.5 Test Method

All measurements were made in accordance with FCC KDB 971168 D01.

1.16.6 Test Results

Maximum Target Output Power 43 dBm

Temperature	Voltage	Frequency Error (Hz)
		Channel Position M
-30°C	120V AC	EUT non-operational
-20°C	120V AC	EUT non-operational
-10°C	120V AC	5
0°C	120V AC	0
+10°C	120V AC	0
+20°C	99V AC	0
+20°C	120V AC	0
+20°C	135V AC	0
+30°C	120V AC	0
+40°C	120V AC	5
+50°C	120V AC	10

Limit	+/- 1 ppm
-------	-----------



Product Service

SECTION 3

TEST EQUIPMENT USED



Product Service

2.1 TEST EQUIPMENT USED

List of absolute measuring and other principal items of test equipment.

Instrument	Manufacturer	Type No.	Serial No	Calibration Period (months)	Calibration Due
PXA Signal Analyzer	Keysight	N9030A	MY53310519	12	2019-07-17

N/A – Not Applicable

O/P Mon – Output Monitored with Calibrated Equipment



Product Service

2.2 MEASUREMENT UNCERTAINTY

For a 95% confidence level, the measurement uncertainties for defined systems are:-

Test Discipline	Frequency / Parameter	MU
Conducted Maximum Peak Output Power	30 MHz to 20 GHz Amplitude	± 0.1 dB
Conducted Emissions	30 MHz to 20 GHz Amplitude	± 2.3 dB
Frequency Stability	30 MHz to 2 GHz	± 5.0 Hz
Occupied Bandwidth	Up to 20 MHz Bandwidth	± 1.1 Hz
Band Edge	30 MHz to 20 GHz Amplitude	± 2.3 dB



Product Service

SECTION 5

ACCREDITATION, DISCLAIMERS AND COPYRIGHT



Product Service

3.1 ACCREDITATION, DISCLAIMERS AND COPYRIGHT



This report relates only to the actual item/items tested.

This report does not imply product endorsement by any government, accreditation agency, or TÜV SÜD Canada Inc.

Opinions or interpretations expressed in this report, if any, are outside the scope of TÜV SÜD Canada Inc. accreditations. Any opinions expressed do not necessarily reflect the opinions of TÜV SÜD Canada Inc., unless otherwise stated.

© 2018 TÜV SÜD Product Service