

# RF Report On



**Add value.  
Inspire trust.**

FCC Testing of the Octasic Portable MIMO System in accordance with  
FCC CFR 47 Part 2, and [FCC CFR 47 Part 90S](#)

COMMERCIAL-IN-CONFIDENCE

FCC: 2AQSOCBRSYS4450

PREPARED BY

Handwritten signature of Jose Martinez.

Jose Martinez

APPROVED BY

Handwritten signature of Scott Drysdale.

Scott Drysdale

DATED

Nov. 16, 21

16-Nov-21

Page 1 of 45

Report Issued:  
11/16/2021

Report File #:  
TR-7169009211E-  
CBRSYS4450- CDMA\_Band 0-  
10 -FCC-Issue -02



Testing Laboratory  
Certificate #2955.19



## Contents

<b>1</b>	<b>SECTION 1: REPORT INFORMATION .....</b>	<b>3</b>
1.1	Report Details .....	4
1.2	Brief Summary of Results .....	5
1.3	Product Information .....	6
<b>1.3.1</b>	<b>Technical Description .....</b>	<b>6</b>
1.3.1.1	The Transmission in the CDMA Band 0 and 10 .....	6
<b>1.3.2</b>	<b>Configuration Description .....</b>	<b>7</b>
1.4	Declaration of Build Status .....	8
1.5	General Test Setup.....	10
1.6	Test Conditions.....	11
1.7	Deviation From The Standard .....	11
1.8	Modification Record .....	11
1.9	TEST FACILITY .....	11
<b>2</b>	<b>SECTION 2: TEST DETAILS .....</b>	<b>12</b>
2.1	Maximum Peak Output Power and Peak to Average Ratio - Conducted.....	13
<b>2.1.1</b>	<b>Specification Reference.....</b>	<b>13</b>
<b>2.1.2</b>	<b>Date of Test and Modification State .....</b>	<b>13</b>
<b>2.1.3</b>	<b>Test Equipment Used .....</b>	<b>13</b>
<b>2.1.4</b>	<b>Environmental Conditions.....</b>	<b>13</b>
<b>2.1.6</b>	<b>Test Results .....</b>	<b>13</b>
2.1.6.1	Bottom Channel – 860.76MHz .....	14
2.1.6.1.1	Worst Case – Port 1B .....	15
2.1.6.2	Middle Channel: 862.25MHz .....	16
2.1.6.2.1	Worst Case – Port 2A .....	17
2.1.6.3	Top Channel: 867.75MHz.....	18
2.1.6.3.1	Worst Case – Port 1A .....	19
2.2	Occupied Bandwidth.....	20
<b>2.2.1</b>	<b>Specification Reference.....</b>	<b>20</b>
<b>2.2.2</b>	<b>Date of Test and Modification State .....</b>	<b>20</b>
<b>2.2.3</b>	<b>Test Equipment Used .....</b>	<b>20</b>
<b>2.2.4</b>	<b>Environmental Conditions.....</b>	<b>20</b>
<b>2.2.6</b>	<b>Test Results .....</b>	<b>20</b>
2.2.6.1	Bottom Channel – 860.76 MHz .....	21
2.2.6.1.1	Worst Case – Port 2B .....	21
2.2.6.2	Middle Channel: 862.25 MHz .....	22
2.2.6.2.1	Worst Case – Port 1B .....	22
2.2.6.1	Top Channel – 867.75 MHz.....	23
2.2.6.1.1	Worst Case – Port 1A .....	23
2.3	Band Edge .....	24
<b>2.3.1</b>	<b>Specification Reference.....</b>	<b>24</b>
<b>2.3.2</b>	<b>Date of Test and Modification State .....</b>	<b>24</b>
<b>2.3.3</b>	<b>Test Equipment Used .....</b>	<b>24</b>
<b>2.3.4</b>	<b>Environmental Conditions.....</b>	<b>24</b>
<b>2.3.6</b>	<b>Test Results .....</b>	<b>25</b>
2.3.6.1	Bottom Channel – 860.76 MHz .....	25
2.3.6.1.1	Worst Case – Port 1B .....	25
2.3.6.2	Top Channel: 867.75MHz.....	27
2.3.6.2.1	Worst Case – Port 2B .....	27
2.4	Transceiver Spurious Emissions .....	29
<b>2.4.1</b>	<b>Specification Reference.....</b>	<b>29</b>
<b>2.4.2</b>	<b>Date of Test and Modification State .....</b>	<b>29</b>
<b>2.4.3</b>	<b>Test Equipment Used .....</b>	<b>29</b>



2.4.4	Environmental Conditions.....	29
2.4.6	Test Results.....	30
2.4.6.1.1	Worst Case – Port 1A.....	30
2.5	Frequency Stability.....	33
2.5.1	Specification Reference.....	33
2.5.2	Date of Test and Modification State.....	33
2.5.3	Test Equipment Used.....	33
2.5.4	Environmental Conditions.....	33
2.5.6	Test Results.....	33
2.5.6.1.1	Worst Case – Port 1A.....	33
2.6	Field Strength.....	34
2.6.1	Specification Reference.....	34
2.6.2	Date of Test and Modification State.....	34
2.6.3	Test Equipment Used.....	34
2.6.4	Environmental Conditions.....	34
2.6.6	Test Results.....	35
<b>3</b>	<b>SECTION 3: TEST EQUIPMENT USED.....</b>	<b>40</b>
3.1	Test Equipment Used.....	41
3.2	Measurement Uncertainty.....	42
<b>4</b>	<b>ACCREDITATION, DISCLAIMERS AND COPYRIGHT.....</b>	<b>43</b>
4.1	Accreditation, Disclaimers and Copyright.....	44



## **SECTION 1: REPORT INFORMATION**



## 1.1 REPORT DETAILS

<b>Manufacturer</b>	Octasic inc.
<b>Manufacturer Description</b>	CBRSYS4450
<b>Address</b>	2901 Rachel St. East, Suite 30. Montreal, QC, H1W 4A4
<b>Product Name</b>	Portable MIMO System
<b>Product Number</b>	CBRSYS4450
<b>Serial Number(s)</b>	F-01150
<b>Hardware Version(s)</b>	Version 1
<b>Software Version(s)</b>	BSP CBRBTS-BSP-02.07.03.02-B454
<b>Test Specification/Issue/Date</b>	<a href="#">FCC CFR 47 Part 2: August 16, 2021</a> <a href="#">FCC CFR 47 Part 90S: September 13, 2021</a>
<b>Max Antenna Gain</b>	5dBi
<b>Start of Test</b>	June 22, 2021
<b>Finish of Test</b>	November 3, 2021
<b>Name of Test Personnel(s)</b>	Jose Martinez
<b>Related Document(s)</b>	<a href="#">KDB 971168 D01 v02r02: April 2018</a> <a href="#">KDB 662911 D01 v02r01: October 2013</a>
<b>Test report revision history</b>	2021-09-15. Issue 000. Initial release. 2021-10-20. Issue 01. Modifications: <ul style="list-style-type: none"><li>• Section 2.1. Power table arranged properly</li><li>• Section 2.3.5. Update RBW selection</li></ul> 2021-11-03. Issue 03. Modifications: <ul style="list-style-type: none"><li>• Changed report name from TR-7169009211M... to TR-7169009211E</li><li>• Section 2.3. Added Band-edge analysis at 1.5MHz from the band-edge</li></ul>



## 1.2 BRIEF SUMMARY OF RESULTS

A summary of results for each configuration, in accordance with FCC CFR 47 Part 2, and [FCC CFR 47 Part 90S](#) is shown below.

Table 1 –Test Summary

Section	FCC CFR 47 Part 2	FCC CFR 47 Part 90	Test Description	Result
2.1	§2.1046	<a href="#">§ 90.205(k)</a>	Maximum Peak Output Power	Pass
2.2	§2.202	<a href="#">§90.209(3)</a>	Occupied Bandwidth	Pass
2.3	§2.1051	<a href="#">§90.669(a)</a>	Band Edge	Pass
2.4	§2.1051	<a href="#">§90.691(a)(2)</a>	Transceiver Spurious Emissions	Pass
2.5	§2.1055	<a href="#">§90.213</a>	Frequency Stability	Pass
2.6	-	<a href="#">§90.689</a>	Filed Strength Limit	Pass



### 1.3 PRODUCT INFORMATION

#### 1.3.1 Technical Description

The EUT, hereafter referred as the Equipment Under Test (EUT) is a MIMO Station unit CBRSYS4450 of Octasic Inc capable of transmitting in the LTE-, UTMS-, CDMA- and GSM-Bands.

##### 1.3.1.1 The Transmission in the CDMA Band 0 and 10

The EUT is transmitting in the spectrum in the 800MHz Cellular System/ 800 MHz High Density Cellular System accordin to [§90.7](#).

The channel configuration is as follows:

Channels	Frequency (MHz)	Target Power (dBm)	Power Measured (dBm)
Bottom Channel	860.76	30	29.83 <Note 1>
Middle	862.25	30	29.94 <Note 2>
Top	867.75	30	28.81 <Note 3>
Note 1. See Table 3 in Section 2.1.6.1 Note 2. See Table 4 in Section 2.1.6.2 Note 3. See Table 5 in Section 2.1.6.3.			

A full technical description can be found in the Manufacturer's documentation guide and datasheet CBRSYS4450-User\_Guide.pdf and CBRSYS4450-Datasheet.pdf, respectively.



### 1.3.2 Configuration Description

The EUT supports single mode operation having four transmitting ports (see Figure 3)

TX test cases: Maximum Conducted Output Power, Spurious Emissions at Antenna Terminals ( $\pm 1$  MHz) and Conducted Spurious Emissions, measurements were performed on the four RF Port. The test limits shown are representative of the worst case. All testing was performed with the EUT transmitting at maximum RF power unless as designated setting by client, otherwise stated.

The EUT was powered via a 120V/60Hz power AC/DC Adapter.

#### Channel Configurations:

Table 2 – Channel Configuration

RAT	CDMA Band	No. Of Carriers	Modulation	Carrier Bandwidth	Carrier Frequency Configuration (MHz)		
					Bottom/ B <sub>R</sub> FBW (MHz)	Middle/ M <sub>RFBW</sub> (MHz)	Top/ T <sub>RFBW</sub> (MHz)
5G	0/10	1	QPSK	5 MHz	860.76	862.25	867.75





1.4 DECLARATION OF BUILD STATUS

<b>MAIN EUT</b>	
<b>MANUFACTURING DESCRIPTION</b>	CBRSYS4450
<b>MANUFACTURER</b>	Octasic inc.
<b>TYPE</b>	Portable Transportable Amplification Unit (TAU)
<b>PART NUMBER(S)</b>	CBRSYS4450
<b>SERIAL NUMBER(S)</b>	F-01150
<b>HARDWARE VERSION(S)</b>	Version 1
<b>SOFTWARE VERSIONS(S)</b>	CBRBTS-BSP-02.07
<b>TRANSMITTER OPERATING RANGE (Band 5)</b>	860.76MHz – 867.75MHz
<b>RECEIVER OPERATING RANGE(MHz)</b>	663 to 2690
<b>EMISSION DESIGNATOR(S): (i.e. G1D, GXW)</b>	194M
<b>Country of Origin</b>	Bangalore, India
<b>MODULATION TYPES: (i.e. GMSK, QPSK)</b>	QPSK
<b>HIGHEST INTERNALLY GENERATED FREQUENCY</b>	2.7GHz
<b>OUTPUT POWER (W or dBm)</b>	30dBm
<b>FCC ID:</b>	2AQSOCBRSYS4450
<b>TECHNICAL DESCRIPTION (a brief description of the intended use and operation)</b>	The CBRSYS4450 is a base station solution build for the particular needs of application like search and Rescue (SRR), Network in Box (NiB) and Disaster Recovery. It integrates four transceiver cellular base station (BTS) with all necessary RF, GPS and Wi-Fi antennas. The control is through an easy-to-use Android app on a smartphone or table for convenient on-the-go operation

Equipment Under Test (EUT)



Figure 3. Top view of CBRSYS4450

### 1.5 GENERAL TEST SETUP

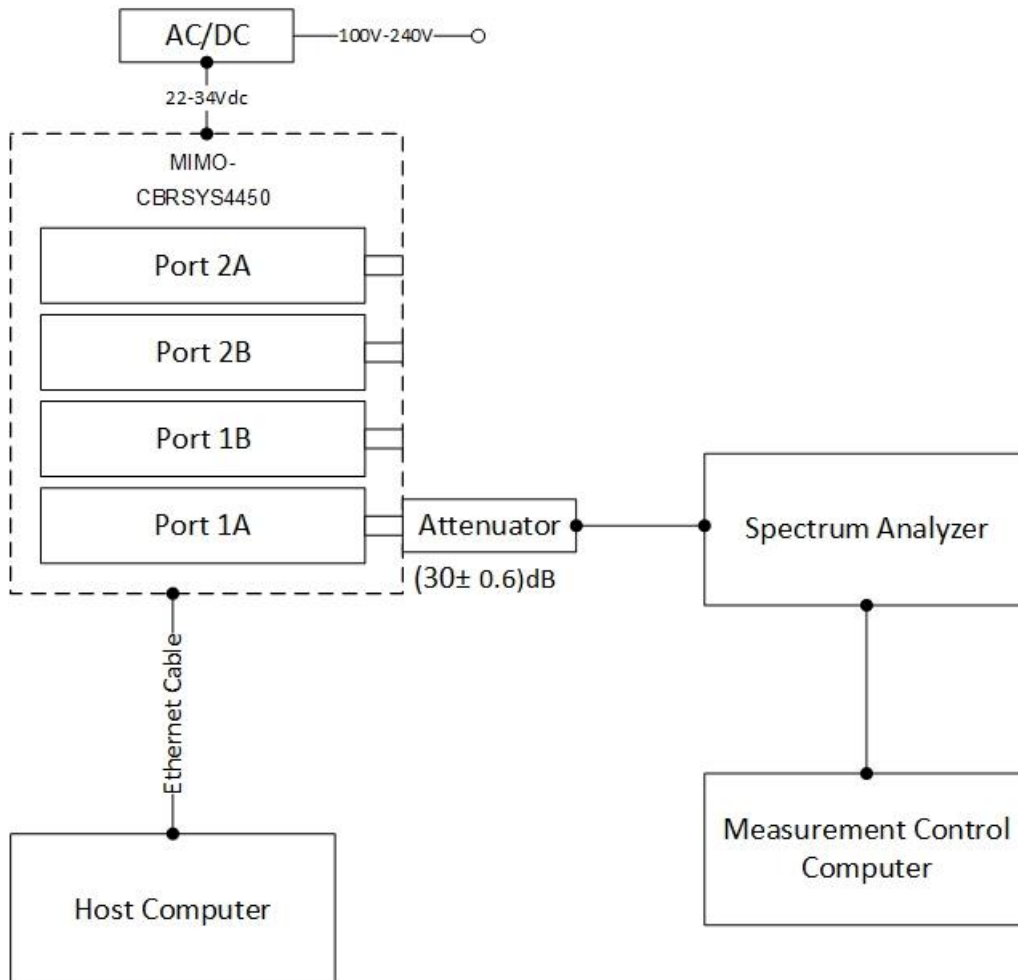

Figure 2. Block Diagram of Conducted Measurement Setup.



## 1.6 TEST CONDITIONS

For all tests the EUT was set up in accordance with the relevant test standard and to represent typical operating conditions. Tests were applied with the EUT situated as described in the Test Method for each Test.

The EUT was powered using the AC/DC adapter.

## 1.7 DEVIATION FROM THE STANDARD

No deviations from the applicable test standards or test plan were made during testing.

## 1.8 MODIFICATION RECORD

No modifications were made to the EUT during testing.

## 1.9 TEST FACILITY

FCC Measurement Facility Registration Number: CA4810

Under our group A2LA Accreditation, TÜV SÜD conducted the following tests at Kanata, Test Laboratory.

Test Name	Name of Test Specialist(s)
Maximum Peak Output Power and Peak to Average Ratio - Conducted	Jose Martinez
Occupied Bandwidth	Jose Martinez
Band Edge	Jose Martinez
Transmitter Spurious Emissions	Jose Martinez
Frequency Stability	Jose Martinez
Field Strength of Spurious Emissions - Radiated	Jose Martinez



## **SECTION 2: TEST DETAILS**



## 2.1 MAXIMUM PEAK OUTPUT POWER AND PEAK TO AVERAGE RATIO - CONDUCTED

### 2.1.1 Specification Reference

FCC CFR 47 Part 2, Clause 2.1046  
FCC FCC CFR 47 Part 90, [Clause 90.541](#)

### 2.1.2 Date of Test and Modification State

12 August 2021 - Modification State 0

### 2.1.3 Test Equipment Used

The major items of test equipment used for the above tests are identified in Section 3.1.

### 2.1.4 Environmental Conditions

Ambient Temperature	25.1°C
Relative Humidity	20.4%

### 2.1.5 Test Method

All measurements were made in accordance with FCC KDB 971168 D01, clause 5.2.1 and and summed in accordance with FCC KDB 662911 D01. The attenuation value used throughout this report is 30dB ± 0.6dB.

Measurements were performed with a Spectrum Analyser using the Band Power measurement function. The detector was set to RMS with an RBW of at least 1 % of the carrier bandwidth and a VBW of at least 3 times the RBW. The integration bandwidth was configured to be wider than the total bandwidth of the carrier or combinations of carriers, (multi-carrier). Using a sweep time of auto, measurements were performed over 200 samples, with the average measurement recorded.

Due to Average measurements being recorded, an additional Peak to Average power ratio (PAPR) measurement was made. This was achieved using the CCDF function of the Spectrum Analyser with the RBW being set to a value wider than the largest signal being measured – in this case – 20MHz.

The EUT was configured to transmit on maximum power on the configurations defined in the tables below.

The peak to average ratio measurement was performed at the conducted ports of the EUT. The spectrum analyzer's Complementary Cumulative Distribution Function (CCDF) was used, and 0.1% probability value recorded.

The RMS Power and Peak to Average Ratio were measured and recorded with the results being compared with the limits.

Measurements presented are the worst-case of measurements conducted in the four ports: TX1A, TX1B, Tx2A and Tx2B, respectively.

### 2.1.6 Test Results



**2.1.6.1 Bottom Channel – 860.76MHz**

Maximum Target Output Power: 30 dBm

Table 3 – Max Peak Output Power – Bottom Channel

Antenna	Output Power				Results
	Conducted Average Power <Note 1>		ERP <Note 2>	Limit <Note 3>	
	(dBm)	(mW)	(dBm)	(W)	
TX1A	29.75	944.06	30.78	200	Pass
TX1B	29.83 <Note 1>	961.61	31.21		
TX2A	29.67	926.83	31.15		
TX2B	29.67	926.83	30.9		
Total		35.75	3759.33	-	
Note 1. See worst-case TX1B in Graph 1 Note 2. ERP =EIRP -2.15 dB as per <a href="#">412172 D01</a> Note 3 As per FCC CFR 47 Part 90, <a href="#">Clause 90.541</a>					



### 2.1.6.1.1 Worst Case – Port 1B

Carrier Power Modulation QPSK - Carrier Bandwidth 2.0 MHz – Channel Position: 860.76 MHz

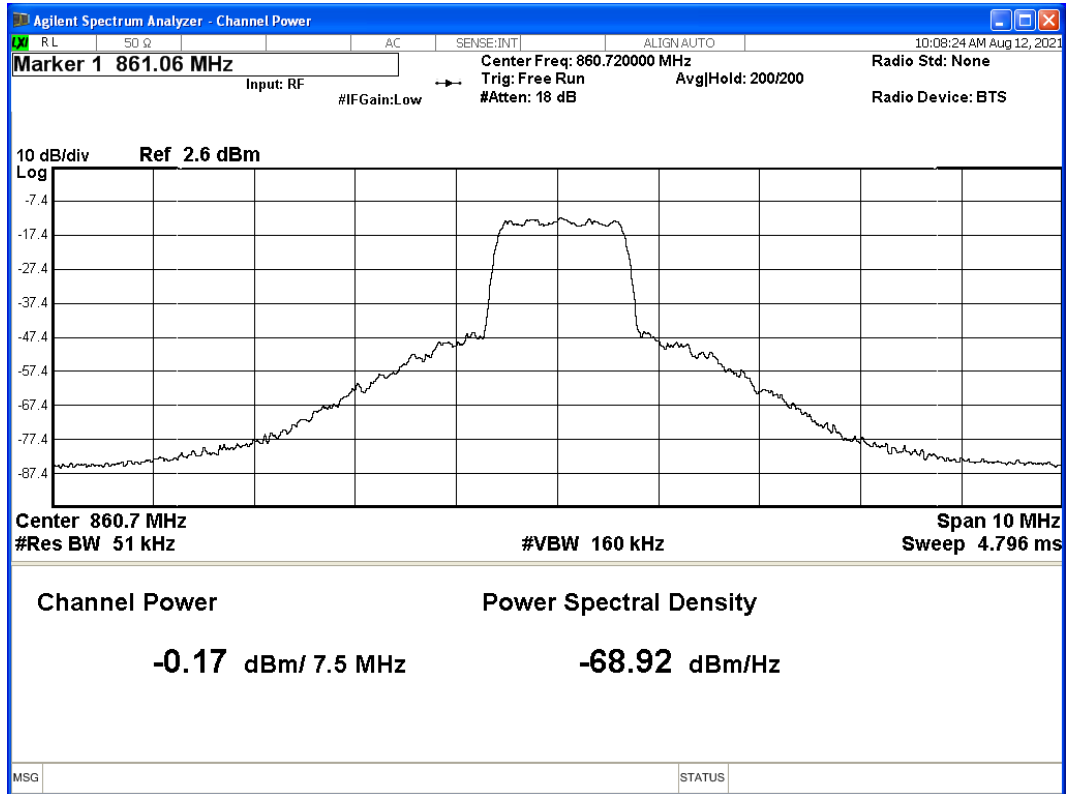

Graph 1: Output Power – Port 1B – Bottom Channel

Calculation:  $30\text{dB} - 0.17\text{ dBm} = 29.83\text{ dBm}$ .





**2.1.6.2 Middle Channel: 862.25MHz**

Maximum Target Output Power: 30 dBm

Table 4 – Max Peak Output Power – Middle Channel

Antenna	Output Power				Results
	Conducted Average Power <Note 1>		ERP <Note 2>	Limit <Note 3>	
	(dBm)	(mW)	(dBm)	(W)	
TX1A	29.85	966.05	31.07	200	Pass
TX1B	29.82	959.40	30.87		
TX2A	29.94 <Note 1>	986.28	31.14		
TX2B	29.92	981.75	31.06		
Total	35.90	3893.48	3759.33		
Note 1. See worst-case TX1B in Graph 2. Note 2. ERP =EIRP -2.15 dB as per <a href="#">412172 D01</a> Note 3 As per FCC CFR 47 Part 90, <a href="#">Clause 90.541</a>					



### 2.1.6.2.1 Worst Case – Port 2A

Carrier Power - Modulation QPSK - Carrier Bandwidth 2.0 MHz – Channel Position:  
862.25MHz

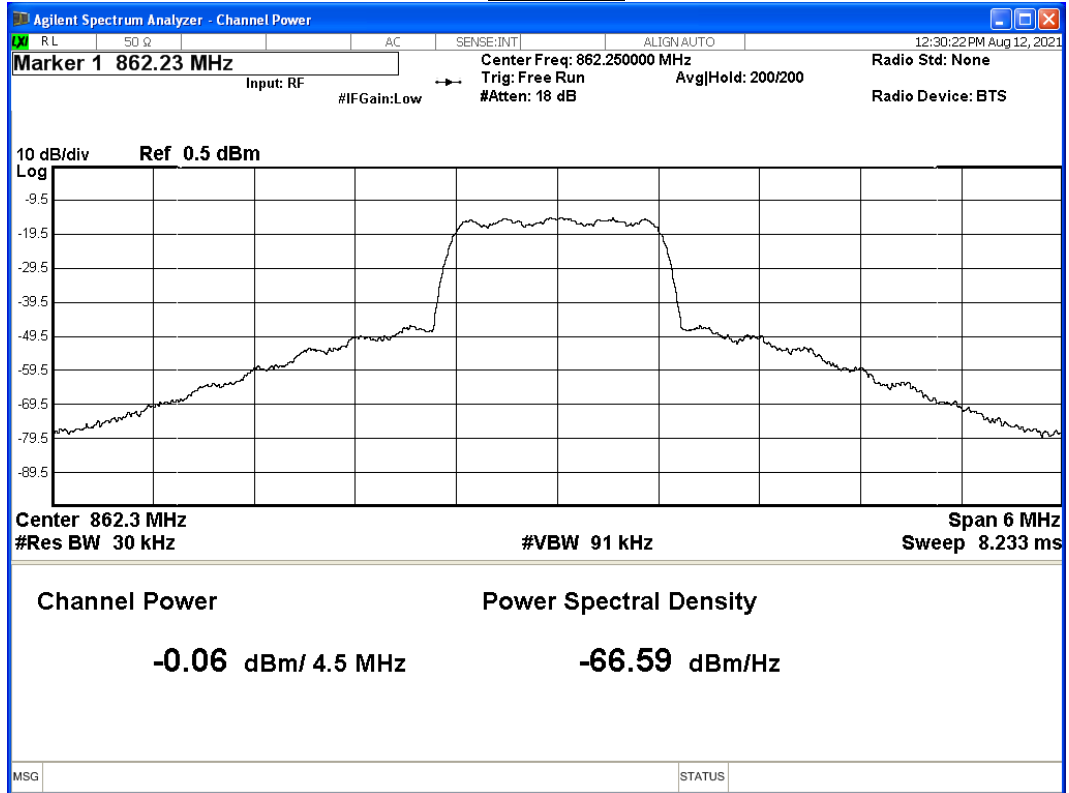

Graph 2: Output Power – Port 2A – Middle Channel

Calculation:  $30.5\text{dB} - 0.06\text{ dBm} = 29.94\text{ dBm}$ .



**2.1.6.3 Top Channel: 867.75MHz**

Maximum Target Output Power: 30 dBm

Table 5 – Max Peak Output Power – Top Channel

Antenna	Output Power				Results
	Conducted Average Power <Note 1>		ERP <Note 2>	Limit <Note 3>	
	(dBm)	(mW)	(dBm)	(W)	
TX1A	29.81 <Note 1>	957.19	30.88	200	Pass
TX1B	29.7	933.25	30.79		
TX2A	29.77	948.42	30.95		
TX2B	29.79	952.80	30.89		
Total	35.79	3791.66	-		
Note 1. See worst-case TX1B in Graph 3 Note 2. ERP =EIRP -2.15 dB as per <a href="#">412172 D01</a> Note 3 As per FCC CFR 47 Part 90, <a href="#">Clause 90.541</a>					



### 2.1.6.3.1 Worst Case – Port 1A

Carrier Power - Modulation QPSK - Carrier Bandwidth 2.0 MHz – Channel Position: 867.75MHz

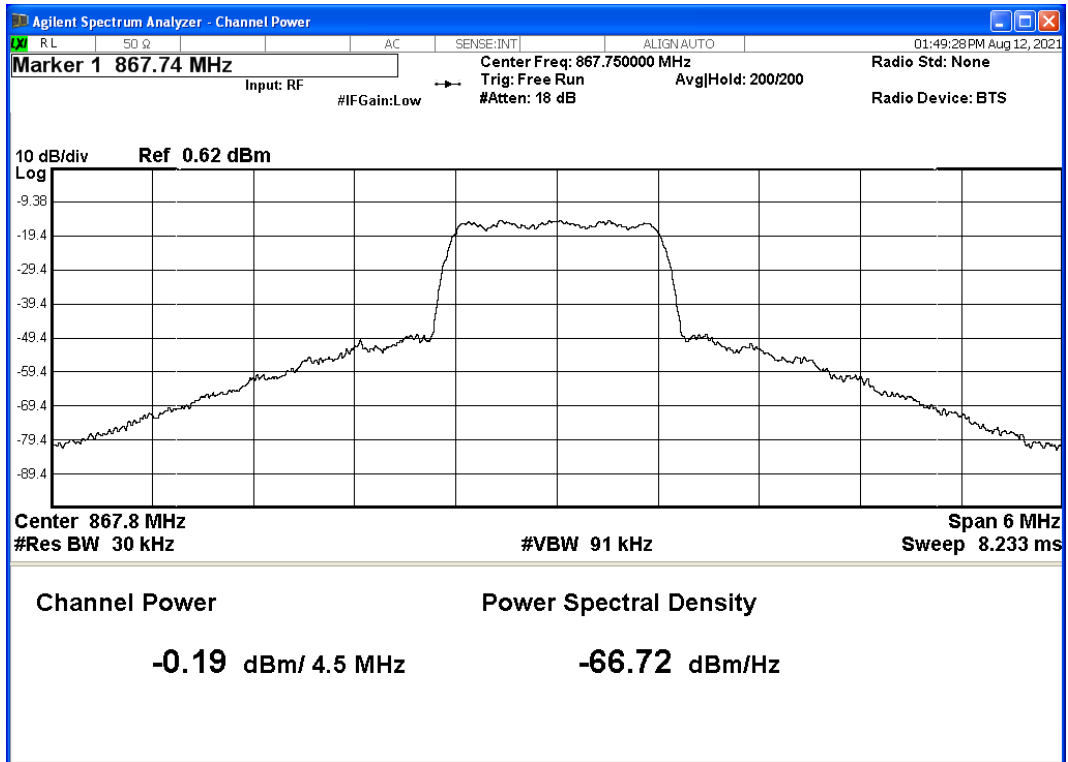

Graph 3: Output Power – Port 1A – Top Channel

Calculation.  $30 \text{ dB} - 0.19 \text{ dBm} = 29.81 \text{ dBm}$ .



## 2.2 OCCUPIED BANDWIDTH

### 2.2.1 Specification Reference

FCC CFR 47 Part 2, [Clause 2.202](#)  
FCC CFR 47 Part 27, [Clause § 22.917](#)  
FCC CFR 47 Part 90 [Clause 90.209](#)

### 2.2.2 Date of Test and Modification State

12 August 2021 - Modification State 0

### 2.2.3 Test Equipment Used

The major items of test equipment used for the above tests are identified in Section 3.1.

### 2.2.4 Environmental Conditions

Ambient Temperature	22.1°C
Relative Humidity	16.4%

### 2.2.5 Test Method

All measurements were made in accordance with FCC KDB 971168 D01.

### 2.2.6 Test Results

Maximum Output Power: Bottom- Middle- and Top- channels was 30 dBm; respectively. The worst-case scenario of all channels is provided below.



2.2.6.1 Bottom Channel – 860.76 MHz

2.2.6.1.1 Worst Case – Port 2B

Modulation	Carrier Bandwidth	Result (MHz)	
		Channel Bandwidth	-26 dB Bandwidth
QPSK	2.0 MHz	2	1.5

Bandwidth 2.0MHz – Modulation: QPSK – Channel B: 860.76 MHz

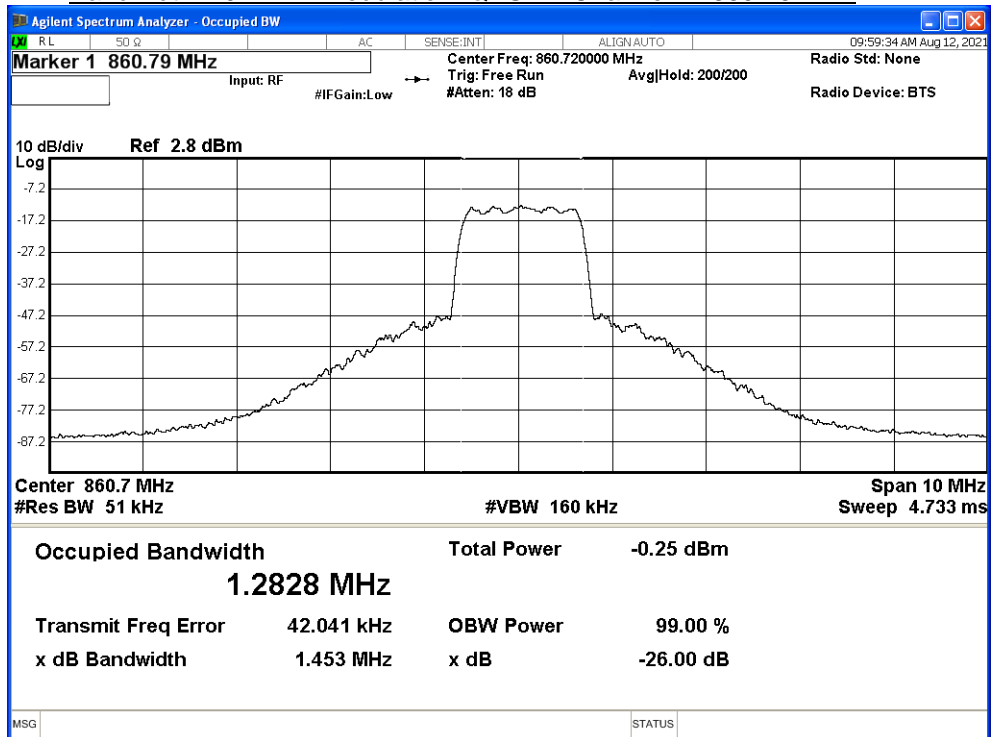



2.2.6.2 Middle Channel: 862.25 MHz

2.2.6.2.1 Worst Case – Port 1B

Modulation	Carrier Bandwidth	Result (MHz)	
		Channel Bandwidth	
		Occupied Bandwidth	-26 dB Bandwidth
QPSK	2.0 MHz	1.3	1.5

Bandwidth 2.0MHz – Modulation: QPSK – Channel Middle: 862.25 MHz

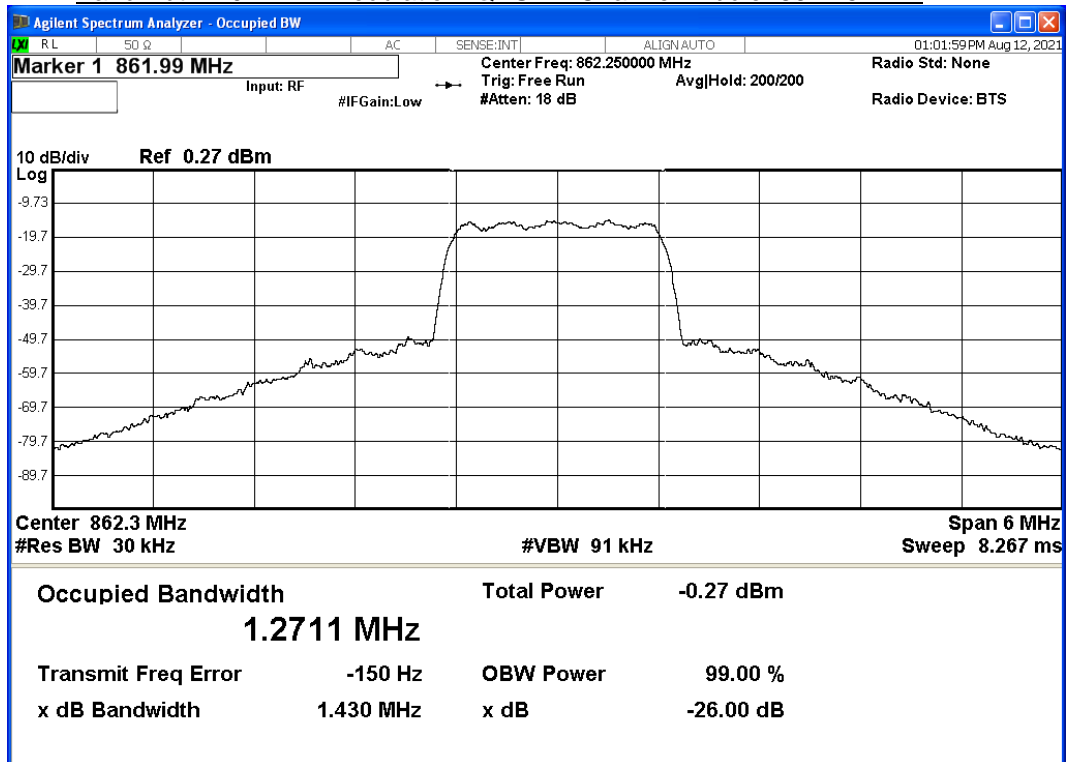



2.2.6.1 Top Channel – 867.75 MHz

2.2.6.1.1 Worst Case – Port 1A

Modulation	Carrier Bandwidth	Result (MHz)	
		Channel Bandwidth	
		Occupied Bandwidth	-26 dB Bandwidth
QPSK	2.0 MHz	1.3	1.4

Bandwidth 2.0MHz – Modulation: QPSK – Channel Top: 867.75 MHz

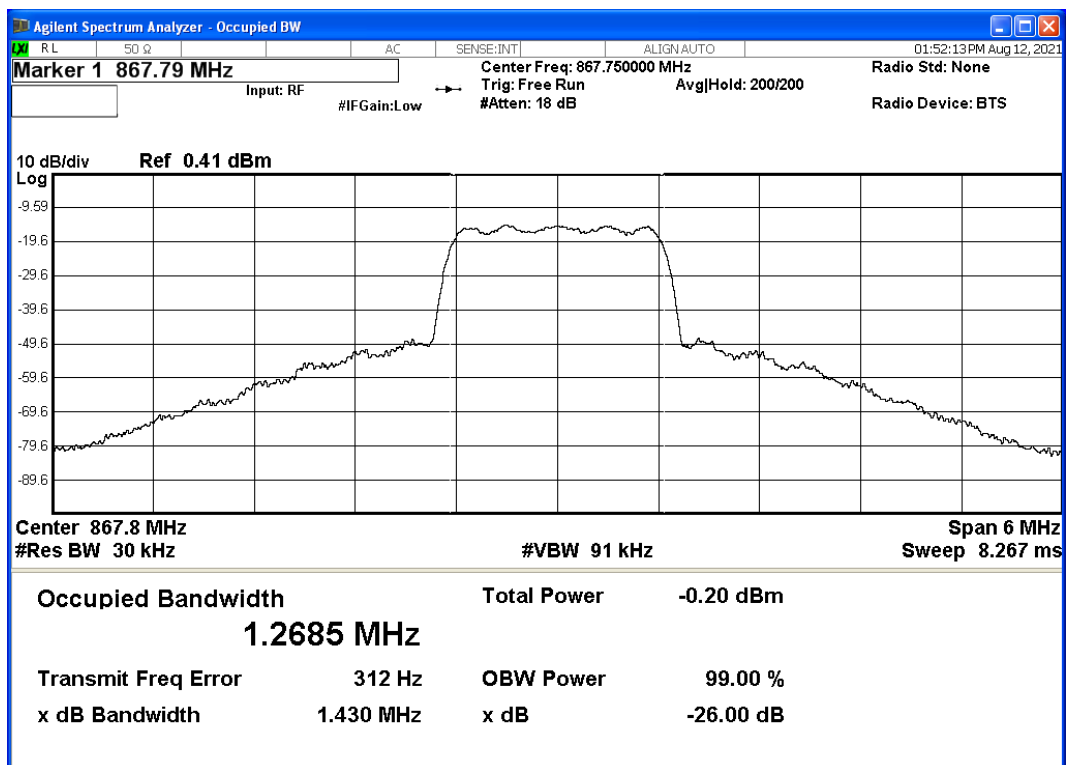





## 2.3 BAND EDGE

### 2.3.1 Specification Reference

FCC CFR 47 Part 2, Clause 2.1051  
FCC CFR 47 Part 90, Clause [§90.669\(a\)](#)

### 2.3.2 Date of Test and Modification State

12 August 2021 - Modification State 0  
3 November 2021 – Modification State 0

### 2.3.3 Test Equipment Used

The major items of test equipment used for the above tests are identified in Section 3.1.

### 2.3.4 Environmental Conditions

Ambient Temperature	24.1°C
Relative Humidity	25.4%

### 2.3.5 Test Method

All measurements were made in accordance with FCC KDB 971168 D01, clause 6. The EUT was connected to a Spectrum Analyser via an attenuator. The path loss between the EUT and the Spectrum Analyser was measured using a Network Analyser. The measured path loss was entered as a Reference Level Offset in the Spectrum Analyser. The Spectrum Analyser RBW was adjusted to be at least 1% of the measured 26dB Bandwidth. Using an RMS detector, the frequency spectrum up to 1MHz away from the Band Edge was Investigated.

The Spectrum Analyser RBW was adjusted to be at least 1% of the measured 26dB Bandwidth. Using an RMS detector, the frequency spectrum up to 1MHz from the band edge was investigated. The worst-case path loss in the measured ranges was entered as a reference level offset. Over the measured ranges, the RBW was set to 10kHz, however the band power function of the SA was used with an integration of 50kHz bandwidth. All measurement results are specified as average with an RMS detector being used in conjunction with a trace setting of Max Hold or clear write if representative. Measurements were performed in configurations of the EUT as reported below.

The EUT has four transmit ports, testing was performed in all ports with a test limit of:

$$43+10 \times \log_{10}(P) + 10 \times \log_{10}(4) = -19 \text{ dBm}$$



## 2.3.6 Test Results

Maximum Output Power: Bottom 30 dBm; Middle 30 dBm and Top 30 dBm. The band edges of ports were determined and only the worst scenario is provided.

### 2.3.6.1 Bottom Channel – 860.76 MHz

#### 2.3.6.1.1 Worst Case – Port 1B

Maximum Target output Power: 30dBm

Modulation	Carrier Bandwidth	Band Edge (MHz)			Band Power	
		Channel Position: Bottom	Lower Band	Upper Band	50kHz	100kHz
QPSK	1.2 MHz	860.76	851	869	-64.14	-68.14

Modulation QPSK - Carrier Bandwidth 1.2 MHz - Channel Position: 860.76 MHz (Band Power 50kHz)

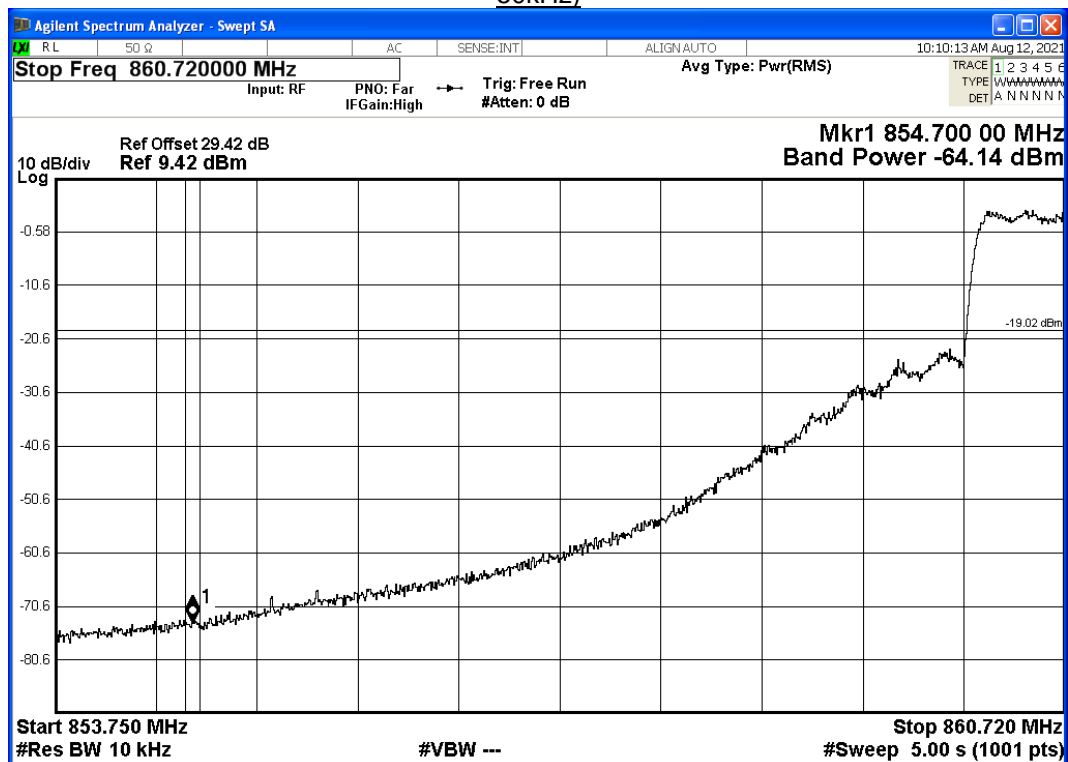



Modulation QPSK - Carrier Bandwidth 1.2 MHz - Channel Position: 860.76 MHz (Band Power 100kHz)

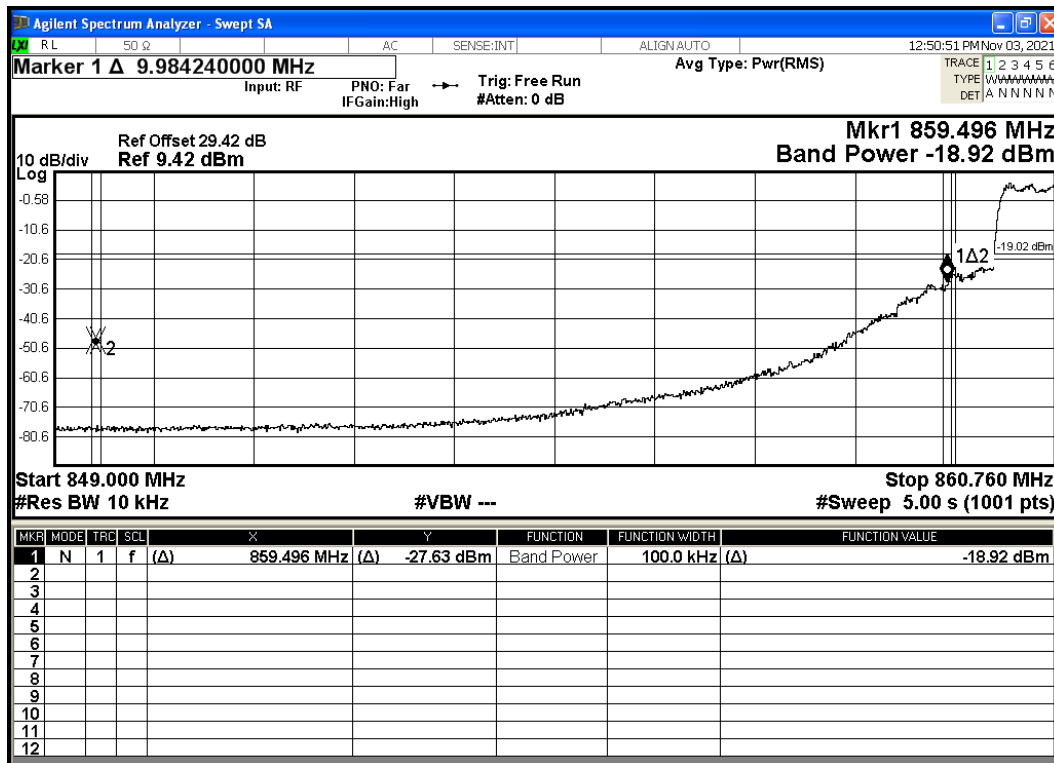
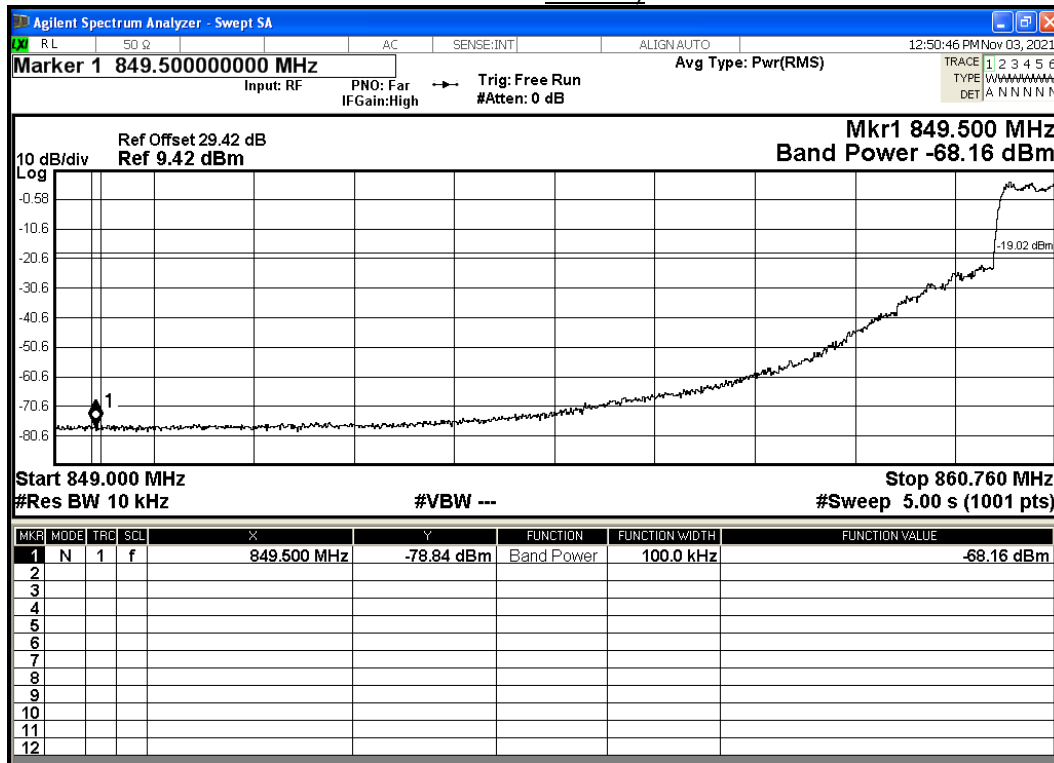



### 2.3.6.2 Top Channel: 867.75MHz

Maximum Target output Power: 30 dBm

#### 2.3.6.2.1 Worst Case – Port 2B

Modulation	Carrier Bandwidth	Band Edge (MHz)			Band Power	
		Channel Position: Bottom	Lower Band	Upper Band	50kHz	100kHz
QPSK	1.2 MHz	867.75	851	869	-21.05	-43.24

Modulation QPSK - Carrier Bandwidth 2.0 MHz - Channel Position: 867.75MHz (Band Power 50kHz)

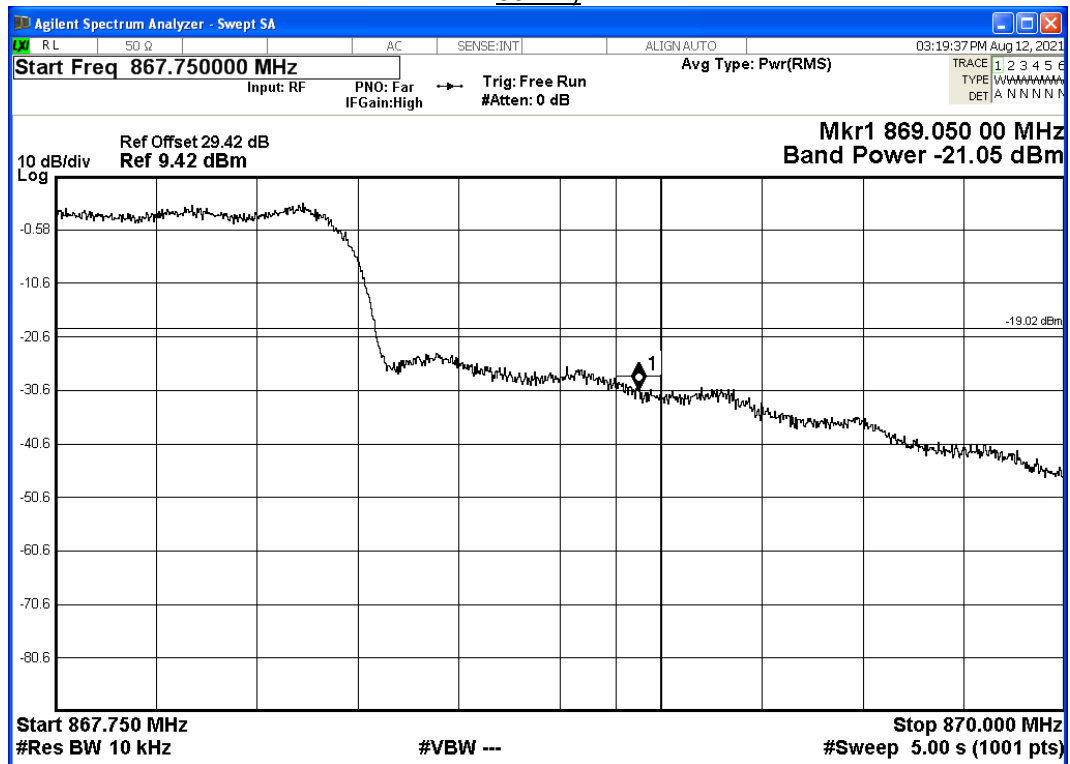



Modulation QPSK - Carrier Bandwidth 2.0 MHz - Channel Position: 867.75MHz (Band Power 100kHz)

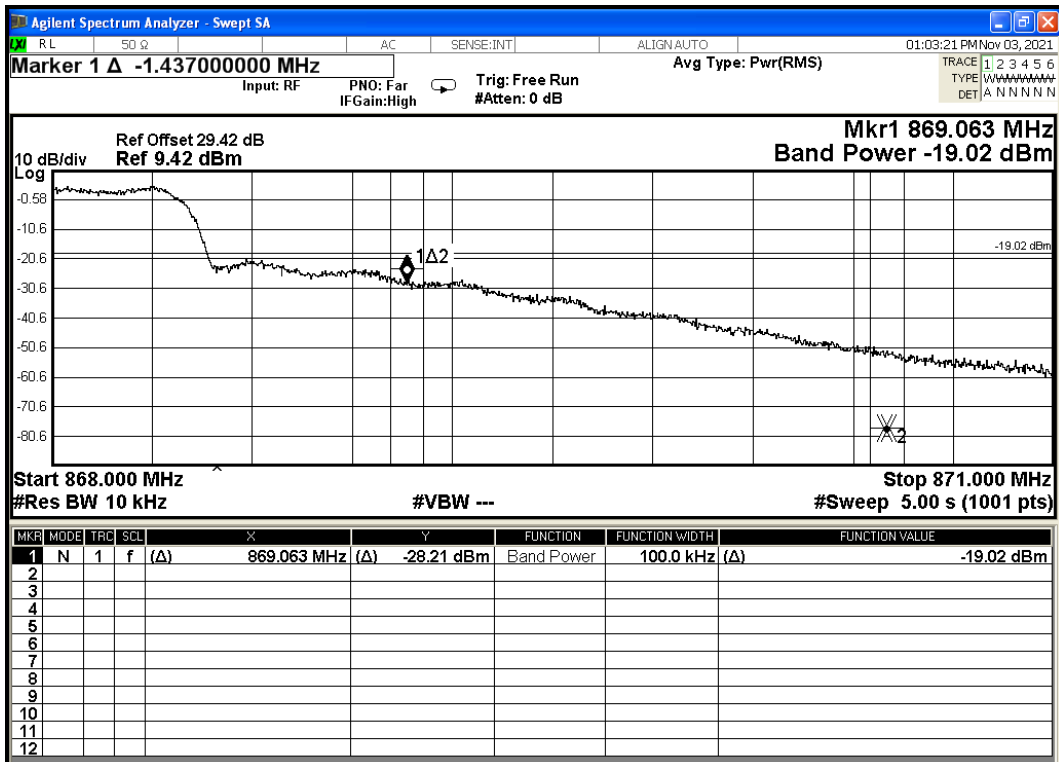
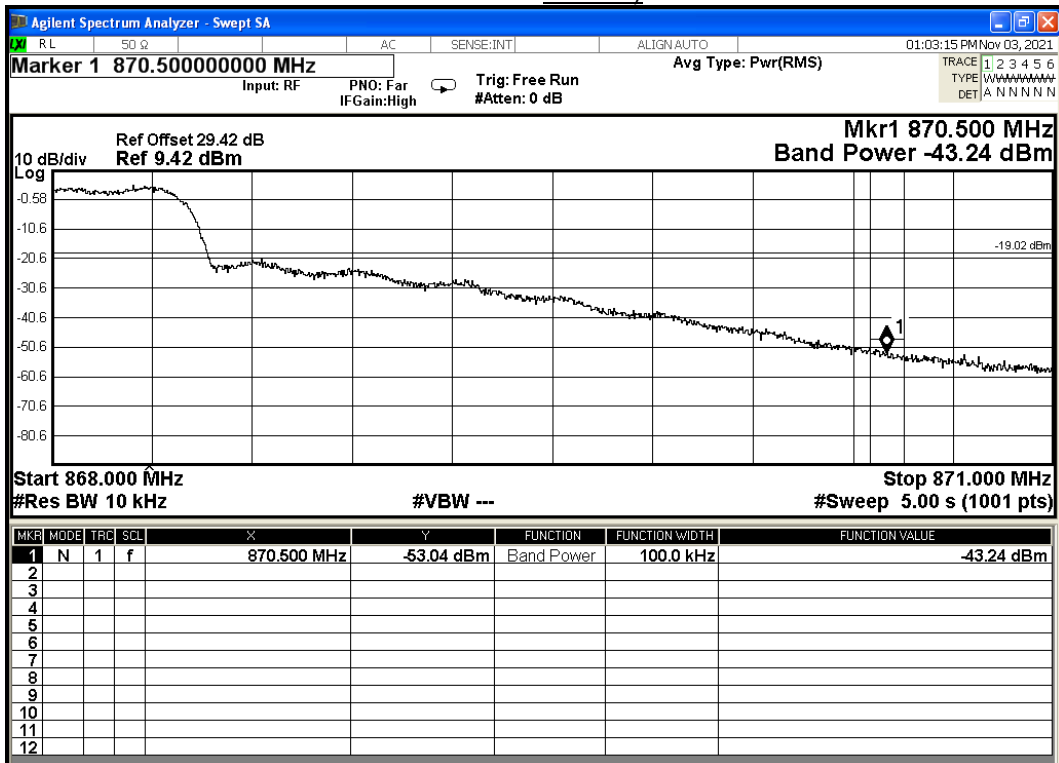



## 2.4 TRANSCEIVER SPURIOUS EMISSIONS

### 2.4.1 Specification Reference

FCC CFR 47 Part 2, Clause 2.1051  
FCC CFR 47 Part 90, Clause [§90.691\(a\)\(2\)](#)

### 2.4.2 Date of Test and Modification State

12 August 2021- Modification State 0

### 2.4.3 Test Equipment Used

The major items of test equipment used for the above tests are identified in Section 3.1.

### 2.4.4 Environmental Conditions

Ambient Temperature	25.1°C
Relative Humidity	16.4%

### 2.4.5 Test Method

All measurements were made in accordance with FCC KDB 971168 D01.

All measurements were made in accordance with FCC KDB 971168 D01 Clause 6. The EUT was connected to a Spectrum Analyser via an attenuator and switching box. Prior to testing, a Network Analyser was used to calibrate the path loss between the EUT and the Spectrum Analyser. The worst-case path loss in the measured ranges was entered as a reference level offset. Over the measured ranges, the RBW was set to 1MHz with a VBW of 3MHz. All measurement results are specified as average with an RMS detector being used in conjunction with a trace setting of Max Hold. Measurements were performed in configurations of the EUT as reported below.

Testing was performed on all four ports and the worst-case scenario complying with the limit of  $43+10 \times \log_{10}(P) + 10 \times \log_{10}(4) = -19$  dBm is presented.



## 2.4.6 Test Results

Range Frequency	Limit (dBm)	Result
9kHz to 1GHz	-19	Pass
1GHz to 5G	-19	Pass
5G to 26GHz	-19	Pass
26GHz to 40GHz	-19	Pass <Note 1>
Note 1. The device was scanned up to 40Ghz with no emission (peak values less than 6Bd from the limit)		

### 2.4.6.1.1 Worst Case – Port 1A

Modulation QPSK - Carrier Bandwidth 2.0 MHz – Range 9kHz to 500MHz: 862.25 MHz

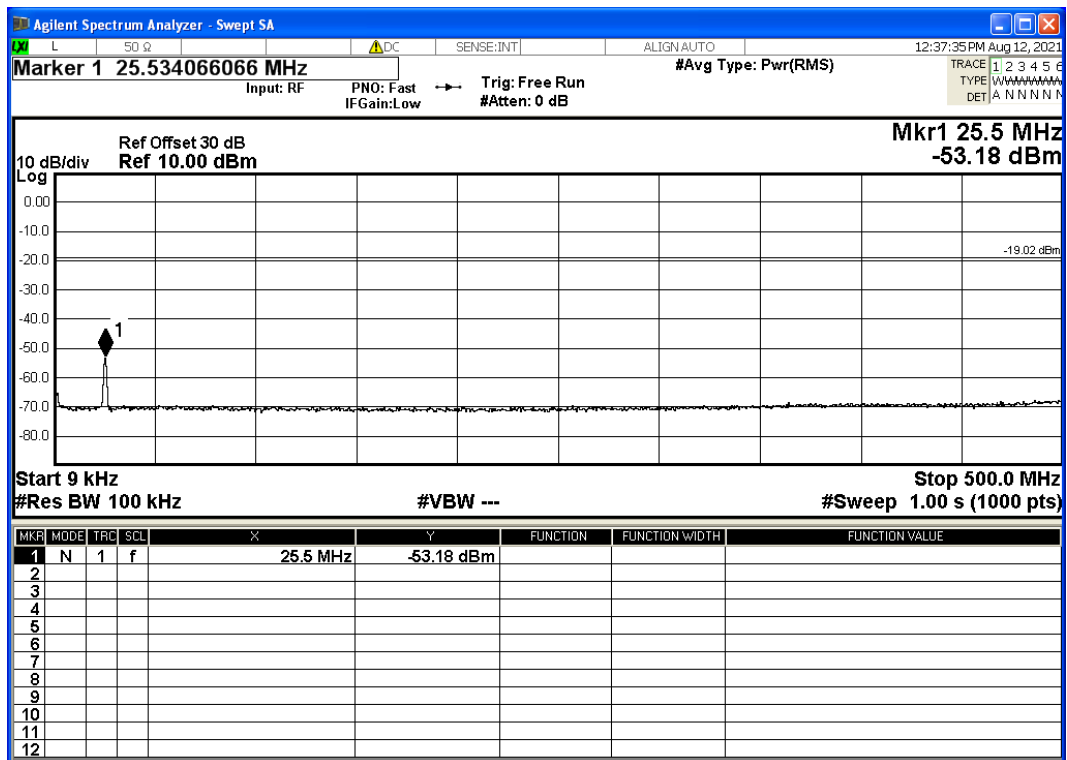



Modulation QPSK - Carrier Bandwidth 2.0 MHz – Range 500MHz to 1GHz: 860.76 MHz

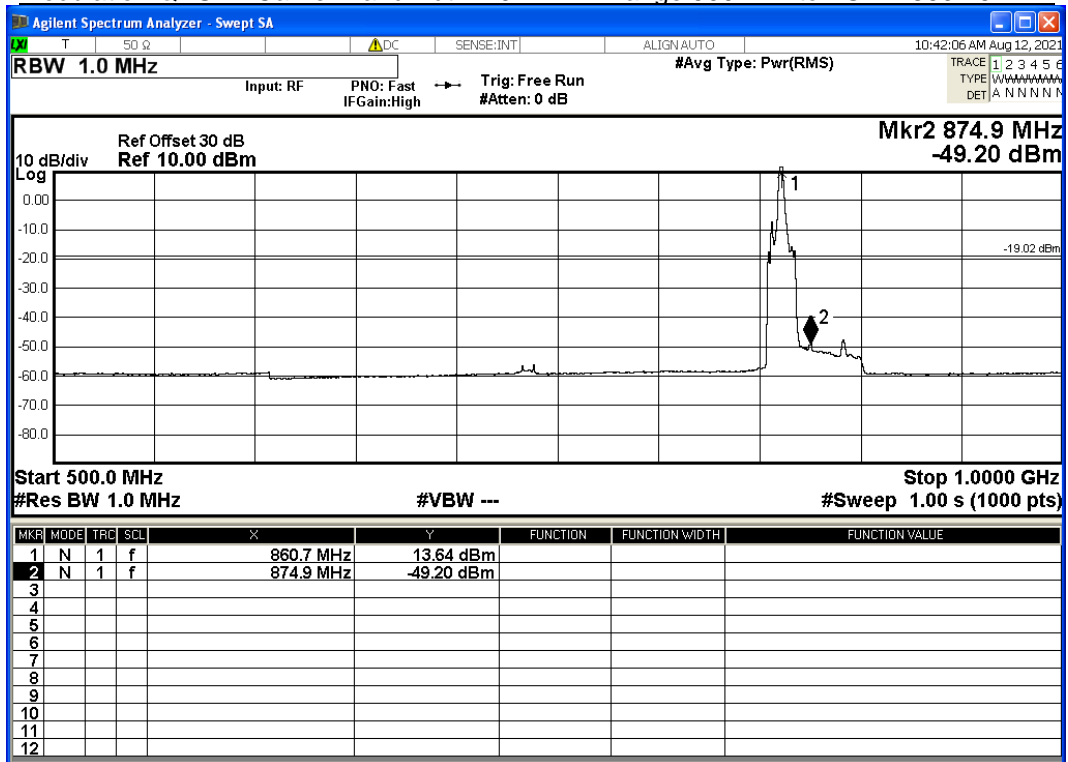

Modulation QPSK - Carrier Bandwidth 2.0 MHz – Range 500MHz to 1GHz: 862.25 MHz

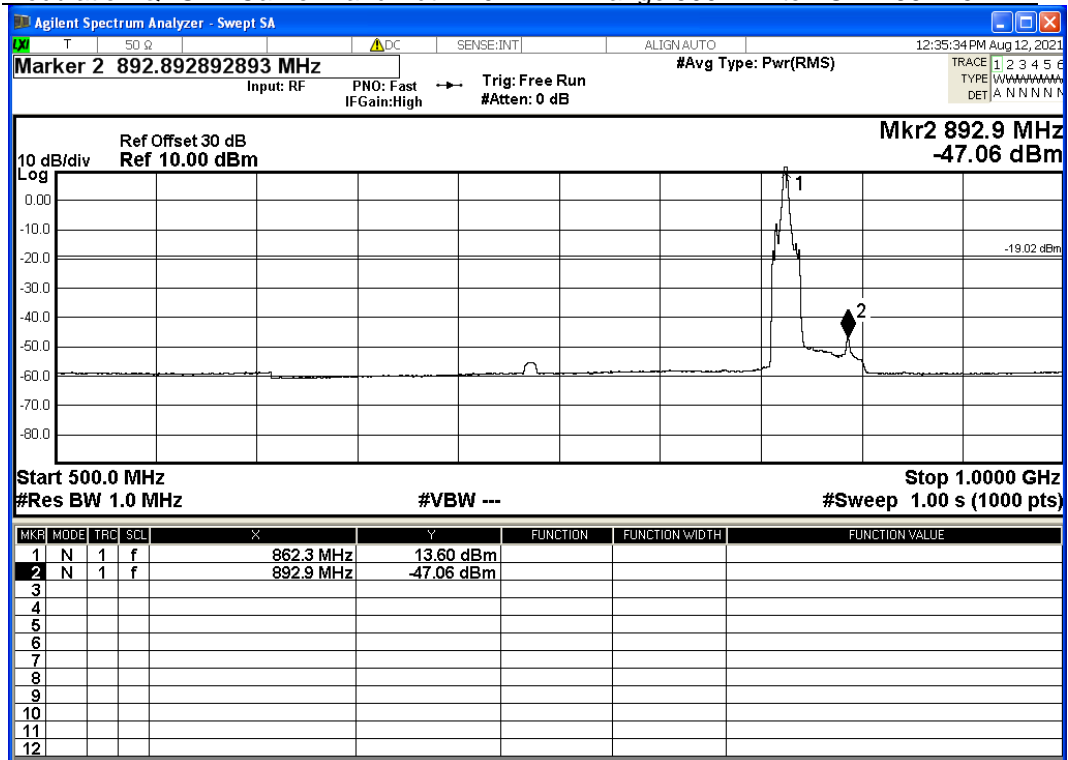





Modulation QPSK - Carrier Bandwidth 2.0 MHz – Range 500MHz to 1GHz: 867.75 MHz

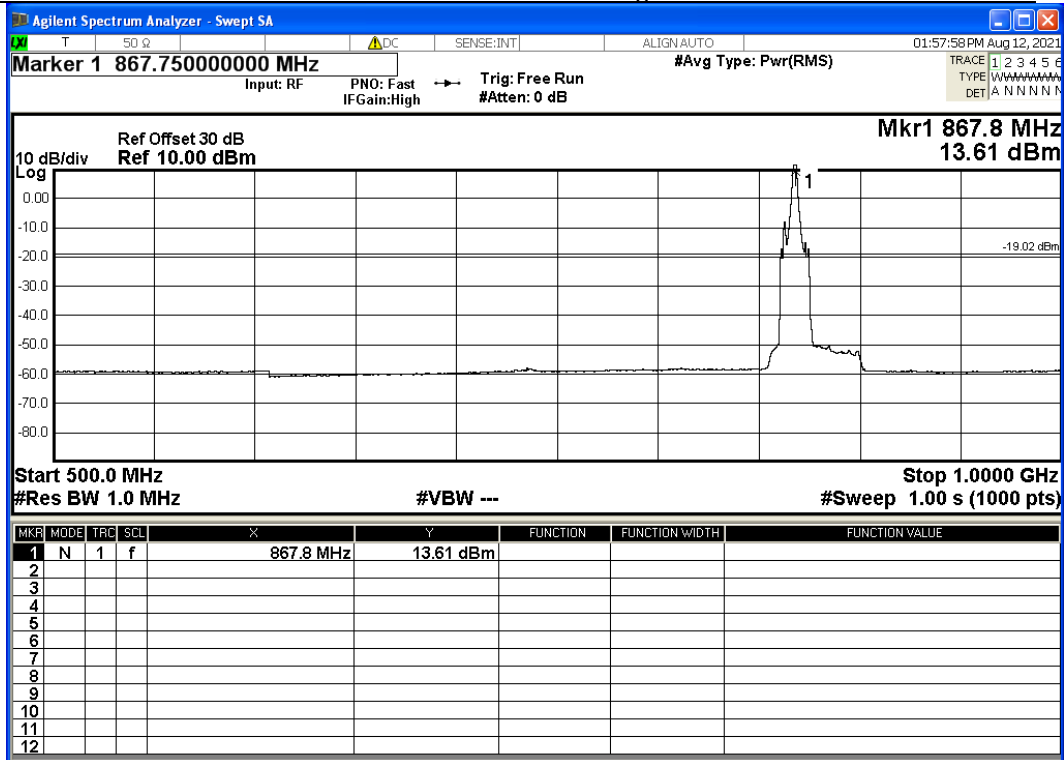

Modulation QPSK - Carrier Bandwidth 2.0 MHz – Range 1GHz to 26GHz

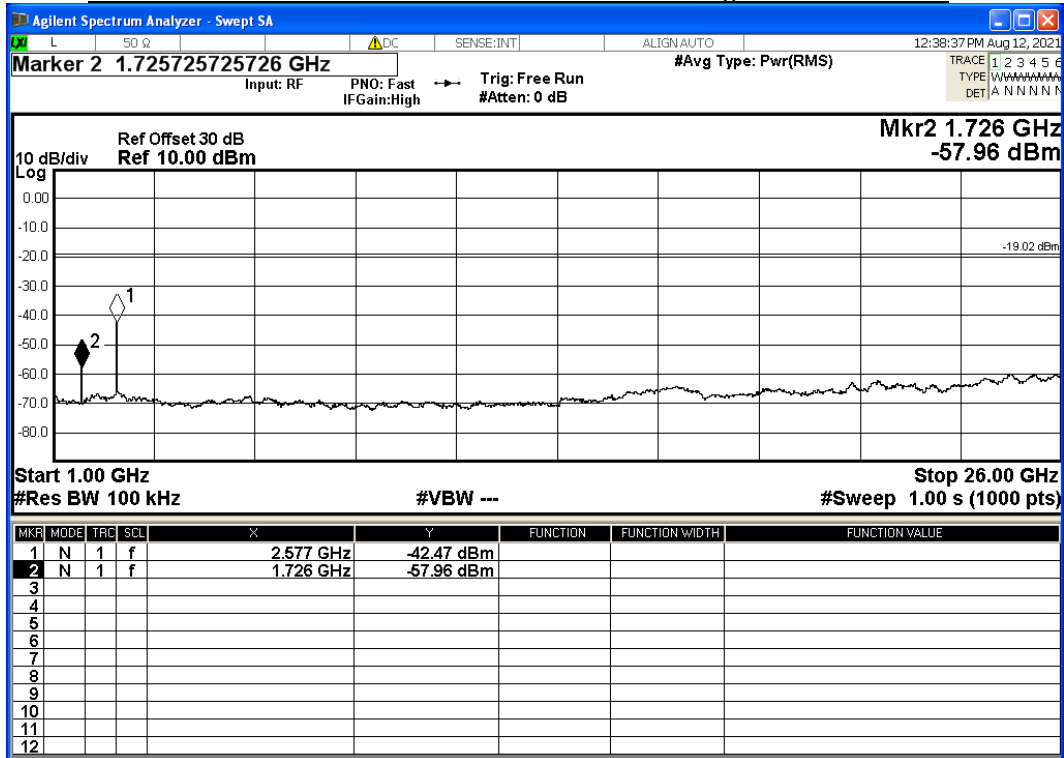



## 2.5 FREQUENCY STABILITY

### 2.5.1 Specification Reference

FCC CFR 47 Part 2, Clause 2.1055  
 FCC CFR 47 Part 27, [Clause 22.355](#)  
 FCC CFR 47 Part 90, [Clause 90.210 \(b\)\(3\)](#)

### 2.5.2 Date of Test and Modification State

22 June 2021 - Modification State 0

### 2.5.3 Test Equipment Used

The major items of test equipment used for the above tests are identified in Section 3.1.

### 2.5.4 Environmental Conditions

Ambient Temperature 26.7°C  
 Relative Humidity 32.2%

### 2.5.5 Test Method

All measurements were made in accordance with FCC KDB 971168 D01.

### 2.5.6 Test Results

Maximum Target Output Power 30dBm

#### 2.5.6.1.1 Worst Case – Port 1A

Temperature	Voltage (AC)	Frequency Error (Hz)	Limit ppm <Note 2>	Error/Freq ppm	Result
-30°C	115	Note 1	±1.5	N/A	<Note 1>
-20°C	115	87.24	±1.5	0.10	Pass
-10°C	115	34.21	±1.5	0.04	Pass
0°C	115	31.0	±1.5	0.03	Pass
+10°C	115	20.50	±1.5	0.02	Pass
+20°C	115	22.7	±1.5	0.03	Pass
+20°C	90	21.22	±1.5	0.02	Pass
+20°C	132	13.17	±1.5	0.01	Pass
+30°C	115	16.34	±1.5	0.02	Pass
+40°C	115	18.30	±1.5	0.02	Pass
+55°C	115	4.62	±1.5	0.005	Pass

Note 1. EUT stop the operation and no transmission was recorded: Pass  
 The frequency stability shall be sufficient to ensure that the fundamental emissions stay within the authorized bands of operation  
 Note 2. Frequency Range 821 to 896 of Table C-1 in [§22.355](#)



## 2.6 FIELD STRENGTH

### 2.6.1 Specification Reference

FCC CFR 47 Part 2.1053  
FCC CFR 47 Part 90, Clause [§ 22.983](#)

### 2.6.2 Date of Test and Modification State

June 22, 2021 – Modification State 0  
June 23, 2021 – Modification State 0  
July 5<sup>th</sup>, 2021 – Modification State 0

### 2.6.3 Test Equipment Used

The major items of test equipment used for the above tests are identified in Section 3.1.

### 2.6.4 Environmental Conditions

Ambient Temperature	23.1°C
Relative Humidity	13.4%

### 2.6.5 Test Method

All measurements were made in accordance with:

- 971168 D01 Power Meas License Digital Systems v03r01 Clause 5.6
- 971168 D01 Power Meas License Digital Systems v03r01 Clause 7

From Clause 5:6, the field strength of the EUT can be calculated by:

$$\text{EIRP} = P_{\text{meas}} + A_{\text{gain}} = 30 \text{ dBm} + 5\text{dBi} = 35\text{dBm} \text{ (or } 127.23 \text{ dB}\mu\text{V/m at } 3\text{m)}$$

Measurements were performed in configurations of the EUT as reported below. Testing was performed with RF on (Port TX1A) with a test limit of FCC 15 Subpart B Class B of 40 dB $\mu$ V/m, which is more restricted than -19 dBm or 76.23 dB $\mu$ V/m at 3m.



### 2.6.6 Test Results

A summary of the test result is depicted in the table below.

Range Frequency	Test Limit (dB $\mu$ V/m)	Limit <Note 1> dB $\mu$ V/m	Result
9kHz to 150kHz	40.0	76.23	Pass <Note 2>
150kHz to 30MHz	40.0	76.23	Pass
30MHz to 1GHz	33.06	76.23	Pass
1GHz to 10GHz	53.96	76.23	Pass
10GHz to 18GHz	53.96	76.23	Pass
18GHz to 40GHz	53.96	76.23	Pass <Note 3>
Note 1. As per CFR 47 27.55(a)(1) Note 2. No significant emission (> 20dB margin below the limit) was recorded according to FCC 15 Subpart B. Note 3. The device was scanned up to 40Ghz with no emission (peak values less than 6Bd from the limit)			



**Spurious Radiation**  
**Spurious Radiation Emission – 150kHz to 30MHz**

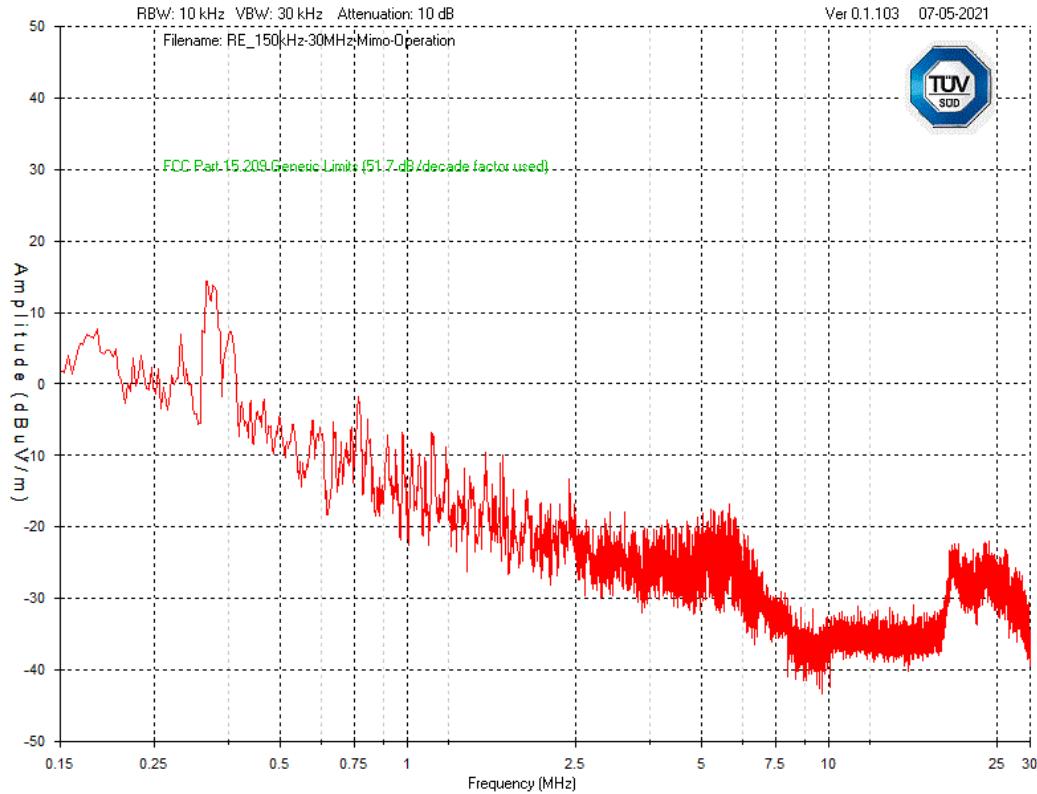

Note 1. The spurious emissions comply with the limit of 76.23 dB $\mu$ V/m at 3m.

Frequency (MHz)	Detector	Raw Reading	Cable 27 - 10m LMR4 00 Factor	Loop - EM687 2 100k to 30M Factor	Pream p-LNA14 50 Factor	Level	FCC Part 15.209 Generic Limits (51.7 dB/decade factor used) Limit	FCC Part 15.209 Generic Limits (51.7 dB/decade factor used) Margin
0.7642	PEAK	31.4	0	-2.3	-31	-1.9	93.3	95.2
1.6872	PEAK	28.5	0.1	-7.4	-31.1	-9.9	86.4	96.3
1.1427	PEAK	28.7	0.1	-4.5	-31	-6.7	89.8	96.5
1.5378	PEAK	28	0.1	-6.6	-31	-9.5	87.2	96.7



## Spurious Radiation Emission –30MHz to 1GHz

"TÜV SÜD, by release of this raw data, does not imply that the tested product has demonstrated compliance to any standard. The raw data provided may not be complete and may require additional processing. If raw data provided includes engineering data, testing may not have been done according to a standard test method. "

Emi CC test:RE_30-1000 MHz 10m - FCC- Class B Number:122 Execution date: 6/22/2021 1:42:24 PM	
Limit	FCC Part 15 Subpart B
Class	Class : B
Test Plan Number	7169009211
Configuration Information	Mode: Operating: Band:891.5MHz (30dBm)
Results	Pass
Model	CBRSYS4450
Tested by	KP and SM
Comments	Port activated: TX1A

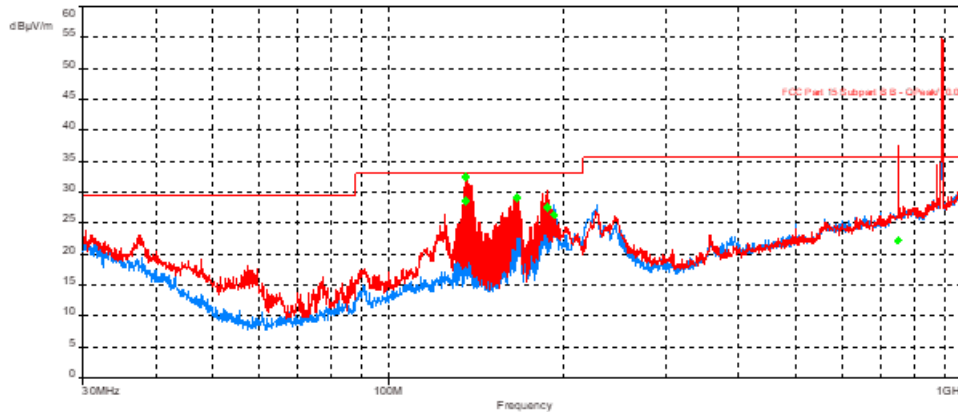

Red=Vertical, Blue=Horizontal

## Finals

Quasi-Peak Detector (6)

Frequency (MHz)	S R	Level (dBµV/m)	Limit (dBµV/m)	Margin (dB)	Height (m) (dB)	Azimuth (°) (dB)	Polarization (dB)	Correction (dB)
135.8700672	1	32.42	33.06	-0.64	1.00	117.75	Vertical	-9.37
166.2925738	1	29.15	33.06	-3.91	1.11	175.25	Vertical	-10.68
187.5651795	1	27.54	33.06	-5.52	1.06	119.75	Vertical	-11.92
749.9822821	1	22.16	35.56	-13.40	1.84	220.75	Vertical	3.69
135.8608141	2	28.49	33.06	-4.57	4.00	112.75	Horizontal	-9.37
192.6622692	2	26.30	33.06	-6.76	3.40	127.25	Horizontal	-11.80

Note 1. The spurious emissions comply with the limit of 76.23 dBµV/m at 3m.

Note 2. Operating at 867.75MHz, thus emission excluded from FCC limit.



## Spurious Radiation Emission –1GHz to 10GHz

"TÜV SÜD, by release of this raw data, does not imply that the tested product has demonstrated compliance to any standard. The raw data provided may not be complete and may require additional processing. If raw data provided includes engineering data, testing may not have been done according to a standard test method. "

Emi CC test:RE_1-10 GHz 3m - MIMO- FCC Class B Number:129 Execution date: 6/22/2021 3:15:43 PM	
Limit	FCC Part 15 Subpart B
Class	Class: B
Test Plan Number	7169009211
Configuration Information	Mode: Operating
Results	Pass
Model	CBRSYS4450
Tested by	KP and SM
Comments	Port activated: TX1A

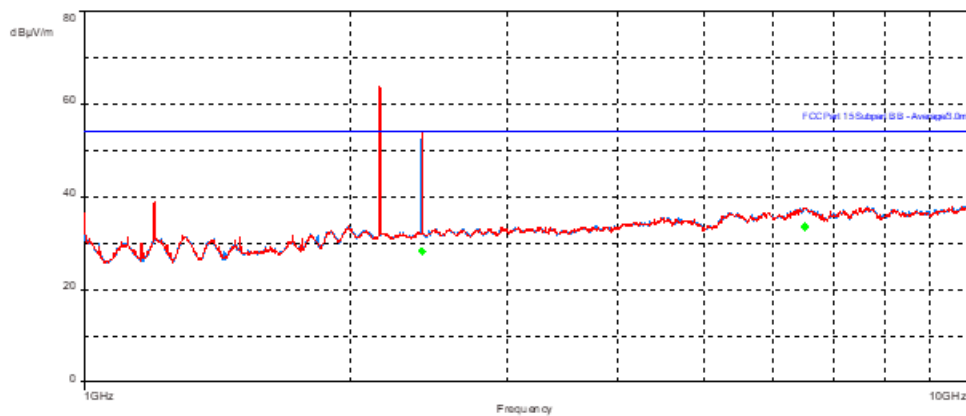

Red=Vertical, Blue=Horizontal

### Finals

AVG (4)								
Frequency (MHz)	SR	Level (dBµV/m)	Limit (dBµV/m)	Margin (dB)	Height (m) (dB)	Azimuth (°) (dB)	Polarization (dB)	Correction (dB)
2405.726603	1	28.27	53.96	-25.69	3.69	9.50	Vertical	-5.79
6492.401603	1	33.47	53.96	-20.49	2.08	343.00	Vertical	1.37
2403.416346	2	28.38	53.96	-25.58	1.00	356.75	Horizontal	-5.81
6513.693269	2	33.56	53.96	-20.40	2.42	2.25	Horizontal	1.35

Note 1. The spurious emissions comply with the limit of 76.23 dBµV/m at 3m.

Note 2. 2.4GHz peak correspond to the computer WIFI communication.



Spurious Radiation Emission –10GHz to 18GHz

"TÜV SÜD, by release of this raw data, does not imply that the tested product has demonstrated compliance to any standard. The raw data provided may not be complete and may require additional processing. If raw data provided includes engineering data, testing may not have been done according to a standard test method. "

Emi CC test:RE_10-18 GHz 3m - MIMO - FCC Class B Number:135 Execution date: 6/23/2021 8:42:04 AM	
Limit	FCC Part 15 Subpart B
Class	Class: B
Test Plan Number	7169009211
Configuration Information	Operation: Band:891.5MHz (30dBm)
Results	Pass
Model	CBRSYS4450
Tested by	KP and SM
Comments	Port activated: TX1A



Red=Vertical, Blue=Horizontal

## Finals

AVG Detector (4)

Frequency (MHz)	S R	Level (dBµV/m)	Limit (dBµV/m)	Margin (dB)	Height (m) (dB)	Azimuth (°) (dB)	Polarization (dB)	Correction (dB)
16750.52277	2	41.61	53.96	-12.35	1.00	10.50	Horizontal	14.25
16753.59519	1	41.97	53.96	-11.99	4.00	271.50	Vertical	14.29
17898.35513	2	41.39	53.96	-12.57	3.86	16.75	Horizontal	14.87
17916.38559	1	41.10	53.96	-12.86	1.00	0.00	Vertical	14.82

Note 1. The spurious emissions comply with the limit of 76.23 dBµV/m at 3m.





## SECTION 3: TEST EQUIPMENT USED



### 3.1 TEST EQUIPMENT USED

List of absolute measurements and other principal items of test equipment.

Instrument	Manufacturer	Type No.	Serial No.	Calibration Period (months)	Calibration Due
Bilog Antenna	TESEQ	CBL 6111D	SSG013965	2021-05-04	2022-05-04
Horn Antenna 3MCH 00003	ETS	3117	LAVE04211	2021-03-30	2022-03-30
EMI Receiver	Rohde & Schwarz	ESU26	SSG013729	2021-03-31	2022-03-31
EMI Receiver	Rohde & Schwarz	ESU40	SSG013672	2020-10-29	2021-10-29
Coaxial Cable	Huber & Suhner	106A	SSG012455	2021-01-05	2022-01-05
Coaxial Cable	Huber & Suhner	106A	SSG012711	2021-01-05	2022-01-05
Coaxial Cable	Huber & Suhner	104PEA	SSG012041	2021-01-05	2022-01-05
Coaxial Cable	Huber & Suhner	ST18/Nm/Nm/36	SSG012785	2021-01-06	2022-01-06
Coaxial Cable	Micro-Coax	UFA 210B-1-1500-504504	SSG012376	2021-01-06	2022-01-06
Pre-Amplifier	Hp	8447D	LAVE04346	2020-09-10	2021-09-10
Pre-Amplifier	BNR	LNA	SSG012360	2020-11-16	2021-11-16
Power Supply	Hewlett Packard	6216A	SSG013063	not required	not required
N/A: No applicable O/P Mon – Output monitored with Calibrated Equipment					



### 3.2 MEASUREMENT UNCERTAINTY

For a 95% confidence level, the measurement uncertainties for defined systems are:

Test Discipline	Frequency / Parameter	MU
Conducted Maximum Peak Output Power	30 MHz to 20 GHz Amplitude	$\pm 0.1$ dB
Conducted Emissions	30 MHz to 20 GHz Amplitude	$\pm 2.3$ dB
Frequency Stability	30 MHz to 2 GHz	$\pm 5.0$ Hz
Occupied Bandwidth	Up to 20 MHz Bandwidth	$\pm 1.1$ Hz
Band Edge	30 MHz to 20 GHz Amplitude	$\pm 2.3$ dB



## **SECTION 5**

### **ACCREDITATION, DISCLAIMERS AND COPYRIGHT**



#### 4.1 ACCREDITATION, DISCLAIMERS AND COPYRIGHT



Testing Laboratory  
Certificate #2955.19

This report relates only to the actual item/items tested.

This report does not imply product endorsement by any government, accreditation agency, or TÜV SÜD Canada Inc.

Opinions or interpretations expressed in this report, if any, are outside the scope of TÜV SÜD Canada Inc. accreditations. Any opinions expressed do not necessarily reflect the opinions of TÜV SÜD Canada Inc., unless otherwise stated.

This report relates only to the actual item/items tested.

© 2021 TÜV SÜD