

APPLICATION CERTIFICATION FCC Part 15C
On Behalf of
DALIS Lighting Inc.

LED bulb

Model No.: SM-BLBGU10

FCC ID: 2AQSN-SMBLBGU10

Prepared for : DALIS Lighting Inc.
Address : 80 boul. De La Seigneurie Est, Blainville, QC, J7C
4N1 Canada

Prepared by : Shenzhen Accurate Technology Co., Ltd.
Address : 1/F., Building A, Changyuan New Material Port,
Science & Industry Park, Nanshan District,
Shenzhen, Guangdong, P.R. China

Tel: (0755) 26503290
Fax: (0755) 26503396

Report No. : ATE20200065
Date of Test : Jan. 14, 2020--Mar. 03, 2020
Date of Report : March 04, 2020

TABLE OF CONTENTS

Description	Page
Test Report Certification	
1. GENERAL INFORMATION	5
1.1. Description of Device (EUT).....	5
1.2. Special Accessory and Auxiliary Equipment	5
1.3. Laboratory Accreditation and Relationship to Customer	6
1.4. Measurement Uncertainty	6
2. MEASURING DEVICE AND TEST EQUIPMENT	7
2.1. For Radiated Emission Measurement	7
2.2. The Equipment Used to Measure Conducted Disturbance (L.I.S.N).....	8
3. OPERATION OF EUT DURING TESTING	9
3.1. Operating Mode	9
3.2. Carrier Frequency of Channels	9
3.3. Configuration and peripherals	10
3.4. Test mode.....	10
4. TEST PROCEDURES AND RESULTS	11
5. 6DB OCCUPIED BANDWIDTH TEST	12
5.1. Block Diagram of Test Setup.....	12
5.2. The Requirement For Section 15.247(a)(1).....	12
5.3. EUT Configuration on Measurement	12
5.4. Operating Condition of EUT	12
5.5. Test Procedure	12
5.6. Test Result	13
6. 99% OCCUPIED BANDWIDTH	20
6.1. Block Diagram of Test Setup.....	20
6.2. EUT Configuration on Measurement	20
6.3. Operating Condition of EUT	20
6.4. Test Procedure	20
6.5. Measurement Result	21
7. DUTY CYCLE MEASUREMENT.....	28
7.1. Block Diagram of Test Setup.....	28
7.2. EUT Configuration on Measurement	28
7.3. Operating Condition of EUT	28
7.4. Test Procedure	28
7.5. Test Result	29
8. POWER SPECTRAL DENSITY TEST.....	32
8.1. Block Diagram of Test Setup.....	32
8.2. The Requirement For Section 15.247(e).....	32
8.3. EUT Configuration on Measurement	32
8.4. Operating Condition of EUT	32
8.5. Test Procedure	32
8.6. Test Result	33
9. MAXIMUM CONDUCTED (AVERAGE) OUTPUT POWER	40
9.1. Block Diagram of Test Setup.....	40
9.2. The Requirement For Section 15.247(b)(3).....	40
9.3. EUT Configuration on Measurement	40

9.4.	Operating Condition of EUT	40
9.5.	Test Procedure	40
9.6.	Test Result	41
10.	RADIATED SPURIOUS EMISSION TEST	48
10.1.	Block Diagram of Test Setup.....	48
10.2.	The Limit For Section 15.247(d)	50
10.3.	Restricted bands of operation	50
10.4.	Configuration of EUT on Measurement	51
10.5.	Operating Condition of EUT	51
10.6.	Test Procedure	51
10.7.	The Field Strength of Radiation Emission Measurement Results	52
11.	BAND EDGE COMPLIANCE TEST	65
11.1.	Block Diagram of Test Setup.....	65
11.2.	The Requirement For Section 15.247(d)	65
11.3.	EUT Configuration on Measurement	65
11.4.	Operating Condition of EUT	65
11.5.	Test Procedure	65
11.6.	Test Result	66
12.	POWER LINE CONDUCTED MEASUREMENT	76
12.1.	Block Diagram of Test Setup.....	76
12.2.	Power Line Conducted Emission Measurement Limits.....	76
12.3.	Configuration of EUT on Measurement	76
12.4.	Operating Condition of EUT	76
12.5.	Test Procedure	77
12.6.	DATA SAMPLE	77
12.7.	Power Line Conducted Emission Measurement Results	78
13.	ANTENNA REQUIREMENT.....	81
13.1.	The Requirement	81
13.2.	Antenna Construction	81

Test Report Certification

Applicant : DALS Lighting Inc.
Address : 80 boul. De La Seigneurie Est, Blainville, QC, J7C 4N1
Canada.
Manufacturer : Hengdian Group Tospo Lighting Co., Ltd.
Address : Hengdian Electronics Industrial Zone, Dongyang, Zhejiang
P.R. China.
Product : LED bulb
Model No. : SM-BLBGU10
Trade name : DALS

Measurement Procedure Used:

FCC Rules and Regulations Part 15 Subpart C Section 15.247
ANSI C63.10: 2013

The EUT was tested according to DTS test procedure of April 02, 2019 KDB558074 D01 DTS Meas Guidance v0502 for compliance to FCC 47CFR 15.247 requirements.

The device described above is tested by SHENZHEN ACCURATE TECHNOLOGY CO., LTD. to determine the maximum emission levels emanating from the device. The maximum emission levels are compared to the FCC Part 15 Subpart C Section 15.247 limits. The measurement results are contained in this test report and SHENZHEN ACCURATE TECHNOLOGY CO., LTD. is assumed full responsibility for the accuracy and completeness of these measurements. Also, this report shows that the Equipment Under Test (EUT) is to be technically compliant with the FCC requirements.

This report applies to above tested sample only. This report shall not be reproduced in part without written approval of SHENZHEN ACCURATE TECHNOLOGY CO., LTD.

Date of Test : Jan. 14, 2020--Mar. 03, 2020

Date of Report : March 04, 2020

Prepared by : _____

(Tim Zhang, Engineer)

Approved & Authorized Signer : _____

(Sean Liu, Manager)

1. GENERAL INFORMATION

1.1. Description of Device (EUT)

EUT	:	LED bulb
Model Number	:	SM-BLBGU10
Frequency Range	:	802.11b/g/n(20MHz): 2412-2462MHz 802.11n(40MHz): 2422-2452MHz
Number of Channels	:	802.11b/g/n (20MHz):11 802.11n (40MHz):7
G _{ANT} MAX	:	1dBi
Type of Antenna	:	Integral Antenna
Power Supply	:	AC 120V/60Hz
Data Rate	:	802.11b: 11, 5.5, 2, 1 Mbps 802.11g: 54, 48, 36, 24, 18, 12, 9, 6 Mbps 802.11n: up to 150Mbps
Modulation Type	:	DSSS, OFDM
Applicant	:	DALS Lighting Inc.
Address	:	80 boul. De La Seigneurie Est, Blainville, QC, J7C 4N1 Canada.
Manufacturer	:	Hengdian Group Tospo Lighting Co., Ltd.
Address	:	Hengdian Electronics Industrial Zone, Dongyang, Zhejiang P.R. China.
Date of sample received	:	Jan. 14, 2020
Date of Test	:	Jan. 14, 2020--Mar. 03, 2020

1.2. Special Accessory and Auxiliary Equipment

PC	Manufacturer: LENOVO
	M/N: 4290-RT8
	S/N: R9-FW93G 11/08

1.3.Laboratory Accreditation and Relationship to Customer

EMC Lab : Recognition of accreditation by Federal Communications Commission (FCC)
The Designation Number is CN1189
The Registration Number is 708358

Listed by Innovation, Science and Economic Development Canada (ISED)
The Registration Number is 5077A-2

Accredited by China National Accreditation Service for Conformity Assessment (CNAS)
The Registration Number is CNAS L3193

Accredited by American Association for Laboratory Accreditation (A2LA)
The Certificate Number is 4297.01

Name of Firm : Shenzhen Accurate Technology Co., Ltd.
Site Location : 1/F., Building A, Changyuan New Material Port, Science & Industry Park, Nanshan District, Shenzhen, Guangdong, P.R. China

1.4.Measurement Uncertainty

Conducted Emission Expanded Uncertainty = 2.72dB, k=2
(Mains ports, 9kHz-30MHz)

Radiated emission expanded uncertainty = 2.66dB, k=2
(9kHz-30MHz)

Radiated emission expanded uncertainty = 4.28dB, k=2
(30MHz-1000MHz)

Radiated emission expanded uncertainty = 4.98dB, k=2
(1G-18GHz)

Radiated emission expanded uncertainty = 5.06dB, k=2
(18G-26.5GHz)

2. MEASURING DEVICE AND TEST EQUIPMENT

2.1.For Radiated Emission Measurement

Item	Equipment	Manufacturer	Model No.	Serial No.	Last Cal.	Cal. Interval
1.	Spectrum Analyzer	Agilent	E7405A	MY45115511	Jan.04, 2020	1 Year
2.	Spectrum Analyzer	Rohde&Schwarz	FSV40	101495	Jan.04, 2020	1 Year
3.	Test Receiver	Rohde&Schwarz	ESCS30	100307	Jan.04, 2020	1 Year
4.	Test Receiver	Rohde& Schwarz	ESPI	100396/003	Jan.04, 2020	1 Year
5.	Test Receiver	Rohde& Schwarz	ESPI	101526/003	Jan.04, 2020	1 Year
6.	Test Receiver	Rohde& Schwarz	ESR	101817	Jan.04, 2020	1 Year
7.	Bilog Antenna	Schwarzbeck	VULB9163	9163-194	Jan.04, 2020	1 Year
8.	Bilog Antenna	Schwarzbeck	VULB9163	9163-323	Jan.04, 2020	1 Year
9.	Log.-Per.Antenna	Schwarzbeck	VUSLP 9111B	9111B-074	Jan.04, 2020	1 Year
10.	Biconical Broad Band Antenna	Schwarzbeck	VHBB 9124+BBA 9106	9124-617	Jan.04, 2020	1 Year
11.	Loop Antenna	Schwarzbeck	FMZB1516	1516131	Jan.04, 2020	1 Year
12.	Horn Antenna	Schwarzbeck	BBHA9120D	9120D-655	Jan.04, 2020	1 Year
13.	Horn Antenna	Schwarzbeck	BBHA9120D	9120D-1067	Jan.04, 2020	1 Year
14.	Vertical Active Monopole Antenna	Schwarzbeck	VAMP 9243	9243-370	Jan.04, 2020	1 Year
15.	RF Switching Unit+PreAMP	Compliance Direction	RSU-M2	38322	Jan.04, 2020	1 Year
16.	Pre-Amplifier	Agilent	8447D	294A10619	Jan.04, 2020	1 Year
17.	Pre-Amplifier	Rohde&Schwarz	CBLU11835 40-01	3791	Jan.04, 2020	1 Year
18.	50 Coaxial Switch	Anritsu Corp	MP59B	6200237248	Jan.04, 2020	1 Year
19.	50 Coaxial Switch	Anritsu Corp	MP59B	6200506474	Jan.04, 2020	1 Year
20.	RF Coaxial Cable	Schwarzbeck	N-5m	No.1	Jan.04, 2020	1 Year
21.	RF Coaxial Cable	Schwarzbeck	N-1m	No.6	Jan.04, 2020	1 Year
22.	RF Coaxial Cable	Schwarzbeck	N-1m	No.7	Jan.04, 2020	1 Year
23.	RF Coaxial Cable	SUHNER	N-3m	No.8	Jan.04, 2020	1 Year
24.	RF Coaxial Cable	RESENBERGER	N-3.5m	No.9	Jan.04, 2020	1 Year
25.	RF Coaxial Cable	SUHNER	N-6m	No.10	Jan.04, 2020	1 Year
26.	RF Coaxial Cable	RESENBERGER	N-12m	No.11	Jan.04, 2020	1 Year
27.	RF Coaxial Cable	RESENBERGER	N-0.5m	No.12	Jan.04, 2020	1 Year
28.	RF Coaxial Cable	SUHNER	N-2m	No.13	Jan.04, 2020	1 Year
29.	RF Coaxial Cable	SUHNER	N-0.5m	No.15	Jan.04, 2020	1 Year
30.	RF Coaxial Cable	SUHNER	N-2m	No.16	Jan.04, 2020	1 Year
31.	RF Coaxial Cable	RESENBERGER	N-6m	No.17	Jan.04, 2020	1 Year
Radiated Emission Measurement Software: EZ EMC V1.1.4.2						

2.2.The Equipment Used to Measure Conducted Disturbance (L.I.S.N)

Item	Equipment	Manufacturer	Model No.	Serial No.	Last Cal.	Cal. Interval
1.	Test Receiver	Rohde & Schwarz	ESCS30	100307	Jan.04, 2020	1 Year
2.	Test Receiver	Rohde & Schwarz	ESPI3	100396/003	Jan.04, 2020	1 Year
3.	Test Receiver	Rohde & Schwarz	ESPI3	101526/003	Jan.04, 2020	1 Year
4.	L.I.S.N.	Schwarzbeck	NLSK8126	8126431	Jan.04, 2020	1 Year
5.	L.I.S.N.	Rohde & Schwarz	ESH3-Z5	100305	Jan.04, 2020	1 Year
6.	L.I.S.N.	Rohde & Schwarz	ESH3-Z5	100310	Jan.04, 2020	1 Year
7.	L.I.S.N.	Rohde & Schwarz	ESH3-Z6	100132	Jan.04, 2020	1 Year
8.	Pulse Limiter	Rohde & Schwarz	ESH3-Z2	100305	Jan.04, 2020	1 Year
9.	Pulse Limiter	Rohde & Schwarz	ESH3-Z2	100312	Jan.04, 2020	1 Year
10.	Pulse Limiter	Rohde & Schwarz	ESH3-Z2	100815	Jan.04, 2020	1 Year
11.	50Ω Coaxial Switch	Anritsu Corp	MP59B	6200283936	Jan.04, 2020	1 Year
12.	50Ω Coaxial Switch	Anritsu Corp	MP59B	6200283933	Jan.04, 2020	1 Year
13.	50Ω Coaxial Switch	Anritsu Corp	MP59B	6200506474	Jan.04, 2020	1 Year
14.	VOLTAGE PROBE	Schwarzbeck	TK9416	N/A	Jan.04, 2020	1 Year
15.	RF CURRENT PROBE	Rohde & Schwarz	EZ-17	100048	Jan.04, 2020	1 Year
16.	8-Wire Impedance Stabilisation Network	Schwarzbeck	CAT5 8158	8158-0035	Jan.04, 2020	1 Year
17.	RF Coaxial Cable	SUHNER	N-2m	No.2	Jan.04, 2020	1 Year
18.	RF Coaxial Cable	SUHNER	N-2m	No.3	Jan.04, 2020	1 Year
19.	RF Coaxial Cable	SUHNER	N-2m	No.14	Jan.04, 2020	1 Year
Conducted Emission Measurement Software: ES-K1 V1.71						

3. OPERATION OF EUT DURING TESTING

3.1.Operating Mode

The mode is used: **1.802.11b Transmitting mode**

Low Channel: 2412MHz

Middle Channel: 2437MHz

High Channel: 2462MHz

2.802.11g Transmitting mode

Low Channel: 2412MHz

Middle Channel: 2437MHz

High Channel: 2462MHz

3.802.11n (20MHz) Transmitting mode

Low Channel: 2412MHz

Middle Channel: 2437MHz

High Channel: 2462MHz

4.802.11n (40MHz) Transmitting mode

Low Channel: 2422MHz

Middle Channel: 2437MHz

High Channel: 2452MHz

3.2.Carrier Frequency of Channels

802.11b, 802.11g, 802.11n (20MHz)

Channel	Frequency(MHz)	Channel	Frequency(MHz)
01	2412	07	2442
02	2417	08	2447
03	2422	09	2452
04	2427	10	2457
05	2432	11	2462
06	2437	---	---

802.11n (40MHz)

Channel	Frequency(MHz)	Channel	Frequency(MHz)
---	---	07	2442
---	---	08	2447
03	2422	09	2452
04	2427	---	---
05	2432	---	---
06	2437	---	---

3.3. Configuration and peripherals

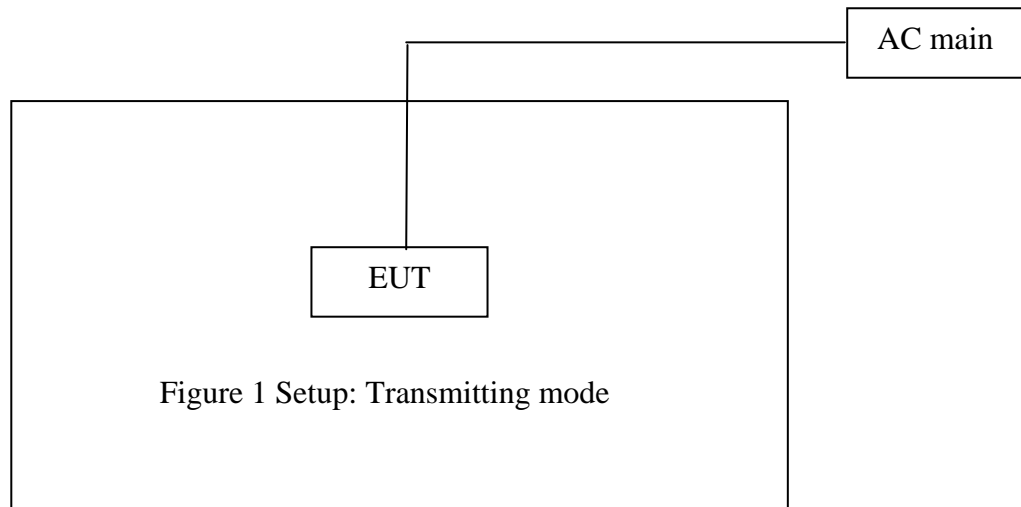

3.4. Test mode

Test Mode	Test Modes Description
11B	IEEE 802.11b with data rate of 1 Mbps
11G	IEEE 802.11g with data rate of 6 Mbps
11N20MHz	IEEE 802.11n with data date of MCS0 and bandwidth of 20 MHz
11N40MHz	IEEE 802.11n with data date of MCS0 and bandwidth of 40 MHz

NOTE: Worst cases for each IEEE 802.11 mode are selected to perform tests.

4. TEST PROCEDURES AND RESULTS

FCC Rules	Description of Test	Result
Section 15.207	AC power Line Conducted Emission Test	Compliant
Section 15.247(a)(2)	6dB Occupied Bandwidth Test	Compliant
KDB558074 D01 DTS Meas Guidance v0502	Duty cycle	Compliant
KDB558074 D01 DTS Meas Guidance v0502	OBW	Compliant
Section 15.247(b)(3)	Maximum conducted (average) output power	Compliant
Section 15.247(e)	Power Spectral Density Test	Compliant
Section 15.205 Section 15.209	Radiated Spurious Emissions Test	Compliant
Section 15.247(d)	Band Edge Compliance Test	Compliant
Section 15.203	Antenna Requirement	Compliant

5. 6DB OCCUPIED BANDWIDTH TEST

5.1. Block Diagram of Test Setup

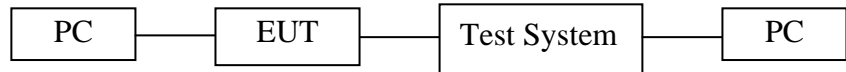

5.2. The Requirement For Section 15.247(a)(1)

Section 15.247(a)(2): Systems using digital modulation techniques may operate in the 902–928 MHz, 2400–2483.5 MHz, and 5725–5850 MHz bands. The minimum 6 dB band-width shall be at least 500 kHz

5.3. EUT Configuration on Measurement

The equipment are installed on the emission measurement to meet the commission requirements and operating regulations in a manner which tends to maximize its emission characteristics in normal application.

5.4. Operating Condition of EUT

5.4.1. Setup the EUT and simulator as shown as Section 5.1.

5.4.2. Turn on the power of all equipment.

5.4.3. Let the EUT work in TX modes measure it. The transmit frequency range are 2412-2462MHz and 2422-2452MHz . We select three frequencies of high, medium and low channel in each frequency band for testing.

5.5. Test Procedure

5.5.1. The transmitter output was connected to the spectrum analyzer through a low loss cable.

5.5.2. Set RBW of spectrum analyzer to 100 kHz and VBW to 300 kHz.

5.5.3. The 6dB bandwidth is defined as the total spectrum the power of which is higher than peak power minus 6dB.

5.6. Test Result

The test was performed with 802.11b			
Channel	Frequency (MHz)	6dB Bandwidth (MHz)	Limit (MHz)
Low	2412	10.08	> 0.5MHz
Middle	2437	10.08	> 0.5MHz
High	2462	10.00	> 0.5MHz

The test was performed with 802.11g			
Channel	Frequency (MHz)	6dB Bandwidth (MHz)	Limit (MHz)
Low	2412	16.48	> 0.5MHz
Middle	2437	16.32	> 0.5MHz
High	2462	16.48	> 0.5MHz

The test was performed with 802.11n (Bandwidth: 20 MHz)			
Channel	Frequency (MHz)	6dB Bandwidth (MHz)	Limit (MHz)
Low	2412	17.76	> 0.5MHz
Middle	2437	17.76	> 0.5MHz
High	2462	17.76	> 0.5MHz

The test was performed with 802.11n (Bandwidth: 40 MHz)			
Channel	Frequency (MHz)	6dB Bandwidth (MHz)	Limit (MHz)
Low	2422	35.52	> 0.5MHz
Middle	2437	35.52	> 0.5MHz
High	2452	35.68	> 0.5MHz

The spectrum analyzer plots are attached as below.

6dB Bandwidth 802.11b Channel Low 2412MHz

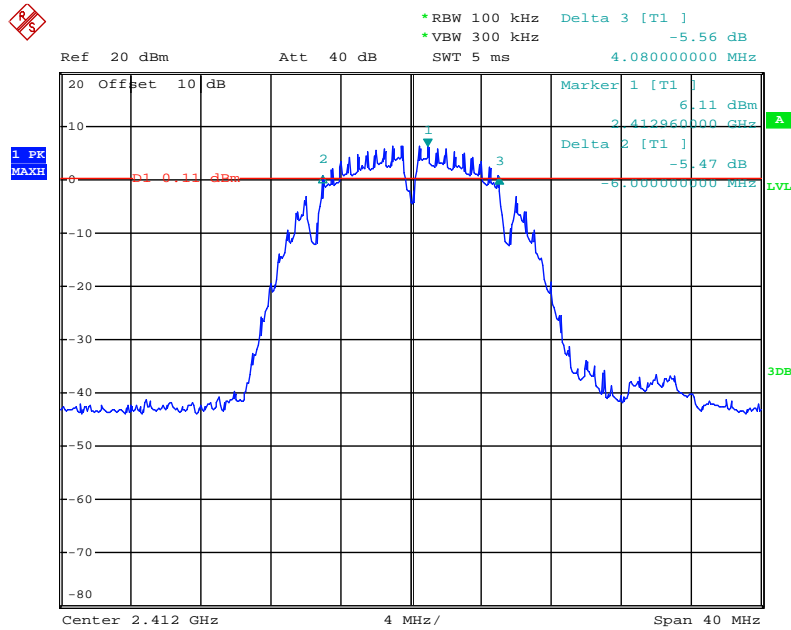

Date: 18.FEB.2020 07:51:06

802.11b Channel Middle 2437MHz

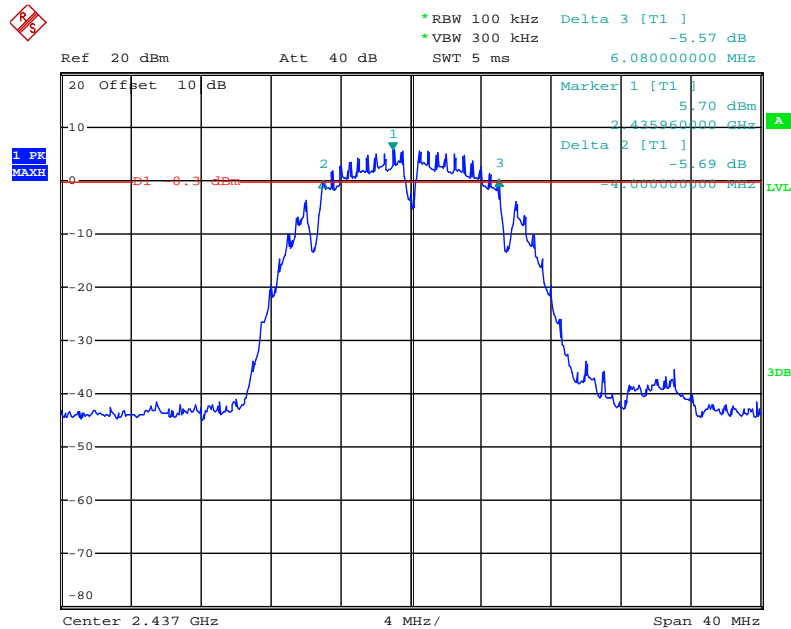

Date: 18.FEB.2020 07:53:27

802.11b Channel High 2462MHz

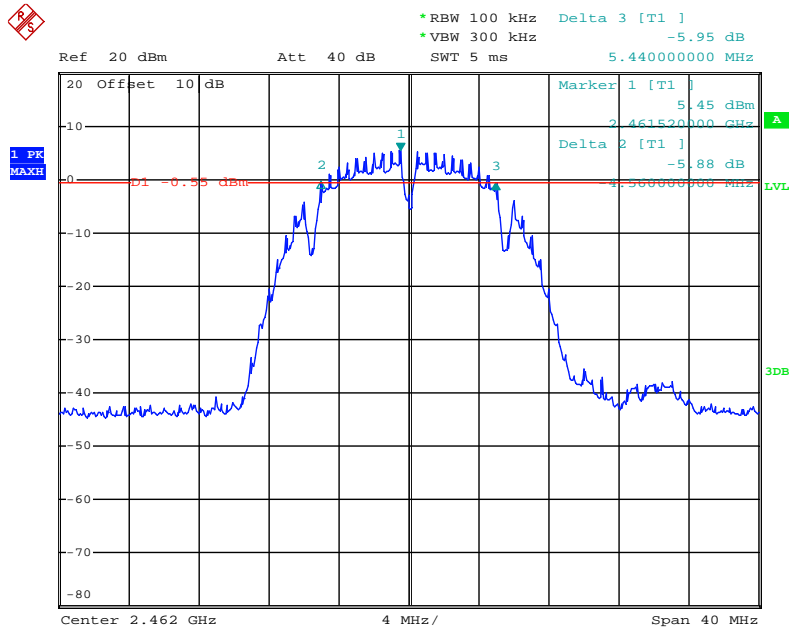

Date: 18.FEB.2020 07:55:37

802.11g Channel Low 2412MHz

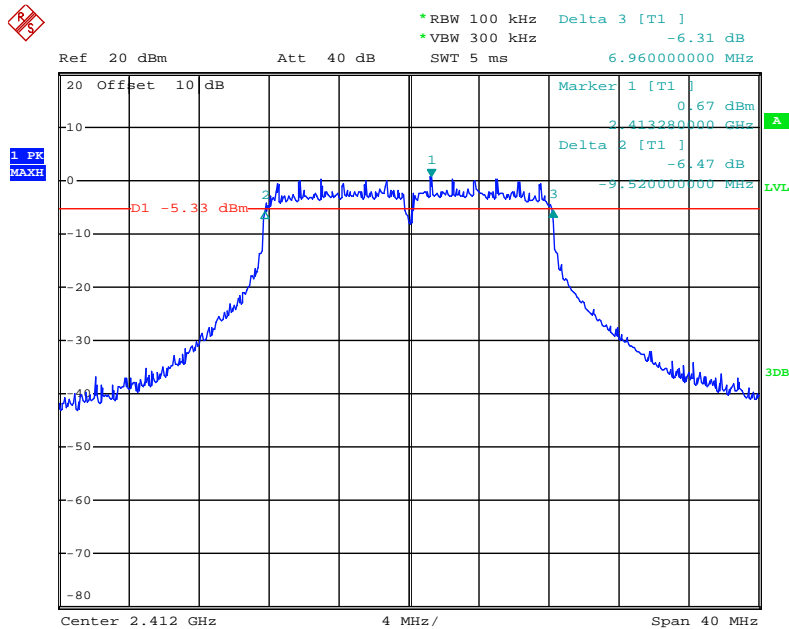

Date: 18.FEB.2020 07:57:25

802.11g Channel Middle 2437MHz

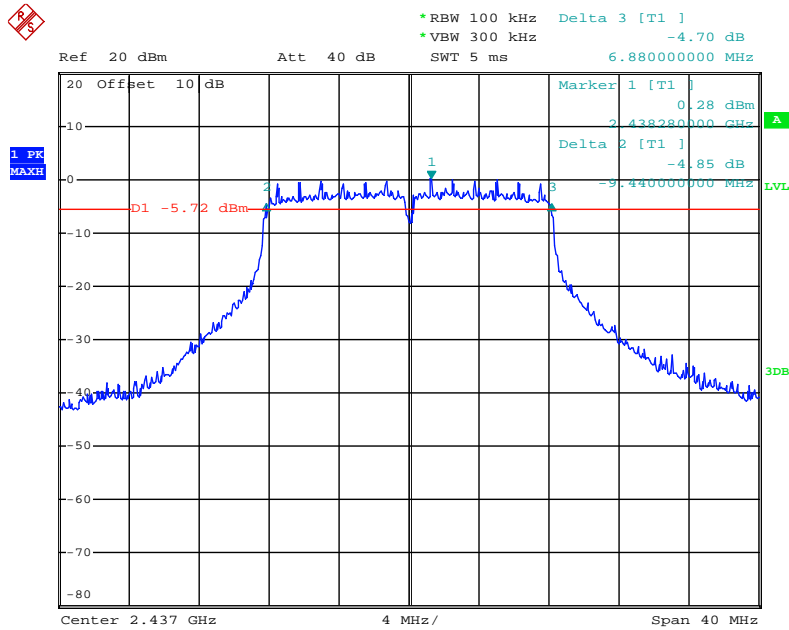

Date: 18.FEB.2020 08:02:58

802.11g Channel High 2462MHz

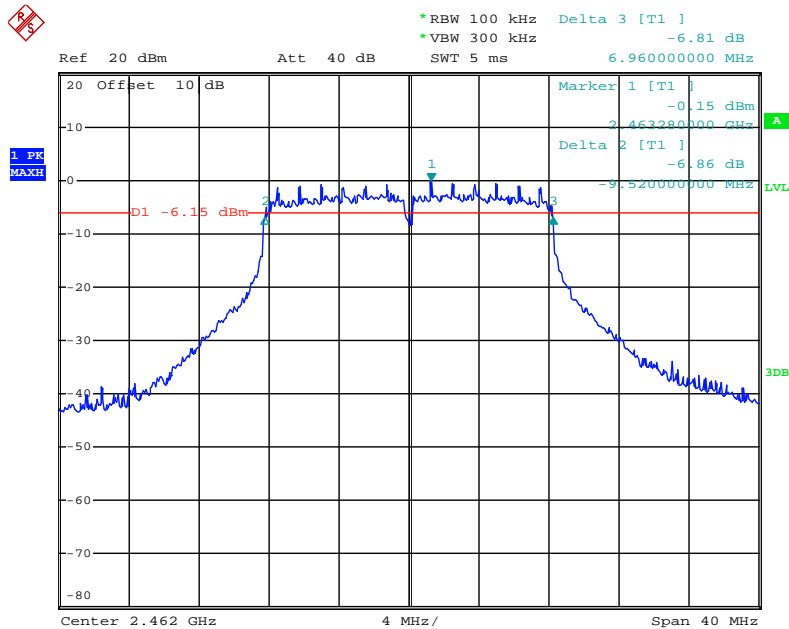

Date: 18.FEB.2020 08:05:27

802.11n Channel Low 2412MHz (20MHz)

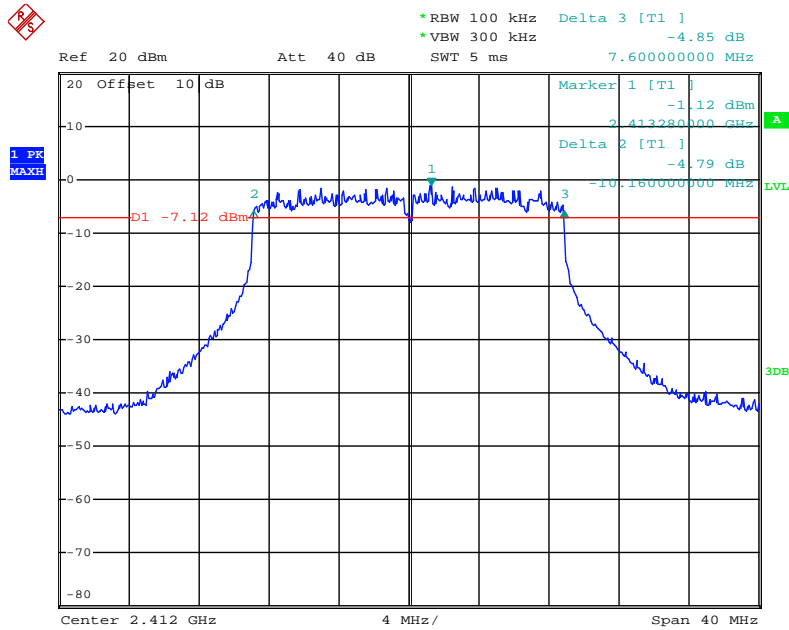

Date: 18.FEB.2020 08:07:57

802.11n Channel Middle 2437MHz(20MHz)

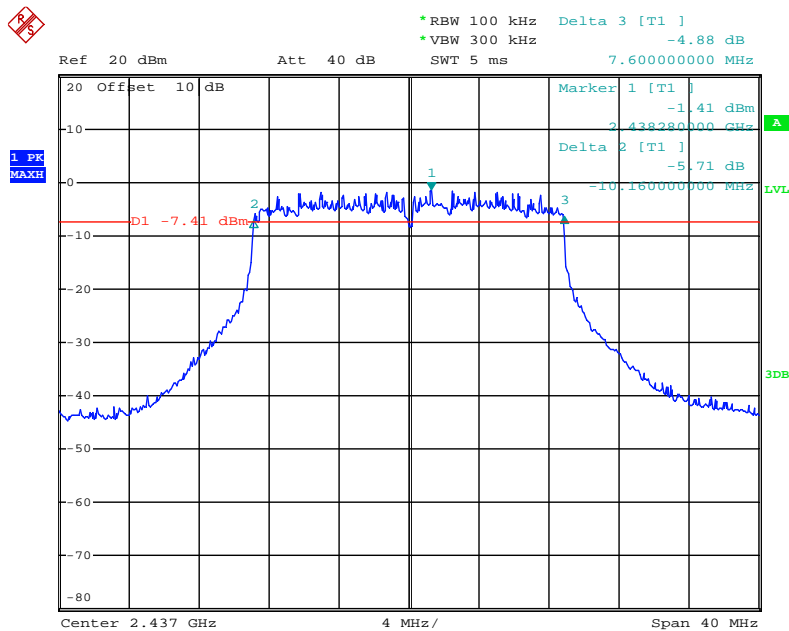

Date: 18.FEB.2020 08:10:11

802.11n Channel High 2462MHz(20MHz)

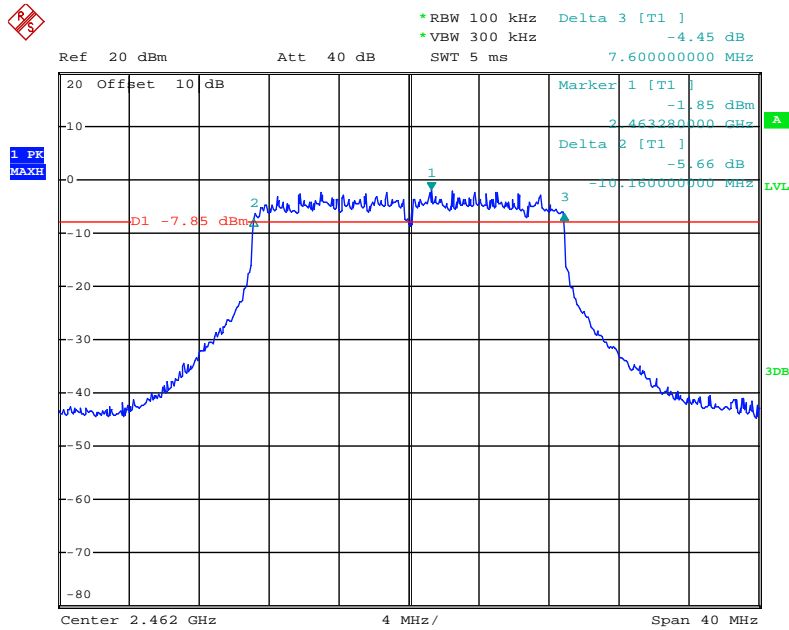

Date: 18.FEB.2020 08:12:26

802.11n Channel Low 2422MHz (40MHz)

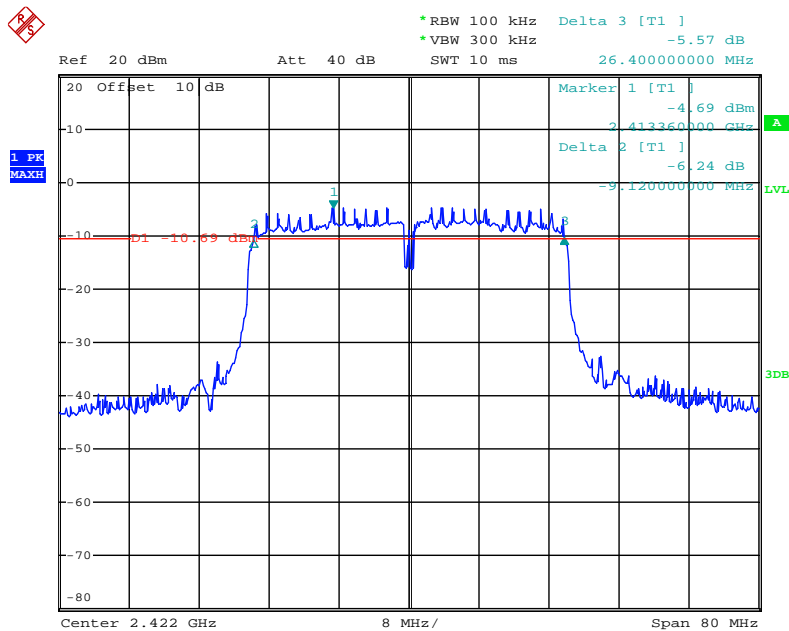

Date: 18.FEB.2020 08:14:40

802.11n Channel Middle 2437MHz(40MHz)

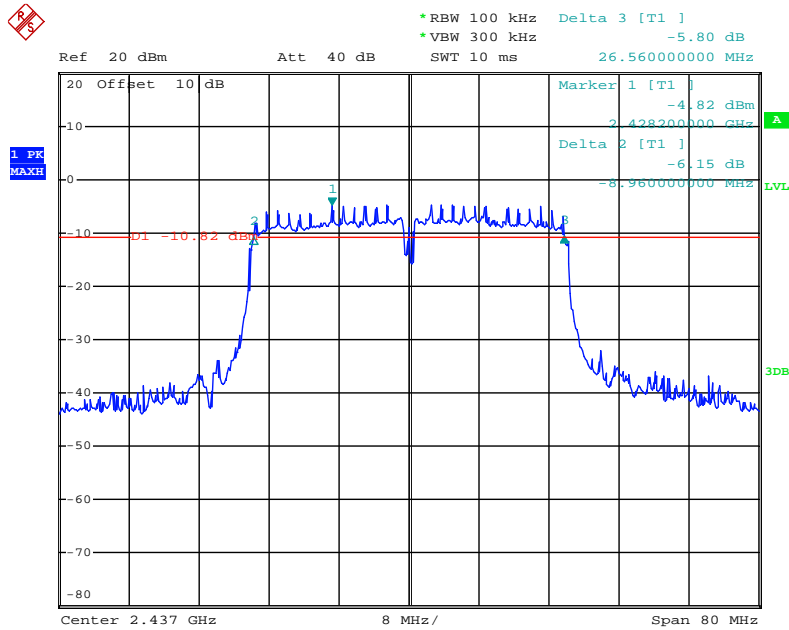

Date: 18.FEB.2020 08:16:56

802.11n Channel High 2452MHz(40MHz)

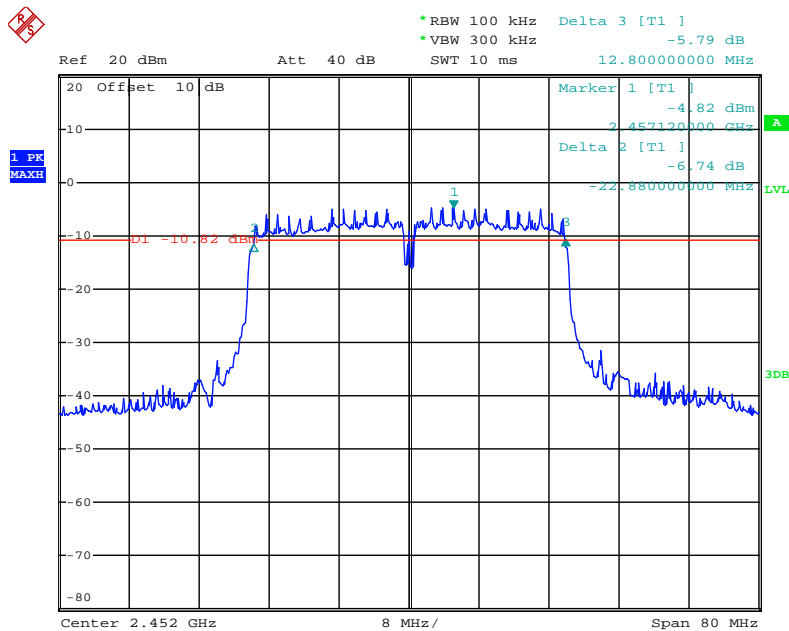

Date: 18.FEB.2020 08:19:16

6. 99% OCCUPIED BANDWIDTH

6.1. Block Diagram of Test Setup

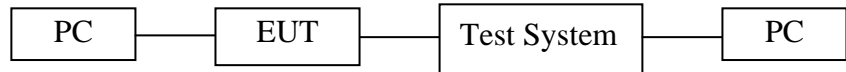

6.2. EUT Configuration on Measurement

The following equipment is installed on the emission measurement to meet the commission requirements and operating regulations in a manner which tends to maximize its emission characteristics in normal application.

6.3. Operating Condition of EUT

6.3.1. Setup the EUT and simulator as shown as Section 6.1.

6.3.2. Turn on the power of all equipment.

6.3.3. Let the EUT work in TX modes measure it. The transmit frequency range are 2412-2462MHz and 2422-2452MHz . We select three frequencies of high, medium and low channel in each frequency band for testing.

6.4. Test Procedure

6.4.1. The transmitter output was connected to the spectrum analyzer through a low loss cable. The transmitter shall be operated at its maximum carrier power measured under normal test conditions. The span of the analyzer shall be set to capture all products of the modulation process, including the emission skirts.

6.4.2. The resolution bandwidth (RBW) shall be in the range of 1% to 5% of the occupied bandwidth (OBW) and video bandwidth (VBW) shall be approximately 3x RBW.

6.4.3. A peak, or peak hold, may be used in place of the sampling detector as this may produce a wider bandwidth than the actual bandwidth (worst-case measurement). Use of a peak hold may be necessary to determine the occupied bandwidth if the device is not transmitting continuously.

6.4.4. Set SPA "Meas" function, Select "Occupied Bandwidth" function, Select "99% Power Bandwidth". The frequency of the upper and lower markers indicating the edges of the transmitters "99% Power" emission bandwidth shall be recorded to automate by SPA.

6.5.Measurement Result

The test was performed with 802.11b		
Channel	Frequency (MHz)	99% Occupied Bandwidth (MHz)
Low	2412	12.96
Middle	2437	12.96
High	2462	12.96

The test was performed with 802.11g		
Channel	Frequency (MHz)	99% Occupied Bandwidth (MHz)
Low	2412	17.12
Middle	2437	17.20
High	2462	17.12

The test was performed with 802.11n (Bandwidth: 20 MHz)		
Channel	Frequency (MHz)	99% Occupied Bandwidth (MHz)
Low	2412	18.00
Middle	2437	18.00
High	2462	18.00

The test was performed with 802.11n (Bandwidth: 40 MHz)		
Channel	Frequency (MHz)	99% Occupied Bandwidth (MHz)
Low	2422	36.48
Middle	2437	36.48
High	2452	36.48

The spectrum analyzer plots are attached as below.

802.11b Low Channel 2412MHz

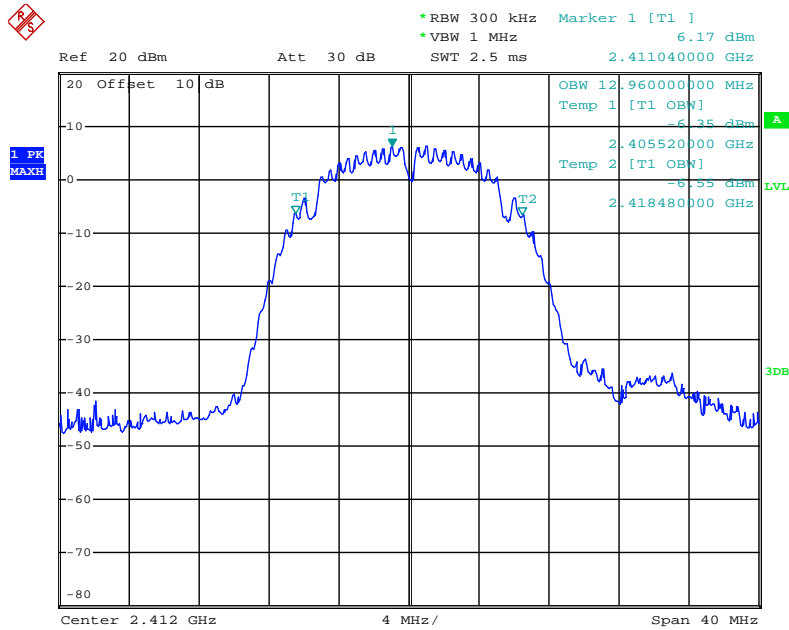

Date: 18.FEB.2020 08:23:37

802.11b Middle Channel 2437MHz

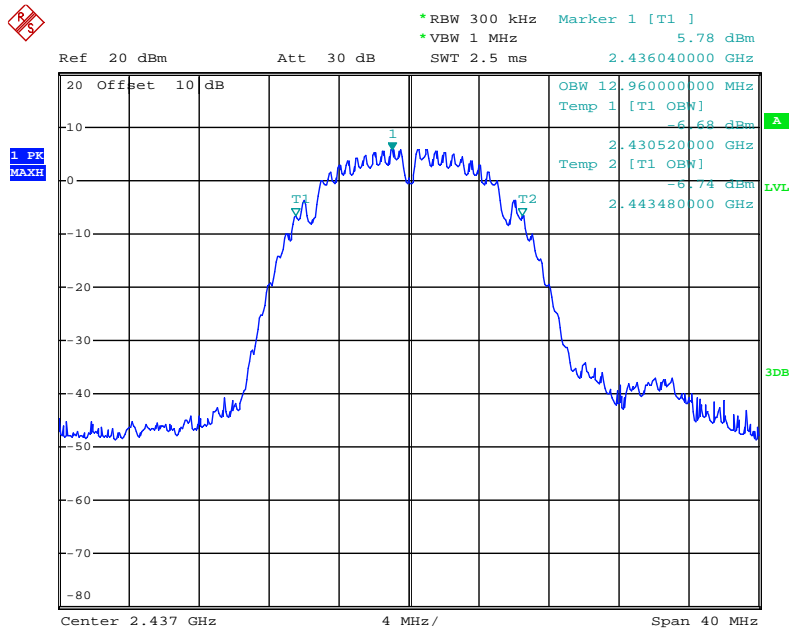

Date: 18.FEB.2020 08:24:44

802.11b High Channel 2462MHz

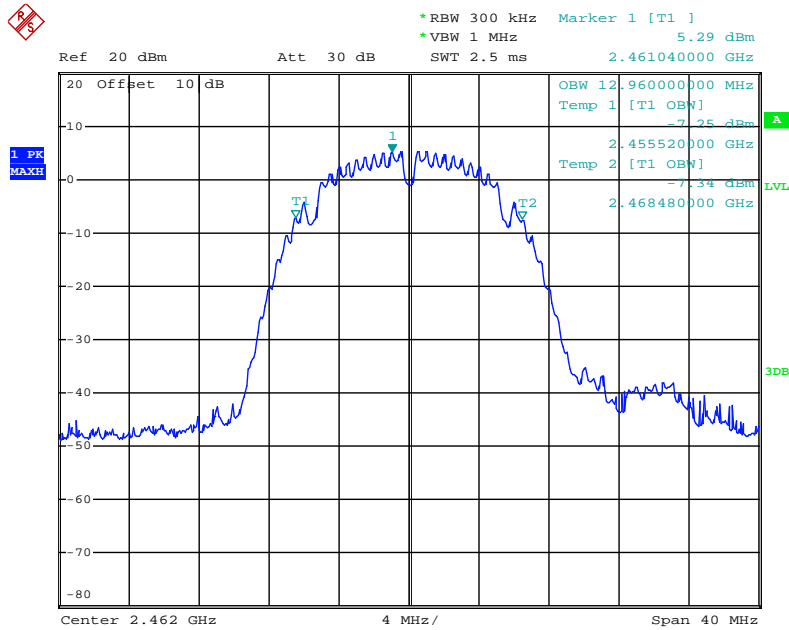

Date: 18.FEB.2020 08:25:29

802.11g Channel Low 2412MHz

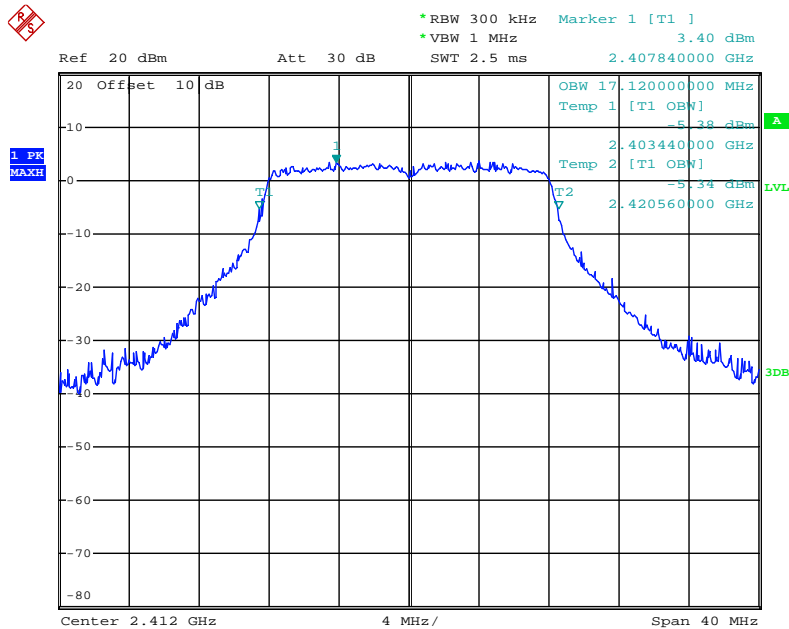

Date: 18.FEB.2020 08:26:21

802.11g Middle Channel 2437MHz

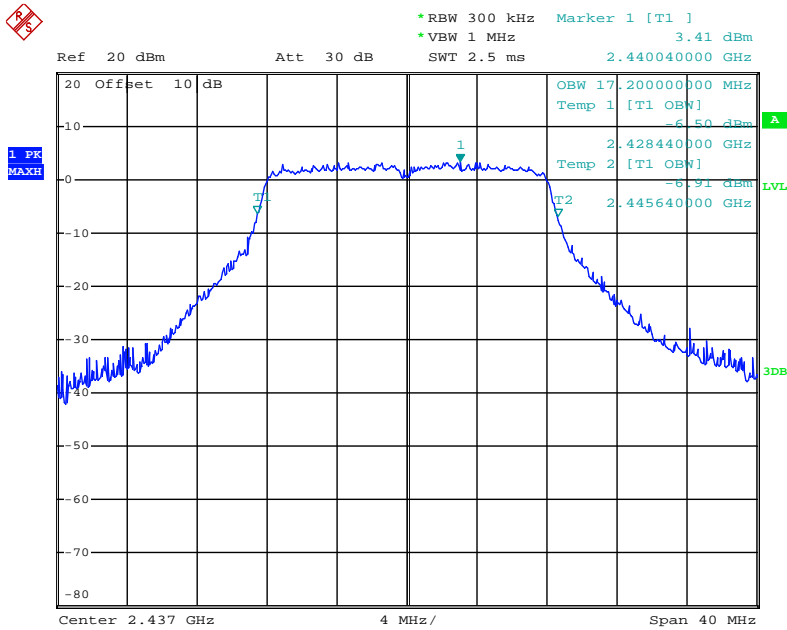

Date: 18.FEB.2020 08:27:02

802.11g High Channel 2462MHz

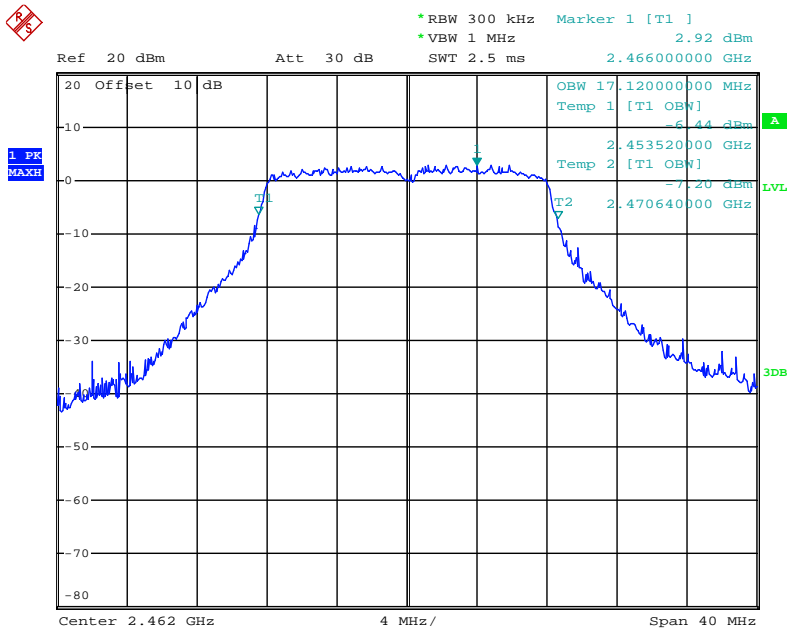

Date: 18.FEB.2020 08:27:50

802.11n(20MHz) Low Channel 2412MHz

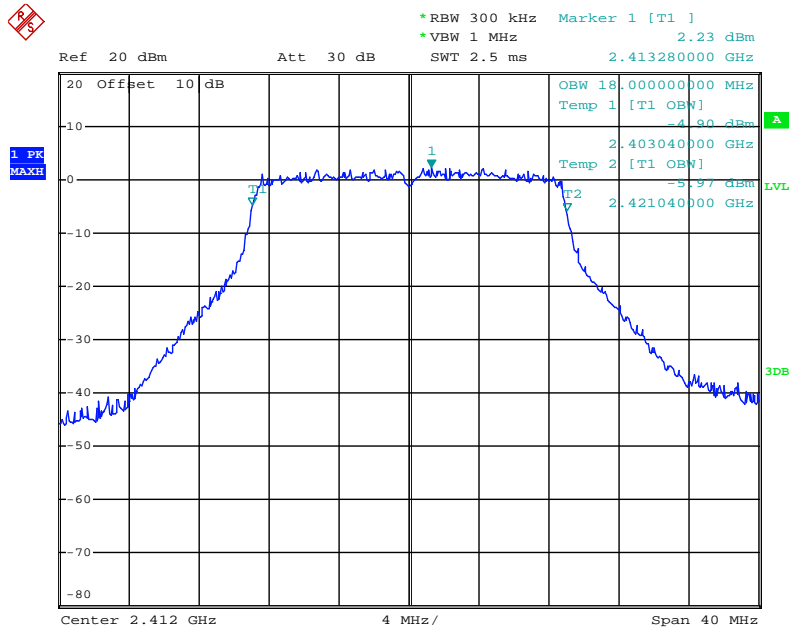

Date: 18.FEB.2020 08:28:45

802.11n(20MHz) Middle Channel 2437MHz

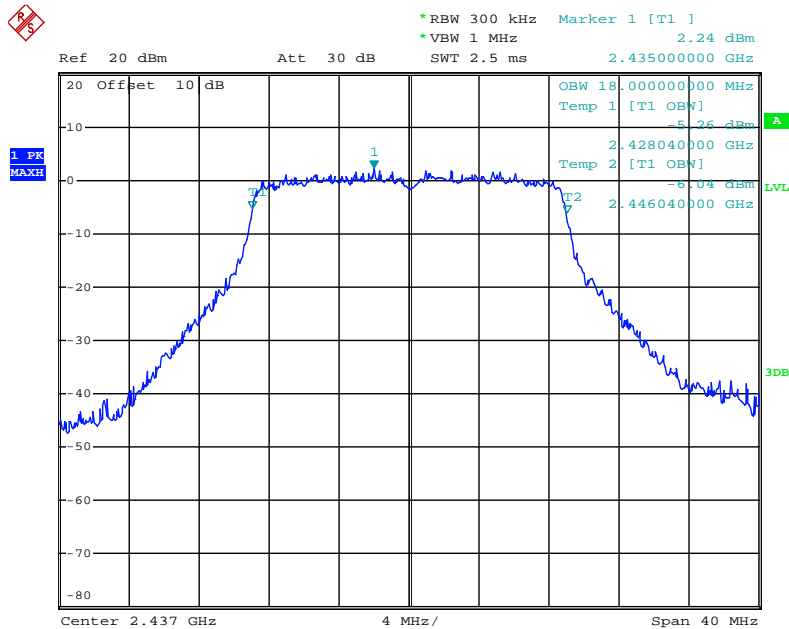

Date: 18.FEB.2020 08:29:20

802.11n(20MHz) High Channel 2462MHz

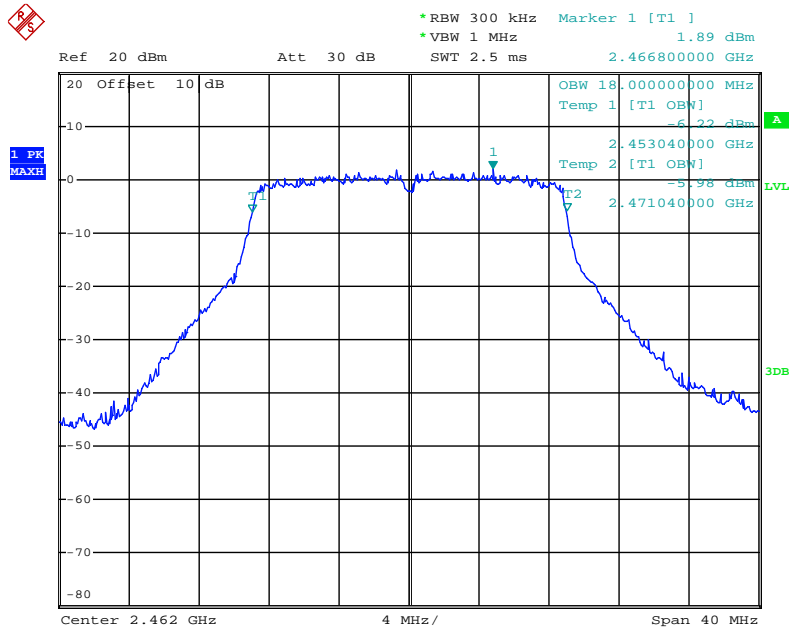

Date: 18.FEB.2020 08:30:04

802.11n(40MHz) Low Channel 2422MHz

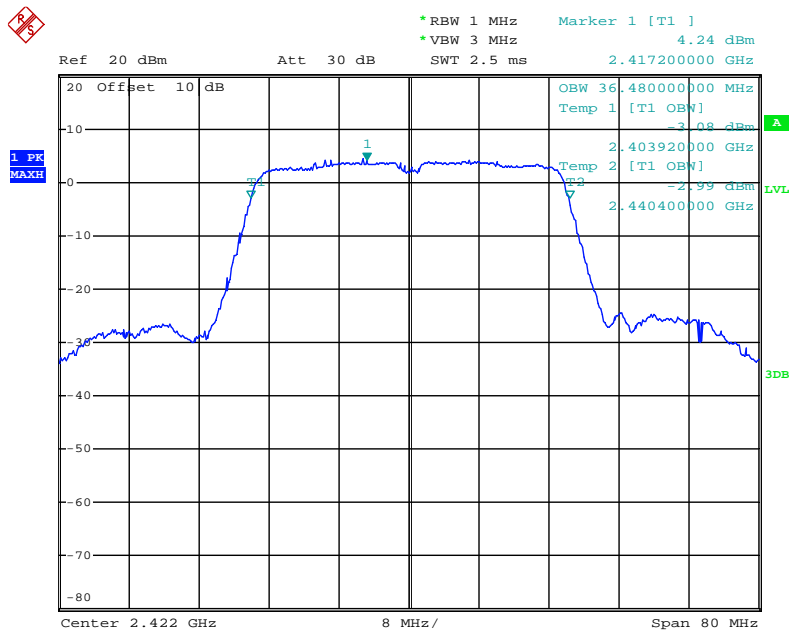

Date: 18.FEB.2020 08:31:31

802.11n(40MHz) Middle Channel 2437MHz

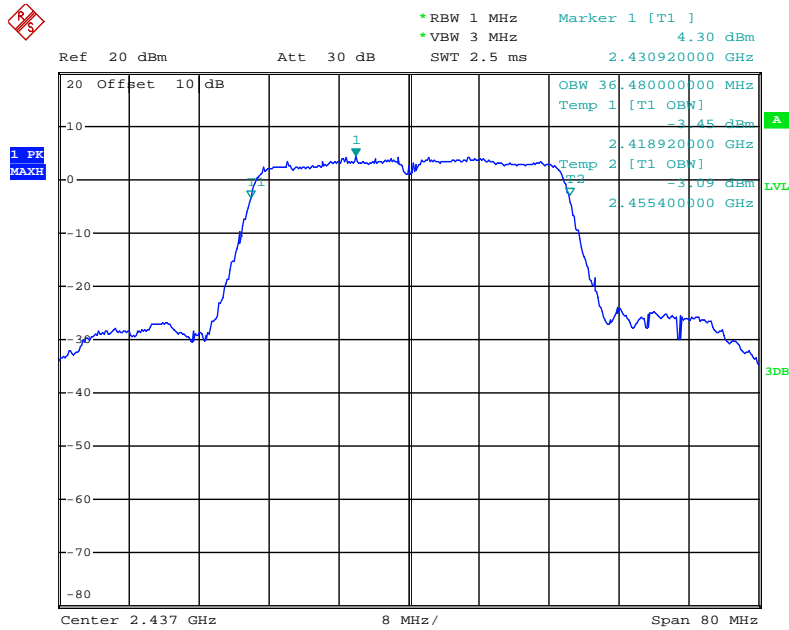

Date: 18.FEB.2020 08:32:44

802.11n(40MHz) High Channel 2452MHz

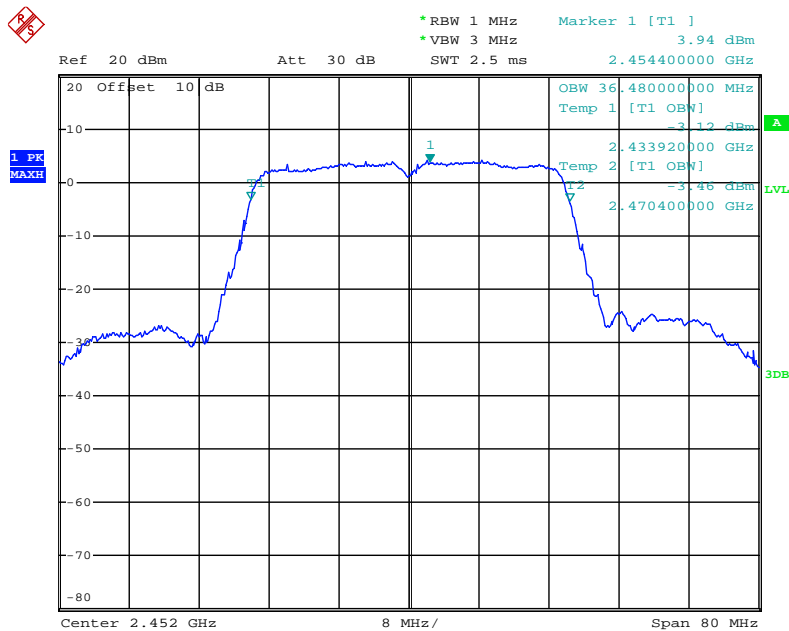

Date: 18.FEB.2020 08:33:43

7. DUTY CYCLE MEASUREMENT

7.1. Block Diagram of Test Setup



7.2. EUT Configuration on Measurement

The equipment are installed on the emission measurement to meet the commission requirements and operating regulations in a manner which tends to maximize its emission characteristics in normal application.

7.3. Operating Condition of EUT

7.3.1. Setup the EUT and simulator as shown as Section 7.1.

7.3.2. Turn on the power of all equipment.

7.3.3. Let the EUT work in TX modes measure it. The transmit frequency range are 2412-2462MHz and 2422-2452MHz . We select three frequencies of high, medium and low channel in each frequency band for testing.

7.4. Test Procedure

Measurements of duty cycle and transmission duration shall be performed using one of the following techniques:

1. A diode detector and an oscilloscope that together have sufficiently short response time to permit accurate measurements of the on- and off-times of the transmitted signal.
2. The zero-span mode on a spectrum analyzer or EMI receiver if the response time and spacing between bins on the sweep are sufficient to permit accurate measurements of the on- and off-times of the transmitted signal
 - a. Set the center frequency of the instrument to the centre frequency of the transmission
 - b. Set $RBW \geq OBW$ if possible; otherwise, set RBW to the largest available value(10MHz).
 - c. Set detector = Peak or average.
 - d. The zero-span measurement method shall not be used unless both RBW and VBW are $> 50/T$ and the number of sweep points across duration T exceeds 100.
(For example, if VBW and/or RBW are limited to 3MHz, then the zero-span method of measuring duty cycle shall not be used if $T \leq 16.7$ microseconds.)

7.5. Test Result

The test was performed with 802.11b			
Channel	Frequency (MHz)	duty cycle(x)	10log(1/x)
Middle	2437	96.31%	0.16

The test was performed with 802.11g			
Channel	Frequency (MHz)	duty cycle(x)	10log(1/x)
Middle	2437	86.49%	0.63

The test was performed with 802.11n20			
Channel	Frequency (MHz)	duty cycle(x)	10log(1/x)
Middle	2437	66.67%	1.76

The test was performed with 802.11n40			
Channel	Frequency (MHz)	duty cycle(x)	10log(1/x)
Middle	2437	73.68%	1.33

Note: The duty cycle's parameter settings for each mode(802.11b,g,n) are the same, Therefore, other channels can refer to the test data of the middle channel.

The spectrum analyzer plots are attached as below.

Duty cycle

802.11b Channel Middle 2437MHz

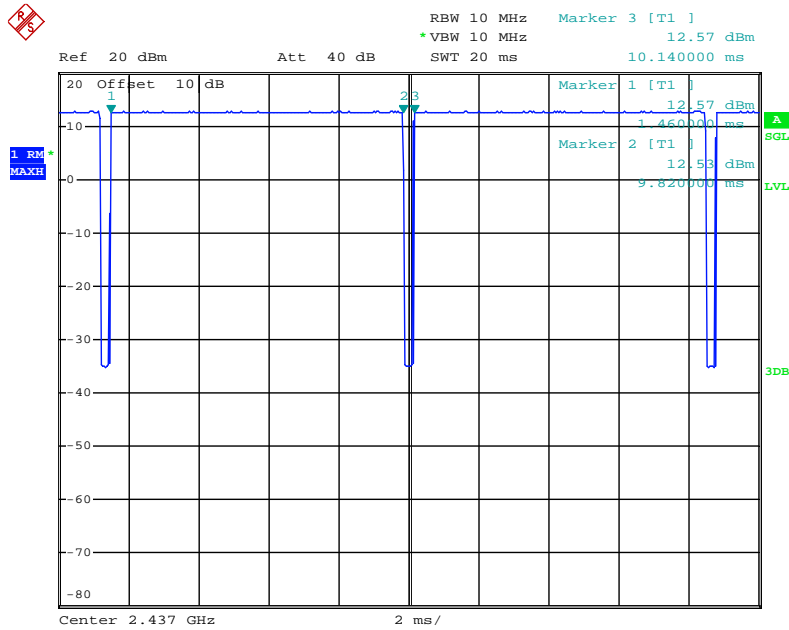

Date: 18.FEB.2020 09:47:02

802.11g Channel Middle 2437MHz

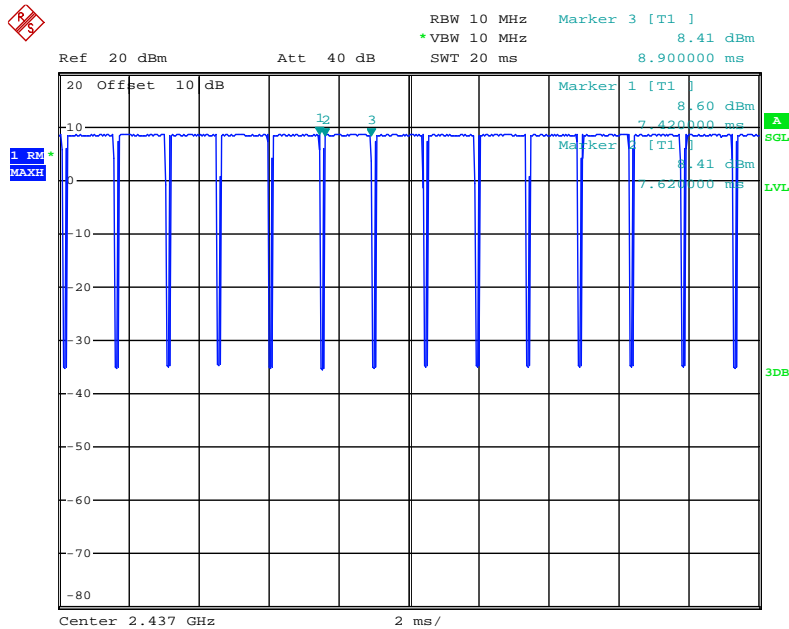

Date: 18.FEB.2020 09:48:40

802.11n20 Channel Middle 2437MHz

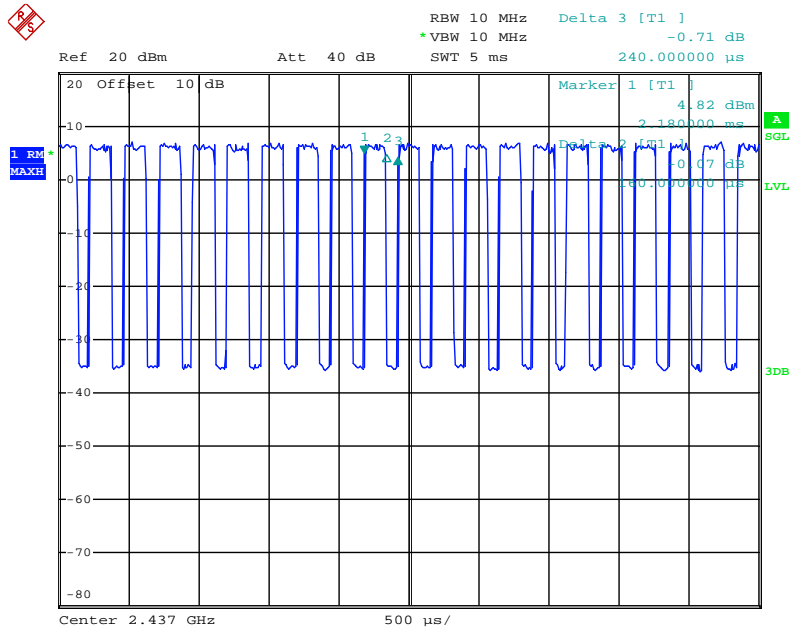

Date: 4.MAR.2020 14:34:11

802.11n40 Channel Middle 2437MHz

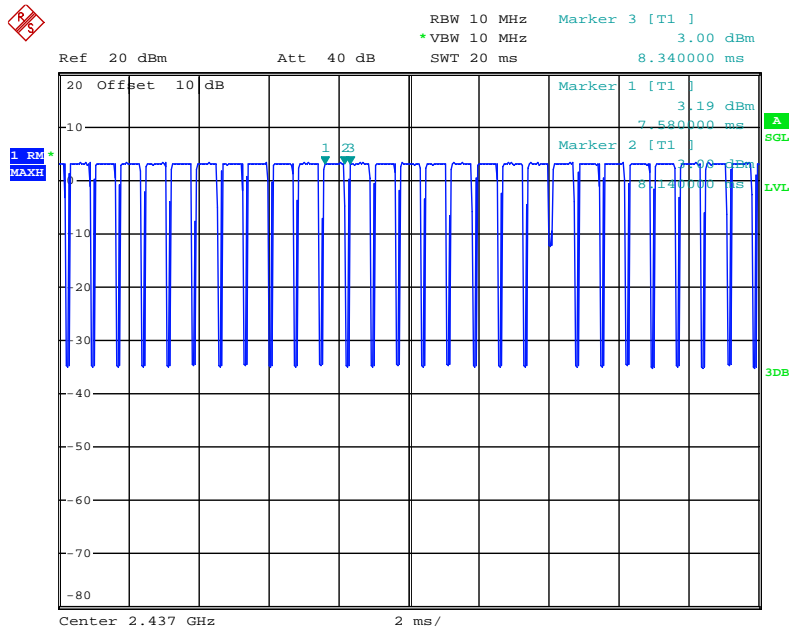

Date: 18.FEB.2020 09:51:43

8. POWER SPECTRAL DENSITY TEST

8.1. Block Diagram of Test Setup



8.2. The Requirement For Section 15.247(e)

Section 15.247(e): For digitally modulated systems, the power spectral density conducted from the intentional radiator to the antenna shall not be greater than 8 dBm in any 3 kHz band during any time interval of continuous transmission.

8.3. EUT Configuration on Measurement

The equipment are installed on the emission Measurement to meet the commission requirements and operating regulations in a manner which tends to maximize its emission characteristics in normal application.

8.4. Operating Condition of EUT

8.4.1. Setup the EUT and simulator as shown as Section 8.1.

8.4.2. Turn on the power of all equipment.

8.4.3. Let the EUT work in TX modes measure it. The transmit frequency range are 2412-2462MHz and 2422-2452MHz . We select three frequencies of high, medium and low channel in each frequency band for testing.

8.5. Test Procedure

8.5.1. The transmitter output was connected to the spectrum analyzer through a low loss cable.

8.5.2. Measurement Procedure PKPSD:

This procedure must be used if maximum peak conducted output power was used to demonstrate compliance to the fundamental output power limit, and is optional if the maximum (average) conducted output power was used to demonstrate compliance.

1. Set analyzer center frequency to DTS channel center frequency.
2. Set the span to 1.5 times the DTS channel bandwidth.
3. Set the RBW $3 \text{ kHz} \leq \text{RBW} \leq 100 \text{ kHz}$.

4. Set the VBW $\geq 3 \times$ RBW.
5. Detector = peak.
6. Sweep time = auto couple.
7. Trace mode = max hold.
8. Allow trace to fully stabilize.
9. Use the peak marker function to determine the maximum amplitude level.
10. If measured value exceeds limit, reduce RBW (no less than 3 kHz) and repeat.

8.5.3.Measurement the maximum power spectral density.

8.6.Test Result

PASS

The test was performed with 802.11b					
Channel	Frequency (MHz)	Power Spectral Density(dBm)	10log(1/ duty cycle)	Final Power Spectral Density(dBm)	Limits (dBm)
Low	2412	-16.36	0.16	-16.20	8 dBm
Middle	2437	-17.73	0.16	-17.57	8 dBm
High	2462	-17.34	0.16	-17.18	8 dBm

The test was performed with 802.11g					
Channel	Frequency (MHz)	Power Spectral Density(dBm)	10log(1/ duty cycle)	Final Power Spectral Density(dBm)	Limits (dBm)
Low	2412	-22.40	0.63	-21.77	8 dBm
Middle	2437	-22.54	0.63	-21.91	8 dBm
High	2462	-23.06	0.63	-22.43	8 dBm

The test was performed with 802.11n(20MHz)					
Channel	Frequency (MHz)	Power Spectral Density(dBm)	10log(1/ duty cycle)	Final Power Spectral Density(dBm)	Limits (dBm)
Low	2412	-23.60	1.76	-21.84	8 dBm
Middle	2437	-24.54	1.76	-22.78	8 dBm
High	2462	-24.78	1.76	-23.02	8 dBm

The test was performed with 802.11n(40MHz)					
Channel	Frequency (MHz)	Power Spectral Density(dBm)	10log(1/ duty cycle)	Final Power Spectral Density(dBm)	Limits (dBm)
Low	2422	-28.17	1.33	-26.84	8 dBm
Middle	2437	-28.45	1.33	-27.12	8 dBm
High	2452	-28.44	1.33	-27.11	8 dBm

The spectrum analyzer plots are attached as below.

802.11b Low Channel 2412MHz

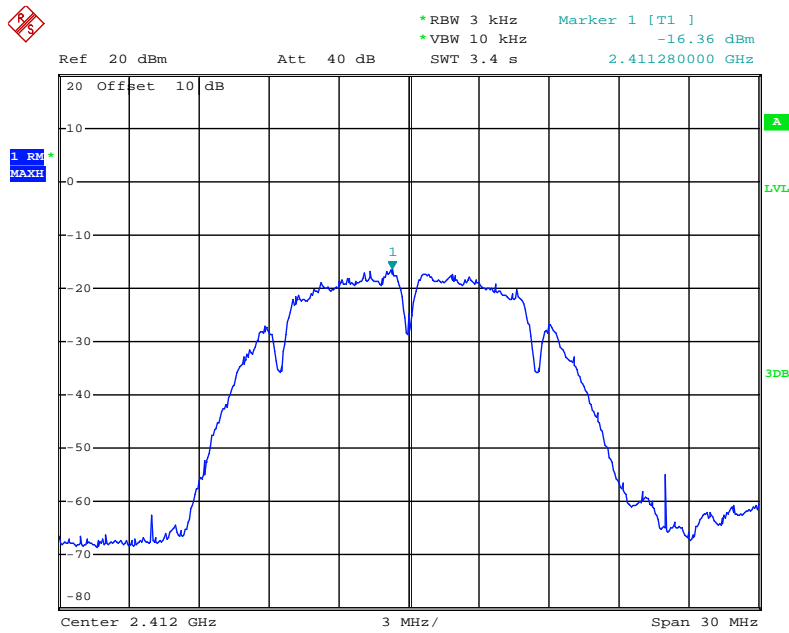

Date: 18.FEB.2020 08:54:24

802.11b Middle Channel 2437MHz

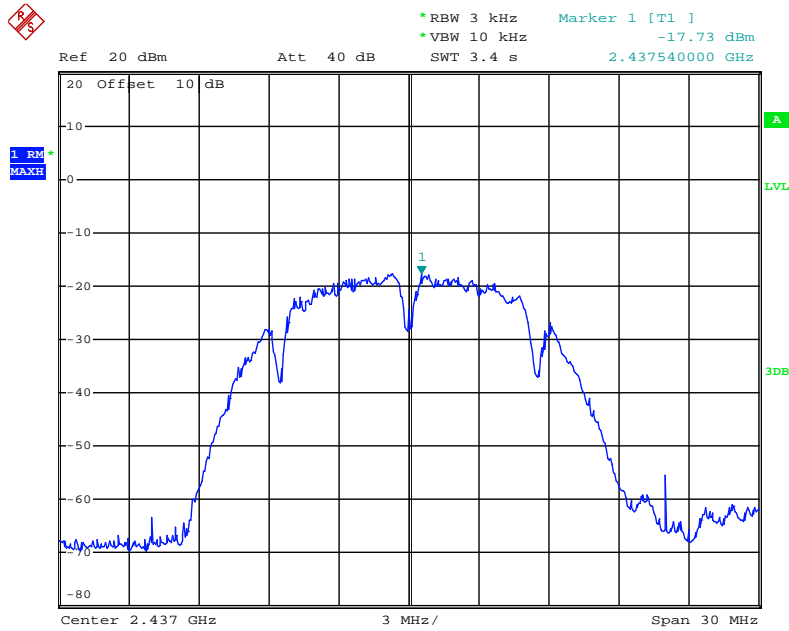

Date: 18.FEB.2020 08:55:12

802.11b High Channel 2462MHz

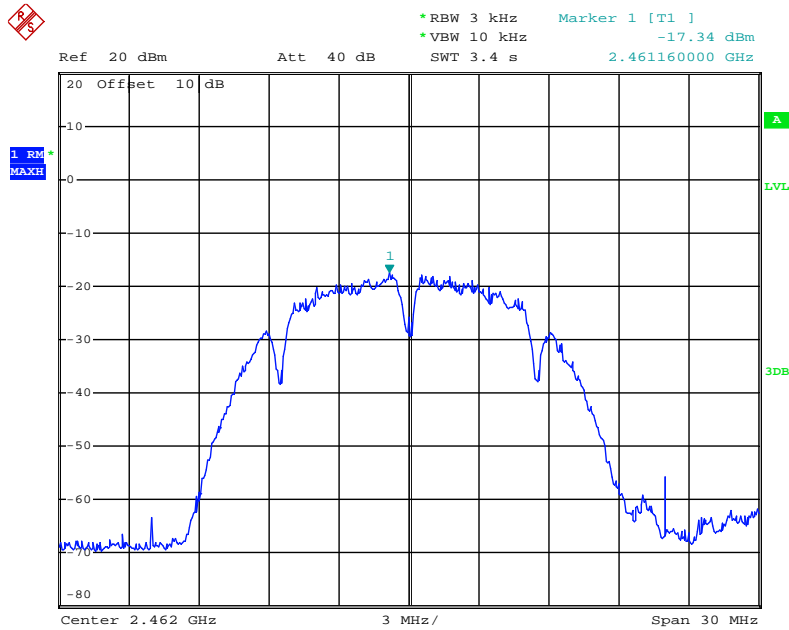

Date: 18.FEB.2020 08:55:46

802.11g Low Channel 2412MHz

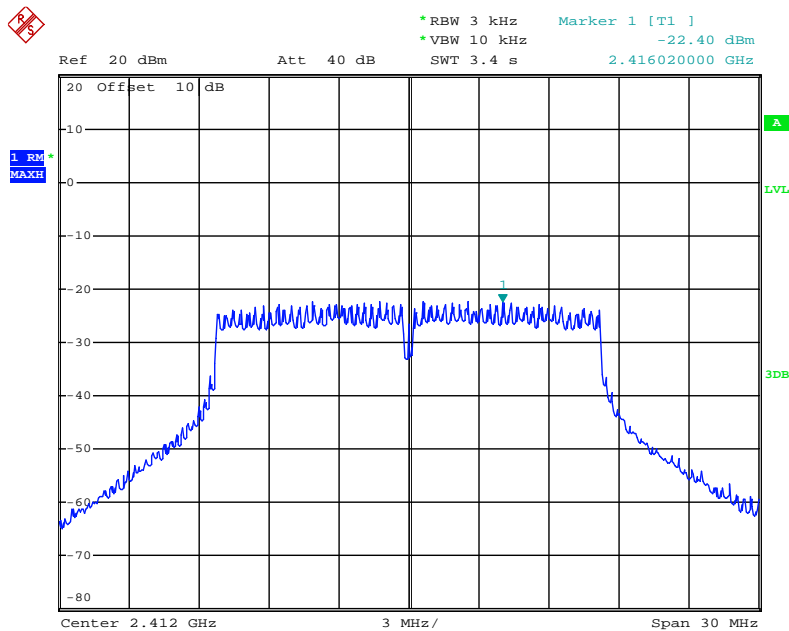

Date: 18.FEB.2020 08:56:25

802.11g Middle Channel 2437MHz

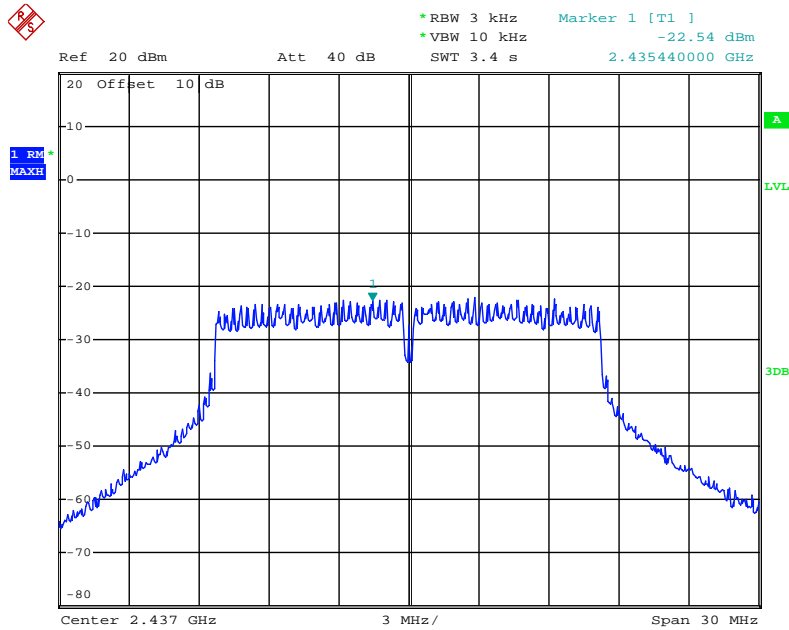

Date: 18.FEB.2020 08:57:00

802.11g High Channel 2462MHz

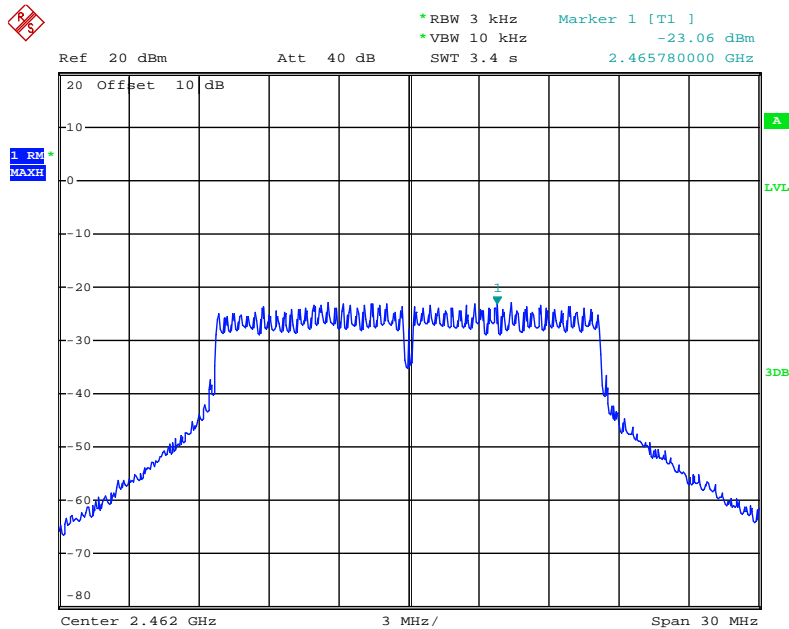

Date: 18.FEB.2020 08:57:50

802.11n(20MHz) Low Channel 2412MHz

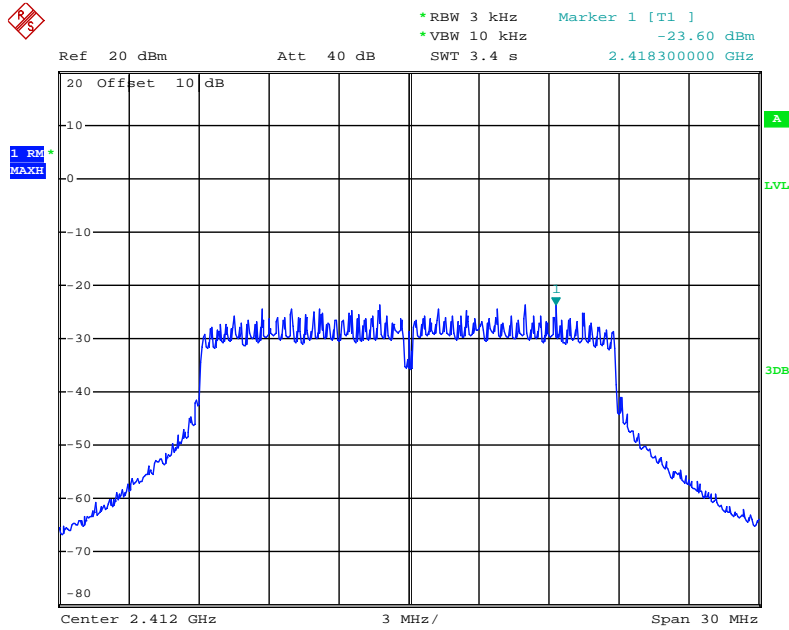

Date: 18.FEB.2020 08:59:03

802.11n(20MHz) Middle Channel 2437MHz

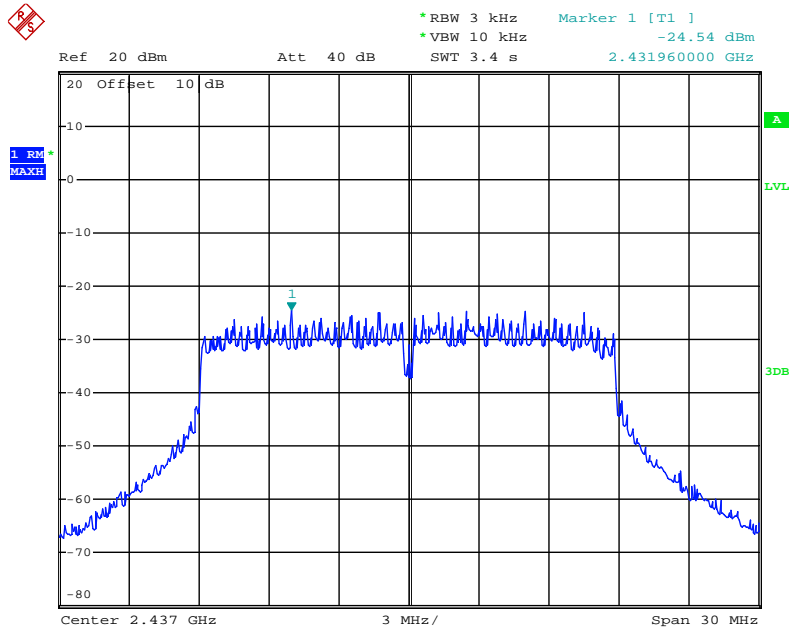

Date: 18.FEB.2020 08:59:38

802.11n(20MHz) High Channel 2462MHz

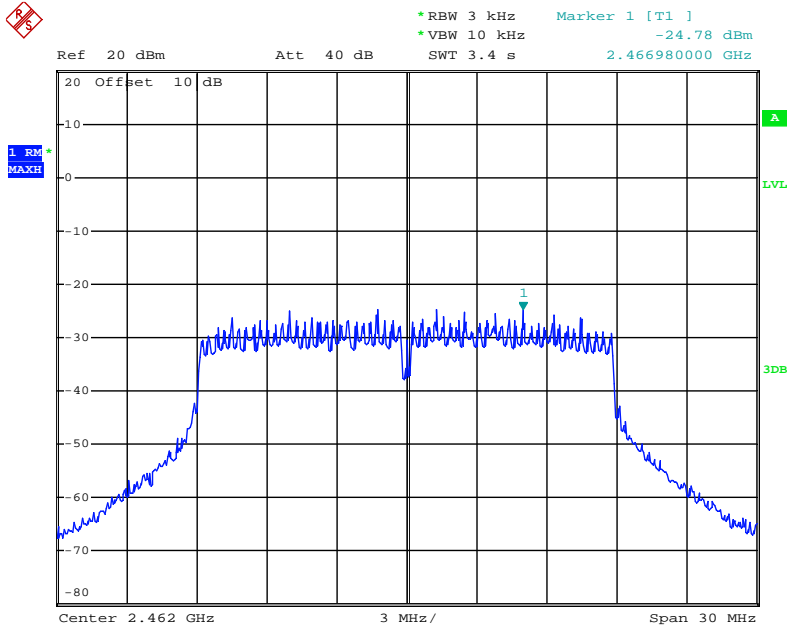

Date: 18.FEB.2020 09:00:13

802.11n(40MHz) Low Channel 2422MHz

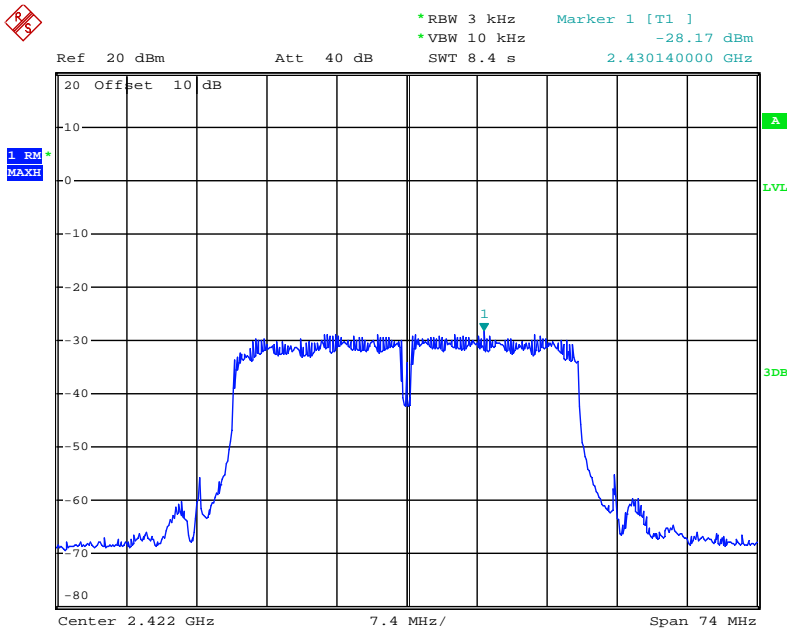

Date: 18.FEB.2020 09:01:16

802.11n(40MHz) Middle Channel 2437MHz

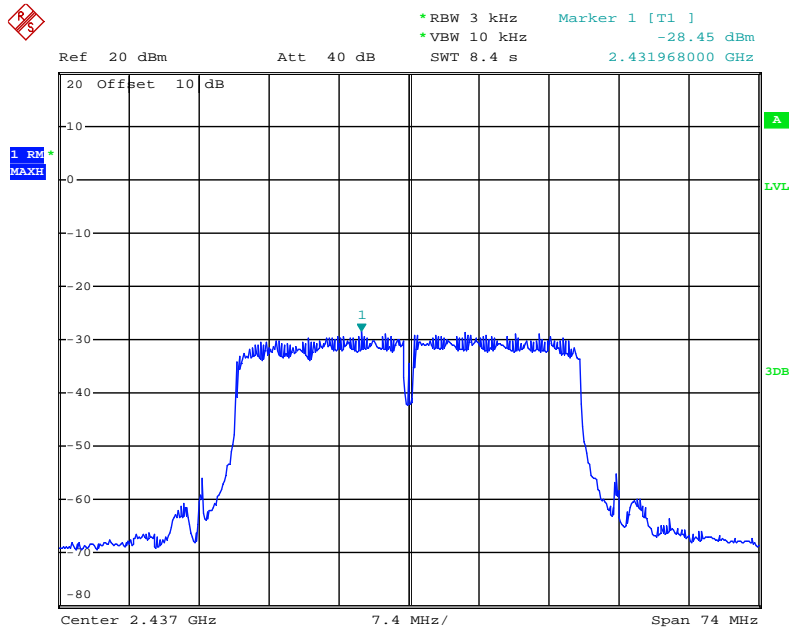

Date: 18.FEB.2020 09:02:11

802.11n(40MHz) High Channel 2452MHz

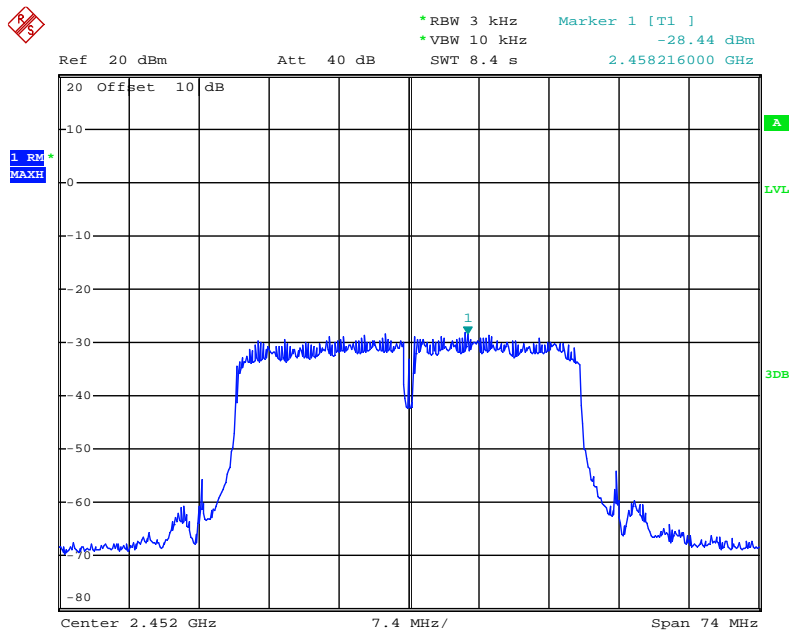

Date: 18.FEB.2020 09:03:00

9. MAXIMUM CONDUCTED (AVERAGE) OUTPUT POWER

9.1. Block Diagram of Test Setup

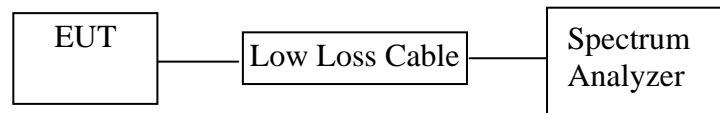

9.2. The Requirement For Section 15.247(b)(3)

Section 15.247(b)(3): For systems using digital modulation in the 902-928MHz, 2400-2483.5MHz, and 5725-5850MHz bands: 1 Watt.

9.3. EUT Configuration on Measurement

The equipment is installed on the emission Measurement to meet the commission requirements and operating regulations in a manner which tends to maximize its emission characteristics in normal application.

9.4. Operating Condition of EUT

9.4.1. Setup the EUT and simulator as shown as Section 9.1.

9.4.2. Turn on the power of all equipment.

9.4.3. Let the EUT work in TX modes measure it. The transmit frequency range are 2412-2462MHz and 2422-2452MHz. We select three frequencies of high, medium and low channel in each frequency band for testing.

9.5. Test Procedure

9.5.1. The EUT was tested according to DTS test procedure of April 02, 2019 KDB558074 D01 DTS Meas Guidance v0502 for compliance to FCC 47CFR 15.247 requirements.

9.5.2. The transmitter output was connected to the spectrum analyzer through a low loss cable.

9.5.3. Set RBW = 1-5% of the OBW, not to exceed 1 MHz, VBW \geq 3 x RBW, Sweep time = auto, Set span to at least 1.5 times the OBW, Detector = RMS.

9.5.4. Measurement the Maximum conducted (average) output power.

9.6.Test Result

Final power= Ave output power+10log(1/ duty cycle)

The test was performed with 802.11b					
Frequency (MHz)	Ave output power (dBm)	10log(1/ duty cycle)	Final power (dBm)	Final power (W)	FCC Limits dBm / W
2412	17.37	0.16	17.53	0.0566	30 dBm / 1 W
2437	17.10	0.16	17.26	0.0532	30 dBm / 1 W
2462	16.56	0.16	16.72	0.0470	30 dBm / 1 W

The test was performed with 802.11g					
Frequency (MHz)	Ave output power (dBm)	10log(1/ duty cycle)	Final power (dBm)	Final power (W)	FCC Limits dBm / W
2412	15.69	0.63	16.32	0.0429	30 dBm / 1 W
2437	15.27	0.63	15.90	0.0389	30 dBm / 1 W
2462	14.67	0.63	15.30	0.0339	30 dBm / 1 W

The test was performed with 802.11n(20MHz)					
Frequency (MHz)	Ave output power (dBm)	10log(1/ duty cycle)	Final power (dBm)	Final power (W)	FCC Limits dBm / W
2412	14.43	1.76	16.19	0.0416	30 dBm / 1 W
2437	14.06	1.76	15.82	0.0382	30 dBm / 1 W
2462	13.85	1.76	15.61	0.0364	30 dBm / 1 W

The test was performed with 802.11n(40MHz)					
Frequency (MHz)	Ave output power (dBm)	10log(1/ duty cycle)	Final power (dBm)	Final power (W)	FCC Limits dBm / W
2422	11.38	1.33	12.71	0.0187	30 dBm / 1 W
2437	11.13	1.33	12.46	0.0176	30 dBm / 1 W
2452	11.12	1.33	12.45	0.0176	30 dBm / 1 W

The spectrum analyzer plots are attached as below.

802.11b Low Channel 2412MHz

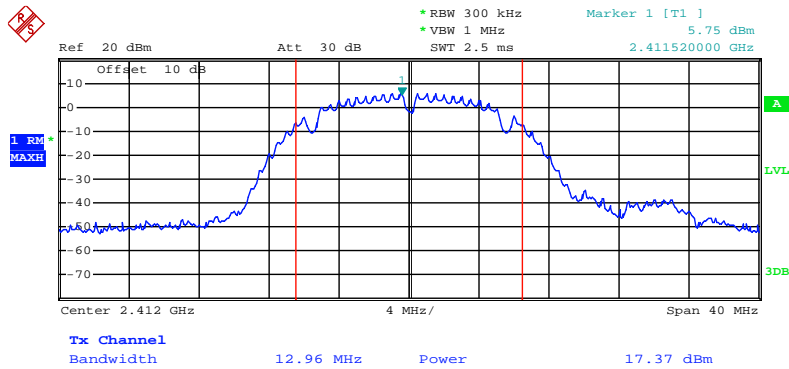

Date: 18.FEB.2020 08:40:24

802.11b Middle Channel 2437MHz

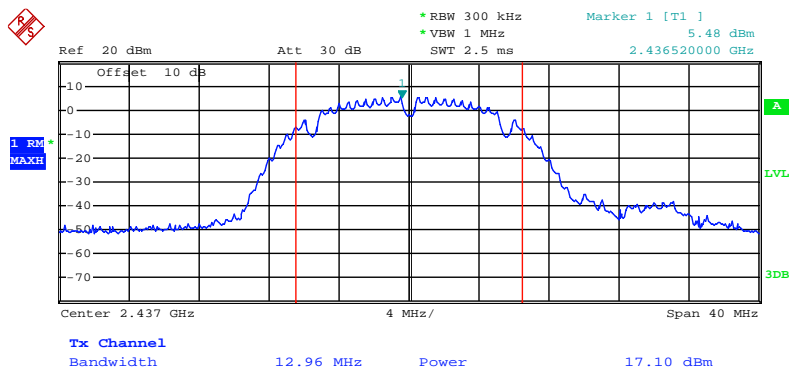

Date: 18.FEB.2020 08:39:44

802.11b High Channel 2462MHz

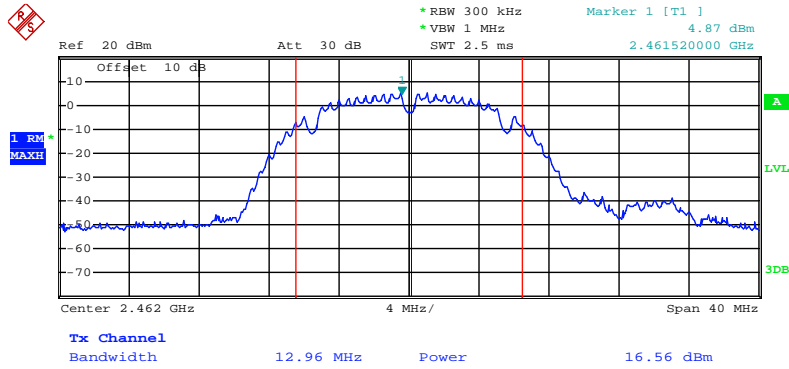

Date: 18.FEB.2020 08:41:08

802.11g Low Channel 2412MHz

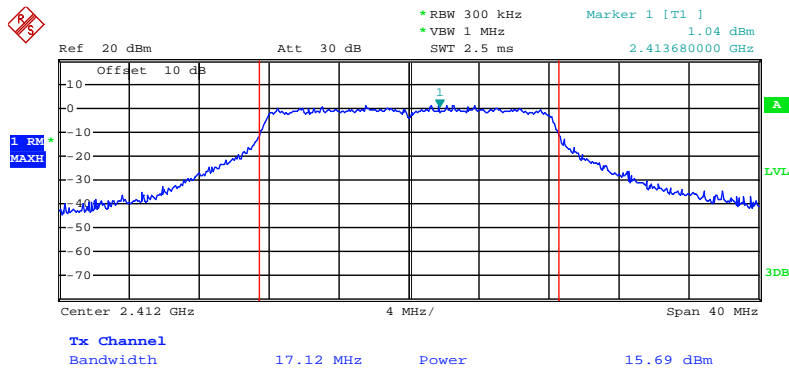

Date: 18.FEB.2020 08:42:13

802.11g Middle Channel 2437MHz

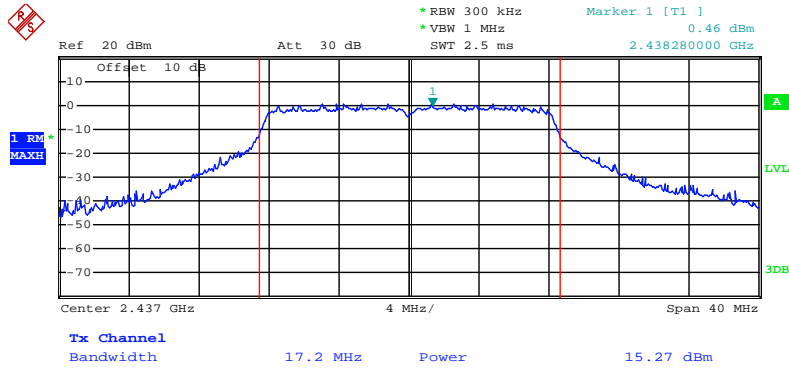

Date: 18.FEB.2020 08:43:20

802.11g High Channel 2462MHz

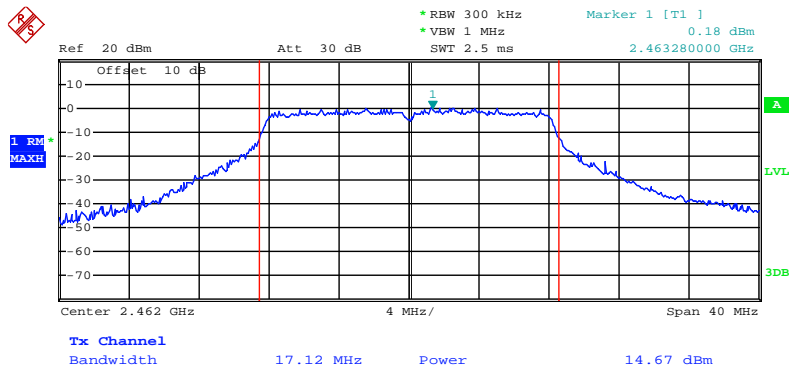

Date: 18.FEB.2020 08:44:36

802.11n(20MHz) Low Channel 2412MHz

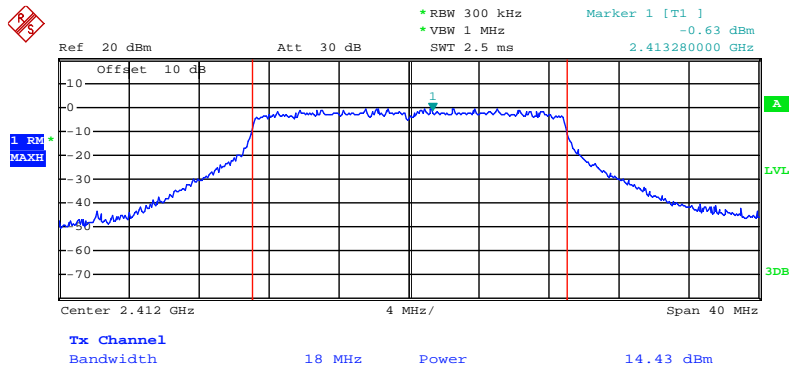

Date: 18.FEB.2020 08:45:55

802.11n(20MHz) Middle Channel 2437MHz

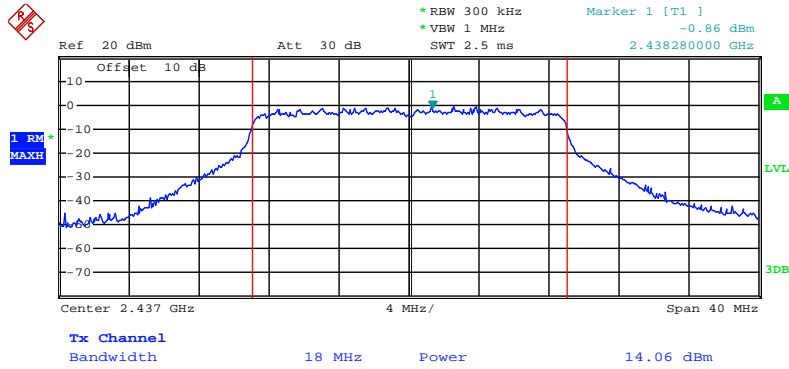

Date: 18.FEB.2020 08:46:43

802.11n(20MHz) High Channel 2462MHz

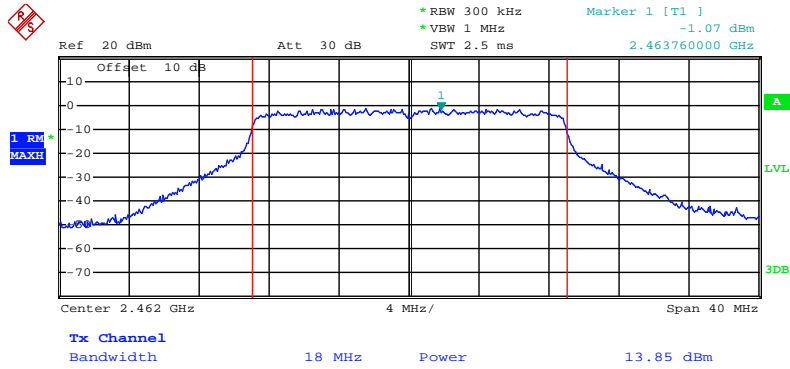

Date: 18.FEB.2020 08:47:41

802.11n(40MHz) Low Channel 2422MHz

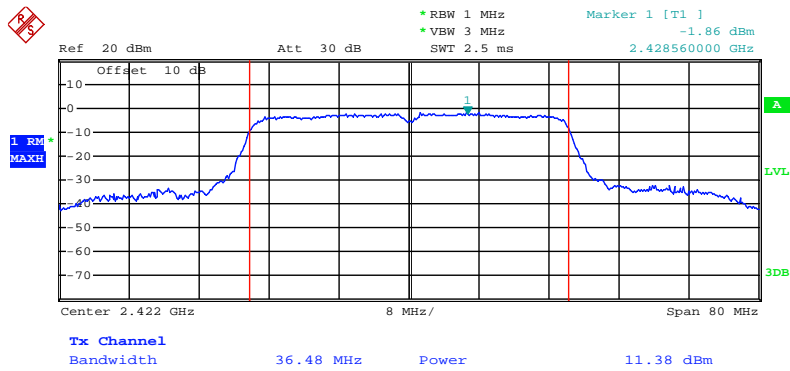

Date: 18.FEB.2020 08:49:59

802.11n(40MHz) Middle Channel 2437MHz

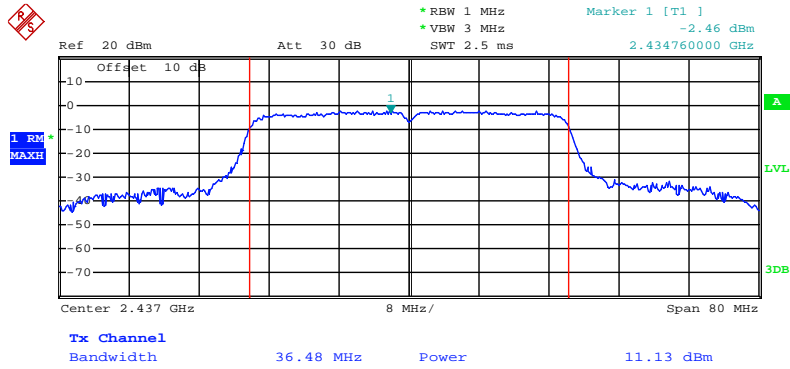

Date: 18.FEB.2020 08:51:15

802.11n(40MHz) High Channel 2452MHz

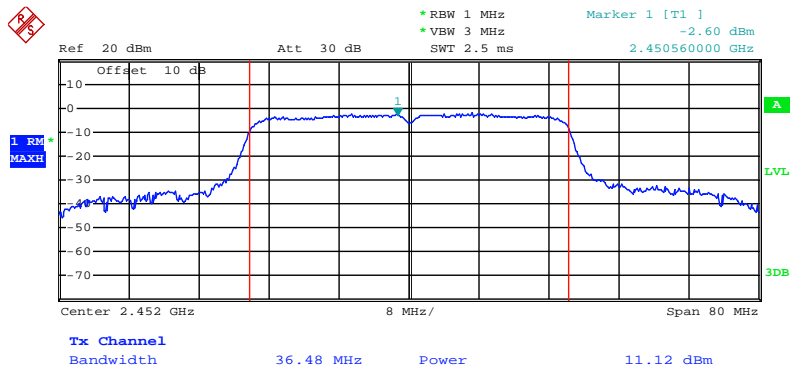

Date: 18.FEB.2020 08:52:07

10.RADIATED SPURIOUS EMISSION TEST

10.1.Block Diagram of Test Setup

10.1.1.Block diagram of connection between the EUT and peripherals

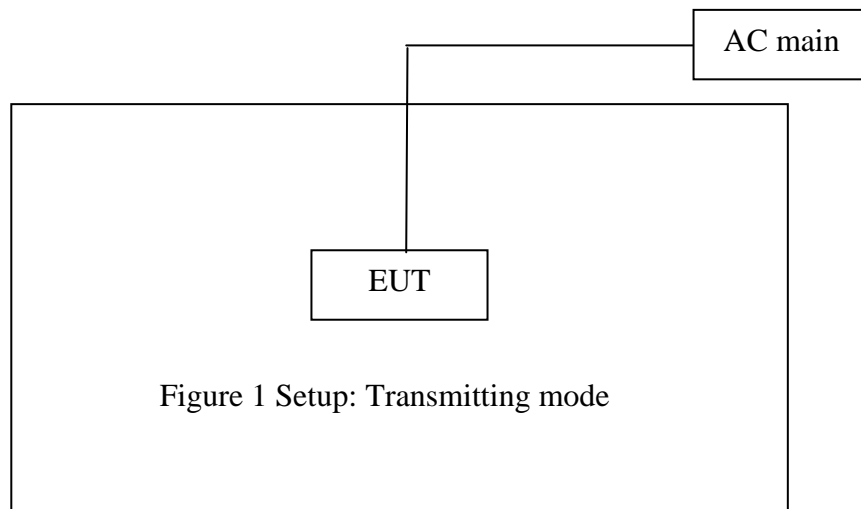

10.1.2.Semi-Anechoic Chamber Test Setup Diagram

(A) Radiated Emission Test Set-Up, Frequency below 30MHz

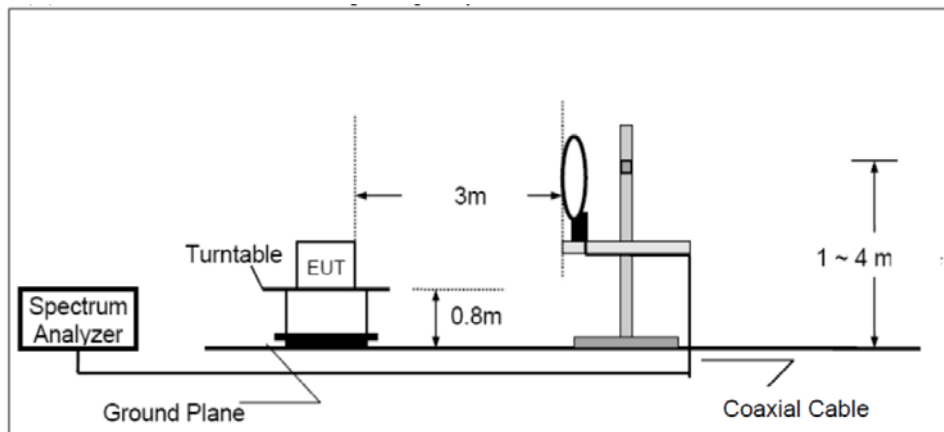

(B) Radiated Emission Test Set-Up, Frequency below 1GHz

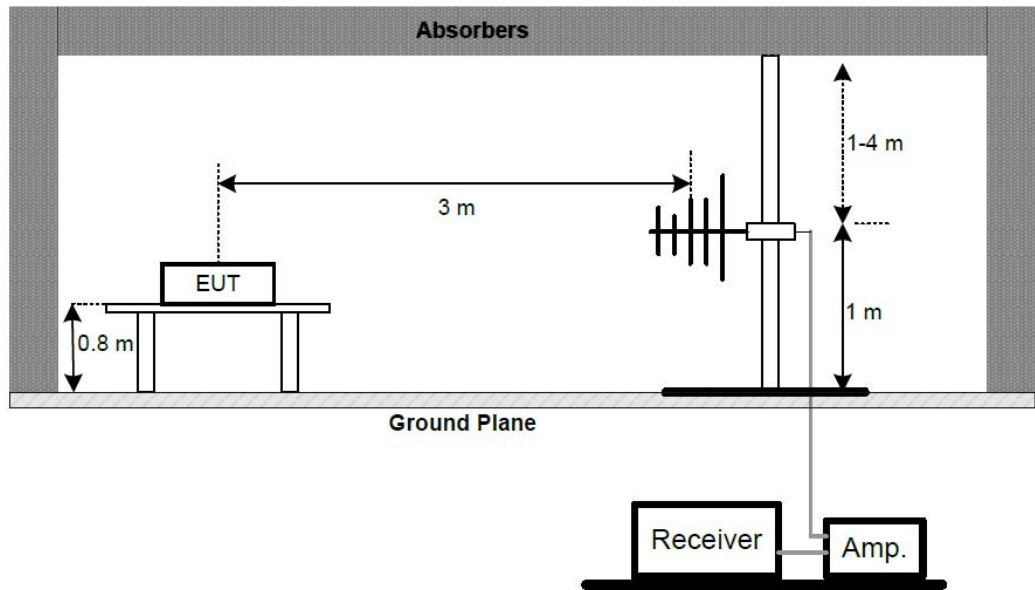

Above 1GHz:

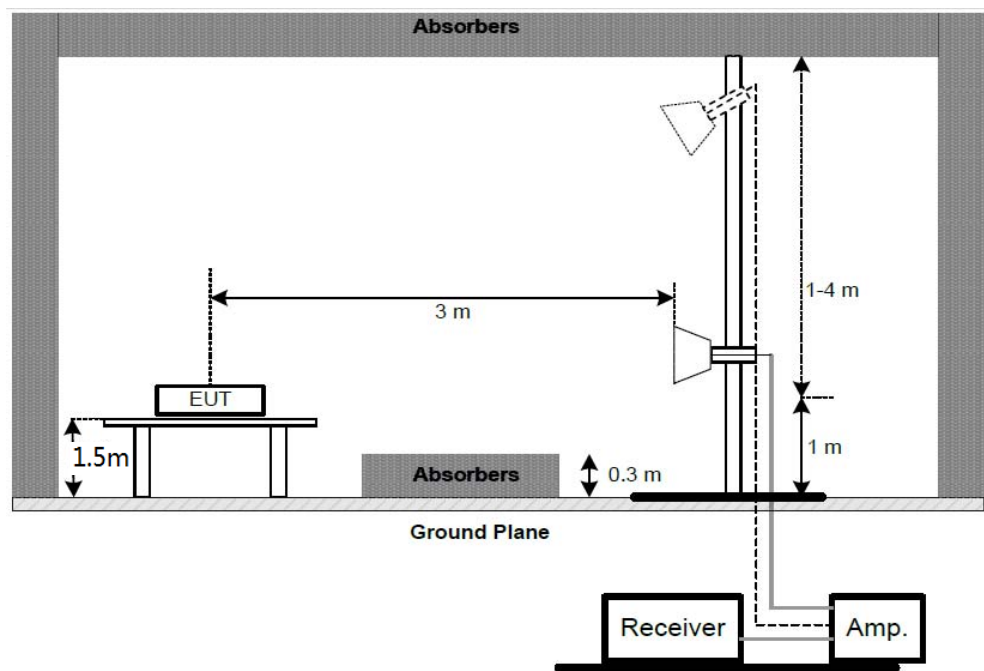

10.2.The Limit For Section 15.247(d)

Section 15.247(d): In any 100 kHz bandwidth outside the frequency band in which the spread spectrum or digitally modulated intentional radiator is operating, the radio frequency power that is produced by the intentional radiator shall be at least 20 dB below that in the 100 kHz bandwidth within the band that contains the highest level of the desired power, based on either an RF conducted or a radiated measurement, provided the transmitter demonstrates compliance with the peak conducted power limits. If the transmitter complies with the conducted power limits based on the use of RMS averaging over a time interval, as permitted under paragraph (b)(3) of this section, the attenuation required under this paragraph shall be 30 dB instead of 20 dB. Attenuation below the general limits specified in Section 15.209(a) is not required. In addition, radiated emissions which fall in the restricted bands, as defined in Section 15.205(a), must also comply with the radiated emission limits specified in Section 15.209(a).

10.3.Restricted bands of operation

10.3.1.FCC Part 15.205 Restricted bands of operation

(a) Except as shown in paragraph (d) of this section, Only spurious emissions are permitted in any of the frequency bands listed below:

MHz	MHz	MHz	GHz
0.090-0.110	16.42-16.423	399.9-410	4.5-5.15
¹ 0.495-0.505	16.69475-16.69525	608-614	5.35-5.46
2.1735-2.1905	16.80425-16.80475	960-1240	7.25-7.75
4.125-4.128	25.5-25.67	1300-1427	8.025-8.5
4.17725-4.17775	37.5-38.25	1435-1626.5	9.0-9.2
4.20725-4.20775	73-74.6	1645.5-1646.5	9.3-9.5
6.215-6.218	74.8-75.2	1660-1710	10.6-12.7
6.26775-6.26825	108-121.94	1718.8-1722.2	13.25-13.4
6.31175-6.31225	123-138	2200-2300	14.47-14.5
8.291-8.294	149.9-150.05	2310-2390	15.35-16.2
8.362-8.366	156.52475-156.52525	2483.5-2500	17.7-21.4
8.37625-8.38675	156.7-156.9	2690-2900	22.01-23.12
8.41425-8.41475	162.0125-167.17	3260-3267	23.6-24.0
12.29-12.293	167.72-173.2	3332-3339	31.2-31.8
12.51975-12.52025	240-285	3345.8-3358	36.43-36.5
12.57675-12.57725	322-335.4	3600-4400	(²)
13.36-13.41			

¹Until February 1, 1999, this restricted band shall be 0.490-0.510

²Above 38.6

(b) Except as provided in paragraphs (d) and (e), the field strength of emission appearing within these frequency bands shall not exceed the limits shown in Section 15.209. At frequencies equal to or less than 1000MHz, Compliance with the limits in Section 15.209 shall be demonstrated using measurement instrumentation employing a CISPR quasi-peak detector. Above 1000MHz, compliance with the emission limits in Section 15.209 shall be demonstrated based on the average value of the measured emissions. The provisions in Section

15.35 apply to these measurements.

10.4. Configuration of EUT on Measurement

The equipment are installed on Radiated Emission Measurement to meet the commission requirements and operating regulations in a manner which tends to maximize its emission characteristics in normal application.

10.5. Operating Condition of EUT

10.5.1. Setup the EUT and simulator as shown as Section 10.1.

10.5.2. Turn on the power of all equipment.

10.5.3. Let the EUT work in TX modes measure it. The transmit frequency range are 2412-2462MHz and 2422-2452MHz . We select three frequencies of high, medium and low in each frequency band for testing.

10.6. Test Procedure

The EUT and its simulators are placed on a turntable, which is 0.8 meter high above ground(Below 1GHz). The EUT and its simulators are placed on a turntable, which is 1.5 meter high above ground(Above 1GHz). The turntable can rotate 360 degrees to determine the position of the maximum emission level. EUT is set 3.0 meters away from the receiving antenna, which is mounted on an antenna tower. The antenna can be moved up and down between 1.0 meter and 4 meters to find out the maximum emission level. Broadband antenna (calibrated bi-log antenna) is used as receiving antenna. Both horizontal and vertical polarizations of the antenna are set on measurement. In order to find the maximum emission levels, all of the EUT location must be manipulated according to ANSI C63.10:2013 on radiated emission measurement. The EUT was tested in 3 orthogonal planes.

The worst-case data rate for this channel to be 1Mbps for 802.11b mode and 6Mbps for 802.11g mode and 150Mbps for 802.11n mode, based on previous with 802.11 WLAN product design architectures.

The frequency range from 30MHz to 25000MHz is checked.

Result = Reading + Corrected Factor

Where Corrected Factor = Antenna Factor + Cable Loss – Amplifier Gain

During the radiated emission test, the spectrum analyzer was set with the following configurations:

1. The resolution bandwidth and video bandwidth of test receiver/spectrum analyzer is 120kHz for Quasi-peak at frequency below 1GHz.
2. The resolution bandwidth of test receiver/spectrum analyzer is 1MHz and video bandwidth is 3MHz for peak measurement with peak detector at frequency above 1GHz.
3. The resolution bandwidth of test receiver/spectrum analyzer is 1MHz and video bandwidth is 10Hz for Average measurement with peak detection at frequency above 1GHz.

4. All modes of operation were investigated and the worst-case emissions are reported.

10.7. The Field Strength of Radiation Emission Measurement Results

Note: 1. Emissions attenuated more than 20 dB below the permissible value are not reported.

2. *: Denotes restricted band of operation.

3. The EUT is tested radiation emission at each test mode (802.11b/g/n) in three axes. The worst emissions are reflected in the following plots.

4. The radiation emissions from 18-25GHz are not reported, because the test values lower than the limits of 20dB

5. The average measurement was not performed when peak measured data under the limit of average detection.

Below 1G



ACCURATE TECHNOLOGY CO., LTD.

F1,Bldg,A,Changyuan New Material Port Keyuan Rd,
Science & Industry Park,Nanshan Shenzhen,P.R.China

Site: 2# Chamber
Tel:+86-0755-26503290
Fax:+86-0755-26503396

Job No.: BR10 #3	Polarization: Horizontal
Standard: FCC Class B 3M Radiated	Power Source: AC 120V/60Hz
Test item: Radiation Test	Date: 2020/01/16/
Temp.(C)/Hum.(%) 25 C / 55 %	Time: 9/53/57
EUT: LED bulb	Engineer Signature: Ben
Mode: TX Chanel 1(802.11b)	Distance: 3m
Model: SM-BLBGU10	
Manufacturer: Hengdian Group Tospo Lighting Co., Ltd.	

Note: Report NO.:ATE20200065

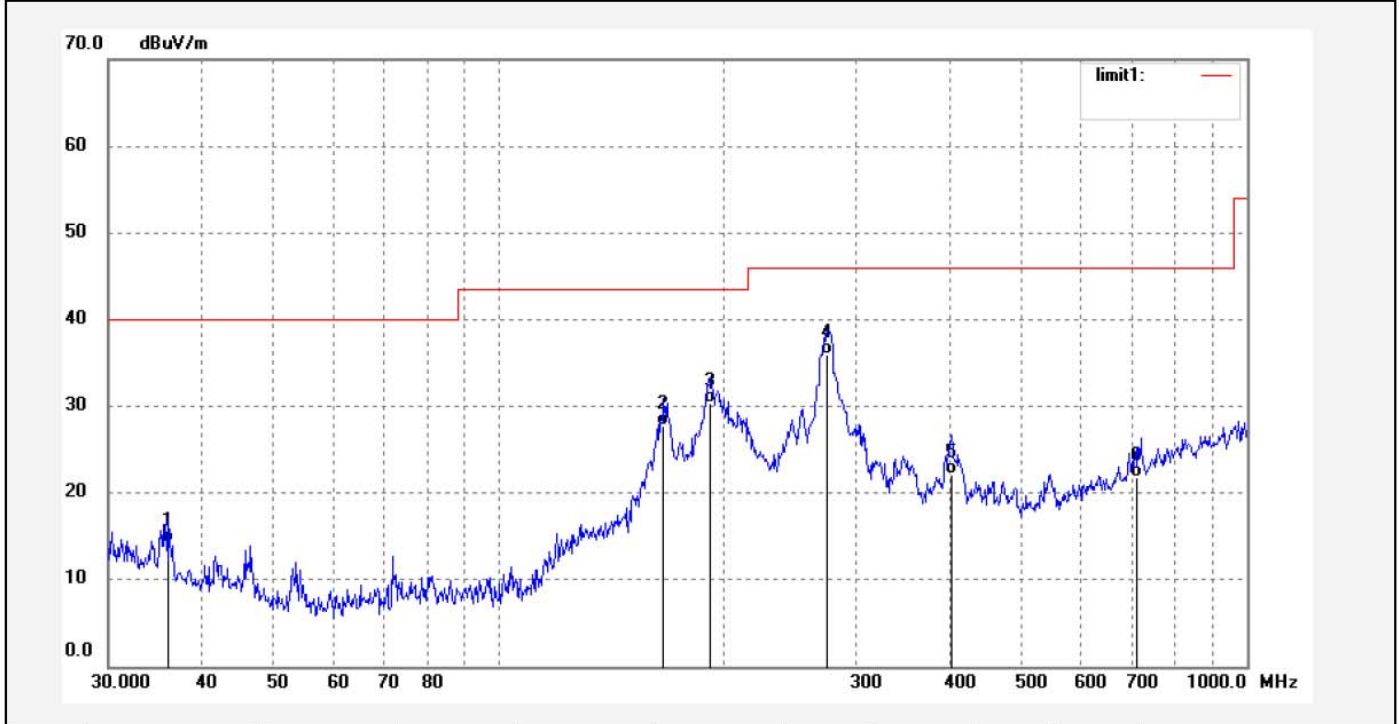

No.	Freq. (MHz)	Reading (dBuV/m)	Factor (dB)	Result (dBuV/m)	Limit (dBuV/m)	Margin (dB)	Detector	Height (cm)	Degree (deg.)	Remark
1	36.1405	36.15	-21.95	14.20	40.00	-25.80	QP	200	198	
2	166.0540	54.22	-26.42	27.80	43.50	-15.70	QP	200	163	
3	191.1114	55.31	-25.01	30.30	43.50	-13.20	QP	200	123	
4	274.4463	58.32	-22.42	35.90	46.00	-10.10	QP	200	102	
5	403.9334	40.33	-18.23	22.10	46.00	-23.90	QP	200	245	
6	708.6941	33.07	-11.27	21.80	46.00	-24.20	QP	200	315	

Job No.: BR10 #4

Standard: FCC Class B 3M Radiated

Test item: Radiation Test

Temp.(C)/Hum.(%) 25 C / 55 %

EUT: LED bulb

Mode: TX Chanel 1(802.11b)

Model: SM-BLBGU10

Manufacturer: Hengdian Group Tospo Lighting Co., Ltd.

Polarization: Vertical

Power Source: AC 120V/60Hz

Date: 2020/01/16/

Time: 9/54/40

Engineer Signature: Ben

Distance: 3m

Note: Report NO.:ATE20200065

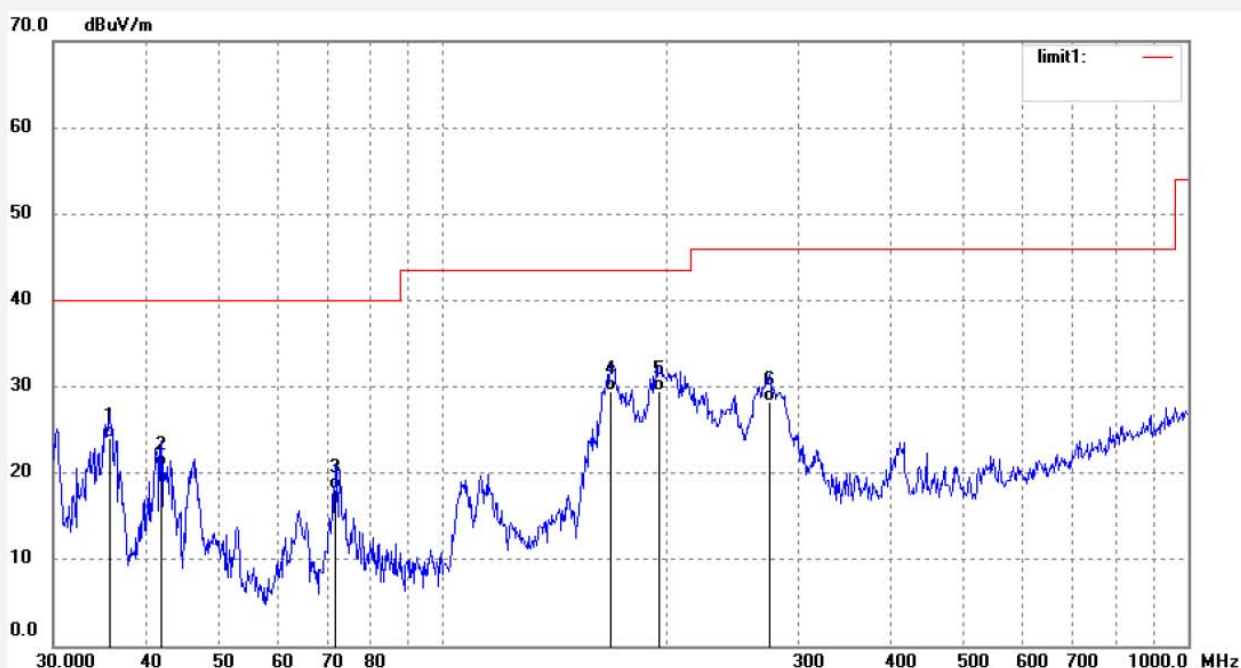

No.	Freq. (MHz)	Reading (dBuV/m)	Factor (dB)	Result (dBuV/m)	Limit (dBuV/m)	Margin (dB)	Detector	Height (cm)	Degree (deg.)	Remark
1	35.7616	45.77	-21.77	24.00	40.00	-16.00	QP	100	215	
2	41.8875	44.61	-23.91	20.70	40.00	-19.30	QP	100	347	
3	71.7052	45.66	-27.56	18.10	40.00	-21.90	QP	100	296	
4	167.8136	55.73	-26.23	29.50	43.50	-14.00	QP	100	198	
5	195.1828	54.12	-24.62	29.50	43.50	-14.00	QP	100	163	
6	274.4463	50.72	-22.42	28.30	46.00	-17.70	QP	100	105	

Job No.: BR10 #6

Standard: FCC Class B 3M Radiated

Test item: Radiation Test

Temp.(C)/Hum.(%) 25 C / 55 %

EUT: LED bulb

Mode: TX Chanel 6(802.11b)

Model: SM-BLBGU10

Manufacturer: Hengdian Group Tospo Lighting Co., Ltd.

Polarization: Horizontal

Power Source: AC 120V/60Hz

Date: 2020/01/16/

Time: 9/57/04

Engineer Signature: Ben

Distance: 3m

Note: Report NO.:ATE20200065

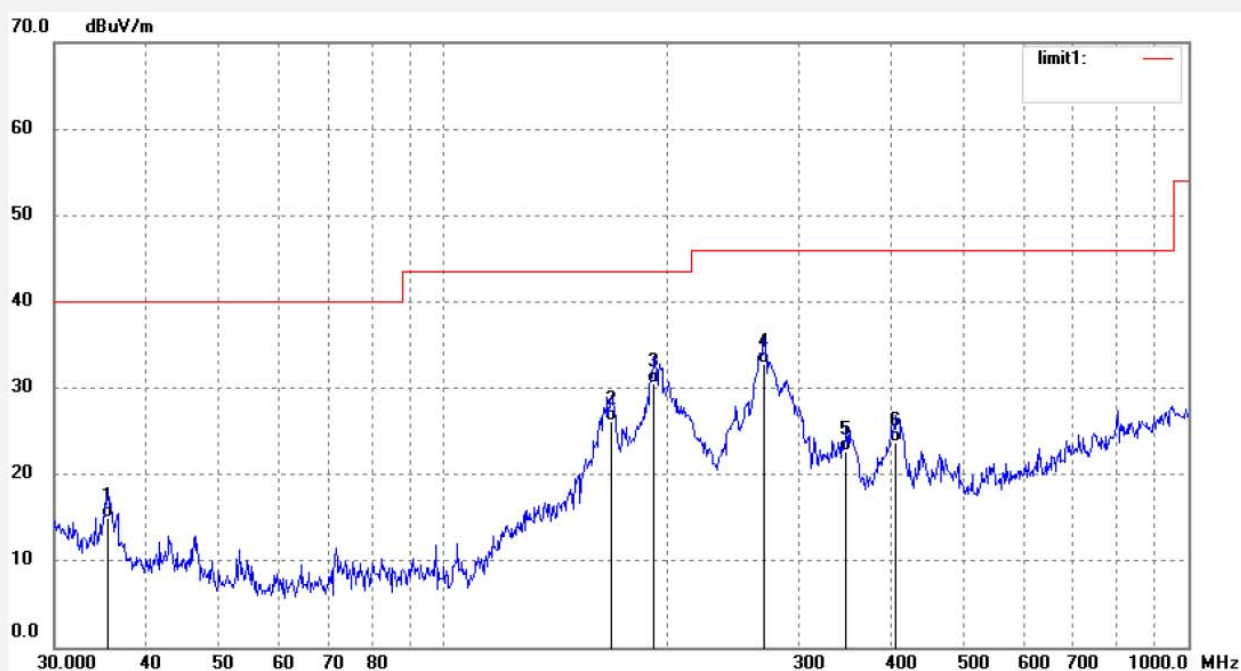

No.	Freq. (MHz)	Reading (dBuV/m)	Factor (dB)	Result (dBuV/m)	Limit (dBuV/m)	Margin (dB)	Detector	Height (cm)	Degree (deg.)	Remark
1	35.3866	36.62	-21.62	15.00	40.00	-25.00	QP	200	345	
2	167.8136	52.33	-26.23	26.10	43.50	-17.40	QP	200	186	
3	191.7840	55.55	-24.95	30.60	43.50	-12.90	QP	200	153	
4	269.6669	55.37	-22.57	32.80	46.00	-13.20	QP	200	109	
5	347.2921	42.02	-19.42	22.60	46.00	-23.40	QP	200	296	
6	405.3551	42.02	-18.22	23.80	46.00	-22.20	QP	200	215	

Job No.: BR10 #5 Standard: FCC Class B 3M Radiated Test item: Radiation Test Temp.(C)/Hum.(%) 25 C / 55 % EUT: LED bulb Mode: TX Chanel 6(802.11b) Model: SM-BLBGU10 Manufacturer: Hengdian Group Tospo Lighting Co., Ltd.	Polarization: Vertical Power Source: AC 120V/60Hz Date: 2020/01/16/ Time: 9/55/31 Engineer Signature: Ben Distance: 3m
--	---

Note: Report NO.:ATE20200065

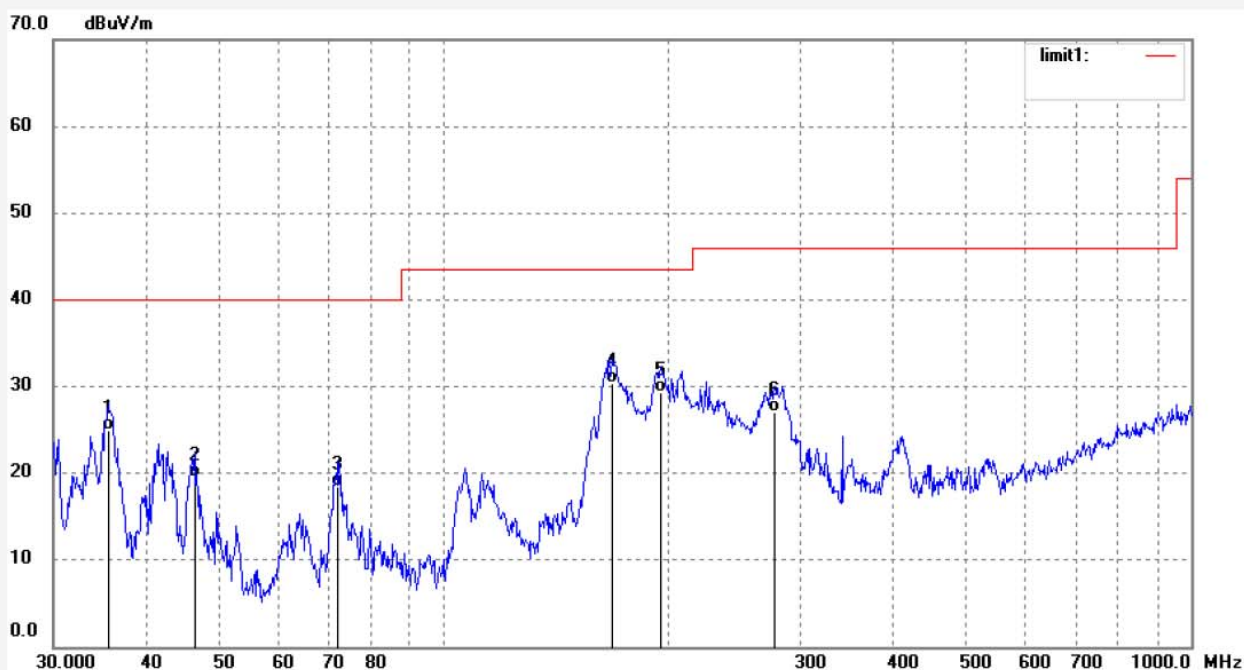

No.	Freq. (MHz)	Reading (dBuV/m)	Factor (dB)	Result (dBuV/m)	Limit (dBuV/m)	Margin (dB)	Detector	Height (cm)	Degree (deg.)	Remark
1	35.5112	46.66	-21.66	25.00	40.00	-15.00	QP	100	115	
2	46.3806	44.42	-24.92	19.50	40.00	-20.50	QP	100	136	
3	72.2111	46.08	-27.58	18.50	40.00	-21.50	QP	100	186	
4	167.8136	56.63	-26.23	30.40	43.50	-13.10	QP	100	202	
5	195.1830	53.92	-24.62	29.30	43.50	-14.20	QP	100	263	
6	277.3546	49.27	-22.27	27.00	46.00	-19.00	QP	100	298	

Job No.: BR10 #7

Standard: FCC Class B 3M Radiated

Test item: Radiation Test

Temp.(C)/Hum.(%) 25 C / 55 %

EUT: LED bulb

Mode: TX Chanel 11(802.11b)

Model: SM-BLBGU10

Manufacturer: Hengdian Group Tospo Lighting Co., Ltd.

Polarization: Horizontal

Power Source: AC 120V/60Hz

Date: 2020/01/16/

Time: 9/58/31

Engineer Signature: Ben

Distance: 3m

Note: Report NO.:ATE20200065

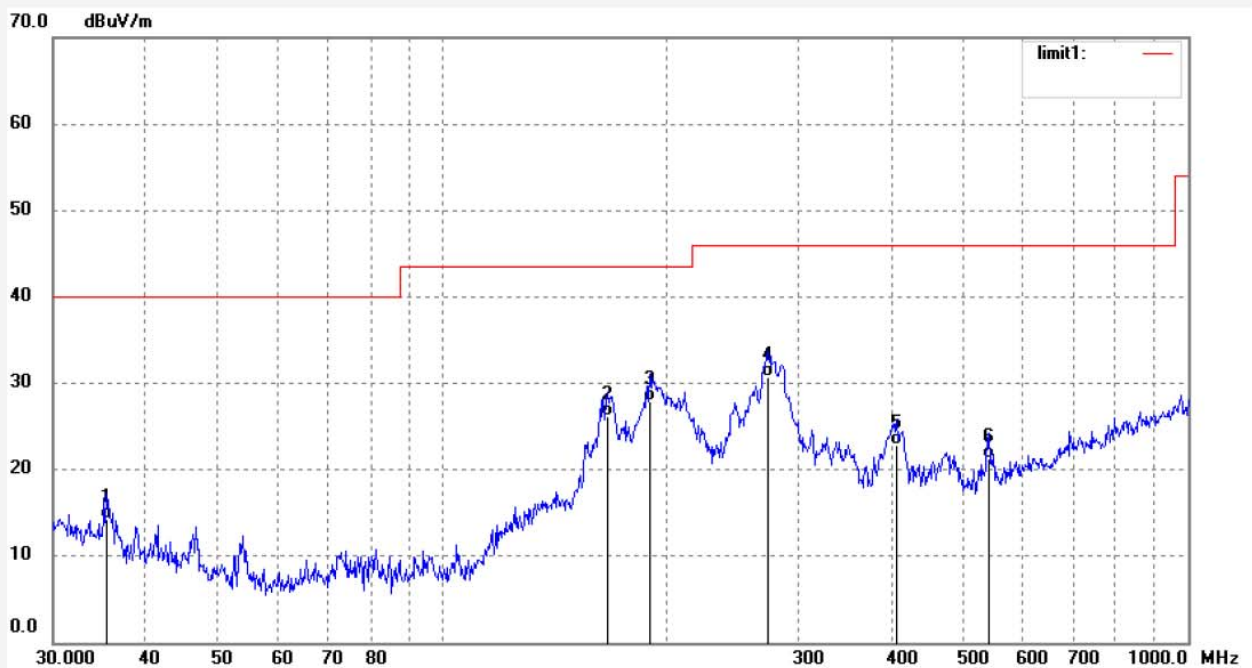

No.	Freq. (MHz)	Reading (dBuV/m)	Factor (dB)	Result (dBuV/m)	Limit (dBuV/m)	Margin (dB)	Detector	Height (cm)	Degree (deg.)	Remark
1	35.3866	35.82	-21.62	14.20	40.00	-25.80	QP	200	245	
2	166.6384	52.46	-26.36	26.10	43.50	-17.40	QP	200	195	
3	189.7732	53.14	-25.14	28.00	43.50	-15.50	QP	200	163	
4	273.4837	53.24	-22.44	30.80	46.00	-15.20	QP	200	125	
5	406.7819	40.99	-18.19	22.80	46.00	-23.20	QP	200	296	
6	540.7071	36.29	-15.09	21.20	46.00	-24.80	QP	200	315	

Job No.: BR10 #8	Polarization: Vertical
Standard: FCC Class B 3M Radiated	Power Source: AC 120V/60Hz
Test item: Radiation Test	Date: 2020/01/16/
Temp.(C)/Hum.(%) 25 C / 55 %	Time: 9/59/11
EUT: LED bulb	Engineer Signature: Ben
Mode: TX Chanel 11(802.11b)	Distance: 3m
Model: SM-BLBGU10	
Manufacturer: Hengdian Group Tospo Lighting Co., Ltd.	

Note: Report NO.:ATE20200065

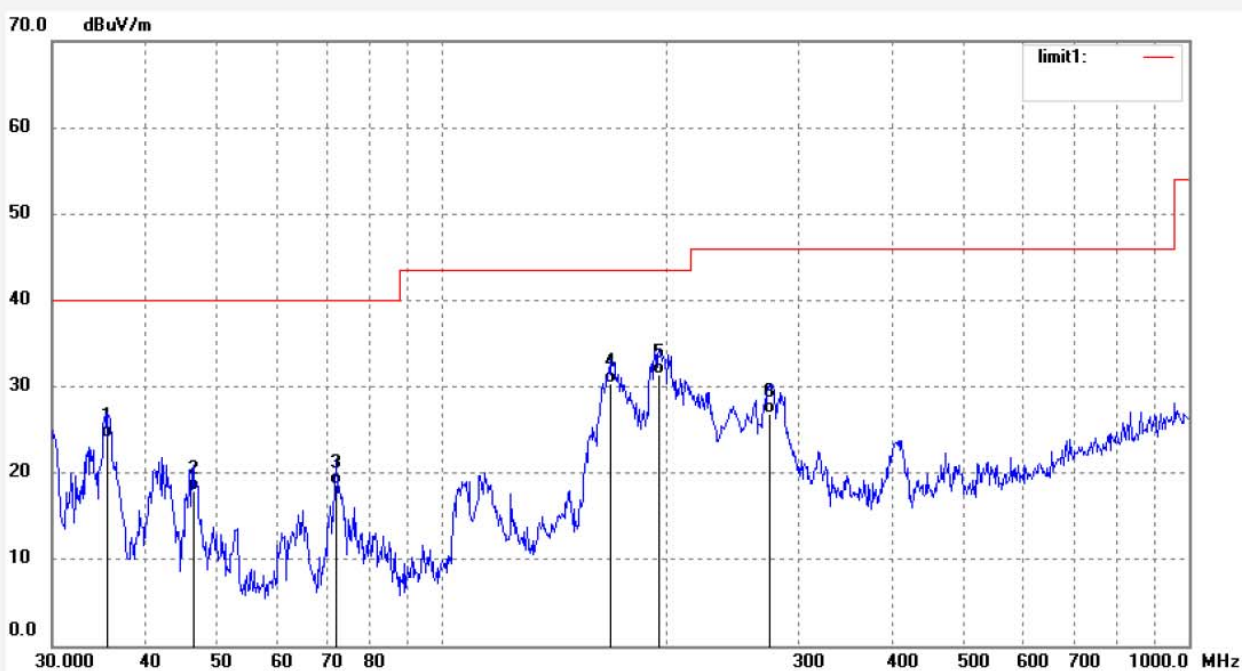

No.	Freq. (MHz)	Reading (dBuV/m)	Factor (dB)	Result (dBuV/m)	Limit (dBuV/m)	Margin (dB)	Detector	Height (cm)	Degree (deg.)	Remark
1	35.6362	45.72	-21.72	24.00	40.00	-16.00	QP	100	118	
2	46.3806	42.82	-24.92	17.90	40.00	-22.10	QP	100	163	
3	71.9578	46.17	-27.57	18.60	40.00	-21.40	QP	100	196	
4	168.4043	56.47	-26.17	30.30	43.50	-13.20	QP	100	215	
5	195.1828	56.12	-24.62	31.50	43.50	-12.00	QP	100	263	
6	273.4836	49.24	-22.44	26.80	46.00	-19.20	QP	100	302	

Above 1G

ACCURATE TECHNOLOGY CO., LTD.

 F1,Bldg.A,Changyuan New Material Port Keyuan Rd,
 Science & Industry Park,Nanshan Shenzhen,P.R.China

Site: 2# Chamber

Tel:+86-0755-26503290

Fax:+86-0755-26503396

Job No.: br #13	Polarization: Horizontal
Standard: FCC PK	Power Source: AC 120V/60Hz
Test item: Radiation Test	Date: 2020/02/28/
Temp.(C)/Hum.(%) 23 C / 48 %	Time: 11/36/15
EUT: LED bulb	Engineer Signature: Ben
Mode: TX Chanel 1(802.11b)	Distance: 3m
Model: SM-BLBGU10	
Manufacturer: Hengdian Group Tospo Lighting Co., Ltd.	

Note: Report NO.:ATE20200065

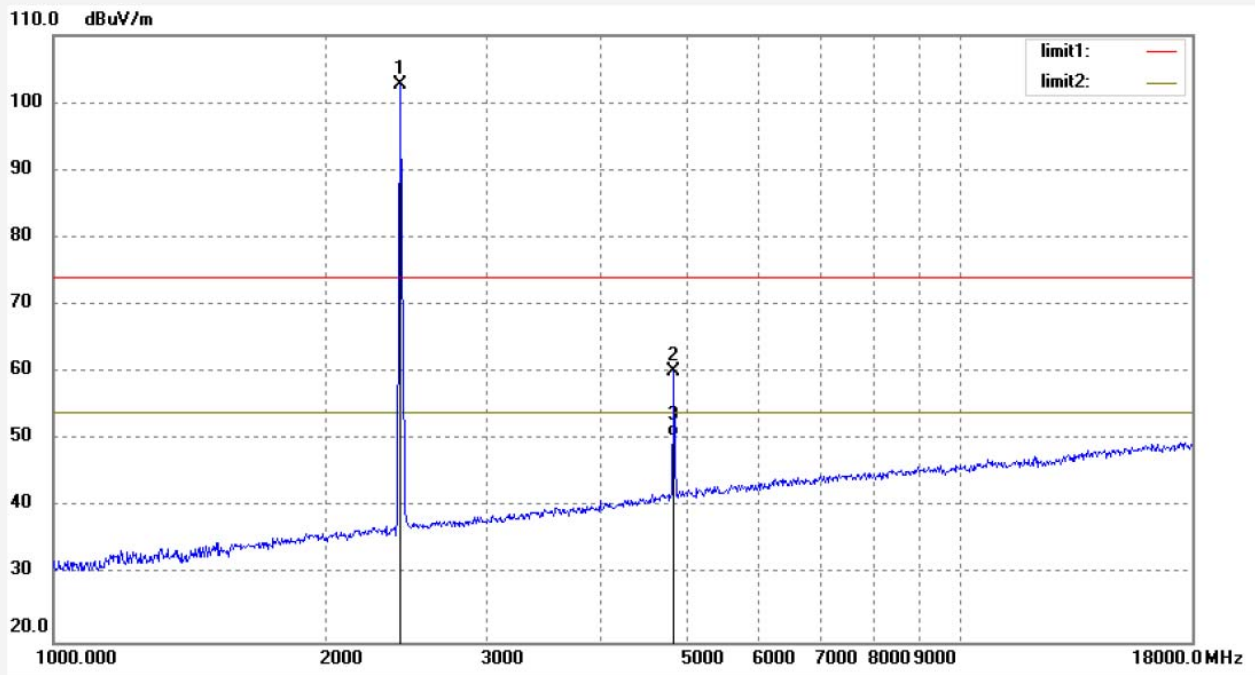

No.	Freq. (MHz)	Reading (dBuV/m)	Factor (dB)	Result (dBuV/m)	Limit (dBuV/m)	Margin (dB)	Detector	Height (cm)	Degree (deg.)	Remark
1	2412.000	101.75	0.93	102.68			peak	200	145	
2	4824.000	52.51	7.58	60.09	74.00	-13.91	peak	200	196	
3	4824.000	43.02	7.58	50.60	54.00	-3.40	AVG	200	263	

Job No.: br #14

Standard: FCC PK

Test item: Radiation Test

Temp.(C)/Hum.(%) 23 C / 48 %

EUT: LED bulb

Mode: TX Chanel 1(802.11b)

Model: SM-BLBGU10

Manufacturer: Hengdian Group Tospo Lighting Co., Ltd.

Polarization: Vertical

Power Source: AC 120V/60Hz

Date: 2020/02/28/

Time: 11/38/51

Engineer Signature: Ben

Distance: 3m

Note: Report NO.:ATE20200065

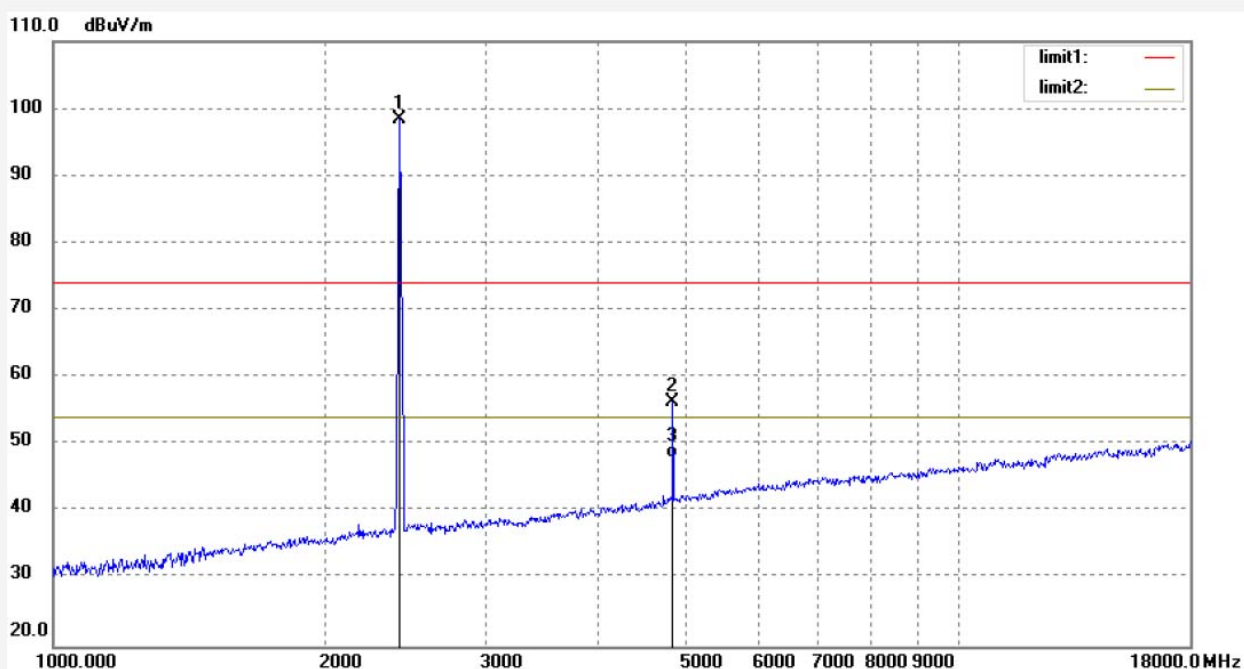

No.	Freq. (MHz)	Reading (dBuV/m)	Factor (dB)	Result (dBuV/m)	Limit (dBuV/m)	Margin (dB)	Detector	Height (cm)	Degree (deg.)	Remark
1	2412.000	97.50	0.93	98.43			peak	150	136	
2	4824.000	48.86	7.58	56.44	74.00	-17.56	peak	150	175	
3	4824.000	40.52	7.58	48.10	54.00	-5.90	AVG	150	263	

Job No.: br #16

Standard: FCC PK

Test item: Radiation Test

Temp.(C)/Hum.(%) 23 C / 48 %

EUT: LED bulb

Mode: TX Chanel 6(802.11b)

Model: SM-BLBGU10

Manufacturer: Hengdian Group Tospo Lighting Co., Ltd.

Polarization: Horizontal

Power Source: AC 120V/60Hz

Date: 2020/02/28/

Time: 11/42/54

Engineer Signature: Ben

Distance: 3m

Note: Report NO.:ATE20200065

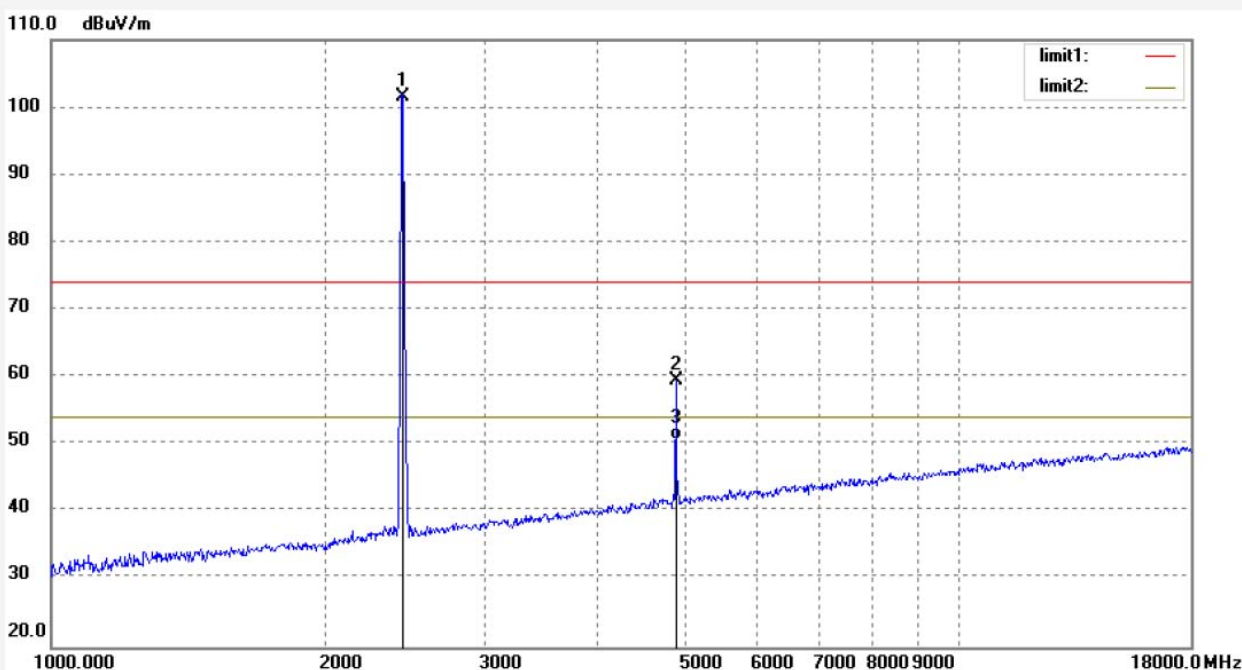

No.	Freq. (MHz)	Reading (dBuV/m)	Factor (dB)	Result (dBuV/m)	Limit (dBuV/m)	Margin (dB)	Detector	Height (cm)	Degree (deg.)	Remark
1	2437.000	100.61	1.04	101.65			peak			
2	4874.000	51.55	8.04	59.59	74.00	-14.41	peak			
3	4874.000	42.76	8.04	50.80	54.00	-3.20	AVG			



ACCURATE TECHNOLOGY CO., LTD.

F1,Bldg,A,Changyuan New Material Port Keyuan Rd,
Science & Industry Park,Nanshan Shenzhen,P.R.China

Site: 2# Chamber

Tel:+86-0755-26503290

Fax:+86-0755-26503396

Job No.: br #15

Standard: FCC PK

Test item: Radiation Test

Temp.(C)/Hum.(%) 23 C / 48 %

EUT: LED bulb

Mode: TX Chanel 6(802.11b)

Model: SM-BLBGU10

Manufacturer: Hengdian Group Tospo Lighting Co., Ltd.

Polarization: Vertical

Power Source: AC 120V/60Hz

Date: 2020/02/28/

Time: 11/40/45

Engineer Signature: Ben

Distance: 3m

Note: Report NO.:ATE20200065

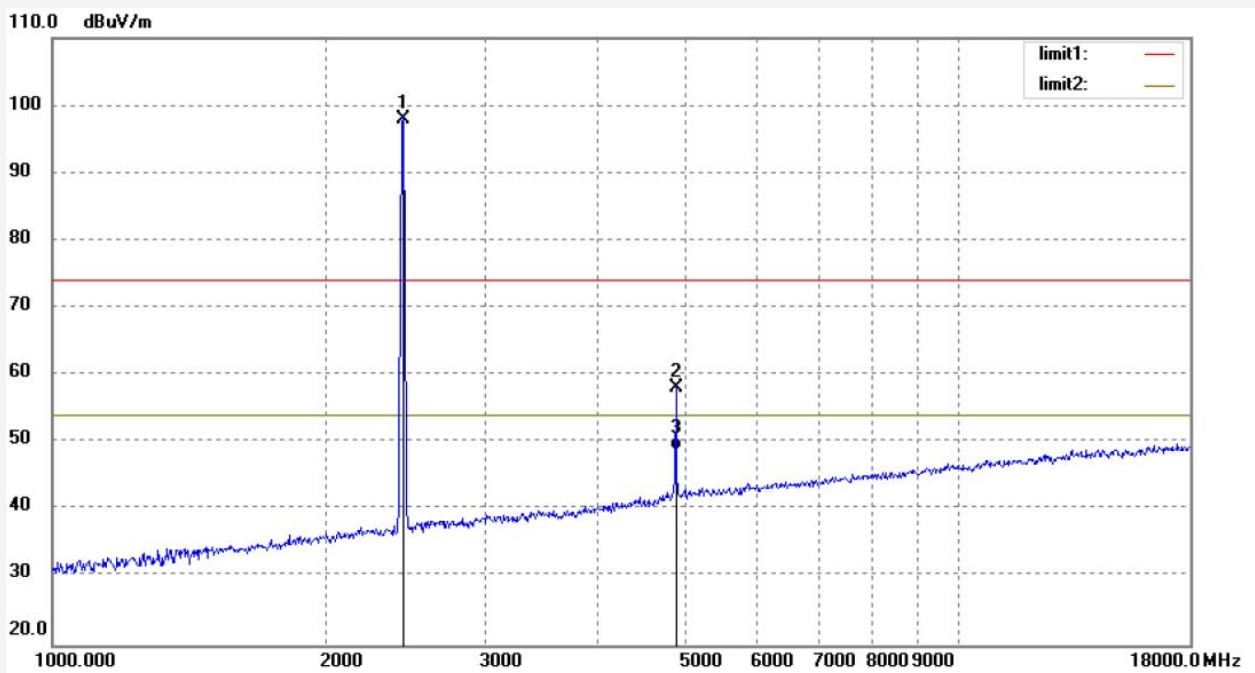

No.	Freq. (MHz)	Reading (dBuV/m)	Factor (dB)	Result (dBuV/m)	Limit (dBuV/m)	Margin (dB)	Detector	Height (cm)	Degree (deg.)	Remark
1	2437.000	96.96	1.04	98.00			peak	150	185	
2	4874.000	50.17	8.04	58.21	74.00	-15.79	peak	150	196	
3	4874.000	40.96	8.04	49.00	54.00	-5.00	AVG	150	265	

ACCURATE TECHNOLOGY CO., LTD.

 F1,Bldg,A,Changyuan New Material Port Keyuan Rd,
 Science & Industry Park,Nanshan Shenzhen,P.R.China

Site: 2# Chamber

Tel:+86-0755-26503290

Fax:+86-0755-26503396

Job No.: br #17

Standard: FCC PK

Test item: Radiation Test

Temp.(C)/Hum.(%) 23 C / 48 %

EUT: LED bulb

Mode: TX Chanel 11(802.11b)

Model: SM-BLBGU10

Manufacturer: Hengdian Group Tospo Lighting Co., Ltd.

Polarization: Horizontal

Power Source: AC 120V/60Hz

Date: 2020/02/28/

Time: 11/44/49

Engineer Signature: Ben

Distance: 3m

Note: Report NO.:ATE20200065

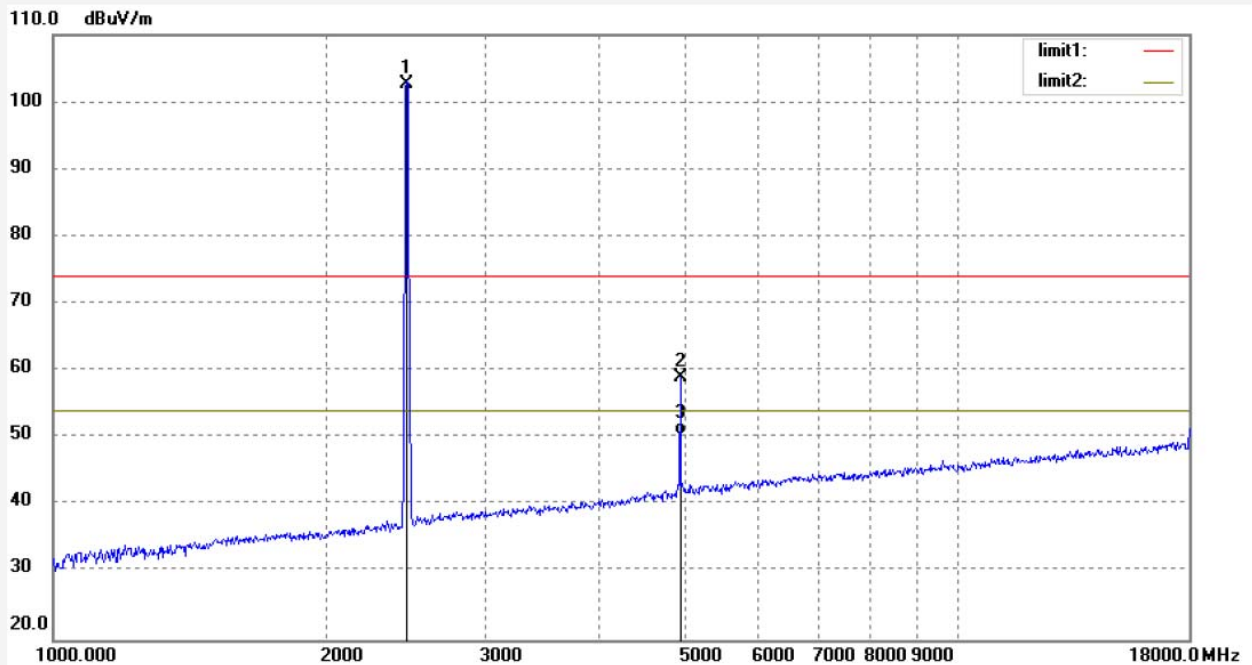

No.	Freq. (MHz)	Reading (dBuV/m)	Factor (dB)	Result (dBuV/m)	Limit (dBuV/m)	Margin (dB)	Detector	Height (cm)	Degree (deg.)	Remark
1	2462.000	101.71	1.09	102.80			peak	200	185	
2	4924.000	50.71	8.40	59.11	74.00	-14.89	peak	200	202	
3	4924.000	42.20	8.40	50.60	54.00	-3.40	AVG	200	296	

Job No.: br #18

Standard: FCC PK

Test item: Radiation Test

Temp.(C)/Hum.(%) 23 C / 48 %

EUT: LED bulb

Mode: TX Chanel 11(802.11b)

Model: SM-BLBGU10

Manufacturer: Hengdian Group Tospo Lighting Co., Ltd.

Polarization: Vertical

Power Source: AC 120V/60Hz

Date: 2020/02/28

Time: 11/46/56

Engineer Signature: Ben

Distance: 3m

Note: Report NO.:ATE20200065

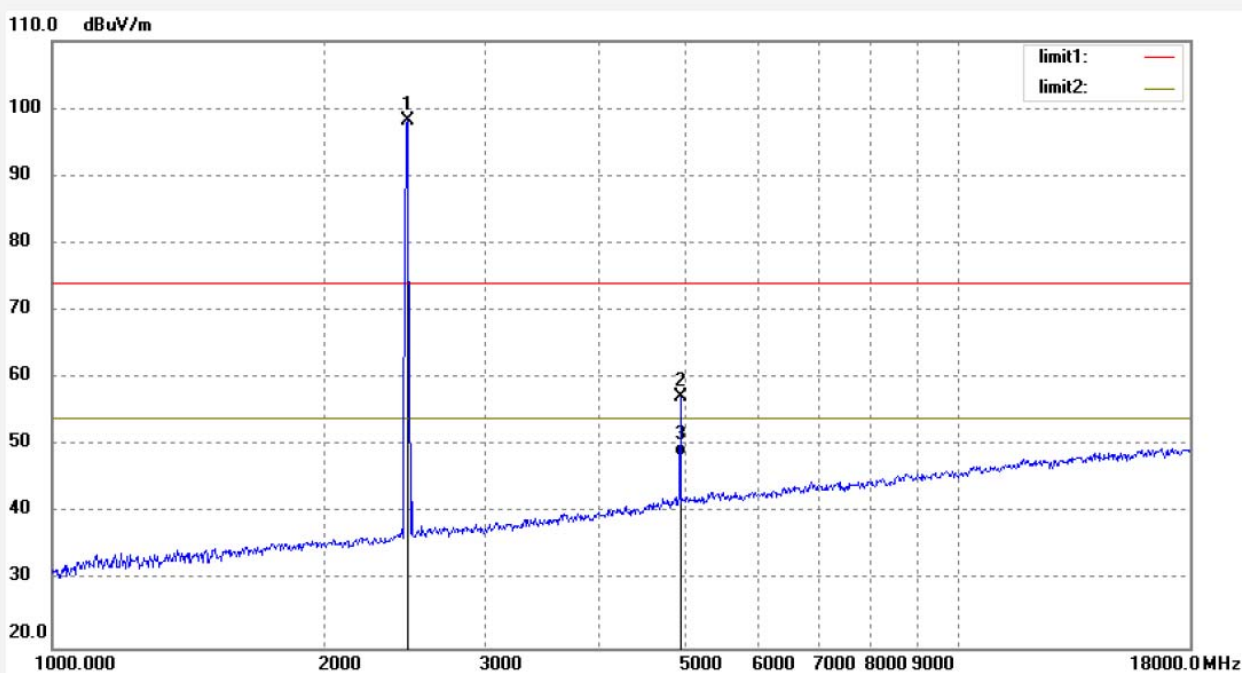

No.	Freq. (MHz)	Reading (dBuV/m)	Factor (dB)	Result (dBuV/m)	Limit (dBuV/m)	Margin (dB)	Detector	Height (cm)	Degree (deg.)	Remark
1	2462.000	97.21	1.09	98.30			peak	150	123	
2	4924.000	48.93	8.40	57.33	74.00	-16.67	peak	150	175	
3	4924.000	40.10	8.40	48.50	54.00	-5.50	AVG	150	263	

11. BAND EDGE COMPLIANCE TEST

11.1. Block Diagram of Test Setup



11.2. The Requirement For Section 15.247(d)

Section 15.247(d): In any 100 kHz bandwidth outside the frequency band in which the spread spectrum or digitally modulated intentional radiator is operating, the radio frequency power that is produced by the intentional radiator shall be at least 20 dB below that in the 100 kHz bandwidth within the band that contains the highest level of the desired power, based on either an RF conducted or a radiated measurement, provided the transmitter demonstrates compliance with the peak conducted power limits. If the transmitter complies with the conducted power limits based on the use of RMS averaging over a time interval, as permitted under paragraph (b)(3) of this section, the attenuation required under this paragraph shall be 30 dB instead of 20 dB. Attenuation below the general limits specified in Section 15.209(a) is not required. In addition, radiated emissions which fall in the restricted bands, as defined in Section 15.205(a), must also comply with the radiated emission limits specified in Section 15.209(a).

11.3. EUT Configuration on Measurement

The equipment are installed on the emission Measurement to meet the commission requirements and operating regulations in a manner which tends to maximize its emission characteristics in normal application.

11.4. Operating Condition of EUT

11.4.1. Setup the EUT and simulator as shown as Section 11.1.

11.4.2. Turn on the power of all equipment.

11.4.3. Let the EUT work in TX modes measure it. The transmit frequency range are 2412-2462MHz and 2422-2452MHz . We select three frequencies of high and low channel in each frequency band for testing.

11.5. Test Procedure

Conducted Band Edge:

11.5.1. The transmitter output was connected to the spectrum analyzer via a low loss cable.

11.5.2. Set RBW of spectrum analyzer to 100kHz and VBW to 300kHz.

Radiate Band Edge:

11.5.3. The EUT is placed on a turntable, which is 1.5m above the ground plane and worked at highest radiated power.

11.5.4. The turntable was rotated for 360 degrees to determine the position of maximum emission level.

11.5.5. EUT is set 3m away from the receiving antenna, which is varied from 1m to 4m to find out the highest emission.

11.5.6. Set the spectrum analyzer in the following setting in order to capture the lower and upper band-edges of the emission:

11.5.7. RBW=1MHz, VBW=1MHz

11.5.8. The band edges were measured and recorded.

11.6. Test Result

The test was performed with 802.11b		
Frequency (MHz)	Result of Band Edge (dBc)	Limit of Band Edge (dBc)
2400.0	48.55	> 20dBc
2483.5	48.57	> 20dBc

The test was performed with 802.11g		
Frequency (MHz)	Result of Band Edge (dBc)	Limit of Band Edge (dBc)
2400.0	30.92	> 20dBc
2483.5	41.68	> 20dBc

The test was performed with 802.11n (20MHz)		
Frequency (MHz)	Result of Band Edge (dBc)	Limit of Band Edge (dBc)
2400.0	32.21	> 20dBc
2500.0	41.64	> 20dBc

The test was performed with 802.11n (40MHz)		
Frequency (MHz)	Result of Band Edge (dBc)	Limit of Band Edge (dBc)
2400.0	31.36	> 20dBc
2483.5	36.00	> 20dBc

802.11b Low Channel 2412MHz

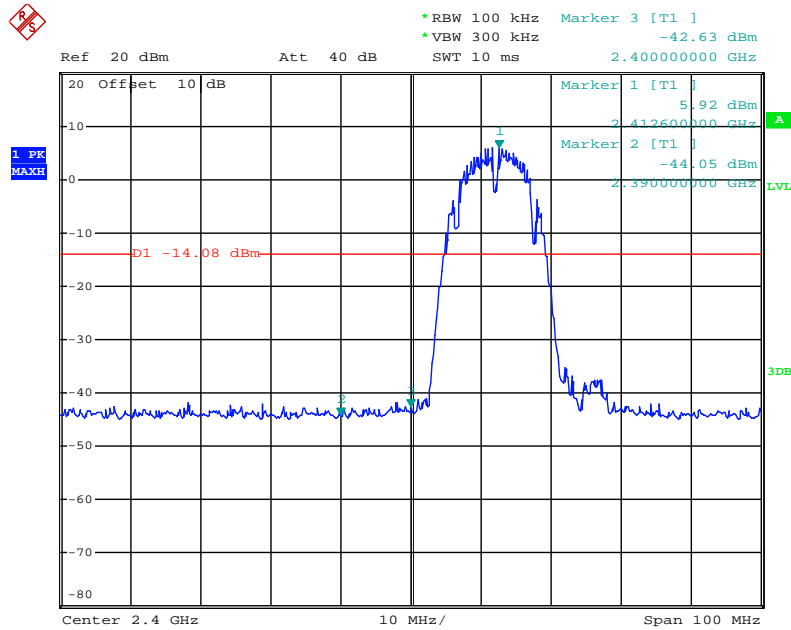

Date: 18.FEB.2020 09:15:50

802.11b High Channel 2462MHz

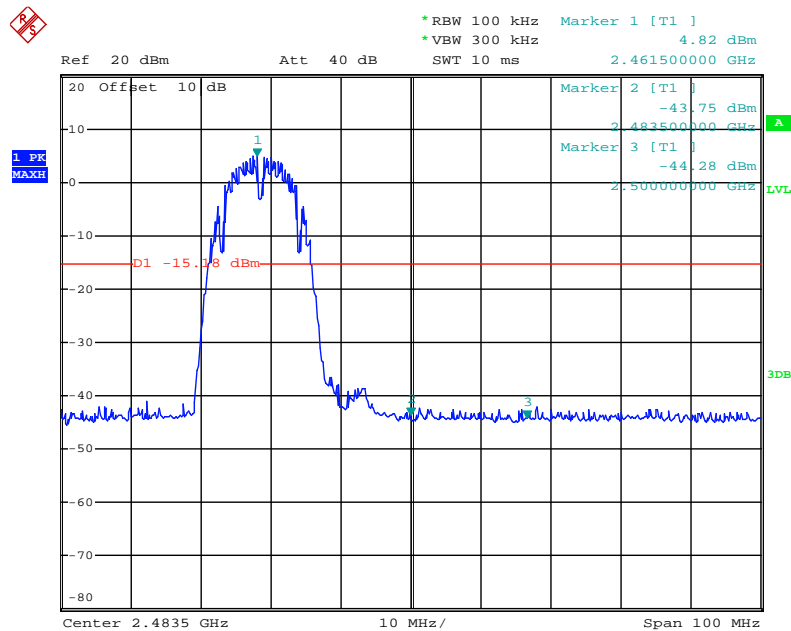

Date: 18.FEB.2020 09:26:08

802.11g Low Channel 2412MHz

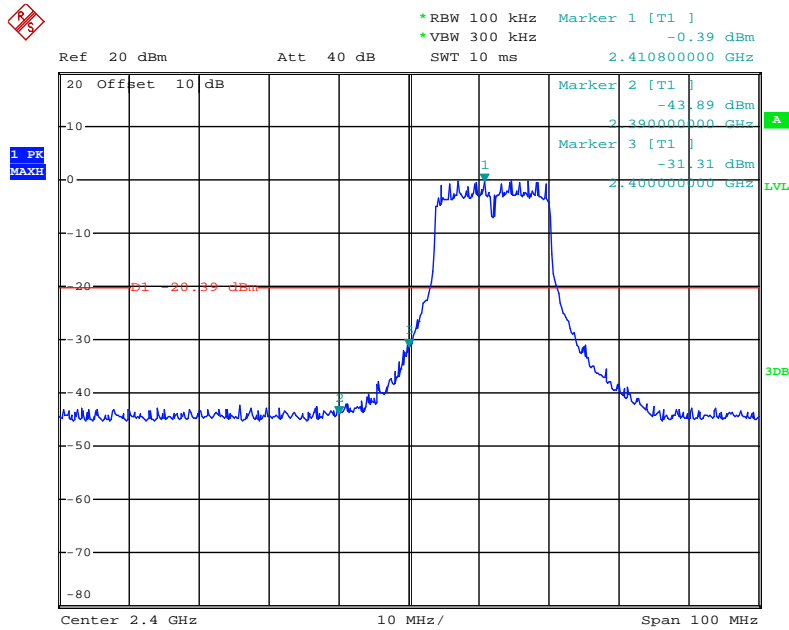

Date: 18.FEB.2020 09:16:52

802.11g High Channel 2462MHz

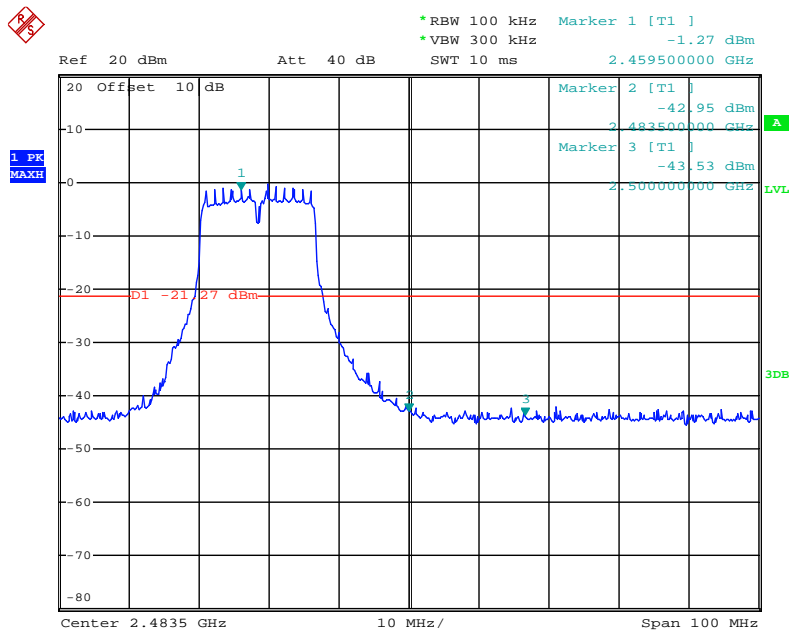

Date: 18.FEB.2020 09:41:48

802.11n(20MHz) Low Channel 2412MHz

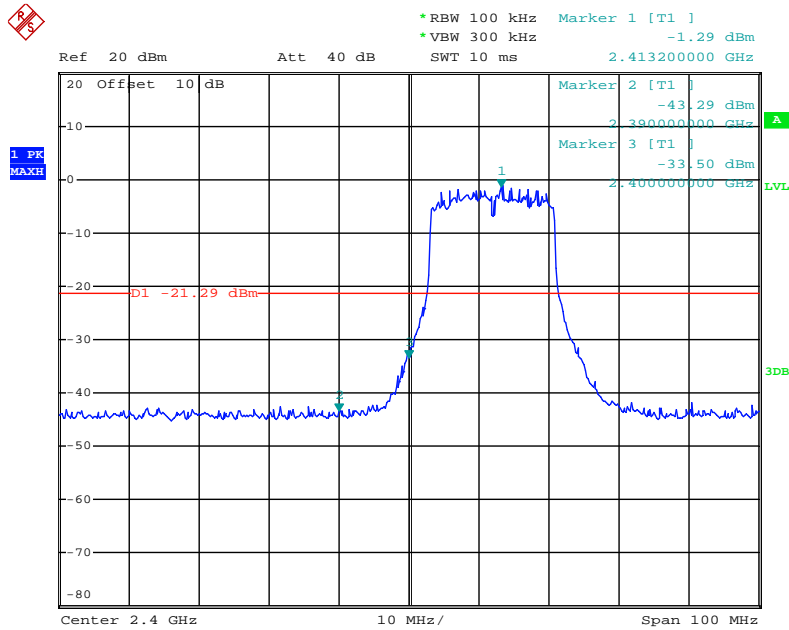

Date: 18.FEB.2020 09:18:26

802.11n(20MHz) High Channel 2462MHz

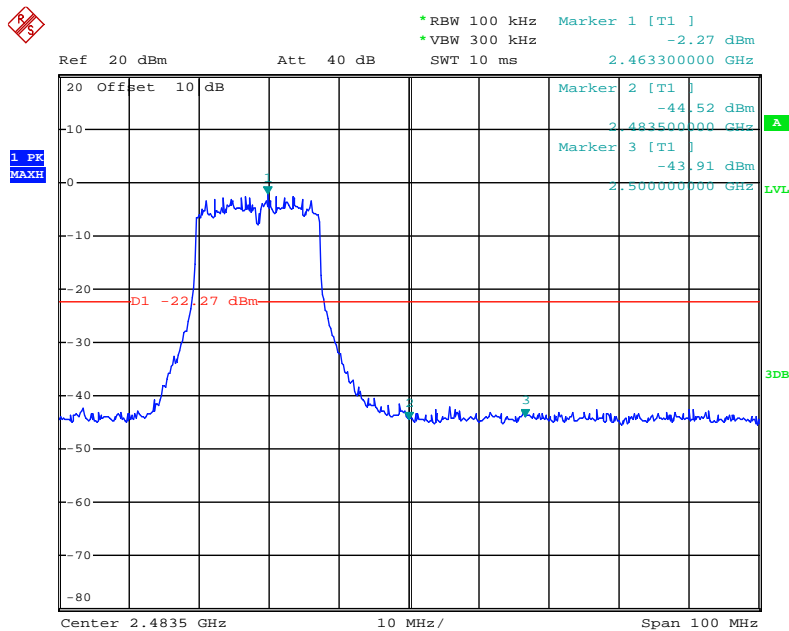

Date: 18.FEB.2020 09:38:50

802.11n(40MHz) Low Channel 2422MHz

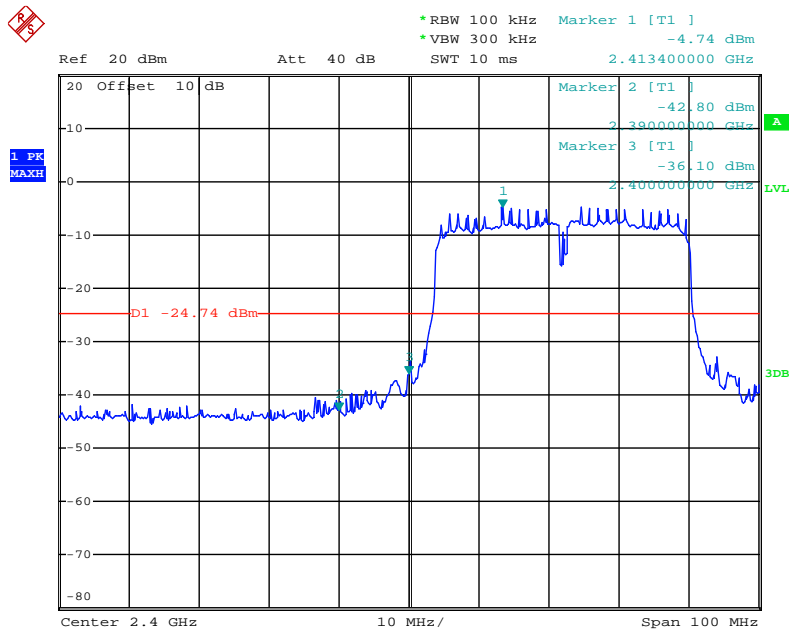

Date: 18.FEB.2020 09:20:17

802.11n(40MHz) High Channel 2452MHz

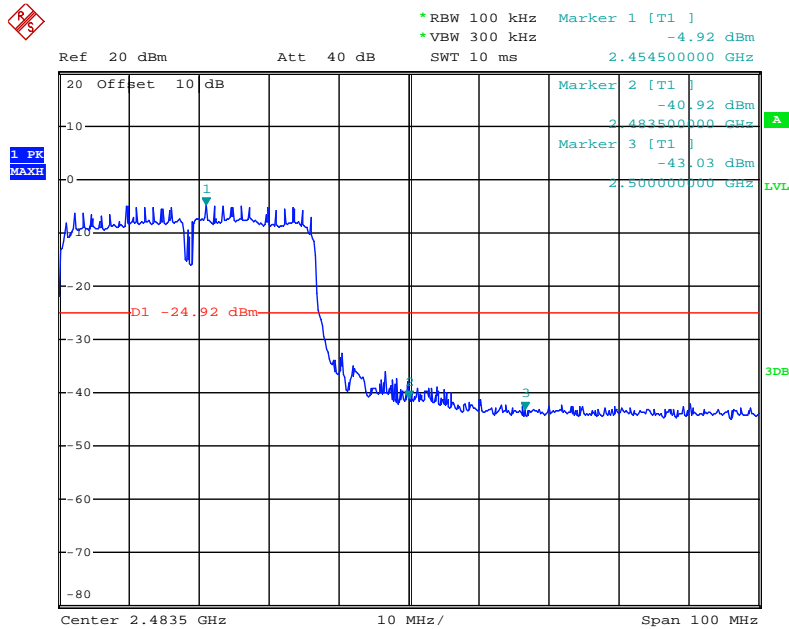

Date: 18.FEB.2020 09:23:16

Radiated Band Edge Result

Note:

1. Emissions attenuated more than 20 dB below the permissible value are not reported.
2. The field strength is calculated by adding the antenna factor, high pass filter loss(if used) and cable loss, and subtracting the amplifier gain(if any)from the measured reading. The basic equation calculation is as follows:
$$\text{Result} = \text{Reading} + \text{Corrected Factor}$$
3. Display the measurement of peak values.
4. The EUT is tested radiation emission at each test mode (802.11b/g/n) in three axes. The worst emissions are reflected in the following plots.
5. The average measurement was not performed when peak measured data under the limit of average detection.

Job No.: br #21

Standard: FCC PK

Test item: Radiation Test

Temp.(C)/Hum.(%) 23 C / 48 %

EUT: LED bulb

Mode: TX Chanel 1(802.11b)

Model: SM-BLBU10

Manufacturer: Hengdian Group Tospo Lighting Co., Ltd.

Polarization: Horizontal

Power Source: AC 120V/60Hz

Date: 2020/02/28/

Time: 11/54/58

Engineer Signature: Ben

Distance: 3m

Note: Report NO.:ATE20200065

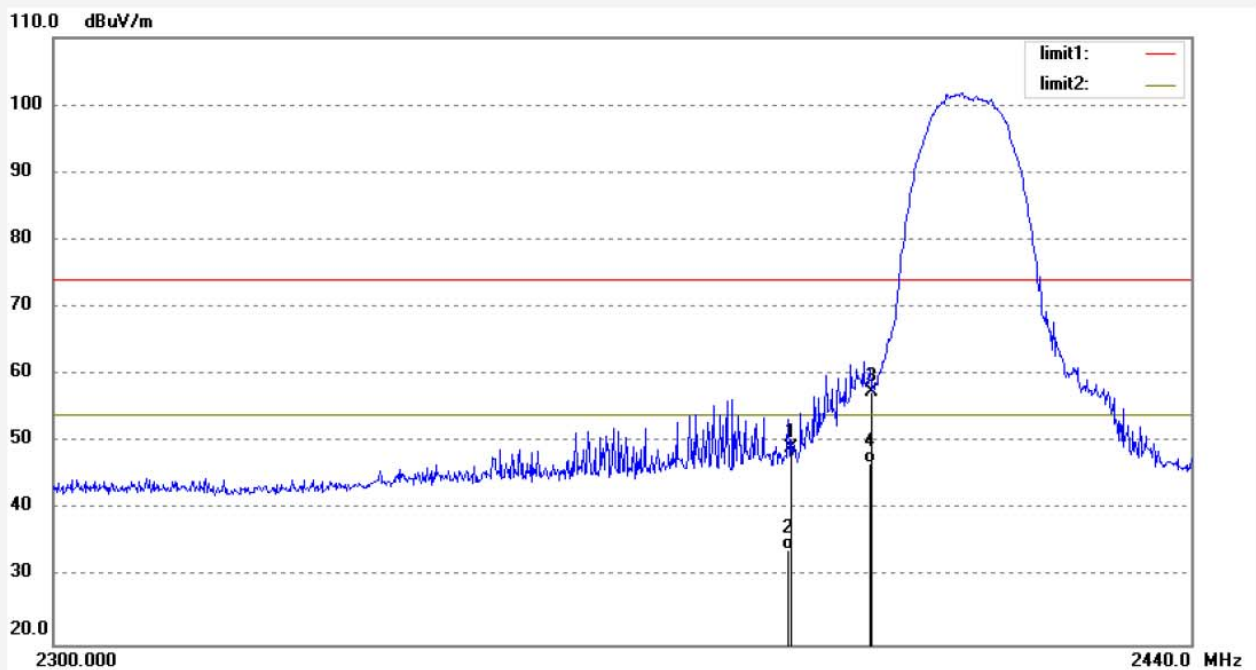

No.	Freq. (MHz)	Reading (dBuV/m)	Factor (dB)	Result (dBuV/m)	Limit (dBuV/m)	Margin (dB)	Detector	Height (cm)	Degree (deg.)	Remark
1	2390.000	48.31	0.79	49.10	74.00	-24.90	peak	200	145	
2	2390.000	33.31	0.79	34.10	54.00	-19.90	AVG	200	196	
3	2400.000	56.50	0.88	57.38	74.00	-16.62	peak	200	245	
4	2400.000	45.92	0.88	46.80	54.00	-7.20	AVG	200	278	

Job No.: br #22

Standard: FCC PK

Test item: Radiation Test

Temp.(C)/Hum.(%) 23 C / 48 %

EUT: LED bulb

Mode: TX Chanel 1(802.11b)

Model: SM-BLBGU10

Manufacturer: Hengdian Group Tospo Lighting Co., Ltd.

Polarization: Vertical

Power Source: AC 120V/60Hz

Date: 2020/02/28/

Time: 11/57/01

Engineer Signature: Ben

Distance: 3m

Note: Report NO.:ATE20200065

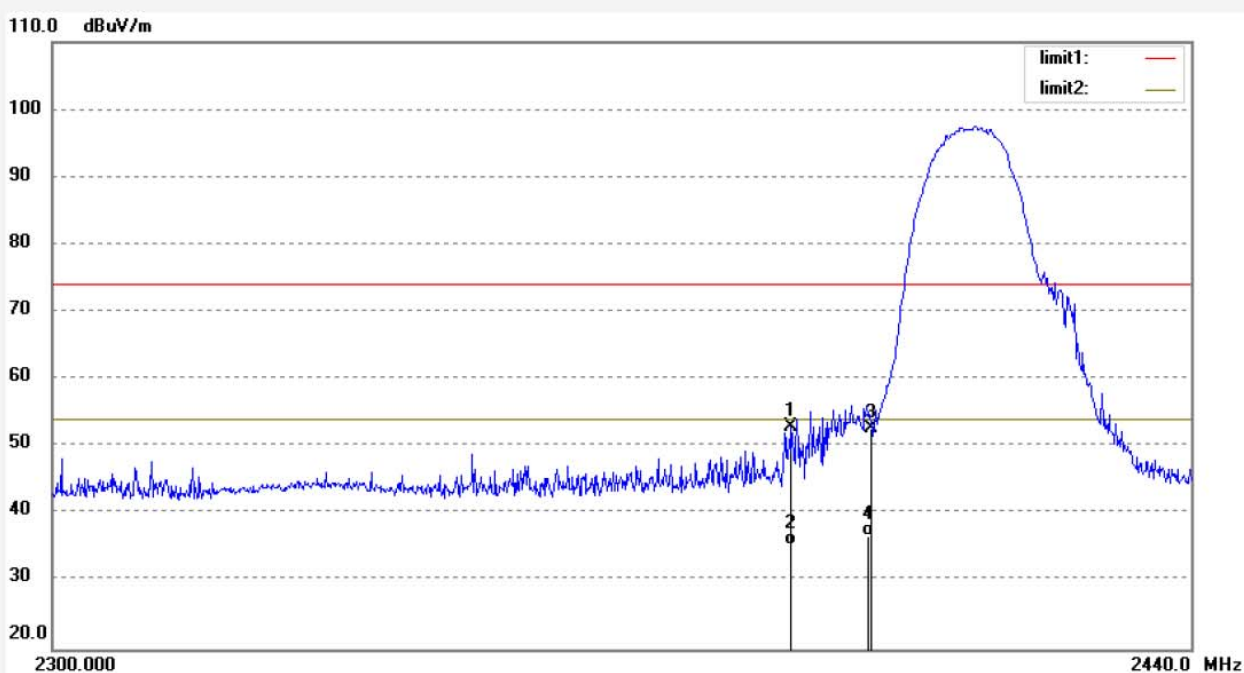

No.	Freq. (MHz)	Reading (dBuV/m)	Factor (dB)	Result (dBuV/m)	Limit (dBuV/m)	Margin (dB)	Detector	Height (cm)	Degree (deg.)	Remark
1	2390.000	52.13	0.79	52.92	74.00	-21.08	peak	150	136	
2	2390.000	34.61	0.79	35.40	54.00	-18.60	AVG	150	185	
3	2400.000	51.79	0.88	52.67	74.00	-21.33	peak	150	196	
4	2400.000	35.82	0.88	36.70	54.00	-17.30	AVG	150	263	

Job No.: br #20	Polarization: Horizontal
Standard: FCC PK	Power Source: AC 120V/60Hz
Test item: Radiation Test	Date: 2020/02/28/
Temp.(C)/Hum.(%) 23 C / 48 %	Time: 11/52/02
EUT: LED bulb	Engineer Signature: Ben
Mode: TX Chanel 11(802.11b)	Distance: 3m
Model: SM-BLBGU10	
Manufacturer: Hengdian Group Tospo Lighting Co., Ltd.	

Note: Report NO.:ATE20200065

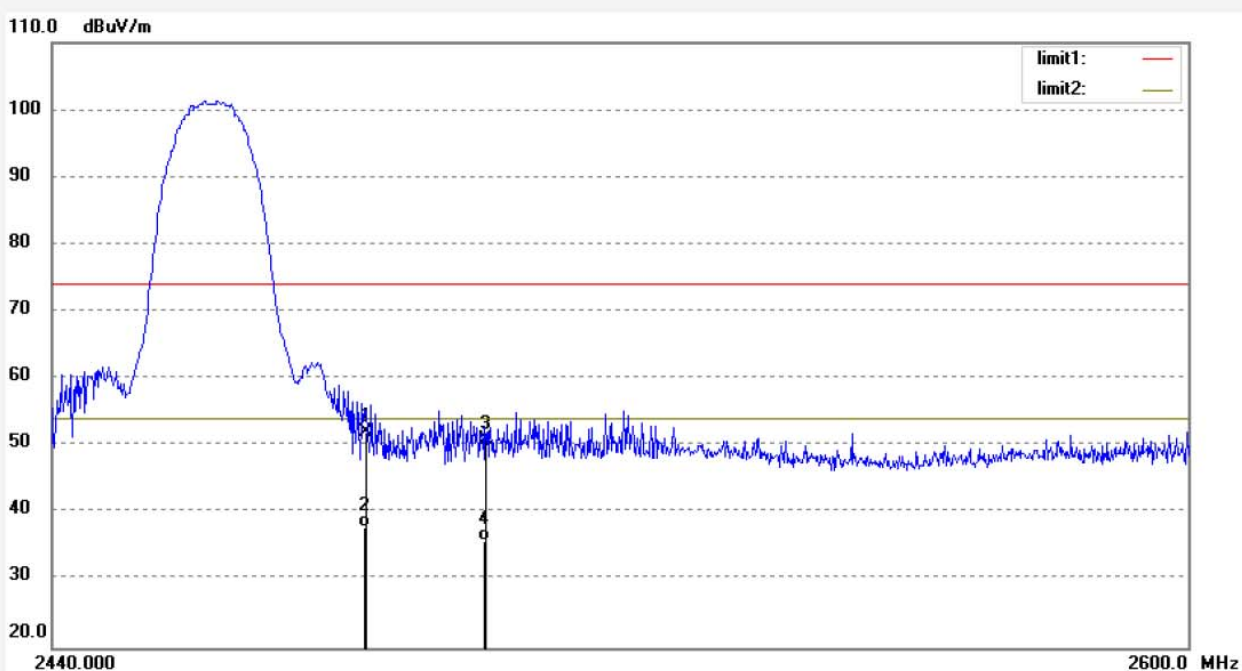

No.	Freq. (MHz)	Reading (dBuV/m)	Factor (dB)	Result (dBuV/m)	Limit (dBuV/m)	Margin (dB)	Detector	Height (cm)	Degree (deg.)	Remark
1	2483.500	50.89	1.10	51.99	74.00	-22.01	peak	200	165	
2	2483.500	36.89	1.10	37.99	54.00	-16.01	AVG	200	189	
3	2500.000	49.83	1.10	50.93	74.00	-23.07	peak	200	236	
4	2500.000	34.80	1.10	35.90	54.00	-18.10	AVG	200	286	

Job No.: br #19	Polarization: Vertical
Standard: FCC PK	Power Source: AC 120V/60Hz
Test item: Radiation Test	Date: 2020/02/28/
Temp.(C)/Hum.(%) 23 C / 48 %	Time: 11/49/18
EUT: LED bulb	Engineer Signature: Ben
Mode: TX Chanel 11(802.11b)	Distance: 3m
Model: SM-BLBGU10	
Manufacturer: Hengdian Group Tospo Lighting Co., Ltd.	

Note: Report NO.:ATE20200065

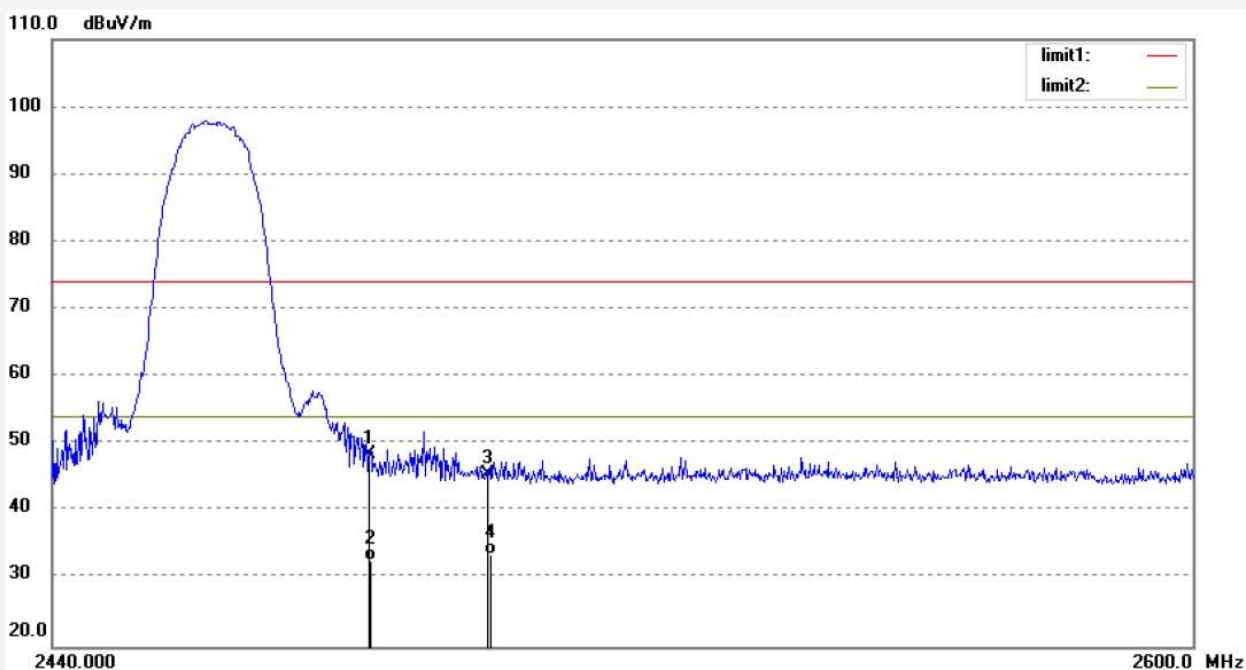

No.	Freq. (MHz)	Reading (dBuV/m)	Factor (dB)	Result (dBuV/m)	Limit (dBuV/m)	Margin (dB)	Detector	Height (cm)	Degree (deg.)	Remark
1	2483.500	47.44	1.10	48.54	74.00	-25.46	peak	150	185	
2	2483.500	31.50	1.10	32.60	54.00	-21.40	AVG	150	198	
3	2500.000	44.41	1.10	45.51	74.00	-28.49	peak	150	245	
4	2500.000	32.41	1.10	33.51	54.00	-20.49	AVG	150	276	

12. POWER LINE CONDUCTED MEASUREMENT

12.1. Block Diagram of Test Setup

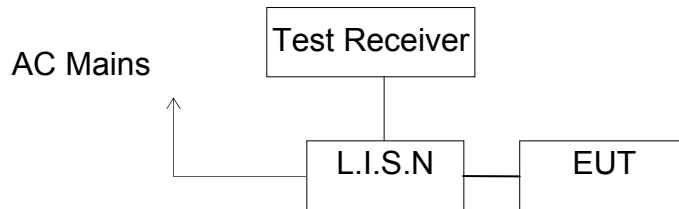

(EUT: LED bulb)

12.2. Power Line Conducted Emission Measurement Limits

Frequency (MHz)	Limit dB(μ V)	
	Quasi-peak Level	Average Level
0.15 - 0.50	66.0 – 56.0 *	56.0 – 46.0 *
0.50 - 5.00	56.0	46.0
5.00 - 30.00	60.0	50.0

NOTE1: The lower limit shall apply at the transition frequencies.
 NOTE2: The limit decreases linearly with the logarithm of the frequency in the range 0.15MHz to 0.50MHz.

12.3. Configuration of EUT on Measurement

The following equipments are installed on Power Line Conducted Emission Measurement to meet the commission requirement and operating regulations in a manner, which tends to maximize its emission characteristics in a normal application.

12.4. Operating Condition of EUT

12.4.1. Setup the EUT and simulator as shown as Section 12.1.

12.4.2. Turn on the power of all equipment.

12.4.3. Let the EUT work in test mode and measure it.

12.5. Test Procedure

The EUT is put on the plane 0.8 m high above the ground by insulating support and is connected to the power mains through a line impedance stabilization network (L.I.S.N.). This provides a 50ohm coupling impedance for the EUT system. Please refer the block diagram of the test setup and photographs. Both sides of AC lines are checked to find out the maximum conducted emission. In order to find the maximum emission levels, the relative positions of equipment and all of the interface cables shall be changed according to ANSI C63.10: 2013 on Conducted Emission Measurement.

The bandwidth of test receiver (R & S ESCS30) is set at 9kHz.

The frequency range from 150kHz to 30MHz is checked.

12.6. DATA SAMPLE

Frequency (MHz)	Quasi Peak Level (dB μ v)	Average Level (dB μ v)	Transducer value (dB)	QuasiPeak Result (dB μ v)	Average Result (dB μ v)	Quasi Peak Limit (dB μ v)	Average Limit (dB μ v)	QuasiPeak Margin (dB)	Average Margin (dB)	Remark (Pass/Fail)
X.XX	29.4	18.3	11.1	40.5	29.4	56.0	56.0	15.5	16.6	Pass

Transducer value = Insertion loss of LISN + Cable Loss

Result = Quasi-peak Level/Average Level + Transducer value

Limit = Limit stated in standard

Calculation Formula:

Margin = Limit – Reading level value – Transducer value

12.7. Power Line Conducted Emission Measurement Results

PASS.

The frequency range from 150kHz to 30MHz is checked.

Test mode : ON&WIFI operation (worse case) Test Voltage: 120V/60Hz								
MEASUREMENT RESULT: "BR-0115-14_fin"								
2020-1-15 11:33								
Frequency	Level	Transd	Limit	Margin	Detector	Line	PE	
MHz	dBuV	dB	dBuV	dB				
0.310000	31.60	10.9	60	28.4	QP	L1	GND	
0.478000	30.50	11.0	56	25.9	QP	L1	GND	
0.894000	28.30	11.1	56	27.7	QP	L1	GND	
2.730000	19.20	11.3	56	36.8	QP	L1	GND	
5.145000	13.90	11.4	60	46.1	QP	L1	GND	
27.775000	12.10	11.8	60	47.9	QP	L1	GND	
MEASUREMENT RESULT: "BR-0115-14_fin2"								
2020-1-15 11:33								
Frequency	Level	Transd	Limit	Margin	Detector	Line	PE	
MHz	dBuV	dB	dBuV	dB				
0.354000	21.20	10.9	49	27.7	AV	L1	GND	
0.774000	22.90	11.1	46	23.1	AV	L1	GND	
0.942000	19.70	11.1	46	26.3	AV	L1	GND	
2.535000	12.00	11.3	46	34.0	AV	L1	GND	
5.200000	6.20	11.4	50	43.8	AV	L1	GND	
28.095000	2.30	11.8	50	47.7	AV	L1	GND	
MEASUREMENT RESULT: "BR-0115-11_fin"								
2020-1-15 11:29								
Frequency	Level	Transd	Limit	Margin	Detector	Line	PE	
MHz	dBuV	dB	dBuV	dB				
0.290000	32.90	10.9	61	27.6	QP	N	GND	
0.502000	30.60	11.0	56	25.4	QP	N	GND	
0.880000	28.60	11.1	56	27.4	QP	N	GND	
2.440000	18.90	11.3	56	37.1	QP	N	GND	
6.465000	13.80	11.5	60	46.2	QP	N	GND	
15.270000	12.70	11.7	60	47.3	QP	N	GND	
MEASUREMENT RESULT: "BR-0115-11_fin2"								
2020-1-15 11:29								
Frequency	Level	Transd	Limit	Margin	Detector	Line	PE	
MHz	dBuV	dB	dBuV	dB				
0.280000	22.90	10.9	51	27.9	AV	N	GND	
0.562000	20.50	11.0	46	25.5	AV	N	GND	
0.908000	19.80	11.1	46	26.2	AV	N	GND	
2.745000	12.00	11.3	46	34.0	AV	N	GND	
5.135000	8.00	11.4	50	42.0	AV	N	GND	
20.735000	3.70	11.7	50	46.3	AV	N	GND	

Emissions attenuated more than 20 dB below the permissible value are not reported.

The spectral diagrams are attached as below.

ACCURATE TECHNOLOGY CO., LTD

CONDUCTED EMISSION STANDARD FCC PART 15B

EUT: LED bulb M/N:SM-BLBGU10
 Manufacturer: Hengdian Group Tospo Lighting Co., Ltd.
 Operating Condition: ON&WIFI operation
 Test Site: 2#Shielding Room
 Operator: Ben
 Test Specification: L 120V/60Hz
 Comment: Report NO.:ATE20200065
 Start of Test: 2020-1-15 / 11:31:53

SCAN TABLE: "V 150K-30MHz fin"

Short Description: SUB STD VTERM2 1.70
 Start Stop Step Detector Meas. IF Transducer
 Frequency Frequency Width Time Bandw.
 150.0 kHz 30.0 MHz 4.5 kHz QuasiPeak 1.0 s 9 kHz NSLK8126 2008
 Average

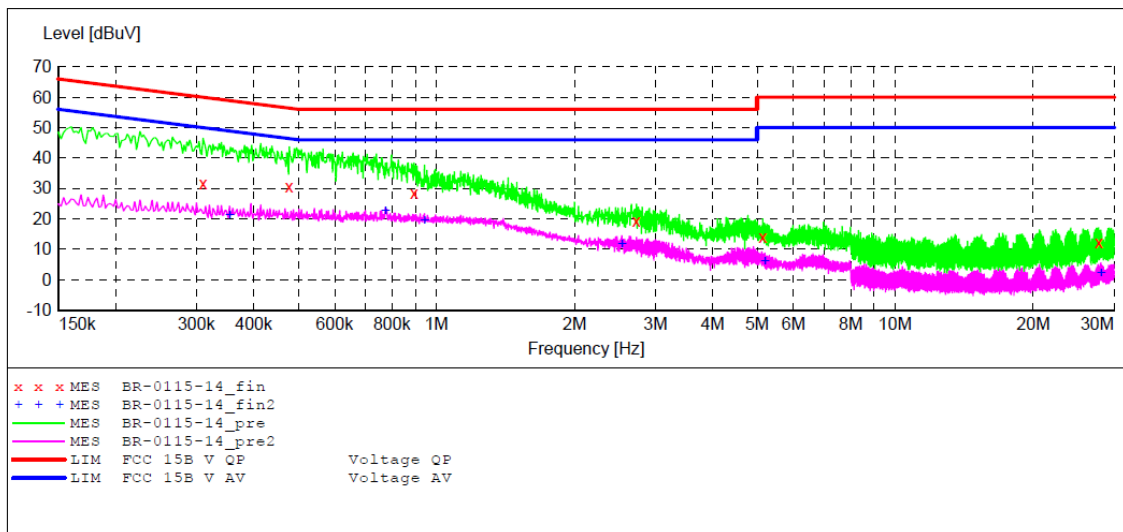

MEASUREMENT RESULT: "BR-0115-14_fin"

2020-1-15 11:33

Frequency MHz	Level dBuV	Transd dB	Limit dBuV	Margin dB	Detector	Line	PE
0.310000	31.60	10.9	60	28.4	QP	L1	GND
0.478000	30.50	11.0	56	25.9	QP	L1	GND
0.894000	28.30	11.1	56	27.7	QP	L1	GND
2.730000	19.20	11.3	56	36.8	QP	L1	GND
5.145000	13.90	11.4	60	46.1	QP	L1	GND
27.775000	12.10	11.8	60	47.9	QP	L1	GND

MEASUREMENT RESULT: "BR-0115-14_fin2"

2020-1-15 11:33

Frequency MHz	Level dBuV	Transd dB	Limit dBuV	Margin dB	Detector	Line	PE
0.354000	21.20	10.9	49	27.7	AV	L1	GND
0.774000	22.90	11.1	46	23.1	AV	L1	GND
0.942000	19.70	11.1	46	26.3	AV	L1	GND
2.535000	12.00	11.3	46	34.0	AV	L1	GND
5.200000	6.20	11.4	50	43.8	AV	L1	GND
28.095000	2.30	11.8	50	47.7	AV	L1	GND

ACCURATE TECHNOLOGY CO., LTD

CONDUCTED EMISSION STANDARD FCC PART 15B

EUT: LED bulb M/N:SM-BLBGU10
 Manufacturer: Hengdian Group Tospo Lighting Co., Ltd.
 Operating Condition: ON&WIFI operation
 Test Site: 2#Shielding Room
 Operator: Ben
 Test Specification: N 120V/60Hz
 Comment: Report NO.:ATE20200065
 Start of Test: 2020-1-15 / 11:27:47

SCAN TABLE: "V 150K-30MHz fin"

Short Description: SUB STD VTERM2 1.70
 Start Stop Step Detector Meas. IF Transducer
 Frequency Frequency Width Time Bandw.
 150.0 kHz 30.0 MHz 4.5 kHz QuasiPeak 1.0 s 9 kHz NSLK8126 2008
 Average

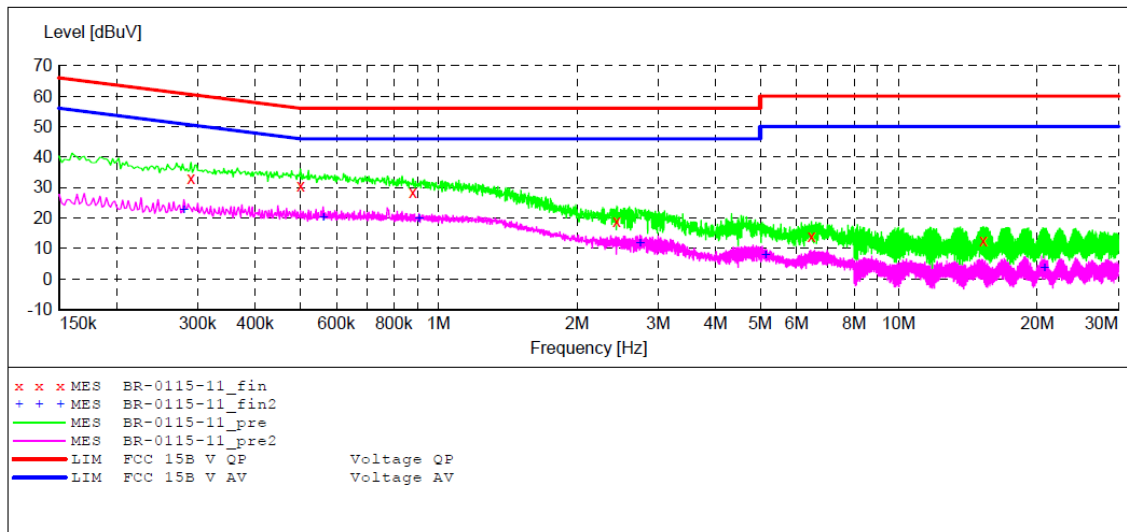

MEASUREMENT RESULT: "BR-0115-11_fin"

2020-1-15 11:29

Frequency MHz	Level dBuV	Transd dB	Limit dBuV	Margin dB	Detector	Line	PE
0.290000	32.90	10.9	61	27.6	QP	N	GND
0.502000	30.60	11.0	56	25.4	QP	N	GND
0.880000	28.60	11.1	56	27.4	QP	N	GND
2.440000	18.90	11.3	56	37.1	QP	N	GND
6.465000	13.80	11.5	60	46.2	QP	N	GND
15.270000	12.70	11.7	60	47.3	QP	N	GND

MEASUREMENT RESULT: "BR-0115-11_fin2"

2020-1-15 11:29

Frequency MHz	Level dBuV	Transd dB	Limit dBuV	Margin dB	Detector	Line	PE
0.280000	22.90	10.9	51	27.9	AV	N	GND
0.562000	20.50	11.0	46	25.5	AV	N	GND
0.908000	19.80	11.1	46	26.2	AV	N	GND
2.745000	12.00	11.3	46	34.0	AV	N	GND
5.135000	8.00	11.4	50	42.0	AV	N	GND
20.735000	3.70	11.7	50	46.3	AV	N	GND

13.ANTENNA REQUIREMENT

13.1.The Requirement

According to Section 15.203, an intentional radiator shall be designed to ensure that no antenna other than that furnished by the responsible party shall be used with the device.

13.2.Antenna Construction

Device is equipped with permanent attached antenna, which isn't displaced by other antenna. The Antenna gain of EUT is 1dBi. Therefore, the equipment complies with the antenna requirement of Section 15.203.

