

# FCC TEST REPORT

Client Name : Dongguan Tyjin Electronics Co., Ltd.  
Address : Room 101, Building 2, No.7 Keyan Road, Wulian,  
Fenggang Town, Dongguan City, Guangdong Province,  
China  
Product Name : Wireless Charging Pad  
Date : Dec. 25, 2021



**Shenzhen Anbotek Compliance Laboratory Limited**

# Contents

- 1. General Information.....4
  - 1.1. Client Information.....4
  - 1.2. Description of Device (EUT).....4
  - 1.3. Auxiliary Equipment Used During Test.....5
  - 1.4. Description of Test Modes.....5
  - 1.5. Description Of Test Setup.....6
  - 1.6. Test Equipment List.....7
  - 1.7. Measurement Uncertainty.....8
  - 1.8. Description of Test Facility.....8
- 2. Summary of Test Results.....9
- 3. Conducted Emission Test.....10
  - 3.1. Test Standard and Limit.....10
  - 3.2. Test Setup.....10
  - 3.3. Test Procedure.....10
  - 3.4. Test Data.....10
- 4. Radiation Spurious Emission.....15
  - 4.1. Test Standard and Limit.....15
  - 4.2. Test Setup.....15
  - 4.3. Test Procedure.....16
  - 4.4. Test Data.....16
- 5. Antenna Requirement.....21
  - 5.1. Test Standard and Requirement.....21
  - 5.2. Antenna Connected Construction.....21
- APPENDIX I -- TEST SETUP PHOTOGRAPH.....22
- APPENDIX II -- EXTERNAL PHOTOGRAPH.....24
- APPENDIX III -- INTERNAL PHOTOGRAPH.....27

# TEST REPORT

Applicant : Dongguan Tyjin Electronics Co., Ltd.

Manufacturer : Dongguan Tyjin Electronics Co., Ltd.

Product Name : Wireless Charging Pad

Model No. : C-109A, C-109

Trade Mark : N.A.

Rating(s) : Input: DC 5V/2A, DC 9V/1.67A  
Wireless output: 5W, 7.5W, 10W

**Test Standard(s) : FCC Part15 Subpart C, Paragraph 15.209**

**Test Method(s) : ANSI C63.10: 2020**

The device described above is tested by Shenzhen Anbotek Compliance Laboratory Limited to determine the maximum emission levels emanating from the device and the severe levels of the device can endure and its performance criterion. The measurement results are contained in this test report and Shenzhen Anbotek Compliance Laboratory Limited is assumed full of responsibility for the accuracy and completeness of these measurements. Also, this report shows that the EUT (Equipment Under Test) is technically compliant with the FCC Part 15 Subpart C requirements.

This report applies to above tested sample only and shall not be reproduced in part without written approval of Shenzhen Anbotek Compliance Laboratory Limited.

Date of Receipt

Dec. 02, 2021

Date of Test

Dec. 02~ 10, 2021

Prepared By



(Ella Liang)

Approved & Authorized Signer



(Kingkong Jin)

# 1. General Information

## 1.1. Client Information

Applicant	:	Dongguan Tyjin Electronics Co., Ltd.
Address	:	Room 101, Building 2, No.7 Keyan Road, Wulian, Fenggang Town, Dongguan City, Guangdong Province, China
Manufacturer	:	Dongguan Tyjin Electronics Co., Ltd.
Address	:	Room 101, Building 2, No.7 Keyan Road, Wulian, Fenggang Town, Dongguan City, Guangdong Province, China
Factory	:	Dongguan Tyjin Electronics Co., Ltd.
Address	:	Room 101, Building 2, No.7 Keyan Road, Wulian, Fenggang Town, Dongguan City, Guangdong Province, China

## 1.2. Description of Device (EUT)

Product Name	:	Wireless Charging Pad	
Model No.	:	C-109A, C-109 (Note: All samples are the same except the model number, so we prepare "C-109A" for test only.)	
Trade Mark	:	N.A.	
Test Power Supply	:	AC 120V, 60Hz for adapter/AC 240V, 60Hz for adapter	
Test Sample No.	:	1-2-1(Normal Sample), 1-2-2(Engineering Sample)	
Product Description	:	Operation Frequency:	110.1-205K
		Modulation Type:	ASK
		Antenna Type:	Inductive loop coil Antenna
		Antenna Gain(Peak):	0 dBi (Provided by customer)
<b>Remark:</b> 1) For a more detailed features description, please refer to the manufacturer's specifications or the User's Manual.			

### 1.3. Auxiliary Equipment Used During Test

Adapter	:	M/N: A2013 Input: AC 100-240V, 0.7A, 50-60Hz Output: 3.6-5.5V---3A/ 6.5-9V---2A/ 9-12V---1.5A
Wireless charging load	:	Manufacturer: Shenzhen Ouju Technology Co., Ltd. M/N: CD2577 Power: 5W/7.5W/10W/15W Last Cal.: Oct. 26, 2020 Cal. Interval: 1 Year

### 1.4. Description of Test Modes

To investigate the maximum EMI emission characteristics generates from EUT, the test system was pre-scanning tested base on the consideration of following EUT operation mode or test configuration mode which possible have effect on EMI emission level. Each of these EUT operation mode(s) or test configuration mode(s) mentioned above was evaluated respectively.

Pretest Mode	Description
Mode 1	Wireless Charging

For Conducted Emission	
Final Test Mode	Description
Mode 1	Wireless Charging

For Radiated Emission	
Final Test Mode	Description
Mode 1	Wireless Charging

Note: (1)Test channel is 0.1101MHz.

(2) All the situation(full load, half load and empty load) has been tested,only the worst situation (full load 10W) was recorded in the report.

**1.5. Description Of Test Setup**

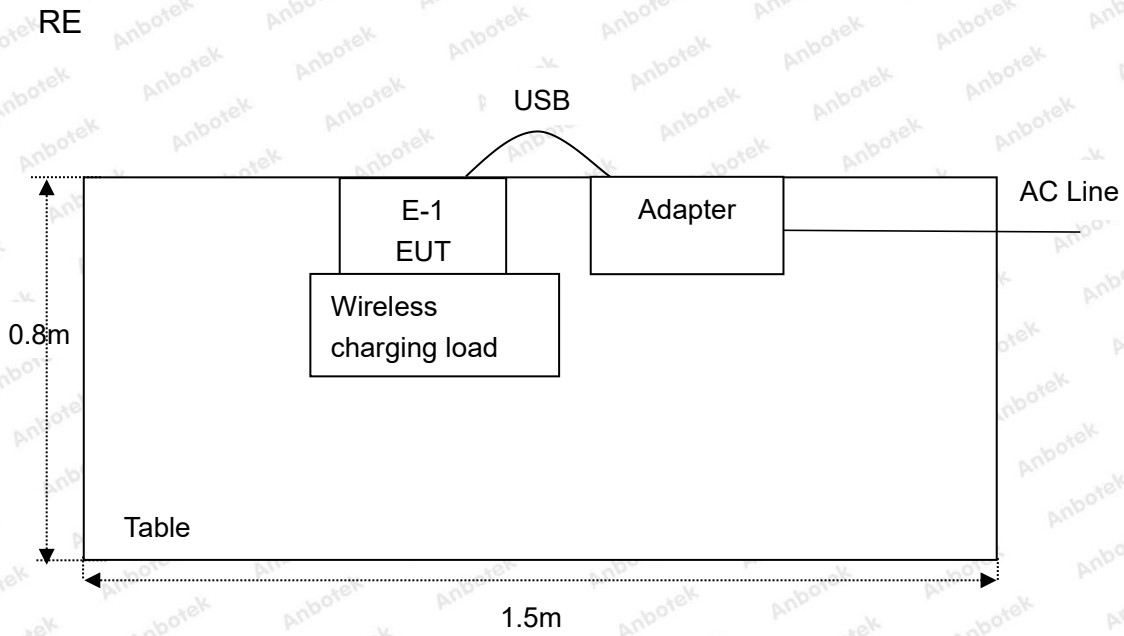
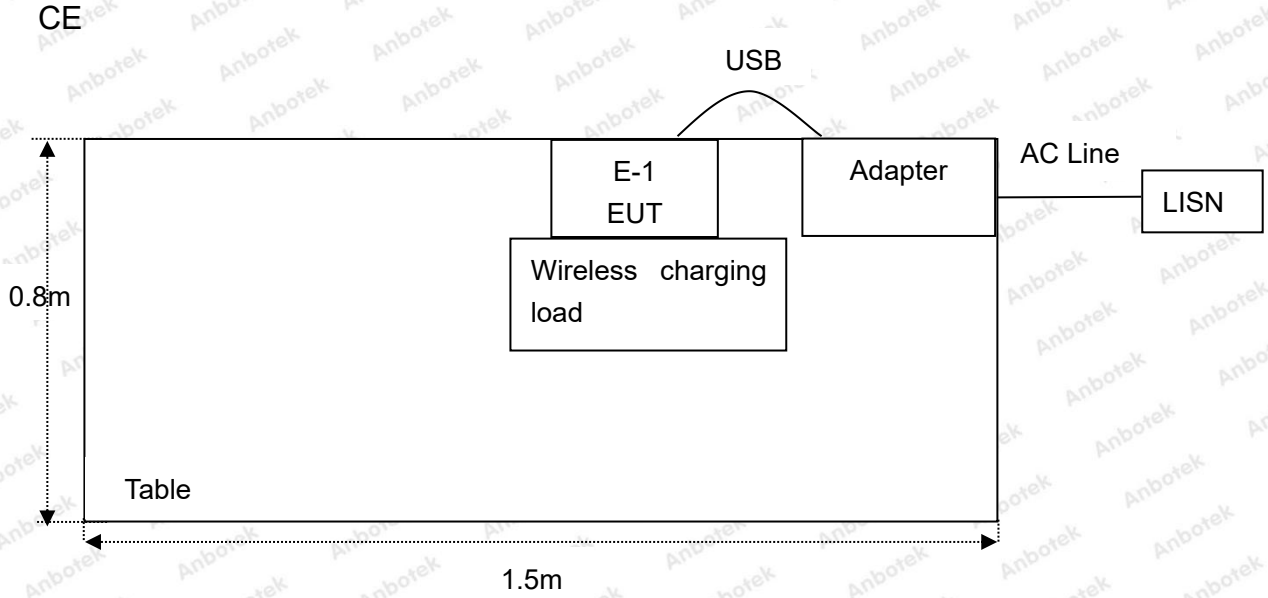

## 1.6. Test Equipment List

Item	Equipment	Manufacturer	Model No.	Serial No.	Last Cal.	Cal. Interval
1.	Three Phase V-type Artificial Power Network	CYBERTEK	EM5040DT	E215040DT001	Jul 05, 2021	1 Year
2.	EMI Test Receiver	Rohde & Schwarz	ESCI	100627	Oct. 22, 2021	1 Year
3.	EMI Test Receiver	Rohde & Schwarz	ESR26	101481	Oct. 22, 2021	1 Year
4.	RF Switching Unit	Compliance Direction	RSU-M2	38303	Oct. 22, 2021	1 Year
5.	MAX Spectrum Analysis	Agilent	N9020A	MY51170037	Oct. 22, 2021	1 Year
6.	Preamplifier	SKET Electronic	BK1G18G30 D	KD17503	Oct. 22, 2021	1 Year
7.	Double Ridged Horn Antenna	Instruments corporation	GTH-0118	351600	Oct. 22, 2021	2 Year
8.	Bilog Broadband Antenna	Schwarzbeck	VULB9163	VULB 9163-289	Oct. 22, 2021	2 Year
9.	Loop Antenna	Schwarzbeck	FMZB1519B	00053	Oct. 22, 2021	2 Year
10.	Horn Antenna	A-INFO	LB-180400-K F	J211060628	Oct. 22, 2021	2 Year
11.	Pre-amplifier	SONOMA	310N	186860	Oct. 22, 2021	1 Year
12.	EMI Test Software EZ-EMC	SHURPLE	N/A	N/A	N/A	N/A
13.	RF Test Control System	YIHENG	YH3000	2017430	Oct. 22, 2021	1 Year
14.	Power Sensor	DAER	RPR3006W	15I00041SN045	Oct. 22, 2021	1 Year
15.	Power Sensor	DAER	RPR3006W	15I00041SN046	Oct. 22, 2021	1 Year
16.	MXA Spectrum Analysis	KEYSIGHT	N9020A	MY53280032	Oct. 22, 2021	1 Year
17.	MXG RF Vector Signal Generator	Agilent	N5182A	MY48180656	Oct. 22, 2021	1 Year
18.	Signal Generator	Agilent	E4421B	MY41000743	Oct. 22, 2021	1 Year
19.	DC Power Supply	IVYTECH	IV3605	1804D360510	Oct. 22, 2021	1 Year
20.	Constant Temperature Humidity Chamber	ZHONGJIAN	ZJ-KHWS80 B	N/A	Oct. 22, 2021	1 Year

### 1.7. Measurement Uncertainty

Radiation Uncertainty	:	Ur = 3.9 dB (Horizontal)
		Ur = 3.8 dB (Vertical)
Conduction Uncertainty	:	Uc = 3.4 dB

### 1.8. Description of Test Facility

The test facility is recognized, certified, or accredited by the following organizations:

#### FCC-Registration No.: 184111

Shenzhen Anbotek Compliance Laboratory Limited, EMC Laboratory has been registered and fully described in a report filed with the (FCC) Federal Communications Commission. The acceptance letter from the FCC is maintained in our files. Registration No. 184111.

#### ISED-Registration No.: 8058A

Shenzhen Anbotek Compliance Laboratory Limited, EMC Laboratory has been registered and fully described in a report filed with the (ISED) Innovation, Science and Economic Development Canada. The acceptance letter from the ISED is maintained in our files. Registration 8058A.

#### Test Location

Shenzhen Anbotek Compliance Laboratory Limited.

1/F, Building D, Sogood Science and Technology Park, Sanwei community, Hangcheng Street, Bao'an District, Shenzhen, Guangdong, China.518102



## 2. Summary of Test Results

Standard Section	Test Item	Result
FCC Part 15, Paragraph 15.207	Conducted Emission Test	PASS
FCC Part 15, Paragraph 15.209(a)(f)	Spurious Emission	PASS
Part 15.203	Antenna Requirement	PASS

## 3. Conducted Emission Test

### 3.1. Test Standard and Limit

Test Standard	FCC Part15 Section 15.207		
Test Limit	Frequency	Maximum RF Line Voltage (dBuV)	
		Quasi-peak Level	Average Level
	150kHz~500kHz	66 ~ 56 *	56 ~ 46 *
	500kHz~5MHz	56	46
5MHz~30MHz	60	50	

**Remark:** (1) \*Decreasing linearly with logarithm of the frequency.  
 (2) The lower limit shall apply at the transition frequency.

### 3.2. Test Setup

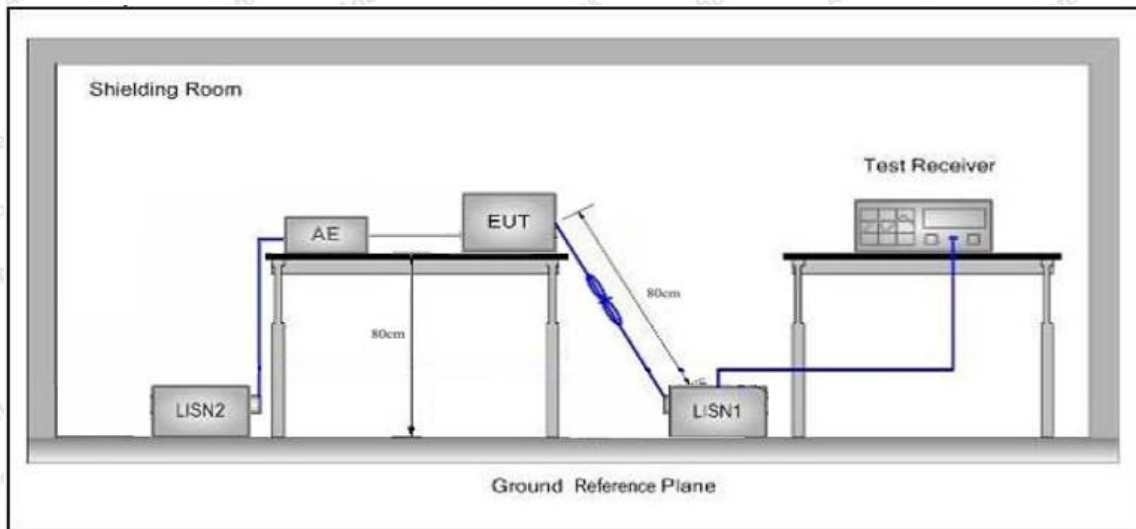

### 3.3. Test Procedure

The EUT system is connected to the power mains through a line impedance stabilization network (L.I.S.N.). This provides a 50ohm coupling impedance for the EUT system. Please refer the block diagram of the test setup and photographs. Both sides of AC line are checked to find out the maximum conducted emission. In order to find the maximum emission levels, the relative positions of equipment and all of the interface cables shall be changed according to FCC ANSI C63.10-2020 on Conducted Emission Measurement.

The bandwidth of test receiver (ESCI) set at 9kHz.

The frequency range from 150kHz to 30MHz is checked.

### 3.4. Test Data

Please to see the following pages

#### Shenzhen Anbotek Compliance Laboratory Limited

Address: 1/F., Building D, Sogood Science and Technology Park, Sanwei Community, Hangcheng Street, Bao'an District, Shenzhen, Guangdong, China.

Tel:(86) 755-26066440 Fax: (86) 755-26014772 Email: service@anbotek.com

Code:AB-RF-05-a

Hotline  
400-003-0500  
www.anbotek.com

### Conducted Emission Test Data

Test Site: 1# Shielded Room  
 Operating Condition: Mode 1  
 Test Specification: AC 240V, 60Hz for adapter  
 Comment: Live Line  
 Tem.: 22.4°C Hum.: 47%

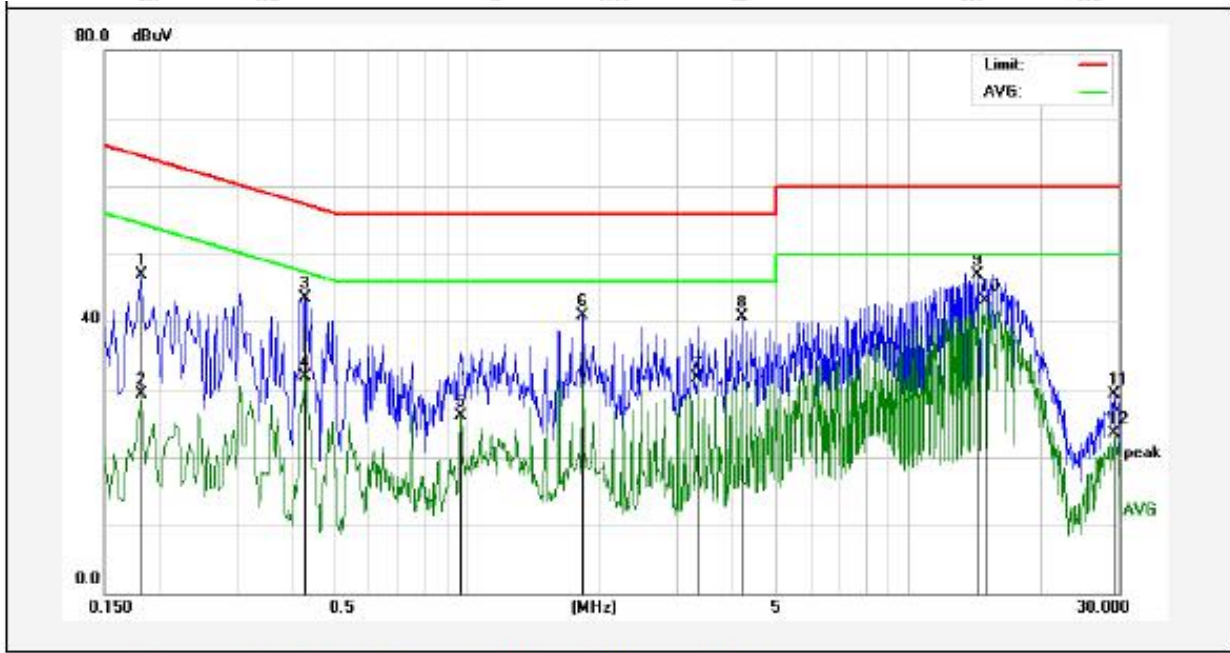

No.	Freq. (MHz)	Reading (dBuV)	Factor (dB)	Result (dBuV)	Limit (dBuV)	Over Limit (dB)	Detector	Remark
1	0.1819	46.85	0.12	46.97	64.39	-17.42	QP	
2	0.1819	29.27	0.12	29.39	54.39	-25.00	AVG	
3	0.4300	43.32	0.12	43.44	57.25	-13.81	QP	
4	0.4300	31.77	0.12	31.89	47.25	-15.36	AVG	
5	0.9660	25.90	0.15	26.05	46.00	-19.95	AVG	
6	1.8260	40.71	0.13	40.84	56.00	-15.16	QP	
7	3.3300	31.60	0.12	31.72	46.00	-14.28	AVG	
8	4.1939	40.64	0.11	40.75	56.00	-15.25	QP	
9	14.3979	46.84	0.16	47.00	60.00	-13.00	QP	
10	15.0419	42.84	0.17	43.01	50.00	-6.99	AVG	
11	29.2260	29.00	0.34	29.34	60.00	-30.66	QP	
12	29.2260	23.10	0.34	23.44	50.00	-26.56	AVG	

### Conducted Emission Test Data

Test Site: 1# Shielded Room  
 Operating Condition: Mode 1  
 Test Specification: AC 240V, 60Hz for adapter  
 Comment: Neutral Line  
 Tem.: 22.4°C Hum.: 47%

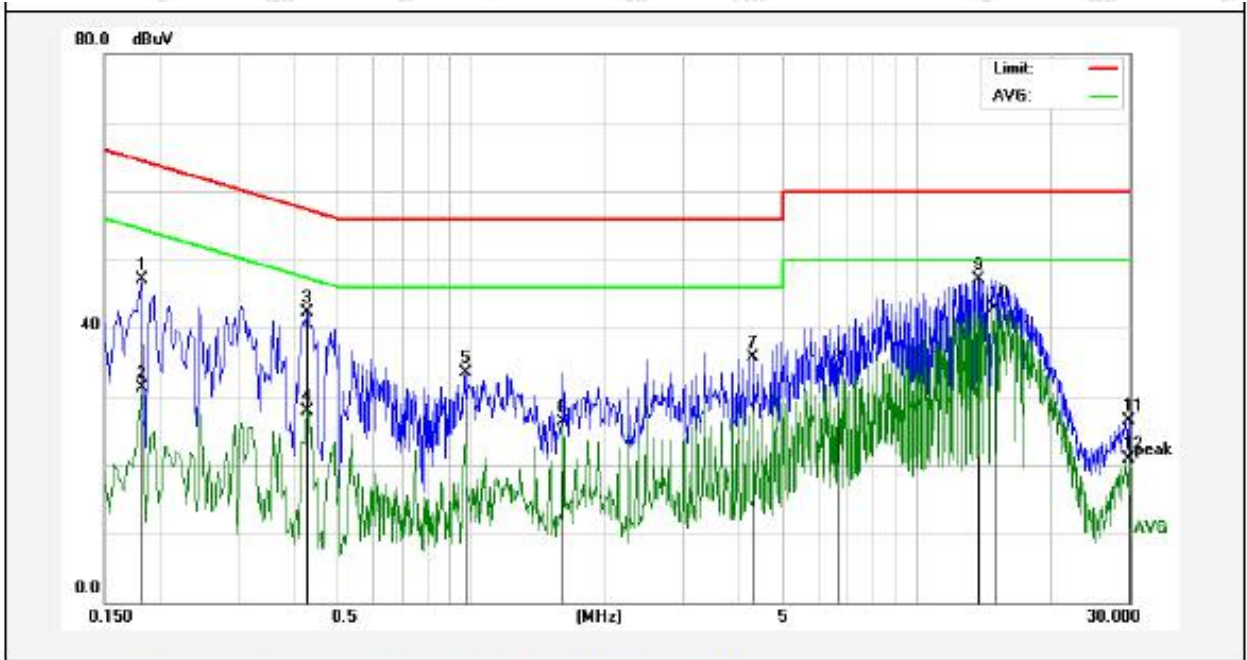

No.	Freq. (MHz)	Reading (dBuV)	Factor (dB)	Result (dBuV)	Limit (dBuV)	Over Limit (dB)	Detector	Remark
1	0.1819	47.05	0.12	47.17	64.39	-17.22	QP	
2	0.1819	31.13	0.12	31.25	54.39	-23.14	AVG	
3	0.4300	42.20	0.12	42.32	57.25	-14.93	QP	
4	0.4300	27.88	0.12	28.00	47.25	-19.25	AVG	
5	0.9700	33.30	0.15	33.45	56.00	-22.55	QP	
6	1.6100	26.11	0.13	26.24	46.00	-19.76	AVG	
7	4.2980	35.69	0.11	35.80	56.00	-20.20	QP	
8	6.6620	33.64	0.11	33.75	50.00	-16.25	AVG	
9	13.7540	46.92	0.16	47.08	60.00	-12.92	QP	
10	15.0420	42.78	0.17	42.95	50.00	-7.05	AVG	
11	29.8660	26.24	0.36	26.60	60.00	-33.40	QP	
12	29.8660	20.49	0.36	20.85	50.00	-29.15	AVG	

**Conducted Emission Test Data**

Test Site: 1# Shielded Room  
 Operating Condition: Mode 1  
 Test Specification: AC 120V, 60Hz for adapter  
 Comment: Live Line  
 Tem.: 22.4°C Hum.: 47%

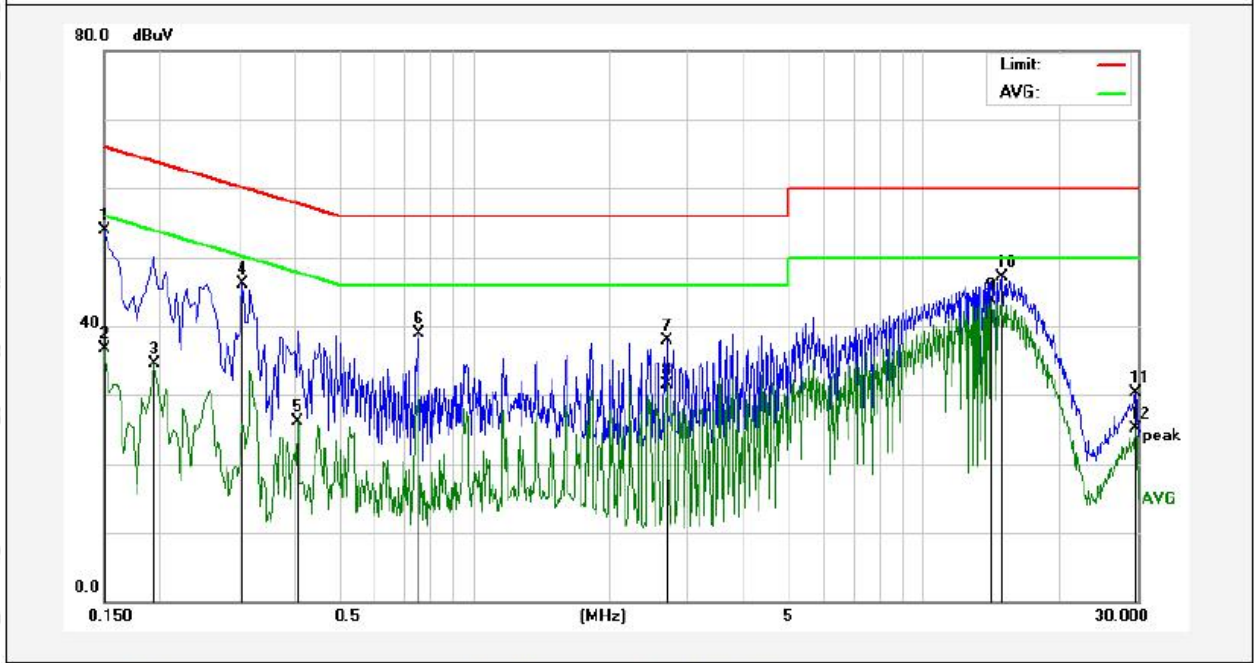

No.	Freq. (MHz)	Reading (dBuV)	Factor (dB)	Result (dBuV)	Limit (dBuV)	Over Limit (dB)	Detector	Remark
1	0.1500	53.71	0.11	53.82	65.99	-12.17	QP	
2	0.1500	36.50	0.11	36.61	55.99	-19.38	AVG	
3	0.1940	34.36	0.12	34.48	53.86	-19.38	AVG	
4	0.3060	46.04	0.13	46.17	60.08	-13.91	QP	
5	0.4060	25.92	0.11	26.03	47.73	-21.70	AVG	
6	0.7539	38.73	0.15	38.88	56.00	-17.12	QP	
7	2.6860	37.79	0.12	37.91	56.00	-18.09	QP	
8	2.6860	31.38	0.12	31.50	46.00	-14.50	AVG	
9	14.1860	43.54	0.16	43.70	50.00	-6.30	AVG	
10	15.0460	46.86	0.17	47.03	60.00	-12.97	QP	
11	29.7380	29.95	0.36	30.31	60.00	-29.69	QP	
12	29.7380	24.67	0.36	25.03	50.00	-24.97	AVG	

**Conducted Emission Test Data**

Test Site: 1# Shielded Room  
 Operating Condition: Mode 1  
 Test Specification: AC 120V, 60Hz for adapter  
 Comment: Neutral Line  
 Tem.: 22.4°C Hum.: 47%

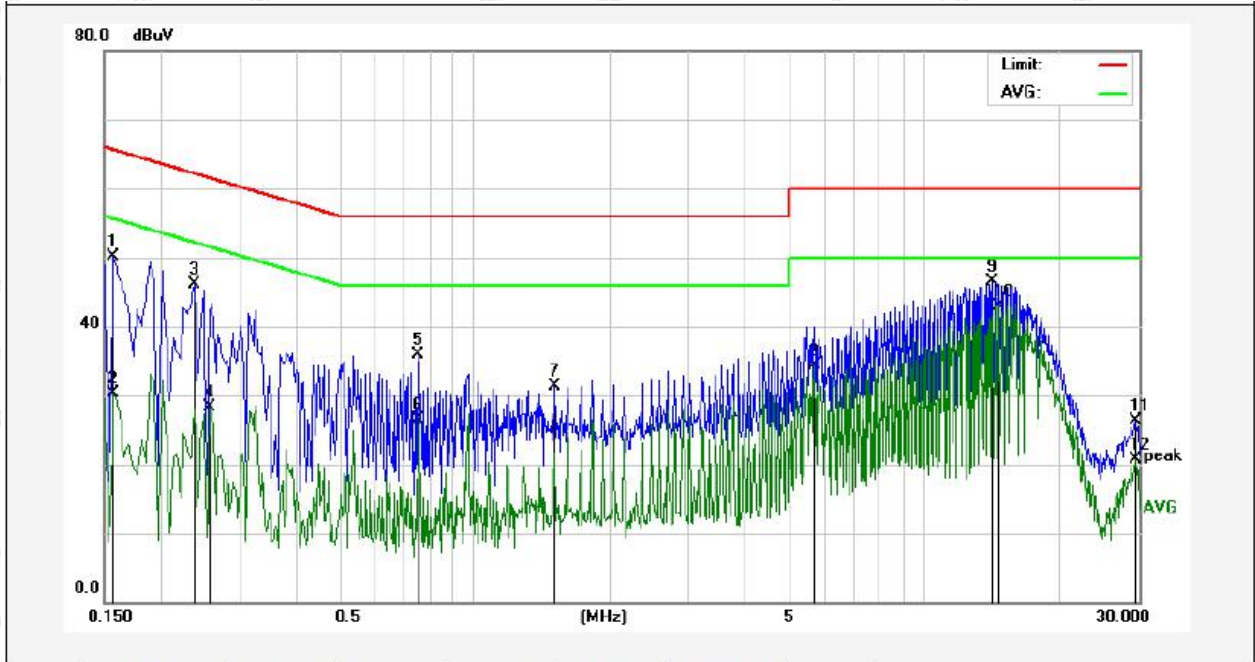

No.	Freq. (MHz)	Reading (dBuV)	Factor (dB)	Result (dBuV)	Limit (dBuV)	Over Limit (dB)	Detector	Remark
1	0.1580	50.08	0.12	50.20	65.56	-15.36	QP	
2	0.1580	30.10	0.12	30.22	55.56	-25.34	AVG	
3	0.2380	46.05	0.12	46.17	62.16	-15.99	QP	
4	0.2580	28.23	0.13	28.36	51.49	-23.13	AVG	
5	0.7500	35.84	0.15	35.99	56.00	-20.01	QP	
6	0.7539	26.34	0.15	26.49	46.00	-19.51	AVG	
7	1.5060	31.18	0.13	31.31	56.00	-24.69	QP	
8	5.6979	34.22	0.11	34.33	50.00	-15.67	AVG	
9	14.1860	46.32	0.16	46.48	60.00	-13.52	QP	
10	14.6180	42.79	0.17	42.96	50.00	-7.04	AVG	
11	29.4580	26.01	0.35	26.36	60.00	-33.64	QP	
12	29.6700	20.30	0.36	20.66	50.00	-29.34	AVG	

## 4. Radiation Spurious Emission

### 4.1. Test Standard and Limit

Test Standard	FCC Part15 C Section 15.209 and 15.205				
Test Limit	Frequency (MHz)	Field strength (microvolt/meter)	Limit (dBuV/m)	Remark	Measurement distance (m)
	0.009MHz~0.490MHz	2400/F(kHz)	-	-	300
	0.490MHz-1.705MHz	24000/F(kHz)	-	-	30
	1.705MHz-30MHz	30	-	-	30
	30MHz~88MHz	100	40.0	Quasi-peak	3
	88MHz~216MHz	150	43.5	Quasi-peak	3
	216MHz~960MHz	200	46.0	Quasi-peak	3
	960MHz~1000MHz	500	54.0	Quasi-peak	3
	Above 1000MHz	500	54.0	Average	3
-		74.0	Peak	3	

**Remark:**

(1)The lower limit shall apply at the transition frequency.

(2) 15.35(b), Unless otherwise specified, the limit on peak radio frequency emissions is 20dB above the maximum permitted average emission limit applicable to the equipment under test. This peak limit applies to the total peak emission level radiated by the device.

### 4.2. Test Setup

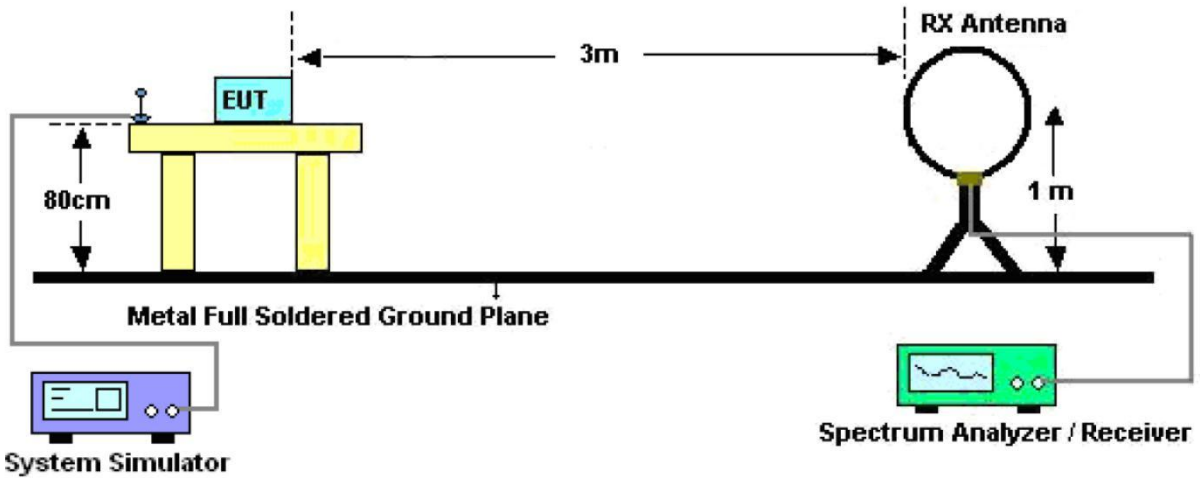

Figure 1. Below 30MHz

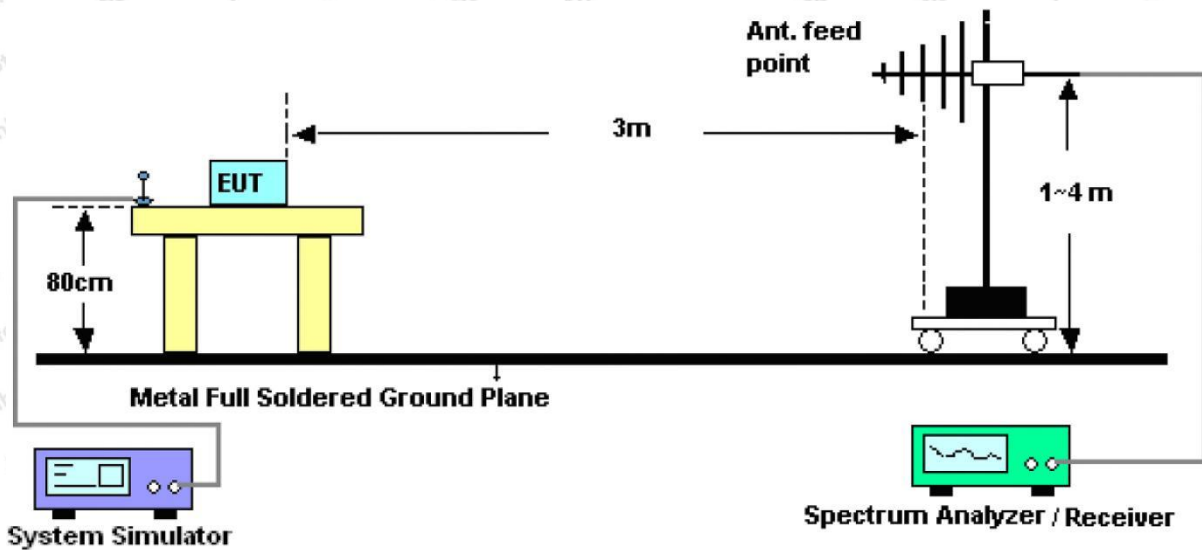

Figure 2. 30MHz to 1GHz

### 4.3. Test Procedure

For below 1GHz: The EUT is placed on a turntable, which is 0.8m above the ground plane.

The turn table can rotate 360 degrees to determine the position of the maximum emission level. The EUT is set 3 meters away from the receiving antenna which is mounted on a antenna tower. The antenna can be moved up and down from 1 to 4 meters to find out the maximum emission level. Rotated the EUT through three orthogonal axes to determine the maximum emissions, both horizontal and vertical polarization of the antenna are set on test. The EUT is tested in 9\*6\*6 Chamber. The device is evaluated in xyz orientation.

For 9kHz to 150kHz, Set the spectrum analyzer as:

RBW = 200Hz, VBW = 1kHz, Detector= Quasi-Peak, Trace mode= Max hold, Sweep- auto couple.

For 150kHz to 30MHz, Set the spectrum analyzer as:

RBW = 9kHz, VBW = 30kHz, Detector= Quasi-Peak, Trace mode= Max hold, Sweep- auto couple.

For 30MHz to 1000MHz, Set the spectrum analyzer as:

RBW = 100kHz, VBW = 300kHz, Detector= Quasi-Peak, Trace mode= Max hold, Sweep- auto couple.

### 4.4. Test Data

**PASS**

Note: The data is in TX mode, and this is the worst mode.



**Test Results**

(Between 9KHz – 30MHz)

**Standard:** FCC PART15 C \_3m      **Power Source:** AC 120V, 60Hz for adapter  
**Test item:** Radiation Test      **Temp.(C)/Hum.(%RH):** 22.4°C/49%RH  
**Test Mode:** Mode 1      **Distance:** 3m

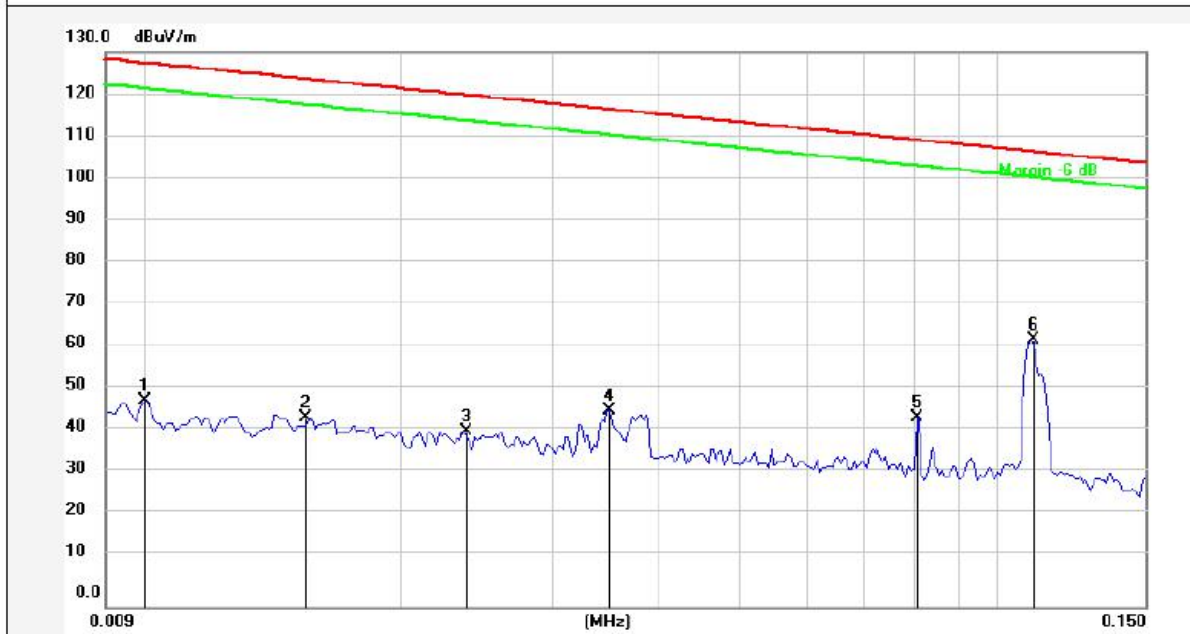

No.	Freq. (MHz)	Reading (dBUV)	Factor ( )	Result (dBUV/m)	Limit (dBUV/m)	Over Limit (dB)	Detector	Height (cm)	degree (deg)	Remark
1	0.0100	28.19	20.09	48.28	127.40	-79.12	QP			
2	0.0154	24.20	20.29	44.49	123.67	-79.18	QP			
3	0.0238	20.71	20.38	41.09	119.91	-78.82	QP			
4	0.0350	25.52	20.49	46.01	116.58	-70.57	QP			
5	0.0806	24.11	20.36	44.47	109.38	-64.91	QP			
6	0.1101	42.20	20.28	62.48	106.69	-44.21	QP			

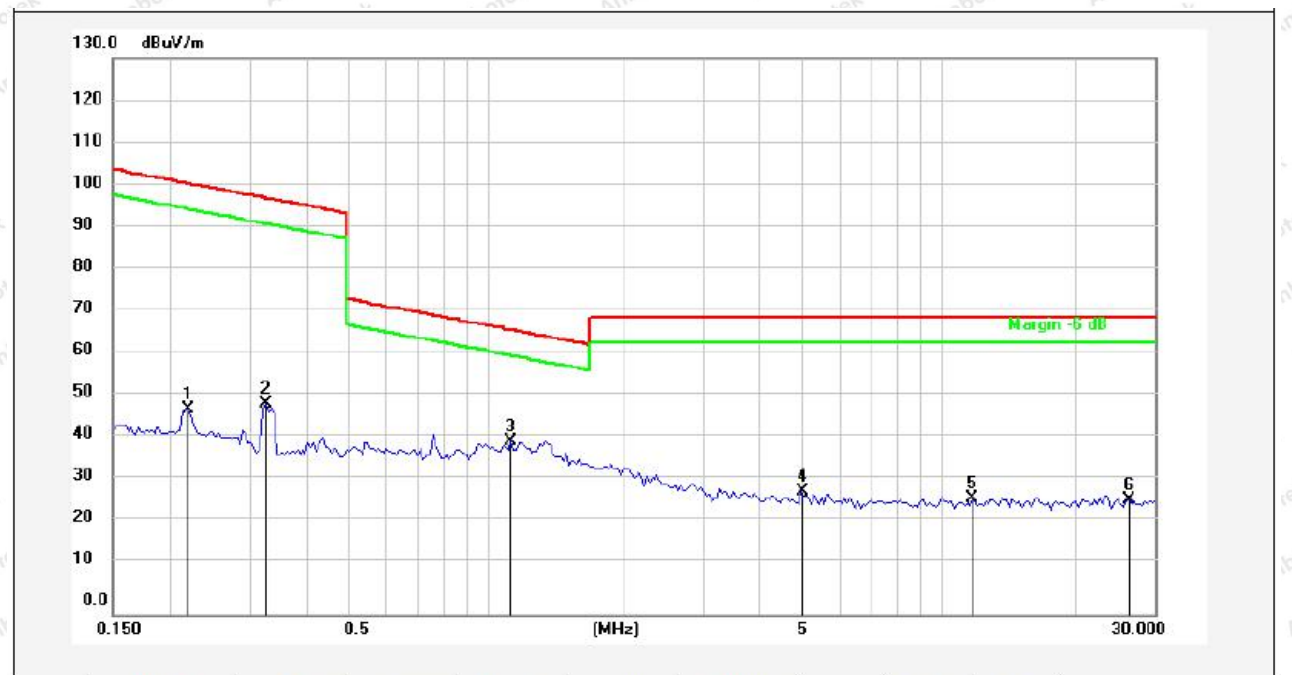

No.	Freq. (MHz)	Reading (dBUV)	Factor ( )	Result (dBUV/m)	Limit (dBUV/m)	Over Limit (dB)	Detector	Height (cm)	degree (deg)	Remark
1	0.2174	27.68	20.30	47.98	100.82	-52.84	QP			
2	0.3276	29.11	20.29	49.40	97.28	-47.88	QP			
3	1.1382	20.06	20.26	40.32	66.50	-26.18	QP			
4	4.9519	8.27	20.41	28.68	69.50	-40.82	QP			
5	11.8696	6.68	20.53	27.21	69.50	-42.29	QP			
6	26.2778	6.13	20.68	26.81	69.50	-42.69	QP			

**Remark:** According to FCC PART 15.209 (d), the emission limits for the frequency bands 9–90 kHz, 110–490 kHz and above 1000 MHz, Radiated emission limits in these three bands are based on measurements employing an average detector.

(Between 30MHz –1000 MHz)

<b>Standard:</b>	<b>FCC PART15 C _3m</b>	<b>Polarization:</b>	<b>Horizontal</b>
<b>Test item:</b>	<b>Radiation Test</b>	<b>Power Source:</b>	<b>AC 120V, 60Hz for adapter</b>
<b>Test Mode:</b>	<b>Mode 1</b>	<b>Temp.(C)/Hum.(%RH):</b>	<b>24.3°C/46%RH</b>
<b>Distance:</b>	<b>3m</b>		

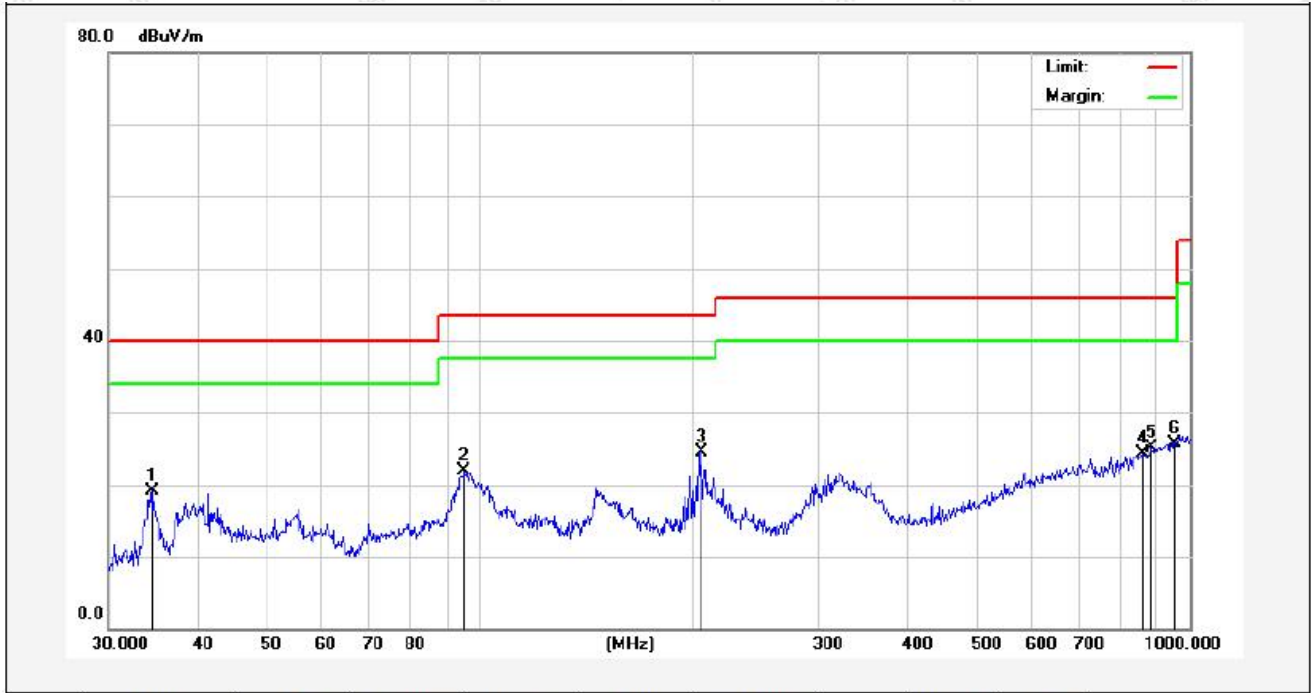

No.	Freq. (MHz)	Reading (dBuV)	Factor (dB/m)	Result (dBuV/m)	Limit (dBuV/m)	Over Limit (dB)	Detector	Height (cm)	degree (deg)	Remark
1	34.6385	37.71	-18.58	19.13	40.00	-20.87	QP			
2	95.0930	43.61	-21.71	21.90	43.50	-21.60	QP			
3	204.9551	46.81	-22.24	24.57	43.50	-18.93	QP			
4	857.0247	31.61	-7.30	24.31	46.00	-21.69	QP			
5	881.4067	31.73	-6.68	25.05	46.00	-20.95	QP			
6	952.0937	31.38	-5.61	25.77	46.00	-20.23	QP			

**Standard:** FCC PART15 C\_3m      **Polarization:** Vertical  
**Test item:** Radiation Test      **Power Source:** AC 120V, 60Hz for adapter  
**Test Mode:** Mode 1      **Temp.(C)/Hum.(%RH):** 24.3°C/46%RH  
**Distance:** 3m



No.	Freq. (MHz)	Reading (dBuV)	Factor (dB/m)	Result (dBuV/m)	Limit (dBuV/m)	Over Limit (dB)	Detector	Height (cm)	degree (deg)	Remark
1	40.8446	45.86	-14.64	31.22	40.00	-8.78	QP			
2	53.5052	40.40	-17.07	23.33	40.00	-16.67	QP			
3	87.1117	45.33	-18.13	27.20	40.00	-12.80	QP			
4	102.7192	42.13	-17.01	25.12	43.50	-18.38	QP			
5	207.1226	43.64	-19.42	24.22	43.50	-19.28	QP			
6	935.5463	32.48	-5.81	26.67	46.00	-19.33	QP			

## 5. Antenna Requirement

### 5.1. Test Standard and Requirement

Test Standard	FCC Part15 Section 15.203
Requirement	An intentional radiator shall be designed to ensure that no antenna other than that furnished by the responsible party shall be used with the device. The use of a permanently attached antenna or of an antenna that uses a unique coupling to the intentional radiator, the manufacturer may design the unit so that a broken antenna can be replaced by the user, but the use of a standard antenna jack or electrical connector is prohibited.

### 5.2. Antenna Connected Construction

The antenna is a Inductive loop coil Antenna which permanently attached, and the best case gain of the antenna is 0 dBi. It complies with the standard requirement.

## APPENDIX I -- TEST SETUP PHOTOGRAPH

Photo of Conducted Emission Measurement

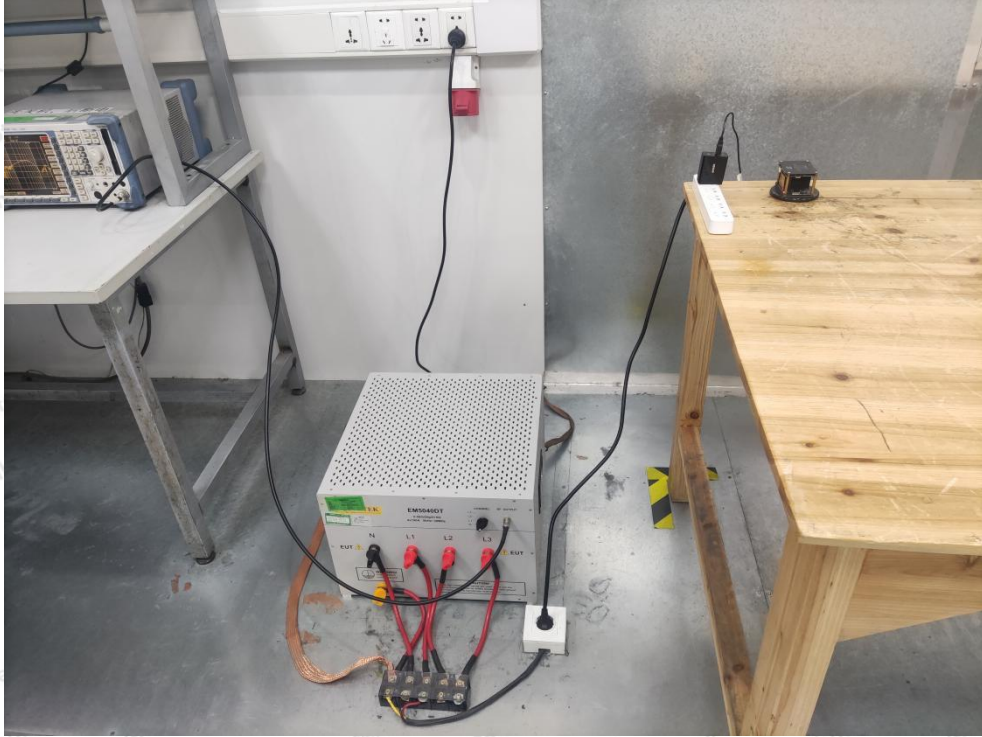
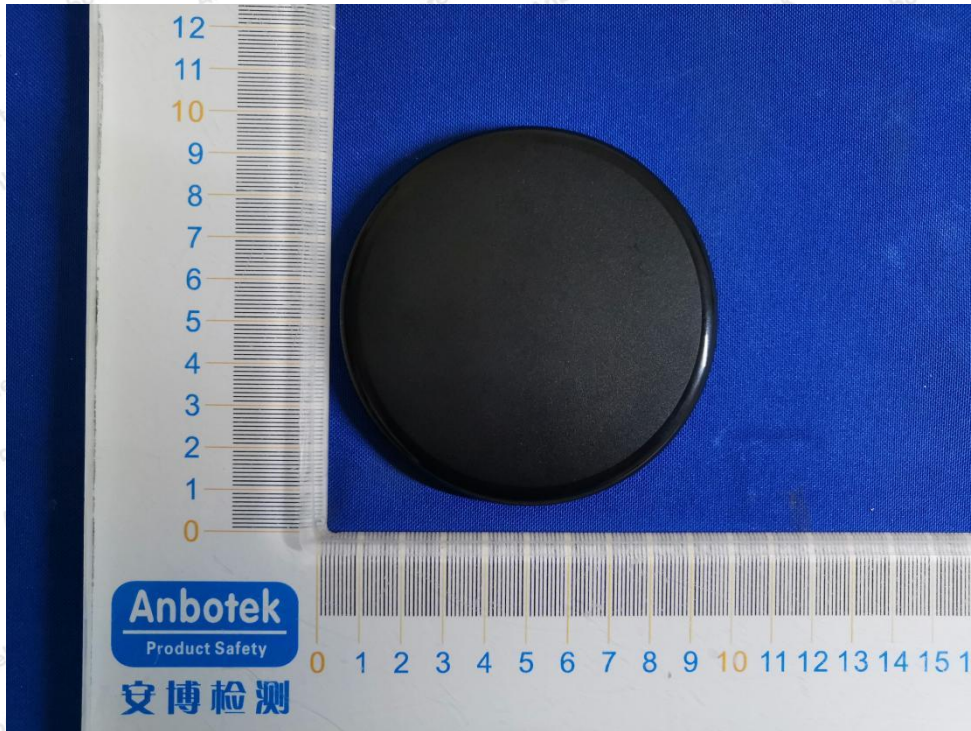

Photo of Radiation Emission Test





## APPENDIX II -- EXTERNAL PHOTOGRAPH









### APPENDIX III -- INTERNAL PHOTOGRAPH

ANT

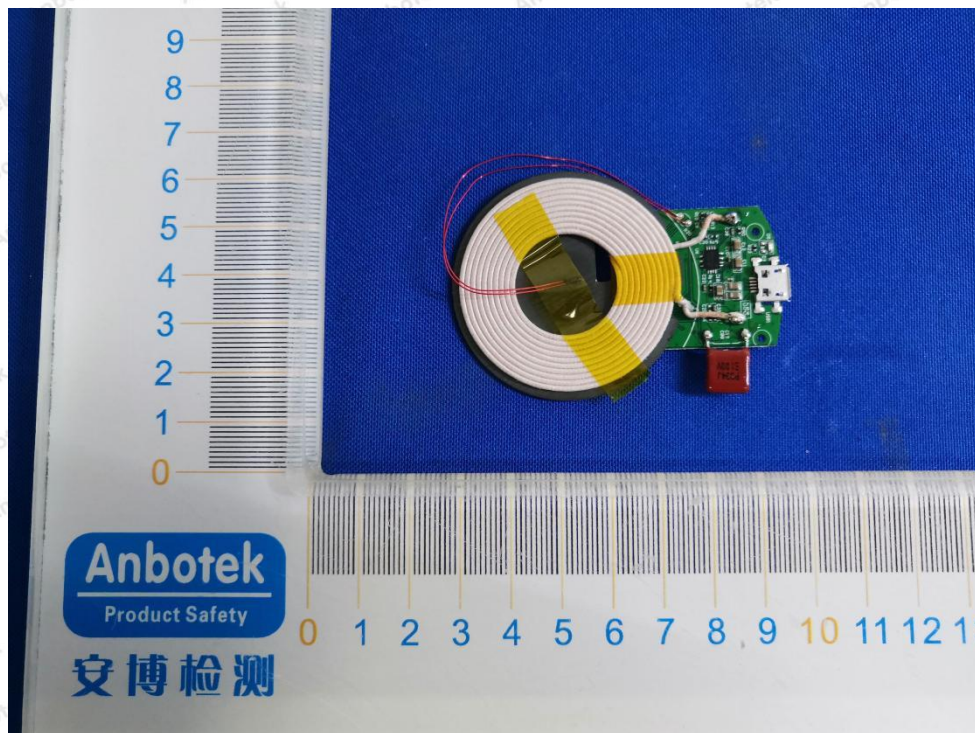
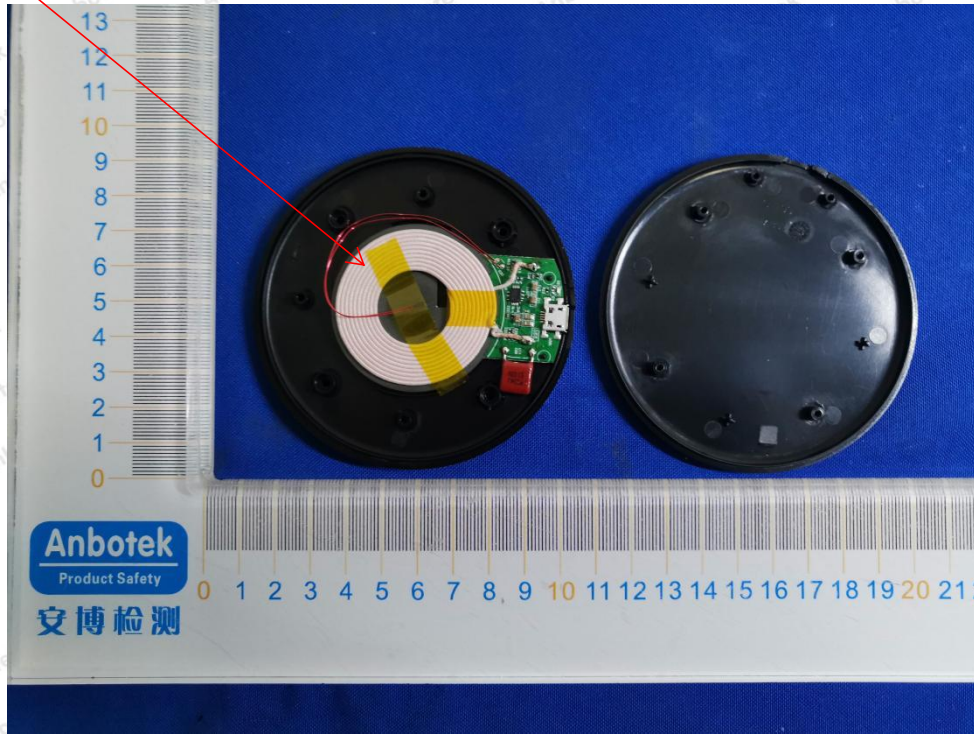

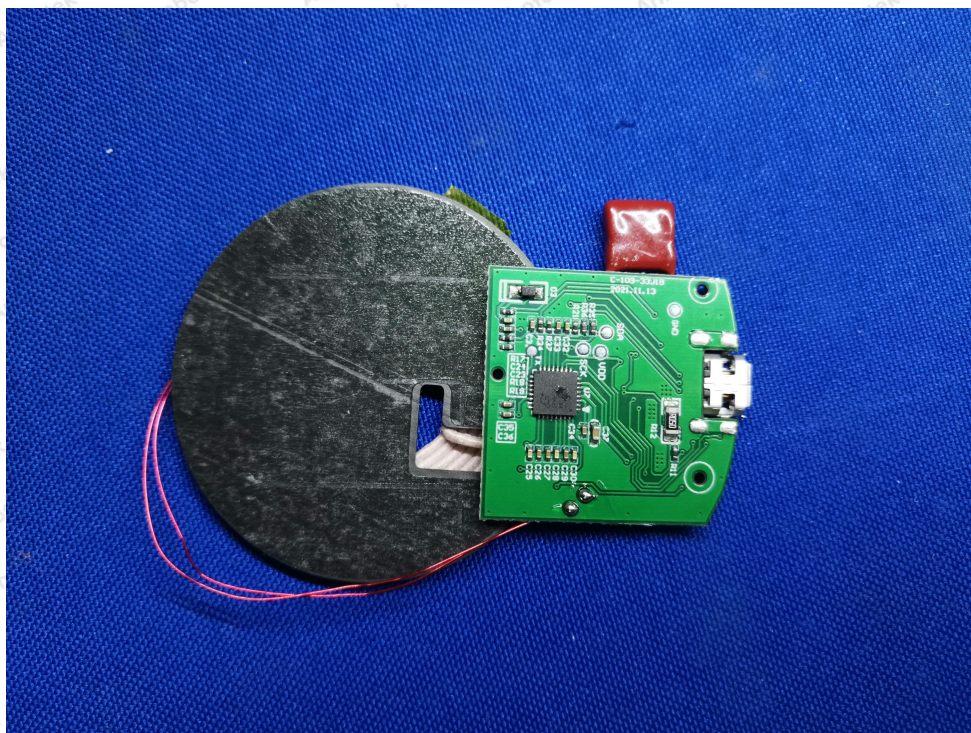
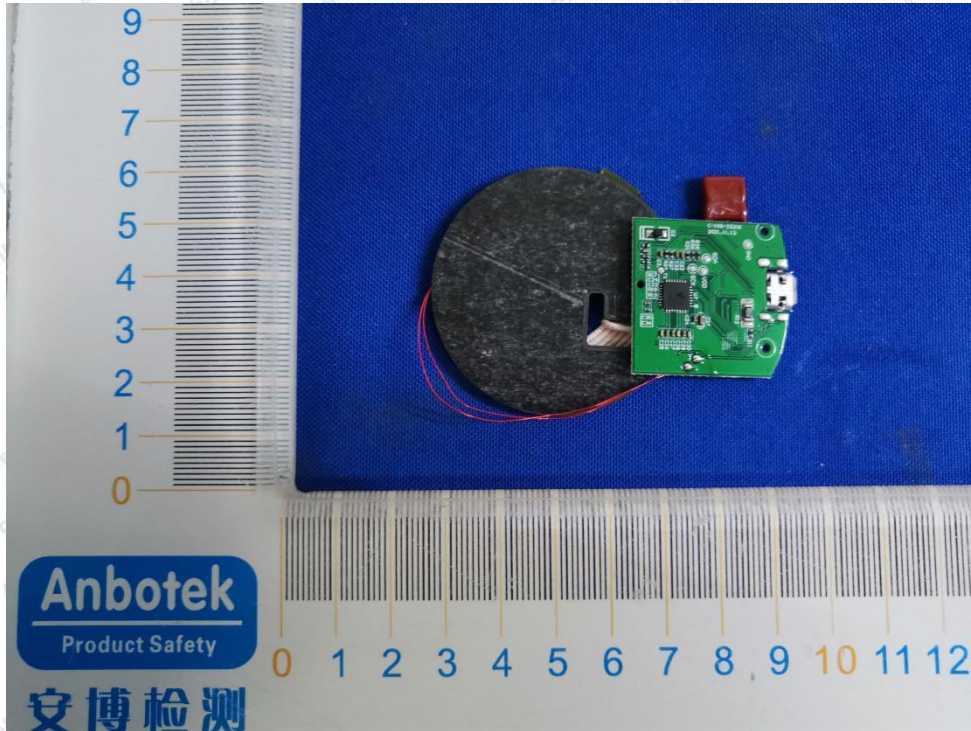

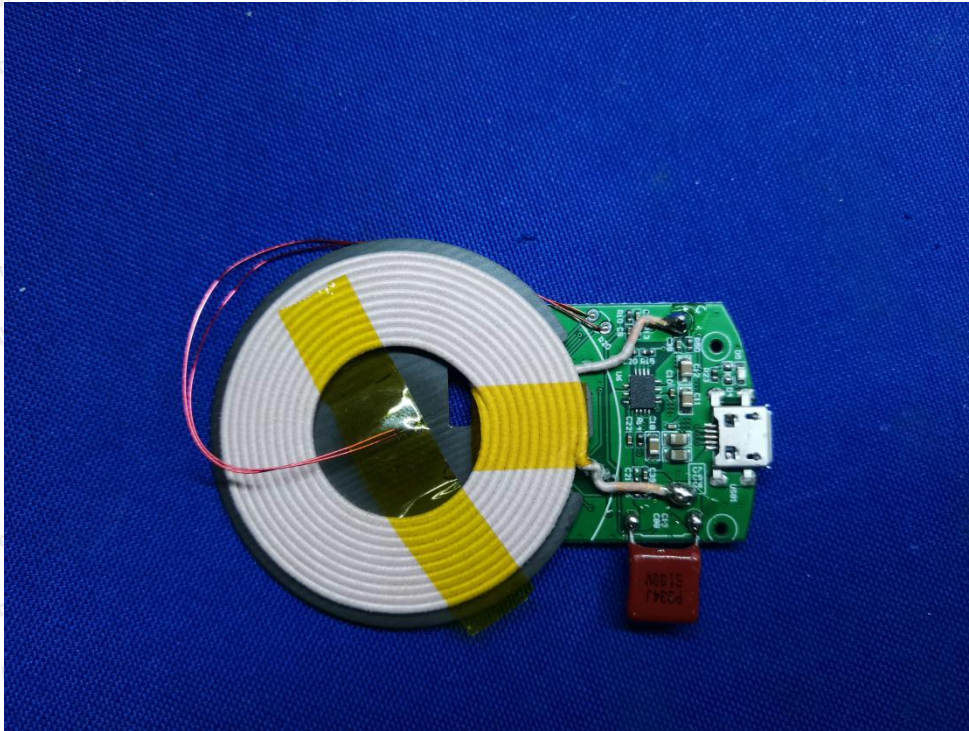

----- End of Report -----