

FCC TEST REPORT

Client Name : Dongguan Tyjin Electronics Co., Ltd.
Address : Room 101, Building 2, No.7 Keyan Road Wulian Village,
Fenggang Town, Dongguan, Guangdong, 523690 China
Product Name : Fast Wireless Charging
Date : Jul. 05, 2022



Shenzhen Anbotek Compliance Laboratory Limited

Contents

- 1. General Information 4
 - 1.1. Client Information 4
 - 1.2. Description of Device (EUT) 4
 - 1.3. Auxiliary Equipment Used During Test 5
 - 1.4. Description of Test Modes 5
 - 1.5. Description Of Test Setup 6
 - 1.6. Test Equipment List 7
 - 1.7. Measurement Uncertainty 8
 - 1.8. Description of Test Facility 8
- 2. Summary of Test Results 9
- 3. Conducted Emission Test 10
 - 3.1. Test Standard and Limit 10
 - 3.2. Test Setup 10
 - 3.3. Test Procedure 10
 - 3.4. Test Data 10
- 4. Radiation Spurious Emission 13
 - 4.1. Test Standard and Limit 13
 - 4.2. Test Setup 13
 - 4.3. Test Procedure 14
 - 4.4. Test Data 14
- 5. Antenna Requirement 19
 - 5.1. Test Standard and Requirement 19
 - 5.2. Antenna Connected Construction 19
- APPENDIX I -- TEST SETUP PHOTOGRAPH 20
- APPENDIX II -- EXTERNAL PHOTOGRAPH 22
- APPENDIX III -- INTERNAL PHOTOGRAPH 26

TEST REPORT

Applicant : Dongguan Tyjin Electronics Co., Ltd.
Manufacturer : Dongguan Tyjin Electronics Co., Ltd.
Product Name : Fast Wireless Charging
Model No. : C-093, HYC093, HMC093, C056, C059, C120, HY056, HM056, HY059
HM059, HY120, HMC120, HM006 HY006, HY008 HM008
Trade Mark : Proloadist, YIICOBAT
Rating(s) : Input: 5V \equiv 3A, 9V \equiv 2A
Output: 5W, 7.5 W, 10W
USB output: 5V \equiv 1A
Test Standard(s) : **FCC Part15 Subpart C, Paragraph 15.209**
Test Method(s) : **ANSI C63.10: 2020**

The device described above is tested by Shenzhen Anbotek Compliance Laboratory Limited to determine the maximum emission levels emanating from the device and the severe levels of the device can endure and its performance criterion. The measurement results are contained in this test report and Shenzhen Anbotek Compliance Laboratory Limited is assumed full of responsibility for the accuracy and completeness of these measurements. Also, this report shows that the EUT (Equipment Under Test) is technically compliant with the FCC Part 15 Subpart C requirements.

This report applies to above tested sample only and shall not be reproduced in part without written approval of Shenzhen Anbotek Compliance Laboratory Limited.

Date of Receipt

Jun. 01, 2022

Date of Test

Jun. 01~ 13, 2022

Prepared By



(TuTu Hong)

Approved & Authorized Signer



(Kingkong Jin)

1. General Information

1.1. Client Information

Applicant	:	Dongguan Tyjin Electronics Co., Ltd.
Address	:	Room 101, Building 2, No.7 Keyan Road Wulian Village, Fenggang Town, Dongguan, Guangdong, 523690 China
Manufacturer	:	Dongguan Tyjin Electronics Co., Ltd.
Address	:	Room 101, Building 2, No.7 Keyan Road Wulian Village, Fenggang Town, Dongguan, Guangdong, 523690 China
Factory	:	Dongguan Tyjin Electronics Co., Ltd.
Address	:	Room 101, Building 2, No.7 Keyan Road Wulian Village, Fenggang Town, Dongguan, Guangdong, 523690 China

1.2. Description of Device (EUT)

Product Name	:	Fast Wireless Charging
Model No.	:	C-093, HYC093, HMC093, C056, C059, C120, HY056, HM056, HY059, HM059, HY120, HMC120, HM006, HY006, HY008, HM008 (Note: All samples are the same except the model number, so we prepare "C-093" for test only.)
Trade Mark	:	Proloadist, YIICOBAT
Test Power Supply	:	AC 120V, 60Hz for adapter
Test Sample No.	:	1-2-1(Normal Sample), 1-2-2(Engineering Sample)
Product Description	Operation Frequency:	110.1-205KHz
	Modulation Type:	ASK
	Antenna Type:	Inductive loop coil Antenna
	Antenna Gain(Peak):	0 dBi (Provided by customer)
	Adapter:	N/A
Remark: 1) For a more detailed features description, please refer to the manufacturer's specifications or the User's Manual.		

1.3. Auxiliary Equipment Used During Test

Adapter	:	M/N: MDY-11-EX Input: 100-240V-0.7A,50-60Hz Output: 5V3A,9V3A,12V2.25A,20V1.35A.11V3A
Wireless charging load	:	Manufacturer: Shenzhen Ouju Technology Co., Ltd. M/N: CD2577 Power: 5W/7.5W/10W/15W Last Cal.: Oct. 26, 2020 Cal. Interval: 1 Year

1.4. Description of Test Modes

To investigate the maximum EMI emission characteristics generates from EUT, the test system was pre-scanning tested base on the consideration of following EUT operation mode or test configuration mode which possible have effect on EMI emission level. Each of these EUT operation mode(s) or test configuration mode(s) mentioned above was evaluated respectively.

Pretest Mode	Description
Mode 1	WPT Mode

For Conducted Emission	
Final Test Mode	Description
Mode 1	WPT Mode

For Radiated Emission	
Final Test Mode	Description
Mode 1	WPT Mode

Note: (1)Test channel is 0.1285MHz.

(2) All the situation(full load, half load and empty load) has been tested,only the worst situation (full load 10W) was recorded in the report.

1.5. Description Of Test Setup

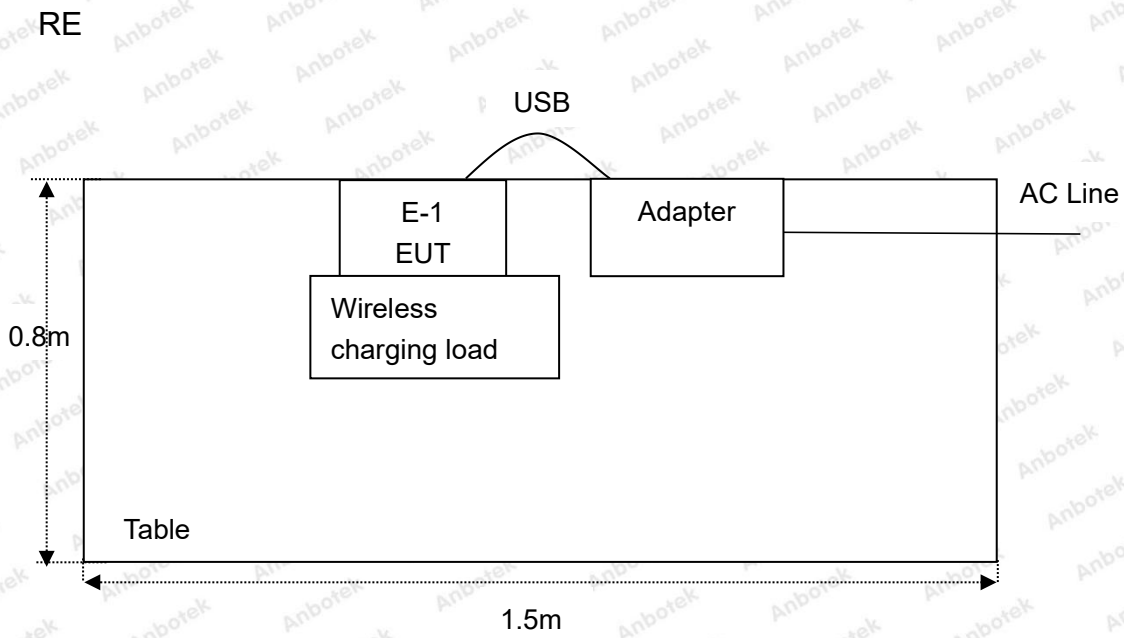
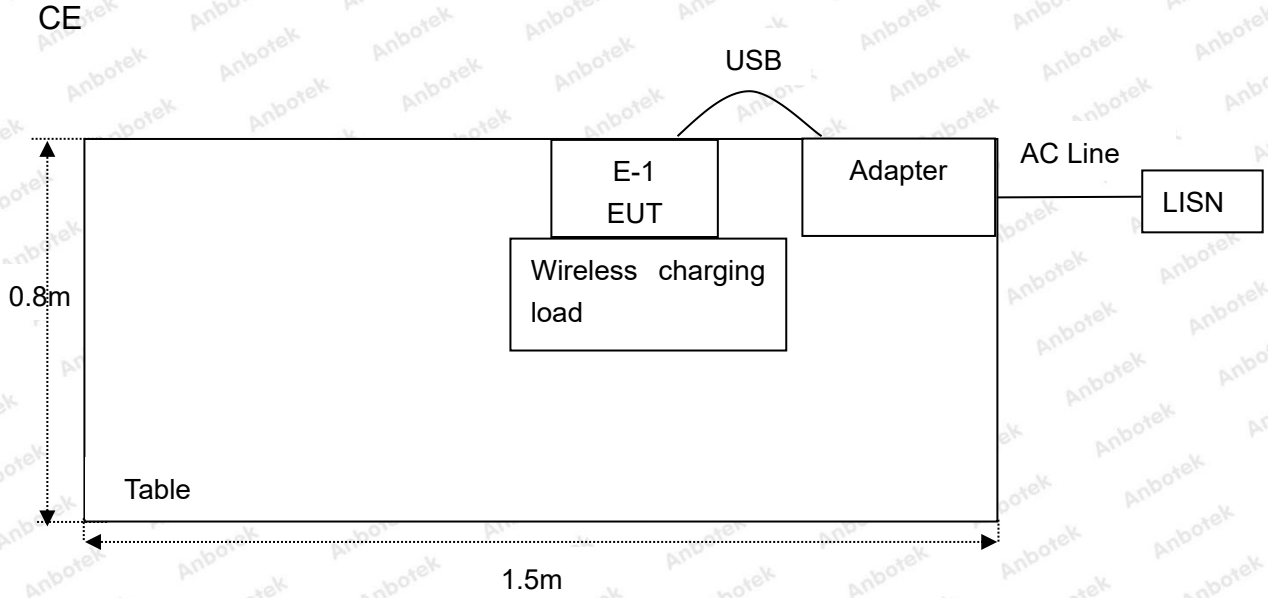

1.6. Test Equipment List

Item	Equipment	Manufacturer	Model No.	Serial No.	Last Cal.	Cal. Interval
1.	Three Phase V-type Artificial Power Network	CYBERTEK	EM5040DT	E215040DT001	Jul 05, 2021	1 Year
2.	EMI Test Receiver	Rohde & Schwarz	ESCI	100627	Oct. 22, 2021	1 Year
3.	EMI Test Receiver	Rohde & Schwarz	ESR26	101481	Oct. 22, 2021	1 Year
4.	RF Switching Unit	Compliance Direction	RSU-M2	38303	Oct. 22, 2021	1 Year
5.	MAX Spectrum Analysis	Agilent	N9020A	MY51170037	Oct. 22, 2021	1 Year
6.	Preamplifier	SKET Electronic	BK1G18G30 D	KD17503	Oct. 22, 2021	1 Year
7.	Double Ridged Horn Antenna	Instruments corporation	GTH-0118	351600	Oct. 22, 2021	2 Year
8.	Bilog Broadband Antenna	Schwarzbeck	VULB9163	VULB 9163-289	Oct. 22, 2021	2 Year
9.	Loop Antenna	Schwarzbeck	FMZB1519B	00053	Oct. 22, 2021	2 Year
10.	Horn Antenna	A-INFO	LB-180400-K F	J211060628	Oct. 22, 2021	2 Year
11.	Pre-amplifier	SONOMA	310N	186860	Oct. 22, 2021	1 Year
12.	EMI Test Software EZ-EMC	SHURPLE	N/A	N/A	N/A	N/A
13.	RF Test Control System	YIHENG	YH3000	2017430	Oct. 22, 2021	1 Year
14.	Power Sensor	DAER	RPR3006W	15I00041SN045	Oct. 22, 2021	1 Year
15.	Power Sensor	DAER	RPR3006W	15I00041SN046	Oct. 22, 2021	1 Year
16.	MXA Spectrum Analysis	KEYSIGHT	N9020A	MY53280032	Oct. 22, 2021	1 Year
17.	MXG RF Vector Signal Generator	Agilent	N5182A	MY48180656	Oct. 22, 2021	1 Year
18.	Signal Generator	Agilent	E4421B	MY41000743	Oct. 22, 2021	1 Year
19.	DC Power Supply	IVYTECH	IV3605	1804D360510	Oct. 22, 2021	1 Year
20.	Constant Temperature Humidity Chamber	ZHONGJIAN	ZJ-KHWS80 B	N/A	Oct. 22, 2021	1 Year

1.7. Measurement Uncertainty

Radiation Uncertainty	:	Ur = 3.9 dB (Horizontal)
		Ur = 3.8 dB (Vertical)
Conduction Uncertainty	:	Uc = 3.4 dB

1.8. Description of Test Facility

The test facility is recognized, certified, or accredited by the following organizations:

FCC-Registration No.: 184111

Shenzhen Anbotek Compliance Laboratory Limited, EMC Laboratory has been registered and fully described in a report filed with the (FCC) Federal Communications Commission. The acceptance letter from the FCC is maintained in our files. Registration No. 184111.

ISED-Registration No.: 8058A

Shenzhen Anbotek Compliance Laboratory Limited, EMC Laboratory has been registered and fully described in a report filed with the (ISED) Innovation, Science and Economic Development Canada. The acceptance letter from the ISED is maintained in our files. Registration 8058A.

Test Location

Shenzhen Anbotek Compliance Laboratory Limited.

1/F, Building D, Sogood Science and Technology Park, Sanwei community, Hangcheng Street, Bao'an District, Shenzhen, Guangdong, China.518102

2. Summary of Test Results

Standard Section	Test Item	Result
FCC Part 15, Paragraph 15.207	Conducted Emission Test	PASS
FCC Part 15, Paragraph 15.209(a)(f)	Spurious Emission	PASS
Part 15.203	Antenna Requirement	PASS

3. Conducted Emission Test

3.1. Test Standard and Limit

Test Standard	FCC Part15 Section 15.207		
Test Limit	Frequency	Maximum RF Line Voltage (dBuV)	
		Quasi-peak Level	Average Level
	150kHz~500kHz	66 ~ 56 *	56 ~ 46 *
	500kHz~5MHz	56	46
	5MHz~30MHz	60	50
Remark: (1) *Decreasing linearly with logarithm of the frequency. (2) The lower limit shall apply at the transition frequency.			

3.2. Test Setup

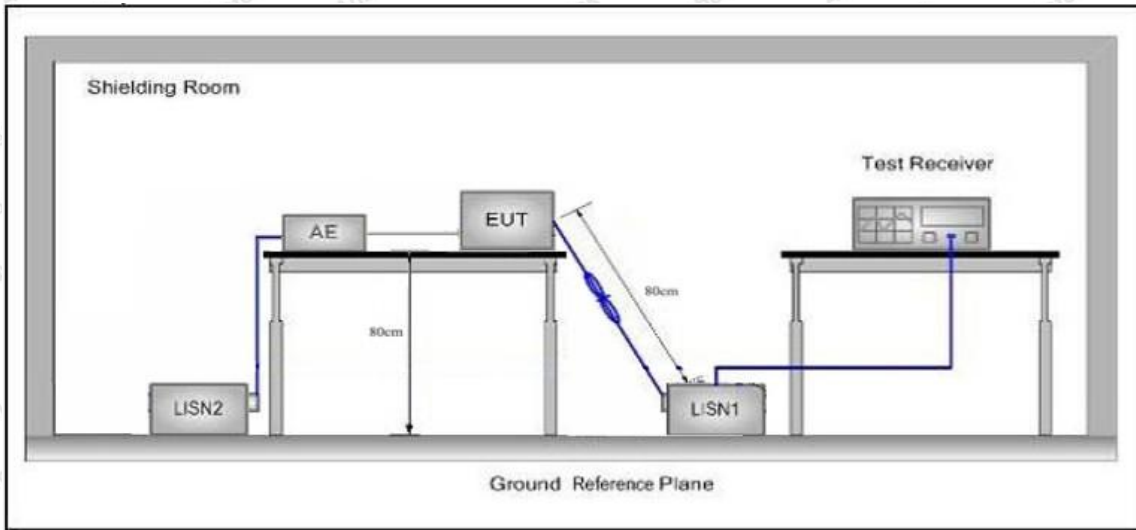

3.3. Test Procedure

The EUT system is connected to the power mains through a line impedance stabilization network (L.I.S.N.). This provides a 50ohm coupling impedance for the EUT system. Please refer the block diagram of the test setup and photographs. Both sides of AC line are checked to find out the maximum conducted emission. In order to find the maximum emission levels, the relative positions of equipment and all of the interface cables shall be changed according to FCC ANSI C63.10-2020 on Conducted Emission Measurement.

The bandwidth of test receiver (ESCI) set at 9kHz.

The frequency range from 150kHz to 30MHz is checked.

3.4. Test Data

Please to see the following pages

Shenzhen Anbotek Compliance Laboratory Limited

Conducted Emission Test Data

Test Site: 1# Shielded Room
 Operating Condition: Mode 1
 Test Specification: AC 120V, 60Hz for adapter
 Comment: Live Line
 Tem.: 23.5°C Hum.: 46%

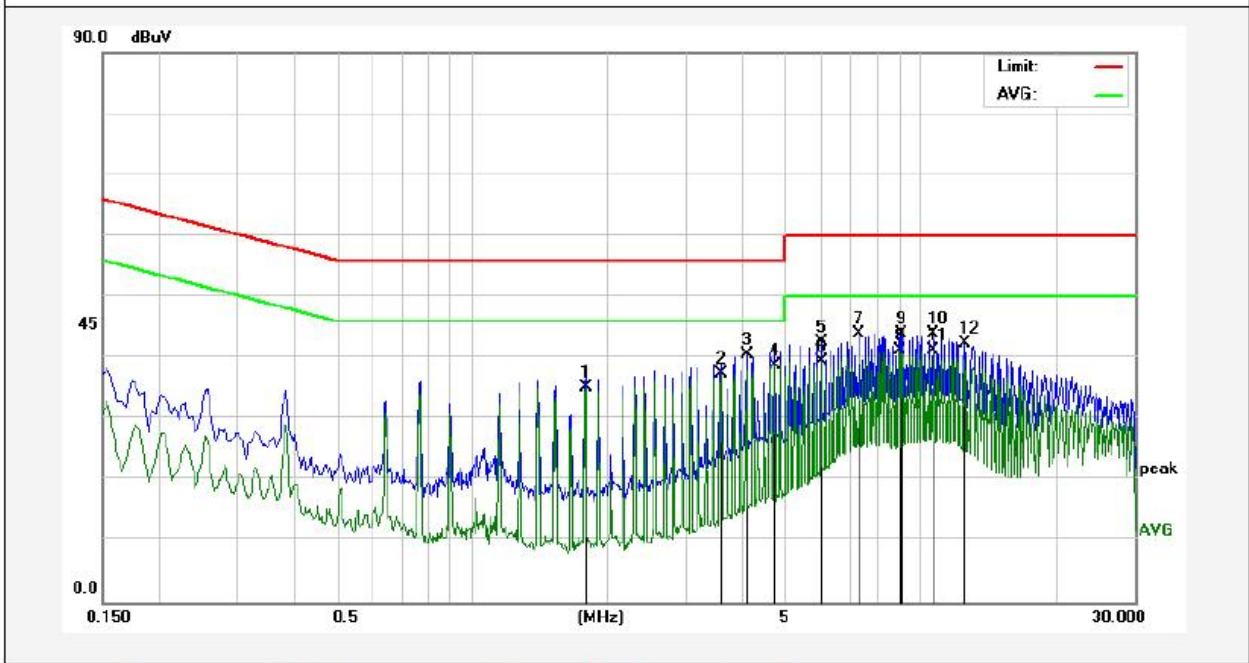

No.	Freq. (MHz)	Reading (dBuV)	Factor (dB)	Result (dBuV)	Limit (dBuV)	Over Limit (dB)	Detector	Remark
1	1.7940	35.16	0.13	35.29	46.00	-10.71	AVG	
2	3.5860	37.40	0.12	37.52	46.00	-8.48	AVG	
3	4.0980	40.60	0.11	40.71	56.00	-15.29	QP	
4	4.7380	38.65	0.11	38.76	46.00	-7.24	AVG	
5	6.0180	42.49	0.11	42.60	60.00	-17.40	QP	
6	6.0180	39.38	0.11	39.49	50.00	-10.51	AVG	
7	7.2980	43.93	0.11	44.04	60.00	-15.96	QP	
8	8.9620	41.12	0.12	41.24	50.00	-8.76	AVG	
9	9.0900	43.87	0.12	43.99	60.00	-16.01	QP	
10	10.6260	43.79	0.13	43.92	60.00	-16.08	QP	
11	10.6260	41.11	0.13	41.24	50.00	-8.76	AVG	
12	12.5460	42.18	0.15	42.33	60.00	-17.67	QP	

Conducted Emission Test Data

Test Site: 1# Shielded Room
 Operating Condition: Mode 1
 Test Specification: AC 120V, 60Hz for adapter
 Comment: Neutral Line
 Tem.: 23.5°C Hum.: 46%

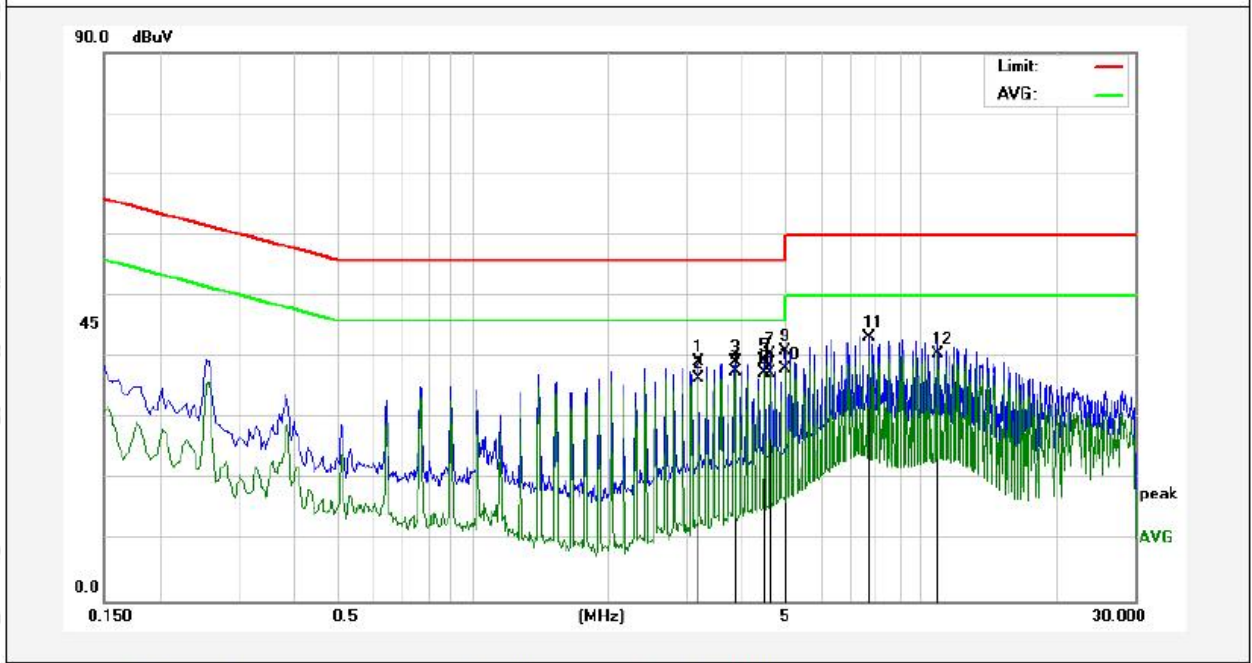

No.	Freq. (MHz)	Reading (dBuV)	Factor (dB)	Result (dBuV)	Limit (dBuV)	Over Limit (dB)	Detector	Remark
1	3.2020	39.23	0.12	39.35	56.00	-16.65	QP	
2	3.2020	36.54	0.12	36.66	46.00	-9.34	AVG	
3	3.8420	39.18	0.12	39.30	56.00	-16.70	QP	
4	3.8420	37.48	0.12	37.60	46.00	-8.40	AVG	
5	4.4820	39.35	0.11	39.46	56.00	-16.54	QP	
6	4.4820	37.29	0.11	37.40	46.00	-8.60	AVG	
7	4.6100	40.48	0.11	40.59	56.00	-15.41	QP	
8	4.6100	37.42	0.11	37.53	46.00	-8.47	AVG	
9	4.9940	40.84	0.11	40.95	56.00	-15.05	QP	
10	4.9940	38.00	0.11	38.11	46.00	-7.89	AVG	
11	7.6780	43.21	0.12	43.33	60.00	-16.67	QP	
12	10.8820	40.38	0.13	40.51	50.00	-9.49	AVG	

4. Radiation Spurious Emission

4.1. Test Standard and Limit

Test Standard	FCC Part15 C Section 15.209 and 15.205				
Test Limit	Frequency (MHz)	Field strength (microvolt/meter)	Limit (dBuV/m)	Remark	Measurement distance (m)
	0.009MHz~0.490MHz	2400/F(kHz)	-	-	300
	0.490MHz-1.705MHz	24000/F(kHz)	-	-	30
	1.705MHz-30MHz	30	-	-	30
	30MHz~88MHz	100	40.0	Quasi-peak	3
	88MHz~216MHz	150	43.5	Quasi-peak	3
	216MHz~960MHz	200	46.0	Quasi-peak	3
	960MHz~1000MHz	500	54.0	Quasi-peak	3
	Above 1000MHz	500	54.0	Average	3
-		-	74.0	Peak	3

Remark:

- (1)The lower limit shall apply at the transition frequency.
- (2) 15.35(b), Unless otherwise specified, the limit on peak radio frequency emissions is 20dB above the maximum permitted average emission limit applicable to the equipment under test. This peak limit applies to the total peak emission level radiated by the device.

4.2. Test Setup

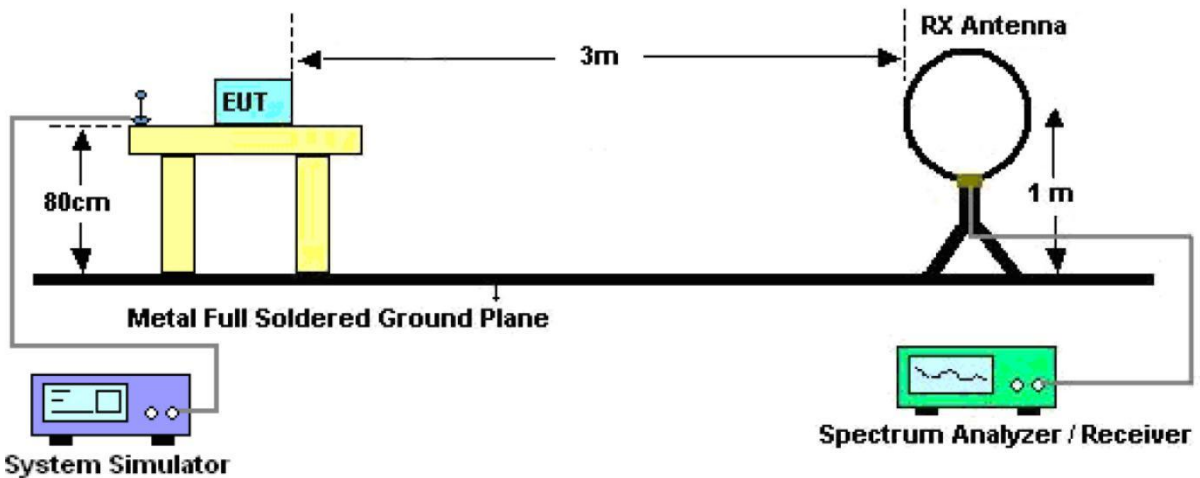

Figure 1. Below 30MHz

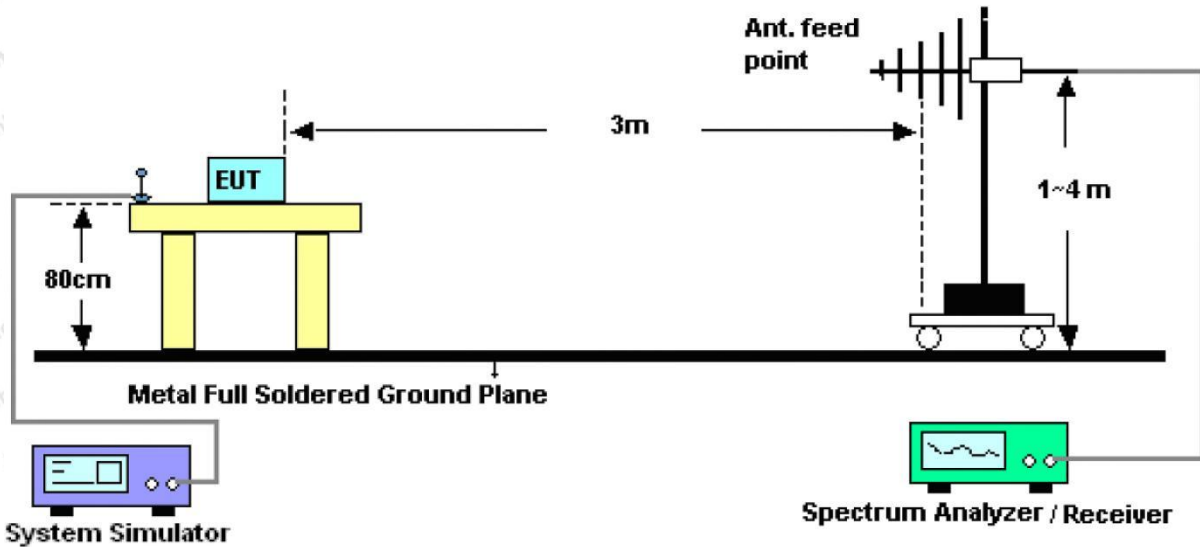

Figure 2. 30MHz to 1GHz

4.3. Test Procedure

For below 1GHz: The EUT is placed on a turntable, which is 0.8m above the ground plane. The turn table can rotate 360 degrees to determine the position of the maximum emission level. The EUT is set 3 meters away from the receiving antenna which is mounted on a antenna tower. The antenna can be moved up and down from 1 to 4 meters to find out the maximum emission level. Rotated the EUT through three orthogonal axes to determine the maximum emissions, both horizontal and vertical polarization of the antenna are set on test. The EUT is tested in 9*6*6 Chamber. The device is evaluated in xyz orientation.

For 9kHz to 150kHz, Set the spectrum analyzer as:

RBW = 200Hz, VBW = 1kHz, Detector= Quasi-Peak, Trace mode= Max hold, Sweep- auto couple.

For 150kHz to 30MHz, Set the spectrum analyzer as:

RBW = 9kHz, VBW = 30kHz, Detector= Quasi-Peak, Trace mode= Max hold, Sweep- auto couple.

For 30MHz to 1000MHz, Set the spectrum analyzer as:

RBW = 100kHz, VBW = 300kHz, Detector= Quasi-Peak, Trace mode= Max hold, Sweep- auto couple.

4.4. Test Data

PASS

Note: The data is in TX mode, and this is the worst mode.

Test Results

(Between 9KHz – 30MHz)

Standard: FCC PART15 C_3m **Power Source:** AC 120V, 60Hz for adapter
Test item: Radiation Test **Temp.(C)/Hum.(%RH):** 22.7°C/49%RH
Test Mode: Mode 1 **Distance:** 3m

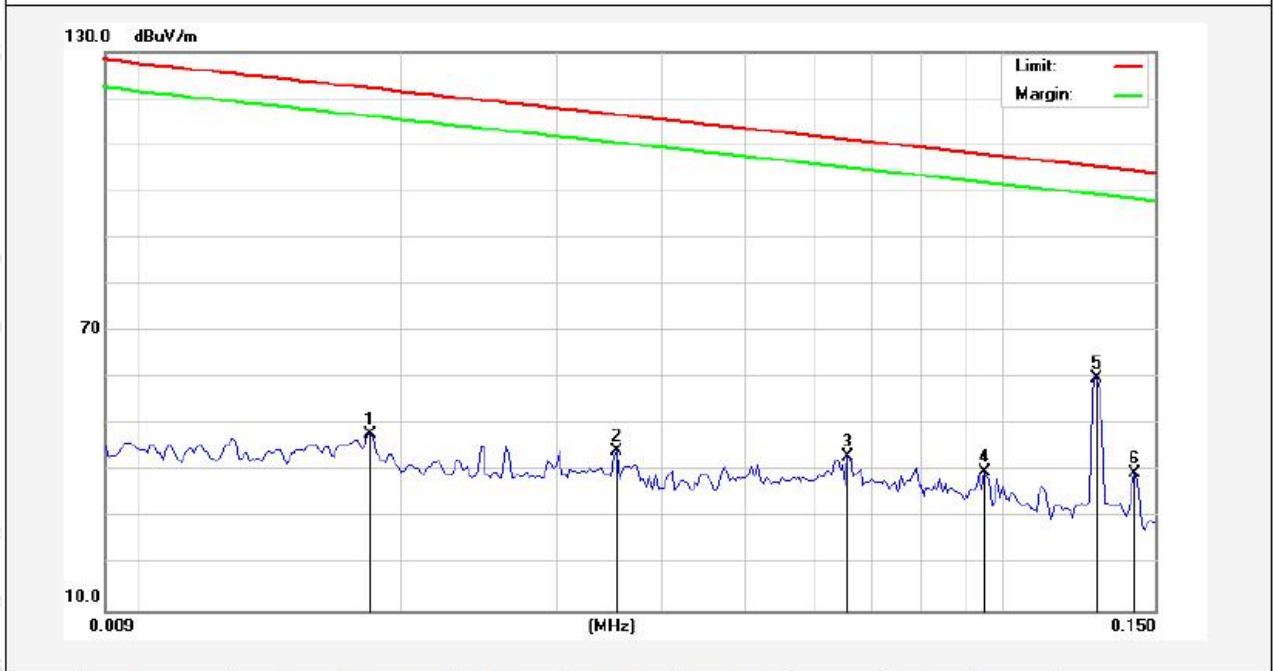

No.	Freq. (MHz)	Reading (dBuV)	Factor (dB/m)	Result (dBuV/m)	Limit (dBuV/m)	Over Limit (dB)	Detector	Height (cm)	degree (deg)	Remark
1	0.0183	27.82	20.23	48.05	122.18	-74.13	AV			
2	0.0354	23.73	20.47	44.20	116.48	-72.28	AV			
3	0.0659	22.78	20.38	43.16	111.12	-67.96	AV			
4	0.0950	19.52	20.29	39.81	107.96	-68.15	AV			
5	0.1285	39.71	20.34	60.05	105.35	-45.30	AV			
6	0.1418	19.22	20.33	39.55	104.50	-64.95	AV			

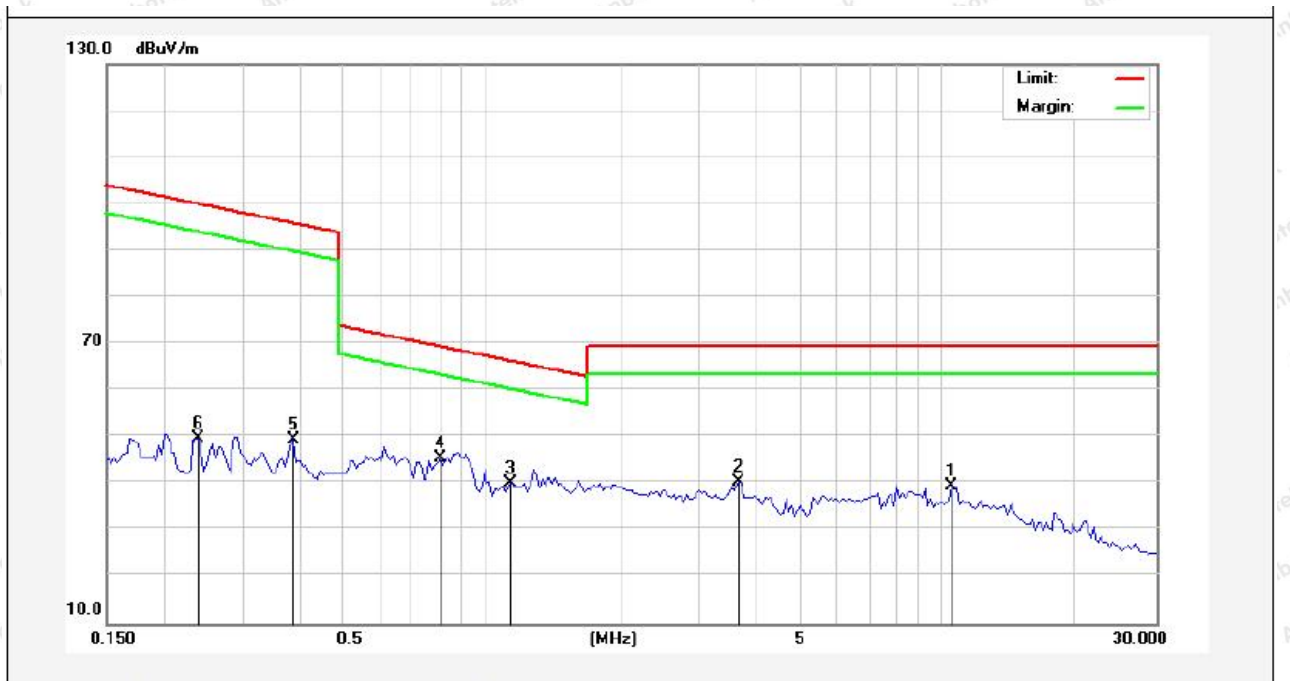

No.	Freq. (MHz)	Reading (dBuV)	Factor (dB/m)	Result (dBuV/m)	Limit (dBuV/m)	Over Limit (dB)	Detector	Height (cm)	degree (deg)	Remark
1	10.6760	19.03	20.52	39.55	69.50	-29.95	QP			
2	3.6514	20.06	20.34	40.40	69.50	-29.10	QP			
3	1.1532	19.94	20.26	40.20	66.39	-26.19	QP			
4	0.8064	25.34	20.26	45.60	69.48	-23.88	QP			
5	0.3840	29.13	20.28	49.41	95.90	-46.49	AV			
6	0.2384	29.49	20.30	49.79	100.02	-50.23	AV			

Remark: According to FCC PART 15.209 (d), the emission limits for the frequency bands 9–90 kHz, 110–490 kHz and above 1000 MHz, Radiated emission limits in these three bands are based on measurements employing an average detector.

(Between 30MHz –1000 MHz)

Standard:	FCC PART15 C _3m	Polarization:	Horizontal
Test item:	Radiation Test	Power Source:	AC 120V, 60Hz for adapter
Test Mode:	Mode 1	Temp.(C)/Hum.(%RH):	23.3°C/452%RH
Distance:	3m		

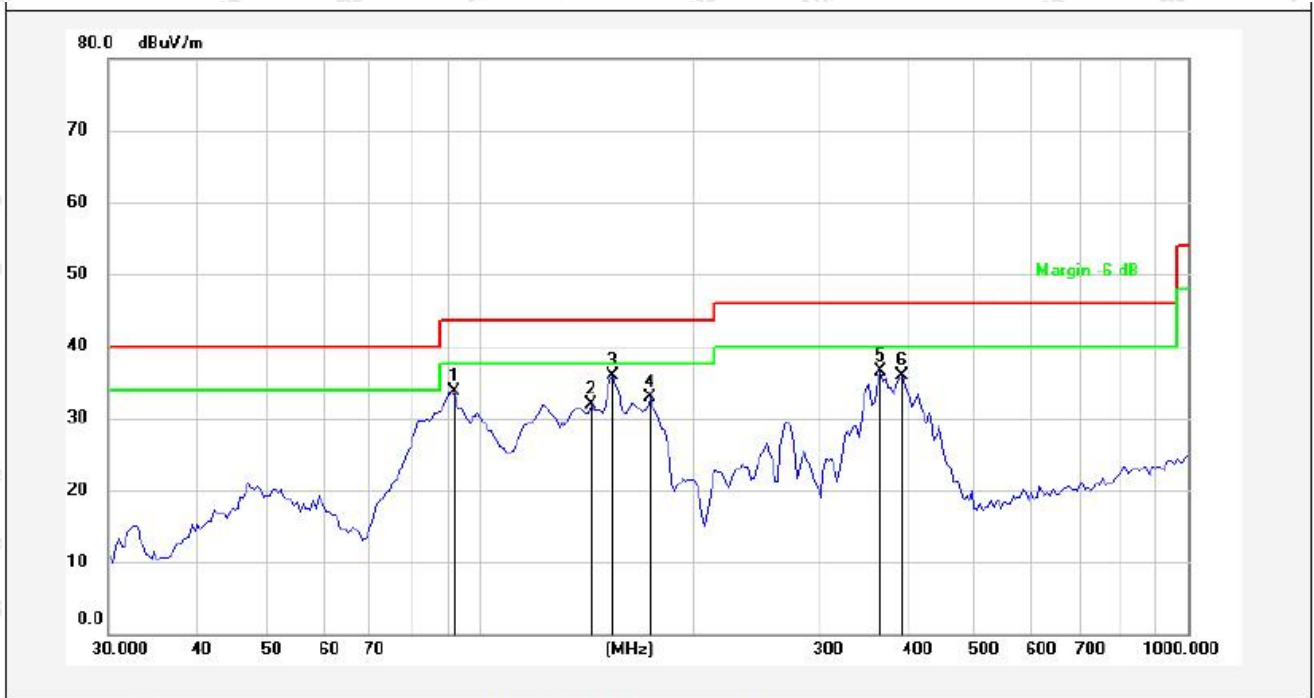

No.	Freq. (MHz)	Reading (dBUV)	Factor ()	Result (dBUV/m)	Limit (dBUV/m)	Over Limit (dB)	Detector	Height (cm)	degree (deg)	Remark
1	91.3346	51.85	-18.14	33.71	43.50	-9.79	QP			
2	144.0819	53.20	-21.26	31.94	43.50	-11.56	QP			
3	154.5493	56.83	-20.84	35.99	43.50	-7.51	QP			
4	174.7301	52.55	-19.66	32.89	43.50	-10.61	QP			
5	368.1116	49.62	-13.19	36.43	46.00	-9.57	QP			
6	394.8545	48.51	-12.54	35.97	46.00	-10.03	QP			

Standard: FCC PART15 C_3m **Polarization:** Vertical
Test item: Radiation Test **Power Source:** AC 120V, 60Hz for adapter
Test Mode: Mode 1 **Temp.(C)/Hum.(%RH):** 23.3°C/45%RH
Distance: 3m



No.	Freq. (MHz)	Reading (dBuV)	Factor ()	Result (dBuV/m)	Limit (dBuV/m)	Over Limit (dB)	Detector	Height (cm)	degree (deg)	Remark
1	32.4628	51.31	-18.04	33.27	40.00	-6.73	QP			
2	53.0382	50.22	-17.33	32.89	40.00	-7.11	QP			
3	87.4177	52.17	-19.19	32.98	40.00	-7.02	QP			
4	155.9101	57.13	-20.77	36.36	43.50	-7.14	QP			
5	171.6933	51.88	-19.84	32.04	43.50	-11.46	QP			
6	416.1791	45.04	-12.12	32.92	46.00	-13.08	QP			

5. Antenna Requirement

5.1. Test Standard and Requirement

Test Standard	FCC Part15 Section 15.203
Requirement	An intentional radiator shall be designed to ensure that no antenna other than that furnished by the responsible party shall be used with the device. The use of a permanently attached antenna or of an antenna that uses a unique coupling to the intentional radiator, the manufacturer may design the unit so that a broken antenna can be replaced by the user, but the use of a standard antenna jack or electrical connector is prohibited.

5.2. Antenna Connected Construction

The antenna is a Inductive loop coil Antenna which permanently attached, and the best case gain of the antenna is 0 dBi. It complies with the standard requirement.

APPENDIX I -- TEST SETUP PHOTOGRAPH

Photo of Conducted Emission Measurement



Photo of Radiation Emission Test





APPENDIX II -- EXTERNAL PHOTOGRAPH







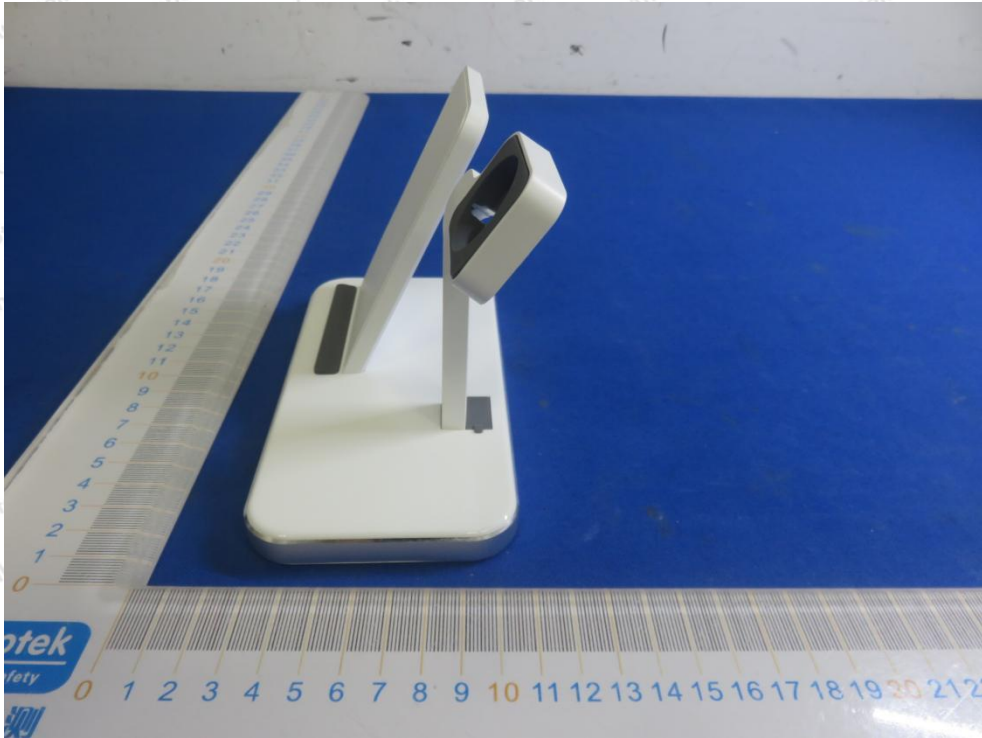

APPENDIX III -- INTERNAL PHOTOGRAPH



ANT

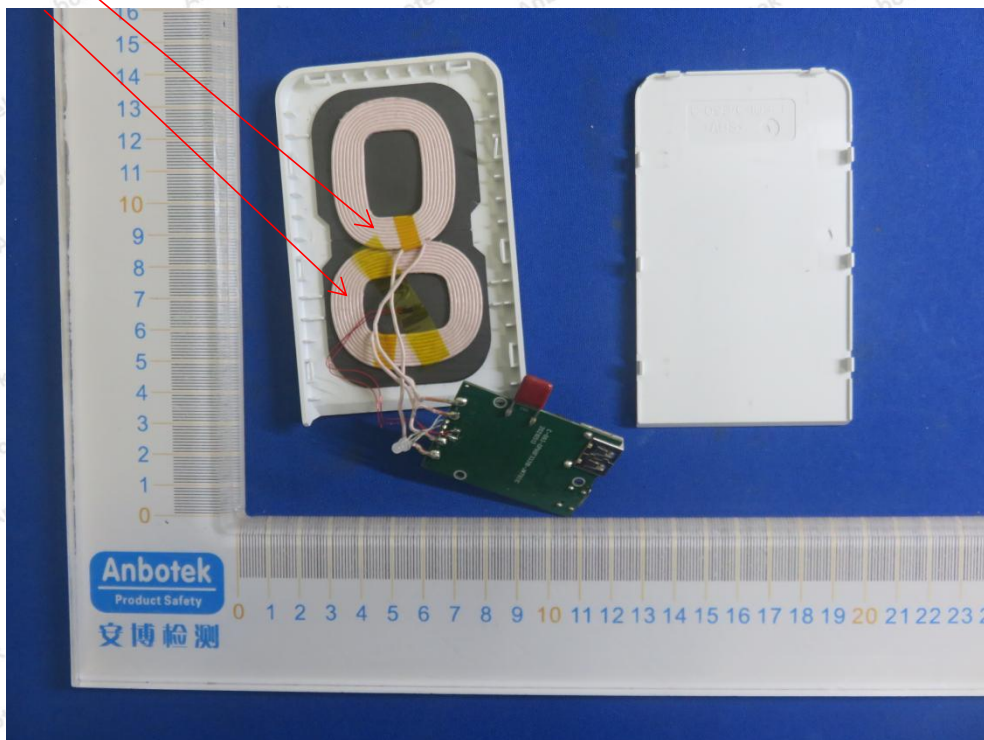

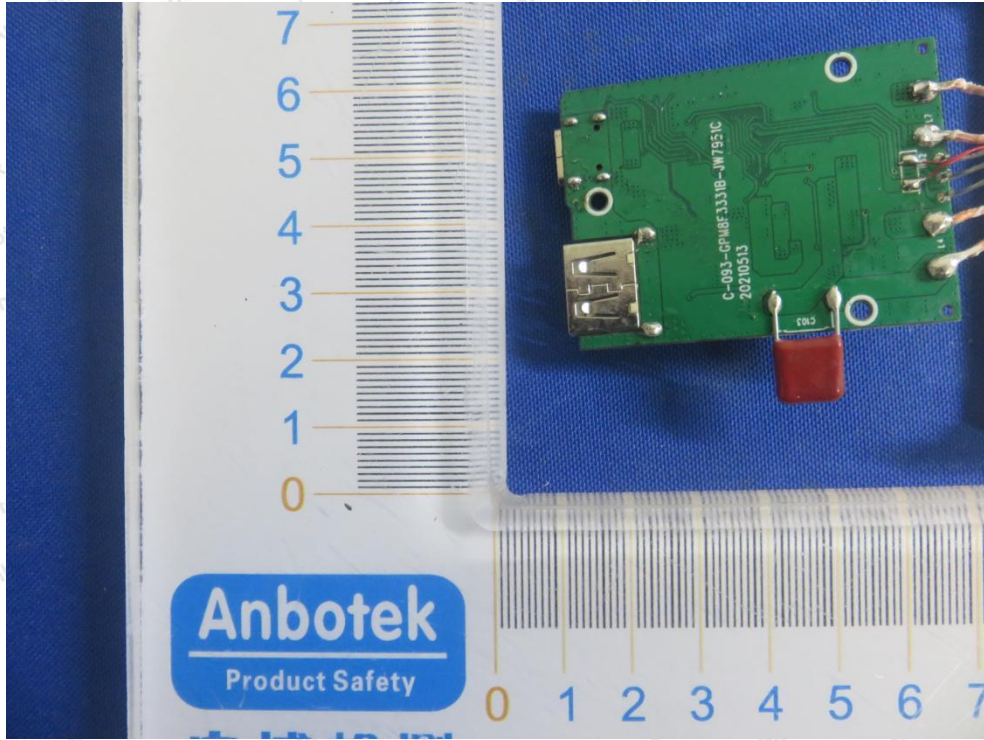

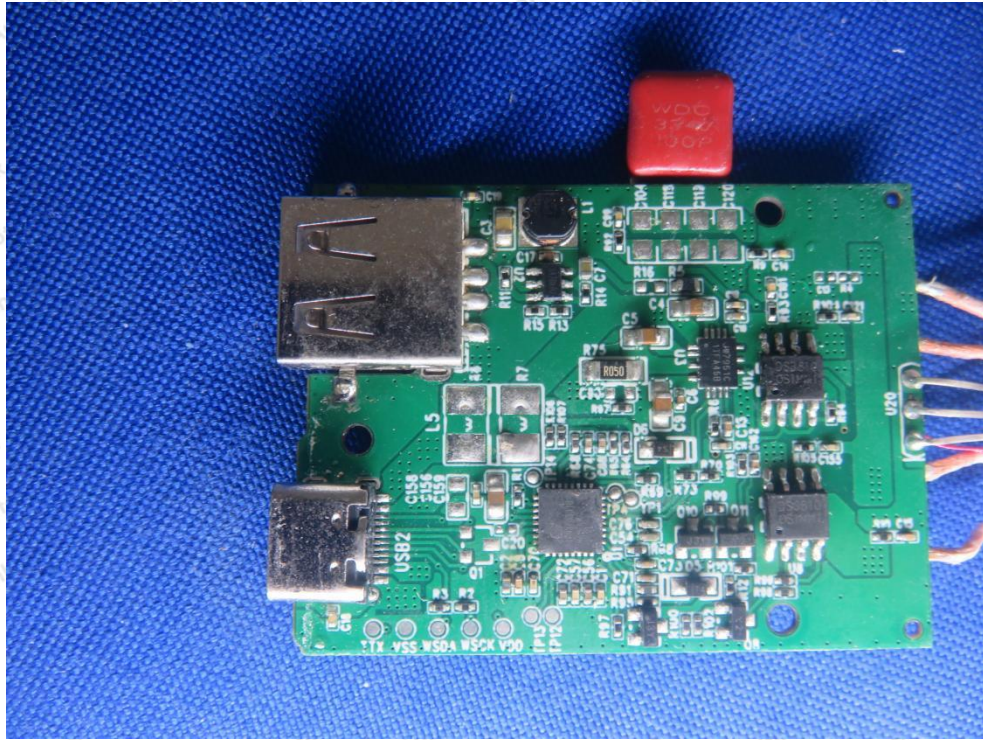

----- End of Report -----

Shenzhen Anbotek Compliance Laboratory Limited

Address: 1/F., Building D, Sogood Science and Technology Park, Sanwei Community, Hangcheng Street, Bao'an District, Shenzhen, Guangdong, China.

Tel: (86) 755-2606440 Fax: (86) 755-26014772 Email: service@anbotek.com

Code: AB-RF-05-a

Hotline
400-003-0500
www.anbotek.com