



HAC RF TESTREPORT

No. I18Z61354-SEM02

For

FOXX Development Inc.

Smartphone MIRO

Model Name: L590A

With

Hardware Version: L590MB_V0.4

Software Version: R02.V04

FCC ID: 2AQRMFXMC52401

Results Summary: M Category = M4

Issued Date: 2018-11-8



Note:

The test results in this test report relate only to the devices specified in this report. This report shall not be reproduced except in full without the written approval of CTTL.

The report must not be used by the client to claim product certification, approval, or endorsement by NVLAP, NIST, or any agency of the U.S. Government.

Test Laboratory:

CTTL, Telecommunication Technology Labs, CAICT

No. 51, Xueyuan Road, Haidian District, Beijing, P. R. China 100191.

Tel:+86(0)10-62304633-2512, Fax:+86(0)10-62304633-2504



REPORT HISTORY

Report Number	Revision	Issue Date	Description
I18Z61354-SEM02	Rev.0	2018-10-23	Initial creation of test report
I18Z61354-SEM02	Rev.1	2018-11-8	Update the product name and Manufacturer information Update the Reference Documents



TABLE OF CONTENT

1 TEST LABORATORY	5
1.1 TESTING LOCATION	5
1.2 TESTING ENVIRONMENT.....	5
1.3 PROJECT DATA	5
1.4 SIGNATURE.....	5
2 CLIENT INFORMATION	6
2.1 APPLICANT INFORMATION	6
2.2 MANUFACTURER INFORMATION	6
3 EQUIPMENT UNDER TEST (EUT) AND ANCILLARY EQUIPMENT (AE)	7
3.1 ABOUT EUT	7
3.2 INTERNAL IDENTIFICATION OF EUT USED DURING THE TEST	7
3.3 INTERNAL IDENTIFICATION OF AE USED DURING THE TEST	7
3.4 AIR INTERFACES / BANDS INDICATING OPERATING MODES	7
4 CONDUCTED OUTPUT POWER MEASUREMENT	8
4.1 SUMMARY	8
4.2 CONDUCTED POWER	8
5 REFERENCE DOCUMENTS.....	10
5.1 REFERENCE DOCUMENTS FOR TESTING	10
6 OPERATIONAL CONDITIONS DURING TEST	11
6.1 HAC MEASUREMENT SET-UP.....	11
6.2 PROBE SPECIFICATION	12
6.3 TEST ARCH PHANTOM & PHONE POSITIONER	13
6.4 ROBOTIC SYSTEM SPECIFICATIONS	13
7 EUT ARRANGEMENT	14
7.1 WD RF EMISSION MEASUREMENTS REFERENCE AND PLANE	14
8 SYSTEM VALIDATION	15
8.1 VALIDATION PROCEDURE	15
8.2 VALIDATION RESULT	15
9 EVALUATION OF MIF	16
9.1 INTRODUCTION.....	16
9.2 MIF MEASUREMENT WITH THE AIA	17
9.3 TEST EQUIPMENT FOR THE MIF MEASUREMENT	17
9.4 TEST SIGNAL VALIDATION	17
9.5 DUT MIF RESULTS.....	18
10 EVALUATION FOR LOW-POWER EXEMPTION	20
10.1 PRODUCT TESTING THRESHOLD	20
10.2 CONDUCTED POWER	20



10.3 CONCLUSION	20
11 RF TEST PROCEDURES.....	21
12 MEASUREMENT RESULTS (E-FIELD).....	22
13 ANSIC 63.19-2011 LIMITS	23
14 MEASUREMENT UNCERTAINTY	24
15 MAIN TEST INSTRUMENTS.....	25
16 CONCLUSION	25
ANNEX A TEST LAYOUT	26
ANNEX B TEST PLOTS	27
ANNEX C SYSTEM VALIDATION RESULT.....	37
ANNEX D PROBE CALIBRATION CERTIFICATE.....	40
ANNEX E DIPOLE CALIBRATION CERTIFICATE	50
ANNEX F DAE CALIBRATION CERTIFICATE	60

1 Test Laboratory

1.1 Testing Location

CompanyName:	CTTL(Shouxiang)
Address:	No. 51 Shouxiang Science Building, Xueyuan Road, Haidian District, Beijing, P. R. China100191

1.2 Testing Environment

Temperature:	18°C~25°C,
Relative humidity:	30%~ 70%
Ground system resistance:	< 0.5 Ω
Ambient noise is checked and found very low and in compliance with requirement of standards. Reflection of surrounding objects is minimized and in compliance with requirement of standards.	

1.3 Project Data

Project Leader:	Qi Dianyuan
Test Engineer:	Lin Hao
Testing Start Date:	October 8, 2018
Testing End Date:	October 8, 2018

1.4 Signature



Lin Xiaojun
(Prepared this test report)

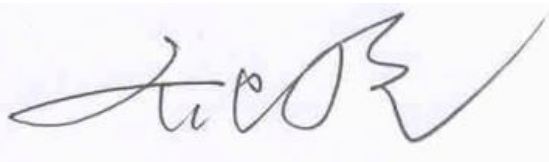

Qi Dianyuan
(Reviewed this test report)



Lu Bingsong
Deputy Director of the laboratory
(Approved this test report)



2 Client Information

2.1 Applicant Information

Company Name	FOXX Development Inc.
Company Address	101 E. Park Blvd., Plano, TX 75074, United States
Contact Person	Yi Zhang
Tel	+1 855-585-3699
Fax	+1 855-585-3699
E-Mail	ethanzhang@foxxusa.com

2.2 Manufacturer Information

Company Name	FOXX Development Inc.
Company Address	101 E. Park Blvd., Plano, TX 75074, United States
Contact Person	Yi Zhang
Tel	+1 855-585-3699
Fax	+1 855-585-3699
E-Mail	ethanzhang@foxxusa.com

3 Equipment Under Test (EUT) and Ancillary Equipment (AE)

3.1 About EUT

Description:	Smartphone MIRO
Model name:	L590A
Operating mode(s):	GSM 850/900/1800/1900 WCDMA850/1900/1700 LTE B2/4/5/12/66/71, BT, WLAN

3.2 Internal Identification of EUT used during the test

EUT ID*	IMEI	HW Version	SW Version
EUT1	015271000000588	L590MB_V0.4	R02.V04
EUT2	0152710000009217	L590MB_V0.4	R02.V04

*EUT ID: is used to identify the test sample in the lab internally.

3.3 Internal Identification of AE used during the test

AE ID*	Description	Model	SN	Manufacturer
AE1	Battery	M2A	/	DONGGUAN DRN NEW ENERGY CO., LTD

*AE ID: is used to identify the test sample in the lab internally.

3.4 Air Interfaces / Bands Indicating Operating Modes

Air-interface	Band(MHz)	Type	C63.19/tested	Simultaneous Transmissions	OTT
GSM	850	VO	Yes	BT, WLAN	NA
	1900				
GPRS/EDGE	850	DT	NA		
	1900				
WCDMA (UMTS)	850	VO	Yes		
	1700				
	1900				
	HSPA	DT	NA		
LTE	Band 2/4/5/7/12/66/71	V/D	Yes	BT, WLAN	NA
BT	2450	DT	NA	GSM, WCDMA, LTE	NA
WLAN	2450	V/D	Yes	GSM, WCDMA, LTE	NA
WLAN	5G	V/D	Yes	GSM, WCDMA, LTE	NA

VO: Voice CMRS/PSTN Service Only V/D: Voice CMRS/PSTN and Data Service DT: Digital Transport

* HAC Rating was not based on concurrent voice and data modes, Non-current mode was found to represent worst case rating for both M and T rating

4 CONDUCTED OUTPUT POWER MEASUREMENT

4.1 Summary

During the process of testing, the EUT was controlled via Agilent Digital Radio Communication tester (E5515C) to ensure the maximum power transmission and proper modulation. This result contains conducted output power for the EUT. In all cases, the measured output power should be greater and within 5% than EMI measurement.

4.2 Conducted Power

GSM 850MHz	Conducted Power (dBm)		
	Channel 251(848.8MHz)	Channel 190(836.6MHz)	Channel 128(824.2MHz)
	33.17	33.03	33.33
GSM 1900MHz	Conducted Power(dBm)		
	Channel 810(1909.8MHz)	Channel 661(1880MHz)	Channel 512(1850.2MHz)
	30.62	30.69	30.68
WCDMA 850MHz	Conducted Power (dBm)		
	Channel 4233(846.6MHz)	Channel 4182(836.4MHz)	Channel 4132(826.4MHz)
	24.72	24.62	24.73
WCDMA 1700MHz	Conducted Power (dBm)		
	Channel 1513 (1752.6MHz)	Channel 1412 (1732.4MHz)	Channel 1312 (1712.4MHz)
	24.67	24.65	24.62
WCDMA 1900MHz	Conducted Power (dBm)		
	Channel 9538(1907.6MHz)	Channel 9400(1880MHz)	Channel 9262(1852.4MHz)
	24.85	24.75	24.78
LTE Band2 QPSK	Conducted Power (dBm)		
	Channel 19100(1900MHz)	Channel18900(1880MHz)	Channel 18700(1860MHz)
	24.54	24.38	24.22
LTE Band5 QPSK	Conducted Power (dBm)		
	Channel 20600(844MHz)	Channel 20525(836.5MHz)	Channel20450(829MHz)
	24.26	24.08	24.02
LTE Band12 QPSK	Conducted Power (dBm)		
	Channel 23130(711MHz)	Channel 23095(707.5MHz)	Channel23060(704MHz)
	23.99	23.91	23.94
LTE Band66 QPSK	Conducted Power (dBm)		
	Channel 132572(1770MHz)	Channel 132322(1745MHz)	Channel 132072(1720MHz)
	24.17	24.22	24.03
LTE Band71 QPSK	Conducted Power (dBm)		
	Channel 133372(688MHz)	Channel 133297(680.5MHz)	Channel 133222(673MHz)
	23.88	23.69	23.68
LTE Band2 16-QAM	Conducted Power (dBm)		
	Channel 19100(1900MHz)	Channel18900(1880MHz)	Channel 18700(1860MHz)
	23.48	22.88	23.12



LTE Band5 16-QAM	Conducted Power (dBm)		
	Channel 20600(844MHz)	Channel 20525(836.5MHz)	Channel20450(829MHz)
	23.22	23.02	23.19
LTE Band12 16-QAM	Conducted Power (dBm)		
	Channel 23130(711MHz)	Channel 23095(707.5MHz)	Channel23060(704MHz)
	23.12	23.31	23.19
LTE Band66 16-QAM	Conducted Power (dBm)		
	Channel 132572(1770MHz)	Channel 132322(1745MHz)	Channel 132072(1720MHz)
	23.07	22.91	23.55
LTE Band71 16-QAM	Conducted Power (dBm)		
	Channel 133372(688MHz)	Channel 133297(680.5MHz)	Channel 133222(673MHz)
	22.63	23.22	23.22
2.4GHz 802.11b 1M	Conducted Power (dBm)		
	Channel 11 (2462MHz)	Channel 6 (2437MHz)	Channel 1 (2412MHz)
	18.01	18.29	18.71

5 Reference Documents

5.1 Reference Documents for testing

The following document listed in this section is referred for testing.

Reference	Title	Version
ANSI C63.19-2011	American National Standard for Methods of Measurement of Compatibility between Wireless Communication Devices and Hearing Aids	2011 Edition
FCC 47 CFR §20.19	Hearing Aid Compatible Mobile Headsets	2015 Edition
KDB 285076 D01	Equipment Authorization Guidance for Hearing Aid Compatibility	v05

6 OPERATIONAL CONDITIONS DURING TEST

6.1 HAC MEASUREMENT SET-UP

These measurements are performed using the DASY5 NEO automated dosimetric assessment system. It is made by Schmid & Partner Engineering AG (SPEAG) in Zurich, Switzerland. It consists of high precision robotics system (Stäubli), robot controller, Intel Core2 computer, near-field probe, probe alignment sensor. The robot is a six-axis industrial robot performing precise movements. A cell controller system contains the power supply, robot controller, teach pendant (Joystick), and remote control, is used to drive the robot motors. The PC consists of the HP Intel Core2 1.86 GHz computer with Windows XP system and HAC Measurement Software DASY5 NEO, A/D interface card, monitor, mouse, and keyboard. The Stäubli Robot is connected to the cell controller to allow software manipulation of the robot. A data acquisition electronic (DAE) circuit performs the signal amplification, signal multiplexing, AD-conversion, offset measurements, mechanical surface detection, collision detection, etc. is connected to the Electro-optical coupler (EOC). The EOC performs the conversion from the optical into digital electric signal of the DAE and transfers data to the PC plug-in card.

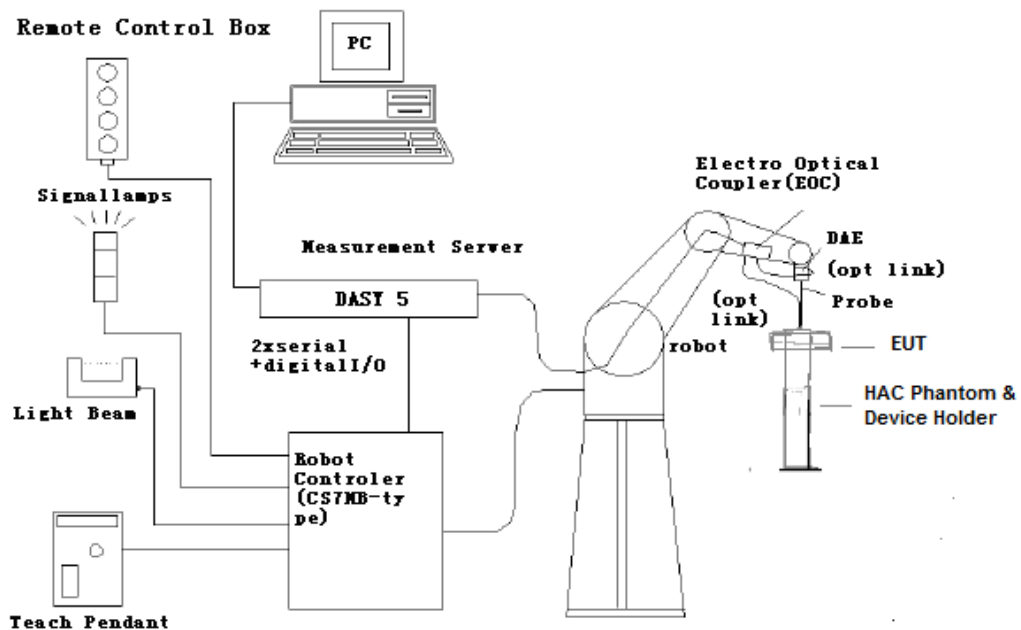

Fig. 1 HAC Test Measurement Set-up

The DAE4 consists of a highly sensitive electrometer-grade preamplifier with auto-zeroing, a channel and gain-switching multiplexer, a fast 16 bit AD-converter and a command decoder and control logic unit. Transmission to the PC-card is accomplished through an optical downlink for data and status information and an optical uplink for commands and clock lines. The mechanical probe mounting device includes two different sensor systems for frontal and sidewise probe contacts. They are also used for mechanical surface detection and probe collision detection. The robot uses its own controller with a built in VME-bus computer.

6.2 Probe Specification

E-Field Probe Description

Construction	One dipole parallel, two dipoles normal to probe axis Built-in shielding against static charges PEEK enclosure material
Calibration	In air from 100 MHz to 3.0 GHz (absolute accuracy $\pm 6.0\%$, $k=2$)
Frequency	40 MHz to > 6 GHz (can be extended to < 20 MHz) Linearity: ± 0.2 dB (100 MHz to 3 GHz)
Directivity	± 0.2 dB in air (rotation around probe axis) ± 0.4 dB in air (rotation normal to probe axis)
Dynamic Range	2 V/m to > 1000 V/m; Linearity: ± 0.2 dB
Dimensions	Overall length: 330 mm (Tip: 16 mm) Tip diameter: 8 mm (Body: 12 mm) Distance from probe tip to dipole centers: 2.5 mm
Application	General near-field measurements up to 6 GHz Field component measurements Fast automatic scanning in phantoms



[ER3DV6]

6.3 Test Arch Phantom & Phone Positioner

The Test Arch phantom should be positioned horizontally on a stable surface. Reference markings on the Phantom allow the complete setup of all predefined phantom positions and measurement grids by manually teaching three points in the robot. It enables easy and well defined positioning of the phone and validation dipoles as well as simple teaching of the robot (Dimensions: 370 x 370 x 370 mm).

The Phone Positioner supports accurate and reliable positioning of any phone with effect on near field $< \pm 0.5$ dB.

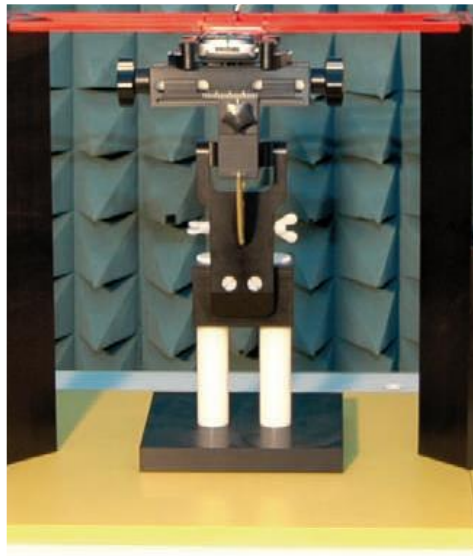

Fig. 2 HAC Phantom & Device Holder

6.4 Robotic System Specifications

Specifications

Positioner: Stäubli Unimation Corp. Robot Model: RX160L

Repeatability: ± 0.02 mm

No. of Axis: 6

Data Acquisition Electronic (DAE) System

Cell Controller

Processor: Intel Core2

Clock Speed: 1.86GHz

Operating System: Windows XP

Data Converter

Features: Signal Amplifier, multiplexer, A/D converter, and control logic

Software: DASY5 software

Connecting Lines: Optical downlink for data and status info.

Optical uplink for commands and clock

7 EUT ARRANGEMENT

7.1 WD RF Emission Measurements Reference and Plane

Figure 4 illustrates the references and reference plane that shall be used in the WD emissions measurement.

- The grid is 5 cm by 5 cm area that is divided into 9 evenly sized blocks or sub-grids.
- The grid is centered on the audio frequency output transducer of the WD (speaker or T-coil).
- The grid is located by reference to a reference plane. This reference plane is the planar area that contains the highest point in the area of the WD that normally rests against the user's ear
- The measurement plane is located parallel to the reference plane and 15 mm from it, out from the phone. The grid is located in the measurement plane.

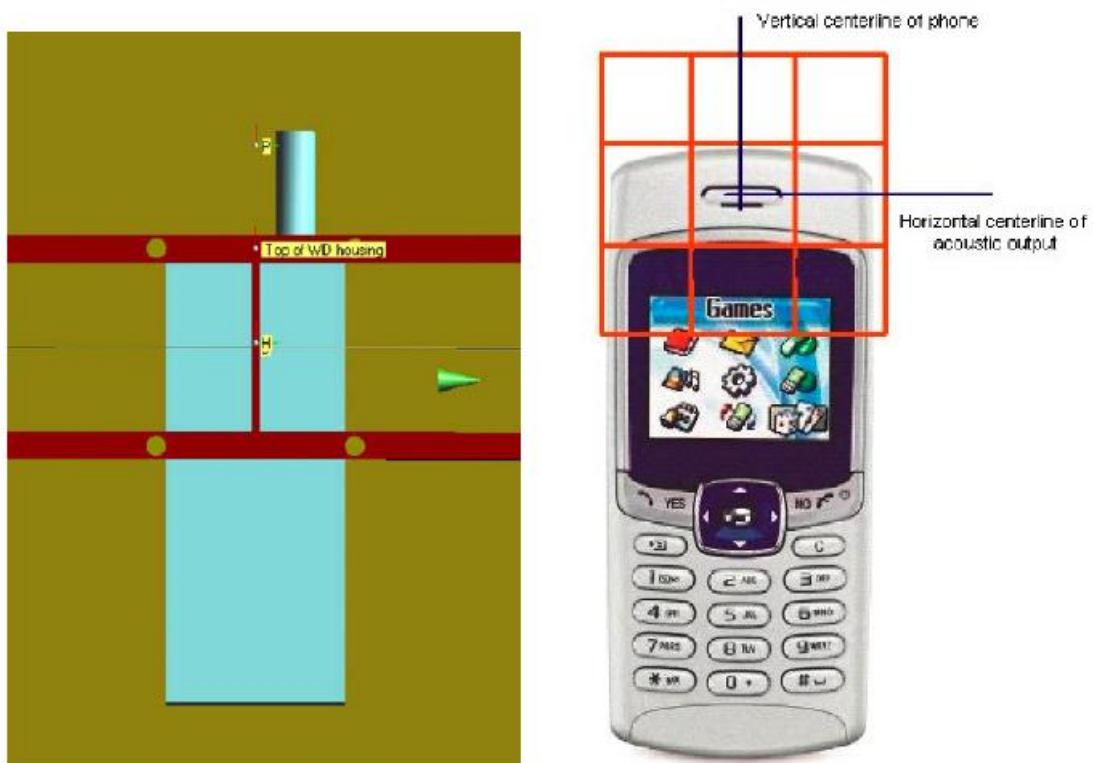

Fig. 3 WD reference and plane for RF emission measurements

8 SYSTEM VALIDATION

8.1 Validation Procedure

Place a dipole antenna meeting the requirements given in ANSI C63.19 in the position normally occupied by the WD. The dipole antenna serves as a known source for an electrical output. Position the E-field probes so that:

- The probes and their cables are parallel to the coaxial feed of the dipole antenna
- The probe cables and the coaxial feed of the dipole antenna approach the measurement area from opposite directions
- The center point of the probe element(s) are 15 mm from the closest surface of the dipole elements.

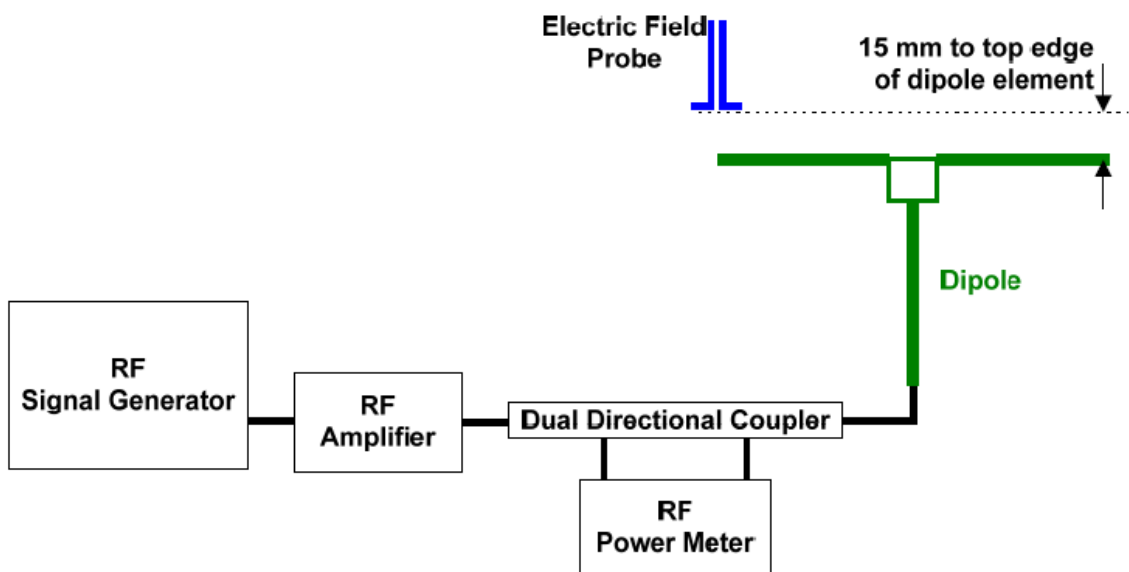

Fig. 4 Dipole Validation Setup

8.2 Validation Result

E-Field Scan						
Mode	Frequency (MHz)	Input Power (mW)	Measured ¹ Value(dBV/m)	Target ² Value(dBV/m)	Deviation ³ (%)	Limit ⁴ (%)
CW	835	100	40.61	40.91	-3.39	± 25
CW	1880	100	39.32	39.01	3.63	± 25

Notes:

1. Please refer to the attachment for detailed measurement data and plot.
2. Target value is provided by SPEAD in the calibration certificate of specific dipoles.
3. Deviation (%) = 100 * (Measured value minus Target value) divided by Target value.
4. ANSI C63.19 requires values within ± 25% are acceptable, of which 12% is deviation and 13% is measurement uncertainty. Values independently validated for the dipole actually used in the measurements should be used, when available.

9 Evaluation of MIF

9.1 Introduction

The MIF (Modulation Interference Factor) is used to classify E-field emission to determine Hearing Aid Compatibility (HAC). It scales the power-averaged signal to the RF audio interference level and is characteristic to a modulation scheme. The HAC standard preferred "indirect" measurement method is based on average field measurement with separate scaling by the MIF. With an Audio Interference Analyzer (AIA) designed by SPEAG specifically for the MIF measurement, these values have been verified by practical measurements on an RF signal modulated with each of the waveforms. The resulting deviations from the simulated values are within the requirements of the HAC standard.

The AIA (Audio Interference Analyzer) is an USB powered electronic sensor to evaluate signals in the frequency range 698MHz - 6 GHz. It contains RMS detector and audio frequency circuits for sampling of the RF envelope.

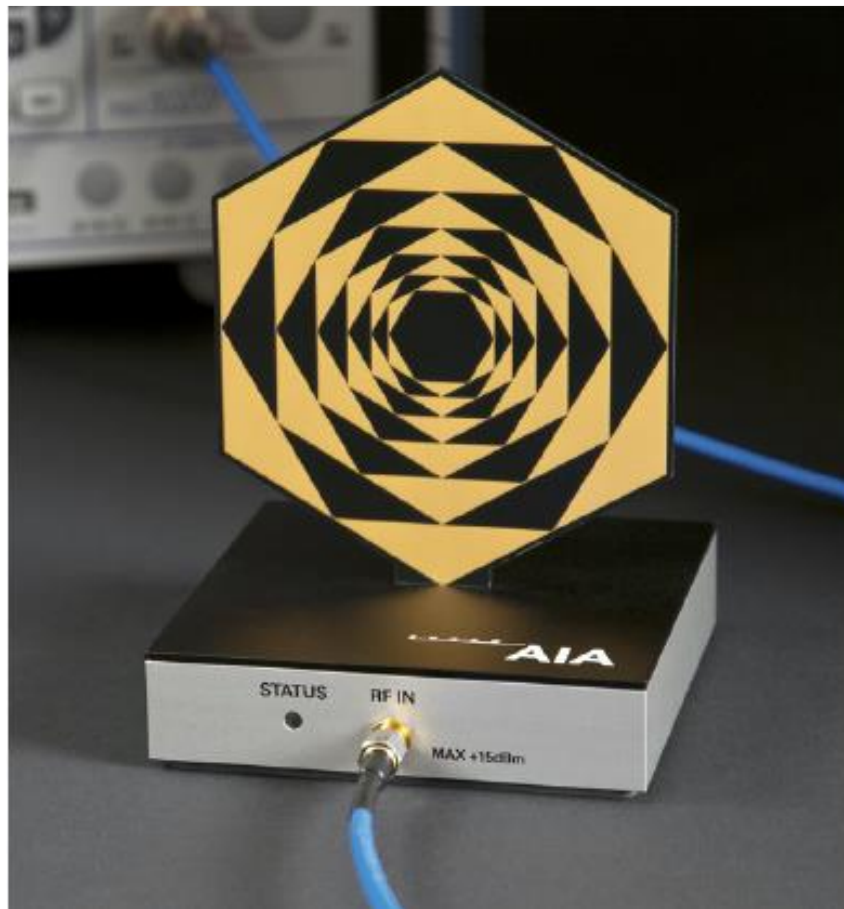

Fig. 5 AIA Front View

9.2 MIF measurement with the AIA

The MIF is measured with the AIA as follows:

1. Connect the AIA via USB to the DASY5 PC and verify the configuration settings.
2. Couple the RF signal to be evaluated to an AIA via cable or antenna.
3. Generate a MIF measurement job for the unknown signal and select the measurement port and timing settings.
4. Document the results via the post processor in a report.

9.3 Test equipment for the MIF measurement

No.	Name	Type	Serial Number	Manufacturer
01	Signal Generator	E4438C	MY49071430	Agilent
02	AIA	SE UMS 170 CB	1029	SPEAG
03	BTS	E5515C	MY50263375	Agilent

9.4 Test signal validation

The signal generator (E4438C) is used to generate a 1GHz signal with different modulation in the below table based on the ANSI C63.19-2011. The measured MIF with AIA are compared with the target values given in ANSI C63.19-2011 table D.3, D.4 and D5.

Pulse modulation	Target MIF	Measured MIF	Deviation
0.5ms pulse, 1000Hz repetition rate	-0.9 dB	-0.9 dB	0 dB
1ms pulse, 100Hz repetition rate	+3.9 dB	+3.7 dB	0.2 dB
0.1ms pulse, 100Hz repetition rate	+10.1 dB	+10.0 dB	0.1 dB
10ms pulse, 10Hz repetition rate	+1.6 dB	+1.7 dB	0.1 dB
Sine-wave modulation	Target MIF	Measured MIF	Deviation
1 kHz, 80% AM	-1.2 dB	-1.3 dB	0.1 dB
1 kHz, 10% AM	-9.1 dB	-9.0 dB	0.1 dB
1 kHz, 1% AM	-19.1 dB	-18.9 dB	0.2 dB
100 Hz, 10% AM	-16.1 dB	-16.0 dB	0.1 dB
10 kHz, 10% AM	-21.5 dB	-21.6 dB	0.1 dB
Transmission protocol	Target MIF	Measured MIF	Deviation
GSM; full-rate version 2; speech codec/handset low	+3.5 dB	+3.47 dB	0.03 dB
WCDMA; speech; speech codec low; AMR 12.2 kb/s	-20.0 dB	-19.8 dB	0.2 dB
CDMA; speech; SO3; RC3; full frame rate; 8kEVRC	-19.0 dB	-19.1 dB	0.1 dB
CDMA; speech; SO3; RC1; 1/8 th frame rate; 8kEVRC	+3.3 dB	+3.44 dB	0.14 dB

9.5 DUT MIF results

Typical MIF levels in ANSI C63.19-2011	
Transmission protocol	Modulation interference factor
GSM; full-rate version 2; speech codec/handset low	+3.5 dB
WCDMA; speech; speech codec low; AMR 12.2 kb/s	-20.0 dB
LTE-FDD (SC-FDMA, 1RB, 20MHz, QPSK)	-15.63 dB
LTE-FDD (SC-FDMA, 1RB, 20MHz, 16QAM)	-9.76 dB
LTE-FDD (SC-FDMA, 1RB, 20MHz, 64QAM)	-9.93 dB
LTE-TDD (SC-FDMA, 1RB, 20MHz, QPSK)	-1.62 dB
LTE-TDD (SC-FDMA, 1RB, 20MHz, 16QAM)	-1.44 dB
LTE-TDD (SC-FDMA, 1RB, 20MHz, 64QAM)	-1.54 dB

Measured MIF levels		
Band	Channel	Modulation interference factor (dB)
GSM 850	251	3.44
	190	3.5
	128	3.49
GSM 1900	810	3.48
	661	3.45
	512	3.45
WCDMA 850	4458	-22.09
	4407	-23.02
	4357	-22.79
WCDMA 1700	1738	-25.35
	1637	-24.48
	1537	-23.51
WCDMA 1900	9938	-24.77
	9800	-25.1
	9662	-24.92
LTE Band2 QPSK	19100	-13.62
	18900	-14.09
	18700	-13.92
LTE Band5 QPSK	20600	-14.46
	20525	-14.9
	20450	-14.46
LTE Band12 QPSK	23130	-14.06
	23095	-14.68
	23060	-14.25
LTE Band66	132572	-14.12



QPSK	132322	-14.89
	132072	-14.59
LTE Band71 QPSK	133372	-14.91
	133297	-14.57
	133222	-15.04
LTE Band2 16QAM	19100	-11.07
	18900	-10.82
	18700	-10.34
LTE Band5 16QAM	20600	-10.57
	20525	-11
	20450	-10.72
LTE Band12 16QAM	23130	-10.34
	23095	-9.81
	23060	-10.33
LTE Band66 16QAM	132572	-10.81
	132322	-10.64
	132072	-10.09
LTE Band71 16QAM	133372	-9.89
	133297	-10.62
	133222	-10.57
2.4GHz 802.11b 5.5M	11	-10.11
	6	-9.89
	1	-10.25

10 Evaluation for low-power exemption

10.1 Product testing threshold

There are two methods for exempting an RF air interface technology from testing. The first method requires evaluation of the MIF for the worst-case operating mode. An RF air interface technology of a device is exempt from testing when its average antenna input power plus its MIF is ≤ 17 dBm for any of its operating modes. The second method does not require determination of the MIF. The RF emissions testing exemption shall be applied to an RF air interface technology in a device whose peak antenna input power, averaged over intervals $\leq 50 \mu s$, is ≤ 23 dBm. An RF air interface technology that is exempted from testing by either method shall be rated as M4.

The first method is used to be exempt from testing for the RF air interface technology in this report.

10.2 Conducted power

Band	Average power (dBm)	MIF (dB)	Sum (dBm)
GSM 850	33.33	3.5	36.83
GSM 1900	30.69	3.48	34.17
WCDMA 850	24.73	-22.09	2.64
WCDMA 1700	24.67	-23.51	1.16
WCDMA 1900	24.85	-24.77	0.08
LTE B2	24.54	-10.34	14.2
LTE B5	24.26	-10.57	13.69
LTE B12	23.99	-9.81	14.18
LTE B66	24.22	-10.09	14.13
LTE B71	23.88	-9.89	13.99
WiFi-2.4G	18.71	-9.89	8.82

10.3 Conclusion

According to the above table, the sums of average power and MIF for UMTS, LTE and WiFi are less than 17dBm. So it is only measured for GSM bands. The UMTS, LTE and WiFi are exempt from testing and rated as M4.



11 RF TEST PROCEDURES

The evaluation was performed with the following procedure:

- 1) Confirm proper operation of the field probe, probe measurement system and other instrumentation and the positioning system.
- 2) Position the WD in its intended test position. The gauge block can simplify this positioning.
- 3) Configure the WD normal operation for maximum rated RF output power, at the desired channel and other operating parameters (e.g., test mode), as intended for the test.
- 4) The center sub-grid shall be centered on the center of the T-Coil mode axial measurement point or the acoustic output, as appropriate. Locate the field probe at the initial test position in the 50 mm by 50 mm grid, which is contained in the measurement plane. If the field alignment method is used, align the probe for maximum field reception.
- 5) Record the reading.
- 6) Scan the entire 50 mm by 50 mm region in equally spaced increments and record the reading at each measurement point. The distance between measurement points shall be sufficient to assure the identification of the maximum reading.
- 7) Identify the five contiguous sub-grids around the center sub-grid whose maximum reading is the lowest of all available choices. This eliminates the three sub-grids with the maximum readings. Thus, the six areas to be used to determine the WD's highest emissions are identified.
- 8) Identify the maximum field reading within the non-excluded sub-grids identified in Step 7)
- 9) Evaluate the MIF and add to the maximum steady-state rms field-strength reading to obtain the RF audio interference level..
- 10) Compare this RF audio interference level with the categories and record the resulting WD category rating.



12 Measurement Results (E-Field)

Frequency		AWF	Measured Value (V/m)	Power Drift (dB)	Category M?	MIF
MHz	Channel					
GSM 850						
	251	0	35..19	-0.06	M4	3.44
	190	0	35.2	0.04	M4	3.5
	128	0	34.56	-0.02	M4	3.49
PCS 1900						
	810	0	29.42	0.15	M4	3.48
	661	0	29.51	0.17	M4	3.45
	512	0	29.82	0.11	M4	3.45

13 ANSIC 63.19-2011 LIMITS

WD RF audio interference level categories in logarithmic units

Emission categories	< 960 MHz	
	E-field emissions	
Category M1	50 to 55	dB (V/m)
Category M2	45 to 50	dB (V/m)
Category M3	40 to 45	dB (V/m)
Category M4	< 40	dB (V/m)
Emission categories	>960 MHz	
	E-field emissions	
Category M1	40 to 45	dB (V/m)
Category M2	35 to 40	dB (V/m)
Category M3	30 to 35	dB (V/m)
Category M4	< 30	dB (V/m)



14 MEASUREMENT UNCERTAINTY

No.	Error source	Type	Uncertainty Value(%)	Prob. Dist.	k	c _i E	Standard Uncertainty (%) u_i (%)E	Degree of freedom V_{eff} or ν_i
Measurement System								
1	Probe Calibration	B	5.	N	1	1	5.1	∞
2	Axial Isotropy	B	4.7	R	$\sqrt{3}$	1	2.7	∞
3	Sensor Displacement	B	16.5	R	$\sqrt{3}$	1	9.5	∞
4	Boundary Effects	B	2.4	R	$\sqrt{3}$	1	1.4	∞
5	Linearity	B	4.7	R	$\sqrt{3}$	1	2.7	∞
6	Scaling to Peak Envelope Power	B	2.0	R	$\sqrt{3}$	1	1.2	∞
7	System Detection Limit	B	1.0	R	$\sqrt{3}$	1	0.6	∞
8	Readout Electronics	B	0.3	N	1	1	0.3	∞
9	Response Time	B	0.8	R	$\sqrt{3}$	1	0.5	∞
10	Integration Time	B	2.6	R	$\sqrt{3}$	1	1.5	∞
11	RF Ambient Conditions	B	3.0	R	$\sqrt{3}$	1	1.7	∞
12	RF Reflections	B	12.0	R	$\sqrt{3}$	1	6.9	∞
13	Probe Positioner	B	1.2	R	$\sqrt{3}$	1	0.7	∞
14	Probe Positioning	A	4.7	R	$\sqrt{3}$	1	2.7	∞
15	Extra. And Interpolation	B	1.0	R	$\sqrt{3}$	1	0.6	∞
Test Sample Related								
16	Device Positioning Vertical	B	4.7	R	$\sqrt{3}$	1	2.7	∞
17	Device Positioning Lateral	B	1.0	R	$\sqrt{3}$	1	0.6	∞
18	Device Holder and Phantom	B	2.4	R	$\sqrt{3}$	1	1.4	∞
19	Power Drift	B	5.0	R	$\sqrt{3}$	1	2.9	∞

20	AIA measurement	B	12	R	$\sqrt{3}$	1	6.9	∞
Phantom and Setup related								
21	Phantom Thickness	B	2.4	R	$\sqrt{3}$	1	1.4	∞
Combined standard uncertainty(%)							16.2	
Expanded uncertainty (confidence interval of 95 %)		$u_e = 2u_c$		N	k=2		32.4	

15 MAIN TEST INSTRUMENTS

Table 1: List of Main Instruments

No.	Name	Type	Serial Number	Calibration Date	Valid Period
01	Signal Generator	E4438C	MY49071430	January 2, 2018	One Year
02	Power meter	NRVD	102083	November 01, 2017	One year
03	Power sensor	NRV-Z5	100542		
04	Amplifier	60S1G4	0331848	No Calibration Requested	
05	AIA	SE UMS 170 CB	1029	No Calibration Requested	
06	E-Field Probe	ER3DV6	2272	December 19, 2017	One year
07	DAE	SPEAG DAE4	1525	September 18, 2018	One year
08	HAC Dipole	CD835V3	1023	August 28, 2018	One year
09	HAC Dipole	CD1880V3	1018	August 28, 2018	One year
10	BTS	CMW 500	129942	March 02, 2018	One year

16 CONCLUSION

The HAC measurement indicates that the EUT complies with the HAC limits of the ANSIC63.19-2011. The total M-rating is **M4**.

END OF REPORT BODY

ANNEX A TEST LAYOUT



Picture A1:HAC RF System Layout

ANNEX B TEST PLOTS

HAC RF E-Field GSM 850 High

Date: 2018-10-8

Electronics: DAE4 Sn1525

Medium: Air

Medium parameters used: $\sigma = 0$ mho/m, $\epsilon_r = 1$; $\rho = 1000$ kg/m³

Ambient Temperature: 22.2°C

Communication System: GSM 850; Frequency: 848.8 MHz; Duty Cycle: 1:8.3

Probe: ER3DV6 - SN2272; ConvF(1, 1, 1)

E Scan - ER3DV6 - 2011: 15 mm from Probe Center to the Device/Hearing Aid

Compatibility Test (101x101x1): Interpolated grid: dx=0.5000 mm, dy=0.5000 mm

Device Reference Point: 0, 0, -6.3 mm

Reference Value = 46.06 V/m; Power Drift = -0.06 dB

Applied MIF = 3.44 dB

RF audio interference level = 35.19 dBV/m

Emission category: M4

MIF scaled E-field

Grid 1 M4 34.21 dBV/m	Grid 2 M4 35.19 dBV/m	Grid 3 M4 35.1 dBV/m
Grid 4 M4 34.17 dBV/m	Grid 5 M4 35.19 dBV/m	Grid 6 M4 35.09 dBV/m
Grid 7 M4 34.03 dBV/m	Grid 8 M4 34.92 dBV/m	Grid 9 M4 34.89 dBV/m

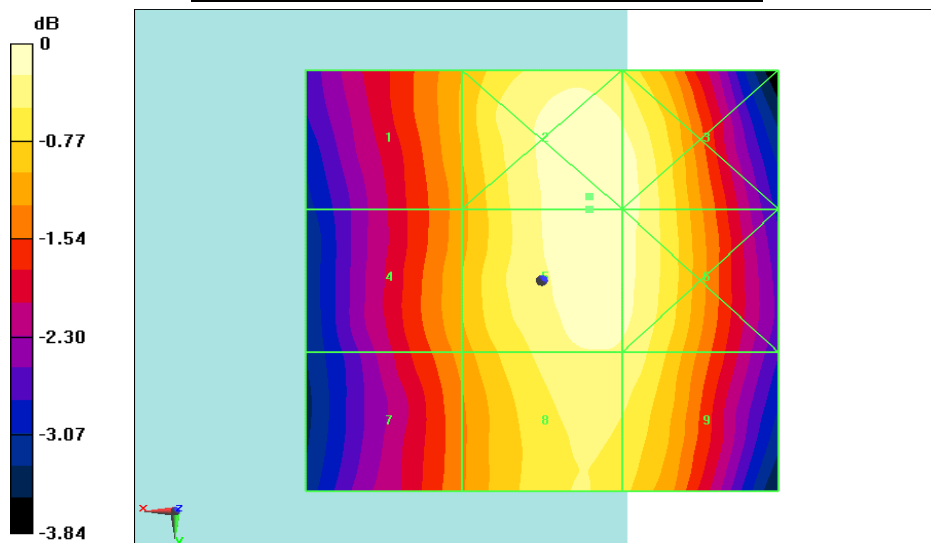

0 dB = 57.48 V/m = 35.19 dBV/m

Fig B.1 HAC RF E-Field GSM 850 High

HAC RF E-Field GSM 850 Middle

Date: 2018-10-8

Electronics: DAE4 Sn1525

Medium: Air

Medium parameters used: $\sigma = 0$ mho/m, $\epsilon_r = 1$; $\rho = 1000$ kg/m³

Ambient Temperature: 22.0°C

Communication System: GSM 850; Frequency: 836.6 MHz; Duty Cycle: 1:8.3

Probe: ER3DV6 - SN2272;ConvF(1, 1, 1)

E Scan - ER3DV6 - 2011: 15 mm from Probe Center to the Device 2/Hearing Aid

Compatibility Test (101x101x1): Interpolated grid: dx=0.5000 mm, dy=0.5000 mm

Device Reference Point: 0, 0, -6.3 mm

Reference Value = 44.05 V/m; Power Drift = 0.04 dB

Applied MIF = 3.50 dB

RF audio interference level = 35.20 dBV/m

Emission category: M4

MIF scaled E-field

Grid 1 M4 33.92 dBV/m	Grid 2 M4 35.17 dBV/m	Grid 3 M4 35.07 dBV/m
Grid 4 M4 33.93 dBV/m	Grid 5 M4 35.2 dBV/m	Grid 6 M4 35.08 dBV/m
Grid 7 M4 33.82 dBV/m	Grid 8 M4 34.96 dBV/m	Grid 9 M4 34.92 dBV/m

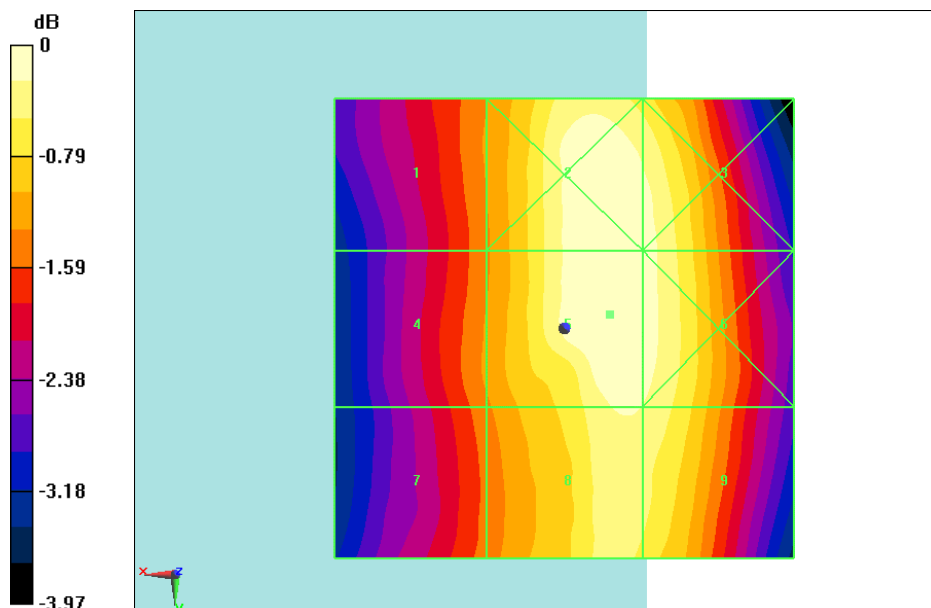



0 dB = 57.51 V/m = 35.19 dBV/m

Fig B.2 HAC RF E-Field GSM 850 Middle

HAC RF E-Field GSM 850 Low

Date: 2018-10-8

Electronics: DAE4 Sn1525

Medium: Air

Medium parameters used: $\sigma = 0$ mho/m, $\epsilon_r = 1$; $\rho = 1000$ kg/m³

Ambient Temperature: 22.0°C

Communication System: GSM 850; Frequency: 824.2 MHz; Duty Cycle: 1:8.3

Probe: ER3DV6 - SN2272;ConvF(1, 1, 1)

E Scan - ER3DV6 - 2011: 15 mm from Probe Center to the Device 3/Hearing Aid

Compatibility Test (101x101x1): Interpolated grid: dx=0.5000 mm, dy=0.5000 mm

Device Reference Point: 0, 0, -6.3 mm

Reference Value = 42.98 V/m; Power Drift = -0.02 dB

Applied MIF = 3.49 dB

RF audio interference level = 34.56 dBV/m

Emission category: M4

MIF scaled E-field

Grid 1 M4 33.67 dBV/m	Grid 2 M4 34.53 dBV/m	Grid 3 M4 34.41 dBV/m
Grid 4 M4 33.71 dBV/m	Grid 5 M4 34.56 dBV/m	Grid 6 M4 34.43 dBV/m
Grid 7 M4 33.56 dBV/m	Grid 8 M4 34.4 dBV/m	Grid 9 M4 34.29 dBV/m

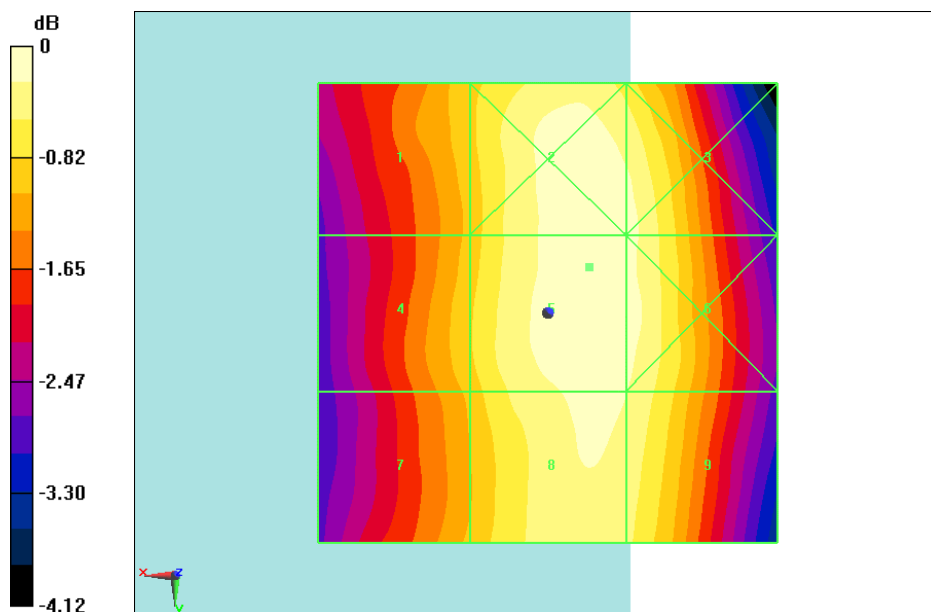

0 dB = 53.43 V/m = 34.56 dBV/m



Fig B.3 HAC RF E-Field GSM 850 Low

HAC RF E-Field GSM 1900 High

Date: 2018-10-8

Electronics: DAE4 Sn1525

Medium: Air

Medium parameters used: $\sigma = 0$ mho/m, $\epsilon_r = 1$; $\rho = 1000$ kg/m³

Ambient Temperature: 22.0°C

Communication System: DCS 1900; Frequency: 1909.8 MHz; Duty Cycle: 1:8.3

Probe: ER3DV6 - SN2272; ConvF(1, 1, 1)

E Scan - ER3DV6 - 2011: 15 mm from Probe Center to the Device/Hearing Aid

Compatibility Test (101x101x1): Interpolated grid: dx=0.5000 mm, dy=0.5000 mm

Device Reference Point: 0, 0, -6.3 mm

Reference Value = 19.43 V/m; Power Drift = 0.15 dB

Applied MIF = 3.48 dB

RF audio interference level = 29.42 dBV/m

Emission category: M4

MIF scaled E-field

Grid 1 M4 27.98 dBV/m	Grid 2 M4 28.27 dBV/m	Grid 3 M4 28.3 dBV/m
Grid 4 M4 27.22 dBV/m	Grid 5 M4 29.42 dBV/m	Grid 6 M4 29.42 dBV/m
Grid 7 M4 28.71 dBV/m	Grid 8 M4 29.94 dBV/m	Grid 9 M4 29.94 dBV/m

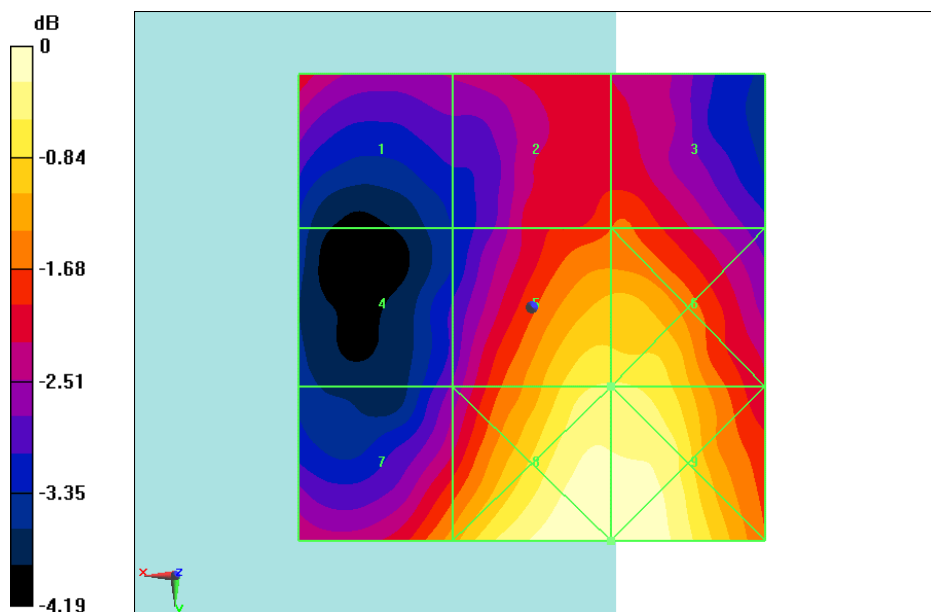

0 dB = 31.40 V/m = 29.94 dBV/m



Fig B.4 HAC RF E-Field GSM 1900 High

HAC RF E-Field GSM 1900 Middle

Date: 2018-10-8

Electronics: DAE4 Sn1525

Medium: Air

Medium parameters used: $\sigma = 0$ mho/m, $\epsilon_r = 1$; $\rho = 1000$ kg/m³

Ambient Temperature: 22.0°C

Communication System: DCS 1900; Frequency: 1880 MHz; Duty Cycle: 1:8.3

Probe: ER3DV6 - SN2272; ConvF(1, 1, 1)

E Scan - ER3DV6 - 2011: 15 mm from Probe Center to the Device 2/Hearing Aid

Compatibility Test (101x101x1): Interpolated grid: dx=0.5000 mm, dy=0.5000 mm

Device Reference Point: 0, 0, -6.3 mm

Reference Value = 18.09 V/m; Power Drift = 0.17 dB

Applied MIF = 3.45 dB

RF audio interference level = 29.51 dBV/m

Emission category: M4

MIF scaled E-field

Grid 1 M4 28.25 dBV/m	Grid 2 M4 27.73 dBV/m	Grid 3 M4 27.51 dBV/m
Grid 4 M4 26.78 dBV/m	Grid 5 M4 29.51 dBV/m	Grid 6 M4 29.55 dBV/m
Grid 7 M4 28.53 dBV/m	Grid 8 M3 30.69 dBV/m	Grid 9 M3 30.7 dBV/m

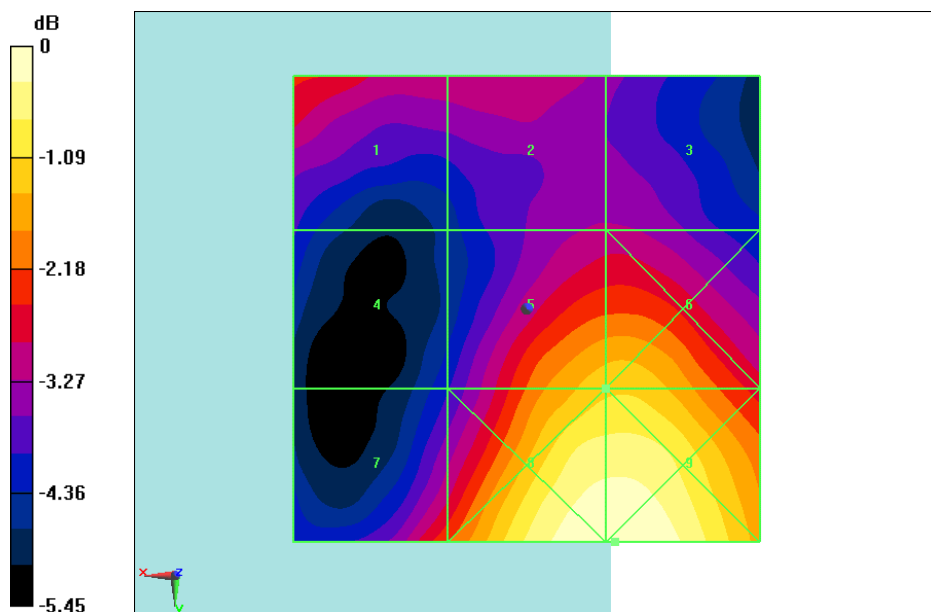

0 dB = 23.97 V/m = 27.59 dBV/m



Fig B.5 HAC RF E-Field GSM 1900 Middle