



8 LIST OF EQUIPMENT

Equipment Summary Sheet				
Equipment Description	Manufacturer / Model	Identification No.	Current Calibration Date	Next Calibration Date
SAM Phantom	MVG	SN-20/09-SAM71	Validated. No cal required.	Validated. No cal required.
COMOSAR Test Bench	Version 3	NA	Validated. No cal required.	Validated. No cal required.
Network Analyzer	Rhode & Schwarz ZVA	SN100132	02/2021	02/2024
Calipers	Carrera	CALIPER-01	02/2021	02/2024
Reference Probe	MVG	EPG122 SN 18/11	02/2021	02/2022
Multimeter	Keithley 2000	1188656	02/2021	02/2024
Signal Generator	Agilent E4438C	MY49070581	02/2021	02/2024
Amplifier	Aethercomm	SN 046	Characterized prior to test. No cal required.	Characterized prior to test. No cal required.
Power Meter	HP E4418A	US38261498	02/2021	02/2024
Power Sensor	HP ECP-E26A	US37181460	02/2021	02/2024
Directional Coupler	Narda 4216-20	01386	Characterized prior to test. No cal required.	Characterized prior to test. No cal required.
Temperature and Humidity Sensor	Control Company	11-661-9	02/2021	02/2024



SAR Reference Dipole Calibration Report

Ref : ACR.156.10.15.SATU.A

SHENZHEN TCT TESTING TECHNOLOGY CO., LTD
2101&2201, ZHENCHANG FACTORY, RENSHAN INDUSTRIAL
ZONE, FUHAI SUBDISTRICT, BAOAN DISTRICT, SHENZHEN,
GUANGDONG, 518103, PEOPLES REPUBLIC OF CHINA
MVG COMOSAR REFERENCE DIPOLE
FREQUENCY: 2600 MHZ
SERIAL NO.: SN 16/15 DIP 2G600-375

Calibrated at MVG US
2105 Barrett Park Dr. - Kennesaw, GA 30144



Calibration Date: 06/05/2021

Summary:

This document presents the method and results from an accredited SAR reference dipole calibration performed in MVG USA using the COMOSAR test bench. All calibration results are traceable to national metrology institutions.



SAR REFERENCE DIPOLE CALIBRATION REPORT

Ref: ACR.156.10.15.SATU.A

	<i>Name</i>	<i>Function</i>	<i>Date</i>	<i>Signature</i>
<i>Prepared by :</i>	Jérôme LUC	Product Manager	06/05/2021	<i>JS</i>
<i>Checked by :</i>	Jérôme LUC	Product Manager	06/05/2021	<i>JS</i>
<i>Approved by :</i>	Kim RUTKOWSKI	Quality Manager	06/05/2021	<i>Kim Rutkowski</i>

	<i>Customer Name</i>
<i>Distribution :</i>	SHENZHEN TONGCE TESTING LAB

<i>Issue</i>	<i>Date</i>	<i>Modifications</i>
A	06/05/2021	Initial release

Page: 2/11

*This document shall not be reproduced, except in full or in part, without the written approval of MVG.
The information contained herein is to be used only for the purpose for which it is submitted and is not to be released in whole or part without written approval of MVG.*



TABLE OF CONTENTS

1	Introduction.....	4
2	Device Under Test	4
3	Product Description	4
3.1	General Information	4
4	Measurement Method	5
4.1	Return Loss Requirements	5
4.2	Mechanical Requirements	5
5	Measurement Uncertainty	5
5.1	Return Loss	5
5.2	Dimension Measurement	5
5.3	Validation Measurement	5
6	Calibration Measurement Results	6
6.1	Return Loss and Impedance In Head Liquid	6
6.2	Return Loss and Impedance In Body Liquid	6
6.3	Mechanical Dimensions	6
7	Validation measurement	7
7.1	Head Liquid Measurement	7
7.2	SAR Measurement Result With Head Liquid	8
7.3	Body Liquid Measurement	9
7.4	SAR Measurement Result With Body Liquid	10
8	List of Equipment	11



1 INTRODUCTION

This document contains a summary of the requirements set forth by the IEEE 1528, FCC KDBs and CEI/IEC 62209 standards for reference dipoles used for SAR measurement system validations and the measurements that were performed to verify that the product complies with the fore mentioned standards.

2 DEVICE UNDER TEST

Device Under Test	
Device Type	COMOSAR 2600 MHz REFERENCE DIPOLE
Manufacturer	MVG
Model	SID2600
Serial Number	SN 16/15 DIP 2G600-375
Product Condition (new / used)	Used

A yearly calibration interval is recommended.

3 PRODUCT DESCRIPTION

3.1 GENERAL INFORMATION

MVG's COMOSAR Validation Dipoles are built in accordance to the IEEE 1528, FCC KDBs and CEI/IEC 62209 standards. The product is designed for use with the COMOSAR test bench only.



Figure 1 – MVG COMOSAR Validation Dipole



4 MEASUREMENT METHOD

The IEEE 1528, FCC KDBs and CEI/IEC 62209 standards provide requirements for reference dipoles used for system validation measurements. The following measurements were performed to verify that the product complies with the fore mentioned standards.

4.1 RETURN LOSS REQUIREMENTS

The dipole used for SAR system validation measurements and checks must have a return loss of -20 dB or better. The return loss measurement shall be performed against a liquid filled flat phantom, with the phantom constructed as outlined in the fore mentioned standards.

4.2 MECHANICAL REQUIREMENTS

The IEEE Std. 1528 and CEI/IEC 62209 standards specify the mechanical components and dimensions of the validation dipoles, with the dimensions frequency and phantom shell thickness dependent. The COMOSAR test bench employs a 2 mm phantom shell thickness therefore the dipoles sold for use with the COMOSAR test bench comply with the requirements set forth for a 2 mm phantom shell thickness.

5 MEASUREMENT UNCERTAINTY

All uncertainties listed below represent an expanded uncertainty expressed at approximately the 95% confidence level using a coverage factor of $k=2$, traceable to the Internationally Accepted Guides to Measurement Uncertainty.

5.1 RETURN LOSS

The following uncertainties apply to the return loss measurement:

Frequency band	Expanded Uncertainty on Return Loss
400-6000MHz	0.1 dB

5.2 DIMENSION MEASUREMENT

The following uncertainties apply to the dimension measurements:

Length (mm)	Expanded Uncertainty on Length
3 - 300	0.05 mm

5.3 VALIDATION MEASUREMENT

The guidelines outlined in the IEEE 1528, FCC KDBs, CENELEC EN50361 and CEI/IEC 62209 standards were followed to generate the measurement uncertainty for validation measurements.

Scan Volume	Expanded Uncertainty
1 g	20.3 %

Page: 5/11

*This document shall not be reproduced, except in full or in part, without the written approval of MVG.
The information contained herein is to be used only for the purpose for which it is submitted and is not to be released in whole or part without written approval of MVG.*



SAR REFERENCE DIPOLE CALIBRATION REPORT

Ref. ACR.156.10.15.SATU.A

10 g	20.1 %
------	--------

6 CALIBRATION MEASUREMENT RESULTS

6.1 RETURN LOSS AND IMPEDANCE IN HEAD LIQUID

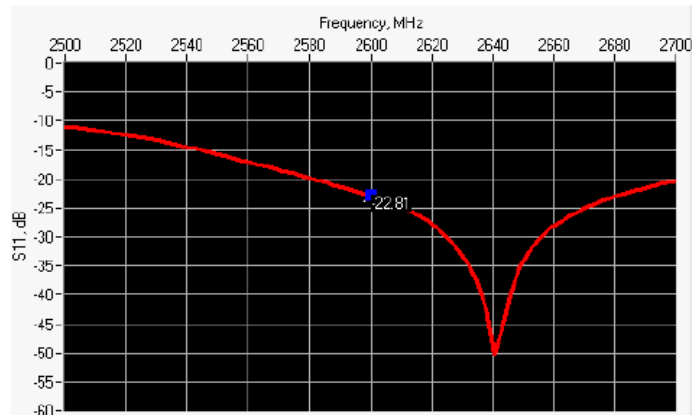

Frequency (MHz)	Return Loss (dB)	Requirement (dB)	Impedance
2600	-22.81	-20	55.3 Ω - 5.1 jΩ

6.2 RETURN LOSS AND IMPEDANCE IN BODY LIQUID

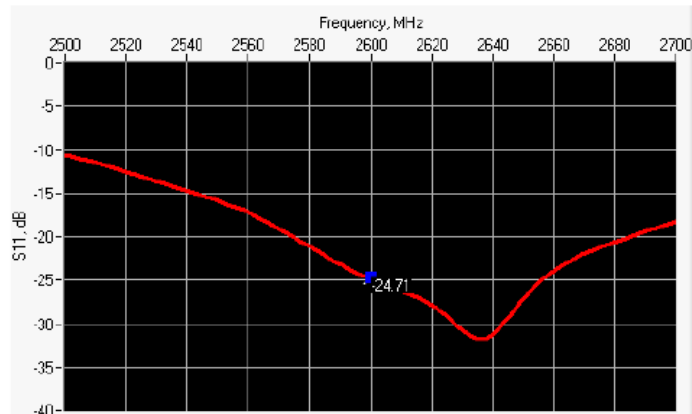

Frequency (MHz)	Return Loss (dB)	Requirement (dB)	Impedance
2600	-24.71	-20	51.5 Ω - 5.5 jΩ

6.3 MECHANICAL DIMENSIONS

Frequency MHz	L mm		h mm		d mm	
	required	measured	required	measured	required	measured
300	420.0 ±1 %.		250.0 ±1 %.		6.35 ±1 %.	

Page: 6/11

This document shall not be reproduced, except in full or in part, without the written approval of MVG. The information contained herein is to be used only for the purpose for which it is submitted and is not to be released in whole or part without written approval of MVG.



SAR REFERENCE DIPOLE CALIBRATION REPORT

Ref: ACR.156.10.15.SATU.A

450	290.0 ±1 %.		166.7 ±1 %.		6.35 ±1 %.	
750	176.0 ±1 %.		100.0 ±1 %.		6.35 ±1 %.	
835	161.0 ±1 %.		89.8 ±1 %.		3.6 ±1 %.	
900	149.0 ±1 %.		83.3 ±1 %.		3.6 ±1 %.	
1450	89.1 ±1 %.		51.7 ±1 %.		3.6 ±1 %.	
1500	80.5 ±1 %.		50.0 ±1 %.		3.6 ±1 %.	
1640	79.0 ±1 %.		45.7 ±1 %.		3.6 ±1 %.	
1750	75.2 ±1 %.		42.9 ±1 %.		3.6 ±1 %.	
1800	72.0 ±1 %.		41.7 ±1 %.		3.6 ±1 %.	
1900	68.0 ±1 %.		39.5 ±1 %.		3.6 ±1 %.	
1950	66.3 ±1 %.		38.5 ±1 %.		3.6 ±1 %.	
2000	64.5 ±1 %.		37.5 ±1 %.		3.6 ±1 %.	
2100	61.0 ±1 %.		35.7 ±1 %.		3.6 ±1 %.	
2300	55.5 ±1 %.		32.6 ±1 %.		3.6 ±1 %.	
2450	51.5 ±1 %.		30.4 ±1 %.		3.6 ±1 %.	
2600	48.5 ±1 %.	PASS	28.8 ±1 %.	PASS	3.6 ±1 %.	PASS
3000	41.5 ±1 %.		25.0 ±1 %.		3.6 ±1 %.	
3500	37.0 ±1 %.		26.4 ±1 %.		3.6 ±1 %.	
3700	34.7 ±1 %.		26.4 ±1 %.		3.6 ±1 %.	

7 VALIDATION MEASUREMENT

The IEEE Std. 1528, FCC KDBs and CEI/IEC 62209 standards state that the system validation measurements must be performed using a reference dipole meeting the fore mentioned return loss and mechanical dimension requirements. The validation measurement must be performed against a liquid filled flat phantom, with the phantom constructed as outlined in the fore mentioned standards. Per the standards, the dipole shall be positioned below the bottom of the phantom, with the dipole length centered and parallel to the longest dimension of the flat phantom, with the top surface of the dipole at the described distance from the bottom surface of the phantom.

7.1 HEAD LIQUID MEASUREMENT

Frequency MHz	Relative permittivity (ε _r)		Conductivity (σ) S/m	
	required	measured	required	measured
300	45.3 ±5 %		0.87 ±5 %	
450	43.5 ±5 %		0.87 ±5 %	
750	41.9 ±5 %		0.89 ±5 %	
835	41.5 ±5 %		0.90 ±5 %	
900	41.5 ±5 %		0.97 ±5 %	
1450	40.5 ±5 %		1.20 ±5 %	
1500	40.4 ±5 %		1.23 ±5 %	
1640	40.2 ±5 %		1.31 ±5 %	
1750	40.1 ±5 %		1.37 ±5 %	

Page: 7/11

This document shall not be reproduced, except in full or in part, without the written approval of MVG. The information contained herein is to be used only for the purpose for which it is submitted and is not to be released in whole or part without written approval of MVG.



SAR REFERENCE DIPOLE CALIBRATION REPORT

Ref. ACR.156.10.15.SAT.U.A

1800	40.0 ±5 %		1.40 ±5 %	
1900	40.0 ±5 %		1.40 ±5 %	
1950	40.0 ±5 %		1.40 ±5 %	
2000	40.0 ±5 %		1.40 ±5 %	
2100	39.8 ±5 %		1.49 ±5 %	
2300	39.5 ±5 %		1.67 ±5 %	
2450	39.2 ±5 %		1.80 ±5 %	
2600	39.0 ±5 %	PASS	1.96 ±5 %	PASS
3000	38.5 ±5 %		2.40 ±5 %	
3500	37.9 ±5 %		2.91 ±5 %	

7.2 SAR MEASUREMENT RESULT WITH HEAD LIQUID

The IEEE Std. 1528 and CEI/IEC 62209 standards state that the system validation measurements should produce the SAR values shown below (for phantom thickness of 2 mm), within the uncertainty for the system validation. All SAR values are normalized to 1 W forward power. In bracket, the measured SAR is given with the used input power.

Software	OPENSAR V4
Phantom	SN 20/09 SAM71
Probe	SN 18/11 EPG122
Liquid	Head Liquid Values: eps' : 38.2 sigma : 1.93
Distance between dipole center and liquid	10.0 mm
Area scan resolution	dx=8mm/dy=8mm
Zoon Scan Resolution	dx=5mm/dy=5mm/dz=5mm
Frequency	2600 MHz
Input power	20 dBm
Liquid Temperature	21 °C
Lab Temperature	21 °C
Lab Humidity	45 %

Frequency MHz	1 g SAR (W/kg/W)		10 g SAR (W/kg/W)	
	required	measured	required	measured
300	2.85		1.94	
450	4.58		3.06	
750	8.49		5.55	
835	9.56		6.22	
900	10.9		6.99	
1450	29		16	
1500	30.5		16.8	
1640	34.2		18.4	
1750	36.4		19.3	
1800	38.4		20.1	

Page: 8/11

This document shall not be reproduced, except in full or in part, without the written approval of MVG. The information contained herein is to be used only for the purpose for which it is submitted and is not to be released in whole or part without written approval of MVG.



SAR REFERENCE DIPOLE CALIBRATION REPORT

Ref: ACR.156.10.15.SATU.A

1900	39.7		20.5	
1950	40.5		20.9	
2000	41.1		21.1	
2100	43.6		21.9	
2300	48.7		23.3	
2450	52.4		24	
2600	55.3	54.31 (5.36)	24.6	24.14 (2.42)
3000	63.8		25.7	
3500	67.1		25	

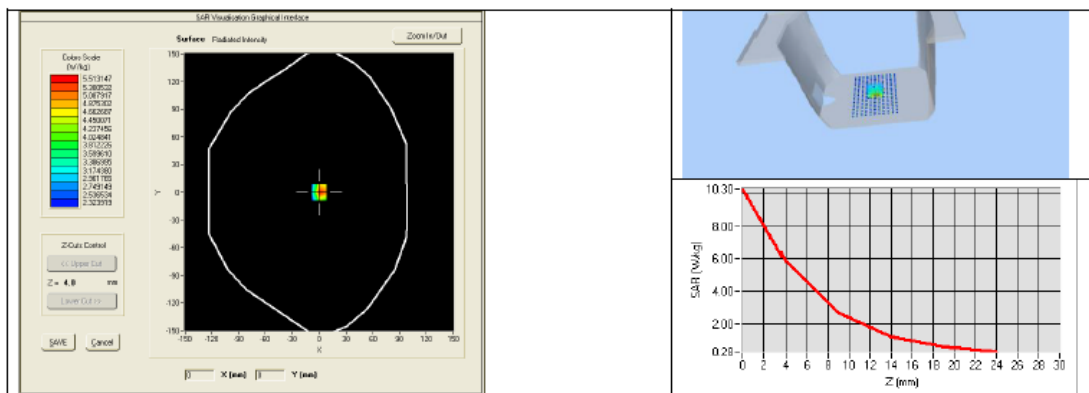

7.3 BODY LIQUID MEASUREMENT

Frequency MHz	Relative permittivity (ϵ_r')		Conductivity (σ) S/m	
	required	measured	required	measured
150	61.9 ± 5 %		0.80 ± 5 %	
300	58.2 ± 5 %		0.92 ± 5 %	
450	56.7 ± 5 %		0.94 ± 5 %	
750	55.5 ± 5 %		0.96 ± 5 %	
835	55.2 ± 5 %		0.97 ± 5 %	
900	55.0 ± 5 %		1.05 ± 5 %	
915	55.0 ± 5 %		1.06 ± 5 %	
1450	54.0 ± 5 %		1.30 ± 5 %	
1610	53.8 ± 5 %		1.40 ± 5 %	
1800	53.3 ± 5 %		1.52 ± 5 %	
1900	53.3 ± 5 %		1.52 ± 5 %	
2000	53.3 ± 5 %		1.52 ± 5 %	
2100	53.2 ± 5 %		1.62 ± 5 %	
2450	52.7 ± 5 %		1.95 ± 5 %	

Page: 9/11

This document shall not be reproduced, except in full or in part, without the written approval of MVG. The information contained herein is to be used only for the purpose for which it is submitted and is not to be released in whole or part without written approval of MVG.



SAR REFERENCE DIPOLE CALIBRATION REPORT

Ref: ACR.156.10.15.SATU.A

2600	52.5 ±5 %	PASS	2.16 ±5 %	PASS
3000	52.0 ±5 %		2.73 ±5 %	
3500	51.3 ±5 %		3.31 ±5 %	
5200	49.0 ±10 %		5.30 ±10 %	
5300	48.9 ±10 %		5.42 ±10 %	
5400	48.7 ±10 %		5.53 ±10 %	
5500	48.6 ±10 %		5.65 ±10 %	
5600	48.5 ±10 %		5.77 ±10 %	
5800	48.2 ±10 %		6.00 ±10 %	

7.4 SAR MEASUREMENT RESULT WITH BODY LIQUID

Software	OPENSAR V4
Phantom	SN 20/09 SAM71
Probe	SN 18/11 EPG122
Liquid	Body Liquid Values: eps' : 51.6 sigma : 2.21
Distance between dipole center and liquid	10.0 mm
Area scan resolution	dx=8mm/dy=8mm
Zoon Scan Resolution	dx=5mm/dy=5mm/dz=5mm
Frequency	2600 MHz
Input power	20 dBm
Liquid Temperature	21 °C
Lab Temperature	21 °C
Lab Humidity	45 %

Frequency MHz	1 g SAR (W/kg/W)	10 g SAR (W/kg/W)
	measured	measured
2600	53.26 (5.12)	23.89 (2.30)

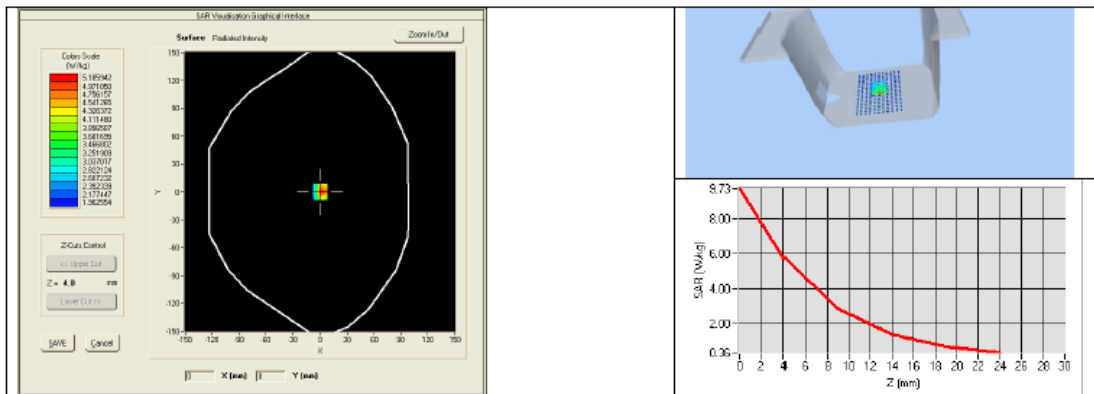

Page: 10/11

This document shall not be reproduced, except in full or in part, without the written approval of MVG. The information contained herein is to be used only for the purpose for which it is submitted and is not to be released in whole or part without written approval of MVG.



8 LIST OF EQUIPMENT

Equipment Summary Sheet				
Equipment Description	Manufacturer / Model	Identification No.	Current Calibration Date	Next Calibration Date
SAM Phantom	MVG	SN-20/09-SAM71	Validated. No cal required.	Validated. No cal required.
COMOSAR Test Bench	Version 3	NA	Validated. No cal required.	Validated. No cal required.
Network Analyzer	Rhode & Schwarz ZVA	SN100132	02/2021	02/2024
Calipers	Carrera	CALIPER-01	02/2021	02/2024
Reference Probe	MVG	EPG122 SN 18/11	02/2021	02/2022
Multimeter	Keithley 2000	1188656	02/2021	02/2024
Signal Generator	Agilent E4438C	MY49070581	02/2021	02/2024
Amplifier	Aethercomm	SN 046	Characterized prior to test. No cal required.	Characterized prior to test. No cal required.
Power Meter	HP E4418A	US38261498	02/2021	02/2024
Power Sensor	HP ECP-E26A	US37181460	02/2021	02/2024
Directional Coupler	Narda 4216-20	01386	Characterized prior to test. No cal required.	Characterized prior to test. No cal required.
Temperature and Humidity Sensor	Control Company	11-661-9	09/2021	09/2022

SID5G



SAR Reference Waveguide Calibration Report

Ref : ACR.256.12.15.SATU.A

SHENZHEN TCT TESTING TECHNOLOGY CO., LTD
2101&2201, ZHENCHANG FACTORY, RENSHAN INDUSTRIAL
ZONE, FUHAI SUBDISTRICT, BAOAN DISTRICT, SHENZHEN,
GUANGDONG, 518103, PEOPLES REPUBLIC OF CHINA
MVG COMOSAR REFERENCE WAVEGUIDE
FREQUENCY: 5000-6000 MHZ
SERIAL NO.: SN 13/14 WGA32

Calibrated at MVG US
2105 Barrett Park Dr. - Kennesaw, GA 30144



Calibration Date: 05/15/2021

Summary:

This document presents the method and results from an accredited SAR reference waveguide calibration performed in MVG USA using the COMOSAR test bench. All calibration results are traceable to national metrology institutions.



SAR REFERENCE WAVEGUIDE CALIBRATION REPORT

Ref: ACR.256.12.15.SATU.A

	<i>Name</i>	<i>Function</i>	<i>Date</i>	<i>Signature</i>
<i>Prepared by :</i>	Jérôme LUC	Product Manager	8/29/2021	<i>JLS</i>
<i>Checked by :</i>	Jérôme LUC	Product Manager	8/29/2021	<i>JLS</i>
<i>Approved by :</i>	Kim RUTKOWSKI	Quality Manager	8/29/2021	<i>Kim Rutkowski</i>

	<i>Customer Name</i>
<i>Distribution :</i>	SHENZHEN TONGCE TESTING LAB

<i>Issue</i>	<i>Date</i>	<i>Modifications</i>
A	8/29/2021	Initial release



TABLE OF CONTENTS

1 Introduction..... 4

2 Device Under Test 4

3 Product Description 4

 3.1 General Information 4

4 Measurement Method 4

 4.1 Return Loss Requirements 4

 4.2 Mechanical Requirements 4

5 Measurement Uncertainty 5

 5.1 Return Loss 5

 5.2 Dimension Measurement 5

 5.3 Validation Measurement 5

6 Calibration Measurement Results 5

 6.1 Return Loss 5

 6.2 Mechanical Dimensions 6

7 Validation measurement 6

 7.1 Head Liquid Measurement 7

 7.2 Measurement Result 7

 7.3 Body Measurement Result 10

8 List of Equipment 13



1 INTRODUCTION

This document contains a summary of the requirements set forth by the IEEE 1528 and CEI/IEC 62209 standards for reference waveguides used for SAR measurement system validations and the measurements that were performed to verify that the product complies with the fore mentioned standards.

2 DEVICE UNDER TEST

Device Under Test	
Device Type	COMOSAR 5000-6000 MHz REFERENCE WAVEGUIDE
Manufacturer	MVG
Model	SWG5500
Serial Number	SN 13/14 WGA32
Product Condition (new / used)	New

A yearly calibration interval is recommended.

3 PRODUCT DESCRIPTION

3.1 GENERAL INFORMATION

MVG's COMOSAR Validation Waveguides are built in accordance to the IEEE 1528 and CEI/IEC 62209 standards.

4 MEASUREMENT METHOD

The IEEE 1528 and CEI/IEC 62209 standards provide requirements for reference waveguides used for system validation measurements. The following measurements were performed to verify that the product complies with the fore mentioned standards.

4.1 RETURN LOSS REQUIREMENTS

The waveguide used for SAR system validation measurements and checks must have a return loss of -8 dB or better. The return loss measurement shall be performed with matching layer placed in the open end of the waveguide, with the waveguide and matching layer in direct contact with the phantom shell as outlined in the fore mentioned standards.

4.2 MECHANICAL REQUIREMENTS

The IEEE 1528 and CEI/IEC 62209 standards specify the mechanical dimensions of the validation waveguide, the specified dimensions are as shown in Section 6.2. Figure 1 shows how the dimensions relate to the physical construction of the waveguide.



5 MEASUREMENT UNCERTAINTY

All uncertainties listed below represent an expanded uncertainty expressed at approximately the 95% confidence level using a coverage factor of k=2, traceable to the Internationally Accepted Guides to Measurement Uncertainty.

5.1 RETURN LOSS

The following uncertainties apply to the return loss measurement:

Frequency band	Expanded Uncertainty on Return Loss
400-6000MHz	0.1 dB

5.2 DIMENSION MEASUREMENT

The following uncertainties apply to the dimension measurements:

Length (mm)	Expanded Uncertainty on Length
3 - 300	0.05 mm

5.3 VALIDATION MEASUREMENT

The guidelines outlined in the IEEE 1528 and CEI/IEC 62209 standards were followed to generate the measurement uncertainty for validation measurements.

Scan Volume	Expanded Uncertainty
1 g	20.3 %
10 g	20.1 %

6 CALIBRATION MEASUREMENT RESULTS

6.1 RETURN LOSS IN HEAD LIQUID

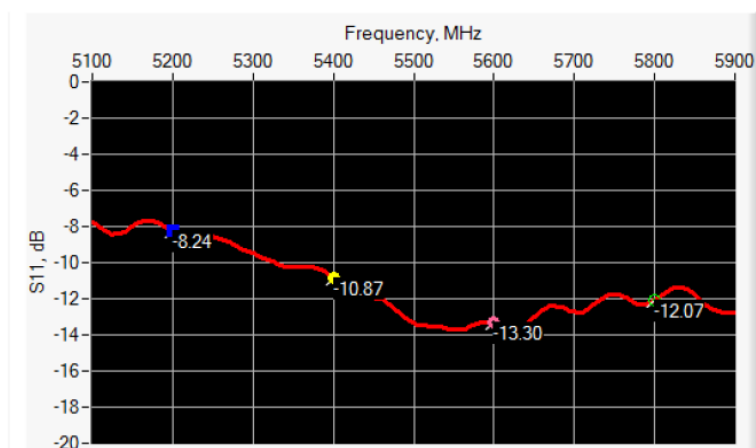

Frequency (MHz)	Return Loss (dB)	Requirement (dB)
5000-6000	< -8.24	-8



6.2 RETURN LOSS IN BODY LIQUID

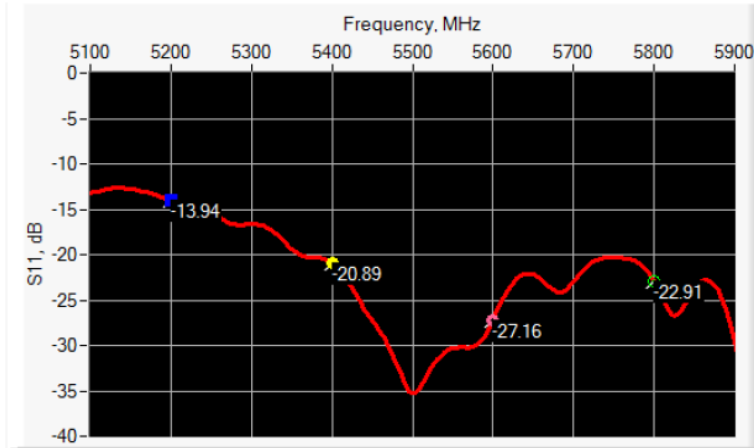

Frequency (MHz)	Return Loss (dB)	Requirement (dB)
5000-6000	< -13.94	-8

6.3 MECHANICAL DIMENSIONS

Frequency (MHz)	L (mm)		W (mm)		L _f (mm)		W _f (mm)		T (mm)	
	Requirement	Measure	Requirement	Measure	Requirement	Measure	Requirement	Measure	Requirement	Measure
5200	40.39 ± 0.13	PASS	20.19 ± 0.13	PASS	81.03 ± 0.13	PASS	61.98 ± 0.13	PASS	5.3*	PASS
5800	40.39 ± 0.13	PASS	20.19 ± 0.13	PASS	81.03 ± 0.13	PASS	61.98 ± 0.13	PASS	4.3*	PASS

* The tolerance for the matching layer is included in the return loss measurement.

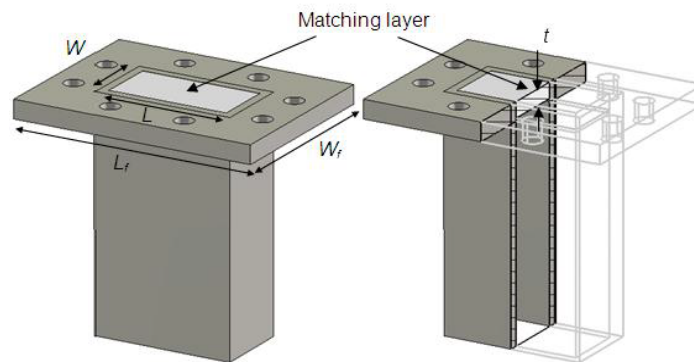

Figure 1: Validation Waveguide Dimensions

7 VALIDATION MEASUREMENT

The IEEE Std. 1528 and CEI/IEC 62209 standards state that the system validation measurements must be performed using a reference waveguide meeting the fore mentioned return loss and mechanical dimension requirements. The validation measurement must be performed with the matching layer placed in the open end of the waveguide, with the waveguide and matching layer in direct contact with the phantom shell.



7.1 HEAD LIQUID MEASUREMENT

Frequency MHz	Relative permittivity (ϵ_r')		Conductivity (σ) S/m	
	required	measured	required	measured
5000	36.2 ±10 %		4.45 ±10 %	
5100	36.1 ±10 %		4.56 ±10 %	
5200	36.0 ±10 %	PASS	4.66 ±10 %	PASS
5300	35.9 ±10 %		4.76 ±10 %	
5400	35.8 ±10 %	PASS	4.86 ±10 %	PASS
5500	35.6 ±10 %		4.97 ±10 %	
5600	35.5 ±10 %	PASS	5.07 ±10 %	PASS
5700	35.4 ±10 %		5.17 ±10 %	
5800	35.3 ±10 %	PASS	5.27 ±10 %	PASS
5900	35.2 ±10 %		5.38 ±10 %	
6000	35.1 ±10 %		5.48 ±10 %	

7.2 SAR MEASUREMENT RESULT WITH HEAD LIQUID

At those frequencies, the target SAR value can not be generic. Hereunder is the target SAR value defined by MVG, within the uncertainty for the system validation. All SAR values are normalized to 1 W net power. In bracket, the measured SAR is given with the used input power.

Software	OPENSAR V4
Phantom	SN 20/09 SAM71
Probe	SN 18/11 EPG122
Liquid	Head Liquid Values 5200 MHz: ϵ_s' :36.62 σ : 4.93 Head Liquid Values 5400 MHz: ϵ_s' :35.95 σ : 5.18 Head Liquid Values 5600 MHz: ϵ_s' :36.08 σ : 5.60 Head Liquid Values 5800 MHz: ϵ_s' :34.73 σ : 5.74
Distance between dipole waveguide and liquid	0 mm
Area scan resolution	dx=8mm/dy=8mm
Zoon Scan Resolution	dx=4mm/dy=4m/dz=2mm
Frequency	5200 MHz 5400 MHz 5600 MHz 5800 MHz
Input power	20 dBm
Liquid Temperature	21 °C
Lab Temperature	21 °C
Lab Humidity	45 %



SAR REFERENCE WAVEGUIDE CALIBRATION REPORT

Ref: ACR.256.12.15.SATU.A

Frequency (MHz)	1 g SAR (W/kg)		10 g SAR (W/kg)	
	required	measured	required	measured
5200	159.00	163.88 (16.39)	56.90	57.29 (5.73)
5400	166.40	172.23 (17.22)	58.43	59.16 (5.92)
5600	173.80	181.28 (18.13)	59.97	61.57 (6.16)
5800	181.20	188.95 (18.90)	61.50	63.45 (6.35)

SAR MEASUREMENT PLOTS @ 5200 MHz

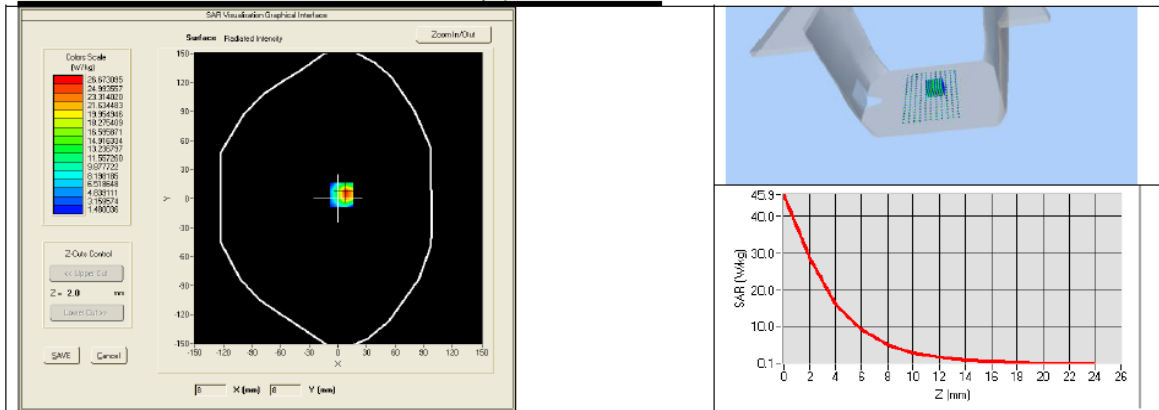

SAR MEASUREMENT PLOTS @ 5400 MHz

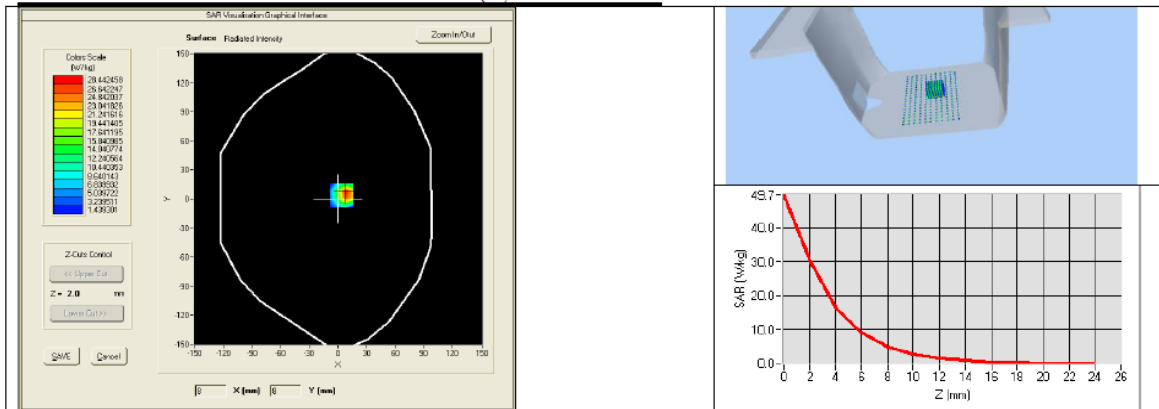



SAR REFERENCE WAVEGUIDE CALIBRATION REPORT

Ref: ACR.256.12.15.SATU.A

SAR MEASUREMENT PLOTS @ 5600 MHz

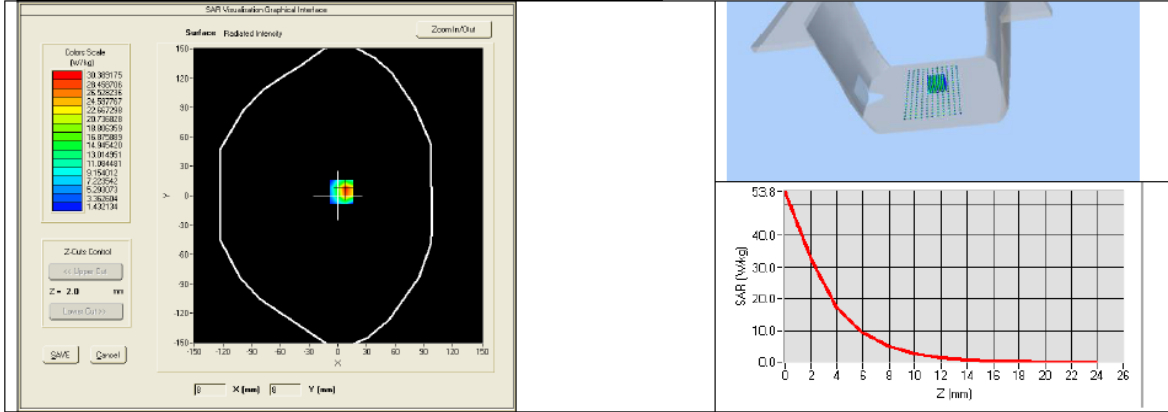

SAR MEASUREMENT PLOTS @ 5800 MHz

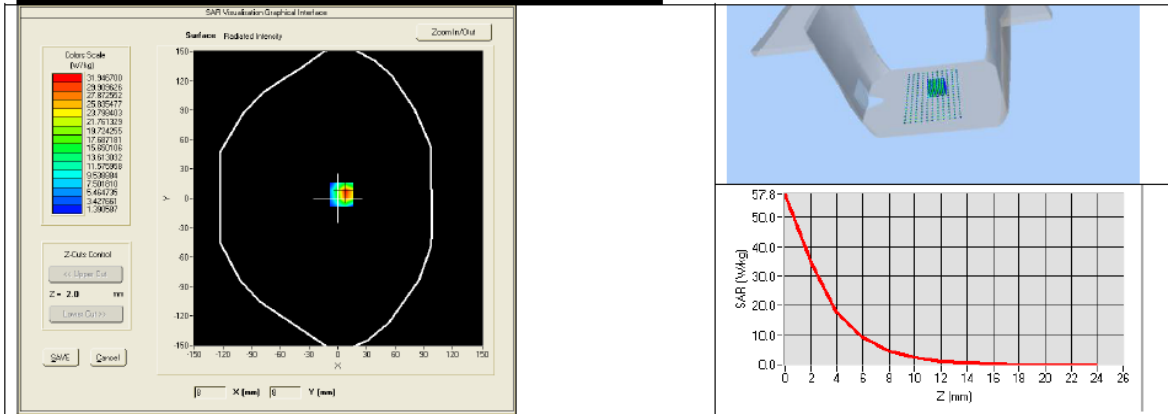



7.3 BODY LIQUID MEASUREMENT

Frequency MHz	Relative permittivity (ϵ_r')		Conductivity (σ) S/m	
	required	measured	required	measured
5200	49.0 ±10 %	PASS	5.30 ±10 %	PASS
5300	48.9 ±10 %		5.42 ±10 %	
5400	48.7 ±10 %	PASS	5.53 ±10 %	PASS
5500	48.6 ±10 %		5.65 ±10 %	
5600	48.5 ±10 %	PASS	5.77 ±10 %	PASS
5800	48.2 ±10 %	PASS	6.00 ±10 %	PASS

7.4 SAR MEASUREMENT RESULT WITH BODY LIQUID

Software	OPENSAR V4
Phantom	SN 20/09 SAM71
Probe	SN 18/11 EPG122
Liquid	Body Liquid Values 5200 MHz: ϵ_r' :50.69 σ : 4.98 Body Liquid Values 5400 MHz: ϵ_r' :48.45 σ : 5.82 Body Liquid Values 5600 MHz: ϵ_r' :50.57 σ : 6.37 Body Liquid Values 5800 MHz: ϵ_r' :48.19 σ : 6.45
Distance between dipole waveguide and liquid	0 mm
Area scan resolution	dx=8mm/dy=8mm
Zoon Scan Resolution	dx=4mm/dy=4m/dz=2mm
Frequency	5200 MHz 5400 MHz 5600 MHz 5800 MHz
Input power	20 dBm
Liquid Temperature	21 °C
Lab Temperature	21 °C
Lab Humidity	45 %

Frequency (MHz)	1 g SAR (W/kg) measured	10 g SAR (W/kg) measured
5200	158.49 (15.85)	55.40 (5.54)
5400	167.20 (16.72)	57.39 (5.74)
5600	175.65 (17.57)	59.48 (5.95)
5800	183.06 (18.31)	61.62 (6.16)



BODY SAR MEASUREMENT PLOTS @ 5200 MHz

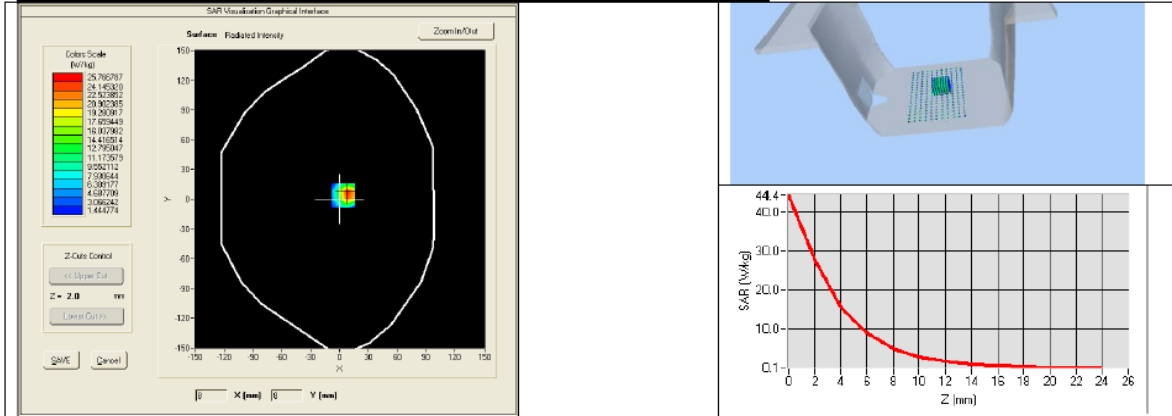

BODY SAR MEASUREMENT PLOTS @ 5400 MHz

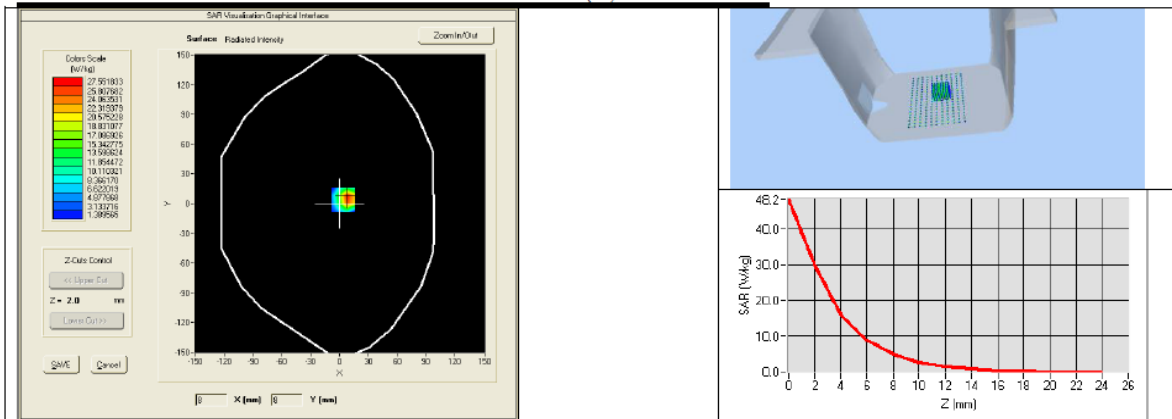

BODY SAR MEASUREMENT PLOTS @ 5600 MHz

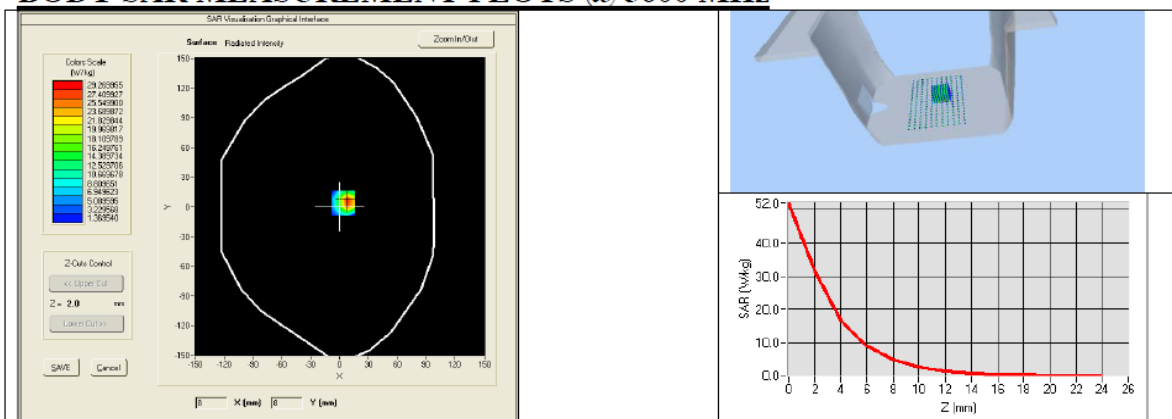



BODY SAR MEASUREMENT PLOTS @ 5800 MHz

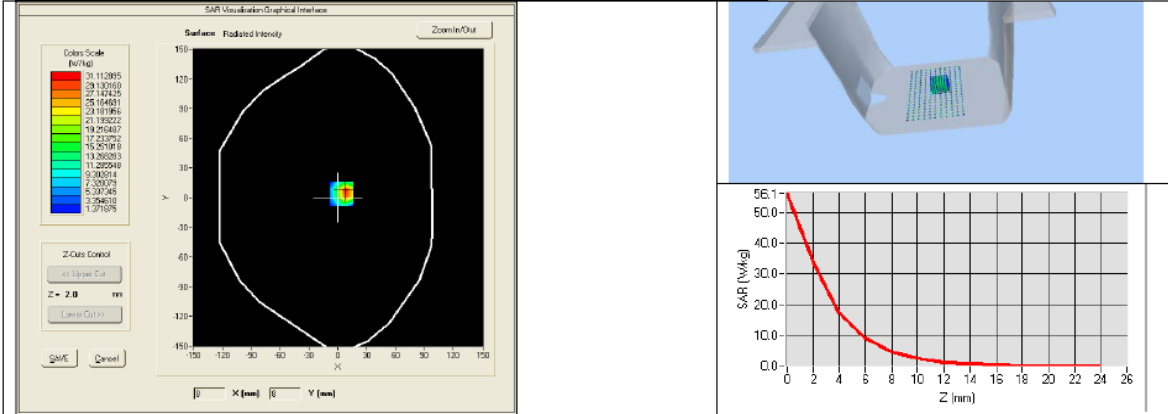



8 LIST OF EQUIPMENT

Equipment Summary Sheet				
Equipment Description	Manufacturer / Model	Identification No.	Current Calibration Date	Next Calibration Date
Flat Phantom	MVG	SN-20/09-SAM71	Validated. No cal required.	Validated. No cal required.
COMOSAR Test Bench	Version 3	NA	Validated. No cal required.	Validated. No cal required.
Network Analyzer	Rhode & Schwarz ZVA	SN100132	02/2019	02/2022
Calipers	Carrera	CALIPER-01	01/2020	01/2023
Reference Probe	MVG	EPG122 SN 18/11	10/2021	10/2022
Multimeter	Keithley 2000	1188656	01/2020	01/2023
Signal Generator	Agilent E4438C	MY49070581	01/2020	01/2023
Amplifier	Aethercomm	SN 046	Characterized prior to test. No cal required.	Characterized prior to test. No cal required.
Power Meter	HP E4418A	US38261498	01/2020	01/2023
Power Sensor	HP ECP-E26A	US37181460	01/2020	01/2023
Directional Coupler	Narda 4216-20	01386	Characterized prior to test. No cal required.	Characterized prior to test. No cal required.
Temperature and Humidity Sensor	Control Company	150798832	10/2021	10/2022

Appendix E: SAR SYSTEM VALIDATION

Per FCC KDB 865664 D02v01, SAR system validation status should be documented to confirm measurement accuracy. The SAR systems (including SAR probes, system components and software versions) used for this device were validated against its performance specifications prior to the SAR measurements. Reference dipoles were used with the required tissue- equivalent media for system validation, according to the procedures outlined in FCC KDB 865664 D01 v01 and IEEE 1528-2013. Since SAR probe calibrations are frequency dependent, each probe calibration point was validated at a frequency within the valid frequency range of the probe calibration point, using the system that normally operates with the probe for routine SAR measurements and according to the required tissue-equivalent media.

A tabulated summary of the system validation status including the validation date(s), measurement frequencies, SAR probes and tissue dielectric parameters has been included.

SAR System Validation Summary

Date	Freq. [MHz]	Probe S/N	Tissue type	COND. PERM.	COND. PERM.	CW Validation			Mod. Validation		
				(σ)	(ϵ_r)	sensitivity	Probe linearity	Probe isotropy	Mod. type	Duty factor	Peak to average power ratio
09/06/2022	835	SN 36/20 EPGO 346	Head	42.3	0.89	PASS	PASS	PASS	GMSK	PASS	N/A
09/06/2022	1800	SN 36/20 EPGO 346	Head	40.57	1.36	PASS	PASS	PASS	GMSK	PASS	N/A
09/06/2022	1900	SN 36/20 EPGO 346	Head	40.31	1.38	PASS	PASS	PASS	GMSK	PASS	N/A
09/06/2022	2450	SN 36/20 EPGO 346	Head	38.99	1.88	PASS	PASS	PASS	OFDM	PASS	N/A
09/06/2022	2600	SN 36/20 EPGO 346	Head	39.00	1.96	PASS	PASS	PASS	OFDM	PASS	N/A
09/06/2022	5G	SN 36/20 EPGO 346	Head	36.68	4.45 ~ 5.08	PASS	PASS	PASS	OFDM	PASS	N/A

NOTE: While the probes have been calibrated for both a CW and modulated signals, all measurements were performed using communication systems calibrated for CW signals only. Modulations in the table above represent test configurations for which the measurement system has been validated per FCC KDB Publication 865664 D01v01 for scenarios when CW probe calibrations are used with other signal types. SAR systems were validated for modulated signals with a periodic duty cycle, such as OFDM according to KDB 865664.

Appendix F: The Check Data of Impedance and Return Loss

The information are included in the SAR report to qualify for the three-year extended calibration interval;

Impedance in head liquid							Date: 09/06/2022
Freq. (MHz)	Temp (°C)	Dipole Impedance Re(z)			Dipole Impedance Im(z)		
		measured	Target	Δ ($\pm 5\Omega$)	measured	Target	Δ ($\pm 5\Omega$)
835	22	52.30	51.60	0.7	2.30	1.70	0.6
1800	22	46.50	48.60	-2.1	0.60	-0.50	1.1
1900	22	50.30	51.70	-1.4	4.20	4.90	-0.7
2450	22	45.90	46.50	-0.6	-0.36	-0.20	-0.1
2600	22	54.70	55.10	-0.4	5.00	5.10	-0.1
5G	22	36.06	35.30	0.76	4.44	5.27	-0.83

Return loss in head liquid				Date: 09/06/2022
Freq. (MHz)	Temp (°C)	Return loss(dB)		
		measured	Target	Δ ($\pm 20\%$)
835	22	-30.35	-32.78	-7.41
1800	22	-37.89	-36.92	2.63
1900	22	-24.33	-25.64	-5.11
2450	22	-30.95	-29.05	6.54
2600	22	-22.01	-22.81	-3.51
5G	22	-21.87	-22.80	0.93

liquid	Freq. (MHz)	Temp (°C)	ϵ_r / relative permittivity			σ (s/m) / conductivity			ρ (kg/m ³)
			measured	Target	Δ ($\pm 5\%$)	measured	Target	Δ ($\pm 5\%$)	
Head	835	22	42.30	41.50	1.93	0.89	0.90	-1.11	1000
	1800	22	40.50	40.00	1.25	1.36	1.40	-2.86	1000
	1900	22	40.31	40.00	0.78	1.38	1.40	-1.43	1000
	2450	22	38.99	39.20	-0.54	1.88	1.80	4.44	1000
	2600	22	38.85	39.00	-0.38	1.93	1.96	-1.53	1000
	5G	22	36.06	35.30	0.76	4.44	5.27	-0.83	1000

Test Equipment	Manufacturer	Model	Serial Number	Calibration	
				Calibration Date (D.M.Y)	Calibration Due (D.M.Y)
Signal Generator	Agilent	N5182A	MY47070282	Jul. 04, 2022	Jul. 03, 2023
Multimeter	Keithley	Multimeter 2000	4078275	Jul. 04, 2022	Jul. 03, 2023
Network Analyzer	Agilent	8753E	US38432457	Jul. 04, 2022	Jul. 03, 2023
Power Meter	Agilent	E4418B	GB43312526	Jul. 04, 2022	Jul. 03, 2023
Power Sensor	Agilent	E9301A	MY41497725	Jul. 04, 2022	Jul. 03, 2023
Power Amplifier	PE	PE15A4019	112342	N/A	N/A
Temperature / Humidity Sensor	Control company	TH101B	152470214	Jul. 04, 2022	Jul. 03, 2023

*******END OF REPORT*******