

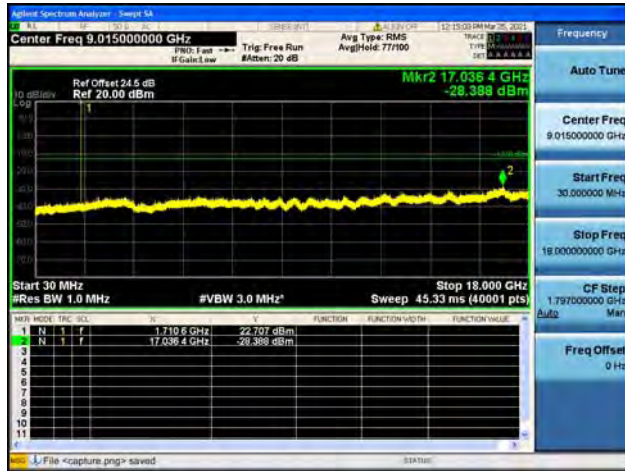

Band4 / 1.4MHz / Low CH / QPSK



Band4 / 1.4MHz / Low CH / 16QAM



Band4 / 1.4MHz / Mid CH / QPSK

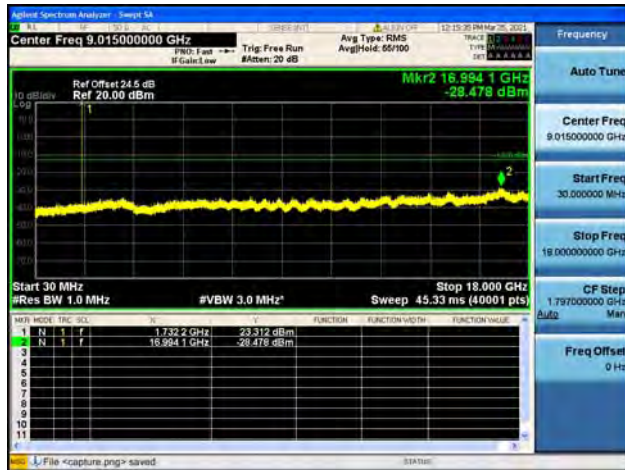

Band4 / 1.4MHz / Mid CH / 16QAM

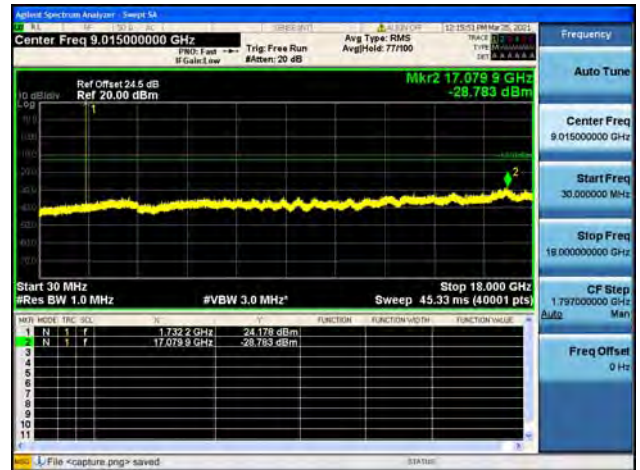

Band4 / 1.4MHz / High CH / QPSK

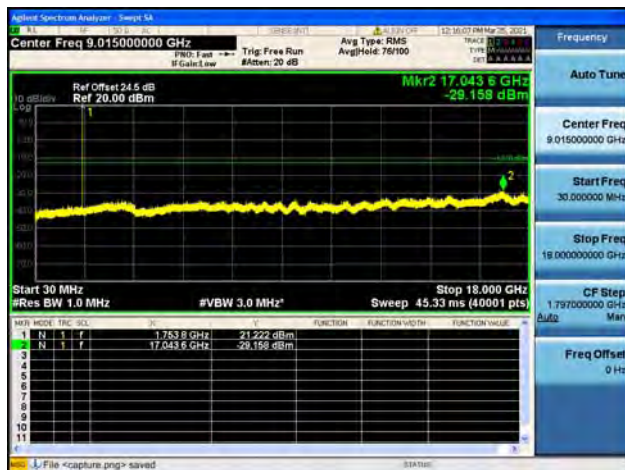

Band4 / 1.4MHz / High CH / 16QAM

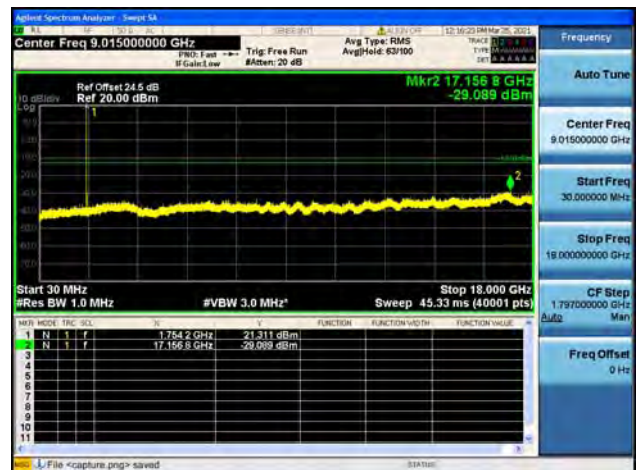



Band4 / 3MHz / Low CH / QPSK



Band4 / 3MHz / Low CH / 16QAM



Band4 / 3MHz / Mid CH / QPSK

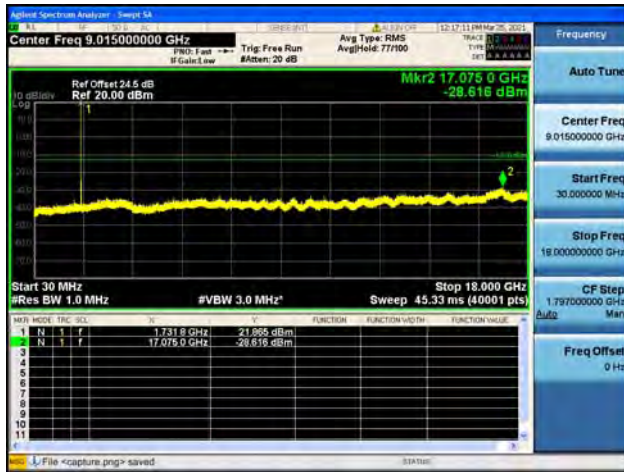

Band4 / 3MHz / Mid CH / 16QAM

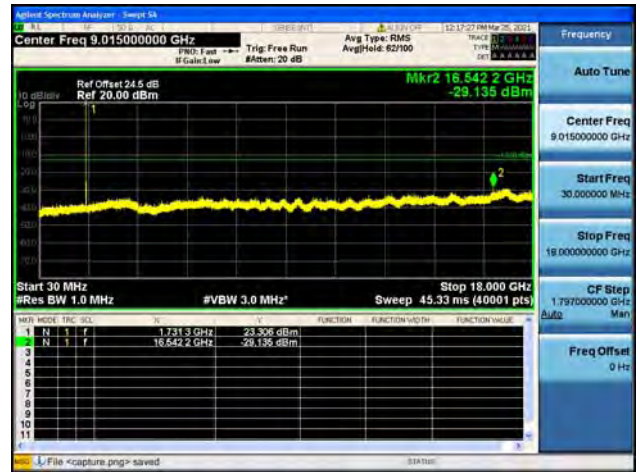

Band4 / 3MHz / High CH / QPSK



Band4 / 3MHz / High CH / 16QAM

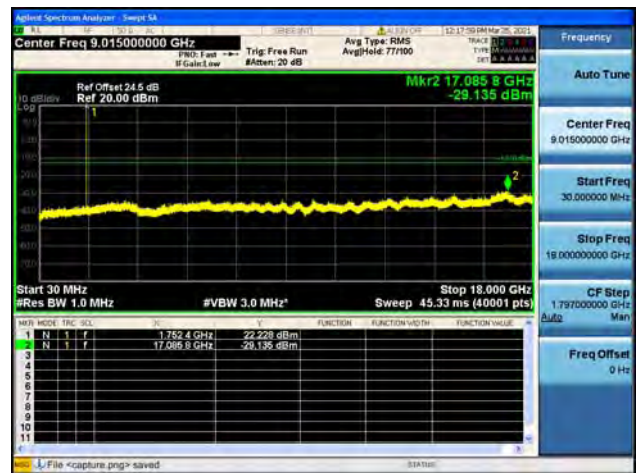



Band4 / 5MHz / Low CH / QPSK



Band4 / 5MHz / Low CH / 16QAM



Band4 / 5MHz / Mid CH / QPSK

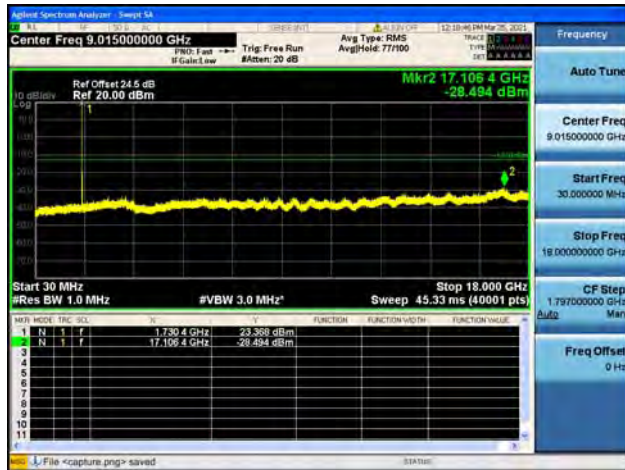

Band4 / 5MHz / Mid CH / 16QAM

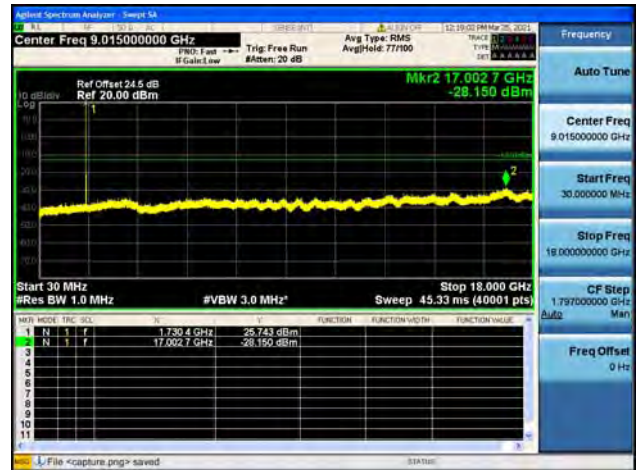

Band4 / 5MHz / High CH / QPSK



Band4 / 5MHz / High CH / 16QAM





Band4 / 10MHz / Low CH / QPSK



Band4 / 10MHz / Low CH / 16QAM

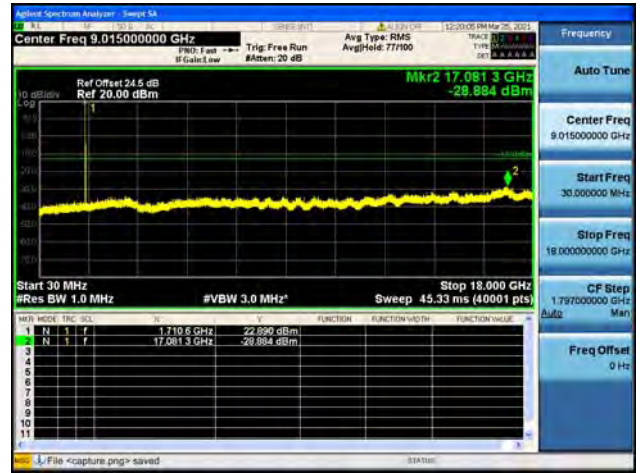

Band4 / 10MHz / Mid CH / QPSK



Band4 / 10MHz / Mid CH / 16QAM

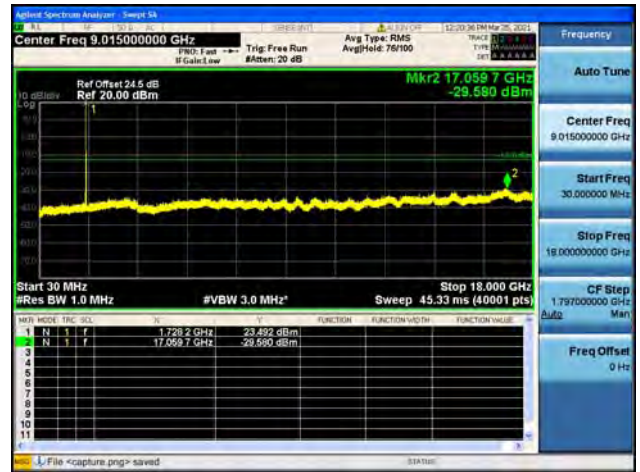

Band4 / 10MHz / High CH / QPSK

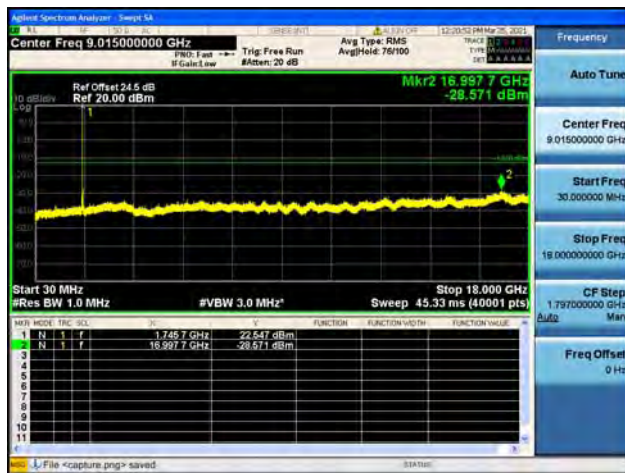

Band4 / 10MHz / High CH / 16QAM

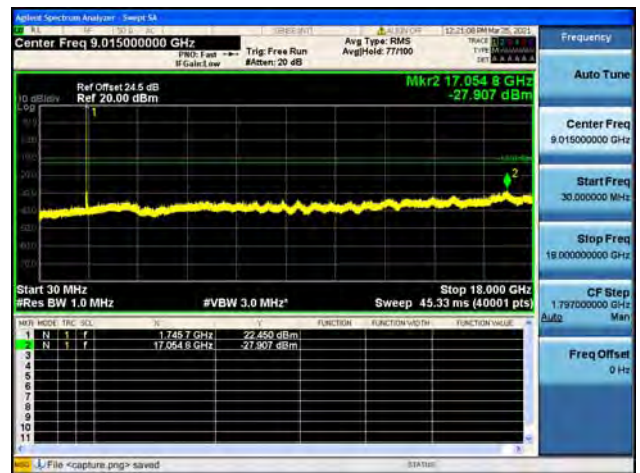



Band4 / 15MHz / Low CH / QPSK

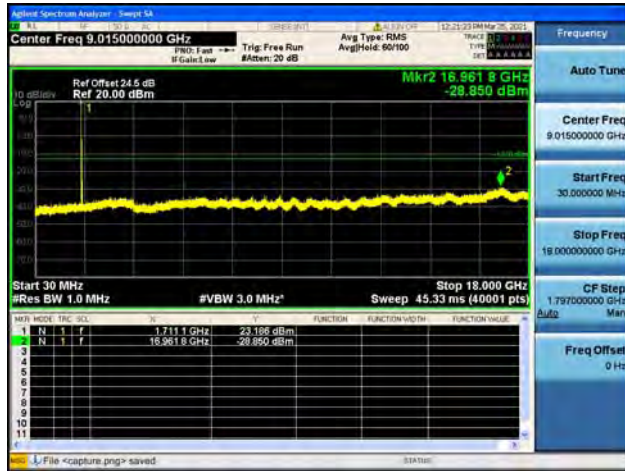

Band4 / 15MHz / Low CH / 16QAM

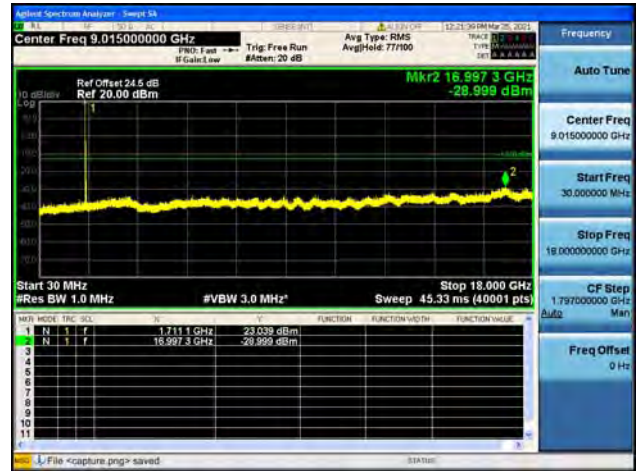

Band4 / 15MHz / Mid CH / QPSK

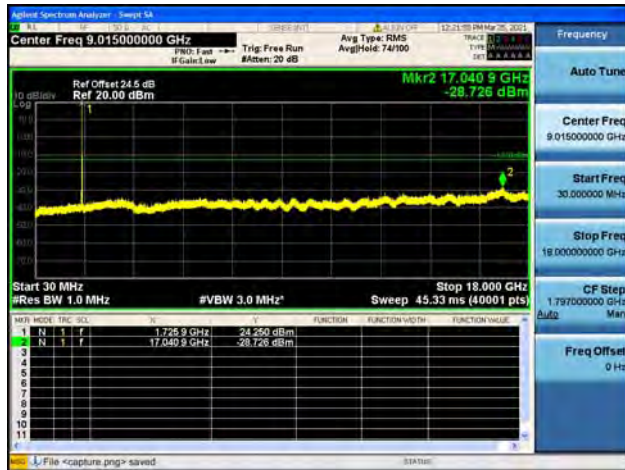

Band4 / 15MHz / Mid CH / 16QAM

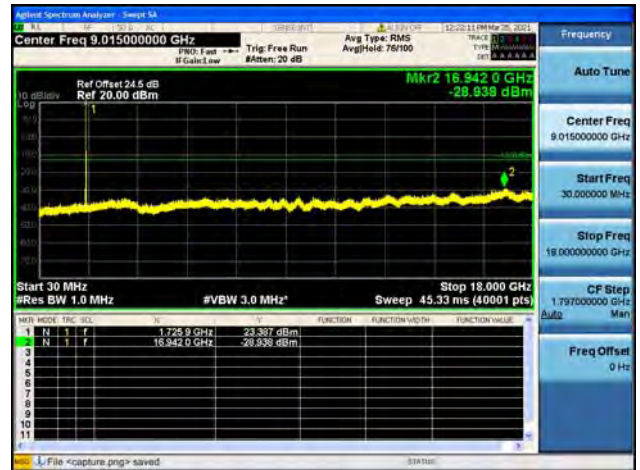

Band4 / 15MHz / High CH / QPSK

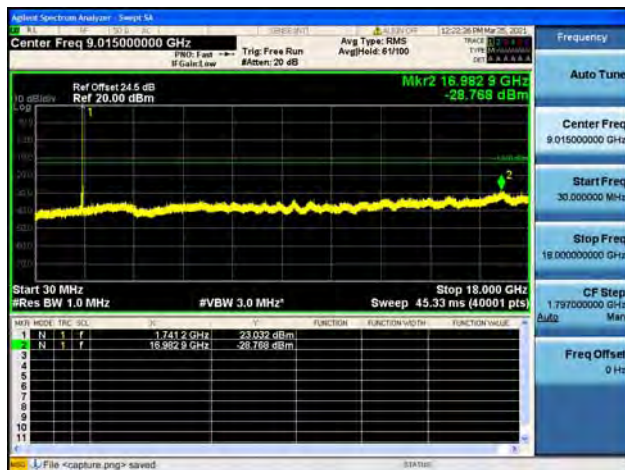

Band4 / 15MHz / High CH / 16QAM





Band4 / 20MHz / Low CH / QPSK

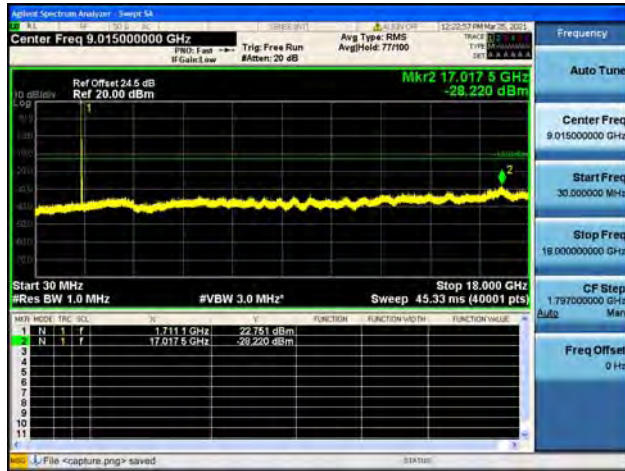

Band4 / 20MHz / Low CH / 16QAM



Band4 / 20MHz / Mid CH / QPSK

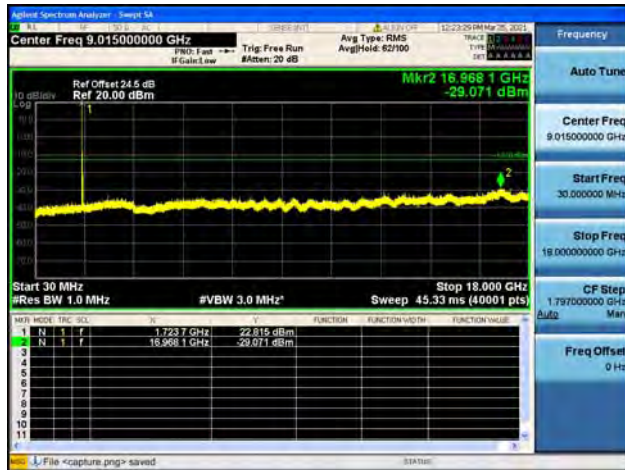

Band4 / 20MHz / Mid CH / 16QAM

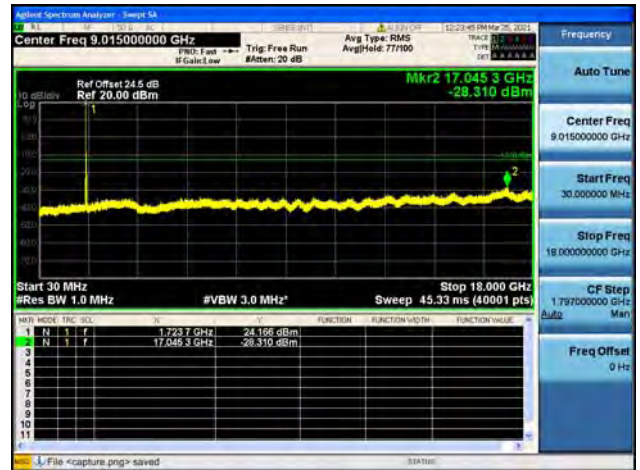

Band4 / 20MHz / High CH / QPSK



Band4 / 20MHz / High CH / 16QAM





Band5 / 1.4MHz / Low CH / QPSK

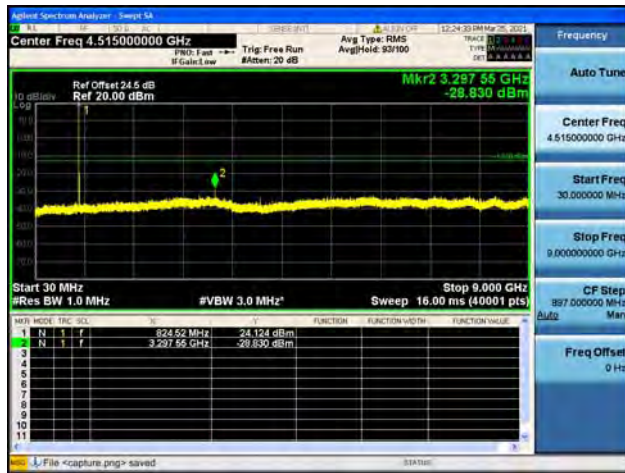

Band5 / 1.4MHz / Low CH / 16QAM

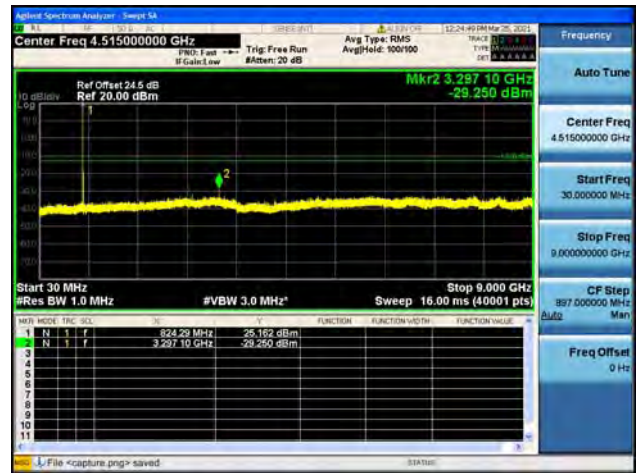

Band5 / 1.4MHz / Mid CH / QPSK

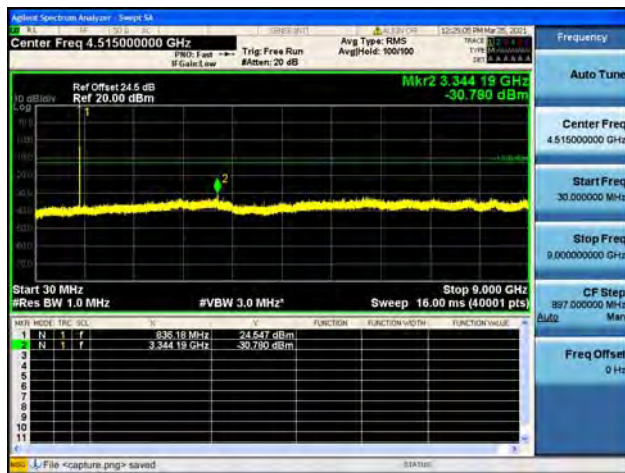

Band5 / 1.4MHz / Mid CH / 16QAM

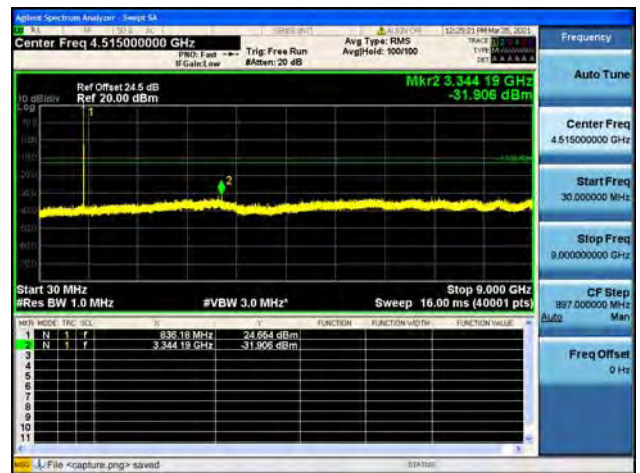

Band5 / 1.4MHz / High CH / QPSK

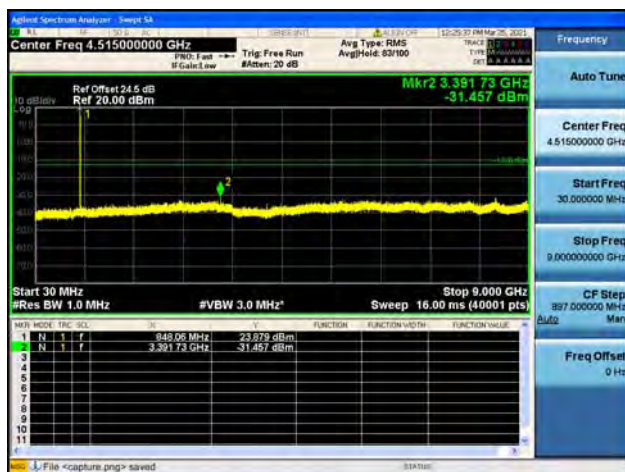

Band5 / 1.4MHz / High CH / 16QAM

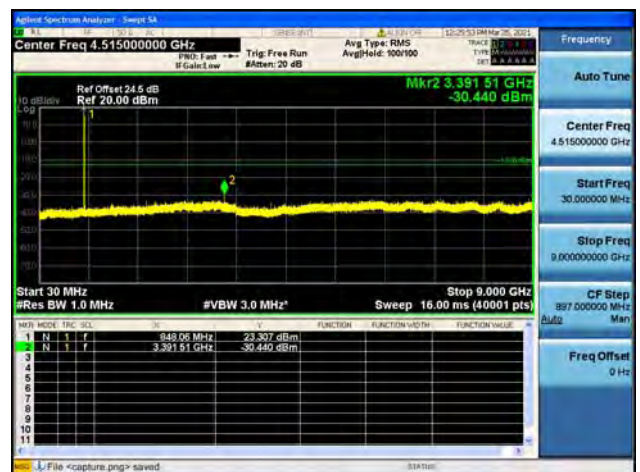



Band5 / 3MHz / Low CH / QPSK

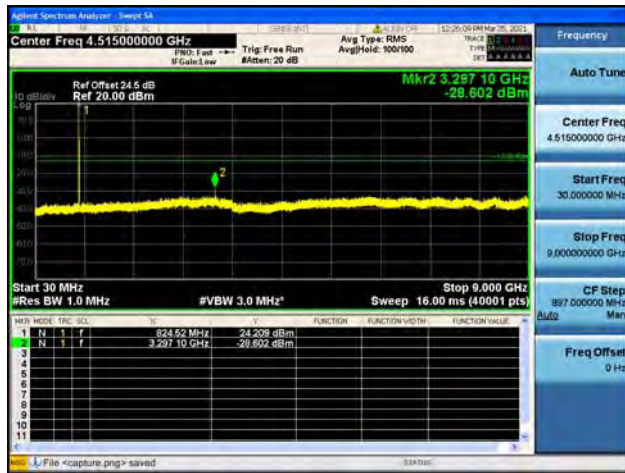

Band5 / 3MHz / Low CH / 16QAM

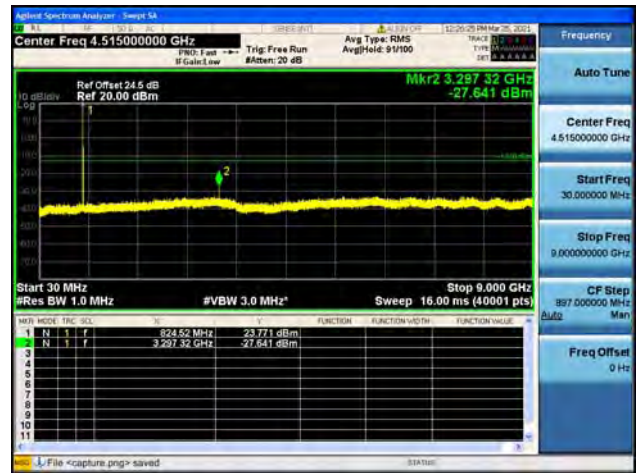

Band5 / 3MHz / Mid CH / QPSK

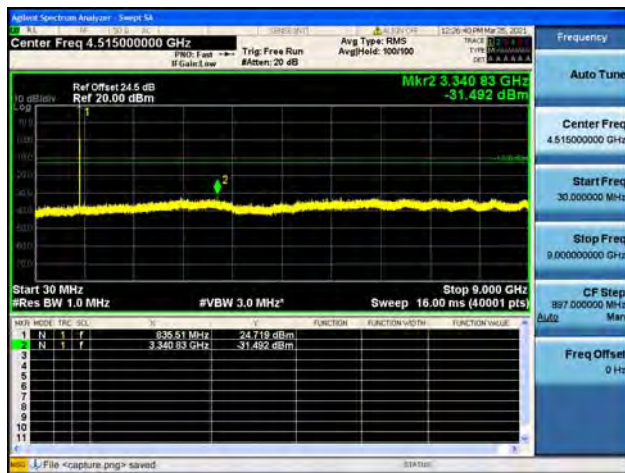

Band5 / 3MHz / Mid CH / 16QAM

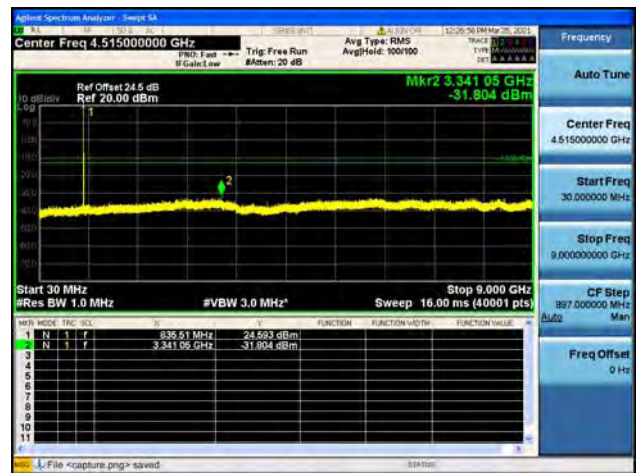

Band5 / 3MHz / High CH / QPSK

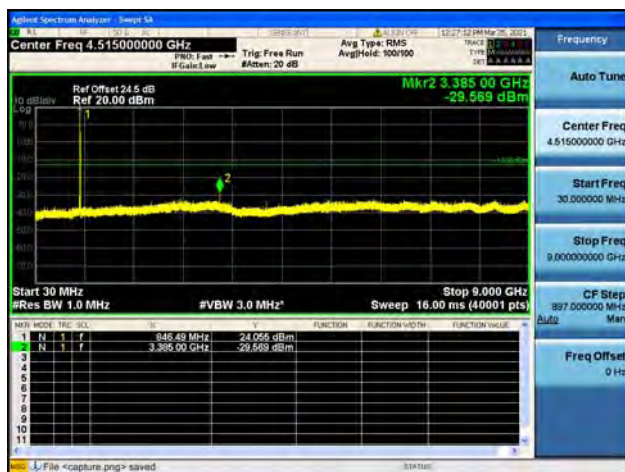

Band5 / 3MHz / High CH / 16QAM

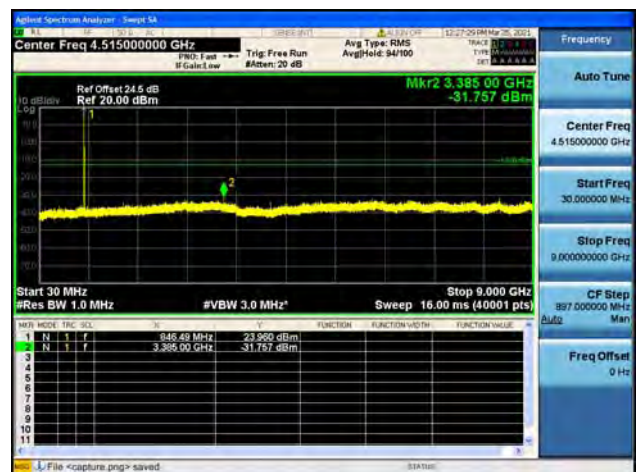



Band5 / 5MHz / Low CH / QPSK

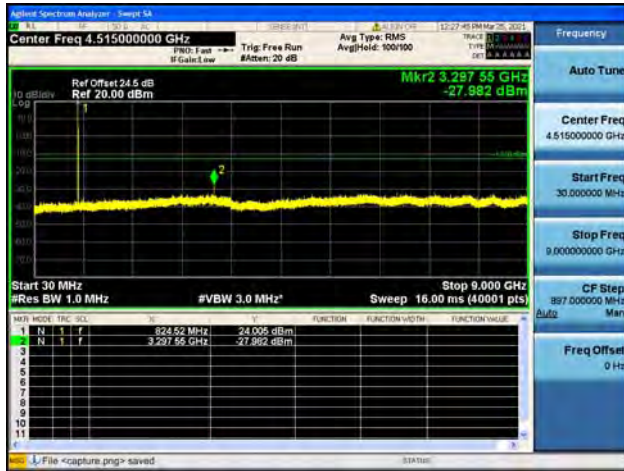

Band5 / 5MHz / Low CH / 16QAM

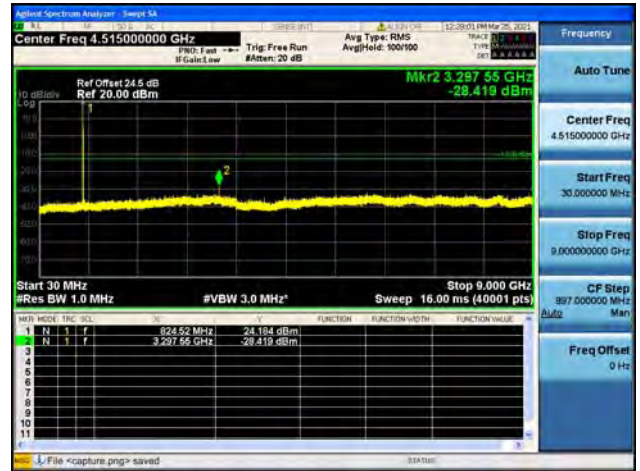

Band5 / 5MHz / Mid CH / QPSK



Band5 / 5MHz / Mid CH / 16QAM

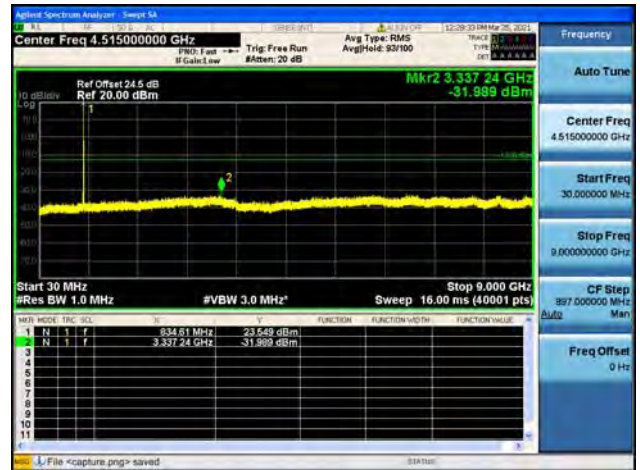

Band5 / 5MHz / High CH / QPSK

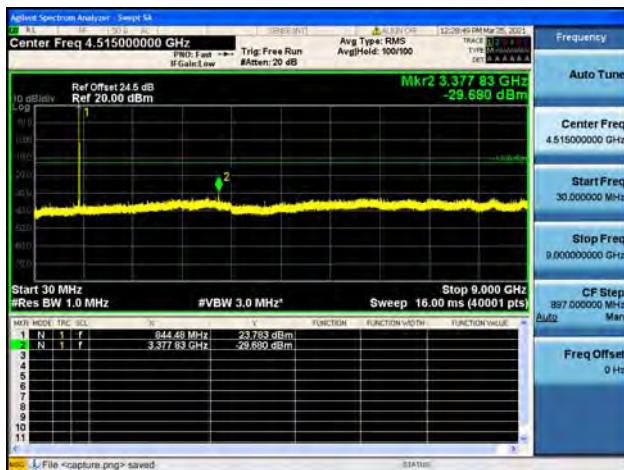

Band5 / 5MHz / High CH / 16QAM

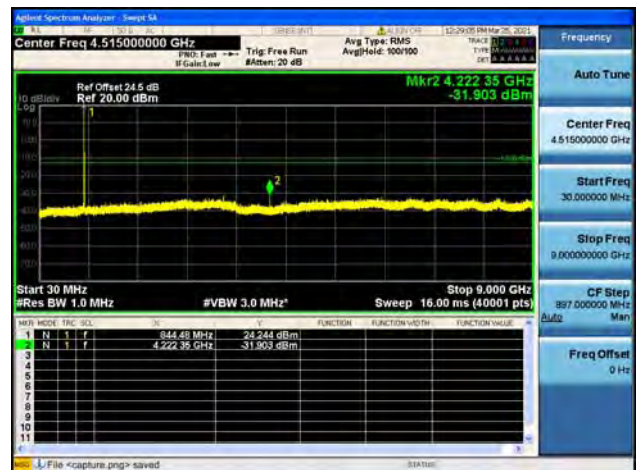



Band5 / 10MHz / Low CH / QPSK

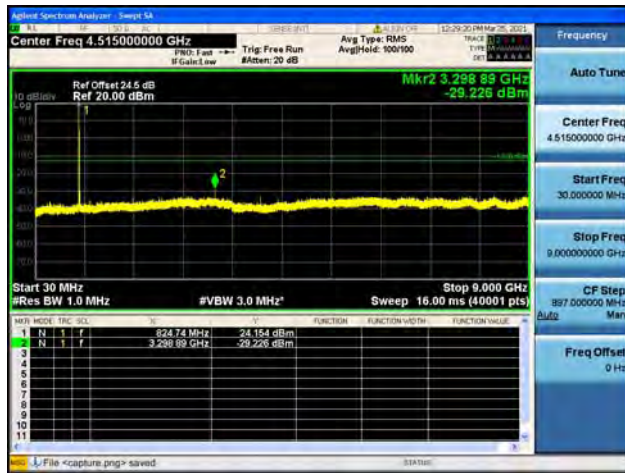

Band5 / 10MHz / Low CH / 16QAM

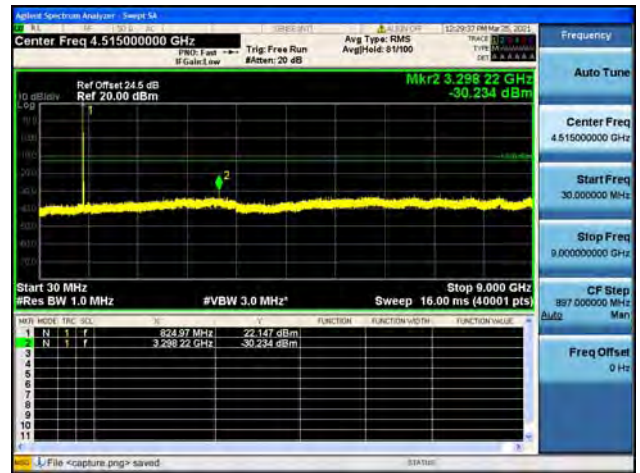

Band5 / 10MHz / Mid CH / QPSK

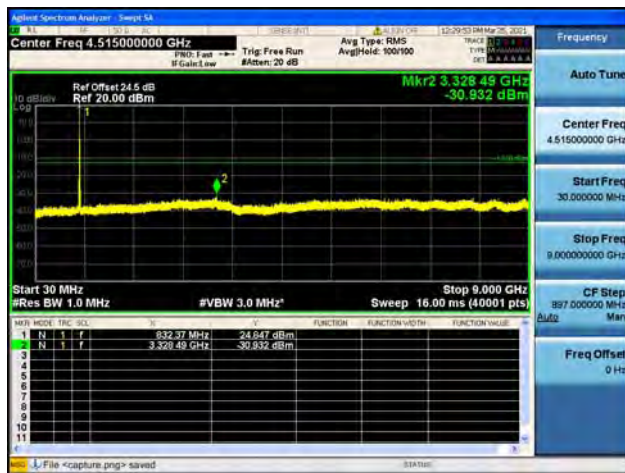

Band5 / 10MHz / Mid CH / 16QAM

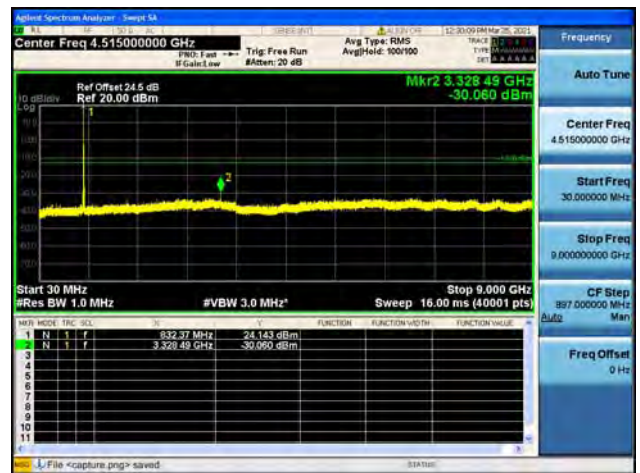

Band5 / 10MHz / High CH / QPSK

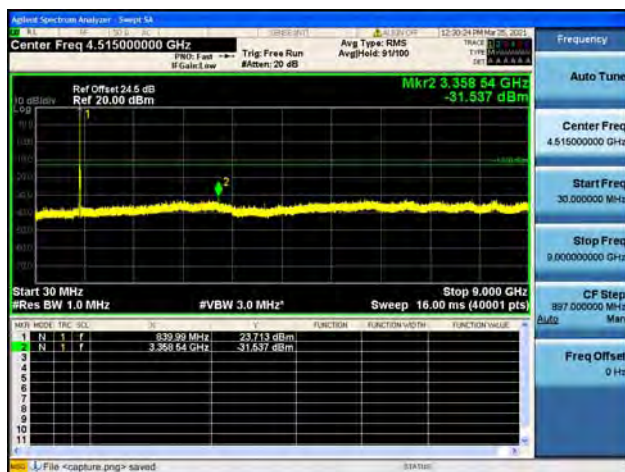

Band5 / 10MHz / High CH / 16QAM

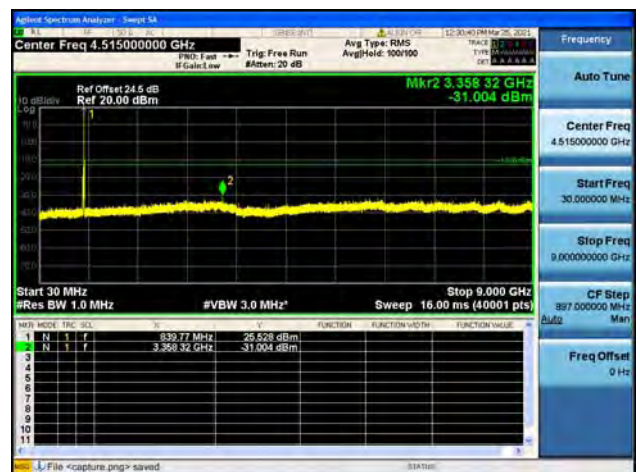



Band12 / 1.4MHz / Low CH / QPSK



Band12 / 1.4MHz / Low CH / 16QAM



Band12 / 1.4MHz / Mid CH / QPSK

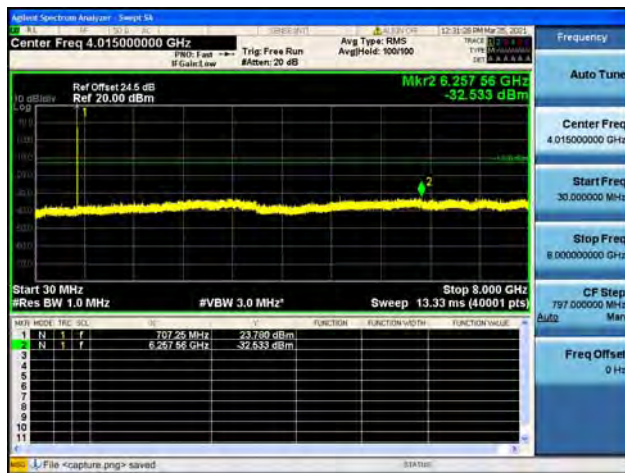

Band12 / 1.4MHz / Mid CH / 16QAM



Band12 / 1.4MHz / High CH / QPSK

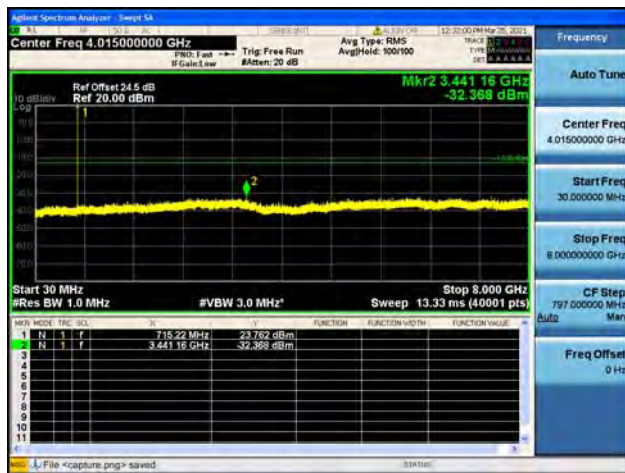

Band12 / 1.4MHz / High CH / 16QAM

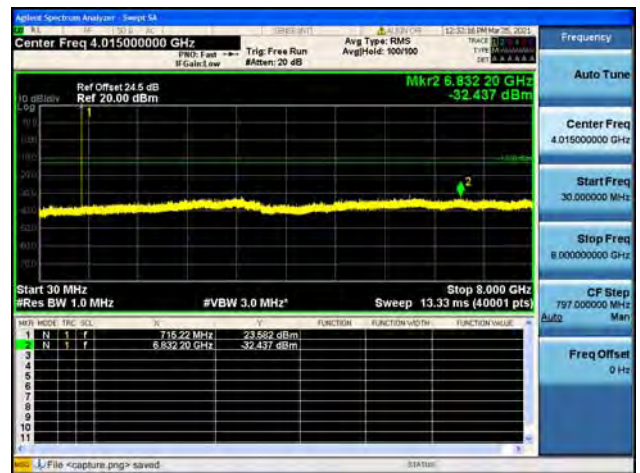



Band12 / 3MHz / Low CH / QPSK



Band12 / 3MHz / Low CH / 16QAM



Band12 / 3MHz / Mid CH / QPSK



Band12 / 3MHz / Mid CH / 16QAM

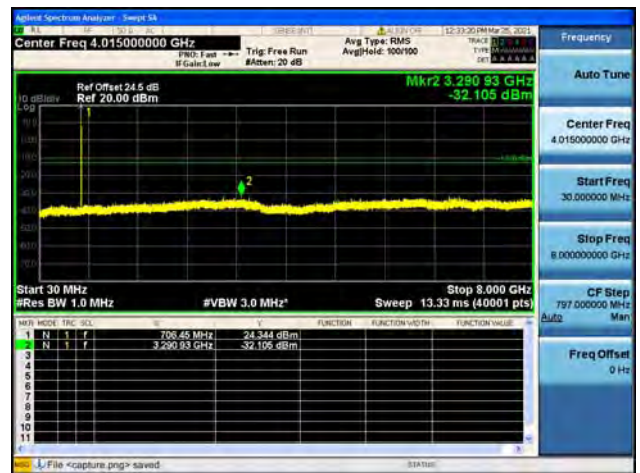

Band12 / 3MHz / High CH / QPSK



Band12 / 3MHz / High CH / 16QAM





Band12 / 5MHz / Low CH / QPSK



Band12 / 5MHz / Low CH / 16QAM



Band12 / 5MHz / Mid CH / QPSK

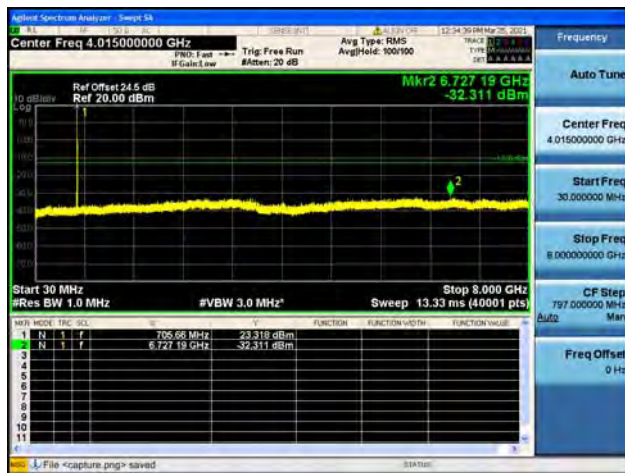

Band12 / 5MHz / Mid CH / 16QAM



Band12 / 5MHz / High CH / QPSK

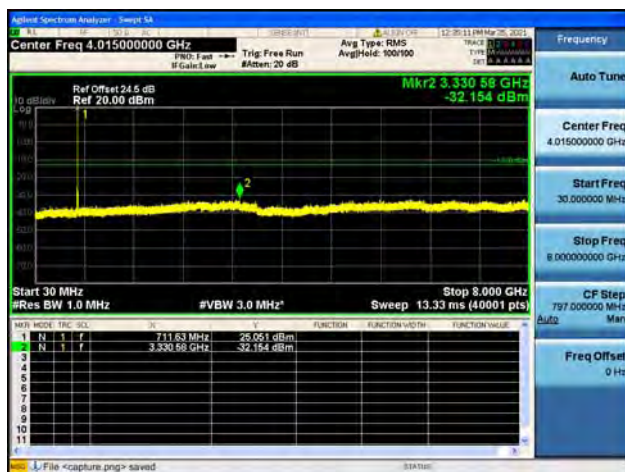

Band12 / 5MHz / High CH / 16QAM

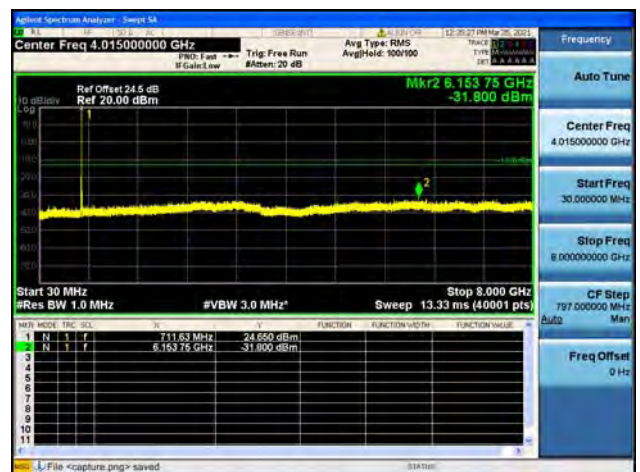



Band12 / 10MHz / Low CH / QPSK



Band12 / 10MHz / Low CH / 16QAM



Band12 / 10MHz / Mid CH / QPSK



Band12 / 10MHz / Mid CH / 16QAM

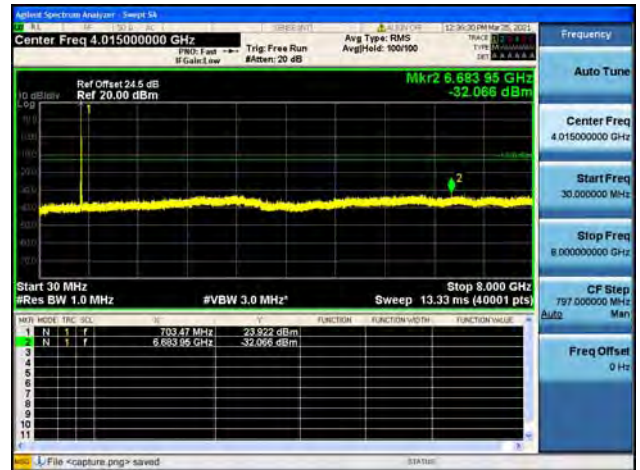

Band12 / 10MHz / High CH / QPSK



Band12 / 10MHz / High CH / 16QAM





Band66 / 1.4MHz / Low CH / QPSK

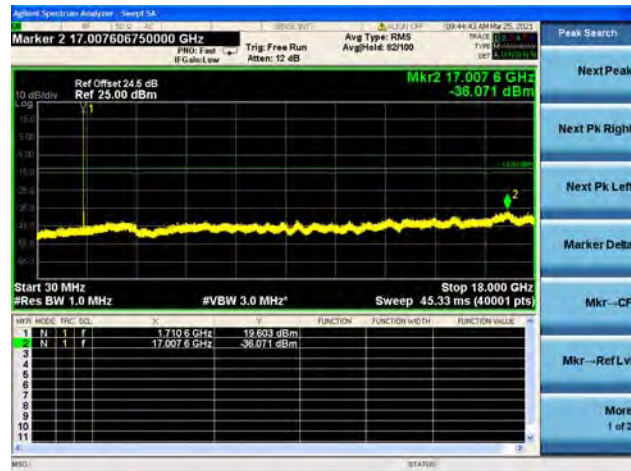

Band66 / 1.4MHz / Low CH / 16QAM



Band66 / 1.4MHz / Mid CH / QPSK

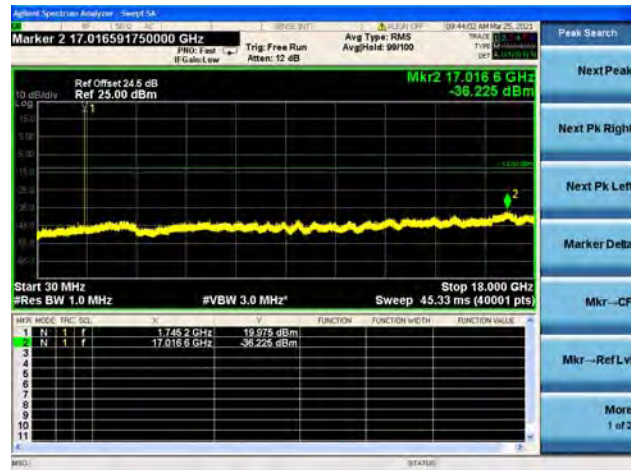

Band66 / 1.4MHz / Mid CH / 16QAM



Band66 / 1.4MHz / High CH / QPSK

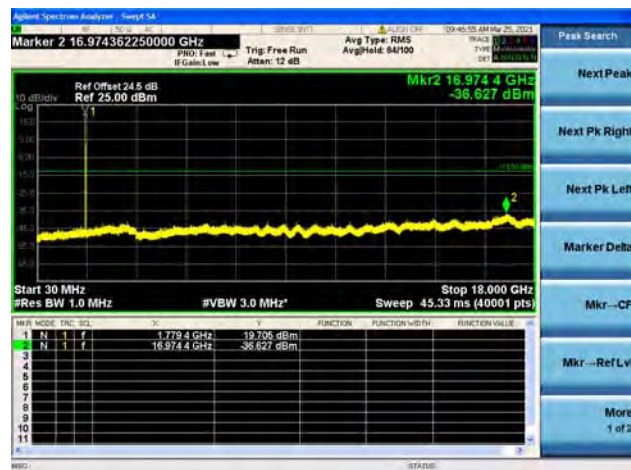

Band66 / 1.4MHz / High CH / 16QAM

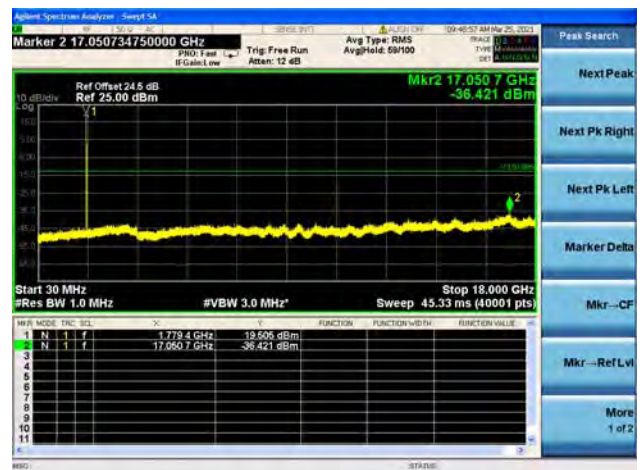

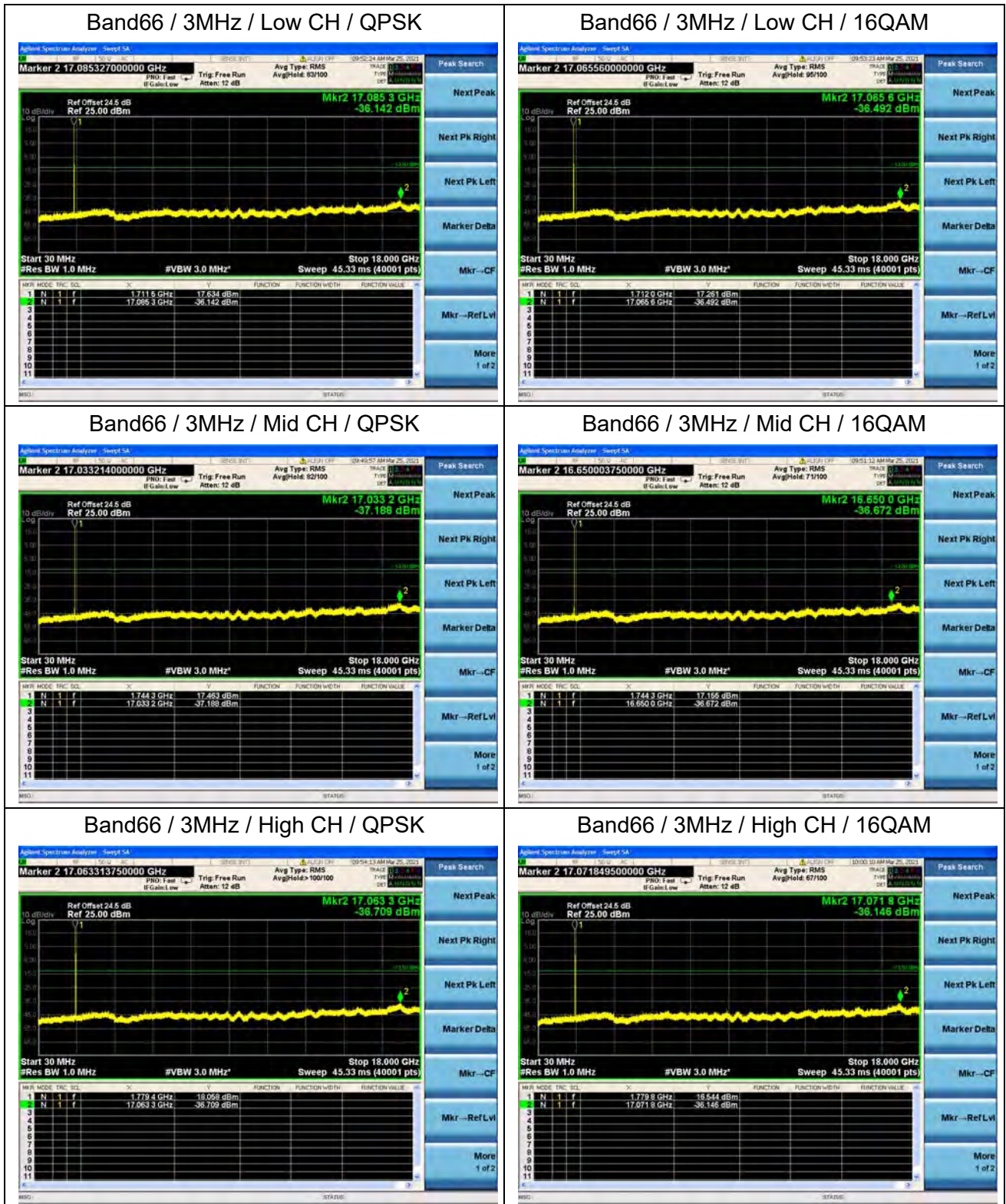



Band66 / 5MHz / Low CH / QPSK

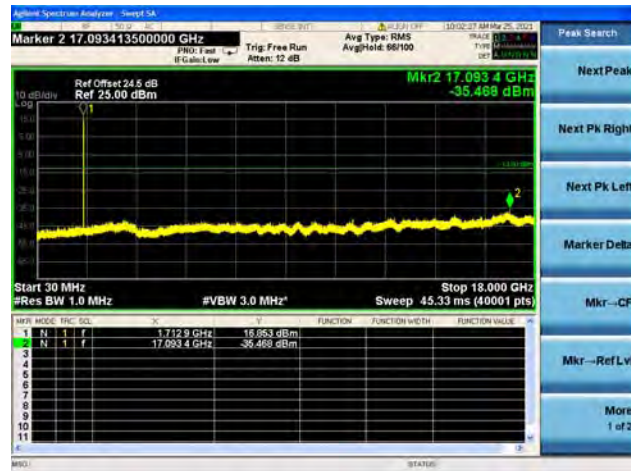

Band66 / 5MHz / Low CH / 16QAM



Band66 / 5MHz / Mid CH / QPSK

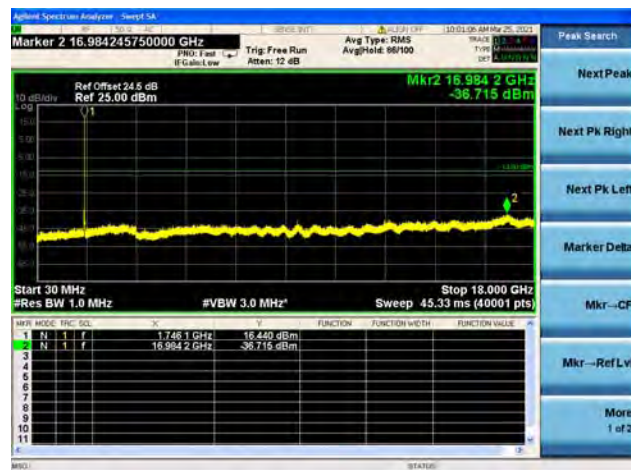

Band66 / 5MHz / Mid CH / 16QAM

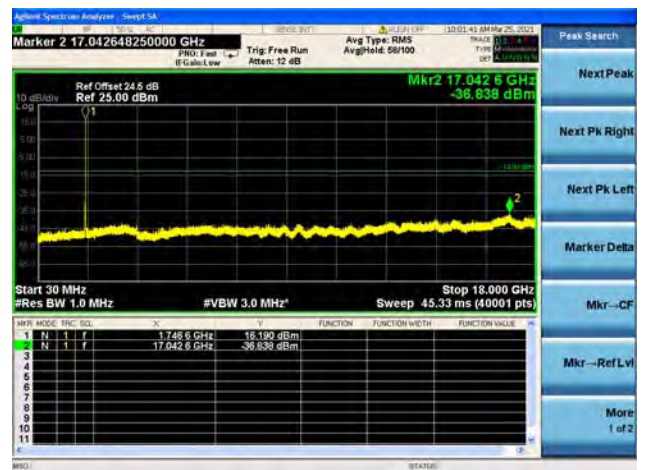

Band66 / 5MHz / High CH / QPSK

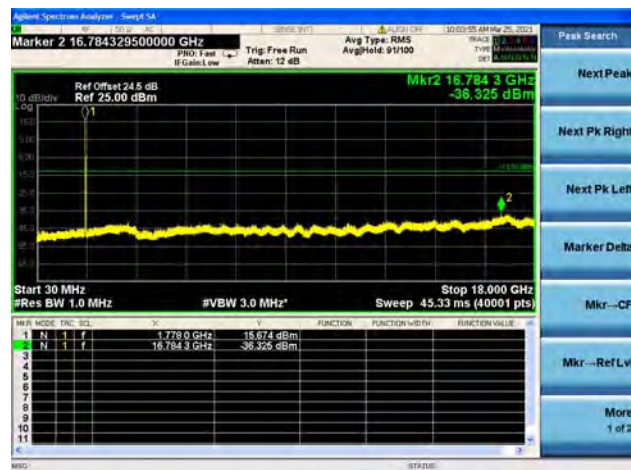

Band66 / 5MHz / High CH / 16QAM

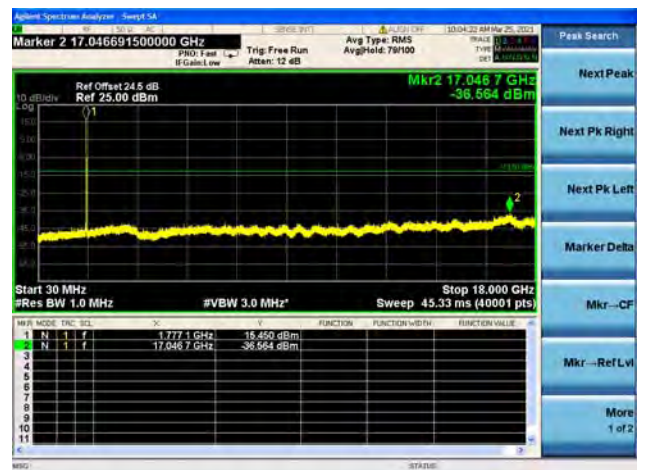



Band66 / 10MHz / Low CH / QPSK

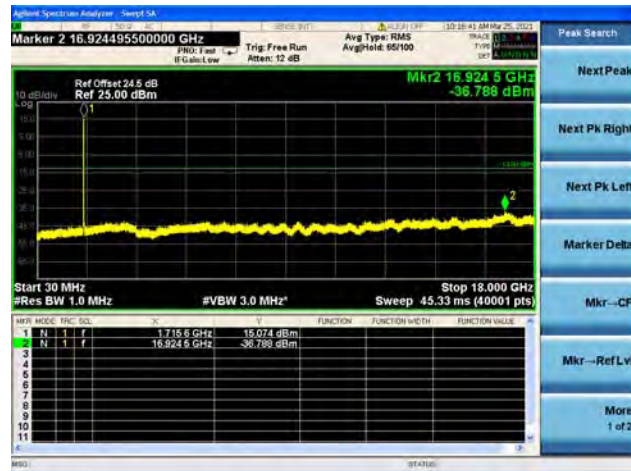

Band66 / 10MHz / Low CH / 16QAM



Band66 / 10MHz / Mid CH / QPSK

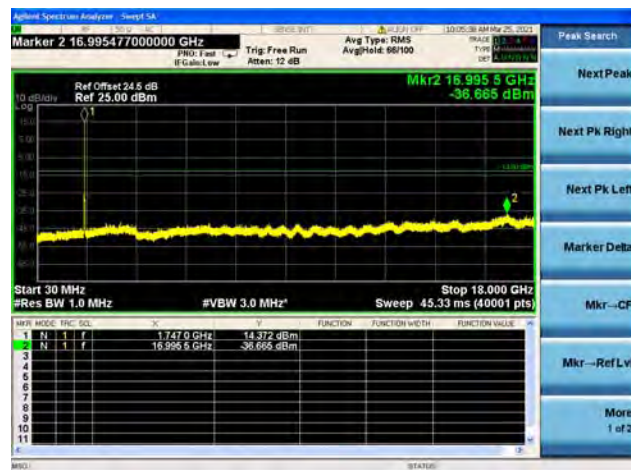

Band66 / 10MHz / Mid CH / 16QAM

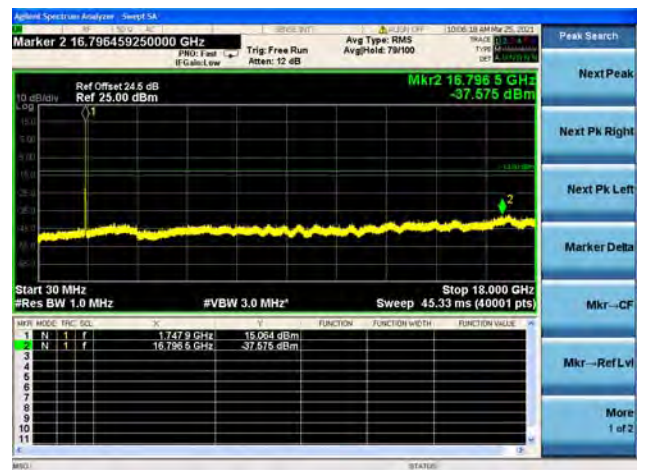

Band66 / 10MHz / High CH / QPSK

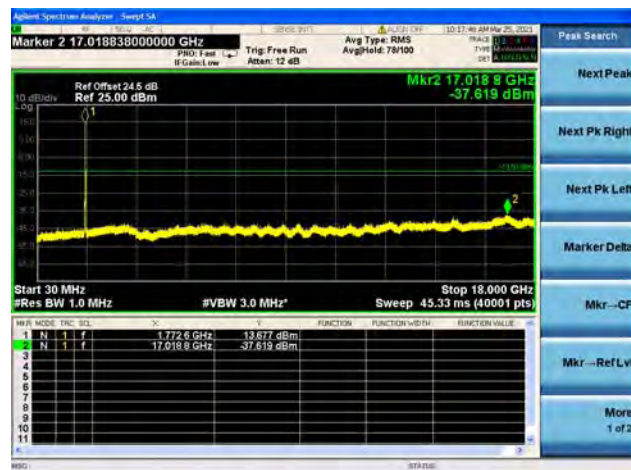

Band66 / 10MHz / High CH / 16QAM

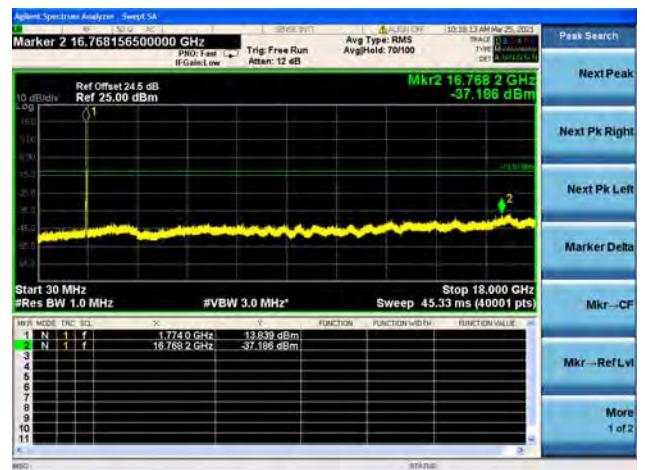



Band66 / 15MHz / Low CH / QPSK

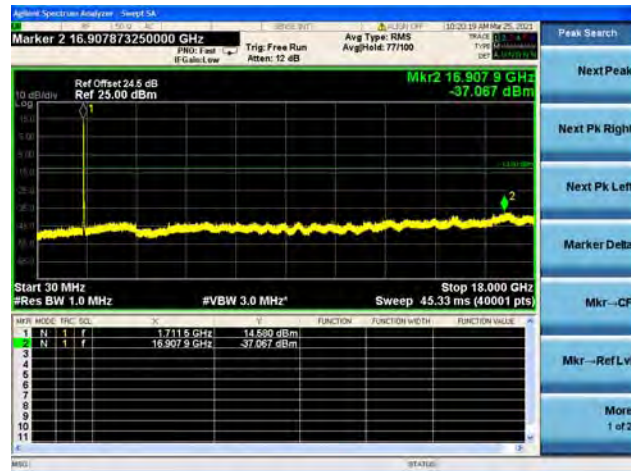

Band66 / 15MHz / Low CH / 16QAM



Band66 / 15MHz / Mid CH / QPSK

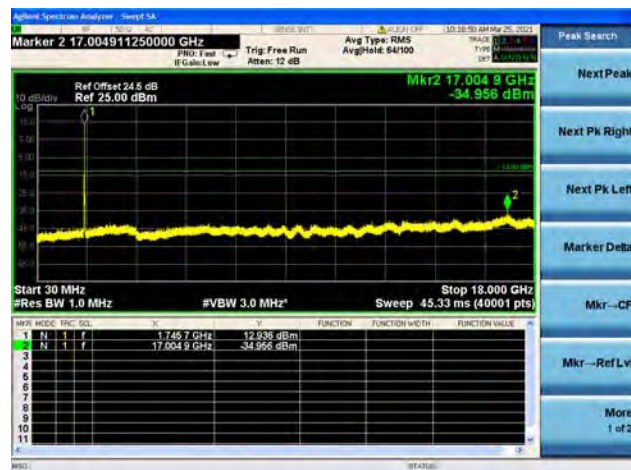

Band66 / 15MHz / Mid CH / 16QAM



Band66 / 15MHz / High CH / QPSK

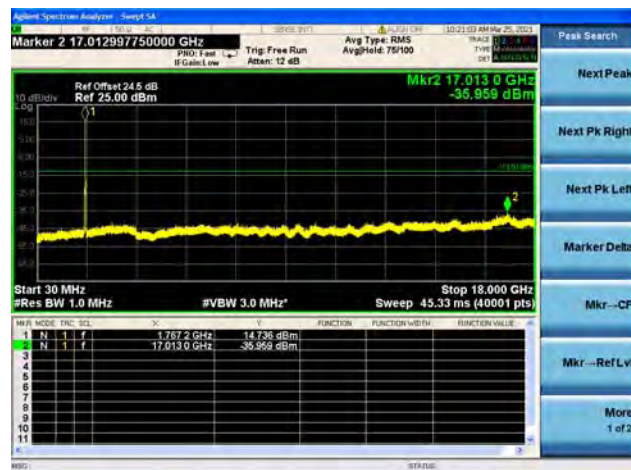

Band66 / 15MHz / High CH / 16QAM

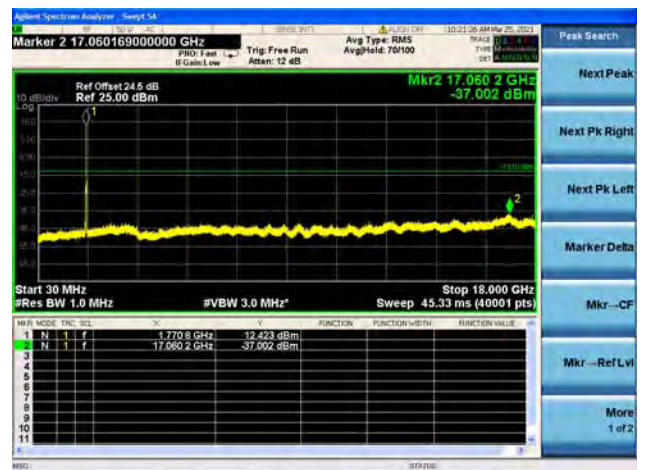

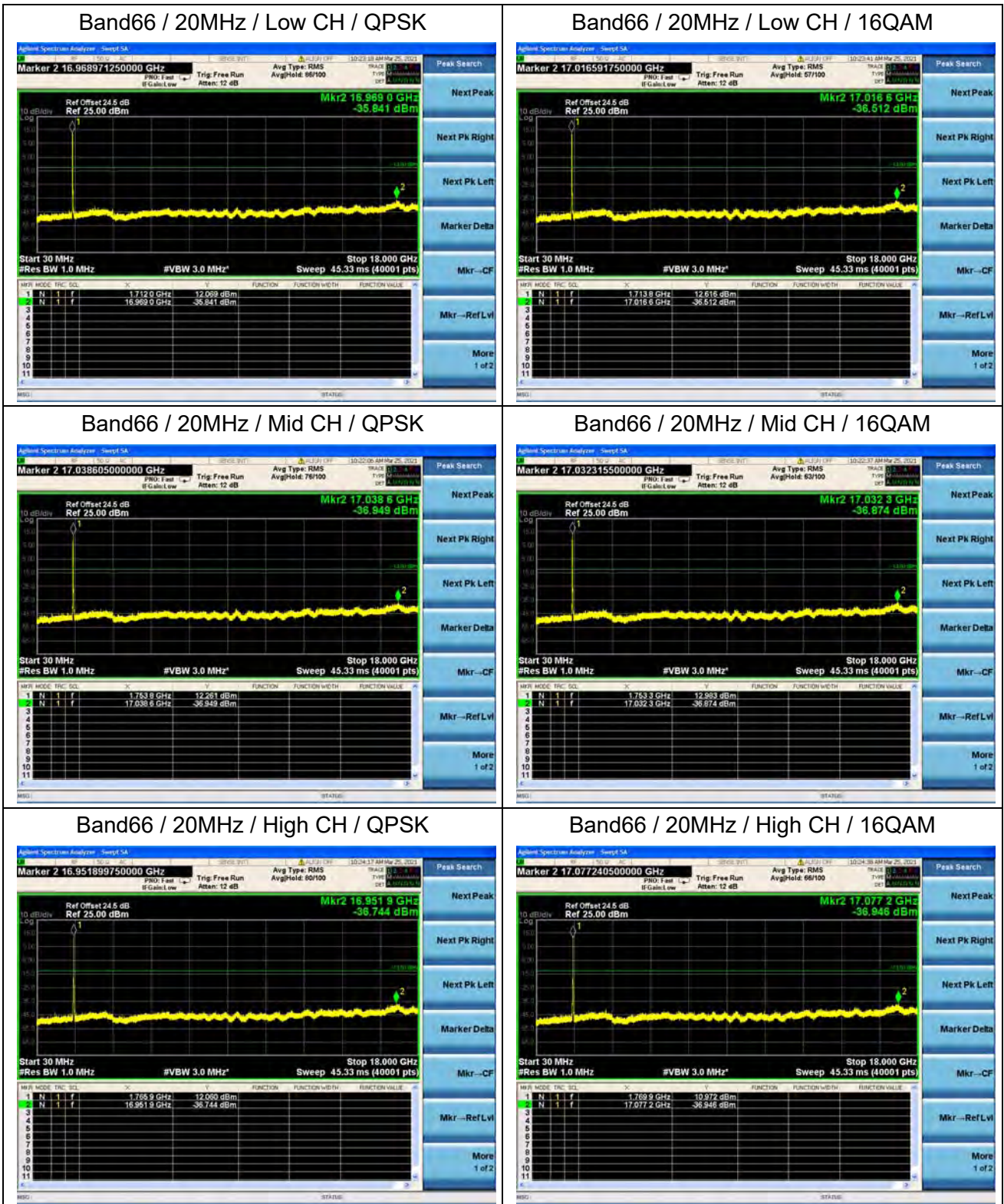



2.6. Band Edge

2.6.1. Requirement

Band 2

According to FCC section 24.238(a), for operations in the 1850–1910MHz bands, the power of any emission outside of the authorized operating frequency ranges must be attenuated below the transmitting power (P) by a factor of at least $43 + 10 \log(P)$ dB in a 1MHz bandwidth. However, in the 1 MHz bands immediately outside and adjacent to the licensee's frequency block, a resolution bandwidth of at least one percent of the emission bandwidth of the fundamental emission of the transmitter may be employed.

Band 4, 66

According to FCC section 27.53(h), for operations in the 1710–1755MHz bands, the power of any emission outside a licensee's frequency block shall be attenuated below the transmitter power (P) by at least $43 + 10 \log_{10}(P)$ dB a 1MHz bandwidth. However, in the 1 MHz bands immediately outside and adjacent to the licensee's frequency block, a resolution bandwidth of at least one percent of the emission bandwidth of the fundamental emission of the transmitter may be employed.

Band 5

According to FCC section 22.917(a), for operations in the 824–849MHz bands, the power of any emission outside of the authorized operating frequency ranges must be attenuated below the transmitting power (P) by a factor of at least $43 + 10 \log(P)$ dB in a 100kHz bandwidth. However, in the 1 MHz bands immediately outside and adjacent to the licensee's frequency block, a resolution bandwidth of at least one percent of the emission bandwidth of the fundamental emission of the transmitter may be employed.

Band 12

For operations in the 600 MHz band and the 698-746 MHz band, the power of any emission outside a licensee's frequency band(s) of operation shall be attenuated below the transmitter power (P) within the licensed band(s) of operation, measured in watts, by at least $43 + 10 \log(P)$ dB. Compliance with this provision is based on the use of measurement instrumentation employing a resolution bandwidth of 100 kilohertz or greater. However, in the 100 kilohertz bands immediately outside and adjacent to a licensee's frequency block, a resolution bandwidth of at least 30 kHz may be employed.

2.6.2. Test Description

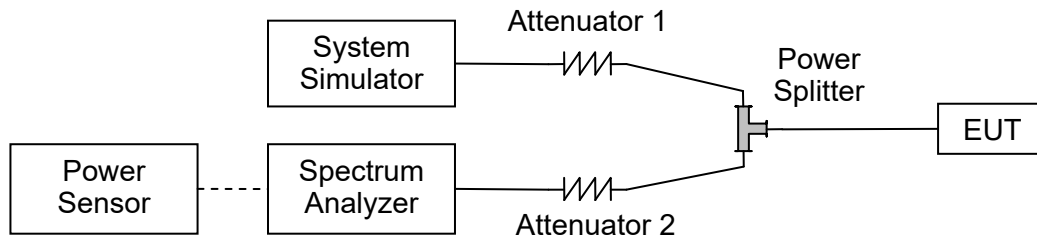

The EUT is coupled to the Spectrum Analyzer (SA) and the System Simulator (SS) with Attenuators through the Power Splitter; the RF load attached to the EUT antenna terminal is 50Ohm; the path loss as the factor is calibrated to correct the reading. The EUT is commanded by the SS to operate at the maximum output power. A call is established between the EUT and the SS.

2.6.3. Test Procedure

KDB 971168 D01v03 Section 6.0 and ANSI/TIA-603-E-2016.



2.6.4. Test Result

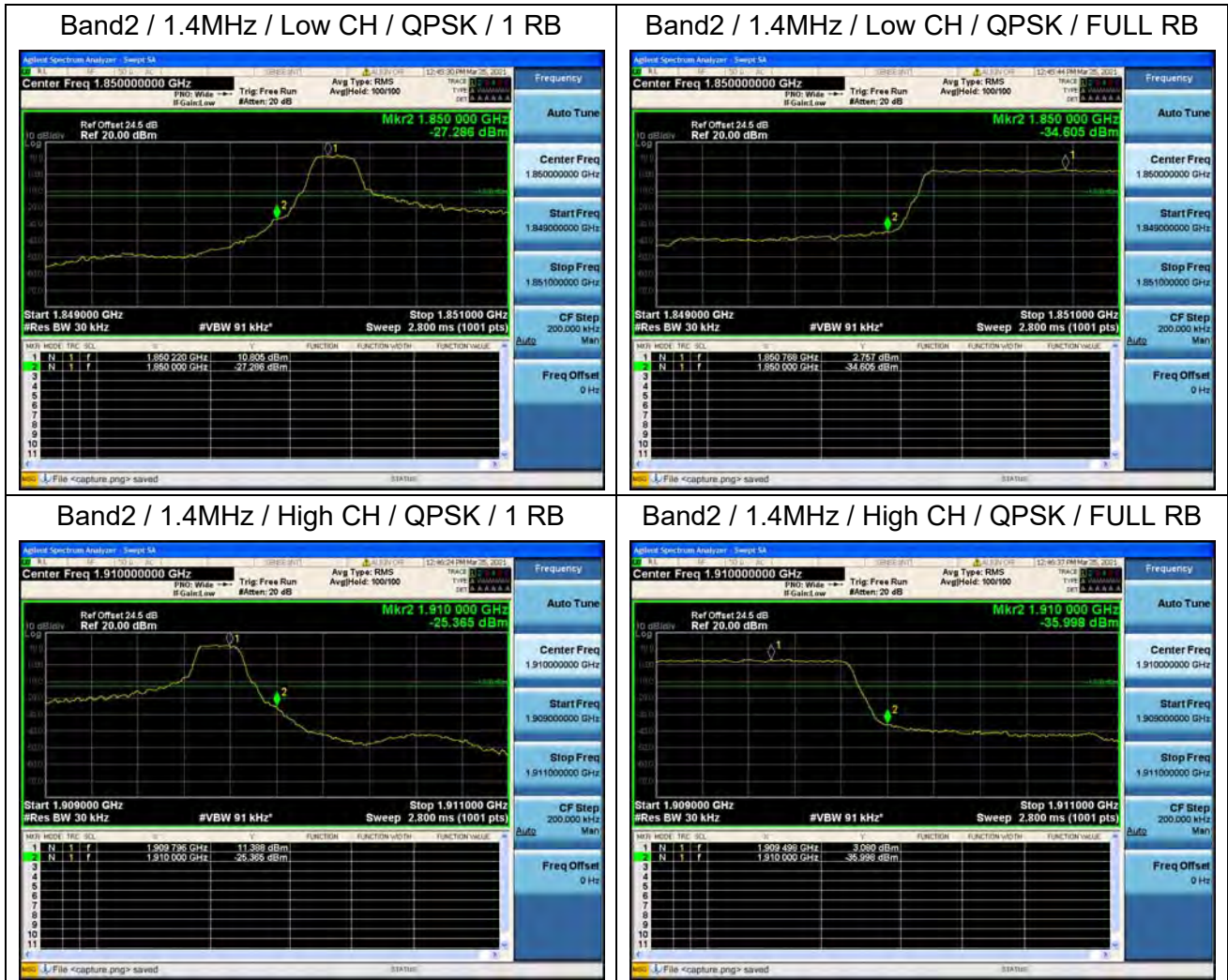



Band2 / 3MHz / Low CH / QPSK / 1 RB



Band2 / 3MHz / Low CH / QPSK / FULL RB



Band2 / 3MHz / High CH / QPSK / 1 RB



Band2 / 3MHz / High CH / QPSK / FULL RB





Band2 / 5MHz / Low CH / QPSK / 1 RB



Band2 / 5MHz / Low CH / QPSK / FULL RB



Band2 / 5MHz / High CH / QPSK / 1 RB



Band2 / 5MHz / High CH / QPSK / FULL RB





Band2 / 10MHz / Low CH / QPSK / 1 RB



Band2 / 10MHz / Low CH / QPSK / FULL RB



Band2 / 10MHz / High CH / QPSK / 1 RB



Band2 / 10MHz / High CH / QPSK / FULL RB





Band2 / 15MHz / Low CH / QPSK / 1 RB



Band2 / 15MHz / Low CH / QPSK / FULL RB



Band2 / 15MHz / High CH / QPSK / 1 RB



Band2 / 15MHz / High CH / QPSK / FULL RB





Band2 / 20MHz / Low CH / QPSK / 1 RB



Band2 / 20MHz / Low CH / QPSK / FULL RB



Band2 / 20MHz / High CH / QPSK / 1 RB



Band2 / 20MHz / High CH / QPSK / FULL RB





Band4 / 1.4MHz / Low CH / QPSK / 1 RB



Band4 / 1.4MHz / Low CH / QPSK / FULL RB



Band4 / 1.4MHz / High CH / QPSK / 1 RB



Band4 / 1.4MHz / High CH / QPSK / FULL RB





Band4 / 3MHz / Low CH / QPSK / 1 RB



Band4 / 3MHz / Low CH / QPSK / FULL RB



Band4 / 3MHz / High CH / QPSK / 1 RB

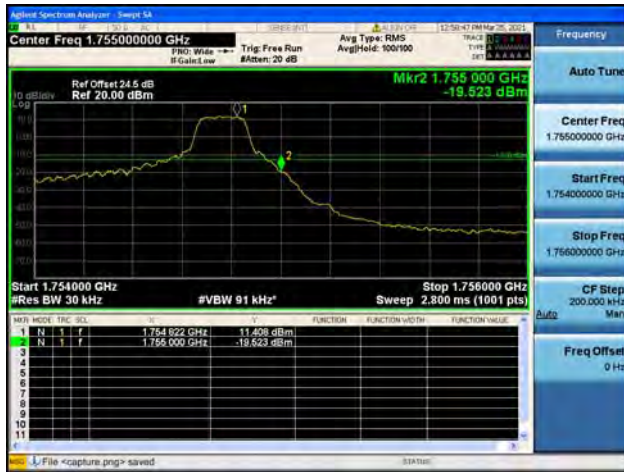

Band4 / 3MHz / High CH / QPSK / FULL RB





Band4 / 5MHz / Low CH / QPSK / 1 RB



Band4 / 5MHz / Low CH / QPSK / FULL RB



Band4 / 5MHz / High CH / QPSK / 1 RB



Band4 / 5MHz / High CH / QPSK / FULL RB





Band4 / 10MHz / Low CH / QPSK / 1 RB



Band4 / 10MHz / Low CH / QPSK / FULL RB



Band4 / 10MHz / High CH / QPSK / 1 RB



Band4 / 10MHz / High CH / QPSK / FULL RB





Band4 / 15MHz / Low CH / QPSK / 1 RB



Band4 / 15MHz / Low CH / QPSK / FULL RB



Band4 / 15MHz / High CH / QPSK / 1 RB



Band4 / 15MHz / High CH / QPSK / FULL RB





Band4 / 20MHz / Low CH / QPSK / 1 RB



Band4 / 20MHz / Low CH / QPSK / FULL RB



Band4 / 20MHz / High CH / QPSK / 1 RB



Band4 / 20MHz / High CH / QPSK / FULL RB





Band5 / 1.4MHz / Low CH / QPSK / 1 RB



Band5 / 1.4MHz / Low CH / QPSK / FULL RB



Band5 / 1.4MHz / High CH / QPSK / 1 RB



Band5 / 1.4MHz / High CH / QPSK / FULL RB





Band5 / 3MHz / Low CH / QPSK / 1 RB



Band5 / 3MHz / Low CH / QPSK / FULL RB



Band5 / 3MHz / High CH / QPSK / 1 RB

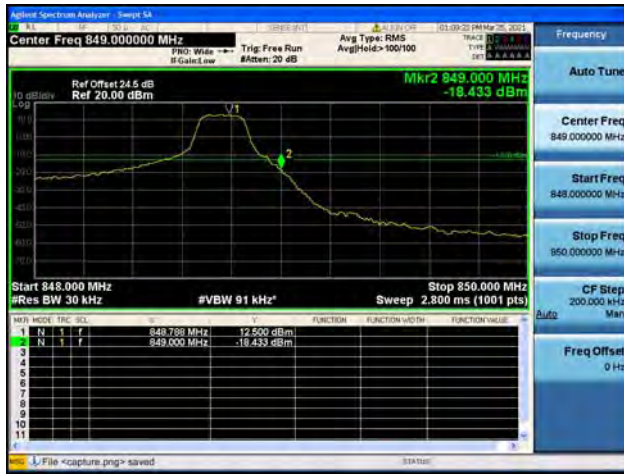

Band5 / 3MHz / High CH / QPSK / FULL RB





Band5 / 5MHz / Low CH / QPSK / 1 RB



Band5 / 5MHz / Low CH / QPSK / FULL RB



Band5 / 5MHz / High CH / QPSK / 1 RB



Band5 / 5MHz / High CH / QPSK / FULL RB





Band5 / 10MHz / Low CH / QPSK / 1 RB



Band5 / 10MHz / Low CH / QPSK / FULL RB



Band5 / 10MHz / High CH / QPSK / 1 RB



Band5 / 10MHz / High CH / QPSK / FULL RB





Band12 / 1.4MHz / Low CH / QPSK / 1 RB



Band12 / 1.4MHz / Low CH / QPSK / FULL RB



Band12 / 1.4MHz / High CH / QPSK / 1 RB



Band12 / 1.4MHz / High CH / QPSK / FULL RB





Band12 / 3MHz / Low CH / QPSK / 1 RB



Band12 / 3MHz / Low CH / QPSK / FULL RB



Band12 / 3MHz / High CH / QPSK / 1 RB



Band12 / 3MHz / High CH / QPSK / FULL RB





Band12 / 5MHz / Low CH / QPSK / 1 RB



Band12 / 5MHz / Low CH / QPSK / FULL RB



Band12 / 5MHz / High CH / QPSK / 1 RB



Band12 / 5MHz / High CH / QPSK / FULL RB





Band12 / 10MHz / Low CH / QPSK / 1 RB



Band12 / 10MHz / Low CH / QPSK / FULL RB



Band12 / 10MHz / High CH / QPSK / 1 RB



Band12 / 10MHz / High CH / QPSK / FULL RB





Band66 / 1.4MHz / Low CH / QPSK / 1 RB



Band66 / 1.4MHz / Low CH / QPSK / FULL RB



Band66 / 1.4MHz / High CH / QPSK / 1 RB

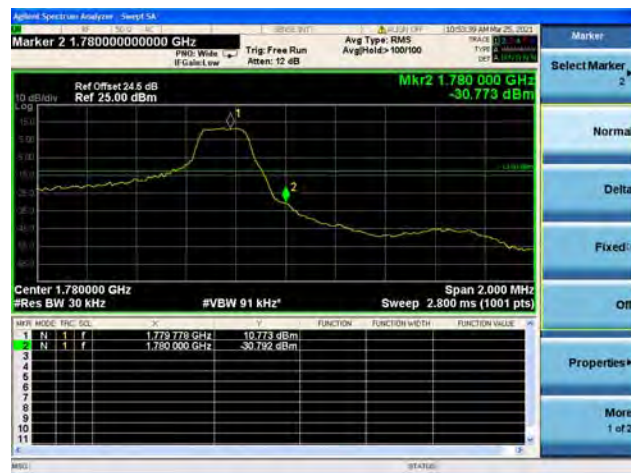

Band66 / 1.4MHz / High CH / QPSK / FULL RB









Band66 / 10MHz / Low CH / QPSK / 1 RB



Band66 / 10MHz / Low CH / QPSK / FULL RB



Band66 / 10MHz / High CH / QPSK / 1 RB



Band66 / 10MHz / High CH / QPSK / FULL RB





Band66 / 15MHz / Low CH / QPSK / 1 RB



Band66 / 15MHz / Low CH / QPSK / FULL RB



Band66 / 15MHz / High CH / QPSK / 1 RB



Band66 / 15MHz / High CH / QPSK / FULL RB





Band66 / 20MHz / Low CH / QPSK / 1 RB



Band66 / 20MHz / Low CH / QPSK / FULL RB



Band66 / 20MHz / High CH / QPSK / 1 RB



Band66 / 20MHz / High CH / QPSK / FULL RB



2.7. Radiated Spurious Emissions

2.7.1. Requirement

According to FCC section 2.1051, the power of any emission outside of the authorized operating frequency ranges must be attenuated below the transmitting power (P) by a factor of at least $43+10*\log(P)$ dB. This calculated to be -13dBm.

2.7.2. Test Description

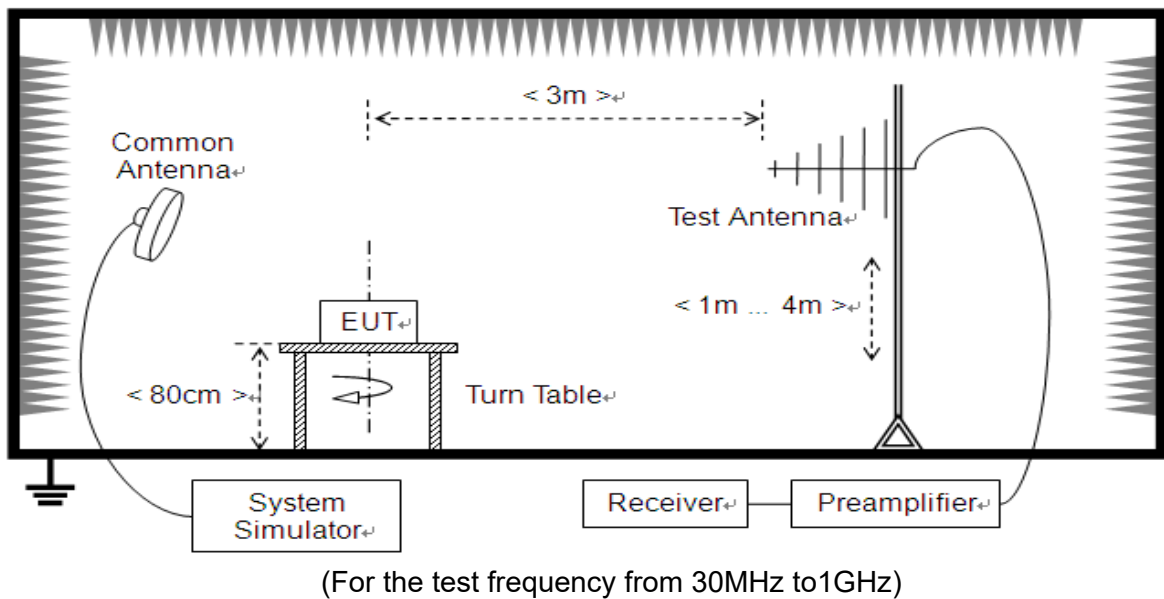

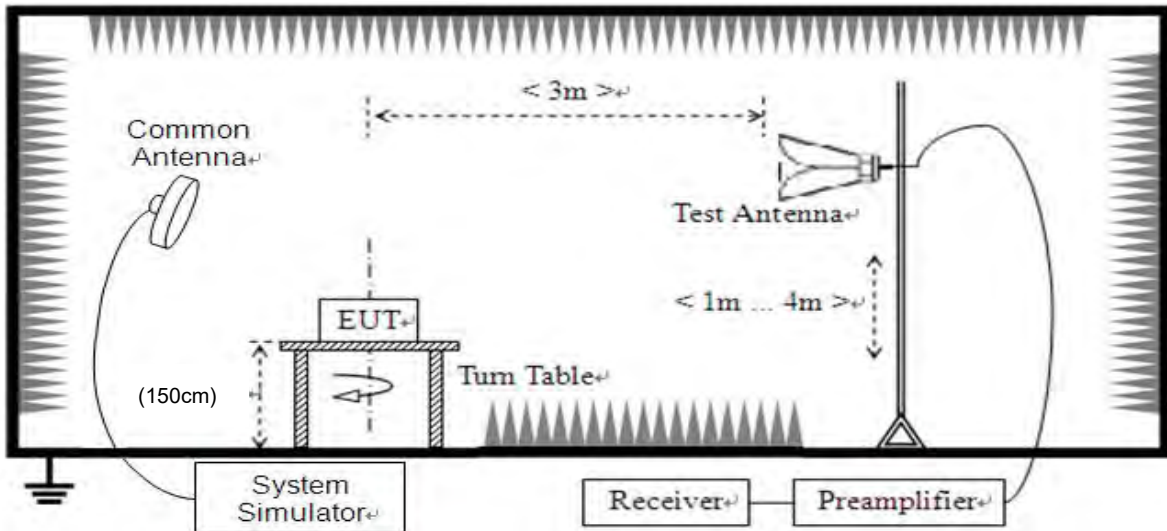

(For the test frequency above 1GHz)

The EUT is located in a 3m Full-Anechoic Chamber, the cable loss, air loss and so on of the site as factors are pre-calibrated using the "Substitution" method, and calculated to correct the reading. A call is established between the EUT and the SS via a Common Antenna. The EUT is commanded by the SS to operate at the maximum and minimum output power, and only the test result of the maximum output power was recorded.

In the frequency range above 30MHz, Bi-Log Test Antenna (30MHz to 1GHz) and Horn Test Antenna (above 1GHz) are used. Test Antenna is 3m away from the EUT. Test Antenna height is varied from 1m to 4m above the ground and the Turn Table is actuated to turn from 0° to 360° to determine the maximum value of the radiated power. The emission levels at both horizontal and vertical polarizations should be tested. The Filters consists of Notch Filters and High Pass Filter.

Note: When doing measurements above 1GHz, the EUT has been within the 3dB cone width of the horn antenna during horizontal antenna.

2.7.3. Test Procedure

KDB 971168 D01v03 Section 5.8 and ANSI/TIA-603-E-2016.

For measurements below 1 GHz the resolution bandwidth is set to 100 kHz for peak detection measurements.

For measurements above 1GHz (exclude 1559-1610 MHz) the resolution bandwidth is set to 1MHz, the video band width is set to 3MHz for peak measurements.



2.7.4. Test Result

The measurement frequency range is from 30MHz to the 10th harmonic of the fundamental frequency. The Turn Table is actuated to turn from 0° to 360°, and both horizontal and vertical polarizations of the Test Antenna are used to find the maximum radiated power. The lowest, middle and highest channels are tested to verify the out of band emissions.

The substitution corrections are obtained as described below:

$$A_{\text{SUBST}} = P_{\text{SUBST_TX}} - P_{\text{SUBST_RX}} - L_{\text{SUBST_CABLES}} + G_{\text{SUBST_TX_ANT}}$$

$$A_{\text{TOT}} = L_{\text{CABLES}} + A_{\text{SUBST}}$$

Where A_{SUBST} is the final substitution correction including receive antenna gain.

$P_{\text{SUBST_TX}}$ is signal generator level,

$P_{\text{SUBST_RX}}$ is receiver level,

$L_{\text{SUBST_CABLES}}$ is cable losses including TX cable,

$G_{\text{SUBST_TX_ANT}}$ is substitution antenna gain.

A_{TOT} is total correction factor including cable loss and substitution correction

During the test, the data of A_{TOT} was added in the test spectrum analyze, so spectrum analyze reading is the final values which contain the data of A_{TOT} .

Note1: The power of the EUT transmitting frequency should be ignored.

Note2: All Spurious Emission tests were performed in X, Y, Z axis direction. And only the worst axis test condition was recorded in this test report.

Note3: All bandwidth and modulation were considered and evaluated respectively by performing full test for each band, only the worst cases (Max Bandwidth and QPSK mode) were recorded in this test report.

Note 4: N/A means the frequency is the basic frequency or the base station frequency, they are no need to verdict.

LTE Band 2, 20MHz BW, Low Channel, QPSK

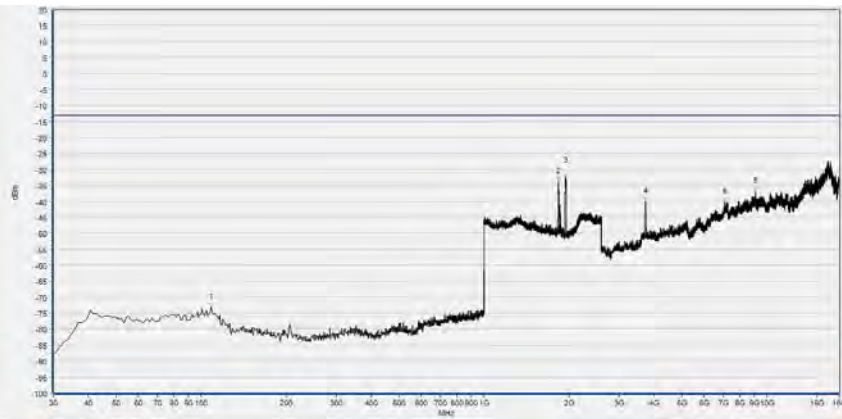

No.	Fre.(MHz)	PK (dBm)	Limit (dBm)	Antenna	Verdict
1	108.570	-73.19	-13.00	Horizontal	PASS
2	1832.973	-33.89	-13.00	Horizontal	N/A
3	1943.097	-32.67	-13.00	Horizontal	N/A
4	3728.605	-40.06	-13.00	Horizontal	PASS
5	7094.817	-40.23	-13.00	Horizontal	PASS
6	9099.982	-36.98	-13.00	Horizontal	PASS

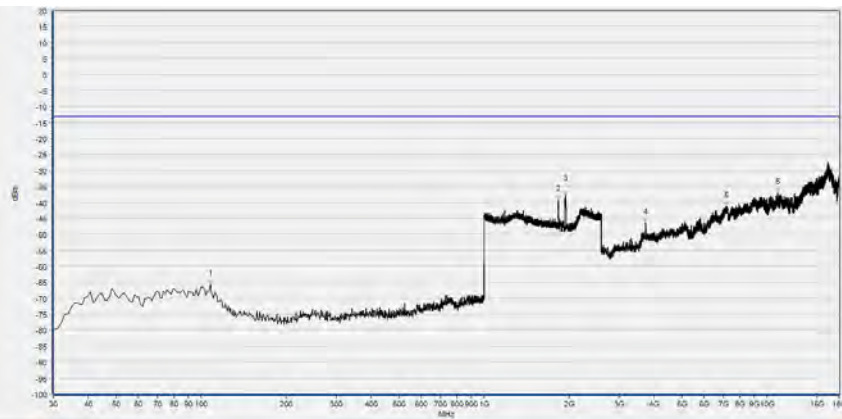

No.	Fre.(MHz)	PK (dBm)	Limit (dBm)	Antenna	Verdict
1	107.600	-65.55	-13.00	Vertical	PASS
2	1832.973	-39.21	-13.00	Vertical	N/A
3	1938.615	-37.98	-13.00	Vertical	N/A
4	3731.406	-46.40	-13.00	Vertical	PASS
5	7170.431	-41.20	-13.00	Vertical	PASS
6	10906.310	-37.09	-13.00	Vertical	PASS

LTE Band 2, 20MHz BW, Mid Channel, QPSK

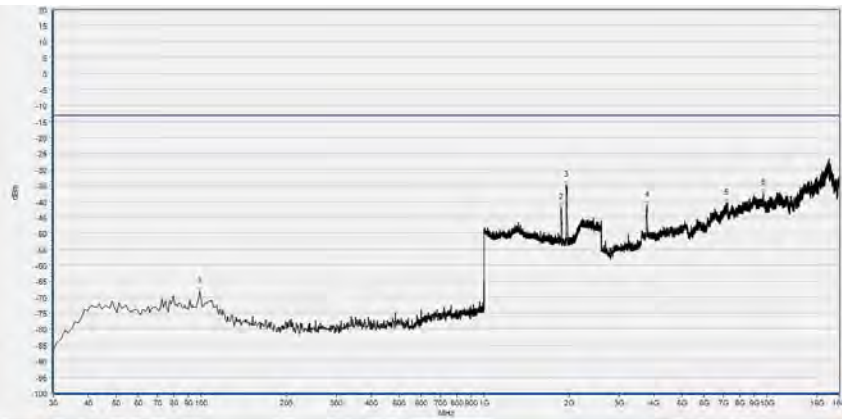

No.	Fre.(MHz)	PK (dBm)	Limit (dBm)	Antenna	Verdict
1	98.870	-68.35	-13.00	Horizontal	PASS
2	1873.309	-41.83	-13.00	Horizontal	N/A
3	1952.061	-34.90	-13.00	Horizontal	N/A
4	3773.413	-41.21	-13.00	Horizontal	PASS
5	7190.035	-40.57	-13.00	Horizontal	PASS
6	9707.692	-37.46	-13.00	Horizontal	PASS

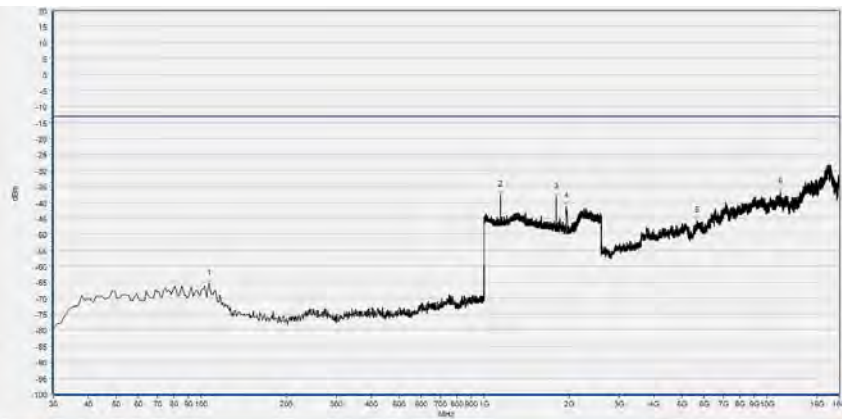

No.	Fre.(MHz)	PK (dBm)	Limit (dBm)	Antenna	Verdict
1	106.630	-65.36	-13.00	Vertical	PASS
2	1143.417	-37.76	-13.00	Vertical	PASS
3	1801.601	-38.35	-13.00	Vertical	N/A
4	1952.701	-41.16	-13.00	Vertical	N/A
5	5663.757	-45.67	-13.00	Vertical	PASS
6	11149.955	-36.75	-13.00	Vertical	PASS

LTE Band 2, 20MHz BW, High Channel, QPSK

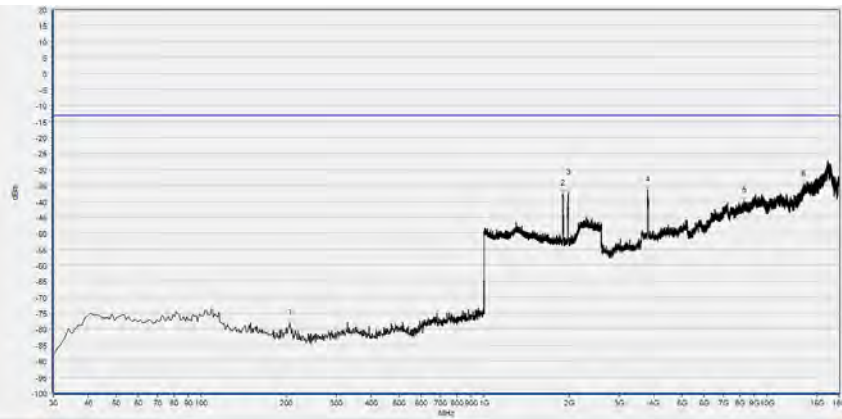

No.	Fre.(MHz)	PK (dBm)	Limit (dBm)	Antenna	Verdict
1	205.570	-78.15	-13.00	Horizontal	PASS
2	1899.560	-37.61	-13.00	Horizontal	N/A
3	1987.915	-37.51	-13.00	Horizontal	N/A
4	3795.817	-36.64	-13.00	Horizontal	PASS
5	8304.637	-39.95	-13.00	Horizontal	PASS
6	13426.769	-34.64	-13.00	Horizontal	PASS

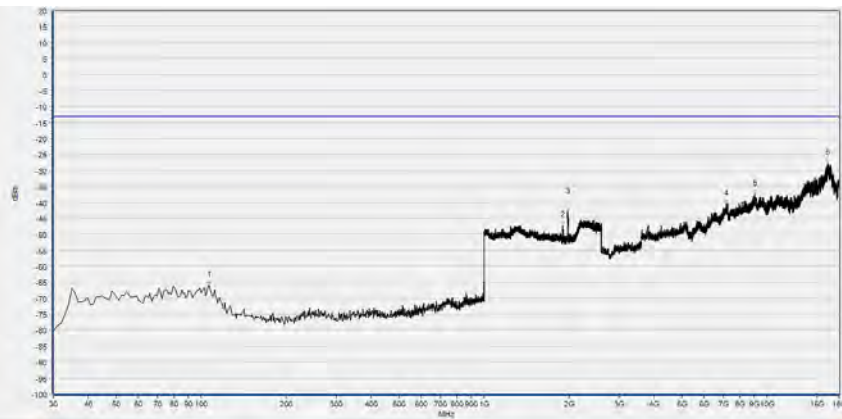

No.	Fre.(MHz)	PK (dBm)	Limit (dBm)	Antenna	Verdict
1	106.630	-66.14	-13.00	Vertical	PASS
2	1900.200	-47.31	-13.00	Vertical	N/A
3	1973.830	-42.74	-13.00	Vertical	N/A
4	7181.633	-40.60	-13.00	Vertical	PASS
5	9038.371	-37.39	-13.00	Vertical	PASS
6	16400.909	-27.86	-13.00	Vertical	PASS

LTE Band 4, 20MHz BW, Low Channel, QPSK

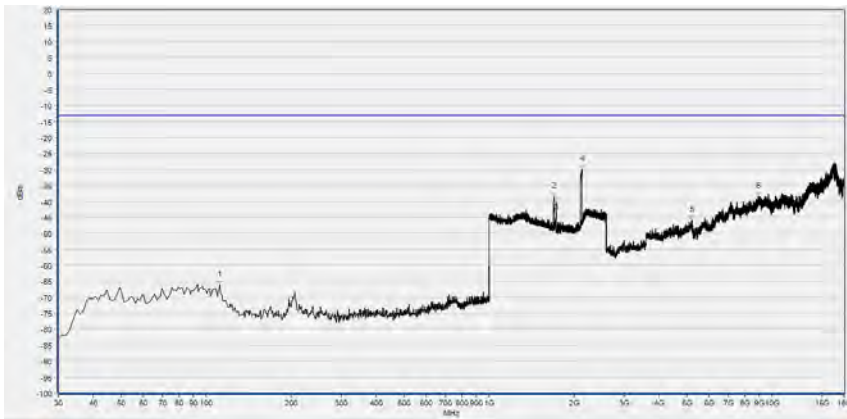

No.	Fre.(MHz)	PK (dBm)	Limit (dBm)	Antenna	Verdict
1	111.480	-66.24	-13.00	Horizontal	PASS
2	1693.397	-38.58	-13.00	Horizontal	PASS
3	1726.691	-40.01	-13.00	Horizontal	N/A
4	2126.210	-30.16	-13.00	Horizontal	N/A
5	5215.676	-45.99	-13.00	Horizontal	PASS
6	8951.555	-38.52	-13.00	Horizontal	PASS

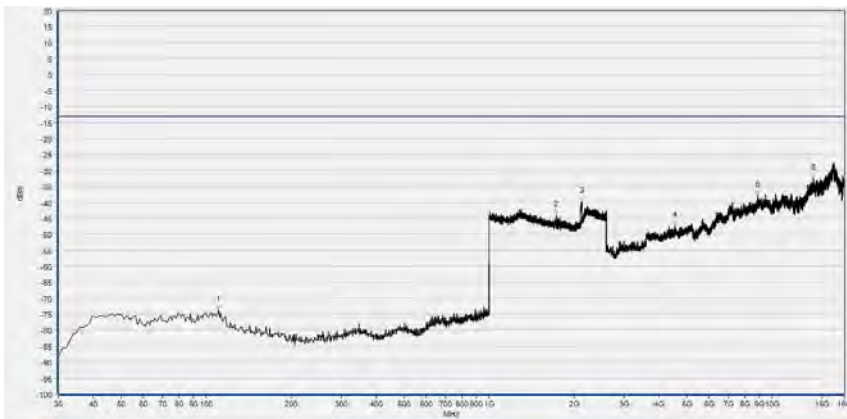

No.	Fre.(MHz)	PK (dBm)	Limit (dBm)	Antenna	Verdict
1	110.510	-73.68	-13.00	Vertical	PASS
2	1727.971	-44.02	-13.00	Vertical	N/A
3	2126.210	-39.77	-13.00	Vertical	N/A
4	4532.351	-47.20	-13.00	Vertical	PASS
5	8909.547	-37.85	-13.00	Vertical	PASS
6	14000.873	-32.60	-13.00	Vertical	PASS

LTE Band 4, 20MHz BW, Mid Channel, QPSK

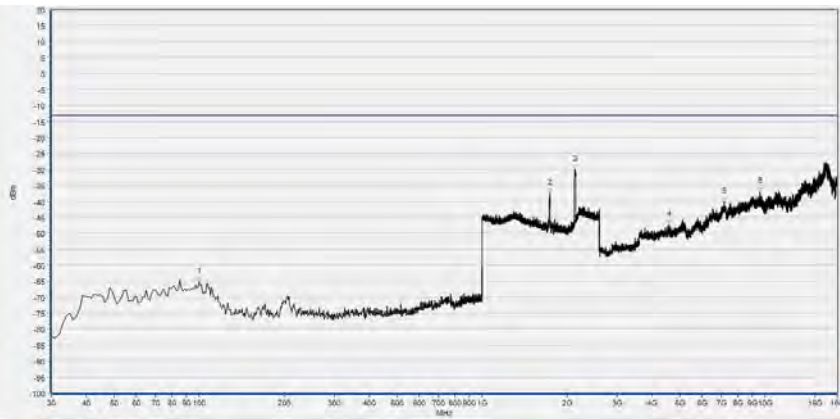

No.	Fre.(MHz)	PK (dBm)	Limit (dBm)	Antenna	Verdict
1	99.840	-65.24	-13.00	Horizontal	PASS
2	1735.014	-37.33	-13.00	Horizontal	N/A
3	2131.333	-30.06	-13.00	Horizontal	N/A
4	4582.761	-47.16	-13.00	Horizontal	PASS
5	7164.830	-40.20	-13.00	Horizontal	PASS
6	9595.672	-36.91	-13.00	Horizontal	PASS

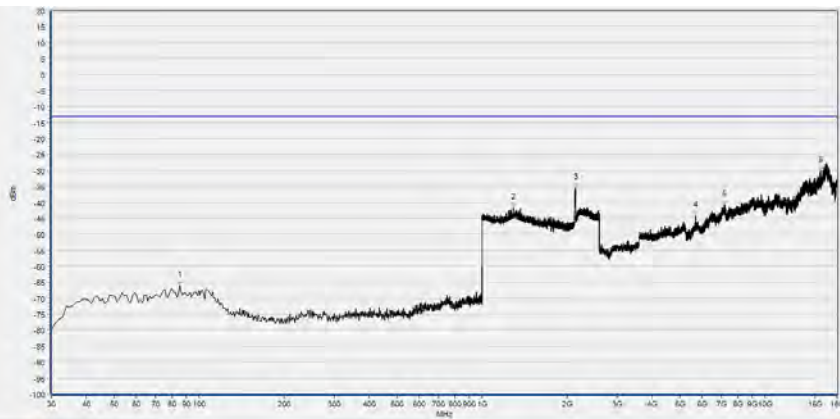

No.	Fre.(MHz)	PK (dBm)	Limit (dBm)	Antenna	Verdict
1	85.290	-65.98	-13.00	Vertical	PASS
2	1293.237	-41.68	-13.00	Vertical	N/A
3	2136.455	-35.36	-13.00	Vertical	N/A
4	5680.560	-44.05	-13.00	Vertical	PASS
5	7167.630	-40.68	-13.00	Vertical	PASS
6	15765.194	-30.05	-13.00	Vertical	PASS

LTE Band 4, 20MHz BW, High Channel, QPSK

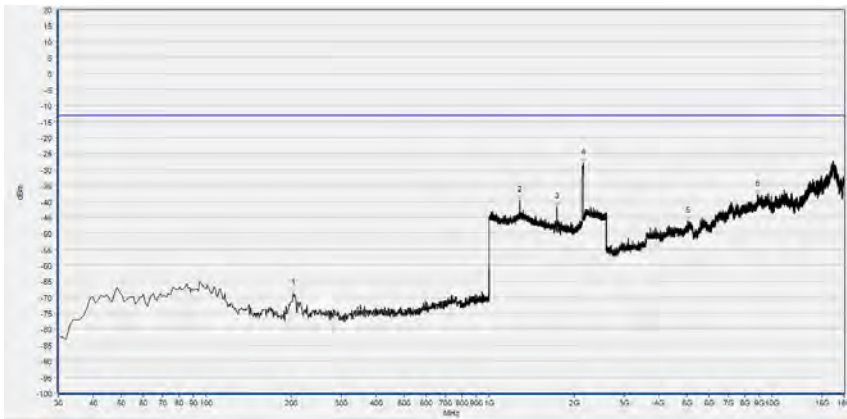

No.	Fre.(MHz)	PK (dBm)	Limit (dBm)	Antenna	Verdict
1	203.630	-68.75	-13.00	Horizontal	PASS
2	1281.713	-39.57	-13.00	Horizontal	PASS
3	1736.295	-41.61	-13.00	Horizontal	N/A
4	2153.101	-28.12	-13.00	Horizontal	N/A
5	5033.642	-46.10	-13.00	Horizontal	PASS
6	8917.949	-37.83	-13.00	Horizontal	PASS

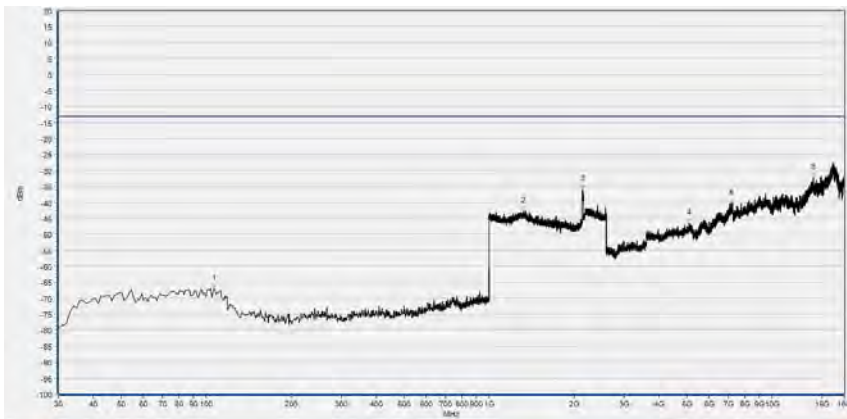

No.	Fre.(MHz)	PK (dBm)	Limit (dBm)	Antenna	Verdict
1	106.630	-66.96	-13.00	Vertical	PASS
2	1325.890	-42.80	-13.00	Vertical	PASS
3	2139.656	-35.84	-13.00	Vertical	N/A
4	5100.855	-46.50	-13.00	Vertical	PASS
5	7195.636	-40.38	-13.00	Vertical	PASS
6	14006.474	-32.33	-13.00	Vertical	PASS

LTE Band 5, 10MHz BW, Low Channel, QPSK

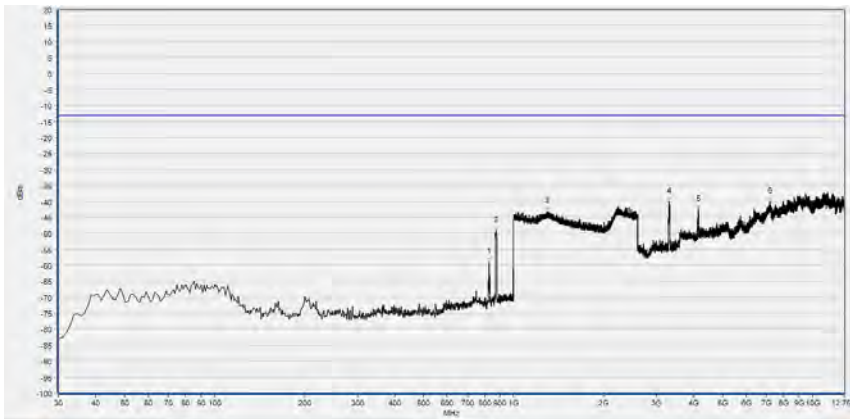

No.	Fre.(MHz)	PK (dBm)	Limit (dBm)	Antenna	Verdict
1	827.340	-59.12	-13.00	Horizontal	N/A
2	874.870	-49.32	-13.00	Horizontal	N/A
3	1295.798	-43.15	-13.00	Horizontal	PASS
4	3316.167	-40.08	-13.00	Horizontal	PASS
5	4148.618	-42.52	-13.00	Horizontal	PASS
6	7208.938	-40.12	-13.00	Horizontal	PASS

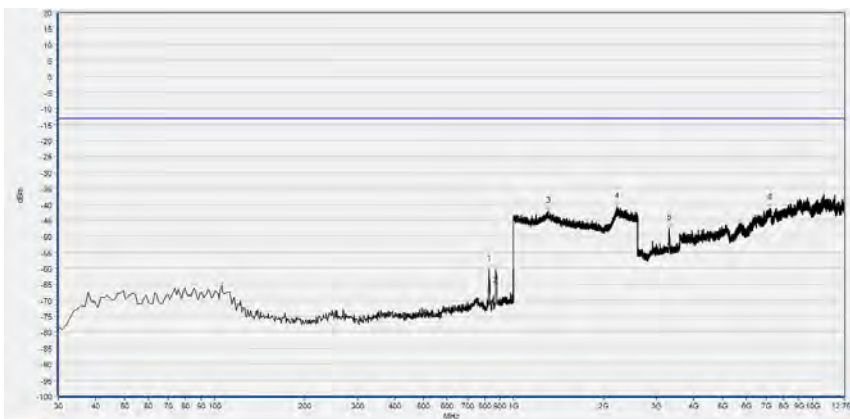

No.	Fre.(MHz)	PK (dBm)	Limit (dBm)	Antenna	Verdict
1	827.340	-60.34	-13.00	Vertical	N/A
2	870.990	-60.44	-13.00	Vertical	N/A
3	1303.481	-42.04	-13.00	Vertical	PASS
4	2210.724	-40.88	-13.00	Vertical	PASS
5	3306.938	-47.53	-13.00	Vertical	PASS
6	7203.401	-41.32	-13.00	Vertical	PASS

LTE Band 5, 10MHz BW, Mid Channel, QPSK

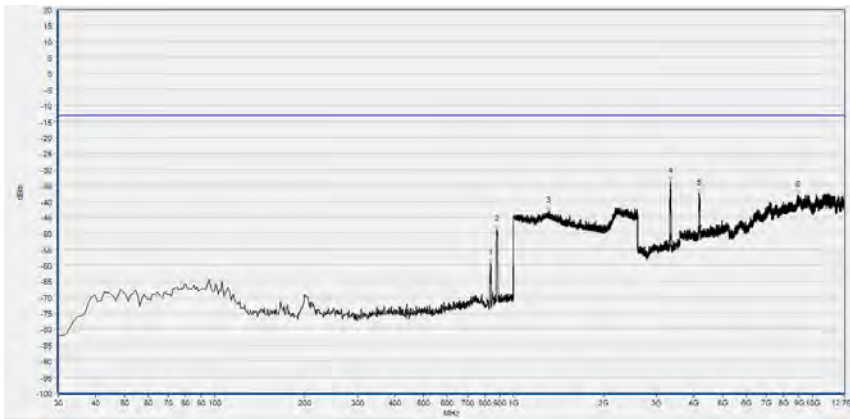

No.	Fre.(MHz)	PK (dBm)	Limit (dBm)	Antenna	Verdict
1	838.980	-59.41	-13.00	Horizontal	N/A
2	878.750	-48.88	-13.00	Horizontal	N/A
3	1306.683	-42.94	-13.00	Horizontal	PASS
4	3345.699	-33.90	-13.00	Horizontal	PASS
5	4181.842	-37.53	-13.00	Horizontal	PASS
6	8938.443	-38.18	-13.00	Horizontal	PASS

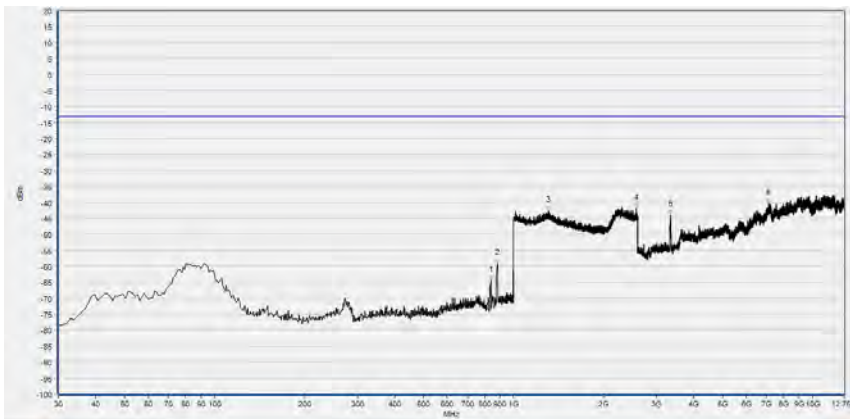

No.	Fre.(MHz)	PK (dBm)	Limit (dBm)	Antenna	Verdict
1	839.950	-64.48	-13.00	Vertical	N/A
2	885.540	-59.08	-13.00	Vertical	N/A
3	1305.402	-42.54	-13.00	Vertical	PASS
4	2578.231	-41.99	-13.00	Vertical	PASS
5	3345.699	-43.97	-13.00	Vertical	PASS
6	7135.106	-40.25	-13.00	Vertical	PASS

LTE Band 5, 10MHz BW, High Channel, QPSK

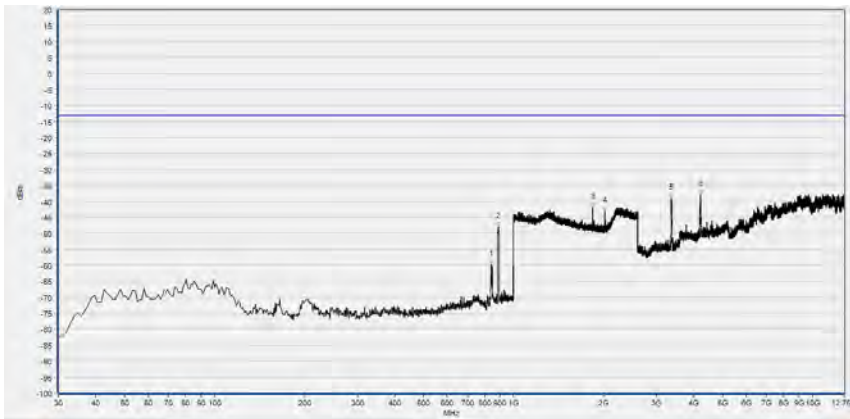

No.	Fre.(MHz)	PK (dBm)	Limit (dBm)	Antenna	Verdict
1	842.860	-59.72	-13.00	Horizontal	PASS
2	889.420	-47.85	-13.00	Horizontal	PASS
3	1841.937	-42.01	-13.00	Horizontal	PASS
4	2019.928	-43.03	-13.00	Horizontal	PASS
5	3375.232	-38.95	-13.00	Horizontal	PASS
6	4215.066	-37.90	-13.00	Horizontal	PASS

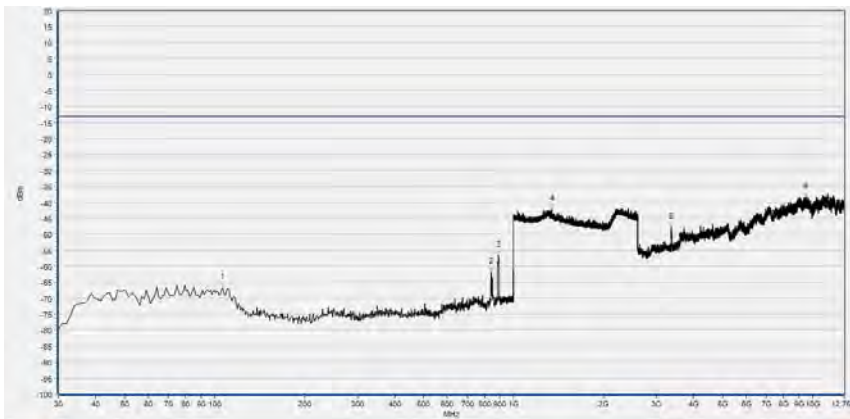

No.	Fre.(MHz)	PK (dBm)	Limit (dBm)	Antenna	Verdict
1	106.630	-66.63	-13.00	Vertical	PASS
2	842.860	-61.78	-13.00	Vertical	PASS
3	890.390	-56.73	-13.00	Vertical	PASS
4	1339.976	-42.17	-13.00	Vertical	PASS
5	3366.003	-47.73	-13.00	Vertical	PASS
6	9460.802	-38.30	-13.00	Vertical	PASS

LTE Band 12, 10MHz BW, Low Channel, QPSK

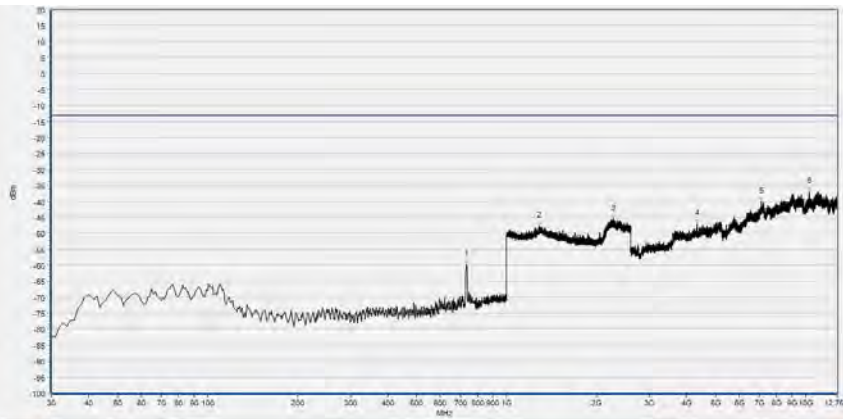

No.	Fre.(MHz)	PK (dBm)	Limit (dBm)	Antenna	Verdict
1	734.925	-59.75	-13.00	Horizontal	N/A
2	1283.294	-47.68	-13.00	Horizontal	PASS
3	2275.625	-45.54	-13.00	Horizontal	PASS
4	4338.028	-47.02	-13.00	Horizontal	PASS
5	7101.410	-40.18	-13.00	Horizontal	PASS
6	10291.178	-36.88	-13.00	Horizontal	PASS

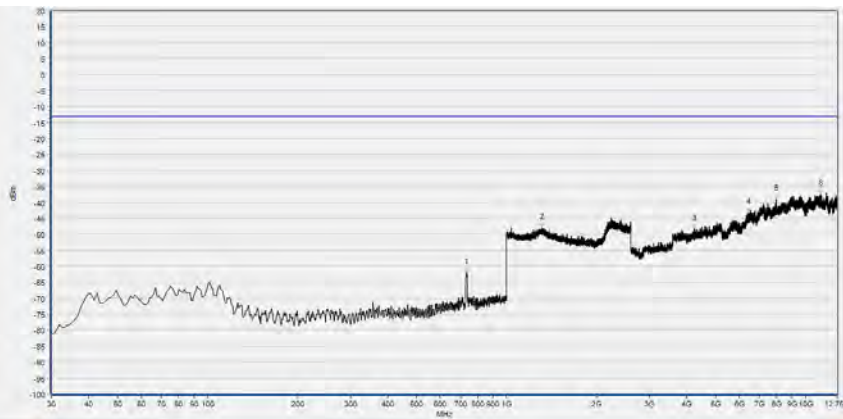

No.	Fre.(MHz)	PK (dBm)	Limit (dBm)	Antenna	Verdict
1	734.925	-61.98	-13.00	Vertical	N/A
2	1314.238	-47.93	-13.00	Vertical	PASS
3	4248.690	-48.36	-13.00	Vertical	PASS
4	6457.772	-43.20	-13.00	Vertical	PASS
5	7978.546	-39.05	-13.00	Vertical	PASS
6	11206.891	-37.37	-13.00	Vertical	PASS



LTE Band 12, 10MHz BW, Mid Channel, QPSK

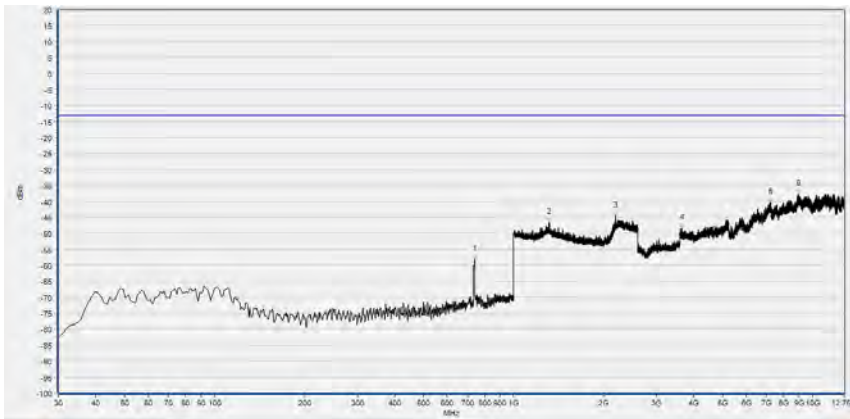

No.	Fre.(MHz)	PK (dBm)	Limit (dBm)	Antenna	Verdict
1	741.722	-58.31	-13.00	Horizontal	N/A
2	1311.037	-46.64	-13.00	Horizontal	PASS
3	2192.931	-44.62	-13.00	Horizontal	PASS
4	3661.902	-48.44	-13.00	Horizontal	PASS
5	7243.539	-40.44	-13.00	Horizontal	PASS
6	8957.201	-37.68	-13.00	Horizontal	PASS

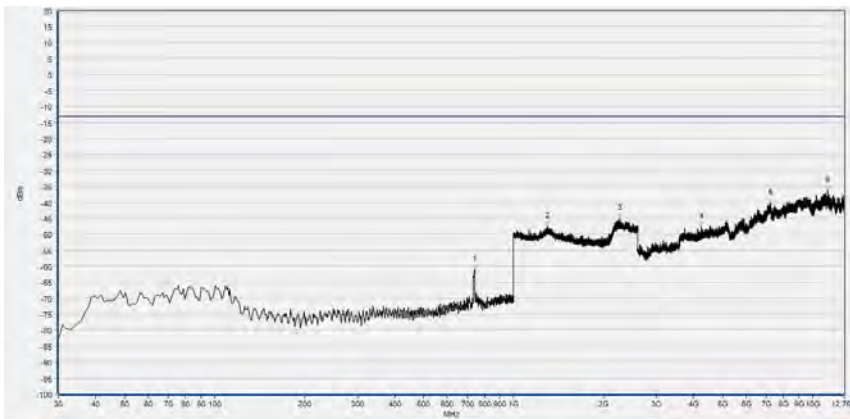

No.	Fre.(MHz)	PK (dBm)	Limit (dBm)	Antenna	Verdict
1	741.722	-61.08	-13.00	Vertical	N/A
2	1300.900	-47.43	-13.00	Vertical	PASS
3	2260.687	-45.10	-13.00	Vertical	PASS
4	4252.751	-47.69	-13.00	Vertical	PASS
5	7235.417	-40.36	-13.00	Vertical	PASS
6	11221.104	-36.38	-13.00	Vertical	PASS



LTE Band 12, 10MHz BW, High Channel, QPSK

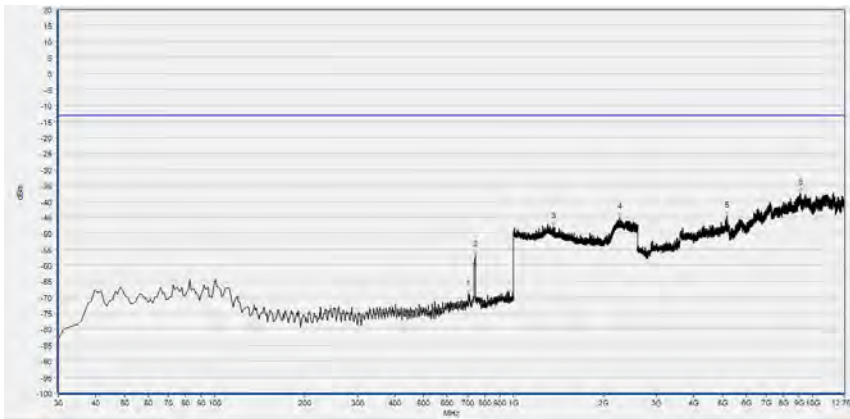

No.	Fre.(MHz)	PK (dBm)	Limit (dBm)	Antenna	Verdict
1	706.767	-68.98	-13.00	Horizontal	N/A
2	743.664	-56.88	-13.00	Horizontal	N/A
3	1354.785	-47.91	-13.00	Horizontal	PASS
4	2265.488	-45.07	-13.00	Horizontal	PASS
5	5160.342	-44.62	-13.00	Horizontal	PASS
6	9093.239	-37.53	-13.00	Horizontal	PASS

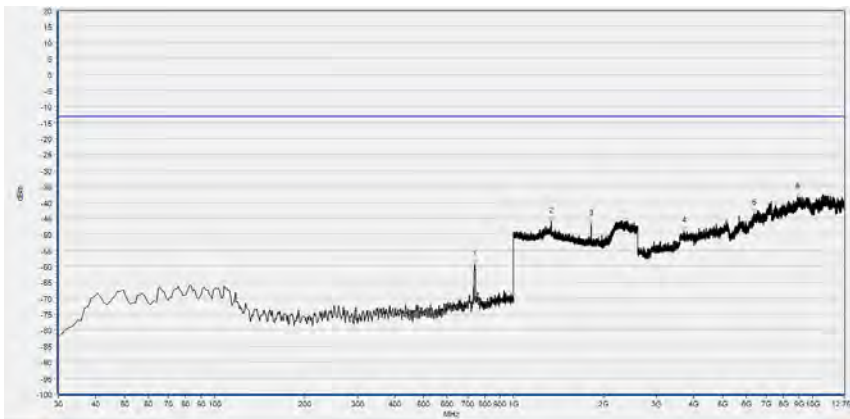

No.	Fre.(MHz)	PK (dBm)	Limit (dBm)	Antenna	Verdict
1	740.751	-59.23	-13.00	Vertical	N/A
2	1337.713	-45.90	-13.00	Vertical	PASS
3	1821.607	-46.92	-13.00	Vertical	PASS
4	3722.815	-49.09	-13.00	Vertical	PASS
5	6376.555	-43.57	-13.00	Vertical	PASS
6	8934.867	-38.26	-13.00	Vertical	PASS

LTE Band 66, 20MHz BW, Low Channel, QPSK

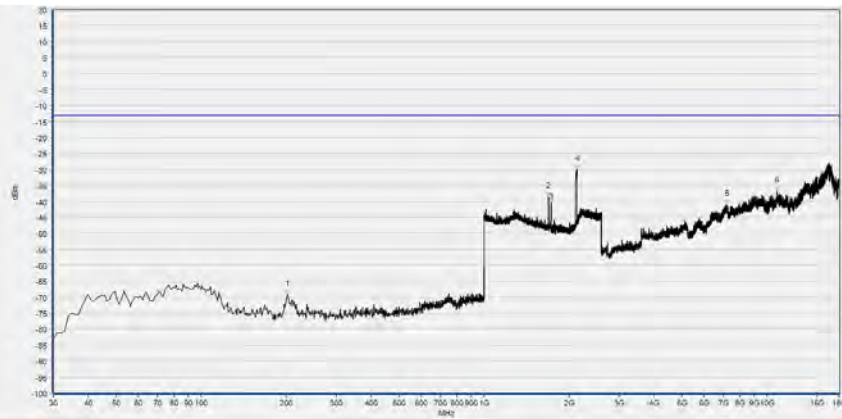

No.	Fre.(MHz)	PK (dBm)	Limit (dBm)	Antenna	Verdict
1	201.690	-69.27	-13.00	Horizontal	PASS
2	1692.757	-38.59	-13.00	Horizontal	PASS
3	1726.050	-40.46	-13.00	Horizontal	N/A
4	2128.131	-30.06	-13.00	Horizontal	N/A
5	7229.242	-40.99	-13.00	Horizontal	PASS
6	10827.896	-36.76	-13.00	Horizontal	PASS

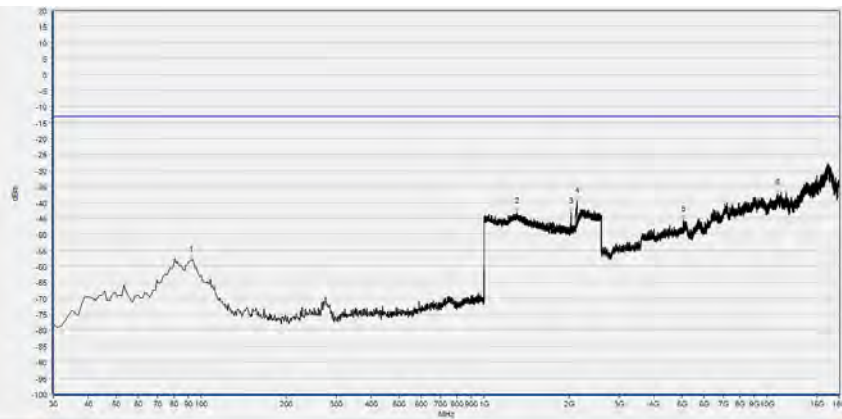

No.	Fre.(MHz)	PK (dBm)	Limit (dBm)	Antenna	Verdict
1	92.080	-58.26	-13.00	Vertical	PASS
2	1304.762	-43.02	-13.00	Vertical	PASS
3	2035.294	-42.95	-13.00	Vertical	PASS
4	2124.930	-39.55	-13.00	Vertical	N/A
5	5075.650	-45.37	-13.00	Vertical	PASS
6	10900.709	-37.12	-13.00	Vertical	PASS

LTE Band 66, 20MHz BW, Mid Channel, QPSK

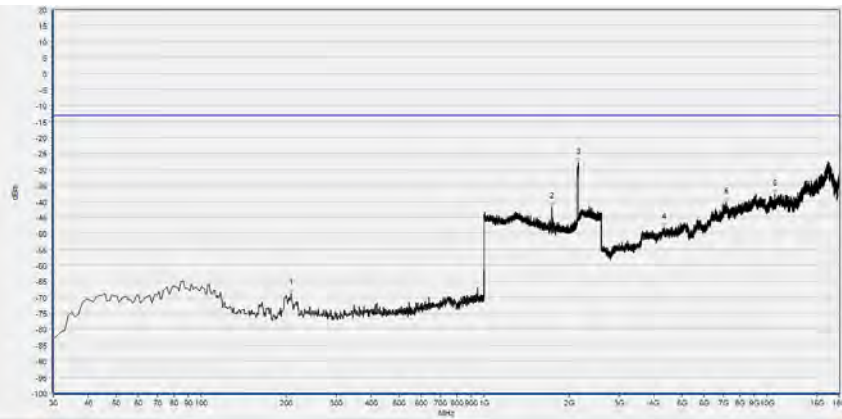

No.	Fre.(MHz)	PK (dBm)	Limit (dBm)	Antenna	Verdict
1	207.510	-68.78	-13.00	Horizontal	PASS
2	1736.935	-41.57	-13.00	Horizontal	N/A
3	2152.461	-27.89	-13.00	Horizontal	N/A
4	4319.513	-48.24	-13.00	Horizontal	PASS
5	7170.431	-40.42	-13.00	Horizontal	PASS
6	10673.868	-37.61	-13.00	Horizontal	PASS

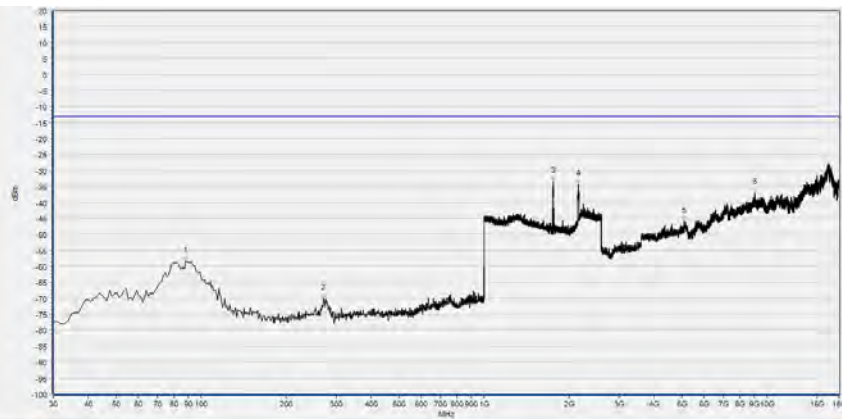

No.	Fre.(MHz)	PK (dBm)	Limit (dBm)	Antenna	Verdict
1	88.200	-58.54	-13.00	Vertical	PASS
2	270.560	-70.10	-13.00	Vertical	PASS
3	1753.581	-33.33	-13.00	Vertical	N/A
4	2157.583	-34.38	-13.00	Vertical	N/A
5	5086.852	-45.95	-13.00	Vertical	PASS
6	9046.772	-36.97	-13.00	Vertical	PASS

LTE Band 66, 20MHz BW, High Channel, QPSK

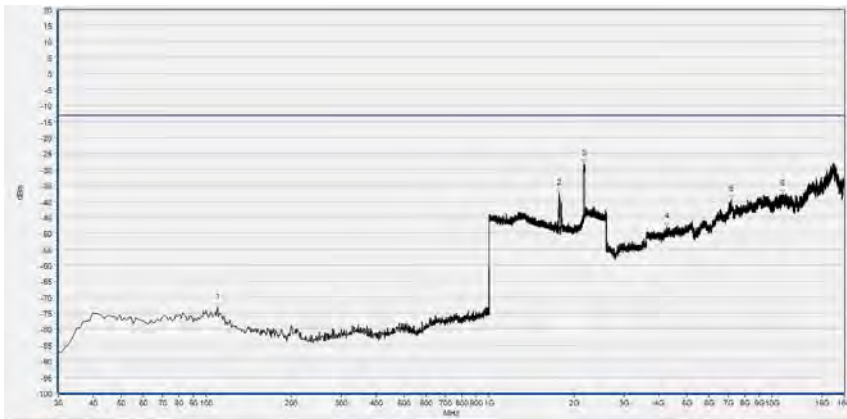

No.	Fre.(MHz)	PK (dBm)	Limit (dBm)	Antenna	Verdict
1	109.540	-73.10	-13.00	Horizontal	PASS
2	1766.387	-37.52	-13.00	Horizontal	N/A
3	2162.705	-28.25	-13.00	Horizontal	N/A
4	4260.702	-47.90	-13.00	Horizontal	PASS
5	7190.035	-39.42	-13.00	Horizontal	PASS
6	10939.916	-37.74	-13.00	Horizontal	PASS

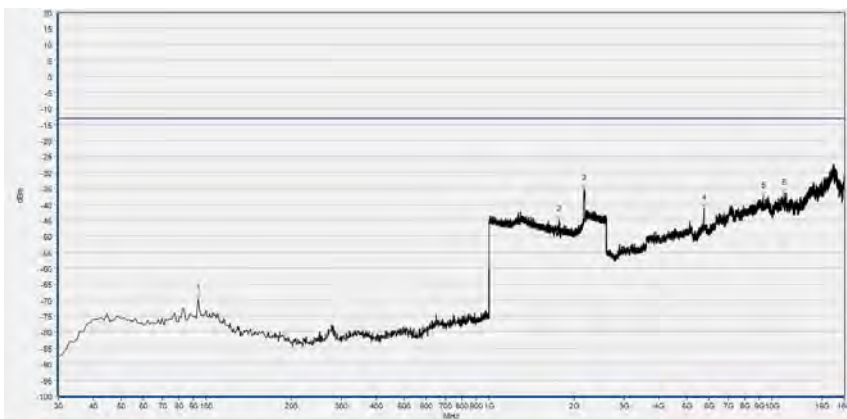

No.	Fre.(MHz)	PK (dBm)	Limit (dBm)	Antenna	Verdict
1	94.020	-69.59	-13.00	Vertical	PASS
2	1767.027	-44.81	-13.00	Vertical	N/A
3	2161.425	-35.18	-13.00	Vertical	N/A
4	5744.972	-41.19	-13.00	Vertical	PASS
5	9304.419	-37.44	-13.00	Vertical	PASS
6	11018.331	-36.44	-13.00	Vertical	PASS



Annex A Test Uncertainty

Where relevant, the following measurement uncertainty levels have been estimated for test performed on the EUT as specified in CISPR 16-1-2:

Test Items	Uncertainty
Output Power	± 2.22 dB
Bandwidth	$\pm 5\%$
Conducted Spurious Emission	± 2.77 dB
Band Edge	± 2.77 dB
Equivalent Isotropic Radiated Power	± 2.22 dB
Radiated Spurious Emissions	± 6 dB

This uncertainty represent an expanded uncertainty expressed at approximately the 95% confidence level using a coverage factor of $k=2$.



Annex B Testing Laboratory Information

1. Identification of the Responsible Testing Laboratory

Laboratory Name:	Morlab Laboratory of Shenzhen Morlab Communications Technology Co., Ltd.
Laboratory Address:	FL.3, Building A, FeiYang Science Park, No.8 LongChang Road, Block 67, BaoAn District, ShenZhen, GuangDong Province, P. R. China
Telephone:	+86 755 36698555
Facsimile:	+86 755 36698525

2. Identification of the Responsible Testing Location

Name:	Morlab Laboratory of Shenzhen Morlab Communications Technology Co., Ltd.
Address:	FL.3, Building A, FeiYang Science Park, No.8 LongChang Road, Block 67, BaoAn District, ShenZhen, GuangDong Province, P. R. China

3. Facilities and Accreditations

All measurement facilities used to collect the measurement data are located at FL.3, Building A, FeiYang Science Park, Block 67, BaoAn District, Shenzhen, 518101 P. R. China. The test site is constructed in conformance with the requirements of ANSI C63.10-2013 and CISPR Publication 22; the FCC designation number is CN1192, the test firm registration number is 226174.



4. Test Equipments Utilized

4.1 Conducted Test Equipments

Equipment Name	Serial No.	Type	Manufacturer	Cal. Date	Cal. Due
Power Splitter	NW521	1506A	Weinschel	2020.04.15	2021.04.14
Attenuator 1	(N/A.)	10dB	Resnet	N/A	N/A
Attenuator 2	(N/A.)	3dB	Resnet	N/A	N/A
EXA Signal Analyzer	MY51511149	N9020A	Agilent	2020.07.27	2021.07.26
USB Power Sensor	MY54210011	U2021XA	Agilent	2020.10.23	2021.10.22
System Simulator	6200995016	MT8820C	Anritsu	2020.10.28	2021.10.27
System Simulator	6261830572	MT8821C	Anritsu	2021.02.25	2022.02.24
RF Cable (30MHz-26GHz)	CB01	RF01	Morlab	N/A	N/A
Coaxial Cable	CB02	RF02	Morlab	N/A	N/A
SMA Connector	CN01	RF03	HUBER-SUHNER	N/A	N/A
Temperature Chamber	(N/A)	HUT705P	CHONGQING HANBA EXPERIMENTAL EQUIPMENT CO.,LTD	2021.03.17	2022.03.16
Computer	T430i	Think Pad	Lenovo	N/A	N/A

**4.2 Radiated Test Equipments**

Equipment Name	Serial No.	Type	Manufacturer	Cal. Date	Cal. Due
System Simulator	152038	CMW500	R&S	2020.11.19	2021.11.18
System Simulator	6200995016	MT8820C	Anritsu	2020.10.28	2021.10.27
Receiver	MY54130016	N9038A	Agilent	2020.07.21	2021.07.20
Test Antenna - Bi-Log	9163-519	VULB 9163	Schwarzbeck	2019.05.24	2022.05.23
Test Antenna - Horn	9170C-531	BBHA9170	Schwarzbeck	2019.07.26	2022.07.25
Test Antenna - Horn	01774	BBHA 9120D	Schwarzbeck	2019.07.26	2022.07.25
Coaxial Cable (N male) (9kHz-30MHz)	CB04	EMC04	Morlab	N/A	N/A
Coaxial Cable (N male) (30MHz-26GHz)	CB02	EMC02	Morlab	N/A	N/A
Coaxial Cable (N male) (30MHz-26GHz)	CB03	EMC03	Morlab	N/A	N/A
Coaxial Cable (N male) (30MHz-40GHz)	CB05	EMC05	Morlab	N/A	N/A
1-18GHz pre-Amplifier	61171/61172	S020180L3203	Tonscend	2020.07.21	2021.07.20
18-26.5GHz pre-Amplifier	46732	S10M100L3802	Tonscend	2020.07.21	2021.07.20
26-40GHz pre-Amplifier	56774	S40M400L4002	Tonscend	2020.07.21	2021.07.20
Notch Filter	N/A	WRCGV -LTE B2	Wainwright	2020.07.21	2021.07.20
Notch Filter	N/A	WRCGV -LTE B4	Wainwright	2020.07.21	2021.07.20
Notch Filter	N/A	WRCGV -LTE B5	Wainwright	2020.07.21	2021.07.20



REPORT No.: SZ21020188W02

Equipment Name	Serial No.	Type	Manufacturer	Cal. Date	Cal. Due
Notch Filter	N/A	WRCGV -LTE B12	Wainwright	2020.07.21	2021.07.20
Notch Filter	N/A	WRCGV -LTE B66	Wainwright	2020.07.21	2021.07.20
Anechoic Chamber	N/A	9m*6m*6m	CRT	2019.07.13	2022.07.12

————— END OF REPORT —————