



# SAR TEST REPORT

<b>FCC ID</b> ..... :	2AQRM-S67	
<b>Test Report No</b> ..... :	TCT240910E033	
<b>Date of issue</b> ..... :	Oct. 08, 2024	
<b>Testing laboratory</b> .....	SHENZHEN TONGCE TESTING LAB	
<b>Testing location/ address:</b>	2101 & 2201, Zhenchang Factory Renshan Industrial Zone, Fuhai Subdistrict, Bao'an District, Shenzhen, Guangdong, 518103, People's Republic of China	
<b>Applicant's name</b> ..... :	FOXX Development Inc.	
<b>Address</b> ..... :	3480 Preston Ridge Road, Suite500, Alpharetta, GA 30005, USA	
<b>Manufacturer's name</b> ... :	FOXX Development Inc.	
<b>Address</b> ..... :	3480 Preston Ridge Road, Suite500, Alpharetta, GA 30005, USA	
<b>Product Name</b> ..... :	Smart Phone	
<b>Trade Mark</b> .....	MIRO, FOXXD, AIRVOICE, FOXXD HTH	
<b>Model/Type reference</b> ..... :	S67	
<b>SAR Max. Values</b> ..... :	<b>0.952W/Kg (1g) for head; 0.692W/Kg (1g) for Body-worn; 0.692 W/Kg (1g) for Hotspot</b>	
<b>Simultaneous Reported SAR</b> ..... :	<b>1.494 W/Kg (1g) for head; 1.119W/Kg (1g) for Body-worn; 1.119 W/Kg (1g) for Hotspot</b>	
<b>Date of receipt of test item</b> .....	Sep. 10, 2024	
<b>Date (s) of performance of test</b> ..... :	Sep. 10, 2024 - Oct. 08, 2024	
<b>Tested by (+signature)</b> ... :	Karl WANG	
<b>Check by (+signature)</b> .... :	Beryl Zhao	
<b>Approved by (+signature)</b> :	Tomsin	

**General disclaimer:**

This report shall not be reproduced except in full, without the written approval of SHENZHEN TONGCE TESTING LAB. This document may be altered or revised by SHENZHEN TONGCE TESTING LAB personnel only, and shall be noted in the revision section of the document. The test results in the report only apply to the tested sample.

**TABLE OF CONTENTS**

<b>1. General Product Information .....</b>	<b>4</b>
<b>1.1. EUT description .....</b>	<b>4</b>
<b>1.2. Model(s) list.....</b>	<b>5</b>
<b>2. Test standard .....</b>	<b>6</b>
<b>3. Facilities and Accreditations .....</b>	<b>6</b>
<b>3.1. Facilities .....</b>	<b>6</b>
<b>3.2. Location .....</b>	<b>6</b>
<b>3.3. Environment Condition:.....</b>	<b>6</b>
<b>4. Test Result Summary .....</b>	<b>7</b>
<b>5. RF Exposure Limit.....</b>	<b>11</b>
<b>6. SAR Measurement System Configuration.....</b>	<b>12</b>
<b>6.1. SAR Measurement Set-up.....</b>	<b>12</b>
<b>6.2. E-field Probe .....</b>	<b>13</b>
<b>6.3. Phantom .....</b>	<b>13</b>
<b>6.4. Device Holder.....</b>	<b>14</b>
<b>6.5. Data Storage and Evaluation .....</b>	<b>15</b>
<b>6.6. Position of the wireless device in relation to the phantom.....</b>	<b>16</b>
<b>6.7. Tissue Dielectric Parameters.....</b>	<b>19</b>
<b>6.8. Tissue-equivalent Liquid Properties .....</b>	<b>20</b>
<b>6.9. System Check.....</b>	<b>21</b>
<b>7. Measurement Procedure .....</b>	<b>22</b>
<b>8. Conducted Output Power .....</b>	<b>25</b>
<b>9. Exposure Position Consideration .....</b>	<b>187</b>
<b>9.1. EUT Antenna Location .....</b>	<b>187</b>
<b>9.2. Test Position Consideration .....</b>	<b>187</b>
<b>10. SAR Test Results Summary .....</b>	<b>188</b>
<b>10.1. Head 1g SAR Data.....</b>	<b>188</b>
<b>10.2. Body-Worn 1g SAR Data .....</b>	<b>195</b>
<b>10.3. Hotspot 1g SAR Data .....</b>	<b>199</b>
<b>10.4. Simultaneous Transmission Conclusion.....</b>	<b>205</b>
<b>10.5. SAR Simultaneous Transmission Analysis .....</b>	<b>206</b>
<b>10.6. Measurement Uncertainty (450MHz-3GHz) .....</b>	<b>221</b>
<b>10.7. Test Equipment List.....</b>	<b>223</b>
<b>11. System Check Results .....</b>	<b>224</b>

12. SAR Test Data .....	248
Appendix A: EUT Photos .....	442
Appendix B: Test Setup Photos .....	445
Appendix C: Probe Calibration Certificate .....	447
Appendix D: Dipole Calibration Report.....	465
Appendix E: SAR SYSTEM VALIDATION.....	544
Appendix F: The Check Data of Impedance and Return Loss .....	545

## 1. General Product Information

### 1.1. EUT description

Product Name.....:	Smart Phone
Model/Type reference.....:	S67
SampleNumber.....:	TCT240910E033-0101
Rating(s).....:	Rechargeable Li-ion Battery DC 3.87V
<b>2G</b>	
Operation Band.....:	GSM850, GSM1900
Supported type.....:	GSM/GPRS/EGPRS
Power Class.....:	GSM850:Power Class 5; GSM1900:Power Class 0
Modulation Type.....:	GMSK for GSM/GPRS ; 8PSK for EGPRS
GSM Release Version.....:	R99
GPRS Multislot Class.....:	12
EGPRS Multislot Class.....:	12
<b>3G</b>	
Operation Band.....:	FDD Band II & FDD Band IV & FDD Band V
Power Class.....:	Power Class 3
Modulation Type.....:	QPSK for WCDMA/HSDPA/HSUPA
WCDMA Release Version.....:	R99
HSDPA Release Version.....:	Release 5
HSUPA Release Version.....:	Release 6
DC-HSUPA Release Version.....:	Not Supported
<b>LTE</b>	
Operation Band.....:	LTE Band 2 & LTE Band 4 & LTE Band 5 & LTE Band 7 & LTE Band 12 & LTE Band 13 & LTE Band 17 & LTE Band 25 & LTE Band 26-1 & LTE Band 26-2 & LTE Band 41 & LTE Band 66 & LTE Band 71
Power Class.....:	Power Class 3
Modulation Type.....:	QPSK & 16-QAM for LTE
<b>5G NR</b>	
Operation Band.....:	5G NR n 2 & 5G NR n 5 & 5G NR n 25 & 5G NR n 41 & 5G NR n 66 & 5G NR n 71 & 5G NR n 77 & 5G NR n 78
Modulation Type.....:	BPSK, QPSK, 16QAM, 64QAM, 256QAM
<b>Wi-Fi 2.4G</b>	
Supported type.....:	802.11b/802.11g/802.11n/802.11ac
Modulation Type.....:	802.11b: DSSS 802.11g/802.11n/802.11ac: OFDM
Operation Frequency.....:	802.11b/802.11g/802.11n(HT20)/ac(HT20):2412MHz~2462MHz; 802.11n(HT40)/ 802.11ac(HT40):2422MHz~2452MHz
Channel number.....:	802.11b/802.11g/802.11n(HT20)/ 802.11ac(HT20):11; 802.11n(HT40)/ 802.11ac(HT40):7
Channel separation.....:	5MHz

Bluetooth	
Bluetooth Version.....:	Supported 5.0
Modulation.....:	GFSK(1Mbps), $\pi/4$ -DQPSK(2Mbps), 8-DPSK(3Mbps)
Operation Frequency.....:	2402MHz~2480MHz
Channel number.....:	79/40
Channel separation.....:	1MHz/2MHz
Wi-Fi 5G	
Operation Frequency.....:	Band 1: 5180 MHz~5240 MHz Band 2A: 5260 MHz~5320 MHz Band 2C: 5500 MHz~5700 MHz Band 3: 5745 MHz~5825 MHz
Channel Bandwidth.....:	802.11a: 20MHz 802.11n: 20MHz, 40MHz 802.11ac: 20MHz, 40MHz, 80MHz
Modulation Technology.....:	Orthogonal Frequency Division Multiplexing(OFDM)
Modulation Type.....:	256QAM, 64QAM, 16QAM, BPSK, QPSK

## 1.2. Model(s) list

None.

## 2. Test standard

The tests were performed according to following standards:

FCC 47 CFR §2.1093

IEC-IEEE 62209-1528-2020: Measurement procedure for the assessment of specific absorption rate of human exposure to radio frequency fields from hand-held and body-mounted wireless communication devices

KDB447498 D01:General RF Exposure Guidance v06

KDB865664 D01:SAR measurement 100MHz to 6GHz v01r04

KDB865664 D02:RF Exposure Reporting v01r02.

KDB941225 D01:3G SAR Procedures v03r01

KDB248227 D01:802.11 wi-fi SAR v02r02

KDB941225 D05:SAR for LTE devices v02r05

KDB941225 D06:Hotspot Mode v02r01

KDB941225 D07:UMPC Mini Tablet v01r02

KDB690783 D01:SAR Listings on Grant v01r03

## 3. Facilities and Accreditations

### 3.1. Facilities

The test facility is recognized, certified, or accredited by the following organizations:

- FCC - Registration No.: 645098

SHENZHEN TONGCE TESTING LAB

Designation Number: CN1205

The testing lab has been registered and fully described in a report with the (FCC) Federal Communications Commission. The acceptance letter from the FCC is maintained in our files.

- IC - Registration No.: 10668A-1

SHENZHEN TONGCE TESTING LAB

CAB identifier: CN0031

The testing lab has been registered by Certification and Engineering Bureau of Industry Canada for radio equipment testing.

### 3.2. Location

SHENZHEN TONGCE TESTING LAB

Address: 2101 & 2201, Zhenchang Factory Renshan Industrial Zone, Fuhai Subdistrict, Bao'an District, Shenzhen, Guangdong, 518103, People's Republic of China

### 3.3. Environment Condition:

Temperature:	18°C ~25°C
Humidity:	35%~75% RH
Atmospheric Pressure:	1011 mbar

#### 4. Test Result Summary

The maximum results of Specific Absorption Rate (SAR) found during test as bellows:  
<Highest Reported standalone SAR Summary>

Exposure Position	Frequency Band	Reported SAR (W/kg)	Equipment Class	Highest Reported SAR (W/kg)
Head 1-g SAR	GSM 850	0.155	PCE	0.952
	GSM 1900	0.948		
	WCDMA Band II	0.254		
	WCDMA Band IV	0.784		
	WCDMA Band V	0.206		
	LTE Band 2	0.643		
	LTE Band 4	0.641		
	LTE Band 5	0.201		
	LTE Band 7	0.077		
	LTE Band 12	0.268		
	LTE Band 13	0.188		
	LTE Band 17	0.199		
	LTE Band 25	0.470		
	LTE Band 26-1	0.230		
	LTE Band 26-2	0.192		
	LTE Band 41	0.125		
	LTE Band 66	<b>0.952</b>		
	LTE Band 71	0.059		
	5G N2	0.183		
	5G N5	0.695		
	5G N25	0.430		
	5G N41	0.603		
	5G N66	0.274		
	5G N71	0.074		
	5G N77	0.435		
	5G N78	0.198		
	WLAN 2.4 GHz	0.179	DTS	
	BT	0.247	DSS	
WLAN 5.2 GHz	0.542	NII		
WLAN 5.3 GHz	0.384			
WLAN 5.6 GHz	0.464			
WLAN 5.8 GHz	0.508			

Body-worn 1-g SAR (10 mm Gap)	GSM 850	0.252	PCE	<b>0.692</b>
	GSM 1900	0.173		
	WCDMA Band II	0.489		
	WCDMA Band IV	0.289		
	WCDMA Band V	0.208		
	LTE Band 2	<b>0.692</b>		
	LTE Band 4	0.375		
	LTE Band 5	0.104		
	LTE Band 7	0.129		
	LTE Band 12	0.183		
	LTE Band 13	0.163		
	LTE Band 17	0.155		
	LTE Band 25	0.381		
	LTE Band 26-1	0.123		
	LTE Band 26-2	0.237		
	LTE Band 41	0.180		
	LTE Band 66	0.271		
	LTE Band 71	0.326		
	5G N2	0.394		
	5G N5	0.284		
	5G N25	0.307		
	5G N41	0.558		
	5G N66	0.442		
	5G N71	0.333		
	5G N77	0.408		
	5G N78	0.621		
	WLAN 2.4 GHz	0.150	DTS	
	BT	0.022	DSS	
	WLAN 5.2 GHz	0.290	NII	
	WLAN 5.4 GHz	0.259		
WLAN 5.6 GHz	0.262			
WLAN 5.8 GHz	0.427			



Hotspot 1-g SAR (10 mm Gap)	GSM 850	0.252	PCE	<b>0.692</b>
	GSM 1900	0.173		
	WCDMA Band II	0.554		
	WCDMA Band IV	0.335		
	WCDMA Band V	0.208		
	LTE Band 2	<b>0.692</b>		
	LTE Band 4	0.444		
	LTE Band 5	0.104		
	LTE Band 7	0.129		
	LTE Band 12	0.183		
	LTE Band 13	0.163		
	LTE Band 17	0.155		
	LTE Band 25	0.418		
	LTE Band 26-1	0.123		
	LTE Band 26-2	0.237		
	LTE Band 41	0.180		
	LTE Band 66	0.271		
	LTE Band 71	0.326		
	5G N2	0.394		
	5G N5	0.284		
	5G N25	0.307		
	5G N41	0.558		
	5G N66	0.442		
	5G N71	0.333		
	5G N77	0.408		
	5G N78	0.621		
	WLAN 2.4 GHz	0.150	DTS	
WLAN 5.2 GHz	0.290	NII		
WLAN 5.4 GHz	0.259			
WLAN 5.6 GHz	0.262			
WLAN 5.8 GHz	0.427			

<Highest Reported simultaneous SAR Summary>

Exposure Position	Frequency Band	Highest Reported Simultaneous Transmission SAR (W/kg)
Head 1-g SAR	LTE Band 66 + WIFI 5G	<b>1.494</b>
Body 1-g SAR (10 mm Gap)	LTE Band 2 + WIFI 5G	<b>1.119</b>
Hotspot 1-g SAR (10 mm Gap)	LTE Band 2 + WIFI 5G	<b>1.119</b>

**Note:**

1. The highest simultaneous transmission is scalar summation of Reported standalone SAR per FCC KDB 690783 D01 v01r03, and scalar SAR summation of all possible simultaneous transmission scenarios are < 1.6W/kg.
2. This device is compliance with Specific Absorption Rate (SAR) for general population/uncontrolled exposure limits specified in FCC 47 CFR part 2 (2.1093) and ANSI/IEEE C95.1-2005, and had been tested in accordance with the measurement methods and procedures specified in IEEE 1528-2013.
3. This EUT owns four cards, after we perform the pretest for these two SIM card; we found the SIM 1 is the worst case, so its result is recorded in this report.

## 5. RF Exposure Limit

Type Exposure	SAR (W/kg)
	Uncontrolled Exposure Limit
Spatial Peak SAR (averaged over any 1 g of tissue)	1.60
Spatial Peak SAR (hands/wrists/feet/ankles averaged over 10g)	4.00
Spatial Peak SAR (averaged over the whole body)	0.08

**Note:**

1. The Spatial Peak value of the SAR averaged over any 1 gram of tissue (defined as a tissue volume in the shape of a cube) and over the appropriate averaging time.
2. The Spatial Average value of the SAR averaged over the whole body.
3. The Spatial Peak value of the SAR averaged over any 10 grams of tissue (defined as a tissue volume in the shape of a cube) and over the appropriate averaging time.

## 6. SAR Measurement System Configuration

### 6.1. SAR Measurement Set-up

The OPENSAR system for performing compliance tests consist of the following items:

A standard high precision 6-axis robot (KUKA) with controller and software.

KUKA Control Panel (KCP)

A dosimetric probe, i.e., an isotropic E-field probe optimized and calibrated for usage in tissue simulating liquid. The probe is equipped with a Video Positioning System (VPS).

The stress sensor is composed with mechanical and electronic when the electronic part detects a change on the electro-mechanical switch; it sends an "Emergency signal" to the robot controller that to stop robot's moves A computer operating Windows XP.

OPENSAR software Remote control with teaches pendant and additional circuitry for robot safety such as warning lamps, etc.

The SAM phantom enabling testing left-hand right-hand and body usage.

The Position device for handheld EUT

Tissue simulating liquid mixed according to the given recipes.

System validation dipoles to validate the proper functioning of the system.

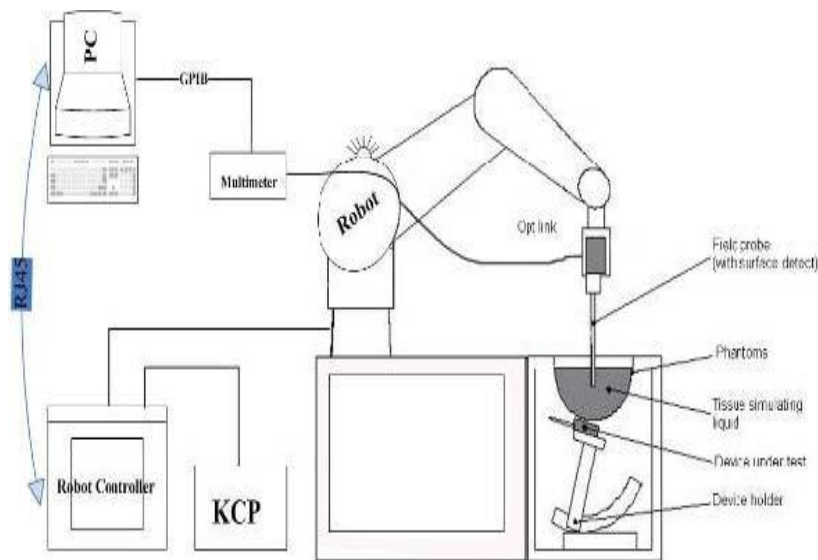

**KUKA SAR Test System Configuration**

## 6.2. E-field Probe

The SAR measurement is conducted with the dosimetric probe (manufactured by MVG). The probe is specially designed and calibrated for use in liquid with high permittivity. The dosimetric probe has special calibration in liquid at different frequency. This probe has a built in optical surface detection system to prevent from collision with phantom.

### Probe Specification

Construction Symmetrical design with triangular core  
Interleaved sensors  
Built-in shielding against static charges  
PEEK enclosure material (resistant to organic solvents, e.g., DGBE)  
Calibration ISO/IEC 17025 calibration service available.

Device Type	COMOSAR DOSIMETRIC E FIELD PROBE
Manufacturer	MVG
Model	SSE2
Serial Number	SN 25/22 EPGO375
Frequency Range of Probe	0.15 GHz- 6GHz
Resistance of Three Dipoles at Connector	Dipole 1:R1=0.197MΩ Dipole 2:R3=0.230MΩ Dipole 3:R3=0.208MΩ

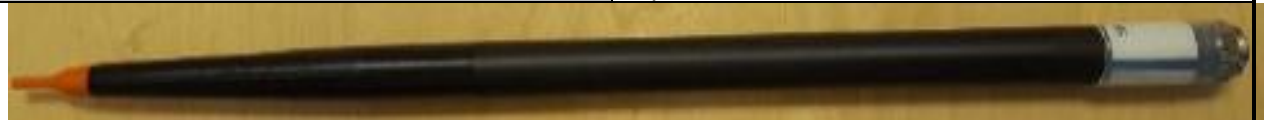

Photo of E-Field Probe

## 6.3. Phantom

The SAM Phantom SAM120 is constructed of a fiberglass shell integrated in a wooden table. The shape of the shell is in compliance with the specification set in IEEE P1528 and CENELEC IEC-IEEE 62209-1528-2020.

The phantom enables the dosimetric evaluation of left and right hand phone usage as well as body mounted usage at the flat phantom region.

A cover prevents the evaporation of the liquid.

Reference markings on the Phantom allow the complete setup of all predefined phantom positions and measurement grids by manually teaching three points in the robot

System checking was performed using the flat section, whilst Head SAR tests used the left and right head profile sections.

Body SAR testing also used the flat section between the head profiles.

Name: COMOSAR IEEE SAM PHANTOM  
S/N: SN 19/15 SAM 120  
Manufacture: MVG

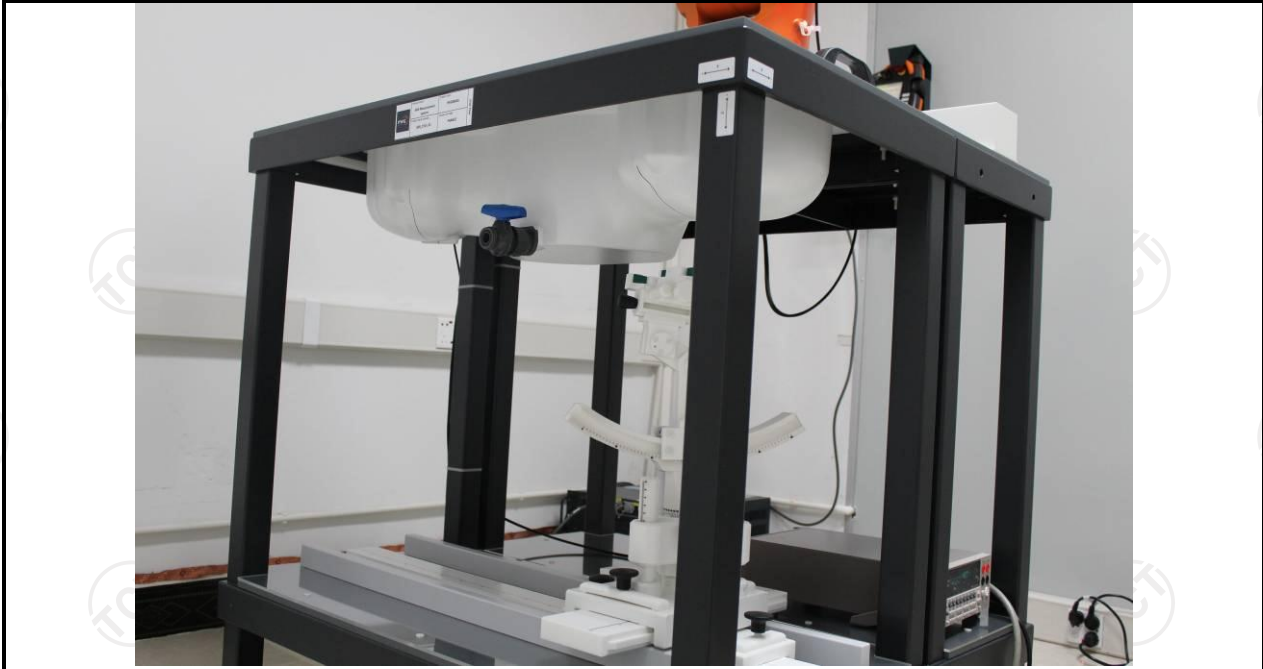

SAM Twin Phantom

#### 6.4. Device Holder

In combination with the Generic Twin Phantom SAM120, the Mounting Device enables the rotation of the mounted transmitter in spherical coordinates whereby the rotation points is the ear opening. The devices can be easily, accurately, and repeatedly positioned according to the FCC and CENELEC specifications. The device holder can be locked at different phantom locations (left head, right head, flat phantom).

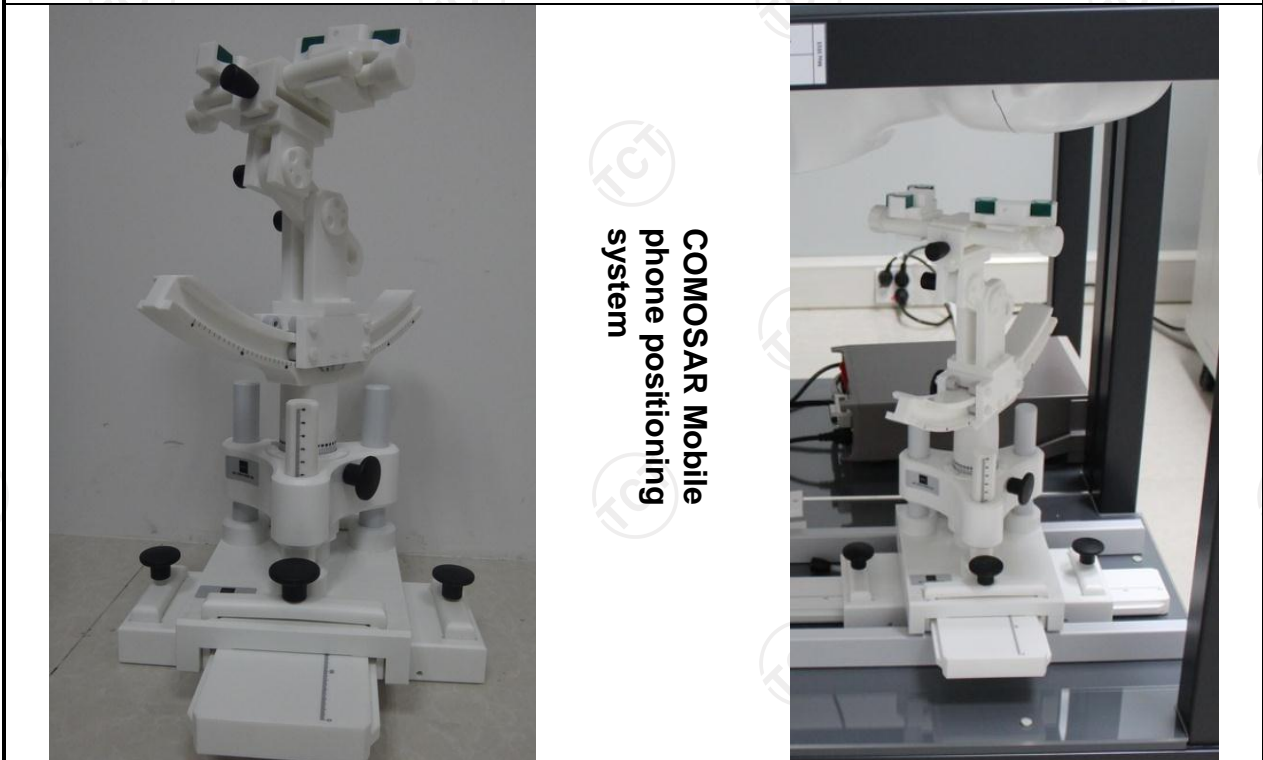

COMOSAR Mobile  
phone positioning  
system

## 6.5. Data Storage and Evaluation

### Data Storage

The OPENSAR software stores the acquired data from the data acquisition electronics as raw data (in microvolt readings from the probe sensors), together with all necessary software parameters for the data evaluation (probe calibration data, liquid parameters and device frequency and modulation data) in measurement files. The software evaluates the desired unit and format for output each time the data is visualized or exported. This allows verification of the complete software setup even after the measurement and allows correction of incorrect parameter settings. For example, if a measurement has been performed with a wrong crest factor parameter in the device setup, the parameter can be corrected afterwards and the data can be re-evaluated.

The measured data can be visualized or exported in different units or formats, depending on the selected probe type ([V/m], [A/m], [°C], [mW/g], [mW/cm<sup>2</sup>], [dBrel], etc.). Some of these units are not available in certain situations or show meaningless results, e.g., a SAR output in a lossless media will always be zero. Raw data can also be exported to perform the evaluation with other software packages.

### Data Evaluation

The OPENSAR software automatically executes the following procedures to calculate the field units from the microvolt readings at the probe connector. The parameters used in the evaluation are stored in the configuration modules of the software:

Probe parameters:	- Sensitivity	Normi, ai0, ai1, ai2
	- Conversion factor	ConvFi
	- Diode compression point	Dcpi
Device parameters:	- Frequency	f
	- Crest factor	cf
Media parameters:	- Conductivity	σ
	- Density	ρ

These parameters must be set correctly in the software. They can be found in the component documents or they can be imported into the software from the configuration files issued for the OPENSAR components. In the direct measuring mode of the millimeter option, the parameters of the actual system setup are used. In the scan visualization and export modes, the parameters stored in the corresponding document files are used.

The first step of the evaluation is a linearization of the filtered input signal to account for the compression characteristics of the detector diode. The compensation depends on the input signal, the diode type and the DC-transmission factor from the diode to the evaluation electronics. If the exciting field is pulsed, the crest factor of the signal must be known to correctly compensate for peak power. The formula for each channel can be given as:

$$V_i = U_i + U_i^2 \cdot c f / d c p_i$$

With	$V_i$	= compensated signal of channel i	(i = x, y, z)
	$U_i$	= input signal of channel i	(i = x, y, z)
	cf	= crest factor of exciting field	(MVG parameter)
	dcpi	= diode compression point	(MVG parameter)

From the compensated input signals the primary field data for each channel can be evaluated:

$$\text{E-field probes: } E_i = (V_i / \text{Normi} \cdot \text{ConvF})^{1/2}$$

$$\text{H-field probes: } H_i = (V_i)^{1/2} \cdot (ai_0 + ai_1 f + ai_2 f^2) / f$$

With	$V_i$	= compensated signal of channel i	(i = x, y, z)
	Normi	= sensor sensitivity of channel i	(i = x, y, z)
		[mV/(V/m) <sup>2</sup> ] for E-field Probes	
	ConvF	= sensitivity enhancement in solution	
	aij	= sensor sensitivity factors for H-field probes	
	f	= carrier frequency [GHz]	
	$E_i$	= electric field strength of channel i in V/m	
	$H_i$	= magnetic field strength of channel i in A/m	

The RSS value of the field components gives the total field strength (Hermitian magnitude):

$$E_{tot} = (E_x^2 + E_y^2 + E_z^2)^{1/2}$$

The primary field data are used to calculate the derived field units.

$$SAR = (E_{tot})^2 \cdot \sigma / (\rho \cdot 1000)$$

- with SAR = local specific absorption rate in mW/g
- E<sub>tot</sub> = total field strength in V/m
- σ = conductivity in [mho/m] or [Siemens/m]
- ρ = equivalent tissue density in g/cm<sup>3</sup>

Note that the density is normally set to 1 (or 1.06), to account for actual brain density rather than the density of the simulation liquid. The power flow density is calculated assuming the excitation field to be a free space field.

### 6.6. Position of the wireless device in relation to the phantom

#### Handset Reference Points

$$P_{pwe} = E_{tot}^2 / 3770 \text{ or } P_{pwe} = H_{tot}^2 \cdot 37.7$$

- With P<sub>pwe</sub> = equivalent power density of a plane wave in mW/cm<sup>2</sup>
- E<sub>tot</sub> = total electric field strength in V/m
- H<sub>tot</sub> = total magnetic field strength in A/m

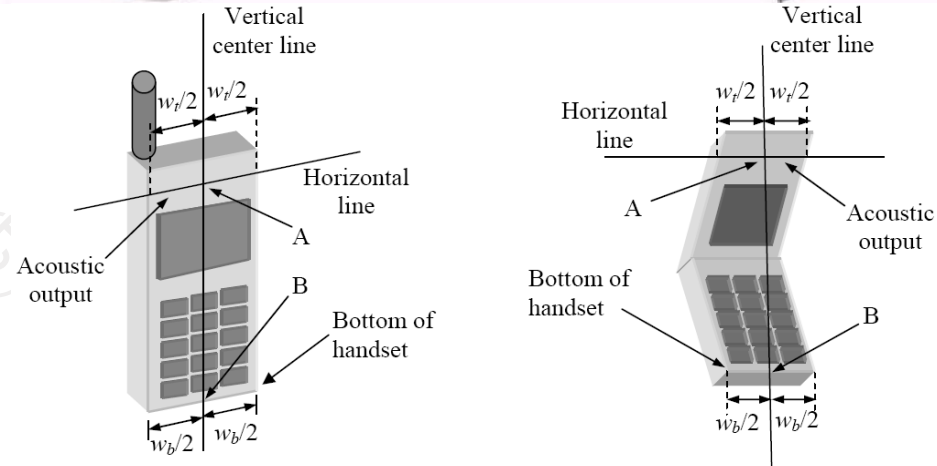

- W<sub>t</sub> Width of the handset at the level of the acoustic
- W<sub>b</sub> Width of the bottom of the handset
- A Midpoint of the width w<sub>t</sub> of the handset at the level of the acoustic output
- B Midpoint of the width w<sub>b</sub> of the bottom of the handset

#### Positioning for Cheek / Touch





**Positioning for Ear / 15° Tilt**

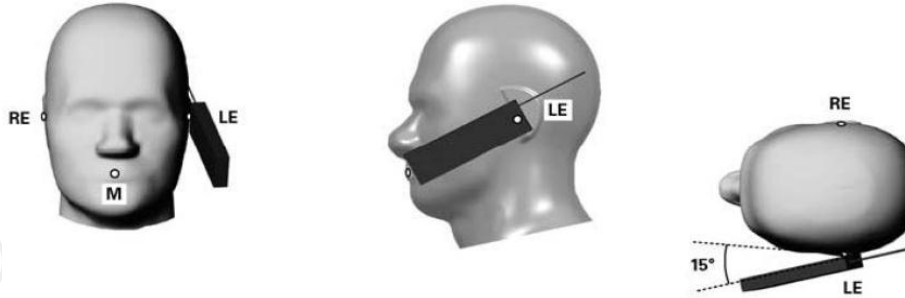

**Body Worn Accessory Configurations**

To position the device parallel to the phantom surface with either keypad up or down.

To adjust the device parallel to the flat phantom.

To adjust the distance between the device surface and the flat phantom to 15mm or holster surface and the flat phantom to 0 mm.

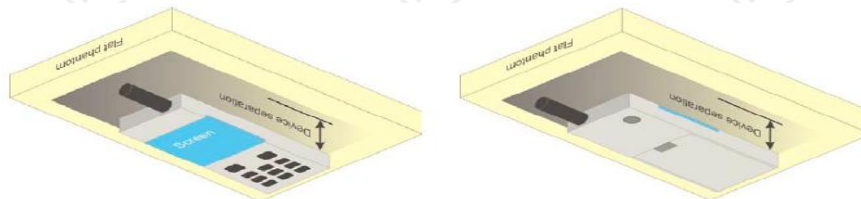

**Illustration for Body Worn Position**

**Wireless Router (Hotspot) Configurations**

Some battery-operated handsets have the capability to transmit and receive internet connectivity through simultaneous transmission of WIFI in conjunction with a separate licensed transmitter. The FCC has provided guidance in KDB Publication 941225 D06 where SAR test considerations for handsets (L x W ≥

9 cm x 5 cm) are based on a composite test separation distance of 10 mm from the front, back and edges of the device with antennas 2.5 cm or closer to the edge of the device, determined from general mixed use conditions for this type of devices. Since the hotspot SAR results may overlap with the body-worn accessory SAR requirements, the more conservative configurations can be considered, thus excluding some body-worn accessory SAR tests.

When the user enables the personal wireless router functions for the handset, actual operations include simultaneous transmission of both the WIFI transmitter and another licensed transmitter. Both transmitters often do not transmit at the same transmitting frequency and thus cannot be evaluated for SAR under actual use conditions. Therefore, SAR must be evaluated for each frequency transmission and mode separately and summed with the WIFI transmitter according to KDB 648474 publication procedures. The "Portable Hotspot" feature on the handset was NOT activated, to ensure the SAR measurements were evaluated for a single transmission frequency RF signal.

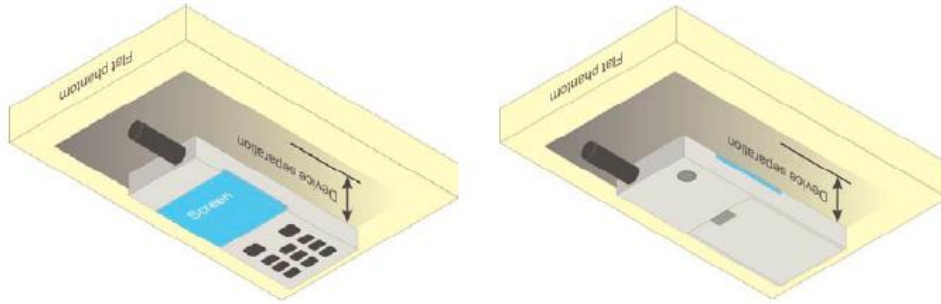
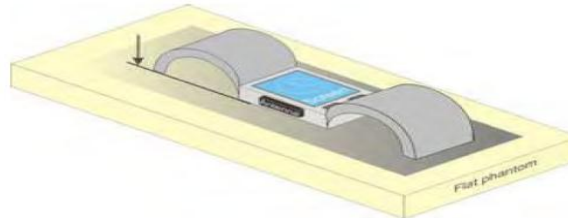

**Illustration for Hotspot Position**

**Limb-worn device**

A limb-worn device is a unit whose intended use includes being strapped to the arm or leg of the user while transmitting (except in idle mode). It is similar to a body-worn device. Therefore, the test positions of 6.1.4.4 also apply. The strap shall be opened so that it is divided into two parts as shown in Figure 9. The device shall be positioned directly against the phantom surface with the strap straightened as much as possible and the back of the device towards the phantom.

If the strap cannot normally be opened to allow placing in direct contact with the phantom surface, it may be necessary to break the strap of the device but ensuring to not damage the antenna.



**Test position for limb-worn devices**

## 6.7. Tissue Dielectric Parameters

The liquid used for the frequency range of 100MHz-6G consisted of water, sugar, salt and Cellulose. The liquid has been previously proven to be suited for worst-case. The following Table shows the detail solution. It's satisfying the latest tissue dielectric parameters requirements proposed by the IEEE 1528 and IEC 62209. The simulating liquids should be checked at the beginning of a series of SAR measurements to determine of the determine of the dielectric parameter are within the tolerances of the specified target values. The measured conductivity and relative permittivity should be within  $\pm 5\%$  of the target values.

The following materials are used for producing the tissue-equivalent materials

Targets for tissue simulating liquid

Frequency (MHz)	Liquid Type	Liquid Type ( $\sigma$ )	$\pm 5\%$ Range	Permittivity ( $\epsilon$ )	$\pm 5\%$ Range
300	Head	0.87	0.83~0.91	45.3	43.04~47.57
450	Head	0.87	0.83~0.91	43.5	41.33~45.68
835	Head	0.90	0.86~0.95	41.5	39.43~43.58
900	Head	0.97	0.92~1.02	41.5	39.43~43.58
1800-2000	Head	1.40	1.33~1.47	40.0	38.00~42.00
2450	Head	1.80	1.71~1.89	39.2	37.24~41.16
2600	Head	1.96	1.86~2.06	39.0	37.05~40.95
3000	Head	2.40	2.28~2.52	38.5	36.58~40.43
5800	Head	5.27	5.01~5.53	35.3	33.54~37.07

( $\epsilon$  = relative permittivity,  $\sigma$  = conductivity and  $\rho = 1000 \text{ kg/m}^3$ )

**6.8. Tissue-equivalent Liquid Properties**

Test Date dd/mm/yy	Temp °C	Tissue Type	Measured Frequency ( MHz )	$\epsilon_r$	$\sigma$ (s/m)	Dev $\epsilon_r$ (%)	Dev $\sigma$ (%)
09/11/2024	22°C	750H	750	41.90	0.89	2.63	-1.12
09/13/2024	22°C	835H	825	41.43	0.86	-0.17	-4.44
			835	41.42	0.87	-0.19	-3.33
			850	40.39	0.88	-2.67	-2.22
09/18/2024	22°C	1800H	1710	39.11	1.34	-2.23	-4.29
			1720	39.10	1.35	-2.25	-3.57
			1750	39.08	1.37	-2.30	-2.14
			1800	39.07	1.38	-2.33	-1.43
09/20/2024	22°C	1900H	1850	39.11	1.34	-2.23	-4.29
			1880	39.10	1.35	-2.25	-3.57
			1900	39.08	1.37	-2.30	-2.14
			1910	39.07	1.38	-2.33	-1.43
09/23/2024	22°C	2450H	2410	37.84	1.79	-3.47	-0.56
			2435	37.85	1.81	-3.44	0.56
			2450	37.82	1.83	-3.52	1.67
			2460	37.80	1.84	-3.57	2.22
09/24/2024	22°C	2600H	20850	38.86	1.93	-0.36	-1.53
			21100	38.85	1.92	-0.39	-2.04
			21350	38.89	1.90	-0.28	-3.06
09/25/2024	22°C	3500H	3500	37.07	2.81	2.19	3.44
09/26/2024	22°C	3700H	3750	37.21	3.21	1.30	-2.88
09/27/2024	22°C	5200H	5200	36.68	4.45	-3.32	-4.04
09/28/2024	22°C	5300H	5300	36.08	4.69	2.16	-4.48
09/28/2024	22°C	5600H	5600	35.34	4.95	0.11	-1.21
09/28/2024	22°C	5800H	5800	34.81	5.08	-3.49	-4.14

### 6.9. System Check

The SAR system must be validated against its performance specifications before it is deployed. When SAR probe and system component or software are changed, upgraded or recalibrated, these must be validated with the SAR system(s) that operates with such component. Reference dipoles are used with the required tissue-equivalent media for system validation.

System check results have to be equal or near the values determined during dipole calibration with the relevant liquids and test system ( $\pm 10\%$ ).

System check is performed regularly on all frequency bands where tests are performed with the OPENSAR system.

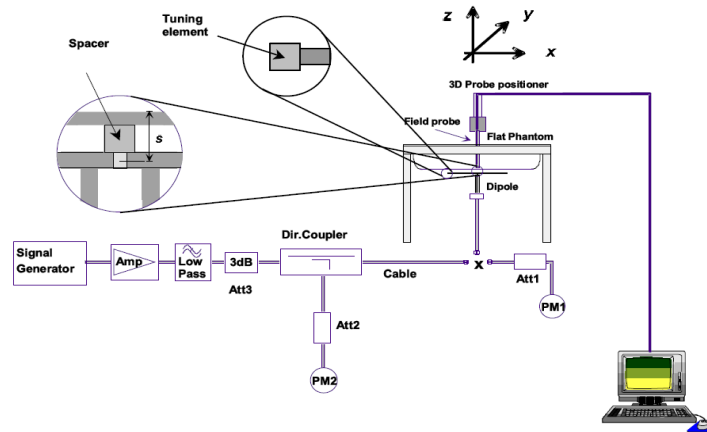

System Check Set-up

#### Verification Results

Frequency (MHz)	Liquid Type	Measured Value in 100mW (W/kg)		Normalized to 1W (W/kg)		Target Value (W/kg)		Deviation (%)	
		1 g Average	10 g Average	1 g Average	10 g Average	1 g Average	10 g Average	1 g Average	10 g Average
750	Head	0.80	0.56	8.00	5.60	8.31	5.71	-3.73	-1.93
835	Head	0.89	0.57	8.90	5.70	9.53	6.12	-6.61	-6.86
1800	Head	3.75	2.20	37.53	21.98	37.67	20.23	-0.37	8.65
1900	Head	3.58	1.90	35.80	19.00	39.26	20.49	-8.81	-7.27
2450	Head	4.99	2.36	49.90	23.60	53.26	24.15	-6.31	-2.28
2600	Head	5.41	2.43	54.14	24.30	54.31	24.14	-0.31	0.66
3500	Head	6.44	2.51	64.40	25.10	65.20	24.68	1.23	-1.67
3700	Head	6.49	2.49	64.90	24.90	66.45	24.42	2.33	-1.97
5200	Head	15.90	5.21	159.00	52.10	163.88	57.29	-2.98	-9.06
5300	Head	17.22	5.92	172.20	59.20	166.40	59.16	3.49	0.00
5600	Head	18.13	6.16	181.30	61.60	181.28	61.57	0.00	0.00
5800	Head	18.20	5.55	182.00	55.50	188.95	63.45	-3.68	-9.91

Comparing to the original SAR value provided by MVG, the verification data should be within its specification of 10%. Below table shows the target SAR and measured SAR after normalized to 1W input power. The table as below indicates the system performance check can meet the variation criterion and the plots can be referred to Section 10 of this report.

## 7. Measurement Procedure

### Conducted power measurement

For WWAN power measurement, use base station simulator to configure EUT WWAN transition in conducted connection with RF cable, at maximum power in each supported wireless interface and frequency band.

Read the WWAN RF power level from the base station simulator.

For WLAN/BT power measurement, use engineering software to configure EUT WLAN/BT continuously transmission, at maximum RF power in each supported wireless interface and frequency band.

Connect EUT RF port through RF cable to the power meter or spectrum analyser, and measure WLAN/BT output power.

### Conducted power measurement

Use base station simulator to configure EUT WWAN transmission in radiated connection, and engineering software to configure EUT WLAN/BT continuously transmission, at maximum RF power, in the highest power channel.

Place the EUT in positions as Appendix B demonstrates.

Set scan area, grid size and other setting on the MVG software.

Measure SAR results for the highest power channel on each testing position.

Find out the largest SAR result on these testing positions of each band.

Measure SAR results for other channels in worst SAR testing position if the Reported SAR or highest power channel is larger than 0.8 W/kg.

According to the test standard, the recommended procedure for assessing the peak spatial-average SAR value consists of the following steps:

Power reference measurement

Area scan

Zoom scan

Power drift measurement

### Spatial Peak SAR Evaluation

The procedure for spatial peak SAR evaluation has been implemented according to the test standard. It can be conducted for 1g and 10g, as well as for user-specific masses. The MVG software includes all numerical procedures necessary to evaluate the spatial peak SAR value.

The base for the evaluation is a “cube” measurement. The measured volume must include the 1g and 10g cubes with the highest averaged SAR values. For that purpose, the center of the measured volume is aligned to the interpolated peak SAR value of a previously performed area scan.

The entire evaluation of the spatial peak values is performed within the post-processing engine (SEMCAD). The system always gives the maximum values for 1g and 10g cubes. The algorithm to find the cube with highest averaged SAR is divided into the following stages:

Extraction of the measured data (grid and values) from the Zoom Scan.

Calculation of the SAR value at every measurement point based on all stored data (A/D values and measurement parameters).

Generation of a high-resolution mesh within the measured volume.

Interpolation of all measured values from the measurement grid to the high-resolution grid

Extrapolation of the entire 3-D field distribution to the phantom surface over the distance from sensor to surface

Calculation of the averaged SAR within masses of 1g and 10g.

### Power Reference Measurement

The Power Reference Measurement and Power Drift Measurement are for monitoring the power drift of the device under test in the batch process. The minimum distance of probe sensors to surface determines the closest measurement point to phantom surface. This distance cannot be smaller than the distance of sensor calibration points to probe tip as defined in the probe properties

### Area & Zoom Scan Procedures

First Area Scan is used to locate the approximate location(s) of the local peak SAR value(s). The measurement grid within an Area Scan is defined by the grid extent, grid step size and grid offset. Next, in order to determine the EM field distribution in a three-dimensional spatial extension, Zoom Scan is required. The Zoom Scan is performed around the highest E-field value to determine the averaged SAR-distribution over 10g. Area scan and zoom scan resolution setting follows KDB 865664 D01v01r03 quoted below.

		$\leq 3$ GHz	$> 3$ GHz	
Maximum distance from closest measurement point (geometric center of probe sensors) to phantom surface		5 mm $\pm$ 1 mm	$\frac{1}{2} \cdot \delta \cdot \ln(2)$ mm $\pm$ 0.5 mm	
Maximum probe angle from probe axis to phantom surface normal at the measurement location		30° $\pm$ 1°	20° $\pm$ 1°	
Maximum area scan spatial resolution: $\Delta x_{Area}$ , $\Delta y_{Area}$		$\leq 2$ GHz: $\leq 15$ mm 2 – 3 GHz: $\leq 12$ mm	3 – 4 GHz: $\leq 12$ mm 4 – 6 GHz: $\leq 10$ mm	
		When the x or y dimension of the test device, in the measurement plane orientation, is smaller than the above, the measurement resolution must be $\leq$ the corresponding x or y dimension of the test device with at least one measurement point on the test device.		
Maximum zoom scan spatial resolution: $\Delta x_{Zoom}$ , $\Delta y_{Zoom}$		$\leq 2$ GHz: $\leq 8$ mm 2 – 3 GHz: $\leq 5$ mm*	3 – 4 GHz: $\leq 5$ mm* 4 – 6 GHz: $\leq 4$ mm*	
Maximum zoom scan spatial resolution, normal to phantom surface	uniform grid: $\Delta z_{Zoom}(n)$	$\leq 5$ mm	3 – 4 GHz: $\leq 4$ mm 4 – 5 GHz: $\leq 3$ mm 5 – 6 GHz: $\leq 2$ mm	
	graded grid	$\Delta z_{Zoom}(1)$ : between 1 <sup>st</sup> two points closest to phantom surface	$\leq 4$ mm	3 – 4 GHz: $\leq 3$ mm 4 – 5 GHz: $\leq 2.5$ mm 5 – 6 GHz: $\leq 2$ mm
		$\Delta z_{Zoom}(n>1)$ : between subsequent points	$\leq 1.5 \cdot \Delta z_{Zoom}(n-1)$ mm	
Minimum zoom scan volume	x, y, z	$\geq 30$ mm	3 – 4 GHz: $\geq 28$ mm 4 – 5 GHz: $\geq 25$ mm 5 – 6 GHz: $\geq 22$ mm	
Note: $\delta$ is the penetration depth of a plane-wave at normal incidence to the tissue medium; see IEEE Std 1528-2013 for details.				
* When zoom scan is required and the <i>reported</i> SAR from the <i>area scan based 1-g SAR estimation</i> procedures of KDB Publication 447498 is $\leq 1.4$ W/kg, $\leq 8$ mm, $\leq 7$ mm and $\leq 5$ mm zoom scan resolution may be applied, respectively, for 2 GHz to 3 GHz, 3 GHz to 4 GHz and 4 GHz to 6 GHz.				

### Volume Scan Procedures

The volume scan is used for assess overlapping SAR distributions for antennas transmitting in different frequency bands. It is equivalent to an oversized zoom scan used in standalone measurements. The measurement volume will be used to enclose all the simultaneous transmitting antennas. For antennas transmitting simultaneously in different frequency bands, the volume scan is measured separately in each frequency band. In order to sum correctly to compute the 1g aggregate SAR, the EUT remain in the same test position for all measurements and all volume scan use the same spatial resolution and grid spacing. When all volume scan were completed, the software, SEMCAD post-processor scan combine and subsequently superpose these measurement data to calculating the multiband SAR.

**SAR Averaged Methods**

In MVG, the interpolation and extrapolation are both based on the modified Quadratic Shepard's method. The interpolation scheme combines a least-square fitted function method and a weighted average method which are the two basic types of computational interpolation and approximation.

Extrapolation routines are used to obtain SAR values between the lowest measurement points and the inner phantom surface. The extrapolation distance is determined by the surface detection distance and the probe sensor offset. The uncertainty increases with the extrapolation distance. To keep the uncertainty within 1% for the 1g and 10g cubes, the extrapolation distance should not be larger than 5 mm.

**Power Drift Monitoring**

All SAR testing is under the EUT install full charged battery and transmit maximum output power. In MVG measurement software, the power reference measurement and power drift measurement procedures are used for monitoring the power drift of EUT during SAR test. Both these procedures measure the field at a specified reference position before and after the SAR testing. The software will calculate the field difference in dB. If the power drifts more than 5%, the SAR will be retested.

**Power Drift measurement**

The drift job measures the field at the same location as the most recent reference job within the same procedure, and with the same settings. The drift measurement gives the field difference in dB from the reading conducted within the last reference measurement. Several drift measurements are possible for

**Measurement Uncertainty**

Per KDB 865664 D01 SAR Measurement 100KHz to 6GHz ,when the highest measurement 1-g SAR within a frequency band is  $<1.5\text{W/kg}$ , the extensive SAR measurement uncertainty analysis described IEEE Std 1528-2013 is not required in SAR report submitted for equipment approval.



## 8. Conducted Output Power

Band: GSM 850	Measured Power (dBm)			Calculation (dB)	Averaged Power (dBm)		
	Channel	128	190		251	128	190
Frequency	824.2	836.6	848.8		824.2	836.6	848.8
GSM (GMSK, Voice)	32.15	32.11	32.06	-9.03	<b>23.12</b>	23.08	23.03
GPRS (GMSK, 1-slot)	32.16	32.14	32.09	-9.03	23.13	23.11	23.06
GPRS (GMSK, 2-slot)	30.22	30.08	30.01	-6.02	<b>24.20</b>	24.06	23.99
GPRS (GMSK, 3-slot)	28.45	28.30	28.20	-4.26	24.19	24.04	23.94
GPRS (GMSK, 4-slot)	26.53	26.36	26.24	-3.01	23.52	23.35	23.23
EGPRS (1-slot)	24.50	27.43	27.31	-9.03	15.47	18.40	18.28
EGPRS (2-slot)	24.51	24.34	24.34	-6.02	18.49	18.32	18.32
EGPRS (3-slot)	23.08	23.08	22.93	-4.26	18.82	18.82	18.67
EGPRS (4-slot)	20.87	21.06	21.72	-3.01	17.86	18.05	18.71

Note:

- Division Factors  
To average the power, the division factor is as follows:  
1TX-slot = 1 transmit time slot out of 8 time slots=> conducted power divided by (8/1) => -9.03dB  
2TX-slots = 2 transmit time slots out of 8 time slots=> conducted power divided by (8/2) => -6.02dB  
3TX-slots = 3 transmit time slots out of 8 time slots=> conducted power divided by (8/3) => -4.26dB  
4TX-slots = 4 transmit time slots out of 8 time slots=> conducted power divided by (8/4) => -3.01dB
- According to the conducted power as above, the body measurements are performed with 1Tx slots for 850MHz for GPRS.
- The device do not support power reduction, so power of hotspot activated as the same as hotspot disabled

Band: GSM 1900 Channel Frequency	Measured Power (dBm)			Calculation (dB)	Averaged Power (dBm)		
	512	661	810		512	661	810
	1850.2	1880.0	1909.8		1850.2	1880.0	1909.8
GSM (GMSK, Voice)	28.37	28.25	28.11	-9.03	<b>19.34</b>	19.22	19.08
GPRS (GMSK, 1-slot)	28.59	28.57	28.50	-9.03	19.56	19.54	19.47
GPRS (GMSK, 2-slot)	26.38	26.27	26.28	-6.02	20.36	20.25	20.26
GPRS (GMSK, 3-slot)	24.95	24.87	24.87	-4.26	<b>20.69</b>	20.61	20.61
GPRS (GMSK, 4-slot)	23.00	22.93	22.94	-3.01	19.99	19.92	19.93
EGPRS (1-slot)	24.01	23.55	24.91	-9.03	14.98	14.52	15.88
EGPRS (2-slot)	23.67	23.37	23.13	-6.02	17.65	17.35	17.11
EGPRS (3-slot)	22.40	21.77	21.72	-4.26	18.14	17.51	17.46
EGPRS (4-slot)	20.08	19.53	19.27	-3.01	17.07	16.52	16.26

Note:

- Division Factors  
To average the power, the division factor is as follows:  
1TX-slot = 1 transmit time slot out of 8 time slots=> conducted power divided by (8/1) => -9.03dB  
2TX-slots = 2 transmit time slots out of 8 time slots=> conducted power divided by (8/2) => -6.02dB  
3TX-slots = 3 transmit time slots out of 8 time slots=> conducted power divided by (8/3) => -4.26dB  
4TX-slots = 4 transmit time slots out of 8 time slots=> conducted power divided by (8/4) => -3.01dB
- According to the conducted power as above, the body measurements are performed with 1Tx slots for 1900MHz for GPRS.
- The device do not support power reduction, so power of hotspot activated as the same as hotspot disabled

Band	WCDMA Band II			WCDMA Band V		
Channel	9262	9400	9538	4132	4182	4233
Frequency	1852.40	1880.00	1907.60	826.40	836.40	846.60
RMC 12.2Kbps	<b>21.27</b>	21.19	21.05	<b>21.31</b>	21.21	21.02
HSDPA Subtest-1	21.77	20.96	21.17	22.68	22.65	22.48
HSDPA Subtest-2	21.79	20.98	21.18	22.68	22.67	22.48
HSDPA Subtest-3	21.78	21.00	21.19	22.67	22.66	22.48
HSDPA Subtest-4	21.73	20.95	21.15	22.61	22.60	22.40
HSUPA Subtest-1	20.08	19.24	19.48	20.58	20.51	20.31
HSUPA Subtest-2	19.90	18.98	19.47	20.38	20.50	20.27
HSUPA Subtest-3	19.88	19.27	19.34	20.36	20.26	20.02
HSUPA Subtest-4	20.03	19.38	19.09	20.30	19.97	20.01
HSUPA Subtest-5	19.82	19.24	19.03	20.06	20.30	19.71
Band	WCDMA Band IV					
Channel	1312	1413	1513			
Frequency	1712.4	1732.6	1752.6			
RMC 12.2Kbps	20.32	<b>20.42</b>	20.05			
HSDPA Subtest-1	19.88	20.12	20.14			
HSDPA Subtest-2	19.95	20.14	20.17			
HSDPA Subtest-3	19.95	20.14	20.16			
HSDPA Subtest-4	19.91	20.12	20.11			
HSUPA Subtest-1	17.91	17.94	18.16			
HSUPA Subtest-2	17.85	17.69	17.90			
HSUPA Subtest-3	17.62	18.16	18.11			
HSUPA Subtest-4	18.05	18.15	17.91			
HSUPA Subtest-5	17.62	18.16	18.09			

Note:

1. According to the power listed above, the HSDPA and HSUPA were not determined for SAR testing.
2. The default test configuration is to measure SAR with an established radio link between the EUT and a communication test set using a 12.2kbps RMC(reference measurement channel) configuration in test loop mode
3. The device do not support power reduction, so power of hotspot activated as the same as hotspot disabled

WLAN 2.4G						
Mode	802.11b			802.11g		
Channel	1	6	11	1	6	11
Frequency	2412	2437	2462	2412	2437	2462
Average Power (dBm)	13.98	12.54	13.18	13.97	12.74	13.10
Mode	802.11n(HT20)			802.11n(HT40)		
Channel	1	6	11	3	6	9
Frequency	2412	2437	2462	2422	2437	2452
Average Power (dBm)	<b>14.24</b>	13.01	13.40	13.63	13.53	12.78

WLAN 5.2G						
Mode	IEEE 802.11a			IEEE 802.11n HT20		
Channel	36	40	48	36	40	48
Frequency	5180	5200	5240	5180	5200	5240
Average Power (dBm)	11.30	11.11	11.24	11.09	10.95	11.15
Mode	IEEE 802.11n HT40			IEEE 802.11ac VHT20		
Channel	38	46		36	40	48
Frequency	5190	5230		5180	5200	5240
Average Power (dBm)	10.60	10.91		11.10	11.08	11.19
Mode	IEEE 802.11ac VHT40			IEEE 802.11ac VHT80		
Channel	38	46		42		
Frequency	5190	5230		5210		
Average Power (dBm)	10.71	10.92		<b>11.44</b>		

WLAN 5.3G						
Mode	IEEE 802.11a			IEEE 802.11n HT20		
Channel	52	60	64	52	60	64
Frequency	5260	5280	5320	5260	5280	5320
Average Power (dBm)	<b>11.22</b>	10.78	10.27	11.14	10.81	10.17
Mode	IEEE 802.11n HT40		IEEE 802.11ac VHT20			
Channel	54	62	52	60	64	
Frequency	5270	5310	5260	5280	5320	
Average Power (dBm)	10.73	10.20	11.20	10.87	10.32	
Mode	IEEE 802.11ac VHT40		IEEE 802.11ac VHT80			
Channel	54	62	58			
Frequency	5270	5310	5290			
Average Power (dBm)	10.67	10.17	11.14			

WLAN 5.6G						
Mode	IEEE 802.11a			IEEE 802.11n HT20		
Channel	100	120	140	100	120	140
Frequency	5500	5600	5700	5500	5600	5700
Average Power (dBm)	9.05	10.87	<b>13.47</b>	9.07	10.87	13.35
Mode	IEEE 802.11n HT40			IEEE 802.11ac VHT20		
Channel	102	118	134	100	120	140
Frequency	5510	5590	5670	5500	5600	5700
Average Power (dBm)	9.03	9.40	12.84	9.02	10.82	13.24
Mode	IEEE 802.11ac VHT40			IEEE 802.11ac VHT80		
Channel	102	118	134	106	122	
Frequency	5510	5590	5670	5530	5610	
Average Power (dBm)	8.98	9.40	12.89	9.36	10.79	

WLAN 5.8G						
Mode	IEEE 802.11a			IEEE 802.11n HT20		
Channel	149	157	165	149	157	165
Frequency	5745	5785	5825	5745	5785	5825
Average Power (dBm)	<b>12.35</b>	11.10	10.67	12.35	11.41	10.81
Mode	IEEE 802.11n HT40		IEEE 802.11ac VHT20			
Channel	151	159	149	157	165	
Frequency	5755	5795	5745	5785	5825	
Average Power (dBm)	11.90	11.08	<b>12.41</b>	11.37	10.82	
Mode	IEEE 802.11ac VHT40		IEEE 802.11ac VHT80			
Channel	151	159	155			
Frequency	5755	5795	5775			
Average Power (dBm)	11.92	10.92	12.31			

**Note**

1. Per KDB 248227 D01 v02r02, choose the highest output power channel to test SAR and determine further SAR exclusion.
2. The output power of all data rate were prescan , just the worst case (the lowest data rate) of all mode were shown in report

Bluetooth						
Mode	GFSK			Pi/4DQPSK		
Channel	0	39	78	0	39	78
Frequency	2402	2441	2480	2402	2441	2480
Average Power (dBm)	7.80	5.64	6.44	8.34	6.61	7.06
Mode	8DPSK			BLE(1M)		
Channel	0	39	78	0	20	39
Frequency	2402	2441	2480	2402	2440	2480
Average Power (dBm)	<b>8.59</b>	6.84	7.29	<b>-0.06</b>	-2.24	-1.44
Mode	BLE(2M)					
Channel	0	20	39			
Frequency	2402	2440	2480			
Average Power (dBm)	-0.31	-2.26	-1.42			

Channel	Frequency (GHz)	Max. Tune-up Power (dBm)	Max. Power (mW)	Test distance (mm)	Result	Exclusion thresholds for 1-g SAR	Exclusion thresholds for 10-g SAR
0	2.402	-0.00	0.87	5	0.27	3.0	7.5

**Note**

- Per KDB 447498 D01v06, the 1-g SAR test exclusion thresholds for 100 MHz to 6 GHz at test separation distances  $\leq 50$  mm are determined by:  

$$[(\text{max. power of channel, including tune-up tolerance, mW}) / (\text{min. test separation distance, mm})] \cdot [\sqrt{f(\text{GHz})}] \leq 3.0$$
 for 1-g SAR, where  
 ·f(GHz) is the RF channel transmit frequency in GHz  
 ·Power and distance are rounded to the nearest mW and mm before calculation  
 ·The result is rounded to one decimal place for comparison
- Base on the result of note1, RF exposure evaluation of BLE is not required.
- Per KDB 248227 D01 v02r02, choose the highest output power channel to test SAR and determine further SAR exclusion.
- The output power of all data rate were prescan, just the worst case (the lowest data rate) of all mode were shown in report.

LTE Band 2

Conducted Power of LTE Band 2								
Bandwidth	Modulation	RB size	RB offset	Channel	Channel	Channel		
				18607	18900	19193		
1.4MHz	QPSK	1	0	21.25	21.22	20.61		
			2	21.13	21.21	20.66		
			5	21.18	21.18	20.74		
		3	0	21.16	21.16	20.88		
			2	21.15	21.16	20.90		
			3	21.15	21.20	20.86		
	6	0	20.18	20.15	19.91			
		16QAM	1	0	20.59	20.09	20.70	
				2	20.59	19.95	20.70	
	5			20.63	20.06	20.79		
	3	0	20.39	20.08	20.13			
		2	20.39	19.97	20.19			
		3	20.29	19.93	20.12			
	6	0	19.57	19.18	19.33			
		Bandwidth	Modulation	RB size	RB offset	Channel	Channel	Channel
						18615	18900	19185
	3MHz	QPSK	1	0	21.40	21.08	20.97	
				7	21.41	21.12	20.96	
14				21.37	21.04	20.74		
8			0	20.32	20.17	19.93		
			4	20.31	20.20	19.94		
			7	20.33	20.14	19.91		
15		0	20.37	20.15	19.95			
		16QAM	1	0	20.23	20.70	20.32	
				7	20.14	20.68	20.38	
14				20.22	20.74	20.44		
8		0	19.67	19.39	19.34			
		4	19.67	19.44	19.34			
		7	19.66	19.44	19.37			
15		0	19.56	19.32	19.18			



**Conducted Power of LTE Band 2**

Bandwidth	Modulation	RB size	RB offset	Channel	Channel	Channel		
				18625	18900	19175		
5MHz	QPSK	1	0	21.22	21.04	21.00		
			13	21.29	21.08	21.03		
			24	21.29	21.01	21.00		
		12	0	20.23	20.17	20.00		
			6	20.24	20.14	19.99		
			13	20.23	20.11	20.05		
		25	0	20.20	20.07	19.98		
		16QAM	1	0	19.79	19.89	20.04	
				13	19.75	19.93	20.00	
	24			19.74	19.87	20.05		
	12		0	19.42	19.24	19.20		
			6	19.43	19.23	19.20		
			13	19.43	19.20	19.12		
	25		0	19.50	19.24	19.16		
	Bandwidth		Modulation	RB size	RB offset	Channel	Channel	Channel
	10MHz		QPSK	1	0	21.51	20.92	20.87
		25			21.33	20.91	20.78	
		49			21.40	20.95	20.80	
25		0		20.27	20.11	19.93		
		13		20.25	20.04	19.96		
		25		20.24	20.06	19.97		
50		0		20.29	20.09	19.99		
16QAM		1		0	20.06	20.90	20.56	
				25	20.05	20.87	20.40	
			49	20.05	20.90	20.45		
		25	0	19.52	19.20	19.17		
			13	19.54	19.23	19.08		
			25	19.46	19.32	19.20		
		50	0	19.44	19.24	19.13		
		Bandwidth	Modulation	RB size	RB offset	Channel	Channel	Channel
		10MHz	QPSK	1	0	21.51	20.92	20.87
25					21.33	20.91	20.78	
49					21.40	20.95	20.80	
25	0			20.27	20.11	19.93		
	13			20.25	20.04	19.96		
	25			20.24	20.06	19.97		
50	0			20.29	20.09	19.99		
16QAM	1			0	20.06	20.90	20.56	
				25	20.05	20.87	20.40	
			49	20.05	20.90	20.45		
	25		0	19.52	19.20	19.17		
			13	19.54	19.23	19.08		
			25	19.46	19.32	19.20		
	50		0	19.44	19.24	19.13		

**Conducted Power of LTE Band 2**

Bandwidth	Modulation	RB size	RB offset	Channel	Channel	Channel		
				18675	18900	19125		
15MHz	QPSK	1	0	20.93	21.01	20.87		
			38	21.07	21.07	20.75		
			74	21.07	21.09	20.78		
		36	0	20.12	19.96	19.94		
			18	20.10	19.98	19.90		
			39	20.02	19.94	19.85		
		75	0	20.07	19.86	19.90		
		16QAM	1	0	20.30	20.39	20.52	
				38	20.41	20.33	20.39	
	74			20.43	20.35	20.41		
	36		0	19.35	19.11	19.14		
			18	19.37	19.08	19.07		
			39	19.35	19.11	19.16		
	75		0	19.32	19.10	19.12		
	Bandwidth		Modulation	RB size	RB offset	Channel	Channel	Channel
						18700	18900	19100
	20MHz	QPSK	1	0	21.04	21.15	20.76	
				50	<b>21.18</b>	20.92	20.70	
99				21.03	20.90	20.68		
50			0	<b>20.17</b>	19.96	19.94		
			25	20.08	20.04	19.83		
			50	20.03	19.99	19.82		
100			0	20.16	19.98	19.82		
16QAM			1	0	20.12	20.70	20.39	
				50	20.16	20.54	20.29	
		99		20.01	20.68	20.17		
		50	0	19.33	19.13	19.14		
			25	19.31	19.14	19.10		
			50	19.28	19.17	19.06		
		100	0	19.30	19.19	19.07		

**LTE Band 4**

Conducted Power of LTE Band 4							
Bandwidth	Modulation	RB size	RB offset	Channel	Channel	Channel	
				19957	20175	20393	
1.4MHz	QPSK	1	0	20.46	20.36	20.55	
			2	20.46	20.36	20.52	
			5	20.39	20.41	20.50	
		3	0	20.34	20.43	20.60	
			2	20.36	20.51	20.60	
			3	20.27	20.39	20.59	
	16QAM	1	0	19.12	19.93	20.02	
			2	19.15	19.97	19.99	
			5	19.19	19.92	19.97	
		3	0	19.40	19.65	19.82	
			2	19.35	19.70	19.78	
			3	19.28	19.71	19.76	
	6	0	18.58	18.72	18.78		
	Bandwidth	Modulation	RB size	RB offset	Channel	Channel	Channel
					19965	20175	20385
	3MHz	QPSK	1	0	20.49	20.26	20.58
				7	20.47	20.33	20.57
				14	20.38	20.28	20.55
8			0	19.32	19.42	19.56	
			4	19.39	19.40	19.54	
			7	19.36	19.36	19.47	
15		0	19.32	19.44	19.49		
16QAM		1	0	19.51	20.36	20.07	
			7	19.38	20.40	19.98	
			14	19.47	20.49	20.04	
		8	0	18.80	18.83	18.96	
			4	18.76	18.82	19.07	
			7	18.67	18.75	18.97	
		15	0	18.50	18.64	18.89	

**Conducted Power of LTE Band 4**

Bandwidth	Modulation	RB size	RB offset	Channel	Channel	Channel		
				19975	20175	20375		
5MHz	QPSK	1	0	20.20	20.40	20.68		
			13	20.14	20.42	20.65		
			24	19.99	20.40	20.59		
		12	0	19.34	19.48	19.63		
			6	19.35	19.48	19.63		
			13	19.28	19.45	19.58		
	25	0	19.33	19.43	19.60			
	16QAM	1	0	19.33	19.39	18.88		
			13	19.34	19.41	18.92		
			24	19.24	19.32	18.88		
		12	0	18.57	18.73	18.80		
			6	18.58	18.71	18.88		
			13	18.54	18.73	18.80		
		25	0	18.63	18.64	18.88		
		Bandwidth	Modulation	RB size	RB offset	Channel	Channel	Channel
10MHz		QPSK	1	0	20.46	20.29	20.54	
	25			20.36	20.30	20.47		
	49			20.34	20.38	20.54		
	25		0	19.32	19.45	19.51		
			13	19.33	19.42	19.54		
			25	19.39	19.43	19.61		
	50		0	19.29	19.42	19.54		
	16QAM		1	0	19.45	19.80	19.96	
				25	19.37	19.90	19.91	
		49		19.35	19.99	19.91		
		25	0	18.75	18.66	18.78		
			13	18.71	18.62	18.75		
			25	18.75	18.66	18.78		
		50	0	18.58	18.66	18.74		
		Bandwidth	Modulation	RB size	RB offset	Channel	Channel	Channel
		10MHz	QPSK	1	0	20.46	20.29	20.54
	25				20.36	20.30	20.47	
	49				20.34	20.38	20.54	
25	0			19.32	19.45	19.51		
	13			19.33	19.42	19.54		
	25			19.39	19.43	19.61		
50	0			19.29	19.42	19.54		
16QAM	1			0	19.45	19.80	19.96	
				25	19.37	19.90	19.91	
			49	19.35	19.99	19.91		
	25		0	18.75	18.66	18.78		
			13	18.71	18.62	18.75		
			25	18.75	18.66	18.78		
	50		0	18.58	18.66	18.74		

**Conducted Power of LTE Band 4**

Bandwidth	Modulation	RB size	RB offset	Channel	Channel	Channel		
				20025	20175	20325		
15MHz	QPSK	1	0	20.57	20.21	20.34		
			38	20.55	20.32	20.37		
			74	20.53	20.37	20.43		
		36	0	19.26	19.35	19.53		
			18	19.31	19.40	19.54		
			39	19.33	19.50	19.61		
	75	0	19.30	19.45	19.58			
	16QAM	1	0	19.77	20.18	20.09		
			38	19.72	20.43	20.14		
			74	19.65	20.54	20.09		
		36	0	18.45	18.52	18.70		
			18	18.56	18.53	18.81		
			39	18.47	18.60	18.84		
	75	0	18.55	18.63	18.72			
Bandwidth	Modulation	RB size	RB offset	Channel	Channel	Channel		
20MHz	QPSK	1	0	20.21	20.32	20.45		
			50	20.15	20.42	<b>20.54</b>		
			99	20.19	20.46	20.44		
		50	0	19.37	19.40	19.54		
			25	19.34	19.48	<b>19.57</b>		
			50	19.33	19.49	19.54		
		100	0	19.33	19.47	19.51		
		16QAM	1	0	19.76	19.33	20.33	
				50	19.61	19.43	20.37	
	99			19.67	19.49	20.37		
	50		0	18.67	18.67	18.78		
			25	18.64	18.68	18.74		
			50	18.59	18.74	18.73		
	100		0	18.53	18.61	18.82		
	Bandwidth		Modulation	RB size	RB offset	Channel	Channel	Channel
	20MHz		QPSK	1	0	20.21	20.32	20.45
		50			20.15	20.42	<b>20.54</b>	
		99			20.19	20.46	20.44	
50		0		19.37	19.40	19.54		
		25		19.34	19.48	<b>19.57</b>		
		50		19.33	19.49	19.54		
100		0		19.33	19.47	19.51		
16QAM		1		0	19.76	19.33	20.33	
				50	19.61	19.43	20.37	
			99	19.67	19.49	20.37		
		50	0	18.67	18.67	18.78		
			25	18.64	18.68	18.74		
			50	18.59	18.74	18.73		
		100	0	18.53	18.61	18.82		

**LTE Band 5**

Conducted Power of LTE Band 5						
Bandwidth	Modulation	RB size	RB offset	Channel	Channel	Channel
				20407	20525	20643
1.4MHz	QPSK	1	0	21.90	21.82	21.67
			2	21.93	21.85	21.69
			5	21.85	21.85	21.69
		3	0	22.00	21.95	21.87
			2	22.04	21.92	21.86
			3	21.98	21.93	21.84
	6	0	20.92	20.86	20.90	
	16QAM	1	0	21.32	20.71	21.63
			2	21.31	20.72	21.68
			5	21.30	20.76	21.68
		3	0	21.04	20.99	20.76
			2	21.09	20.80	20.73
3			21.05	20.84	20.68	
6	0	20.08	20.06	19.81		
Bandwidth	Modulation	RB size	RB offset	Channel	Channel	Channel
				20415	20525	20635
3MHz	QPSK	1	0	21.91	21.71	21.62
			7	21.93	21.77	21.57
			14	21.93	21.63	21.52
		8	0	20.96	20.89	20.81
			4	20.99	20.83	20.76
			7	21.01	20.85	20.80
	15	0	20.94	20.83	20.78	
	16QAM	1	0	20.96	21.29	21.33
			7	20.86	21.15	21.23
			14	20.97	21.25	21.13
		8	0	20.26	19.96	20.11
			4	20.30	19.95	20.04
			7	20.21	19.96	20.05
	15	0	20.00	19.86	19.94	

**Conducted Power of LTE Band 5**

Bandwidth	Modulation	RB size	RB offset	Channel	Channel	Channel		
				20425	20525	20625		
5MHz	QPSK	1	0	21.86	21.87	21.91		
			13	21.78	21.80	21.91		
			24	21.72	21.78	21.77		
		12	0	20.93	20.93	20.89		
			6	20.92	20.84	20.81		
			13	20.88	20.81	20.78		
	25	0	20.95	20.87	20.84			
	16QAM	1	0	20.86	20.77	20.09		
			13	20.78	20.67	20.01		
			24	20.78	20.67	19.96		
		12	0	20.01	19.86	19.93		
			6	20.00	19.84	19.90		
			13	20.01	19.78	19.88		
		25	0	20.08	19.80	19.96		
Bandwidth		Modulation	RB size	RB offset	Channel	Channel	Channel	
10MHz	QPSK	1	0	<b>21.94</b>	21.69	21.71		
			25	21.91	21.66	21.67		
			49	21.82	21.61	21.65		
		25	0	<b>20.85</b>	20.81	20.76		
			13	20.81	20.74	20.67		
			25	20.82	20.68	20.68		
		50	0	20.85	20.84	20.78		
		16QAM	1	0	20.67	21.78	21.11	
				25	20.59	21.75	21.03	
	49			20.53	21.67	20.99		
	25		0	20.11	19.91	19.96		
			13	20.09	19.93	19.94		
			25	20.06	19.84	19.89		
	50		0	19.97	19.89	19.88		
	Bandwidth		Modulation	RB size	RB offset	Channel	Channel	Channel
	10MHz		QPSK	1	0	<b>21.94</b>	21.69	21.71
		25			21.91	21.66	21.67	
		49			21.82	21.61	21.65	
25		0		<b>20.85</b>	20.81	20.76		
		13		20.81	20.74	20.67		
		25		20.82	20.68	20.68		
50		0		20.85	20.84	20.78		
16QAM		1		0	20.67	21.78	21.11	
				25	20.59	21.75	21.03	
			49	20.53	21.67	20.99		
		25	0	20.11	19.91	19.96		
			13	20.09	19.93	19.94		
			25	20.06	19.84	19.89		
		50	0	19.97	19.89	19.88		

**LTE Band 7**

Conducted Power of LTE Band 7								
Bandwidth	Modulation	RB size	RB offset	Channel	Channel	Channel		
				20775	21100	21425		
5MHz	QPSK	1	0	20.92	21.08	20.96		
			12	21.02	21.08	20.92		
			24	21.02	21.16	20.43		
		12	0	19.98	20.24	18.81		
			6	19.97	20.25	18.80		
			13	19.96	20.25	18.77		
		25	0	19.97	20.27	18.81		
		16QAM	1	0	19.92	19.72	18.46	
				12	19.97	19.79	18.52	
	24			19.96	19.80	18.56		
	12		0	19.01	19.38	18.20		
			6	19.06	19.45	18.15		
			13	18.98	19.41	17.95		
	25	0	19.03	19.45	18.54			
	Bandwidth	Modulation	RB size	RB offset	Channel	Channel	Channel	
10MHz	QPSK	1	0	20.97	21.01	21.56		
			24	21.07	21.15	21.45		
			49	21.11	21.24	19.83		
		25	0	20.01	20.24	18.82		
			12	19.98	20.31	18.85		
			25	19.97	20.35	18.76		
		50	0	20.05	20.28	18.85		
		16QAM	1	0	19.77	21.04	19.07	
				24	19.79	21.24	19.14	
	49			19.79	21.32	19.08		
	25		0	19.25	19.40	18.65		
			12	19.24	19.48	19.55		
			25	19.24	19.47	18.01		
	50		0	19.22	19.47	18.16		
	Bandwidth		Modulation	RB size	RB offset	Channel	Channel	Channel
	10MHz		QPSK	1	0	20.97	21.01	21.56
		24			21.07	21.15	21.45	
		49			21.11	21.24	19.83	
25		0		20.01	20.24	18.82		
		12		19.98	20.31	18.85		
		25		19.97	20.35	18.76		
50		0		20.05	20.28	18.85		
16QAM		1		0	19.77	21.04	19.07	
				24	19.79	21.24	19.14	
			49	19.79	21.32	19.08		
		25	0	19.25	19.40	18.65		
			12	19.24	19.48	19.55		
			25	19.24	19.47	18.01		
		50	0	19.22	19.47	18.16		



**Conducted Power of LTE Band 7**

Bandwidth	Modulation	RB size	RB offset	Channel	Channel	Channel		
				20825	21100	21375		
15MHz	QPSK	1	0	20.81	21.04	21.48		
			38	20.89	21.16	21.62		
			74	20.95	21.24	19.81		
		38	0	20.03	20.23	18.84		
			18	20.01	20.32	20.64		
			37	19.99	20.31	18.70		
	75	0	20.02	20.32	18.80			
	16QAM	1	0	20.15	20.56	19.00		
			38	20.22	20.78	19.08		
			74	20.22	20.83	19.06		
		38	0	19.24	19.37	17.35		
			18	19.22	19.48	17.46		
			37	19.21	19.47	17.38		
	75	0	19.16	19.49	17.07			
Bandwidth	Modulation	RB size	RB offset	Channel	Channel	Channel		
20MHz	QPSK	1	0	20.89	20.99	21.51		
			49	21.07	21.21	<b>21.68</b>		
			99	21.09	21.32	20.12		
		50	0	19.80	20.05	20.50		
			25	19.86	20.17	<b>20.64</b>		
			50	19.83	20.23	20.57		
		100	0	19.78	20.19	18.72		
		16QAM	1	0	19.82	19.97	21.01	
				49	19.91	20.23	21.06	
	99			19.85	20.25	20.39		
	50		0	18.87	19.29	18.56		
			25	19.04	19.41	19.74		
			50	19.06	19.44	19.72		
	100		0	19.05	19.35	19.79		
	Bandwidth		Modulation	RB size	RB offset	Channel	Channel	Channel
	20MHz		QPSK	1	0	20.89	20.99	21.51
		49			21.07	21.21	<b>21.68</b>	
		99			21.09	21.32	20.12	
50		0		19.80	20.05	20.50		
		25		19.86	20.17	<b>20.64</b>		
		50		19.83	20.23	20.57		
100		0		19.78	20.19	18.72		
16QAM		1		0	19.82	19.97	21.01	
				49	19.91	20.23	21.06	
			99	19.85	20.25	20.39		
		50	0	18.87	19.29	18.56		
			25	19.04	19.41	19.74		
			50	19.06	19.44	19.72		
		100	0	19.05	19.35	19.79		

**LTE Band 12**

Conducted Power of LTE Band 12						
Bandwidth	Modulation	RB size	RB offset	Channel	Channel	Channel
				23017	23095	23173
1.4MHz	QPSK	1	0	21.72	21.64	21.78
			2	21.88	21.71	21.72
			5	21.80	21.65	21.69
		3	0	21.80	21.72	21.66
			2	21.75	21.80	21.64
			3	21.67	21.73	21.54
	6	0	20.71	20.78	20.57	
	16QAM	1	0	20.36	21.58	20.24
			2	20.36	21.49	20.26
			5	20.39	21.44	20.19
		3	0	20.53	20.67	20.33
			2	20.50	20.67	20.38
3			20.50	20.58	20.19	
6	0	19.72	19.74	19.46		
Bandwidth	Modulation	RB size	RB offset	Channel	Channel	Channel
				23025	23095	23165
3MHz	QPSK	1	0	21.74	21.52	21.42
			7	21.76	21.72	21.35
			14	21.68	21.42	21.33
		8	0	20.66	20.49	20.42
			4	20.67	20.49	20.45
			7	20.70	20.49	20.45
	15	0	20.59	20.40	20.39	
	16QAM	1	0	20.50	20.93	20.89
			7	20.44	20.92	20.81
			14	20.53	20.93	20.76
		8	0	19.82	19.65	19.68
			4	19.79	19.72	19.68
			7	19.75	19.67	19.72
	15	0	19.55	19.59	19.61	

**Conducted Power of LTE Band 12**

Bandwidth	Modulation	RB size	RB offset	Channel	Channel	Channel		
				23035	23095	23155		
5MHz	QPSK	1	0	21.60	21.57	21.49		
			13	21.55	21.58	21.46		
			24	21.56	21.64	21.41		
		12	0	20.69	20.59	20.64		
			6	20.65	20.62	20.57		
			13	20.60	20.58	20.56		
	25	0	20.75	20.71	20.64			
	16QAM	1	0	20.62	20.59	20.13		
			13	20.57	20.60	20.00		
			24	20.56	20.62	20.03		
		12	0	19.82	19.78	19.77		
			6	19.81	19.85	19.73		
			13	19.71	19.84	19.69		
	25	0	19.82	19.72	19.78			
Bandwidth	Modulation	RB size	RB offset	Channel	Channel	Channel		
10MHz	QPSK	1	0	21.13	21.02	21.18		
			25	21.06	21.08	<b>21.24</b>		
			49	21.12	21.10	21.08		
		25	0	20.44	20.40	20.37		
			13	20.43	20.42	<b>20.43</b>		
			25	20.47	20.58	20.40		
		50	0	20.65	20.66	20.68		
		16QAM	1	0	20.60	21.48	20.88	
				25	20.51	21.56	20.91	
	49			20.58	21.54	20.79		
	25		0	19.82	19.75	19.70		
			13	19.84	19.77	19.71		
			25	19.88	19.81	19.60		
	50		0	19.76	19.74	19.69		
	Bandwidth		Modulation	RB size	RB offset	Channel	Channel	Channel
	10MHz		QPSK	1	0	21.13	21.02	21.18
		25			21.06	21.08	<b>21.24</b>	
		49			21.12	21.10	21.08	
25		0		20.44	20.40	20.37		
		13		20.43	20.42	<b>20.43</b>		
		25		20.47	20.58	20.40		
50		0		20.65	20.66	20.68		
16QAM		1		0	20.60	21.48	20.88	
				25	20.51	21.56	20.91	
			49	20.58	21.54	20.79		
		25	0	19.82	19.75	19.70		
			13	19.84	19.77	19.71		
			25	19.88	19.81	19.60		
		50	0	19.76	19.74	19.69		

**LTE Band 13**

Conducted Power of LTE Band 13						
Bandwidth	Modulation	RB size	RB offset	Channel	Channel	Channel
				23205	23230	23255
5MHz	QPSK	1	0	21.73	21.86	21.75
			13	21.73	21.89	21.75
			24	21.73	21.90	21.72
		12	0	20.88	20.90	20.81
			6	20.82	20.86	20.87
			13	20.81	20.85	20.87
	25	0	21.11	21.11	21.12	
	16QAM	1	0	21.01	20.33	20.99
			13	20.98	20.31	20.99
			24	20.91	20.26	20.99
		12	0	20.08	20.20	20.12
			6	20.08	20.17	20.18
			13	20.03	20.20	20.17
	25	0	20.06	20.18	20.20	
Bandwidth	Modulation	RB size	RB offset	Channel		
				23230		
10MHz	QPSK	1	0	21.81		
			25	21.83		
			49	<b>21.87</b>		
		25	0	<b>20.98</b>		
			13	20.95		
			25	20.93		
	50	0	21.12			
	16QAM	1	0	21.44		
			25	21.40		
			49	21.51		
		25	0	20.14		
			13	20.12		
			25	20.21		
	50	0	20.15			

**LTE Band 17**

Conducted Power of LTE Band 17								
Bandwidth	Modulation	RB size	RB offset	Channel	Channel	Channel		
				23755	23790	23825		
5MHz	QPSK	1	0	21.78	21.65	21.68		
			13	21.76	21.74	21.65		
			24	21.70	21.70	21.65		
		12	0	20.85	20.70	20.77		
			6	20.83	20.83	20.71		
			13	20.82	20.74	20.68		
		25	0	20.84	20.77	20.73		
		16QAM	1	0	20.25	20.36	20.60	
				13	20.14	20.40	20.54	
	24			20.12	20.33	20.52		
	12		0	19.82	19.67	19.86		
			6	19.85	19.68	19.84		
			13	19.81	19.59	19.80		
	25	0	19.78	19.73	19.75			
	Bandwidth	Modulation	RB size	RB offset	Channel	Channel	Channel	
10MHz	QPSK	1	0	<b>21.93</b>	21.75	21.81		
			25	21.90	21.77	21.82		
			49	21.91	21.66	21.70		
		25	0	20.80	20.76	20.73		
			13	20.82	20.81	20.78		
			25	<b>20.85</b>	20.74	20.74		
		50	0	20.78	20.84	20.81		
		16QAM	1	0	20.52	21.07	21.00	
				25	20.46	21.17	21.03	
	49			20.45	21.05	20.89		
	25		0	19.91	19.81	19.81		
			13	19.87	19.84	19.87		
			25	19.90	19.80	19.76		
	50		0	19.80	19.89	19.88		
	Bandwidth		Modulation	RB size	RB offset	Channel	Channel	Channel
						23780	23790	23800

LTE Band 25

Conducted Power of LTE Band 25								
Bandwidth	Modulation	RB size	RB offset	Channel	Channel	Channel		
				26047	26365	26683		
1.4MHz	QPSK	1	0	20.78	21.88	21.85		
			2	21.87	21.90	21.84		
			5	21.79	21.86	21.79		
		3	0	21.92	21.85	21.78		
			2	21.94	21.91	21.82		
			3	21.84	21.86	21.77		
		6	0	20.84	20.82	20.76		
		16QAM	1	0	21.21	20.94	20.90	
				2	21.22	20.97	20.88	
	5			21.23	20.94	20.84		
	3		0	21.09	20.98	20.90		
			2	21.09	20.95	20.90		
			3	21.06	20.86	20.76		
	6		0	20.11	20.16	20.14		
	Bandwidth		Modulation	RB size	RB offset	Channel	Channel	Channel
						26055	26365	26675
	3MHz	QPSK	1	0	22.06	21.70	21.74	
				7	22.08	21.76	21.78	
14				22.02	21.67	21.72		
8			0	20.94	20.90	20.78		
			4	20.92	20.90	20.77		
			7	20.89	20.81	20.74		
15			0	20.91	20.84	20.74		
16QAM			1	0	20.87	21.33	21.23	
				7	20.76	21.37	21.15	
		14		20.81	21.36	21.12		
		8	0	20.31	20.02	20.16		
			4	20.27	20.12	20.15		
			7	20.32	20.05	20.06		
		15	0	20.18	19.97	20.02		

**Conducted Power of LTE Band 25**

Bandwidth	Modulation	RB size	RB offset	Channel	Channel	Channel		
				26065	26365	26665		
5MHz	QPSK	1	0	21.72	21.91	21.79		
			13	21.76	21.97	21.87		
			24	21.83	21.98	21.80		
		12	0	21.03	21.00	20.89		
			6	21.01	21.00	20.90		
			13	20.99	20.98	20.84		
	25	0	21.00	20.97	20.84			
	16QAM	1	0	20.99	21.01	20.15		
			13	21.02	21.04	20.17		
			24	21.03	20.98	20.14		
		12	0	20.23	20.06	20.02		
			6	20.21	20.01	20.03		
			13	20.26	20.10	20.00		
		25	0	20.35	20.03	20.09		
		Bandwidth	Modulation	RB size	RB offset	Channel	Channel	Channel
10MHz		QPSK	1	0	22.02	21.76	21.63	
	25			22.18	21.78	21.64		
	49			22.18	21.72	21.63		
	25		0	21.03	20.93	20.82		
			13	21.08	21.01	20.84		
			25	21.06	20.93	20.80		
	50		0	21.03	20.95	20.87		
	16QAM		1	0	20.80	21.35	21.26	
				25	20.84	21.42	21.32	
		49		20.84	21.39	21.35		
		25	0	20.35	20.15	20.05		
			13	20.37	20.14	20.05		
			25	20.36	20.10	20.01		
		50	0	20.30	20.14	20.09		
		Bandwidth	Modulation	RB size	RB offset	Channel	Channel	Channel
		10MHz	QPSK	1	0	22.02	21.76	21.63
	25				22.18	21.78	21.64	
	49				22.18	21.72	21.63	
25	0			21.03	20.93	20.82		
	13			21.08	21.01	20.84		
	25			21.06	20.93	20.80		
50	0			21.03	20.95	20.87		
16QAM	1			0	20.80	21.35	21.26	
				25	20.84	21.42	21.32	
			49	20.84	21.39	21.35		
	25		0	20.35	20.15	20.05		
			13	20.37	20.14	20.05		
			25	20.36	20.10	20.01		
	50		0	20.30	20.14	20.09		

**Conducted Power of LTE Band 25**

Bandwidth	Modulation	RB size	RB offset	Channel	Channel	Channel		
				26115	26365	26615		
15MHz	QPSK	1	0	22.12	21.75	21.62		
			38	22.30	21.74	21.64		
			74	22.28	21.84	21.63		
		36	0	21.02	20.98	20.77		
			18	21.06	21.00	20.78		
			39	21.02	20.92	20.78		
	75	0	21.03	20.95	20.88			
	16QAM	1	0	21.43	21.72	21.38		
			38	21.62	21.76	21.23		
			74	21.53	21.98	21.32		
		36	0	20.26	20.05	20.01		
			18	20.27	20.06	20.07		
			39	20.25	20.04	19.97		
	75	0	20.24	20.15	20.08			
Bandwidth	Modulation	RB size	RB offset	Channel	Channel	Channel		
20MHz	QPSK	1	0	21.88	21.69	21.99		
			50	<b>21.99</b>	21.78	21.82		
			99	21.88	21.81	21.87		
		50	0	<b>21.04</b>	20.98	20.82		
			25	21.02	21.00	20.78		
			50	20.95	20.89	20.82		
		100	0	21.05	21.00	20.90		
		16QAM	1	0	21.65	21.23	20.97	
				50	21.94	21.26	20.84	
	99			21.70	21.38	20.82		
	50		0	20.30	20.25	20.11		
			25	20.29	20.23	20.11		
			50	20.25	20.25	20.07		
	100		0	20.38	20.12	20.06		
	Bandwidth		Modulation	RB size	RB offset	Channel	Channel	Channel
						26140	26365	26590



**LTE Band 26-1**

Conducted Power of LTE Band 26								
Bandwidth	Modulation	RB size	RB offset	Channel	Channel	Channel		
				26697	26740	26783		
1.4MHz	QPSK	1	0	21.86	21.95	21.11		
			2	21.96	21.95	21.11		
			5	21.87	21.19	21.19		
		3	0	21.98	21.17	21.16		
			2	21.95	21.25	21.24		
			3	21.94	21.26	21.18		
		6	0	20.63	20.21	20.20		
		16QAM	1	0	20.61	20.02	20.99	
				2	20.59	19.99	20.99	
	5			20.55	20.10	21.01		
	3		0	20.32	20.31	20.07		
			2	20.36	20.19	20.08		
			3	20.37	20.16	20.02		
	6		0	19.37	19.42	19.16		
	Bandwidth		Modulation	RB size	RB offset	Channel	Channel	Channel
						26705	26740	26775
	3MHz	QPSK	1	0	21.40	21.14	21.11	
				7	21.33	21.16	21.09	
14				21.33	21.11	21.02		
8			0	20.24	20.17	20.13		
			4	20.22	20.21	20.14		
			7	20.25	20.13	20.12		
15			0	20.19	20.14	20.13		
16QAM			1	0	19.94	21.01	20.65	
				7	19.85	20.96	20.52	
		14		19.89	21.07	20.54		
		8	0	19.41	19.36	19.36		
			4	19.44	19.37	19.38		
			7	19.38	19.38	19.37		
		15	0	19.28	19.30	19.21		

**Conducted Power of LTE Band 26**

Bandwidth	Modulation	RB size	RB offset	Channel	Channel	Channel		
				26715	26740	26765		
5MHz	QPSK	1	0	20.73	20.74	20.98		
			13	20.75	20.77	20.91		
			24	20.73	20.75	20.85		
		12	0	20.22	20.17	20.22		
			6	20.21	20.13	20.16		
			13	20.17	20.12	20.15		
		25	0	20.17	20.15	20.16		
		16QAM	1	0	20.03	20.02	19.37	
				13	20.01	20.02	19.31	
	24			19.94	19.93	19.32		
	12		0	19.27	19.32	19.28		
			6	19.24	19.30	19.17		
			13	19.17	19.28	19.19		
	25		0	19.29	19.21	19.24		
	Bandwidth		Modulation	RB size	RB offset	Channel		
						26740		
	10MHz	QPSK	1	0	20.77			
				25	<b>20.85</b>			
49				20.59				
25			0	<b>19.81</b>				
			13	19.79				
			25	19.74				
50			0	20.06				
16QAM			1	0	20.52			
				25	20.46			
		49		20.40				
		25	0	19.25				
			13	19.18				
			25	19.19				
		50	0	19.23				

**LTE Band 26-2**

Conducted Power of LTE Band 26						
Bandwidth	Modulation	RB size	RB offset	Channel	Channel	Channel
				26797	26915	27033
1.4MHz	QPSK	1	0	21.84	20.97	20.96
			2	21.77	21.01	20.92
			5	21.18	21.03	20.90
		3	0	21.19	21.02	20.96
			2	21.20	21.04	20.96
			3	21.18	21.00	20.91
	16QAM	1	0	20.04	20.34	20.31
			2	20.03	20.38	20.23
			5	20.03	20.34	20.26
		3	0	20.25	20.12	20.02
			2	20.17	20.16	20.00
			3	20.11	20.17	19.96
6	0	19.36	19.17	19.04		
Bandwidth	Modulation	RB size	RB offset	Channel	Channel	Channel
				26805	26915	27025
3MHz	QPSK	1	0	21.35	21.03	21.00
			7	21.31	20.99	20.99
			14	21.20	20.93	20.93
		8	0	20.18	20.00	19.96
			4	20.18	19.99	19.91
			7	20.13	19.97	19.88
	15	0	20.11	19.94	19.93	
	16QAM	1	0	19.89	20.44	20.28
			7	19.79	20.33	20.12
			14	19.83	20.41	20.17
		8	0	19.32	19.13	19.22
			4	19.36	19.13	19.19
			7	19.35	19.13	19.13
		15	0	19.15	19.01	19.08

**Conducted Power of LTE Band 26**

Bandwidth	Modulation	RB size	RB offset	Channel	Channel	Channel		
				26915	26915	27015		
5MHz	QPSK	1	0	20.66	20.68	20.54		
			13	20.65	20.60	20.52		
			24	20.58	20.61	20.42		
		12	0	20.14	19.99	19.96		
			6	20.08	20.02	19.90		
			13	20.04	19.96	19.90		
	25	0	20.10	20.02	19.92			
	16QAM	1	0	19.81	19.90	19.35		
			13	19.78	19.88	19.26		
			24	19.71	19.81	19.20		
		12	0	19.12	18.97	19.04		
			6	19.14	19.02	19.03		
			13	19.05	18.96	18.94		
		25	0	19.11	18.97	19.09		
		Bandwidth	Modulation	RB size	RB offset	Channel	Channel	Channel
						26840	26915	26990
	10MHz	QPSK	1	0	20.90	20.79	20.71	
				25	20.83	20.77	20.62	
49				20.75	20.68	20.59		
25			0	19.85	19.79	19.76		
			13	19.85	19.75	19.72		
			25	19.88	19.72	19.69		
50		0	20.09	20.00	19.90			
16QAM		1	0	20.03	20.48	20.51		
			25	19.97	20.35	20.41		
			49	19.88	20.34	20.36		
		25	0	19.32	19.16	19.06		
			13	19.26	19.12	19.02		
			25	19.25	19.01	19.00		
		50	0	19.16	19.10	18.97		

Conducted Power of LTE Band 26

Bandwidth	Modulation	RB size	RB offset	Channel	Channel	Channel	
				26865	26915	26965	
15MHz	QPSK	1	0	<b>21.09</b>	20.81	20.72	
			38	21.06	20.73	20.63	
			74	20.97	20.70	20.59	
		36	0	19.85	19.86	19.77	
			18	<b>19.89</b>	19.77	19.77	
			39	19.82	19.75	19.78	
		75	0	20.06	19.98	20.02	
		16QAM	1	0	20.51	20.50	20.53
				38	20.45	20.34	20.42
	74			20.34	20.26	20.33	
	36		0	19.15	19.14	19.06	
			18	19.12	19.11	19.04	
			39	19.12	19.12	19.06	
	75		0	19.16	19.11	19.01	

**LTE Band 41**

Conducted Power of LTE Band 41						
Bandwidth	Modulation	RB size	RB offset	Channel	Channel	Channel
				39675	40620	41565
5MHz	QPSK	1	0	20.48	19.99	19.77
			13	20.32	20.05	19.56
			24	20.44	19.99	19.64
		12	0	19.50	18.64	18.68
			6	19.51	18.64	18.67
			13	19.50	18.82	18.63
	25	0	19.34	18.84	18.76	
	16QAM	1	0	19.26	18.51	18.68
			13	19.71	18.60	18.71
			24	19.15	18.56	18.78
		12	0	18.40	17.65	17.51
			6	18.35	17.66	17.53
			13	18.29	17.64	17.72
	25	0	18.43	18.02	17.66	
Bandwidth	Modulation	RB size	RB offset	Channel	Channel	Channel
				39700	40620	41540
10MHz	QPSK	1	0	20.64	19.96	19.80
			25	20.47	19.98	19.83
			49	20.50	19.52	19.77
		25	0	19.53	18.68	18.58
			13	19.73	18.98	18.63
			25	19.62	19.01	18.76
	50	0	19.64	19.01	18.62	
	16QAM	1	0	19.42	19.43	18.78
			25	19.57	19.41	18.76
			49	19.48	19.46	18.62
		25	0	19.01	18.32	17.84
			13	19.01	18.28	17.91
			25	19.04	18.27	17.90
	50	0	18.40	18.03	17.59	

**Conducted Power of LTE Band 41**

Bandwidth	Modulation	RB size	RB offset	Channel	Channel	Channel
				39725	40620	41515
15MHz	QPSK	1	0	20.39	19.51	19.56
			38	20.21	19.80	19.70
			74	20.30	19.67	19.63
		36	0	19.43	18.59	18.44
			18	19.22	18.80	18.49
			39	19.40	18.48	18.61
	75	0	19.44	18.82	18.57	
	16QAM	1	0	19.11	18.75	18.14
			38	18.84	18.84	18.15
			74	18.98	18.57	18.22
		36	0	18.45	17.58	17.62
			18	18.25	17.63	17.57
			39	18.20	17.61	17.53
	75	0	18.44	17.60	17.48	
Bandwidth	Modulation	RB size	RB offset	Channel	Channel	Channel
				39750	40620	41490
20MHz	QPSK	1	0	20.31	19.47	19.57
			50	<b>20.37</b>	19.79	19.63
			99	20.07	19.56	19.59
		50	0	19.20	18.50	18.63
			25	<b>19.30</b>	18.55	18.57
			50	19.19	18.43	18.59
	100	0	19.33	18.82	18.36	
	16QAM	1	0	19.42	18.41	18.47
			50	19.34	18.43	18.71
			99	19.82	18.21	18.78
		50	0	18.32	17.66	17.62
			25	18.38	17.98	17.61
			50	18.35	17.76	17.57
	100	0	18.35	17.78	17.59	

**LTE Band 66**

Conducted Power of LTE Band 66								
Bandwidth	Modulation	RB size	RB offset	Channel	Channel	Channel		
				131979	132322	132665		
1.4MHz	QPSK	1	0	20.36	20.51	20.98		
			2	20.37	20.48	20.97		
			5	20.34	20.55	20.87		
		3	0	20.86	20.57	20.83		
			2	21.02	20.53	20.81		
			3	21.01	20.55	20.72		
		6	0	19.99	19.46	19.74		
		16QAM	1	0	20.86	19.84	19.59	
				2	20.44	19.89	19.99	
	5			20.41	19.89	19.62		
	3		0	19.44	19.48	19.78		
			2	19.48	19.53	19.77		
			3	19.43	19.53	19.67		
	6		0	18.60	18.76	19.29		
	Bandwidth		Modulation	RB size	RB offset	Channel	Channel	Channel
						131987	132322	132657
	3MHz	QPSK	1	0	20.78	20.45	20.92	
				7	20.83	20.47	20.84	
14				20.70	20.49	20.79		
8			0	19.64	19.48	19.68		
			4	19.35	19.48	19.70		
			7	19.35	19.43	19.61		
15			0	19.31	19.40	19.72		
16QAM			1	0	19.93	19.85	19.65	
				7	19.89	19.78	19.73	
		14		19.93	19.88	19.52		
		8	0	18.61	18.78	19.00		
			4	18.65	18.94	19.50		
			7	18.61	18.89	19.33		
		15	0	18.55	18.62	19.04		



**Conducted Power of LTE Band 66**

Bandwidth	Modulation	RB size	RB offset	Channel	Channel	Channel	
				131997	132322	132647	
5MHz	QPSK	1	0	20.18	20.40	20.66	
			13	20.07	20.42	20.71	
			24	20.00	20.35	20.65	
		12	0	19.32	19.37	19.76	
			6	19.27	19.42	19.73	
			13	19.21	19.43	19.67	
	25	0	19.30	19.43	19.65		
	16QAM	1	0	19.27	19.29	19.07	
			13	19.20	19.37	19.52	
			24	19.17	19.35	19.04	
		12	0	18.48	18.64	19.11	
			6	18.48	18.68	18.98	
			13	18.39	18.75	18.87	
		25	0	18.52	18.56	19.48	
		Bandwidth	Modulation	RB size	RB offset	Channel	Channel
10MHz		QPSK	1	0	20.46	20.40	20.63
	25			20.40	20.40	20.62	
	49			20.36	20.34	20.68	
	25		0	19.31	19.45	19.59	
			13	19.33	19.45	19.59	
			25	19.38	19.48	19.65	
	50	0	19.26	19.45	19.61		
	16QAM	1	0	19.15	19.93	20.01	
			25	19.07	19.91	19.93	
			49	19.10	19.90	20.02	
		25	0	18.64	18.67	19.11	
			13	18.54	18.63	18.98	
			25	18.65	18.71	19.20	
		50	0	18.49	18.67	19.14	
		Bandwidth	Modulation	RB size	RB offset	Channel	Channel
10MHz		QPSK	1	0	20.46	20.40	20.63
	25			20.40	20.40	20.62	
	49			20.36	20.34	20.68	
	25		0	19.31	19.45	19.59	
			13	19.33	19.45	19.59	
			25	19.38	19.48	19.65	
	50	0	19.26	19.45	19.61		
	16QAM	1	0	19.15	19.93	20.01	
			25	19.07	19.91	19.93	
			49	19.10	19.90	20.02	
		25	0	18.64	18.67	19.11	
			13	18.54	18.63	18.98	
			25	18.65	18.71	19.20	
		50	0	18.49	18.67	19.14	

Conducted Power of LTE Band 66

Bandwidth	Modulation	RB size	RB offset	Channel	Channel	Channel		
				132047	132322	132597		
15MHz	QPSK	1	0	20.28	20.33	20.52		
			38	20.26	20.40	20.54		
			74	20.23	20.48	20.61		
		36	0	19.25	19.48	19.56		
			18	19.38	19.45	19.65		
			39	19.35	19.40	19.69		
		75	0	19.27	19.45	19.67		
		16QAM	1	0	19.53	19.93	20.12	
				38	19.47	19.99	20.13	
	74			19.40	20.04	20.13		
	36		0	18.51	18.71	18.73		
			18	18.60	18.68	19.22		
			39	18.41	18.71	18.89		
	75		0	18.47	18.65	18.85		
	Bandwidth		Modulation	RB size	RB offset	Channel	Channel	Channel
						132072	132322	132572
	20MHz	QPSK	1	0	20.59	20.73	20.63	
				50	20.46	<b>20.86</b>	20.66	
99				20.53	20.78	20.82		
50			0	19.43	19.50	19.66		
			25	19.42	<b>19.52</b>	19.62		
			50	19.35	19.47	19.64		
100			0	19.34	19.53	19.63		
16QAM			1	0	20.03	19.66	19.65	
				50	19.88	19.74	19.67	
		99		19.97	19.80	19.73		
		50	0	18.64	18.71	18.87		
			25	18.91	18.64	18.90		
			50	18.55	18.67	18.93		
		100	0	18.63	18.59	18.80		

LTE Band 71

Conducted Power of LTE Band 71							
Bandwidth	Modulation	RB size	RB offset	Channel	Channel	Channel	
				133147	133297	133447	
5MHz	QPSK	1	0	21.59	22.00	21.94	
			13	21.54	21.99	21.96	
			24	21.49	21.96	21.90	
		12	0	20.71	20.91	20.99	
			6	20.64	20.87	20.89	
			13	20.59	20.82	20.88	
	25	0	20.92	21.08	21.16		
	16QAM	1	0	20.70	20.33	20.84	
			13	20.77	20.30	20.80	
			24	20.69	20.23	20.76	
		12	0	20.04	20.16	20.22	
			6	20.05	20.16	20.12	
			13	20.00	20.06	20.10	
		25	0	19.93	20.20	20.15	
		Bandwidth	Modulation	RB size	RB offset	Channel	Channel
133172						133297	133422
10MHz	QPSK	1	0	21.77	21.81	22.03	
			25	21.69	21.91	22.04	
			49	21.84	21.99	22.05	
		25	0	20.83	21.03	21.03	
			13	20.76	20.95	21.01	
			25	20.80	20.95	21.07	
	50	0	20.93	21.15	21.18		
	16QAM	1	0	20.88	21.93	21.46	
			25	20.72	21.91	21.38	
			49	20.86	21.99	21.38	
		25	0	20.11	20.18	20.19	
			13	20.03	20.12	20.18	
			25	20.25	20.13	20.25	
		50	0	19.98	20.12	20.18	