

TEST REPORT

Reference No...... : WTD24D01019176W003
FCC ID : 2AQRM-MF3
Applicant..... : FOXX Development Inc.
Address..... : 3480 Preston Ridge Road, Suite500, Alpharetta, GA 30005, USA
Manufacturer : FOXX Development Inc.
Address..... : 3480 Preston Ridge Road, Suite500, Alpharetta, GA 30005, USA
Product..... : LTE MiFi Router
Model(s) : MF3
Standards..... : FCC CFR47 Part 22 Subpart H
FCC CFR47 Part 24 Subpart E
FCC CFR47 Part 27 Subpart L
Date of Receipt sample : 2024-01-26
Date of Test : 2024-02-19 to 2024-04-01
Date of Issue..... : 2024-04-01
Test Result..... : **Pass**

Remarks:

The results shown in this test report refer only to the sample(s) tested, this test report cannot be reproduced, except in full, without prior written permission of the company. The report would be invalid without specific stamp of test institute and the signatures of compiler and approver.

Prepared By:

Waltek Testing Group Co., Ltd.

Address: No. 77, Houjie Section, Guantai Road, Houjie Town, Dongguan City, Guangdong, China
Tel: +86-769-2267 6998
Fax: +86-769-2267 6828

Compiled by:

Approved by:

James Cheng
James Cheng / Project Engineer



2 Contents

	Page
1 COVER PAGE	1
2 CONTENTS	2
3 REVISION HISTORY	4
4 GENERAL INFORMATION	5
4.1 GENERAL DESCRIPTION OF E.U.T.	5
4.2 DETAILS OF E.U.T.	5
4.3 TEST MODE	6
4.4 TEST FACILITY	6
5 TEST SUMMARY	7
6 EQUIPMENT USED DURING TEST	8
6.1 EQUIPMENTS LIST	8
6.2 MEASUREMENT UNCERTAINTY	9
6.3 TEST EQUIPMENT CALIBRATION	9
7 RF OUTPUT POWER	10
7.1 EUT OPERATION.....	10
7.2 TEST PROCEDURE.....	10
7.3 TEST RESULT.....	11
8 PEAK-TO-AVERAGE RATIO	15
8.1 EUT OPERATION.....	15
8.2 TEST PROCEDURE.....	15
8.3 TEST RESULT.....	16
9 BANDWIDTH	18
9.1 EUT OPERATION.....	18
9.2 TEST PROCEDURE.....	18
9.3 TEST RESULT.....	19
10 SPURIOUS EMISSIONS AT ANTENNA TERMINALS	27
10.1 EUT OPERATION	27
10.2 TEST PROCEDURE	27
10.3 TEST RESULT	28
11 SPURIOUS RADIATED EMISSIONS	37
11.1 EUT OPERATION	37
11.2 TEST SETUP	37
11.3 SPECTRUM ANALYZER SETUP.....	38
11.4 TEST PROCEDURE	39
11.5 SUMMARY OF TEST RESULTS	40
12 BAND EDGE MEASUREMENT	42
12.1 EUT OPERATION	42
12.2 TEST PROCEDURE	42
12.3 TEST RESULT	43
13 FREQUENCY STABILITY	52
13.1 EUT OPERATION	52
13.2 TEST PROCEDURE	52
13.3 TEST RESULT	53

14	RF EXPOSURE	59
15	PHOTOGRAPHS OF TEST SETUP AND EUT.....	59

3 Revision History

Test Report No.	Date of Receipt Sample	Date of Test	Date of Issue	Purpose	Comment	Approved
WTD24D01019176W003	2024-01-26	2024-02-19 to 2024-04-01	2024-04-01	Original	-	Valid

4 General Information

4.1 General Description of E.U.T.

Product:	LTE MiFi Router
Model(s):	MF3
Model Description:	N/A
WCDMA Band(s):	FDD Band II/IV/V
Hardware Version:	Mobile.M47.H01
Software Version:	Mobile.M47.B01
Highest frequency (Exclude Radio):	26MHz
Storage Location:	SD card Storage

4.2 Details of E.U.T.

Operation Frequency:	WCDMA Band II: 1850~1910MHz WCDMA Band IV:1710~1755MHz WCDMA Band V: 824~849MHz
Max. RF output power:	WCDMA Band II: 22.71dBm WCDMA Band IV: 22.95dBm WCDMA Band V: 22.30dBm
Type of Modulation:	WCDMA: QPSK
Antenna installation:	WCDMA: PCB printed antenna
Antenna Gain:	WCDMA Band II: 3.1dBi WCDMA Band V: 2.6dBi WCDMA Band IV: 3.2dBi

Note:

#: The antenna gain is provided by the applicant, and the applicant should be responsible for its authenticity, WALTEK lab has not verified the authenticity of its information.

Ratings:	Battery: DC 3.7V, 3000mAh, 11.1Wh
Adapter:	Input: 100-240V~, 50/60Hz, 0.2A Output: 5.0V===1.0A
Type of Emission:	WCDMA1900: 4M17F9W WCDMA1700: 4M16F9W WCDMA850: 4M17F9W

4.3 Test Mode

All test mode(s) and condition(s) mentioned were considered and evaluated respectively by performing full tests, the worst data were recorded and reported.

Support Band	Test Mode	Channel Frequency	Channel Number
WCDMA Band V	WCDMA/HSUPA/HSDPA	826.4 MHz	4132
		836.6 MHz	4183
		846.6 MHz	4233
WCDMA Band II	WCDMA/HSUPA/HSDPA	1852.4MHz	9262
		1880.0MHz	9400
		1907.6MHz	9538
WCDMA Band IV	WCDMA/HSUPA/HSDPA	1712.4MHz	1313
		1732.6MHz	1413
		1752.6MHz	1512
Remark: All mode(s) were tested and the worst data was recorded.			

4.4 Test Facility

The test facility has a test site registered with the following organizations:

ISED CAB identifier: CN0013. Test Firm Registration No.: 7760A.

Waltek Testing Group Co., Ltd. Has been registered and fully described in a report filed with the Industry Canada. The acceptance letter from the Industry Canada is maintained in our files.

Registration number 7760A, October 15, 2016.

FCC Designation No.: CN1201. Test Firm Registration No.: 523476.

Waltek Testing Group Co., Ltd. EMC Laboratory `has been registered and fully described in a report filed with the (FCC) Federal Communications Commission. The acceptance letter from the FCC is maintained in our files. Registration number 523476, September 10, 2019.

5 Test Summary

Test Items	Test Requirement	Result
RF Output Power	2.1046 22.913 (a) 24.232 (c) 27.50(c) 27.50(d)	PASS
Peak-to-Average Ratio	24.232 (d) 27.50(d)	PASS
Bandwidth	2.1049 22.905 22.917 24.238 27.53(a)	PASS
Spurious Emissions at Antenna Terminal	2.1051 22.917 (a) 24.238 (a) 27.53(h)	PASS
Field Strength of Spurious Radiation	2.1053 22.917 (a) 24.238 (a) 27.53(h)	PASS
Out of band emission, Band Edge	22.917 (a) 24.238 (a) 27.53(h)	PASS
Frequency Stability	2.1055 22.355 24.235 27.5(h) 27.54	PASS

6 Equipment Used during Test

6.1 Equipments List

Item	Equipment	Manufacturer	Model No.	Serial No.	Last Cal. Date	Calibration Due Date
3m Semi-anechoic Chamber for Radiation Emissions 1#						
1	Spectrum Analyzer	R&S	FSP30	100091	2023-04-24	2024-04-23
2	Amplifier	Agilent	8447D	2944A10178	2023-07-27	2024-07-26
3	Tri-log Broadband Antenna	SCHWARZBECK	VULB9163	336	2023-08-07	2024-08-06
4	Coaxial Cable	Top	TYPE16(13M)	-	2023-04-24	2024-04-23
5	Broad-band Horn Antenna	SCHWARZBECK	BBHA 9120D	667	2024-01-23	2025-01-22
6	Broad-band Horn Antenna	SCHWARZBECK	BBHA 9170	335	2023-07-27	2024-07-26
7	Broadband Preamplifier	COMPLIANCE	PAP-1G18	2004	2023-08-08	2024-08-07
8	Coaxial Cable	Top	ZT26-NJ-NJ-8M/FA	-	2023-04-24	2024-04-23
9	Microwave Amplifier	SCHWARZBECK	BBV 9721	100472	2023-07-27	2024-07-26
10	Coaxial Cable	Top	ZT40-2.92J-2.92J-2.0M	17100919	2023-04-24	2024-04-23
3m Semi-anechoic Chamber for Radiation Emissions 2#						
1	Test Receiver	R&S	ESCI	101296	2023-04-24	2024-04-23
2	Trilog Broadband Antenna	SCHWARZBECK	VULB9160	9160-3325	2023-11-04	2024-11-03
3	Active Loop Antenna	Com-Power	AL-130R	10160007	2023-05-07	2024-05-06
4	Amplifier	ANRITSU	MH648A	M43381	2023-04-24	2024-04-23
5	Cable	HUBER+SUHNER	CBL2	525178	2023-04-24	2024-04-23
RF Conducted Testing						
1	EMC Analyzer (9k~26.5GHz)	Agilent	E7405A	MY45114943	2023-04-24	2024-04-23
2	Spectrum Analyzer (9k-6GHz)	R&S	FSL6	100959	2023-04-24	2024-04-23
3.	Universal Radio Communication Tester	R&S	CMU 200	121315	2023-04-24	2024-04-23
4	Signal Analyzer (9k~26.5GHz)	Agilent	N9010A	MY50520207	2023-04-24	2024-04-23
5	Universal Radio Communication Tester	R&S	CMW 500	127818	2023-04-24	2024-04-23

Test Software:

Test Item	Software name	Software version
Conduction disturbance Radiated Emission(3m)	EZ-EMC	EZ-EMC(RA-03A1-1)

6.2 Measurement Uncertainty

Parameter	Uncertainty
Conducted Emission	± 3.64 dB(AC mains 150KHz~30MHz)
Radiated Spurious Emissions	± 5.08 dB (Bilog antenna 30M~1000MHz)
	± 5.47 dB (Horn antenna 1000M~25000MHz)
Radio Frequency	± 1 x 10 ⁻⁷ Hz
RF Power	± 0.42 dB
RF Power Density	± 0.7dB
Conducted Spurious Emissions	± 2.76 dB (9kHz~26500MHz)
Confidence interval: 95%. Confidence factor:k=2	

6.3 Test Equipment Calibration

All the test equipments used are valid and calibrated by CEPREI Certification Body that address is No.110 Dongguan Zhuang RD. Guangzhou, P.R.China.

7 RF Output Power

Test Requirement:	FCC Part 2.1046, 22.913 (a), 24.232 (c), 27.50(c.10); 27.50(d.4)
Test Method:	TIA/EIA-603-E:2016 ANSI C63.26:2015
Test Mode:	TX transmitting

7.1 EUT Operation

Operating Environment :

Temperature:	24.2 °C
Humidity:	53.9 % RH
Atmospheric Pressure:	101.4kPa

7.2 Test Procedure

Conducted method:

The RF output of the transmitter was connected to the wireless test set and the spectrum analyzer through sufficient attenuation.

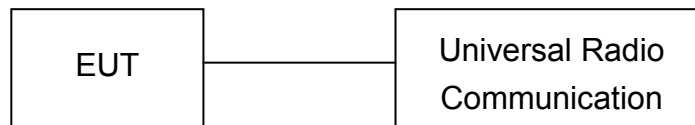

Radiated method:

1. The setup of EUT is according with per TIA/EIA Standard 603D measurement procedure.
2. The measurement antenna was placed at a distance of 3 meters from the EUT. During the tests, the antenna height and polarization as well as EUT azimuth were varied in order to identify the maximum level of emissions from the EUT. The test was performed by placing the EUT on 3-orthogonal axis.
3. The frequency range up to tenth harmonic of the fundamental frequency was investigated.
4. Remove the EUT and replace it with substitution antenna. A signal generator was connected to the substitution antenna by a non-radiating cable. The absolute levels of the spurious emissions were measured by the substitution.

7.3 Test Result

Conducted Power

WCDMA - Average Power (dBm)									
Band	WCDMA Band II			WCDMA Band V			WCDMA Band IV		
Channel	9262	9400	9538	4132	4183	4233	1313	1413	1512
Frequency (MHz)	1852.4	1880	1907.6	826.4	836.6	846.6	1712.4	1732.6	1752.6
RMC 12.2k	22.12	22.71	22.67	22.30	21.97	21.89	22.95	22.56	22.81
HSDPA Subtest-1	21.03	21.56	21.51	21.18	20.84	20.78	22.10	21.58	21.36
HSDPA Subtest-2	21.01	21.48	21.36	21.05	20.71	20.66	22.04	21.41	21.27
HSDPA Subtest-3	20.78	21.42	21.28	20.92	20.50	20.52	21.92	21.30	21.14
HSDPA Subtest-4	20.73	21.24	21.16	20.86	20.41	20.33	21.81	21.26	21.02
HSUPA Subtest-1	21.43	22.11	22.19	21.49	21.20	21.25	22.43	21.88	21.90
HSUPA Subtest-2	21.31	21.89	22.00	21.43	21.15	21.02	22.24	21.73	21.78
HSUPA Subtest-3	21.15	21.85	21.92	21.30	21.09	20.89	22.13	21.56	21.55
HSUPA Subtest-4	21.10	21.63	21.80	21.16	20.85	20.73	22.09	21.44	21.37
HSUPA Subtest-5	20.93	21.55	21.49	21.02	20.79	20.65	20.91	21.28	21.13

Radiated Power

ERP and EIRP

WCDMA Band II (Part 24E)

Frequency	Receiver Reading	Turn table Angle	RX Antenna		Substituted			Absolute Level	Part 24E	
			Height	Polar	SG Level	Cable	Antenna Gain		Limit	Margin
(MHz)	(dBμV)	Degree	(m)	(H/V)	(dBm)	(dB)	(dB)	(dBm)	(dBm)	(dB)
WCDMA Band II Voice Channel 9262										
1852.4	89.32	81	2.3	H	15.35	0.31	10.40	25.44	33	-7.56
1852.4	88.65	70	2.0	V	15.37	0.31	10.40	25.46	33	-7.54
WCDMA Band II Voice Channel 9400										
1880	89.04	261	2.4	H	15.19	0.31	10.40	25.28	33	-7.72
1880	88.75	45	1.1	V	15.63	0.31	10.40	25.72	33	-7.28
WCDMA Band II Voice Channel 9538										
1907.6	89.01	344	1.7	H	15.28	0.32	10.40	25.36	33	-7.64
1907.6	88.43	205	1.3	V	15.47	0.32	10.40	25.55	33	-7.45
WCDMA Band II HSDPA Channel 9262										
1852.4	87.96	251	2.0	H	13.99	0.31	10.40	24.08	33	-8.92
1852.4	87.85	35	2.3	V	14.57	0.31	10.40	24.66	33	-8.34
WCDMA Band II HSDPA Channel 9400										
1880	88.26	354	1.4	H	14.41	0.31	10.40	24.50	33	-8.50
1880	87.89	306	2.1	V	14.77	0.31	10.40	24.86	33	-8.14
WCDMA Band II HSDPA Channel 9538										
1907.6	88.03	157	2.4	H	14.30	0.32	10.40	24.38	33	-8.62
1907.6	87.87	6	1.2	V	14.91	0.32	10.40	24.99	33	-8.01
WCDMA Band II HSUPA Channel 9262										
1852.4	87.07	211	1.5	H	13.10	0.31	10.40	23.19	33	-9.81
1852.4	86.97	43	1.1	V	13.69	0.31	10.40	23.78	33	-9.22
WCDMA Band II HSUPA Channel 9400										
1880	87.08	152	1.9	H	13.23	0.31	10.40	23.32	33	-9.68
1880	86.91	13	2.0	V	13.79	0.31	10.40	23.88	33	-9.12
WCDMA Band II HSUPA Channel 9538										
1907.6	87.12	167	1.9	H	13.39	0.32	10.40	23.47	33	-9.53
1907.6	87.00	339	1.5	V	14.04	0.32	10.40	24.12	33	-8.88

WCDMA Band V (Part 22H)

Frequency	Receiver Reading	Turn table Angle	RX Antenna		Substituted			Absolute Level	Part 22H	
			Height	Polar	SG Level	Cable	Antenna Gain		Limit	Margin
(MHz)	(dBμV)	Degree	(m)	(H/V)	(dBm)	(dB)	(dB)	(dBm)	(dBm)	(dB)
WCDMA Band V Voice Channel 4132										
826.4	92.45	176	1.7	H	25.42	0.20	0.00	25.22	38.45	-13.23
826.4	91.92	130	2.0	V	24.82	0.20	0.00	24.62	38.45	-13.83
WCDMA Band V Voice Channel 4183										
836.6	92.16	161	1.3	H	25.13	0.20	0.00	24.93	38.45	-13.52
836.6	92.07	235	1.2	V	24.97	0.20	0.00	24.77	38.45	-13.68
WCDMA Band V Voice Channel 4233										
846.6	91.98	324	1.7	H	24.95	0.20	0.00	24.75	38.45	-13.70
846.6	91.03	298	2.1	V	23.93	0.20	0.00	23.73	38.45	-14.72
WCDMA Band V HSDPA Channel 4132										
826.4	91.19	101	1.7	H	24.16	0.20	0.00	23.96	38.45	-14.49
826.4	92.18	336	2.1	V	25.08	0.20	0.00	24.88	38.45	-13.57
WCDMA Band V HSDPA Channel 4183										
836.6	91.08	156	1.3	H	24.05	0.20	0.00	23.85	38.45	-14.60
836.6	91.07	141	2.1	V	23.97	0.20	0.00	23.77	38.45	-14.68
WCDMA Band V HSDPA Channel 4233										
846.6	91.26	76	1.4	H	24.23	0.20	0.00	24.03	38.45	-14.42
846.6	91.09	307	1.9	V	23.99	0.20	0.00	23.79	38.45	-14.66
WCDMA Band V HSUPA Channel 4132										
826.4	89.98	103	2.1	H	22.95	0.20	0.00	22.75	38.45	-15.70
826.4	90.40	313	1.9	V	23.30	0.20	0.00	23.10	38.45	-15.35
WCDMA Band V HSUPA Channel 4183										
836.6	90.03	20	1.5	H	23.00	0.20	0.00	22.80	38.45	-15.65
836.6	90.24	60	2.4	V	23.14	0.20	0.00	22.94	38.45	-15.51
WCDMA Band V HSUPA Channel 4233										
846.6	90.01	190	1.8	H	22.98	0.20	0.00	22.78	38.45	-15.67
846.6	90.39	334	1.4	V	23.29	0.20	0.00	23.09	38.45	-15.36

WCDMA Band IV (Part 27L)

Frequency	Receiver Reading	Turntable Angle	RX Antenna		Substituted			Absolute Level	Part 27	
			Height	Polar	SG Level	Cable	Antenna Gain		Limit	Margin
(MHz)	(dBμV)	Degree	(m)	(H/V)	(dBm)	(dB)	(dB)	(dBm)	(dBm)	(dB)
WCDMA Band IV Voice Channel 1313										
1712.4	88.89	50	2.2	H	14.92	0.30	9.40	24.02	30	-5.98
1712.4	88.42	215	1.1	V	14.14	0.30	9.40	23.24	30	-6.76
WCDMA Band IV Voice Channel 1413										
1732.6	88.58	101	2.2	H	14.73	0.30	9.40	23.83	30	-6.17
1732.6	88.55	268	1.6	V	14.43	0.30	9.40	23.53	30	-6.47
WCDMA Band IV Voice Channel 1512										
1752.6	88.82	300	1.7	H	15.09	0.30	9.40	24.19	30	-5.81
1752.6	88.70	298	1.1	V	13.74	0.30	9.40	22.84	30	-7.16
WCDMA Band IV HSDPA Channel 1313										
1712.4	88.41	196	1.1	H	14.44	0.30	9.40	23.54	30	-6.46
1712.4	88.81	6	1.2	V	14.53	0.30	9.40	23.63	30	-6.37
WCDMA Band IV HSDPA Channel 1413										
1732.6	88.49	221	2.1	H	14.64	0.30	9.40	23.74	30	-6.26
1732.6	88.54	29	1.6	V	14.42	0.30	9.40	23.52	30	-6.48
WCDMA Band IV HSDPA Channel 1512										
1752.6	88.68	189	1.7	H	14.95	0.30	9.40	24.05	30	-5.95
1752.6	88.67	277	1.4	V	13.71	0.30	9.40	22.81	30	-7.19
WCDMA Band IV HSUPA Channel 1313										
1712.4	88.54	44	1.0	H	14.57	0.30	9.40	23.67	30	-6.33
1712.4	88.59	144	1.3	V	14.31	0.30	9.40	23.41	30	-6.59
WCDMA Band IV HSUPA Channel 1413										
1732.6	88.52	222	1.4	H	14.67	0.30	9.40	23.77	30	-6.23
1732.6	88.45	303	1.6	V	14.33	0.30	9.40	23.43	30	-6.57
WCDMA Band IV HSUPA Channel 1512										
1752.6	88.66	216	1.1	H	14.93	0.30	9.40	24.03	30	-5.97
1752.6	88.49	331	1.9	V	13.53	0.30	9.40	22.63	30	-7.37

8 Peak-to-Average Ratio

Test Requirement:	24.232 (d), 27.50(d)
Test Method:	N/A
Test Mode:	TX transmitting

8.1 EUT Operation

Operating Environment :

Temperature:	24.2 °C
Humidity:	53.9 % RH
Atmospheric Pressure:	101.4kPa

8.2 Test Procedure

1. The EUT was connected to spectrum analyzer and system simulator via a power divider.
2. Set EUT to transmit at maximum output power.
3. When the duty cycle is less than 98%, then signal gating will be implemented on the spectrum analyzer by triggering from the system simulator.
4. Set the CCDF (Complementary Cumulative Distribution Function) option of the spectrum analyzer. Record the maximum PAPR level associated with a probability of 0.1%.

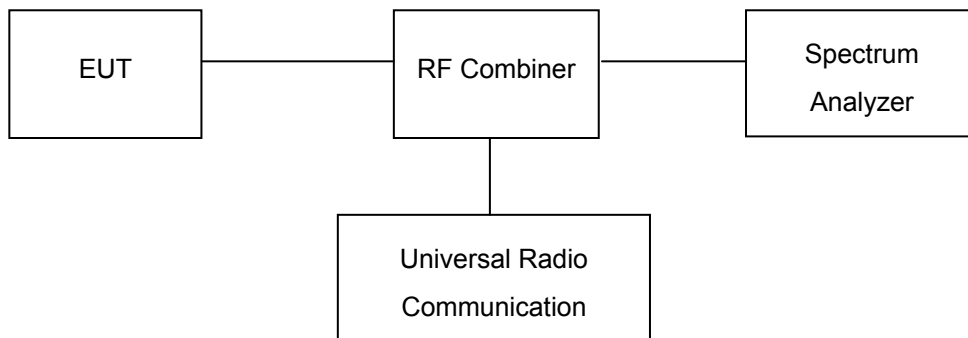

8.3 Test Result

Remark: All test data were reported and only the worst case (middle channel mode) test graphs were showed in test report.

Cellular Band (Part 24E&Part 27L)

Mode	WCDMA Band II			WCDMA Band IV			Limit (dB)
Channel	9262	9400	9538	1313	1413	1512	
Frequency (MHz)	1852.4	1880.0	1907.6	1712.4	1732.6	1752.6	
Peak-to-Average Ratio (dB)	3.84	3.87	2.96	3.93	3.97	3.88	13

Test Plots (Part 24E)

WCDMA Band II Middle Channel

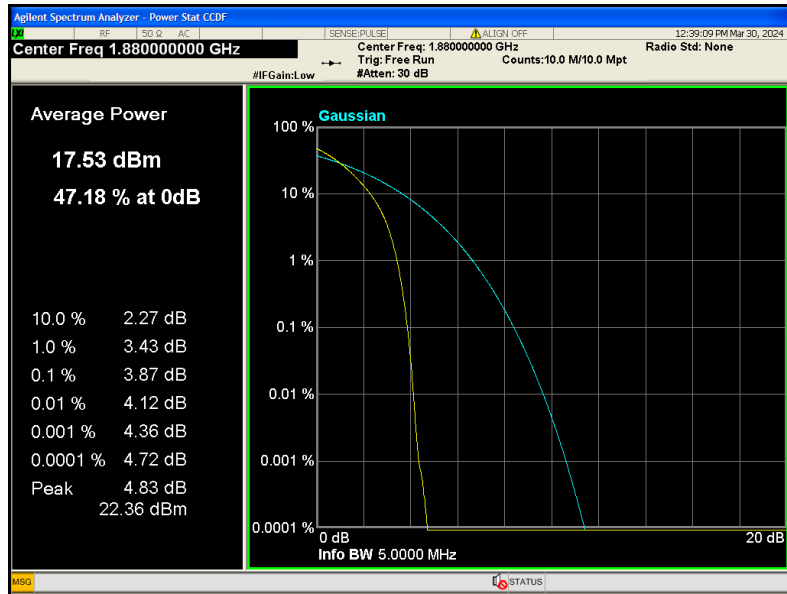

Test Plots (Part 27L)

WCDMA Band IV Middle Channel

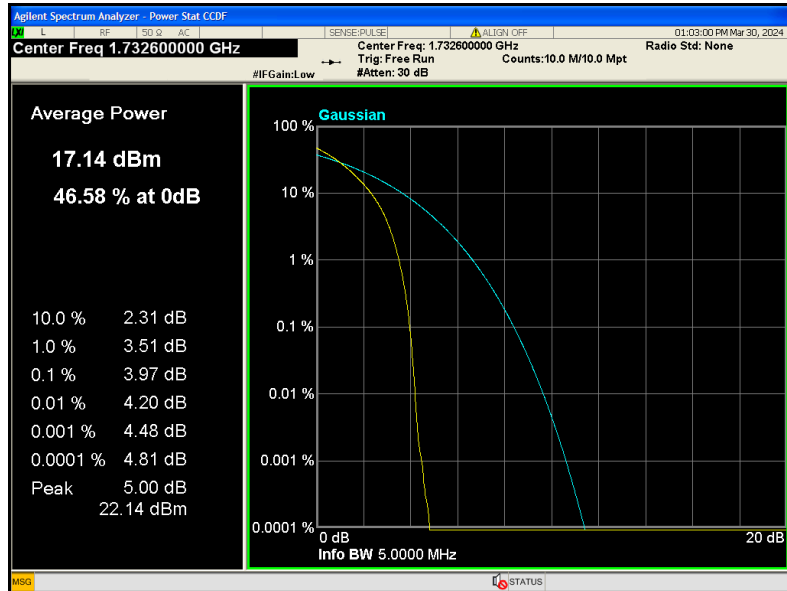

9 Bandwidth

Test Requirement: FCC Part 2.1049, 22.917, 22.905, 24.238, 27.53(a)

Test Method: TIA/EIA-603-E:2016

ANSI C63.26:2015

Test Mode: TX transmitting

9.1 EUT Operation

Operating Environment :

Temperature: 24.2 °C

Humidity: 53.9 % RH

Atmospheric Pressure: 101.4kPa

9.2 Test Procedure

The RF output of the transmitter was connected to the wireless test set and the spectrum analyzer through sufficient attenuation.

The resolution bandwidth of the spectrum analyzer was set in the range of 1 to 5 % of the anticipated OBW (Cellular /PCS) and the 26 dB & 99%bandwidth was recorded.

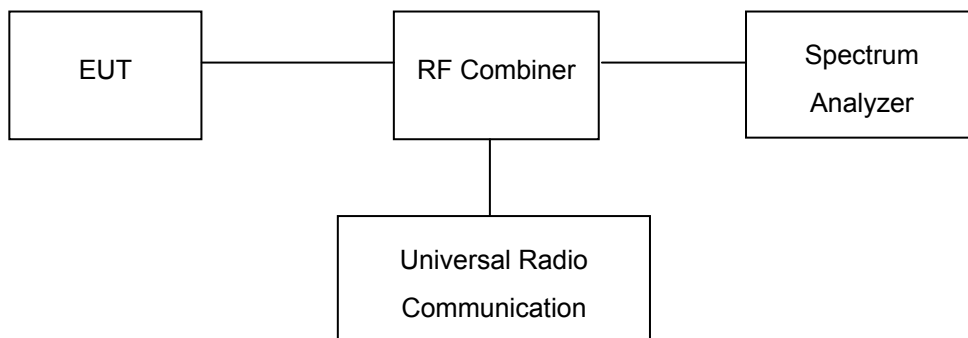

9.3 Test Result

Remark: All test data were reported and only the worst case (middle channel mode) test graphs were showed in test report.

Cellular Band (Part 22H)

Test Mode		Channel	Frequency (MHz)	99% Occupied Bandwidth(MHz)	26 dB Emission Bandwidth(MHz)
WCDMA Band V	RMC12.2k	4132	826.4	4.14	4.67
		4183	836.6	4.15	4.69
		4233	846.6	4.13	4.68
	HSDPA(16QAM)	4132	826.4	4.17	4.67
		4183	836.6	4.17	4.68
		4233	846.6	4.17	4.67
	HSUPA(BPSK)	4132	826.4	4.15	4.67
		4183	836.6	4.16	4.67
		4233	846.6	4.16	4.67

Cellular Band (Part 24E)

Test Mode		Channel	Frequency (MHz)	99% Occupied Bandwidth(MHz)	26 dB Emission Bandwidth(MHz)
WCDMA Band II	RMC12.2k	9262	1852.4	4.13	4.69
		9400	1880.0	4.15	4.70
		9538	1907.6	4.14	4.69
	HSDPA(16QAM)	9262	1852.4	4.14	4.69
		9400	1880.0	4.16	4.69
		9538	1907.6	4.15	4.69
	HSUPA(BPSK)	9262	1852.4	4.16	4.65
		9400	1880.0	4.17	4.66
		9538	1907.6	4.15	4.65

Cellular Band (Part 27L)

Test Mode		Channel	Frequency (MHz)	99% Occupied Bandwidth(MHz)	26 dB Emission Bandwidth(MHz)
WCDMA Band IV	RMC12.2k	1313	1712.6	4.08	4.57
		1413	1732.6	4.15	4.68
		1512	1752.4	4.09	4.58
	HSDPA	1313	1712.6	4.12	4.59
		1413	1732.6	4.15	4.68
		1512	1752.4	4.09	4.67
	HSUPA	1313	1712.6	4.12	4.65
		1413	1732.6	4.16	4.67
		1512	1752.4	4.14	4.61

Test Plots (worst case)
 Cellular Band (Part 22H)
 WCDMA band V
 RMC12.2k

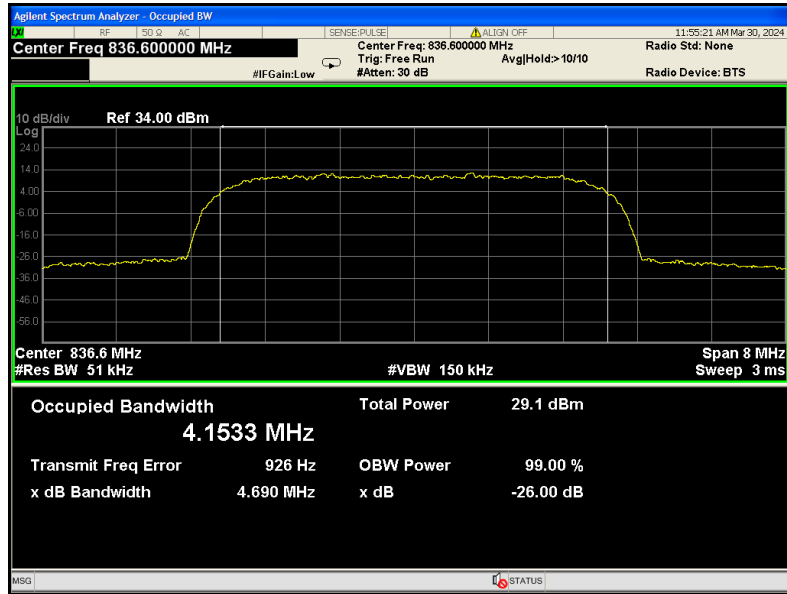

HSDPA

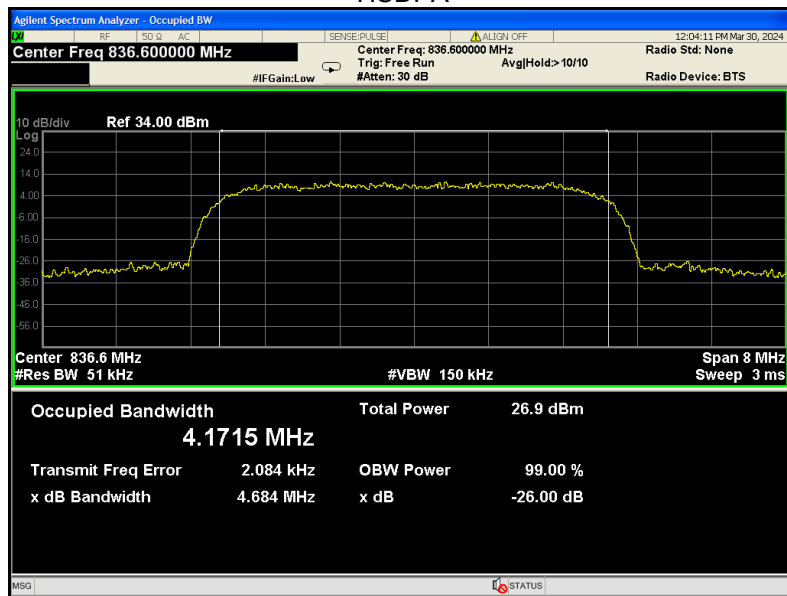

HSUPA

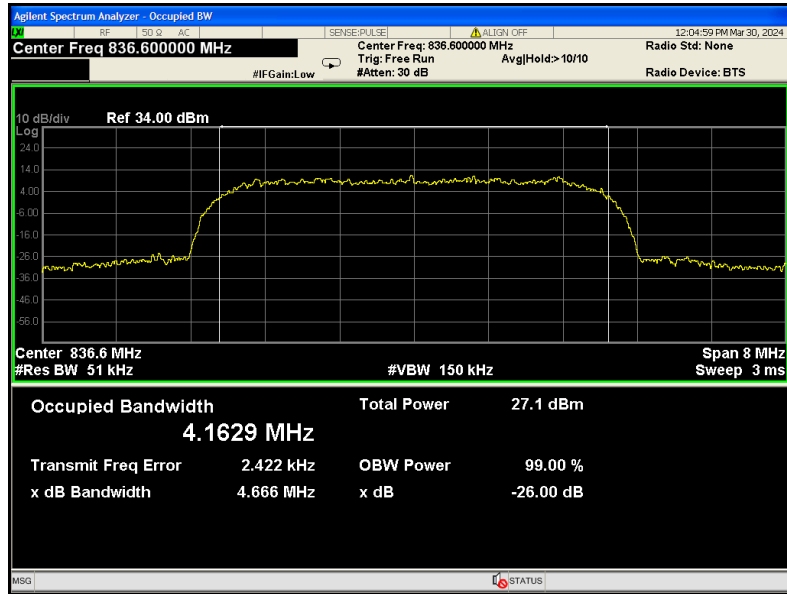

Cellular Band (Part 24E)

WCDMA band II

RMC12.2k

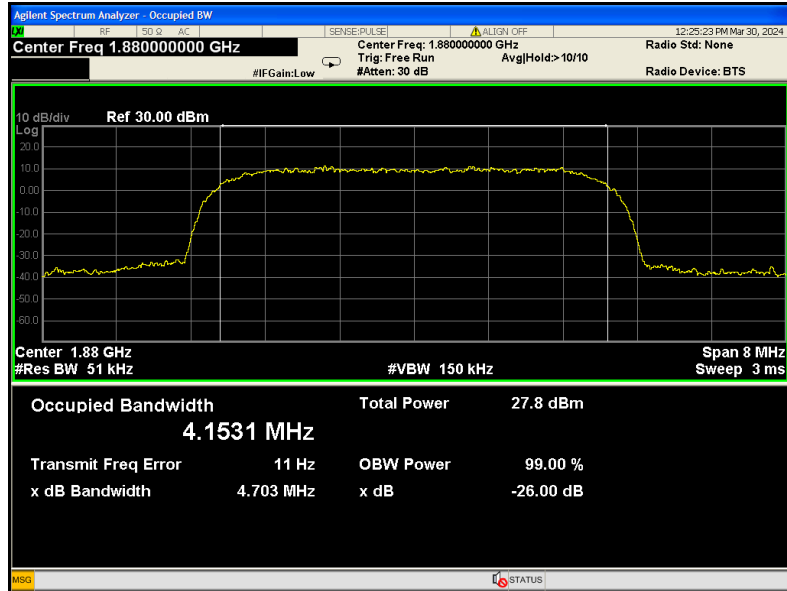

HSDPA

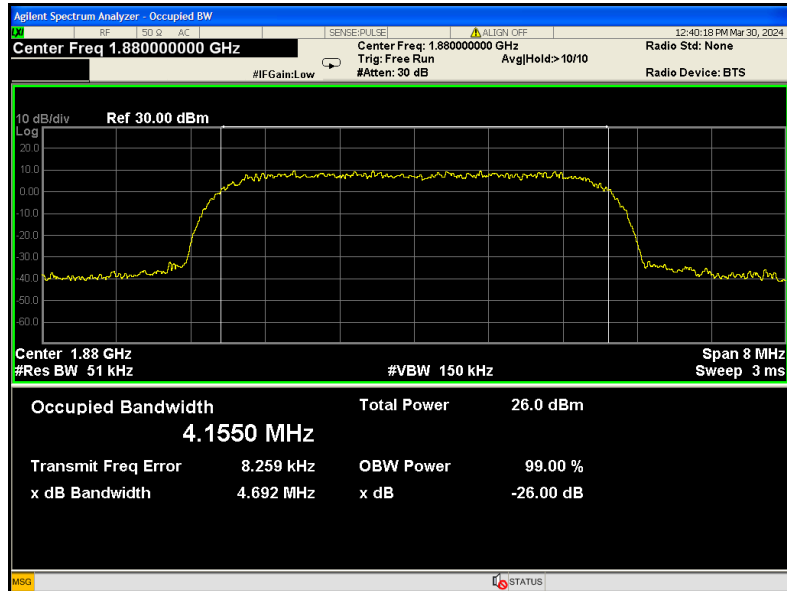

HSUPA

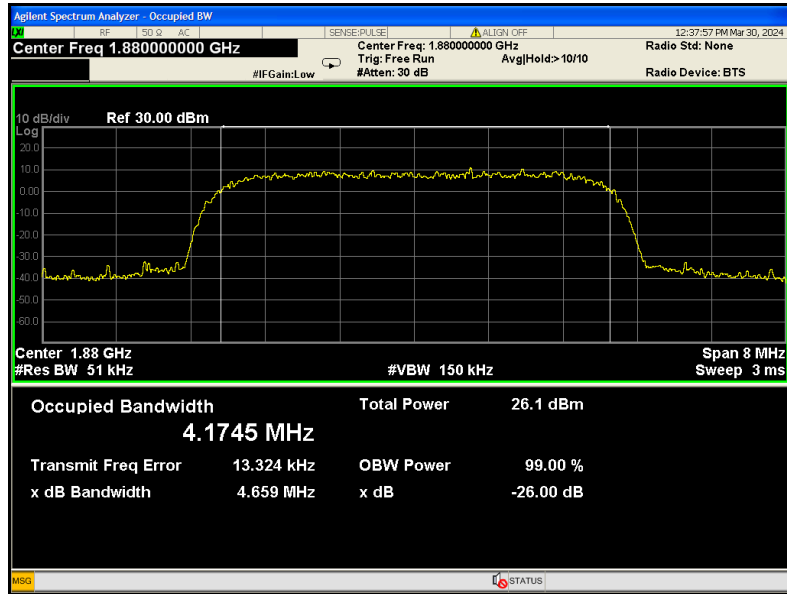

(Part 27L)
 WCDMA band IV
 RMC12.2k

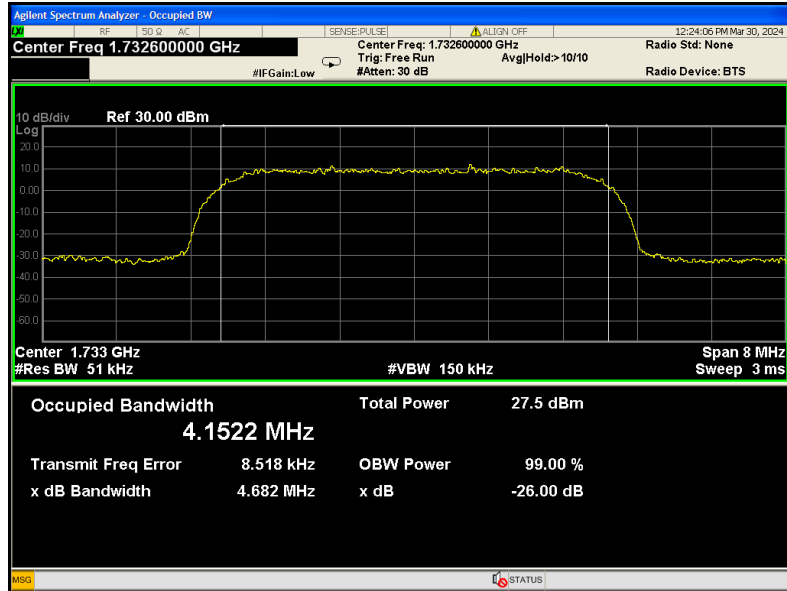

HSDPA

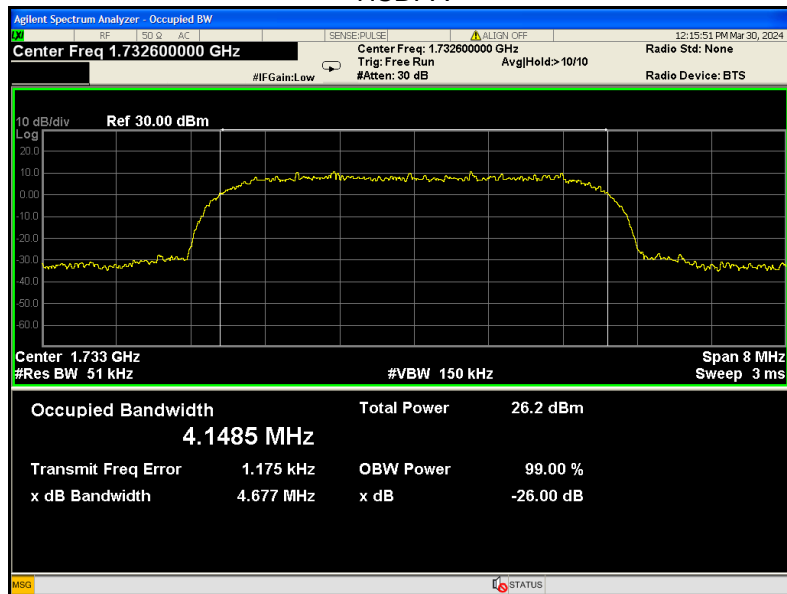

HSUPA

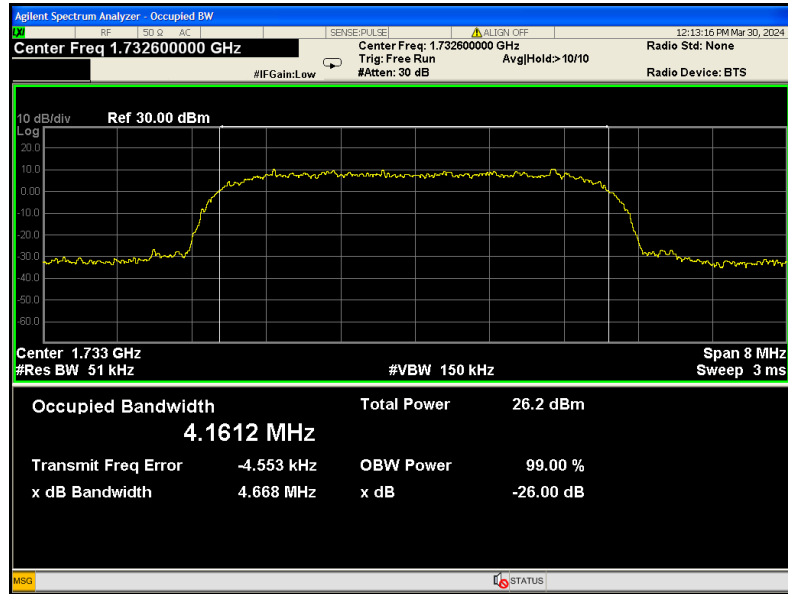

10 Spurious Emissions at Antenna Terminals

Test Requirement:	FCC Part 2.1051, 22.917(a), 24.238(a), 27.53(h)
Test Method:	TIA/EIA-603-E:2016 ANSI C63.26:2015
Test Mode:	TX transmitting

10.1 EUT Operation

Operating Environment :

Temperature:	24.4 °C
Humidity:	55.7 % RH
Atmospheric Pressure:	101.5kPa

10.2 Test Procedure

The RF output of the transceiver was connected to a spectrum analyzer and simulator through appropriate attenuation. The resolution bandwidth of the spectrum analyzer was set at 1MHz. Sufficient scans were taken to show any out of band emissions up to 10th harmonics.

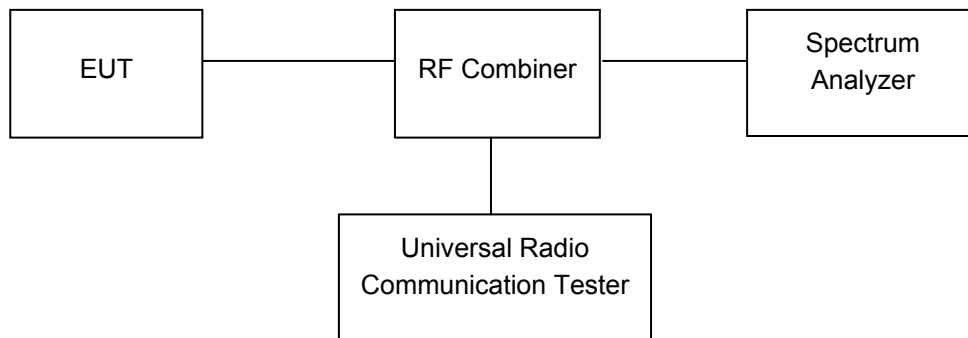

10.3 Test Result

Remark: All test data were reported and only the worst case (middle channel mode) test graphs were showed in test report.

Cellular Band (Part 22H)
WCDMA band V - channel 4183
30MHz-1GHz

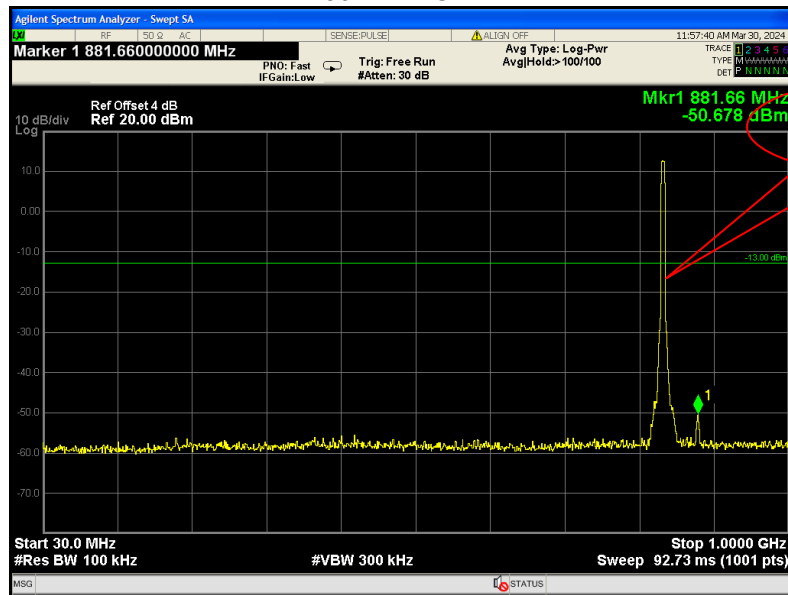

Above 1GHz

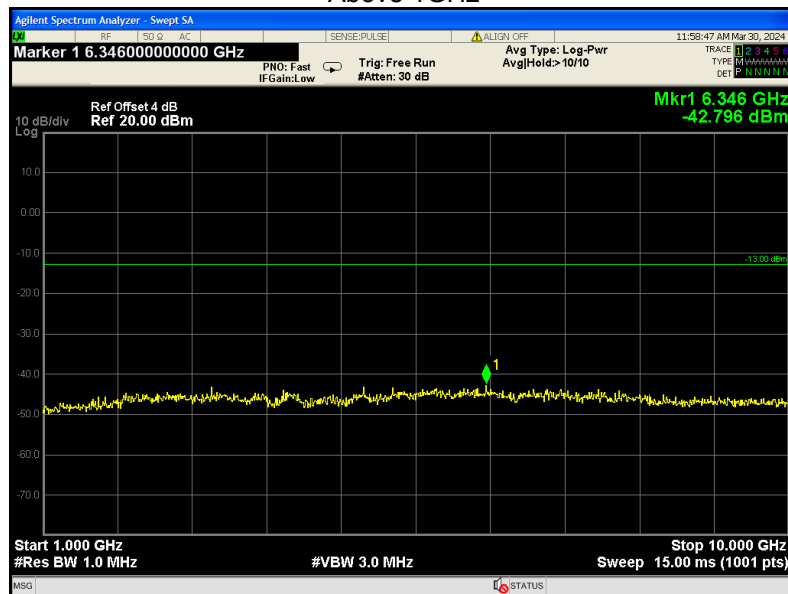

WCDMA band V - channel 4183 (HSDPA)

30MHz-1GHz

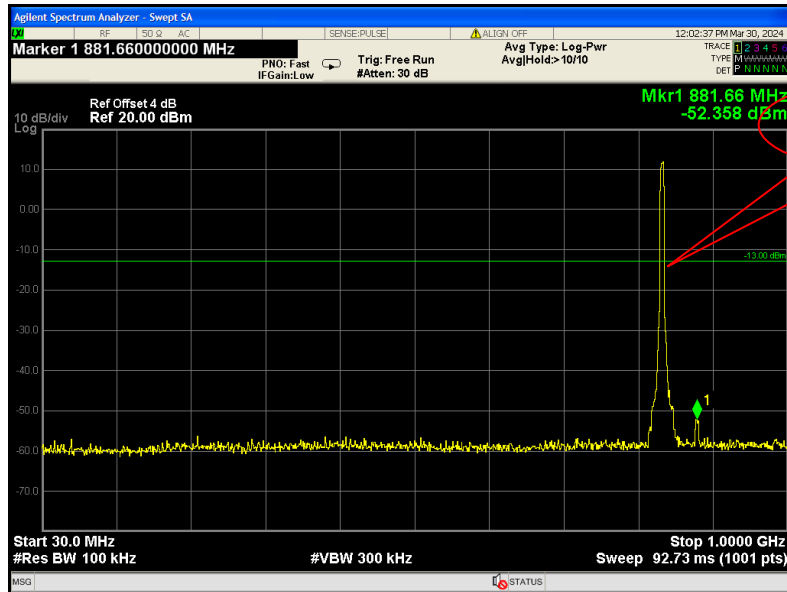

Above 1GHz

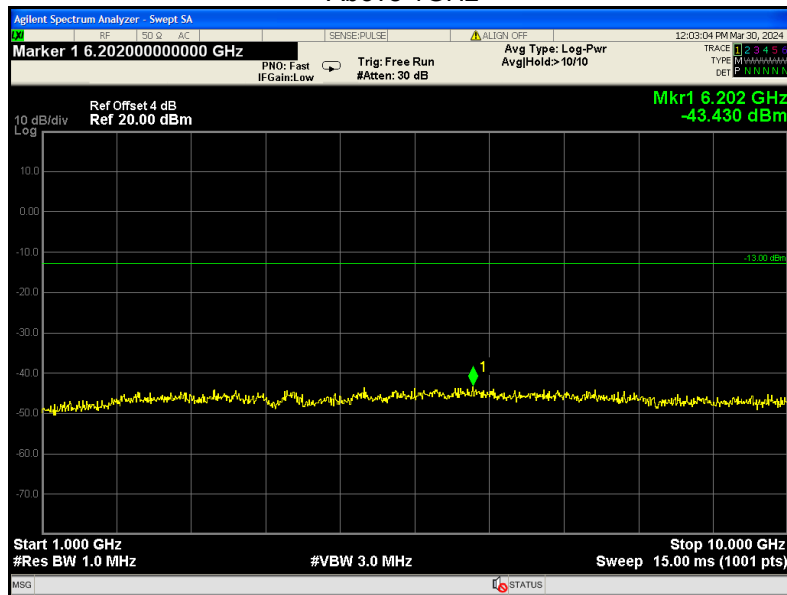

WCDMA band V - channel 4183 (HSUPA)

30MHz-1GHz

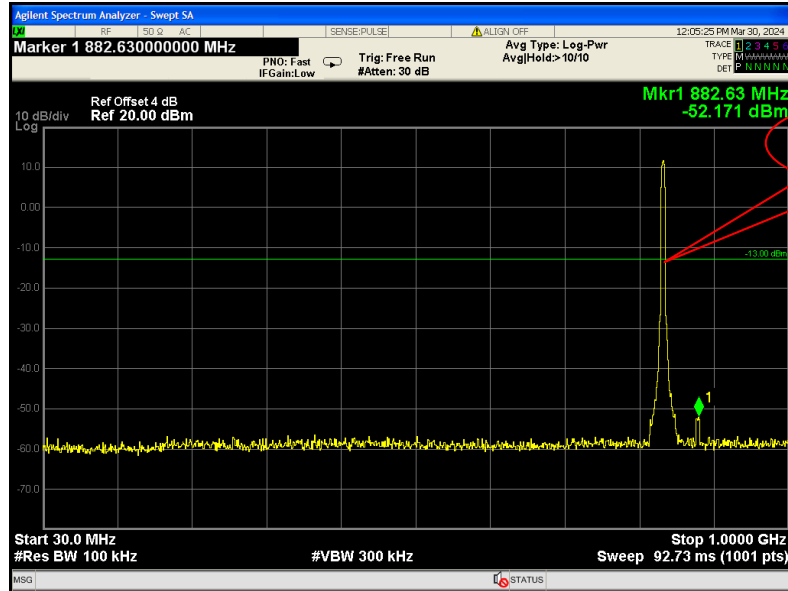

Above 1GHz

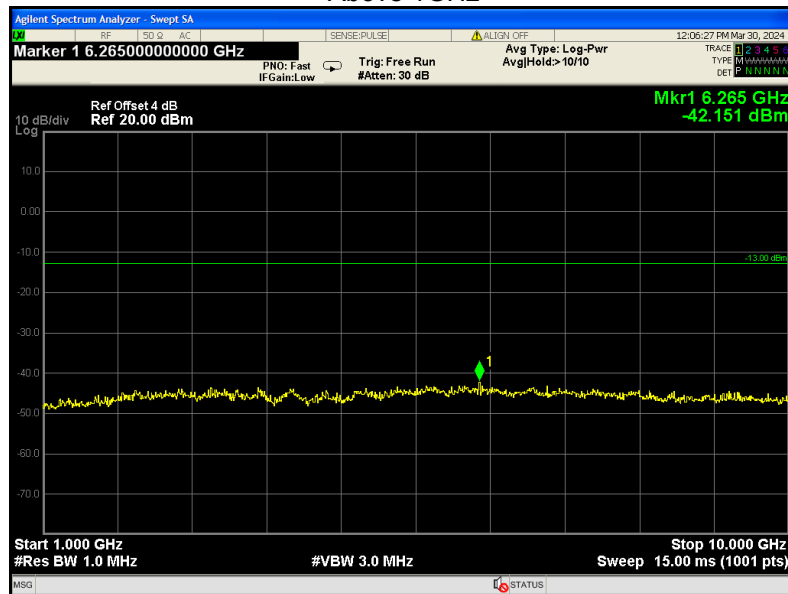

Cellular Band (Part 24E)
WCDMA band II - channel 9400
30MHz-1GHz

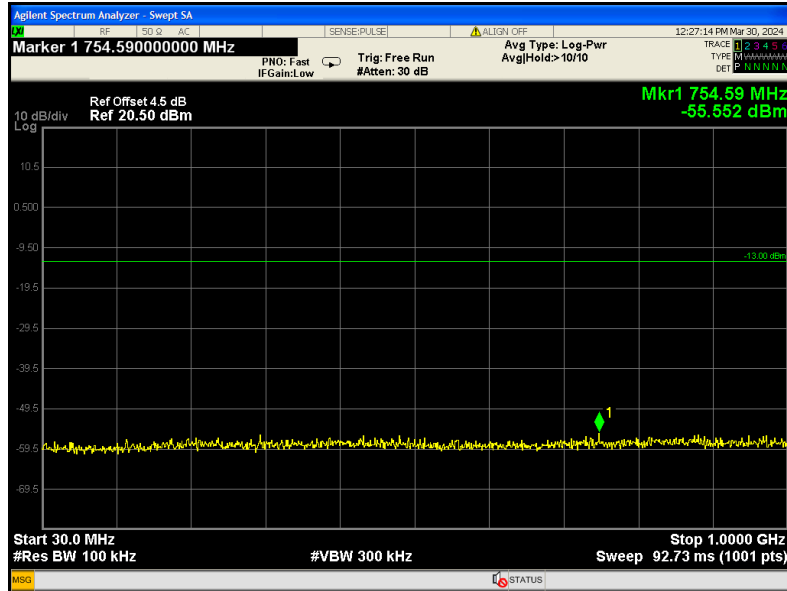

Above 1GHz

Fundamental

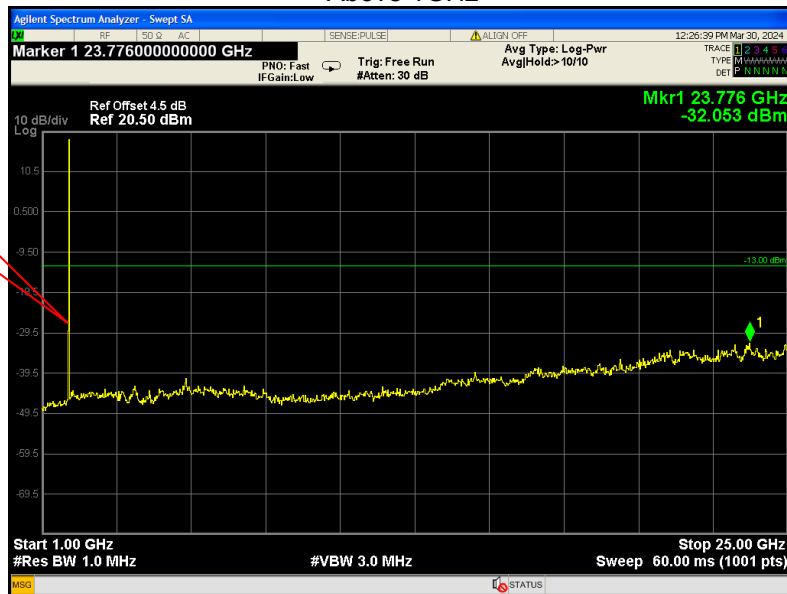

WCDMA band II - channel 9400 (HSDPA)

30MHz-1GHz

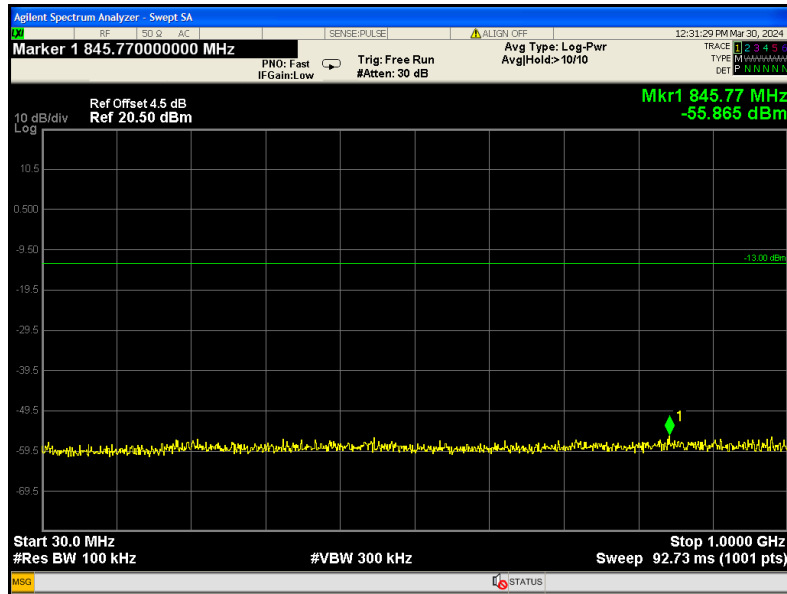

Above 1GHz

Fundamental

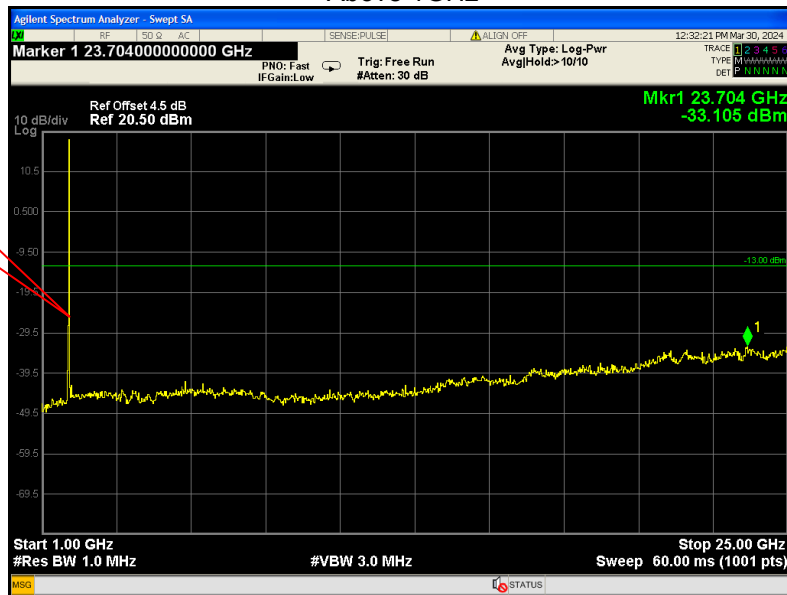

WCDMA band II - channel 9400 (HSUPA)

30MHz-1GHz

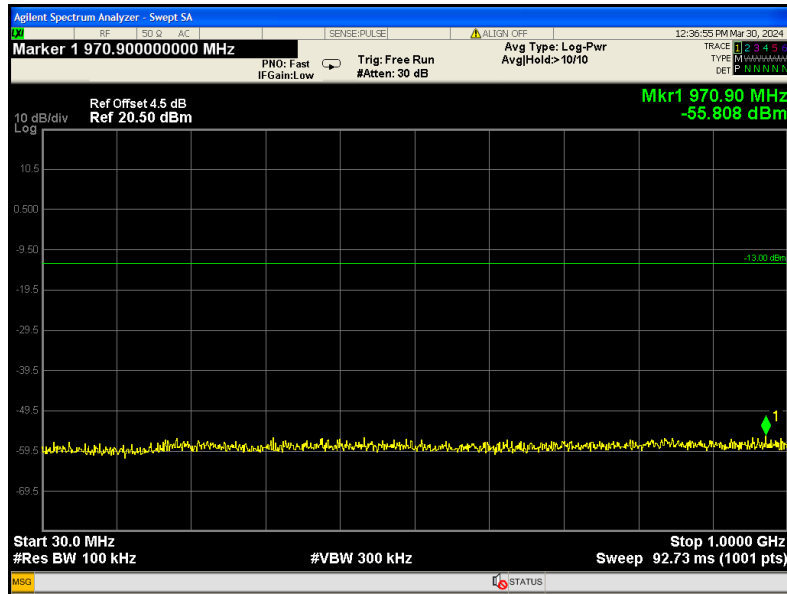

Above 1GHz

Fundamental

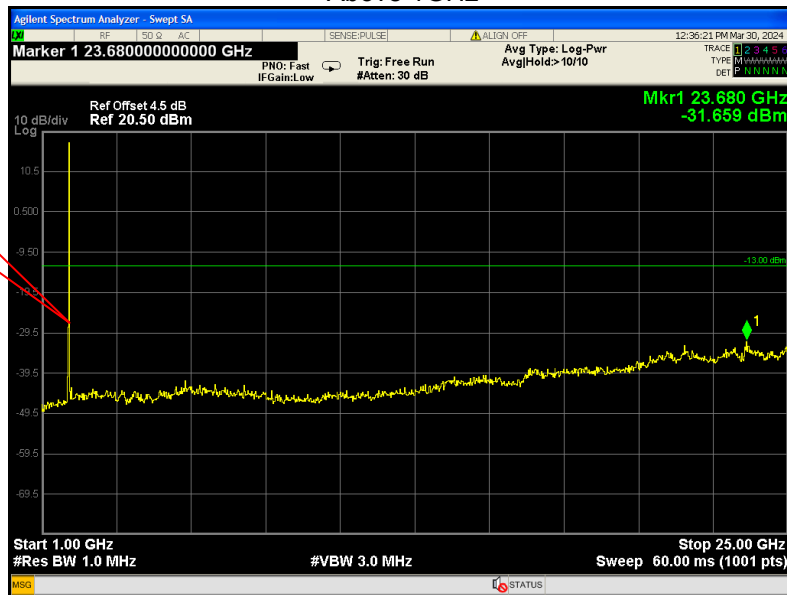

(Part 27L)

WCDMA band IV - channel 1413

30MHz-1GHz

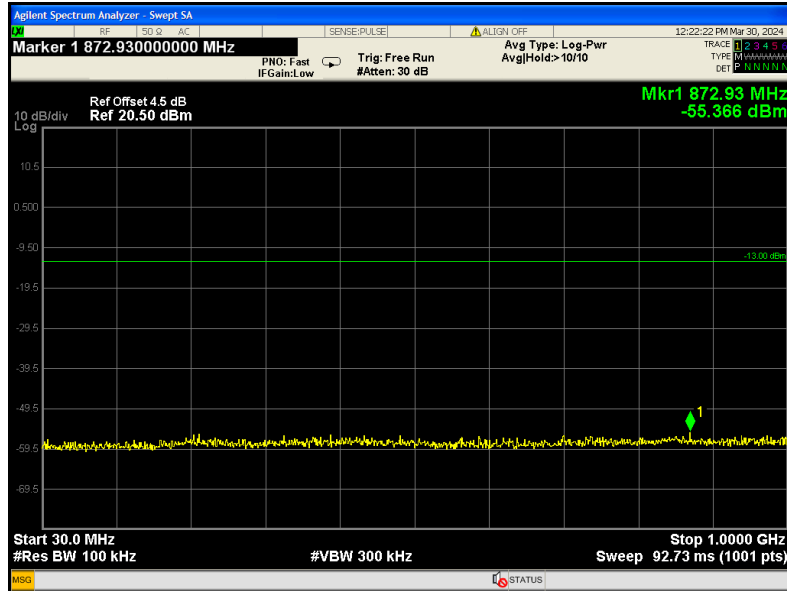

Above 1GHz

Fundamental

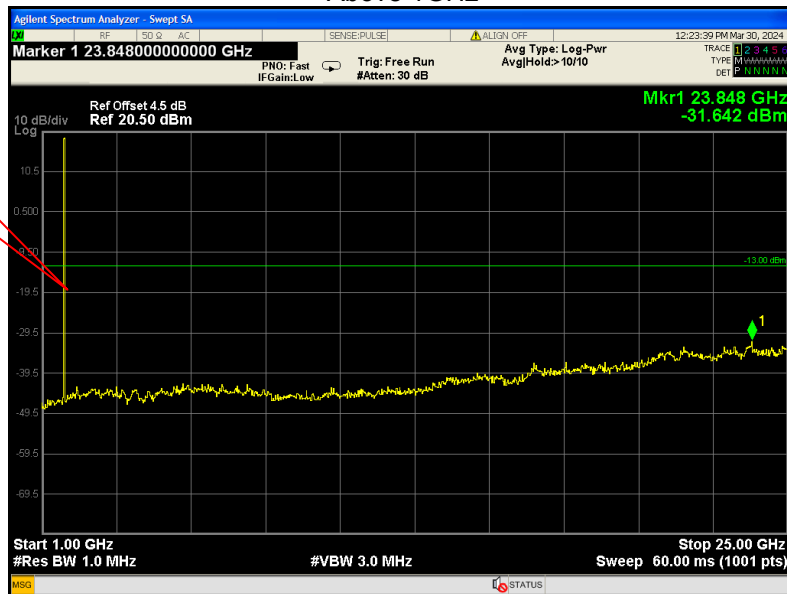

WCDMA band IV - channel 1413 (HSDPA)

30MHz-1GHz

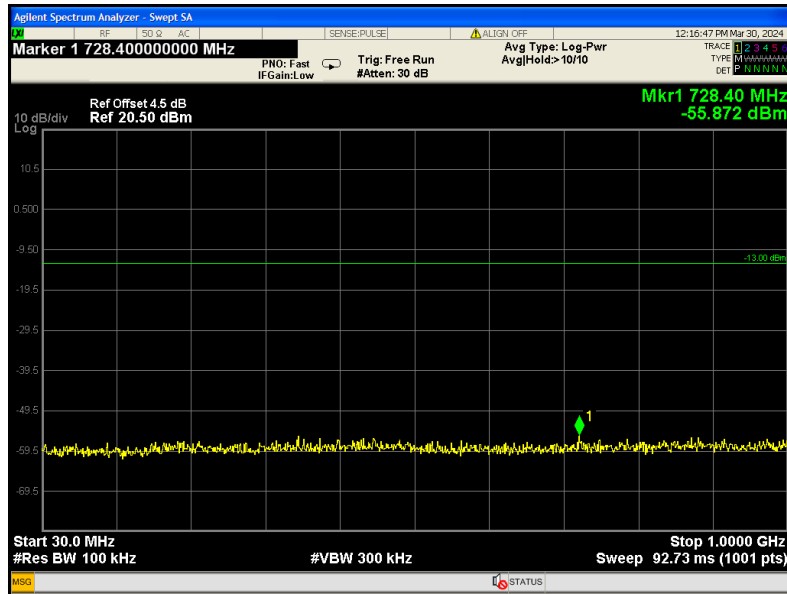

Above 1GHz

Fundamental

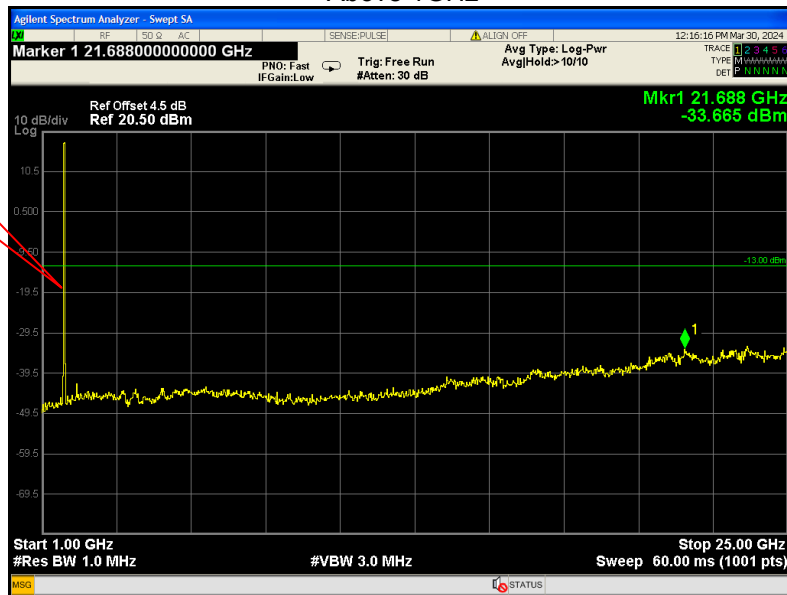

WCDMA band IV - channel 1413 (HSUPA)

30MHz-1GHz

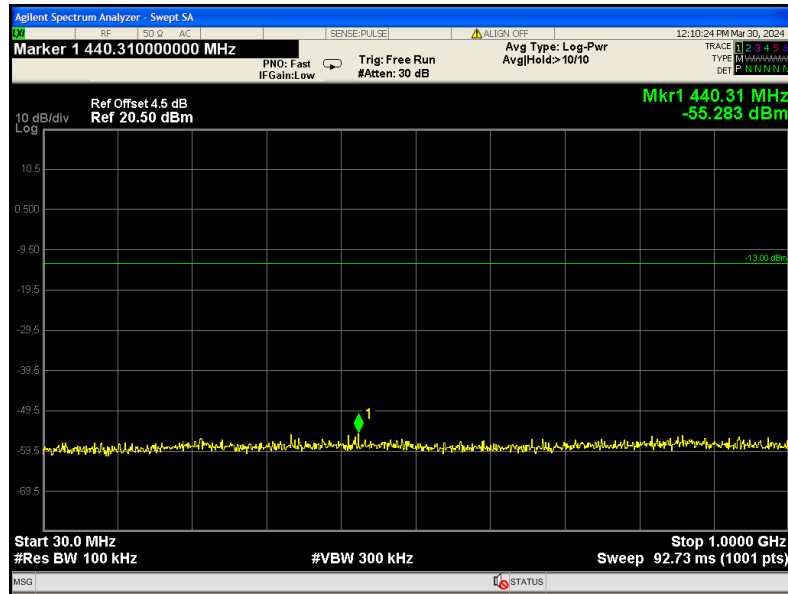

Above 1GHz

Fundamental

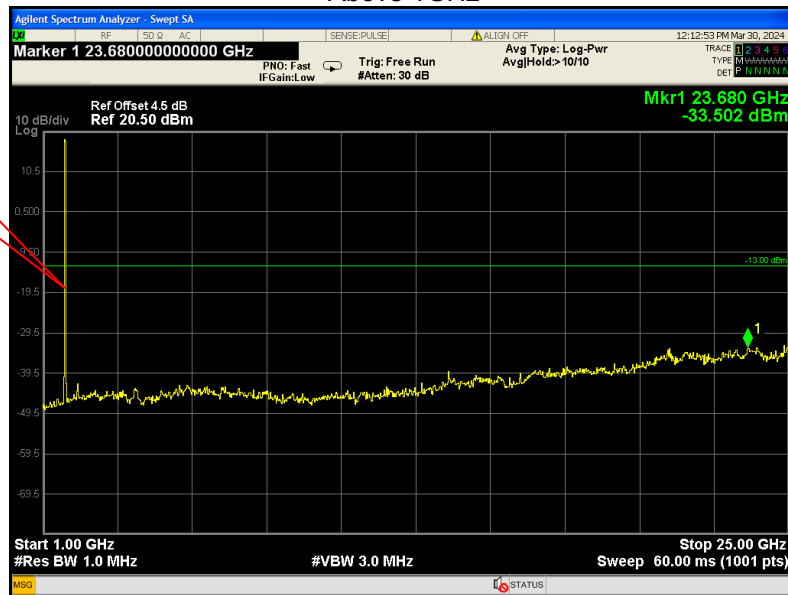

11 Spurious Radiated Emissions

Test Requirement: FCC Part 2.1053, 22.917, 24.238, 27.53(h)

Test Method: TIA/EIA-603-E:2016

ANSI C63.26:2015

Test Mode: TX transmitting

11.1 EUT Operation

Operating Environment :

Temperature: 23.8 °C

Humidity: 56.3 % RH

Atmospheric Pressure: 101.2kPa

11.2 Test Setup

The radiated emission tests were performed in the 3m Semi- Anechoic Chamber test site, using the setup accordance with the test setup for emission measurement from 30 MHz to 1 GHz.

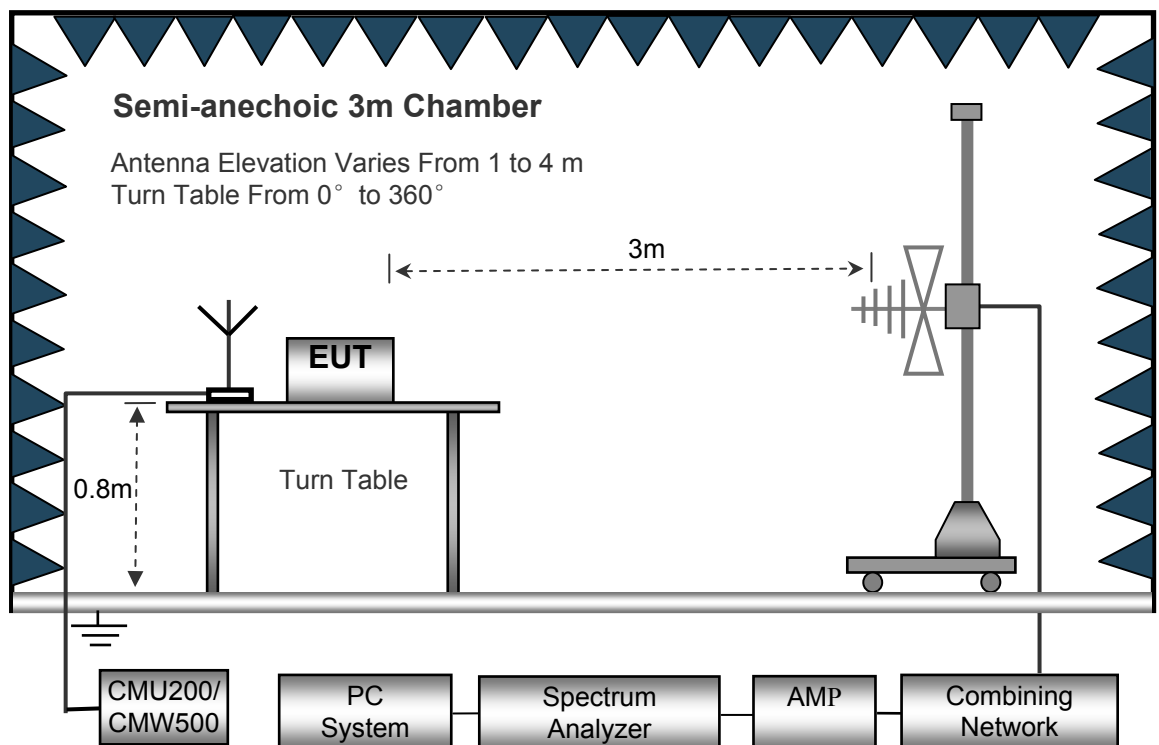

The test setup for emission measurement above 1 GHz.

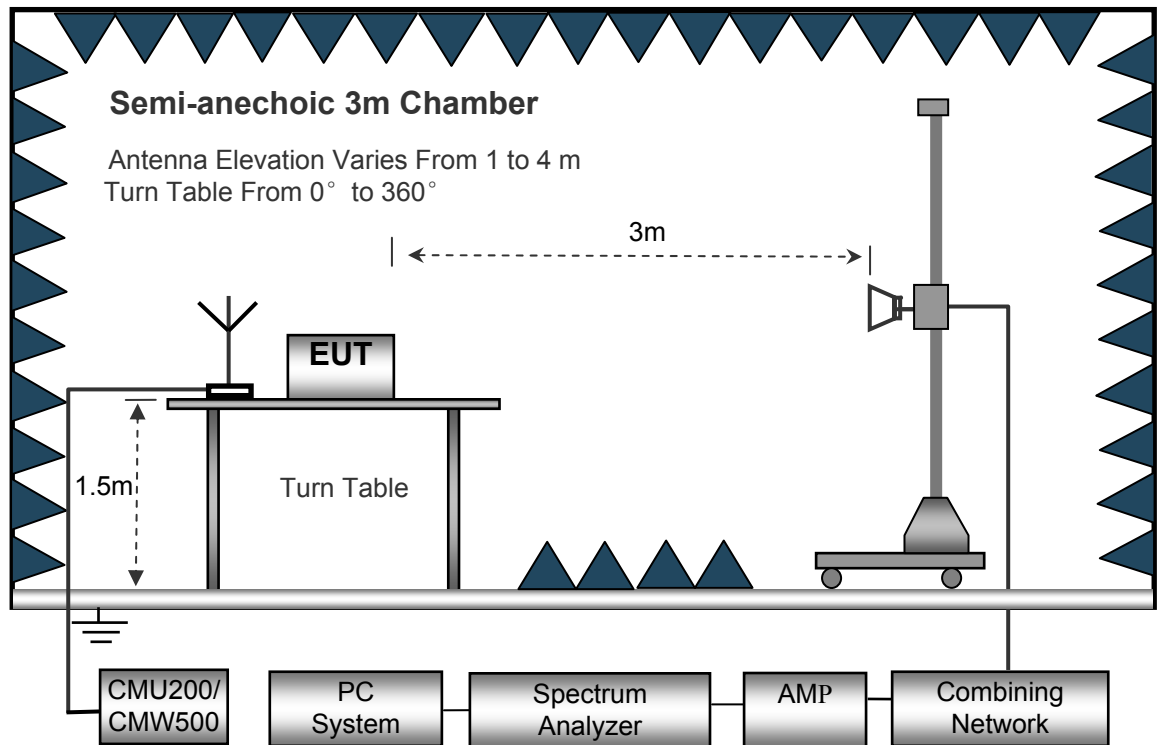

11.3 Spectrum Analyzer Setup

30MHz ~ 1GHz

Sweep Speed Auto
 Detector PK
 Resolution Bandwidth..... 100kHz
 Video Bandwidth..... 300kHz

Above 1GHz

Sweep Speed Auto
 Detector PK
 Resolution Bandwidth..... 1MHz
 Video Bandwidth..... 3MHz
 Detector Ave.
 Resolution Bandwidth..... 1MHz
 Video Bandwidth..... 10Hz

11.4 Test Procedure

1. The EUT is placed on a turntable, which is 0.8m for below 1GHz and 1.5m for above 1GHz above ground plane.
2. The turntable shall be rotated for 360 degrees to determine the position of maximum emission level.
3. EUT is set 3m away from the receiving antenna, which is moved from 1m to 4m to find out the maximum emissions. The spectrum was investigated from 30MHz up to the tenth harmonic of the highest fundamental frequency.
4. Maximum procedure was performed on the six highest emissions to ensure EUT compliance.
5. And also, each emission was to be maximized by changing the polarization of receiving antenna both horizontal and vertical.
6. The radiation measurements are tested under 3-axes(X,Y,Z) position(X denotes lying on the table, Y denotes side stand and Z denotes vertical stand), After pre-test, It was found that the worse radiation emission was get at the Z position. So the data shown was the Z position only.
7. Remove the EUT and replace it with substitution antenna. A signal generator was connected to the substitution antenna by a non-radiating cable. The absolute levels of the spurious emissions were measured by the substitution.
Spurious emissions in dB = $10 \lg (\text{TXpwr in Watts}/0.001)$ – the absolute level
Spurious attenuation limit in dB = $43 + 10 \text{Log}_{10} (\text{power out in Watts})$
8. Repeat above procedures until the measurements for all frequencies are completed.

11.5 Summary of Test Results

For 26MHz~30MHz,

The measurements were more than 20 dB below the limit and not reported.

Remark: Test performed from 30MHz to 10th harmonics with low/middle/high channels, only the worst data were recorded.

Cellular Band (Part 22H)

Frequency	Receiver Reading	Turn table Angle	RX Antenna		Substituted			Absolute Level	Result	
			Height	Polar	SG Level	Cable	Antenna Gain		Limit	Margin
(MHz)	(dBμV)	Degree	(m)	(H/V)	(dBm)	(dB)	(dB)	(dBm)	(dBm)	(dB)
WCDMA Band V Channel 4233										
207.65	42.67	63	1.6	H	-67.84	0.15	0.00	-67.99	-13.00	-54.99
207.65	49.22	113	1.8	V	-58.37	0.15	0.00	-58.52	-13.00	-45.52
1693.20	59.74	295	1.1	H	-54.23	0.30	9.40	-45.13	-13.00	-32.13
1693.20	49.07	97	1.2	V	-64.46	0.30	9.40	-55.36	-13.00	-42.36
2539.80	49.50	125	2.2	H	-64.50	0.43	10.60	-54.33	-13.00	-41.33
2539.80	39.72	340	2.1	V	-70.56	0.43	10.60	-60.39	-13.00	-47.39

Cellular Band (Part 24E/27L)

Frequency	Receiver Reading	Turn table Angle	RX Antenna		Substituted			Absolute Level	Result	
			Height	Polar	SG Level	Cable	Antenna Gain		Limit	Margin
(MHz)	(dB μ V)	Degree	(m)	(H/V)	(dBm)	(dB)	(dB)	(dBm)	(dBm)	(dB)
WCDMA Band II Channel 9400										
207.65	48.44	259	1.5	H	-62.07	0.15	0.00	-62.22	-13.00	-49.22
207.65	40.27	66	2.0	V	-67.32	0.15	0.00	-67.47	-13.00	-54.47
3760.00	59.13	237	1.9	H	-52.41	2.37	12.50	-42.28	-13.00	-29.28
3760.00	53.61	301	1.8	V	-56.20	2.37	12.50	-46.07	-13.00	-33.07
5640.00	46.57	316	1.9	H	-63.04	2.86	12.90	-53.00	-13.00	-40.00
5640.00	37.83	219	1.2	V	-71.05	2.86	12.90	-61.01	-13.00	-48.01
WCDMA Band IV Channel 1313										
207.65	50.04	275	1.8	H	-60.47	0.15	0.00	-60.62	-13.00	-47.62
207.65	36.96	48	2.0	V	-70.63	0.15	0.00	-70.78	-13.00	-57.78
3424.80	51.39	197	1.1	H	-60.15	2.37	12.50	-50.02	-13.00	-37.02
3424.80	45.57	100	2.2	V	-64.24	2.37	12.50	-54.11	-13.00	-41.11
5137.20	38.85	196	1.7	H	-70.76	2.86	12.90	-60.72	-13.00	-47.72
5137.20	32.25	274	1.2	V	-76.63	2.86	12.90	-66.59	-13.00	-53.59

Note: 1) Absolute Level = SG Level - Cable loss + Antenna Gain

2) Margin = Absolute Level - Limit

12 Band Edge Measurement

Test Requirement:	FCC Part 2.1051, 22.917(a), 24.238(a), 27.53(h)
Test Method:	TIA/EIA-603-E:2016 ANSI C63.26:2015
Test Mode:	TX transmitting

12.1 EUT Operation

Operating Environment :

Temperature:	24.2 °C
Humidity:	53.9 % RH
Atmospheric Pressure:	101.4kPa

12.2 Test Procedure

The RF output of the transmitter was connected to the input of the spectrum analyzer through sufficient attenuation.

According to FCC Part 22.917(a), the power of any emissions outside of the authorized operating frequency ranges must be attenuated below the transmitting power (P) by a factor of at least $43 + 10 \log(P)$ dB.

According to FCC Part 24.238(a), the power of any emissions outside of the authorized operating frequency ranges must be attenuated below the transmitting power (P) by a factor of at least $43 + 10 \log(P)$ dB.

According to FCC Part 27.53(h), Except as otherwise specified below, for operations in the 1695-1710 MHz, 1710-1755 MHz, 1755-1780 MHz, 1915-1920 MHz, 1995-2000 MHz, 2000-2020 MHz, 2110-2155 MHz, 2155-2180 MHz, and 2180-2200 bands, the power of any emission outside a licensee's frequency block shall be attenuated below the transmitter power (P) in watts by at least $43 + 10 \log_{10}(P)$ dB.

The center of the spectrum analyzer was set to block edge frequency

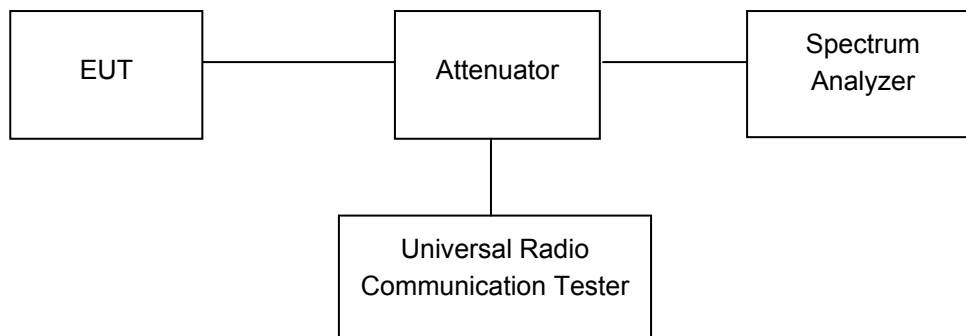

12.3 Test Result

Test plots

Cellular Band (Part 22H)

WCDMA band V band edge-left side

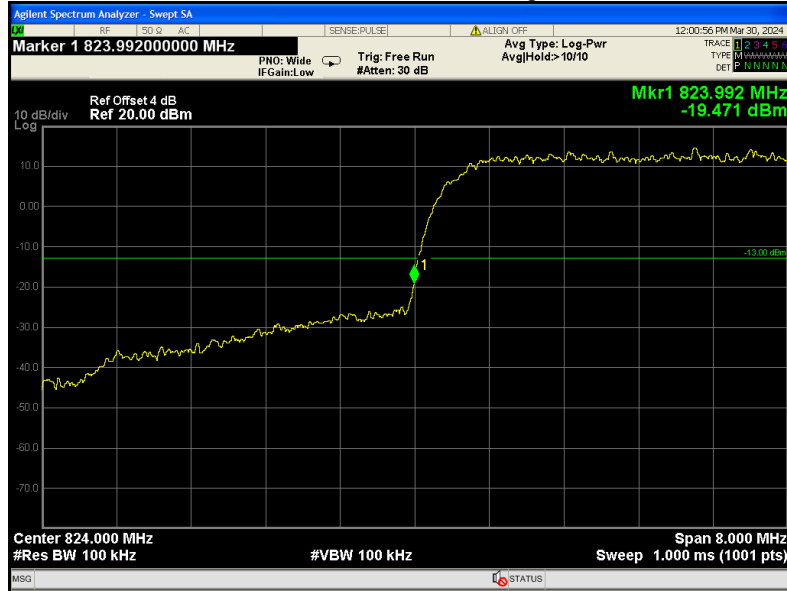

WCDMA band V band edge-right side

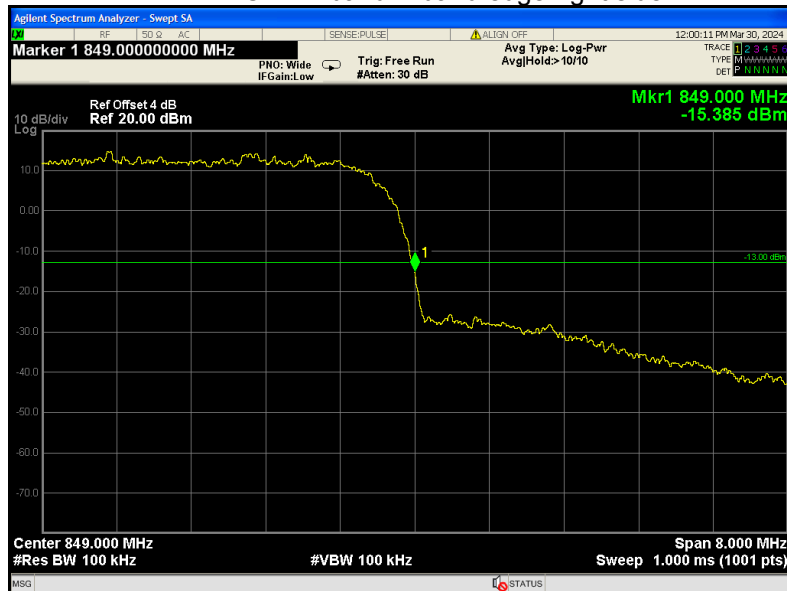

WCDMA band V band edge-left side (HSDPA)

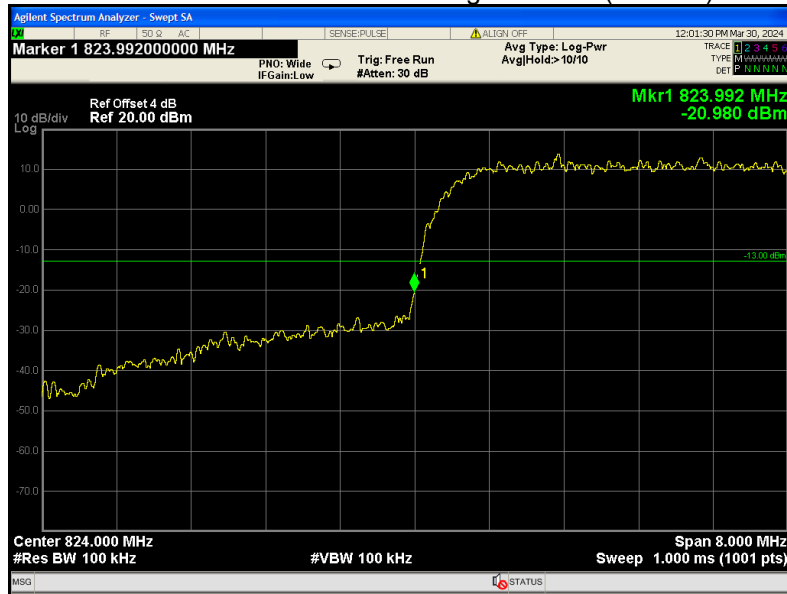

WCDMA band V band edge-right side (HSDPA)



WCDMA band V band edge-left side (HSUPA)

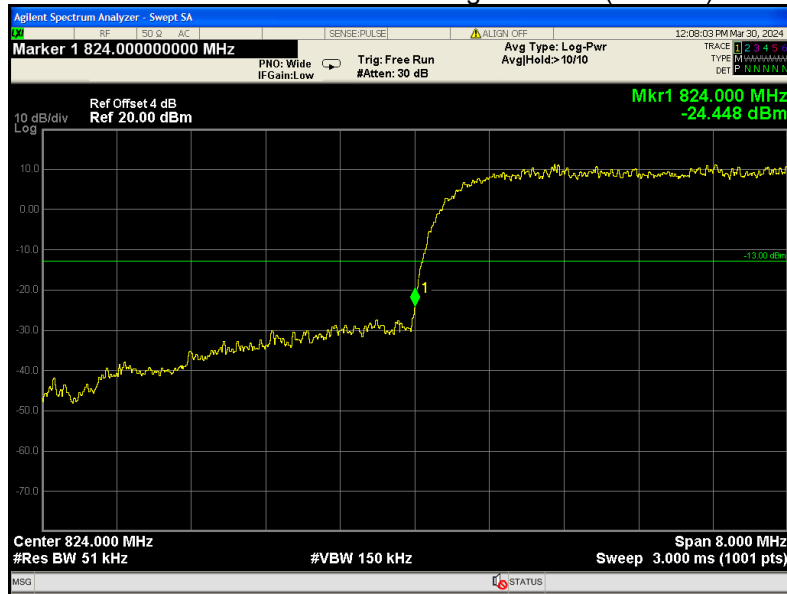

WCDMA band V band edge-right side (HSUPA)

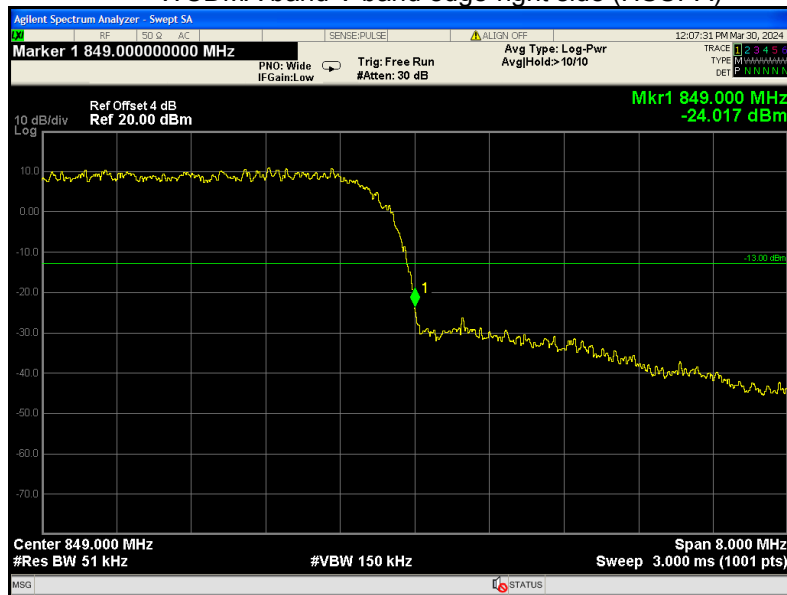

Cellular Band (Part 24E)

WCDMA band II band edge-left side

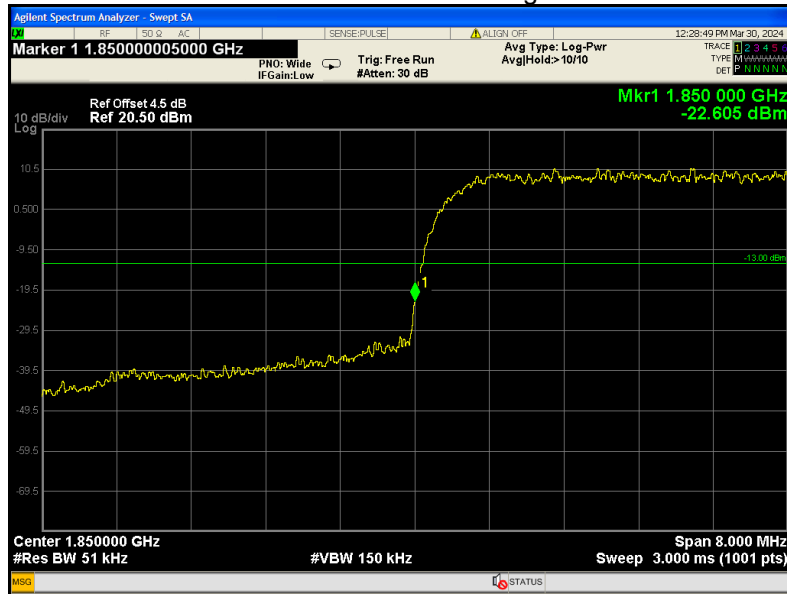

WCDMA band II band edge-right side



WCDMA band II band edge-left side (HSDPA)

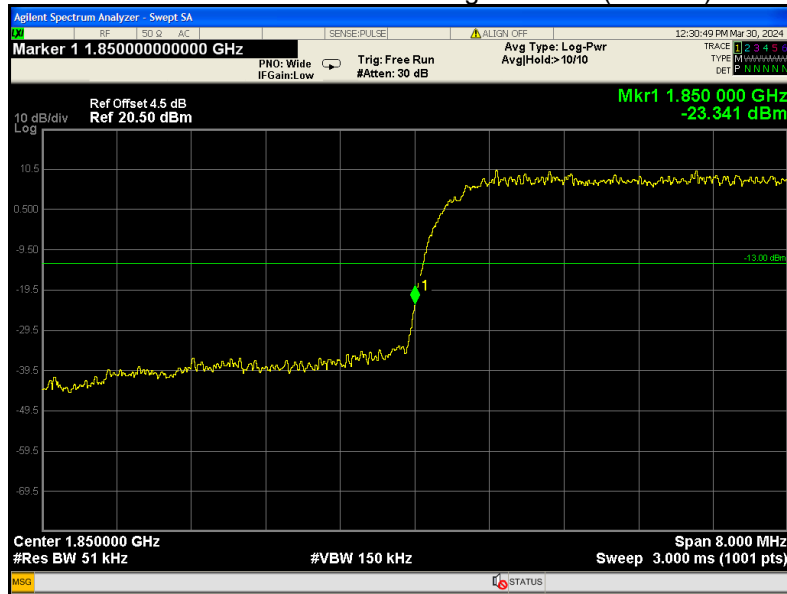

WCDMA band II band edge-right side (HSDPA)



WCDMA band II band edge-left side (HSUPA)

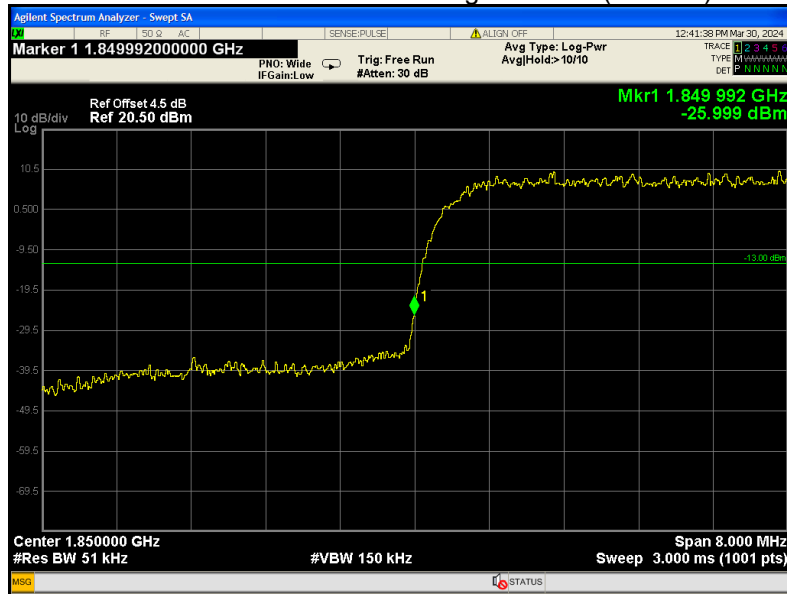

WCDMA band II band edge-right side (HSUPA)

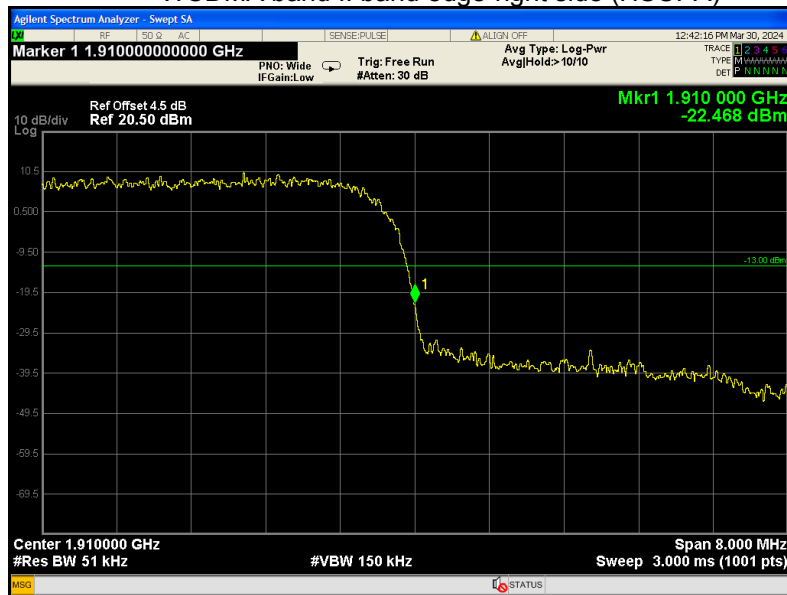

Part 27L

WCDMA band IV band edge-left side

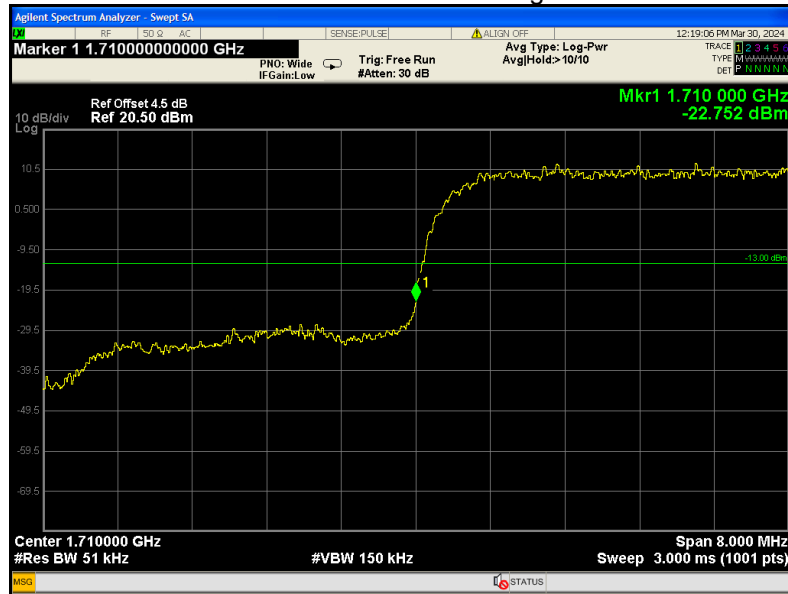

WCDMA band IV band edge-right side

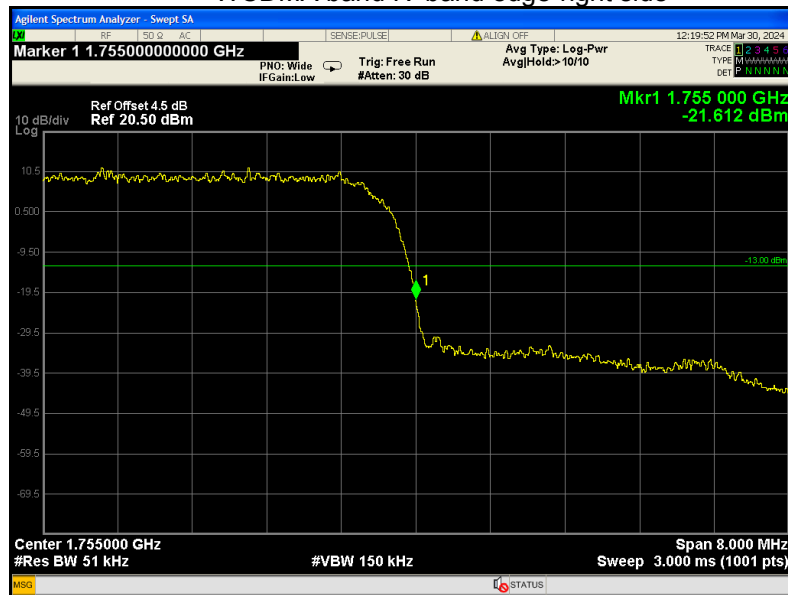

WCDMA band IV band edge-left side (HSDPA)

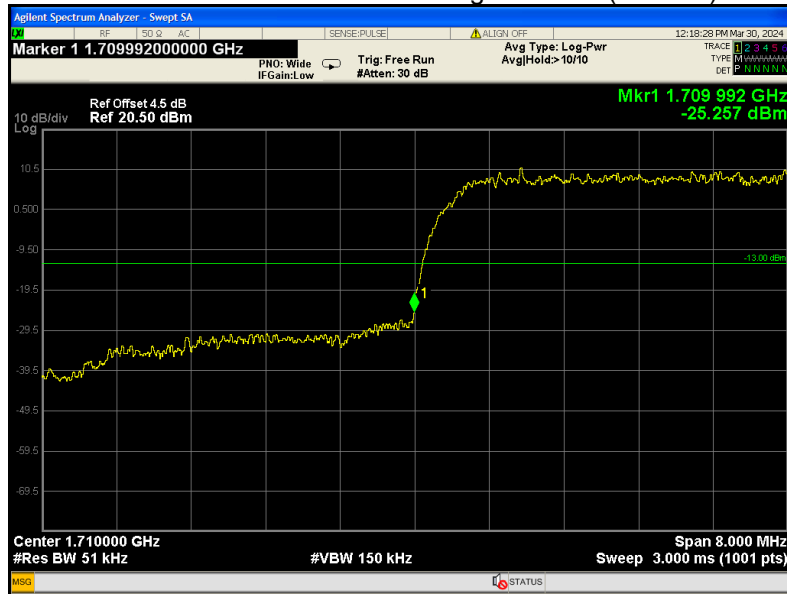

WCDMA band IV band edge-right side (HSDPA)



WCDMA band IV band edge-left side (HSUPA)

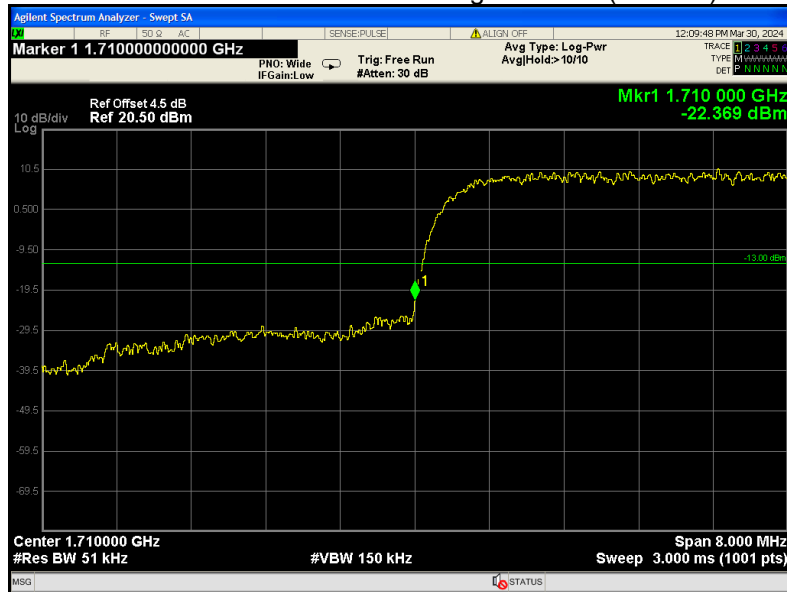

WCDMA band IV band edge-right side (HSUPA)



13 Frequency Stability

Test Requirement:	FCC Part 2.1055, 22.355, 24.235, 27.5(h),27.54
Test Method:	TIA/EIA-603-E:2016 ANSI C63.26:2015
Test Mode:	TX transmitting

13.1 EUT Operation

Operating Environment :	
Temperature:	24.6 °C
Humidity:	55.1 % RH
Atmospheric Pressure:	101.2kPa

13.2 Test Procedure

Frequency Stability vs. Temperature: The equipment under test was connected to an external DC power supply and the RF output was connected to communication test set via feed-through attenuators. The EUT was placed inside the temperature chamber. The DC leads and RF output cable exited the chamber through an opening made for the purpose.

After the temperature stabilized for approximately 20 minutes, the frequency output was recorded from the communication test set.

Frequency Stability vs. Voltage: For hand carried, battery powered equipment; reduce primary supply voltage to the battery operating end point which shall be specified by the manufacturer.

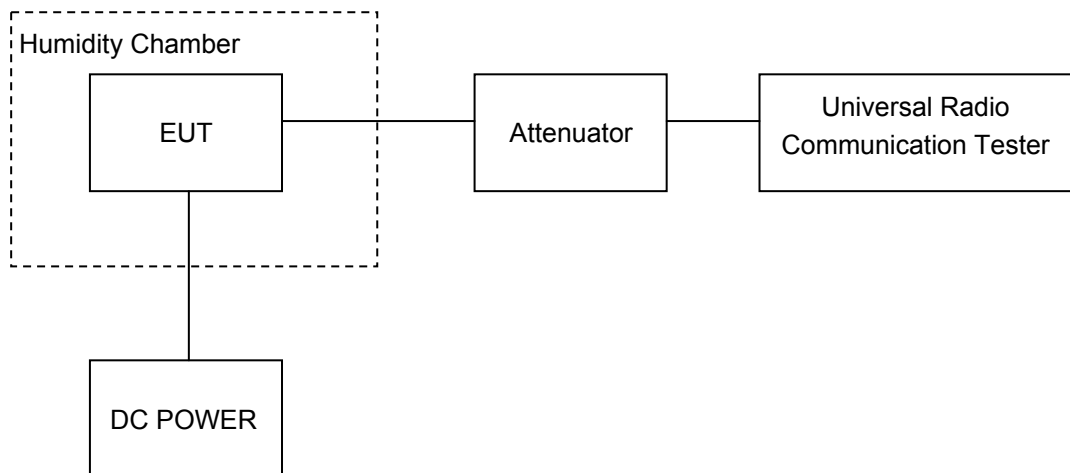

13.3 Test Result

Cellular Band (Part 22H)

WCDMA Band V Test Frequency:836.6MHz				
Temperature (°C)	Power Supply (VDC)	Frequency Error (Hz)	Frequency Error (ppm)	Limit (ppm)
50	3.7	-5	-0.0060	2.5
40		10	0.0120	2.5
30		2	0.0024	2.5
20		3	0.0036	2.5
10		7	0.0084	2.5
0		-6	-0.0072	2.5
-10		4	0.0048	2.5
-20		-5	-0.0060	2.5
-30		-5	-0.0060	2.5
20		3.3	9	0.0108
20	4.2	9	0.0108	2.5

WCDMA Band V Test Frequency:836.6MHz(HSDPA)				
Temperature (°C)	Power Supply (VDC)	Frequency Error (Hz)	Frequency Error (ppm)	Limit (ppm)
50	3.7	7	0.0084	2.5
40		1	0.0012	2.5
30		-2	-0.0024	2.5
20		5	0.0060	2.5
10		-2	-0.0024	2.5
0		10	0.0120	2.5
-10		7	0.0084	2.5
-20		-2	-0.0024	2.5
-30		12	0.0143	2.5
20		3.3	0	0.0000
20	4.2	14	0.0167	2.5

WCDMA Band V Test Frequency:836.6MHz(HSUPA)				
Temperature (°C)	Power Supply (VDC)	Frequency Error (Hz)	Frequency Error (ppm)	Limit (ppm)
50	3.7	3	0.0036	2.5
40		11	0.0131	2.5
30		1	0.0012	2.5
20		4	0.0048	2.5
10		3	0.0036	2.5
0		11	0.0131	2.5
-10		-3	-0.0036	2.5
-20		-2	-0.0024	2.5
-30		8	0.0096	2.5
20		3.3	-1	-0.0012
20	4.2	5	0.0060	2.5

PCS Band (Part 24E)

WCDMA Band II Test Frequency:1880.0MHz				
Temperature (°C)	Power Supply (VDC)	Frequency Error (Hz)	Frequency Error (ppm)	Limit (ppm)
50	3.7	7	0.0037	2.5
40		13	0.0069	2.5
30		13	0.0069	2.5
20		6	0.0032	2.5
10		12	0.0064	2.5
0		1	0.0005	2.5
-10		11	0.0059	2.5
-20		3	0.0016	2.5
-30		9	0.0048	2.5
20		3.3	11	0.0059
20	4.2	-2	-0.0011	2.5

WCDMA Band II Test Frequency:1880.0MHz(HSDPA)				
Temperature (°C)	Power Supply (VDC)	Frequency Error (Hz)	Frequency Error (ppm)	Limit (ppm)
50	3.7	1	0.0005	2.5
40		7	0.0037	2.5
30		13	0.0069	2.5
20		4	0.0021	2.5
10		2	0.0011	2.5
0		4	0.0021	2.5
-10		-2	-0.0011	2.5
-20		0	0.0000	2.5
-30		7	0.0037	2.5
20		3.3	9	0.0048
20	4.2	11	0.0059	2.5

WCDMA Band II Test Frequency:1880.0MHz(HSUPA)				
Temperature (°C)	Power Supply (VDC)	Frequency Error (Hz)	Frequency Error (ppm)	Limit (ppm)
50	3.7	3	0.0016	2.5
40		9	0.0048	2.5
30		16	0.0085	2.5
20		7	0.0037	2.5
10		8	0.0043	2.5
0		4	0.0021	2.5
-10		11	0.0059	2.5
-20		7	0.0037	2.5
-30		4	0.0021	2.5
20		3.3	1	0.0005
20	4.2	3	0.0016	2.5

Part 27L

WCDMA Band IV Test Frequency:1732.6MHz				
Temperature (°C)	Power Supply (VDC)	Frequency Error (Hz)	Frequency Error (ppm)	Limit (ppm)
50	3.7	10	0.0058	2.5
40		8	0.0046	2.5
30		1	0.0006	2.5
20		6	0.0035	2.5
10		0	0.0000	2.5
0		7	0.0040	2.5
-10		13	0.0075	2.5
-20		5	0.0029	2.5
-30		3	0.0017	2.5
20		3.3	13	0.0075
20	4.2	6	0.0035	2.5

WCDMA Band IV Test Frequency:1732.6MHz (HSDPA)				
Temperature (°C)	Power Supply (VDC)	Frequency Error (Hz)	Frequency Error (ppm)	Limit (ppm)
50	3.7	4	0.0023	2.5
40		12	0.0069	2.5
30		0	0.0000	2.5
20		7	0.0040	2.5
10		1	0.0006	2.5
0		12	0.0069	2.5
-10		3	0.0017	2.5
-20		8	0.0046	2.5
-30		4	0.0023	2.5
20		3.3	16	0.0092
20	4.2	12	0.0069	2.5

WCDMA Band IV Test Frequency:1732.6MHz (HSUPA)				
Temperature (°C)	Power Supply (VDC)	Frequency Error (Hz)	Frequency Error (ppm)	Limit (ppm)
50	3.7	7	0.0040	2.5
40		-3	-0.0017	2.5
30		12	0.0069	2.5
20		5	0.0029	2.5
10		2	0.0012	2.5
0		6	0.0035	2.5
-10		2	0.0012	2.5
-20		6	0.0035	2.5
-30		2	0.0012	2.5
20		3.3	5	0.0029
20	4.2	1	0.0006	2.5

