



# RF Test Report

For

**Applicant Name:** FOXX Development Inc.  
Address: 3480 Preston Ridge Road, Suite500, Alpharetta, GA 30005, USA  
EUT Name: Smart phone  
Brand Name: FOXXD  
Model Number: A62

## Issued By

**Company Name:** BTF Testing Lab (Shenzhen) Co., Ltd.  
Address: F101, 201 and 301, Building 1, Block 2, Tantou Industrial Park, Tantou Community, Songgang Street, Bao'an District, Shenzhen, China

Report Number: BTF230921R00304  
Test Standards: 47 CFR Part 15E

Test Conclusion: Pass  
FCC ID: 2AQRM-A62  
Test Date: 2023-09-22 to 2023-10-18  
Date of Issue: 2023-10-19

Prepared By:   
Date: 2023-10-19  
Approved By:   
Date: 2023-10-19

Aria Zhang / Project Engineer  
Ryan.CJ / EMC Manager

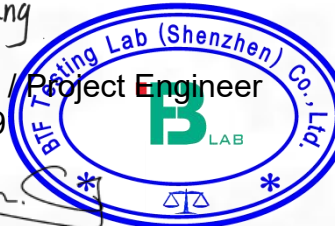

*Note: All the test results in this report only related to the testing samples. Which can be duplicated completely for the legal use with approval of applicant; it shall not be reproduced except in full without the written approval of BTF Testing Lab (Shenzhen) Co., Ltd., All the objections should be raised within thirty days from the date of issue. To validate the report, you can contact us.*

Revision History		
Version	Issue Date	Revisions Content
R_V0	2023-10-19	Original

*Note: Once the revision has been made, then previous versions reports are invalid.*

## Table of Contents

<b>1 INTRODUCTION</b> .....	<b>5</b>
1.1 Identification of Testing Laboratory .....	5
1.2 Identification of the Responsible Testing Location .....	5
1.3 Announcement .....	5
<b>2 PRODUCT INFORMATION</b> .....	<b>6</b>
2.1 Application Information .....	6
2.2 Manufacturer Information .....	6
2.3 Factory Information .....	6
2.4 General Description of Equipment under Test (EUT) .....	6
2.5 Technical Information .....	6
<b>3 SUMMARY OF TEST RESULTS</b> .....	<b>7</b>
3.1 Test Standards .....	7
3.2 Uncertainty of Test .....	7
3.3 Summary of Test Result .....	7
<b>4 TEST CONFIGURATION</b> .....	<b>8</b>
4.1 Test Equipment List .....	8
4.2 Test Auxiliary Equipment .....	14
4.3 Test Modes .....	14
<b>5 EVALUATION RESULTS (EVALUATION)</b> .....	<b>15</b>
5.1 Antenna requirement .....	15
<b>6 RADIO SPECTRUM MATTER TEST RESULTS (RF)</b> .....	<b>15</b>
<b>6.1 Conducted Emission at AC power line</b> .....	<b>15</b>
6.1.1 E.U.T. Operation: .....	15
6.1.2 Test Setup Diagram: .....	15
6.1.3 Test Data: .....	16
<b>6.2 Duty Cycle</b> .....	<b>18</b>
6.2.1 E.U.T. Operation: .....	18
6.2.2 Test Data: .....	18
<b>6.3 Maximum conducted output power</b> .....	<b>19</b>
6.3.1 E.U.T. Operation: .....	20
6.3.2 Test Data: .....	20
<b>6.4 Power spectral density</b> .....	<b>21</b>
6.4.1 E.U.T. Operation: .....	22
6.4.2 Test Data: .....	22
<b>6.5 Emission bandwidth and occupied bandwidth</b> .....	<b>23</b>
6.5.1 E.U.T. Operation: .....	24
6.5.2 Test Data: .....	24
<b>6.6 Band edge emissions (Radiated)</b> .....	<b>25</b>
6.6.1 E.U.T. Operation: .....	26
6.6.2 Test Setup Diagram: .....	27
6.6.3 Test Data: .....	28
<b>6.7 Undesirable emission limits (below 1GHz)</b> .....	<b>30</b>
6.7.1 E.U.T. Operation: .....	31
6.7.2 Test Setup Diagram: .....	32
6.7.3 Test Data: .....	33
<b>6.8 Undesirable emission limits (above 1GHz)</b> .....	<b>35</b>
6.8.1 E.U.T. Operation: .....	36



6.8.2 Test Data:..... 37

**7 TEST SETUP PHOTOS.....41**

**8 EUT CONSTRUCTIONAL DETAILS (EUT PHOTOS).....43**

**APPENDIX.....44**

## 1 Introduction

### 1.1 Identification of Testing Laboratory

Company Name:	BTF Testing Lab (Shenzhen) Co., Ltd.
Address:	F101, 201 and 301, Building 1, Block 2, Tantou Industrial Park, Tantou Community, Songgang Street, Bao'an District, Shenzhen, China
Phone Number:	+86-0755-23146130
Fax Number:	+86-0755-23146130

### 1.2 Identification of the Responsible Testing Location

Company Name:	BTF Testing Lab (Shenzhen) Co., Ltd.
Address:	F101, 201 and 301, Building 1, Block 2, Tantou Industrial Park, Tantou Community, Songgang Street, Bao'an District, Shenzhen, China
Phone Number:	+86-0755-23146130
Fax Number:	+86-0755-23146130
FCC Registration Number:	518915
Designation Number:	CN1330

### 1.3 Announcement

- (1) The test report reference to the report template version v0.
- (2) The test report is invalid if not marked with the signatures of the persons responsible for preparing, reviewing and approving the test report.
- (3) The test report is invalid if there is any evidence and/or falsification.
- (4) This document may not be altered or revised in any way unless done so by BTF and all revisions are duly noted in the revisions section.
- (5) Content of the test report, in part or in full, cannot be used for publicity and/or promotional purposes without prior written approval from the laboratory.
- (6) The laboratory is only responsible for the data released by the laboratory, except for the part provided by the applicant.

## 2 Product Information

### 2.1 Application Information

Company Name:	FOXX Development Inc.
Address:	3480 Preston Ridge Road, Suite500, Alpharetta, GA 30005, USA

### 2.2 Manufacturer Information

Company Name:	FOXX Development Inc.
Address:	3480 Preston Ridge Road, Suite500, Alpharetta, GA 30005, USA

### 2.3 Factory Information

Company Name:	FOXX Development Inc.
Address:	3480 Preston Ridge Road, Suite500, Alpharetta, GA 30005, USA

### 2.4 General Description of Equipment under Test (EUT)

EUT Name:	Smart phone
Test Model Number:	A62
Hardware Version:	H327_MB_V1
Software Version:	Android_FOXXD_A62_V1.0

### 2.5 Technical Information

Power Supply:	DC 5V from adapter
Operation Frequency Range	U-NII Band 1: 5.18~5.24 GHz U-NII Band 3: 5.745~5.825 GHz
Frequency Block	U-NII Band 1: 5.15~5.25 GHz U-NII Band 3: 5.725~5.825 GHz
Channel Bandwidth	802.11a: 20 MHz 802.11n: 20 MHz, 40 MHz 802.11ac: 20 MHz, 40 MHz
Antenna Type:	PIFA Antenna
Antenna Gain:	0.95 dBi

Note:

#: The antenna gain provided by the applicant, and the laboratory will not be responsible for the accumulated calculation results which covers the information provided by the applicant.

### 3 Summary of Test Results

#### 3.1 Test Standards

The tests were performed according to following standards:

**47 CFR Part 15E:** Unlicensed National Information Infrastructure Devices

#### 3.2 Uncertainty of Test

Item	Measurement Uncertainty
Conducted Emission (150 kHz-30 MHz)	±2.64dB
The following measurement uncertainty levels have been estimated for tests performed on the EUT as specified in CISPR 16-4-2. This uncertainty represents an expanded uncertainty expressed at approximately the 95% confidence level using a coverage factor of k=2.	

#### 3.3 Summary of Test Result

Item	Standard	Requirement	Result
Antenna requirement	47 CFR Part 15E	Part 15.203	Pass
Conducted Emission at AC power line	47 CFR Part 15E	47 CFR Part 15.207(a)	Pass
Maximum conducted output power	47 CFR Part 15E	47 CFR Part 15.407(a)(1)(i) 47 CFR Part 15.407(a)(1)(ii) 47 CFR Part 15.407(a)(1)(iii) 47 CFR Part 15.407(a)(1)(iv) 47 CFR Part 15.407(a)(2) 47 CFR Part 15.407(a)(3)(i)	Pass
Power spectral density	47 CFR Part 15E	47 CFR Part 15.407(a)(1)(i) 47 CFR Part 15.407(a)(1)(ii) 47 CFR Part 15.407(a)(1)(iii) 47 CFR Part 15.407(a)(1)(iv) 47 CFR Part 15.407(a)(2) 47 CFR Part 15.407(a)(3)(i)	Pass
Emission bandwidth and occupied bandwidth	47 CFR Part 15E	U-NII 1, U-NII 2A, U-NII 2C: No limits, only for report use. 47 CFR Part 15.407(e)	Pass
Channel Availability Check Time	47 CFR Part 15E	47 CFR Part 15.407(h)(2)(ii)	Pass
U-NII Detection Bandwidth	47 CFR Part 15E	47 CFR Part 15.407(h)(2)	Pass
Statistical Performance Check	47 CFR Part 15E	KDB 935210 D02, Clause 5.1 Table 2	Pass
Channel Move Time, Channel Closing Transmission Time	47 CFR Part 15E	47 CFR Part 15.407(h)(2)(iii)	Pass
Non-Occupancy Period Test	47 CFR Part 15E	47 CFR Part 15.407(h)(2)(iv)	Pass
DFS Detection Thresholds	47 CFR Part 15E	KDB 905462 D02, Clause 5.2 Table 3	Pass
Band edge emissions (Radiated)	47 CFR Part 15E	47 CFR Part 15.407(b)(1) 47 CFR Part 15.407(b)(2) 47 CFR Part 15.407(b)(4) 47 CFR Part 15.407(b)(10)	Pass
Undesirable emission limits (below 1GHz)	47 CFR Part 15E	47 CFR Part 15.407(b)(9)	Pass
Undesirable emission limits (above 1GHz)	47 CFR Part 15E	47 CFR Part 15.407(b)(1) 47 CFR Part 15.407(b)(2) 47 CFR Part 15.407(b)(4)	Pass

		47 CFR Part 15.407(b)(10)	
--	--	---------------------------	--

## 4 Test Configuration

### 4.1 Test Equipment List

Conducted Emission at AC power line					
Equipment	Manufacturer	Model No	Inventory No	Cal Date	Cal Due Date
Pulse Limiter	SCHWARZBECK	VTSD 9561-F	00953	2022-11-24	2023-11-23
Coaxial Switcher	SCHWARZBECK	CX210	CX210	2022-11-24	2023-11-23
V-LISN	SCHWARZBECK	NSLK 8127	01073	2022-11-24	2023-11-23
LISN	AFJ	LS16/110VAC	16010020076	2023-02-23	2024-02-22
EMI Receiver	ROHDE&SCHWARZ	ESCI3	101422	2022-11-24	2023-11-23

Duty Cycle					
Equipment	Manufacturer	Model No	Inventory No	Cal Date	Cal Due Date
RFTest software	/	V1.00	/	/	/
RF Control Unit	Techy	TR1029-1	/	2022-11-24	2023-11-23
RF Sensor Unit	Techy	TR1029-2	/	2022-11-24	2023-11-23
Programmable constant temperature and humidity box	ZZCKONG	ZZ-K02A	20210928007	2022-11-24	2023-11-23
Adjustable Direct Current Regulated Power Supply	Dongguan Tongmen Electronic Technology Co., LTD	etm-6050c	20211026123	2022-11-24	2023-11-23
WIDEBAND RADIO COMMUNICATION TESTER	Rohde & Schwarz	CMW500	161997	2022-11-24	2023-11-23
MXA Signal Analyzer	KEYSIGHT	N9020A	MY50410020	2022-11-24	2023-11-23

Maximum conducted output power					
Equipment	Manufacturer	Model No	Inventory No	Cal Date	Cal Due Date
RFTest software	/	V1.00	/	/	/
RF Control Unit	Techy	TR1029-1	/	2022-11-24	2023-11-23
RF Sensor Unit	Techy	TR1029-2	/	2022-11-24	2023-11-23
Programmable constant temperature and humidity box	ZZCKONG	ZZ-K02A	20210928007	2022-11-24	2023-11-23
Adjustable Direct Current Regulated Power Supply	Dongguan Tongmen Electronic Technology Co., LTD	etm-6050c	20211026123	2022-11-24	2023-11-23
WIDEBAND RADIO COMMUNICATION TESTER	Rohde & Schwarz	CMW500	161997	2022-11-24	2023-11-23
MXA Signal Analyzer	KEYSIGHT	N9020A	MY50410020	2022-11-24	2023-11-23



Power spectral density					
Equipment	Manufacturer	Model No	Inventory No	Cal Date	Cal Due Date
RFTest software	/	V1.00	/	/	/
RF Control Unit	Techy	TR1029-1	/	2022-11-24	2023-11-23
RF Sensor Unit	Techy	TR1029-2	/	2022-11-24	2023-11-23
Programmable constant temperature and humidity box	ZZCKONG	ZZ-K02A	20210928007	2022-11-24	2023-11-23
Adjustable Direct Current Regulated Power Supply	Dongguan Tongmen Electronic Technology Co., LTD	etm-6050c	20211026123	2022-11-24	2023-11-23
WIDEBAND RADIO COMMUNICATION TESTER	Rohde & Schwarz	CMW500	161997	2022-11-24	2023-11-23
MXA Signal Analyzer	KEYSIGHT	N9020A	MY50410020	2022-11-24	2023-11-23

Emission bandwidth and occupied bandwidth					
Equipment	Manufacturer	Model No	Inventory No	Cal Date	Cal Due Date
RFTest software	/	V1.00	/	/	/
RF Control Unit	Techy	TR1029-1	/	2022-11-24	2023-11-23
RF Sensor Unit	Techy	TR1029-2	/	2022-11-24	2023-11-23
Programmable constant temperature and humidity box	ZZCKONG	ZZ-K02A	20210928007	2022-11-24	2023-11-23
Adjustable Direct Current Regulated Power Supply	Dongguan Tongmen Electronic Technology Co., LTD	etm-6050c	20211026123	2022-11-24	2023-11-23
WIDEBAND RADIO COMMUNICATION TESTER	Rohde & Schwarz	CMW500	161997	2022-11-24	2023-11-23
MXA Signal Analyzer	KEYSIGHT	N9020A	MY50410020	2022-11-24	2023-11-23

Channel Availability Check Time					
Equipment	Manufacturer	Model No	Inventory No	Cal Date	Cal Due Date
RFTest software	/	V1.00	/	/	/
RF Control Unit	Techy	TR1029-1	/	2022-11-24	2023-11-23
RF Sensor Unit	Techy	TR1029-2	/	2022-11-24	2023-11-23
Programmable constant temperature and humidity box	ZZCKONG	ZZ-K02A	20210928007	2022-11-24	2023-11-23
Adjustable Direct Current Regulated Power Supply	Dongguan Tongmen Electronic Technology Co., LTD	etm-6050c	20211026123	2022-11-24	2023-11-23



WIDEBAND RADIO COMMUNICATION TESTER	Rohde & Schwarz	CMW500	161997	2022-11-24	2023-11-23
MXA Signal Analyzer	KEYSIGHT	N9020A	MY50410020	2022-11-24	2023-11-23

**U-NII Detection Bandwidth**

Equipment	Manufacturer	Model No	Inventory No	Cal Date	Cal Due Date
RFTest software	/	V1.00	/	/	/
RF Control Unit	Techy	TR1029-1	/	2022-11-24	2023-11-23
RF Sensor Unit	Techy	TR1029-2	/	2022-11-24	2023-11-23
Programmable constant temperature and humidity box	ZZCKONG	ZZ-K02A	20210928007	2022-11-24	2023-11-23
Adjustable Direct Current Regulated Power Supply	Dongguan Tongmen Electronic Technology Co., LTD	etm-6050c	20211026123	2022-11-24	2023-11-23
WIDEBAND RADIO COMMUNICATION TESTER	Rohde & Schwarz	CMW500	161997	2022-11-24	2023-11-23
MXA Signal Analyzer	KEYSIGHT	N9020A	MY50410020	2022-11-24	2023-11-23

**Statistical Performance Check**

Equipment	Manufacturer	Model No	Inventory No	Cal Date	Cal Due Date
RFTest software	/	V1.00	/	/	/
RF Control Unit	Techy	TR1029-1	/	2022-11-24	2023-11-23
RF Sensor Unit	Techy	TR1029-2	/	2022-11-24	2023-11-23
Programmable constant temperature and humidity box	ZZCKONG	ZZ-K02A	20210928007	2022-11-24	2023-11-23
Adjustable Direct Current Regulated Power Supply	Dongguan Tongmen Electronic Technology Co., LTD	etm-6050c	20211026123	2022-11-24	2023-11-23
WIDEBAND RADIO COMMUNICATION TESTER	Rohde & Schwarz	CMW500	161997	2022-11-24	2023-11-23
MXA Signal Analyzer	KEYSIGHT	N9020A	MY50410020	2022-11-24	2023-11-23

**Channel Move Time, Channel Closing Transmission Time**

Equipment	Manufacturer	Model No	Inventory No	Cal Date	Cal Due Date
RFTest software	/	V1.00	/	/	/
RF Control Unit	Techy	TR1029-1	/	2022-11-24	2023-11-23
RF Sensor Unit	Techy	TR1029-2	/	2022-11-24	2023-11-23
Programmable constant temperature and humidity box	ZZCKONG	ZZ-K02A	20210928007	2022-11-24	2023-11-23
Adjustable Direct Current Regulated	Dongguan Tongmen	etm-6050c	20211026123	2022-11-24	2023-11-23

Power Supply	Electronic Technology Co., LTD				
WIDEBAND RADIO COMMUNICATION TESTER	Rohde & Schwarz	CMW500	161997	2022-11-24	2023-11-23
MXA Signal Analyzer	KEYSIGHT	N9020A	MY50410020	2022-11-24	2023-11-23

**Non-Occupancy Period Test**

Equipment	Manufacturer	Model No	Inventory No	Cal Date	Cal Due Date
RFTest software	/	V1.00	/	/	/
RF Control Unit	Techy	TR1029-1	/	2022-11-24	2023-11-23
RF Sensor Unit	Techy	TR1029-2	/	2022-11-24	2023-11-23
Programmable constant temperature and humidity box	ZZCKONG	ZZ-K02A	20210928007	2022-11-24	2023-11-23
Adjustable Direct Current Regulated Power Supply	Dongguan Tongmen Electronic Technology Co., LTD	etm-6050c	20211026123	2022-11-24	2023-11-23
WIDEBAND RADIO COMMUNICATION TESTER	Rohde & Schwarz	CMW500	161997	2022-11-24	2023-11-23
MXA Signal Analyzer	KEYSIGHT	N9020A	MY50410020	2022-11-24	2023-11-23

**DFS Detection Thresholds**

Equipment	Manufacturer	Model No	Inventory No	Cal Date	Cal Due Date
RFTest software	/	V1.00	/	/	/
RF Control Unit	Techy	TR1029-1	/	2022-11-24	2023-11-23
RF Sensor Unit	Techy	TR1029-2	/	2022-11-24	2023-11-23
Programmable constant temperature and humidity box	ZZCKONG	ZZ-K02A	20210928007	2022-11-24	2023-11-23
Adjustable Direct Current Regulated Power Supply	Dongguan Tongmen Electronic Technology Co., LTD	etm-6050c	20211026123	2022-11-24	2023-11-23
WIDEBAND RADIO COMMUNICATION TESTER	Rohde & Schwarz	CMW500	161997	2022-11-24	2023-11-23
MXA Signal Analyzer	KEYSIGHT	N9020A	MY50410020	2022-11-24	2023-11-23

**Band edge emissions (Radiated)**

Equipment	Manufacturer	Model No	Inventory No	Cal Date	Cal Due Date
Coaxial cable Multiflex 141	Schwarzbeck	N/SMA 0.5m	517386	2023-03-24	2024-03-23
Preamplifier	SCHWARZBECK	BBV9744	00246	2022-11-24	2023-11-23
RE Cable	REBES Talent	UF1-SMASMAM-10m	21101566	2022-11-24	2023-11-23

RE Cable	REBES Talent	UF2-NMNM-10m	21101570	2022-11-24	2023-11-23
RE Cable	REBES Talent	UF1-SMASMAM-1m	21101568	2022-11-24	2023-11-23
RE Cable	REBES Talent	UF2-NMNM-1m	21101576	2022-11-24	2023-11-23
RE Cable	REBES Talent	UF2-NMNM-2.5m	21101573	2022-11-24	2023-11-23
POSITIONAL CONTROLLER	SKET	PCI-GPIB	/	/	/
Horn Antenna	SCHWARZBECK	BBHA9170	01157	2021-11-28	2023-11-27
EMI TEST RECEIVER	ROHDE&SCHWARZ	ESCI7	101032	2022-11-24	2023-11-23
SIGNAL ANALYZER	ROHDE&SCHWARZ	FSQ40	100010	2022-11-24	2023-11-23
POSITIONAL CONTROLLER	SKET	PCI-GPIB	/	/	/
Broadband Preampilifier	SCHWARZBECK	BBV9718D	00008	2023-03-24	2024-03-23
Horn Antenna	SCHWARZBECK	BBHA9120D	2597	2022-05-22	2024-05-21
EZ EMC	Frad	FA-03A2 RE+	/	/	/
POSITIONAL CONTROLLER	SKET	PCI-GPIB	/	/	/
Log periodic antenna	SCHWARZBECK	VULB 9168	01328	2021-11-28	2023-11-27

Undesirable emission limits (below 1GHz)					
Equipment	Manufacturer	Model No	Inventory No	Cal Date	Cal Due Date
Coaxial cable Multiflex 141	Schwarzbeck	N/SMA 0.5m	517386	2023-03-24	2024-03-23
Preampilifier	SCHWARZBECK	BBV9744	00246	2022-11-24	2023-11-23
RE Cable	REBES Talent	UF1-SMASMAM-10m	21101566	2022-11-24	2023-11-23
RE Cable	REBES Talent	UF2-NMNM-10m	21101570	2022-11-24	2023-11-23
RE Cable	REBES Talent	UF1-SMASMAM-1m	21101568	2022-11-24	2023-11-23
RE Cable	REBES Talent	UF2-NMNM-1m	21101576	2022-11-24	2023-11-23
RE Cable	REBES Talent	UF2-NMNM-2.5m	21101573	2022-11-24	2023-11-23
POSITIONAL CONTROLLER	SKET	PCI-GPIB	/	/	/
Horn Antenna	SCHWARZBECK	BBHA9170	01157	2021-11-28	2023-11-27
EMI TEST RECEIVER	ROHDE&SCHWARZ	ESCI7	101032	2022-11-24	2023-11-23
SIGNAL ANALYZER	ROHDE&SCHWARZ	FSQ40	100010	2022-11-24	2023-11-23
POSITIONAL CONTROLLER	SKET	PCI-GPIB	/	/	/
Broadband Preampilifier	SCHWARZBECK	BBV9718D	00008	2023-03-24	2024-03-23
Horn Antenna	SCHWARZBECK	BBHA9120D	2597	2022-05-22	2024-05-21
EZ EMC	Frad	FA-03A2 RE+	/	/	/
POSITIONAL CONTROLLER	SKET	PCI-GPIB	/	/	/
Log periodic antenna	SCHWARZBECK	VULB 9168	01328	2021-11-28	2023-11-27

Undesirable emission limits (above 1GHz)					
Equipment	Manufacturer	Model No	Inventory No	Cal Date	Cal Due Date
Coaxial cable Multiflex 141	Schwarzbeck	N/SMA 0.5m	517386	2023-03-24	2024-03-23
Preamplifier	SCHWARZBECK	BBV9744	00246	2022-11-24	2023-11-23
RE Cable	REBES Talent	UF1-SMASMAM-10m	21101566	2022-11-24	2023-11-23
RE Cable	REBES Talent	UF2-NMNM-10m	21101570	2022-11-24	2023-11-23
RE Cable	REBES Talent	UF1-SMASMAM-1m	21101568	2022-11-24	2023-11-23
RE Cable	REBES Talent	UF2-NMNM-1m	21101576	2022-11-24	2023-11-23
RE Cable	REBES Talent	UF2-NMNM-2.5m	21101573	2022-11-24	2023-11-23
POSITIONAL CONTROLLER	SKET	PCI-GPIB	/	/	/
Horn Antenna	SCHWARZBECK	BBHA9170	01157	2021-11-28	2023-11-27
EMI TEST RECEIVER	ROHDE&SCHWARZ	ESCI7	101032	2022-11-24	2023-11-23
SIGNAL ANALYZER	ROHDE&SCHWARZ	FSQ40	100010	2022-11-24	2023-11-23
POSITIONAL CONTROLLER	SKET	PCI-GPIB	/	/	/
Broadband Preamplifier	SCHWARZBECK	BBV9718D	00008	2023-03-24	2024-03-23
Horn Antenna	SCHWARZBECK	BBHA9120D	2597	2022-05-22	2024-05-21
EZ_EM	Frad	FA-03A2 RE+	/	/	/
POSITIONAL CONTROLLER	SKET	PCI-GPIB	/	/	/
Log periodic antenna	SCHWARZBECK	VULB 9168	01328	2021-11-28	2023-11-27

## 4.2 Test Auxiliary Equipment

The EUT was tested as an independent device.

## 4.3 Test Modes

No.	Test Modes	Description
TM1	802.11a mode	Keep the EUT connect to AC power line and works in continuously transmitting mode with 802.11a modulation type. All data rates has been tested and found the data rate @ 6Mbps is the worst case. Only the data of worst case is recorded in the report.
TM2	802.11n mode	Keep the EUT connect to AC power line and works in continuously transmitting mode with 802.11n modulation type. All bandwidth and data rates has been tested and found the data rate @ MCS0 is the worst case. Only the data of worst case is recorded in the report.
TM3	802.11ac mode	Keep the EUT connect to AC power line and works in continuously transmitting mode with 802.11ac modulation type. Only the data of worst case is recorded in the report.
TM4	Normal Operating	Keep the EUT works in normal operating mode and connect to companion device



**6.1.3 Test Data:**

TM1 / Line: Line / Band: U-NII 1 / BW: 20 / CH: L

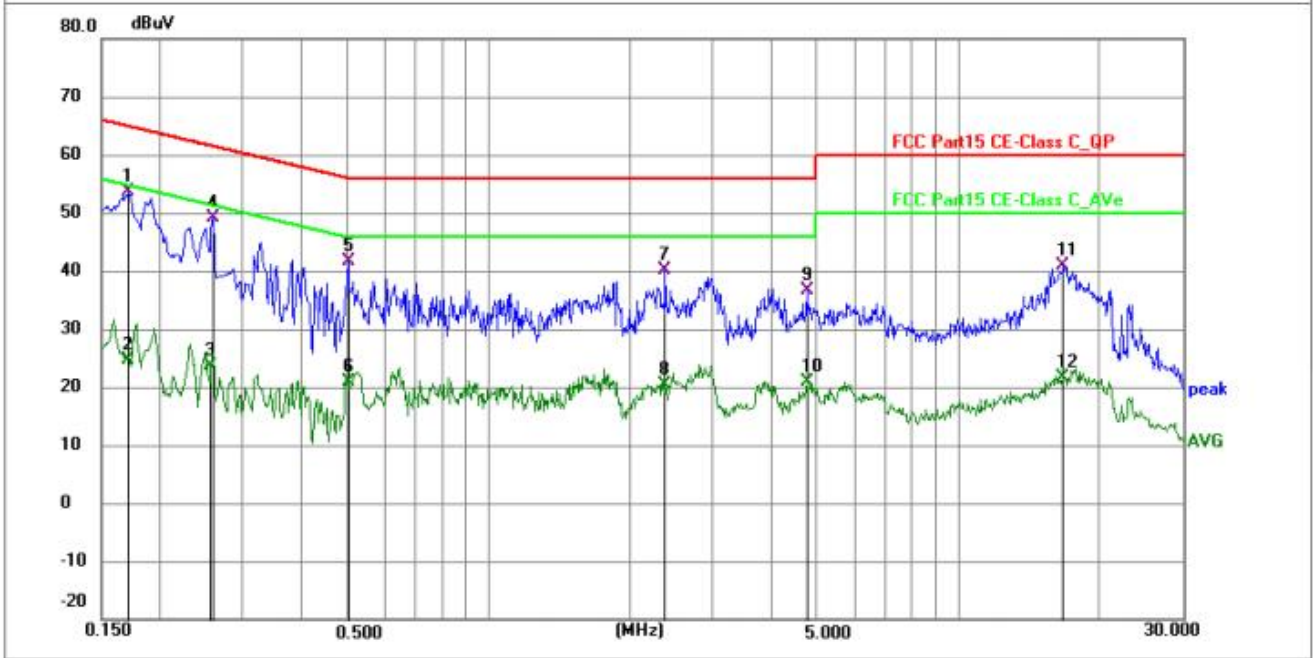

No.	Frequency (MHz)	Reading (dBuV)	Factor (dB)	Level (dBuV)	Limit (dBuV)	Margin (dB)	Detector	P/F	Remark
1 *	0.1711	43.15	10.56	53.71	64.91	-11.20	QP	P	
2	0.1720	13.96	10.56	24.52	54.86	-30.34	AVG	P	
3	0.2560	12.96	10.59	23.55	51.56	-28.01	AVG	P	
4	0.2580	38.65	10.59	49.24	61.50	-12.26	QP	P	
5	0.5010	30.96	10.61	41.57	56.00	-14.43	QP	P	
6	0.5010	10.28	10.61	20.89	46.00	-25.11	AVG	P	
7	2.3730	29.32	10.70	40.02	56.00	-15.98	QP	P	
8	2.3730	9.71	10.70	20.41	46.00	-25.59	AVG	P	
9	4.7713	25.76	10.80	36.56	56.00	-19.44	QP	P	
10	4.7713	10.05	10.80	20.85	46.00	-25.15	AVG	P	
11	16.7145	29.81	10.95	40.76	60.00	-19.24	QP	P	
12	16.7145	10.56	10.95	21.51	50.00	-28.49	AVG	P	



TM1 / Line: Neutral / Band: U-NII 1 / BW: 20 / CH: L

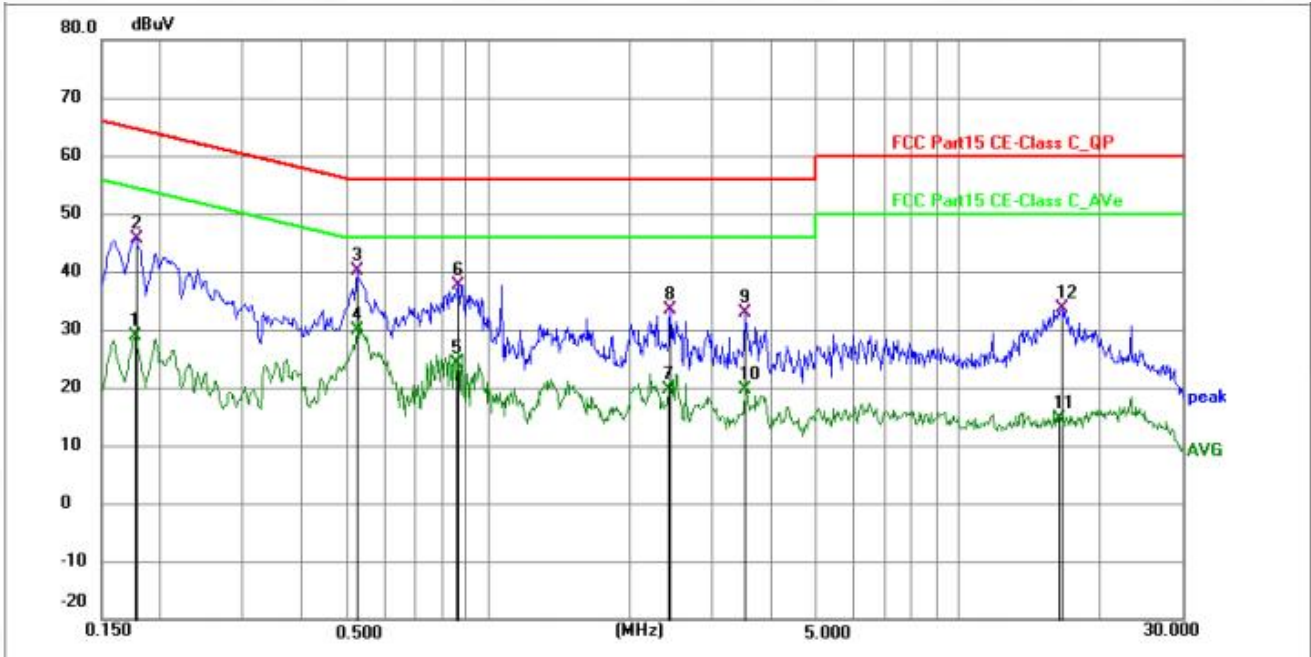

No.	Frequency (MHz)	Reading (dBuV)	Factor (dB)	Level (dBuV)	Limit (dBuV)	Margin (dB)	Detector	P/F	Remark
1	0.1766	18.38	10.56	28.94	54.64	-25.70	AVG	P	
2	0.1770	35.13	10.56	45.69	64.63	-18.94	QP	P	
3 *	0.5231	29.50	10.62	40.12	56.00	-15.88	QP	P	
4	0.5231	19.19	10.62	29.81	46.00	-16.19	AVG	P	
5	0.8610	13.30	10.76	24.06	46.00	-21.94	AVG	P	
6	0.8655	26.95	10.76	37.71	56.00	-18.29	QP	P	
7	2.4180	8.98	10.70	19.68	46.00	-26.32	AVG	P	
8	2.4450	22.59	10.70	33.29	56.00	-22.71	QP	P	
9	3.5250	22.24	10.72	32.96	56.00	-23.04	QP	P	
10	3.5250	8.94	10.72	19.66	46.00	-26.34	AVG	P	
11	16.4530	3.86	10.88	14.74	50.00	-35.26	AVG	P	
12	16.6020	22.74	10.88	33.62	60.00	-26.38	QP	P	

## 6.2 Duty Cycle

Test Requirement:	All measurements are to be performed with the EUT transmitting at 100% duty cycle at its maximum power control level; however, if 100% duty cycle cannot be achieved, measurements of duty cycle, x, and maximum-power transmission duration, T, are required for each tested mode of operation.
Test Method:	ANSI C63.10-2013 section 12.2 (b)
Test Limit:	No limits, only for report use.
Procedure:	<ul style="list-style-type: none"> <li>i) Set the center frequency of the instrument to the center frequency of the transmission.</li> <li>ii) Set RBW <math>\geq</math> EBW if possible; otherwise, set RBW to the largest available value.</li> <li>iii) Set VBW <math>\geq</math> RBW.</li> <li>iv) Set detector = peak.</li> <li>v) The zero-span measurement method shall not be used unless both RBW and VBW are <math>&gt; 50/T</math>, where T is defined in item a1) of 12.2, and the number of sweep points across duration T exceeds 100.</li> </ul>

### 6.2.1 E.U.T. Operation:

Operating Environment:	
Temperature:	25.5 °C
Humidity:	50.6 %
Atmospheric Pressure:	1010 mbar

### 6.2.2 Test Data:

Please Refer to Appendix for Details.

### 6.3 Maximum conducted output power

<p>Test Requirement:</p>	<p>47 CFR Part 15.407(a)(1)(i)          47 CFR Part 15.407(a)(1)(ii)          47 CFR Part 15.407(a)(1)(iii)          47 CFR Part 15.407(a)(1)(iv)          47 CFR Part 15.407(a)(2)          47 CFR Part 15.407(a)(3)(i)</p>
<p>Test Method:</p>	<p>ANSI C63.10-2013, section 12.3</p>
<p>Test Limit:</p>	<p>For an outdoor access point operating in the band 5.15-5.25 GHz, the maximum conducted output power over the frequency band of operation shall not exceed 1 W provided the maximum antenna gain does not exceed 6 dBi.          If transmitting antennas of directional gain greater than 6 dBi are used, the maximum conducted output power shall be reduced by the amount in dB that the directional gain of the antenna exceeds 6 dBi. The maximum e.i.r.p. at any elevation angle above 30 degrees as measured from the horizon must not exceed 125 mW (21 dBm).</p> <p>For an indoor access point operating in the band 5.15-5.25 GHz, the maximum conducted output power over the frequency band of operation shall not exceed 1 W provided the maximum antenna gain does not exceed 6 dBi.          If transmitting antennas of directional gain greater than 6 dBi are used, the maximum conducted output power shall be reduced by the amount in dB that the directional gain of the antenna exceeds 6 dBi.</p> <p>For fixed point-to-point access points operating in the band 5.15-5.25 GHz, the maximum conducted output power over the frequency band of operation shall not exceed 1 W.          Fixed point-to-point U-NII devices may employ antennas with directional gain up to 23 dBi without any corresponding reduction in the maximum conducted output power.          For fixed point-to-point transmitters that employ a directional antenna gain greater than 23 dBi, a 1 dB reduction in maximum conducted output power is required for each 1 dB of antenna gain in excess of 23 dBi.          Fixed, point-to-point operations exclude the use of point-to-multipoint systems, omnidirectional applications, and multiple collocated transmitters transmitting the same information. The operator of the U-NII device, or if the equipment is professionally installed, the installer, is responsible for ensuring that systems employing high gain directional antennas are used exclusively for fixed, point-to-point operations.</p> <p>For client devices in the 5.15-5.25 GHz band, the maximum conducted output power over the frequency band of operation shall not exceed 250 mW provided the maximum antenna gain does not exceed 6 dBi.          If transmitting antennas of directional gain greater than 6 dBi are used, the maximum conducted output power shall be reduced by the amount in dB that the directional gain of the antenna exceeds 6 dBi.</p> <p>For the 5.25-5.35 GHz and 5.47-5.725 GHz bands, the maximum conducted output power over the frequency bands of operation shall not exceed the lesser of 250 mW or <math>11 \text{ dBm} + 10 \log B</math>, where B is the 26 dB emission bandwidth in megahertz.          If transmitting antennas of directional gain greater than 6 dBi are used, the maximum conducted output power shall be reduced by the amount in dB that the directional gain of the antenna exceeds 6 dBi.</p>

	<p>For the band 5.725-5.850 GHz, the maximum conducted output power over the frequency band of operation shall not exceed 1 W.          If transmitting antennas of directional gain greater than 6 dBi are used, the maximum conducted output power shall be reduced by the amount in dB that the directional gain of the antenna exceeds 6 dBi.          However, fixed point-to-point U-NII devices operating in this band may employ transmitting antennas with directional gain greater than 6 dBi without any corresponding reduction in transmitter conducted power. Fixed, point-to-point operations exclude the use of point-to-multipoint systems, omnidirectional applications, and multiple collocated transmitters transmitting the same information. The operator of the U-NII device, or if the equipment is professionally installed, the installer, is responsible for ensuring that systems employing high gain directional antennas are used exclusively for fixed, point-to-point operations.</p>
<p>Procedure:</p>	<p>Method SA-1          a) Set span to encompass the entire 26 dB EBW or 99% OBW of the signal.          b) Set RBW = 1 MHz.          c) Set VBW <math>\geq</math> 3 MHz.          d) Number of points in sweep <math>\geq</math> <math>[2 \times \text{span} / \text{RBW}]</math>. (This gives bin-to-bin spacing <math>\leq</math> <math>\text{RBW} / 2</math>, so that narrowband signals are not lost between frequency bins.)          e) Sweep time = auto.          f) Detector = RMS (i.e., power averaging), if available. Otherwise, use sample detector mode.          g) If transmit duty cycle <math>&lt;</math> 98%, use a video trigger with the trigger level set to enable triggering only on full power pulses. The transmitter shall operate at maximum power control level for the entire duration of every sweep. If the EUT transmits continuously (i.e., with no OFF intervals) or at duty cycle <math>\geq</math> 98%, and if each transmission is entirely at the maximum power control level, then the trigger shall be set to "free run."          h) Trace average at least 100 traces in power averaging (rms) mode.          i) Compute power by integrating the spectrum across the 26 dB EBW or 99% OBW of the signal using the instrument's band power measurement function, with band limits set equal to the EBW or OBW band edges. If the instrument does not have a band power function, then sum the spectrum levels (in power units) at 1 MHz intervals extending across the 26 dB EBW or 99% OBW of the spectrum.</p>

**6.3.1 E.U.T. Operation:**

Operating Environment:	
Temperature:	25.5 °C
Humidity:	50.6 %
Atmospheric Pressure:	1010 mbar

**6.3.2 Test Data:**

Please Refer to Appendix for Details.

### 6.4 Power spectral density

<p>Test Requirement:</p>	<p>47 CFR Part 15.407(a)(1)(i)          47 CFR Part 15.407(a)(1)(ii)          47 CFR Part 15.407(a)(1)(iii)          47 CFR Part 15.407(a)(1)(iv)          47 CFR Part 15.407(a)(2)          47 CFR Part 15.407(a)(3)(i)</p>
<p>Test Method:</p>	<p>ANSI C63.10-2013, section 12.5</p>
<p>Test Limit:</p>	<p>For an outdoor access point operating in the band 5.15-5.25 GHz, the maximum power spectral density shall not exceed 17 dBm in any 1 megahertz band. If transmitting antennas of directional gain greater than 6 dBi are used, the maximum power spectral density shall be reduced by the amount in dB that the directional gain of the antenna exceeds 6 dBi.</p> <p>For an indoor access point operating in the band 5.15-5.25 GHz, the maximum power spectral density shall not exceed 17 dBm in any 1 megahertz band. If transmitting antennas of directional gain greater than 6 dBi are used, the maximum power spectral density shall be reduced by the amount in dB that the directional gain of the antenna exceeds 6 dBi.</p> <p>For fixed point-to-point access points operating in the band 5.15-5.25 GHz, the maximum power spectral density shall not exceed 17 dBm in any 1 megahertz band. Fixed point-to-point U-NII devices may employ antennas with directional gain up to 23 dBi without any corresponding reduction in the maximum power spectral density. For fixed point-to-point transmitters that employ a directional antenna gain greater than 23 dBi, a 1 dB reduction in maximum power spectral density is required for each 1 dB of antenna gain in excess of 23 dBi. Fixed, point-to-point operations exclude the use of point-to-multipoint systems, omnidirectional applications, and multiple collocated transmitters transmitting the same information. The operator of the U-NII device, or if the equipment is professionally installed, the installer, is responsible for ensuring that systems employing high gain directional antennas are used exclusively for fixed, point-to-point operations.</p> <p>For client devices in the 5.15-5.25 GHz band, the maximum power spectral density shall not exceed 11 dBm in any 1 megahertz band. If transmitting antennas of directional gain greater than 6 dBi are used, the maximum power spectral density shall be reduced by the amount in dB that the directional gain of the antenna exceeds 6 dBi.</p> <p>For the 5.25-5.35 GHz and 5.47-5.725 GHz bands, the maximum power spectral density shall not exceed 11 dBm in any 1 megahertz band. If transmitting antennas of directional gain greater than 6 dBi are used, the maximum power spectral density shall be reduced by the amount in dB that the directional gain of the antenna exceeds 6 dBi.</p> <p>For the band 5.725-5.850 GHz, the maximum power spectral density shall not exceed 30 dBm in any 500-kHz band. If transmitting antennas of directional gain greater than 6 dBi are used, the maximum power spectral density shall be reduced by the amount in dB that the directional gain of the antenna exceeds 6 dBi. However, fixed point-to-point U-NII devices operating in this band may employ transmitting antennas with directional gain greater than 6 dBi without any corresponding reduction in transmitter</p>

	<p>conducted power. Fixed, point-to-point operations exclude the use of point-to-multipoint systems, omnidirectional applications, and multiple collocated transmitters transmitting the same information. The operator of the U-NII device, or if the equipment is professionally installed, the installer, is responsible for ensuring that systems employing high gain directional antennas are used exclusively for fixed, point-to-point operations.</p>
<p>Procedure:</p>	<p>a) Create an average power spectrum for the EUT operating mode being tested by following the instructions in 12.3.2 for measuring maximum conducted output power using a spectrum analyzer or EMI receiver; that is, select the appropriate test method (SA-1, SA-2, SA-3, or their respective alternatives) and apply it up to, but not including, the step labeled, "Compute power...." (This procedure is required even if the maximum conducted output power measurement was performed using the power meter method PM.)  b) Use the peak search function on the instrument to find the peak of the spectrum.  c) Make the following adjustments to the peak value of the spectrum, if applicable:  1) If method SA-2 or SA-2A was used, then add <math>[10 \log (1 / D)]</math>, where D is the duty cycle, to the peak of the spectrum.  2) If method SA-3A was used and the linear mode was used in step h) of 12.3.2.7, add 1 dB to the final result to compensate for the difference between linear averaging and power averaging.  d) The result is the PPSD.  e) The procedure in item a) through item c) requires the use of 1 MHz resolution bandwidth to satisfy the 1 MHz measurement bandwidth specified by some regulatory authorities. This requirement also permits use of resolution bandwidths less than 1 MHz "provided that the measured power is integrated to show the total power over the measurement bandwidth" (i.e., 1 MHz). If measurements are performed using a reduced resolution bandwidth and integrated over 1 MHz bandwidth, the following adjustments to the procedures apply:  1) Set <math>RBW \geq 1 / T</math>, where T is defined in 12.2 a).  2) Set <math>VBW \geq [3 \times RBW]</math>.  3) Care shall be taken such that the measurements are performed during a period of continuous transmission or are corrected upward for duty cycle.</p>

**6.4.1 E.U.T. Operation:**

Operating Environment:	
Temperature:	25.5 °C
Humidity:	50.6 %
Atmospheric Pressure:	1010 mbar

**6.4.2 Test Data:**

Please Refer to Appendix for Details.

### 6.5 Emission bandwidth and occupied bandwidth

Test Requirement:	<p>U-NII 1, U-NII 2A, U-NII 2C: No limits, only for report use.</p> <p>U-NII 3, U-NII 4: 47 CFR Part 15.407(e)</p>
Test Method:	<p>ANSI C63.10-2013, section 6.9.3 &amp; 12.4 KDB 789033 D02, Clause C.2</p>
Test Limit:	<p>U-NII 1, U-NII 2A, U-NII 2C: No limits, only for report use.</p> <p>U-NII 3, U-NII 4: Within the 5.725-5.850 GHz and 5.850-5.895 GHz bands, the minimum 6 dB bandwidth of U-NII devices shall be at least 500 kHz.</p>
Procedure:	<p>Emission bandwidth:</p> <ol style="list-style-type: none"> <li>Set RBW = approximately 1% of the emission bandwidth.</li> <li>Set the VBW &gt; RBW.</li> <li>Detector = peak.</li> <li>Trace mode = max hold.</li> <li>Measure the maximum width of the emission that is 26 dB down from the peak of the emission.</li> </ol> <p>Compare this with the RBW setting of the instrument. Readjust RBW and repeat measurement as needed until the RBW/EBW ratio is approximately 1%.</p> <p>Occupied bandwidth:</p> <ol style="list-style-type: none"> <li>The instrument center frequency is set to the nominal EUT channel center frequency. The frequency span for the spectrum analyzer shall be between 1.5 times and 5.0 times the OBW.</li> <li>The nominal IF filter bandwidth (3 dB RBW) shall be in the range of 1% to 5% of the OBW, and VBW shall be approximately three times the RBW, unless otherwise specified by the applicable requirement.</li> <li>Set the reference level of the instrument as required, keeping the signal from exceeding the maximum input mixer level for linear operation. In general, the peak of the spectral envelope shall be more than <math>[10 \log (OBW/RBW)]</math> below the reference level. Specific guidance is given in 4.1.5.2.</li> <li>Step a) through step c) might require iteration to adjust within the specified range.</li> <li>Video averaging is not permitted. Where practical, a sample detection and single sweep mode shall be used. Otherwise, peak detection and max hold mode (until the trace stabilizes) shall be used.</li> <li>Use the 99% power bandwidth function of the instrument (if available) and report the measured bandwidth.</li> <li>If the instrument does not have a 99% power bandwidth function, then the trace data points are recovered and directly summed in linear power terms. The recovered amplitude data points, beginning at the lowest frequency, are placed in a running sum until 0.5% of the</li> </ol>

	<p>total is reached; that frequency is recorded as the lower frequency. The process is repeated until 99.5% of the total is reached; that frequency is recorded as the upper frequency. The 99% power bandwidth is the difference between these two frequencies.</p> <p>h) The occupied bandwidth shall be reported by providing plot(s) of the measuring instrument display; the plot axes and the scale units per division shall be clearly labeled. Tabular data may be reported in addition to the plot(s).</p> <p>6 dB emission bandwidth:</p> <p>a) Set RBW = 100 kHz. b) Set the video bandwidth (VBW) <math>\geq 3 \times</math> RBW. c) Detector = Peak. d) Trace mode = max hold. e) Sweep = auto couple. f) Allow the trace to stabilize. g) Measure the maximum width of the emission that is constrained by the frequencies associated with the two outermost amplitude points (upper and lower frequencies) that are attenuated by 6 dB relative to the maximum level measured in the fundamental emission.</p>
--	---

**6.5.1 E.U.T. Operation:**

Operating Environment:	
Temperature:	25.5 °C
Humidity:	50.6 %
Atmospheric Pressure:	1010 mbar

**6.5.2 Test Data:**

Please Refer to Appendix for Details.



### 6.6 Band edge emissions (Radiated)

Test Requirement:	47 CFR Part 15.407(b)(1) 47 CFR Part 15.407(b)(2) 47 CFR Part 15.407(b)(4) 47 CFR Part 15.407(b)(10)																																																																																				
Test Method:	ANSI C63.10-2013, section 12.7.4, 12.7.5, 12.7.6																																																																																				
Test Limit:	<p>For transmitters operating in the 5.15-5.25 GHz band: All emissions outside of the 5.15-5.35 GHz band shall not exceed an e.i.r.p. of -27 dBm/MHz.</p> <p>For transmitters operating in the 5.25-5.35 GHz band: All emissions outside of the 5.15-5.35 GHz band shall not exceed an e.i.r.p. of -27 dBm/MHz.</p> <p>For transmitters operating solely in the 5.725-5.850 GHz band: All emissions shall be limited to a level of -27 dBm/MHz at 75 MHz or more above or below the band edge increasing linearly to 10 dBm/MHz at 25 MHz above or below the band edge, and from 25 MHz above or below the band edge increasing linearly to a level of 15.6 dBm/MHz at 5 MHz above or below the band edge, and from 5 MHz above or below the band edge increasing linearly to a level of 27 dBm/MHz at the band edge.</p> <table border="1"> <thead> <tr> <th>MHz</th> <th>MHz</th> <th>MHz</th> <th>GHz</th> </tr> </thead> <tbody> <tr> <td>0.090-0.110</td> <td>16.42-16.423</td> <td>399.9-410</td> <td>4.5-5.15</td> </tr> <tr> <td><sup>1</sup>0.495-0.505</td> <td>16.69475-16.69525</td> <td>608-614</td> <td>5.35-5.46</td> </tr> <tr> <td>2.1735-2.1905</td> <td>16.80425-16.80475</td> <td>960-1240</td> <td>7.25-7.75</td> </tr> <tr> <td>4.125-4.128</td> <td>25.5-25.67</td> <td>1300-1427</td> <td>8.025-8.5</td> </tr> <tr> <td>4.17725-4.17775</td> <td>37.5-38.25</td> <td>1435-1626.5</td> <td>9.0-9.2</td> </tr> <tr> <td>4.20725-4.20775</td> <td>73-74.6</td> <td>1645.5-1646.5</td> <td>9.3-9.5</td> </tr> <tr> <td></td> <td></td> <td>5</td> <td></td> </tr> <tr> <td>6.215-6.218</td> <td>74.8-75.2</td> <td>1660-1710</td> <td>10.6-12.7</td> </tr> <tr> <td>6.26775-6.26825</td> <td>108-121.94</td> <td>1718.8-1722.2</td> <td>13.25-13.4</td> </tr> <tr> <td></td> <td></td> <td>2</td> <td></td> </tr> <tr> <td>6.31175-6.31225</td> <td>123-138</td> <td>2200-2300</td> <td>14.47-14.5</td> </tr> <tr> <td>8.291-8.294</td> <td>149.9-150.05</td> <td>2310-2390</td> <td>15.35-16.2</td> </tr> <tr> <td>8.362-8.366</td> <td>156.52475-156.52525</td> <td>2483.5-2500</td> <td>17.7-21.4</td> </tr> <tr> <td></td> <td>25</td> <td></td> <td></td> </tr> <tr> <td>8.37625-8.38675</td> <td>156.7-156.9</td> <td>2690-2900</td> <td>22.01-23.12</td> </tr> <tr> <td>8.41425-8.41475</td> <td>162.0125-167.17</td> <td>3260-3267</td> <td>23.6-24.0</td> </tr> <tr> <td>12.29-12.293</td> <td>167.72-173.2</td> <td>3332-3339</td> <td>31.2-31.8</td> </tr> <tr> <td>12.51975-12.52025</td> <td>240-285</td> <td>3345.8-3358</td> <td>36.43-36.5</td> </tr> <tr> <td>12.57675-12.57725</td> <td>322-335.4</td> <td>3600-4400</td> <td>(<sup>2</sup>)</td> </tr> <tr> <td>13.36-13.41</td> <td></td> <td></td> <td></td> </tr> </tbody> </table> <p><sup>1</sup>Until February 1, 1999, this restricted band shall be 0.490-0.510 MHz.</p> <p><sup>2</sup>Above 38.6</p> <p>The field strength of emissions appearing within these frequency bands shall not exceed the limits shown in § 15.209. At frequencies equal to or less than 1000 MHz, compliance with the limits in § 15.209 shall be demonstrated using measurement instrumentation employing a CISPR quasi-peak detector. Above 1000 MHz, compliance with the emission limits in § 15.209 shall be demonstrated based on the average value of the measured emissions. The provisions in § 15.35 apply to these measurements.</p> <p>Except as provided elsewhere in this subpart, the emissions from an intentional</p>	MHz	MHz	MHz	GHz	0.090-0.110	16.42-16.423	399.9-410	4.5-5.15	<sup>1</sup> 0.495-0.505	16.69475-16.69525	608-614	5.35-5.46	2.1735-2.1905	16.80425-16.80475	960-1240	7.25-7.75	4.125-4.128	25.5-25.67	1300-1427	8.025-8.5	4.17725-4.17775	37.5-38.25	1435-1626.5	9.0-9.2	4.20725-4.20775	73-74.6	1645.5-1646.5	9.3-9.5			5		6.215-6.218	74.8-75.2	1660-1710	10.6-12.7	6.26775-6.26825	108-121.94	1718.8-1722.2	13.25-13.4			2		6.31175-6.31225	123-138	2200-2300	14.47-14.5	8.291-8.294	149.9-150.05	2310-2390	15.35-16.2	8.362-8.366	156.52475-156.52525	2483.5-2500	17.7-21.4		25			8.37625-8.38675	156.7-156.9	2690-2900	22.01-23.12	8.41425-8.41475	162.0125-167.17	3260-3267	23.6-24.0	12.29-12.293	167.72-173.2	3332-3339	31.2-31.8	12.51975-12.52025	240-285	3345.8-3358	36.43-36.5	12.57675-12.57725	322-335.4	3600-4400	( <sup>2</sup> )	13.36-13.41			
MHz	MHz	MHz	GHz																																																																																		
0.090-0.110	16.42-16.423	399.9-410	4.5-5.15																																																																																		
<sup>1</sup> 0.495-0.505	16.69475-16.69525	608-614	5.35-5.46																																																																																		
2.1735-2.1905	16.80425-16.80475	960-1240	7.25-7.75																																																																																		
4.125-4.128	25.5-25.67	1300-1427	8.025-8.5																																																																																		
4.17725-4.17775	37.5-38.25	1435-1626.5	9.0-9.2																																																																																		
4.20725-4.20775	73-74.6	1645.5-1646.5	9.3-9.5																																																																																		
		5																																																																																			
6.215-6.218	74.8-75.2	1660-1710	10.6-12.7																																																																																		
6.26775-6.26825	108-121.94	1718.8-1722.2	13.25-13.4																																																																																		
		2																																																																																			
6.31175-6.31225	123-138	2200-2300	14.47-14.5																																																																																		
8.291-8.294	149.9-150.05	2310-2390	15.35-16.2																																																																																		
8.362-8.366	156.52475-156.52525	2483.5-2500	17.7-21.4																																																																																		
	25																																																																																				
8.37625-8.38675	156.7-156.9	2690-2900	22.01-23.12																																																																																		
8.41425-8.41475	162.0125-167.17	3260-3267	23.6-24.0																																																																																		
12.29-12.293	167.72-173.2	3332-3339	31.2-31.8																																																																																		
12.51975-12.52025	240-285	3345.8-3358	36.43-36.5																																																																																		
12.57675-12.57725	322-335.4	3600-4400	( <sup>2</sup> )																																																																																		
13.36-13.41																																																																																					

	radiator shall not exceed the field strength levels specified in the following table:		
	Frequency (MHz)	Field strength (microvolts/meter)	Measurement distance (meters)
	0.009-0.490	2400/F(kHz)	300
	0.490-1.705	24000/F(kHz)	30
	1.705-30.0	30	30
	30-88	100 **	3
	88-216	150 **	3
	216-960	200 **	3
	Above 960	500	3
Procedure:	<p>Above 1GHz:</p> <p>a. For above 1GHz, the EUT was placed on the top of a rotating table 1.5 meters above the ground at a 3 meter fully-anechoic chamber. The table was rotated 360 degrees to determine the position of the highest radiation.</p> <p>b. The EUT was set 3 meters away from the interference-receiving antenna, which was mounted on the top of a variable-height antenna tower.</p> <p>c. The antenna height is varied from one meter to four meters above the ground to determine the maximum value of the field strength. Both horizontal and vertical polarizations of the antenna are set to make the measurement.</p> <p>d. For each suspected emission, the EUT was arranged to its worst case and then the antenna was tuned to heights from 1 meter to 4 meters (for the test frequency of below 30MHz, the antenna was tuned to heights 1 meter) and the rotatable table was turned from 0 degrees to 360 degrees to find the maximum reading.</p> <p>e. The test-receiver system was set to Peak Detect Function and Specified Bandwidth with Maximum Hold Mode.</p> <p>f. If the emission level of the EUT in peak mode was 10dB lower than the limit specified, then testing could be stopped and the peak values of the EUT would be reported. Otherwise the emissions that did not have 10dB margin would be re-tested one by one using peak or average method as specified and then reported in a data sheet.</p> <p>g. Test the EUT in the lowest channel, the middle channel, the Highest channel.</p> <p>h. The radiation measurements are performed in X, Y, Z axis positioning for Transmitting mode, and found the X axis positioning which it is the worst case.</p> <p>i. Repeat above procedures until all frequencies measured was complete.</p> <p>Remark:</p> <ol style="list-style-type: none"> <li>Level= Read Level+ Cable Loss+ Antenna Factor- Preamp Factor</li> <li>Scan from 18GHz to 40GHz, the disturbance above 18GHz was very low. The points marked on above plots are the highest emissions could be found when testing, so only above points had been displayed. The amplitude of spurious emissions from the radiator which are attenuated more than 20dB below the limit need not be reported.</li> <li>As shown in this section, for frequencies above 1GHz, the field strength limits are based on average limits. However, the peak field strength of any emission shall not exceed the maximum permitted average limits specified above by more than 20 dB under any condition of modulation. For the emissions whose peak level is lower than the average limit, only the peak measurement is shown in the report.</li> <li>The disturbance above 18GHz were very low and the harmonics were the highest point could be found when testing, so only the above harmonics had been displayed.</li> </ol>		

**6.6.1 E.U.T. Operation:**

Operating Environment:	
Temperature:	25.5 °C

Humidity:	50.6 %
Atmospheric Pressure:	1010 mbar

6.6.2 Test Setup Diagram:

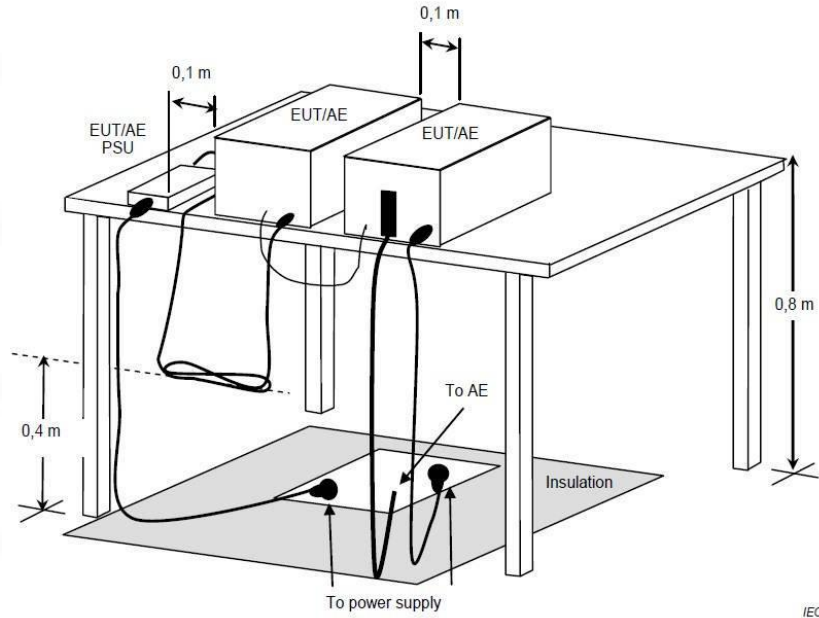

**6.6.3 Test Data:**

Note: All the mode have been tested, and only the worst case of mode are in the report

**UNII-1 20M\_5180MHz\_Horizontal**

No.	Frequency (MHz)	Reading (dBuV)	Factor (dB/m)	Level (dBuV/m)	Limit (dBuV/m)	Margin (dB)	Detector	P/F
1 *	5129.600	72.94	-27.26	45.68	74.00	-28.32	peak	P
2	5150.000	71.25	-27.24	44.01	74.00	-29.99	peak	P

**UNII-1 20M\_5180MHz\_Vertical**

No.	Frequency (MHz)	Reading (dBuV)	Factor (dB/m)	Level (dBuV/m)	Limit (dBuV/m)	Margin (dB)	Detector	P/F
1	5122.800	74.18	-27.27	46.91	74.00	-27.09	peak	P
2 *	5150.000	75.13	-27.24	47.89	74.00	-26.11	peak	P

**UNII-1 20M\_5240MHz\_Horizontal**

No.	Frequency (MHz)	Reading (dBuV)	Factor (dB/m)	Level (dBuV/m)	Limit (dBuV/m)	Margin (dB)	Detector	P/F
1 *	5350.000	40.86	6.37	47.23	74.00	-26.77	peak	P
2	5460.000	40.20	6.57	46.77	74.00	-27.23	peak	P

**UNII-1 20M\_5240MHz\_Vertical**

No.	Frequency (MHz)	Reading (dBuV)	Factor (dB/m)	Level (dBuV/m)	Limit (dBuV/m)	Margin (dB)	Detector	P/F
1	5350.000	43.67	4.63	48.30	74.00	-25.70	peak	P
2 *	5460.000	44.10	4.79	48.89	74.00	-25.11	peak	P

**UNII-3 40M\_5755MHz\_Horizontal**

No.	Frequency (MHz)	Reading (dBuV)	Factor (dB/m)	Level (dBuV/m)	Limit (dBuV/m)	Margin (dB)	Detector	P/F
1	5650.000	87.14	-31.23	55.91	68.20	-12.29	peak	P
2	5700.000	94.08	-31.34	62.74	105.60	-42.86	peak	P
3	5720.000	94.98	-31.40	63.58	110.8	-47.22	peak	P

**UNII-3 40M\_5755MHz\_Vertical**

No.	Frequency (MHz)	Reading (dBuV)	Factor (dB/m)	Level (dBuV/m)	Limit (dBuV/m)	Margin (dB)	Detector	P/F
1	5650.000	88.90	-30.88	58.02	68.20	-10.18	peak	P
2	5700.000	95.84	-30.99	64.85	105.60	-40.75	peak	P
3	5720.000	96.74	-31.05	65.69	110.8	-45.11	peak	P

**UNII-3 40M\_5795MHz\_Horizontal**

No.	Frequency (MHz)	Reading (dBuV)	Factor (dB/m)	Level (dBuV/m)	Limit (dBuV/m)	Margin (dB)	Detector	P/F
1	5850.000	83.25	-30.87	52.38	122.20	-69.82	peak	P
2	5875.000	90.19	-30.98	59.21	110.80	-51.59	peak	P
3	5925.000	91.09	-31.04	60.05	68.20	-8.15	peak	P

## UNII-3\_40M\_5795MHz\_Vertical

No.	Frequency (MHz)	Reading (dBuV)	Factor (dB/m)	Level (dBuV/m)	Limit (dBuV/m)	Margin (dB)	Detector	P/F
1	5850.000	83.60	-31.34	52.26	122.20	-69.94	peak	P
2	5875.000	90.54	-31.45	59.09	110.80	-51.71	peak	P
3	5925.000	91.44	-31.51	59.93	68.20	-8.27	peak	P

### 6.7 Undesirable emission limits (below 1GHz)

Test Requirement:	47 CFR Part 15.407(b)(9)																								
Test Method:	ANSI C63.10-2013, section 12.7.4, 12.7.5, 12.7.6																								
Test Limit:	<p>Unwanted emissions below 1 GHz must comply with the general field strength limits set forth in § 15.209.</p> <p>Except as provided elsewhere in this subpart, the emissions from an intentional radiator shall not exceed the field strength levels specified in the following table:</p> <table border="1"> <thead> <tr> <th>Frequency (MHz)</th> <th>Field strength (microvolts/meter)</th> <th>Measurement distance (meters)</th> </tr> </thead> <tbody> <tr> <td>0.009-0.490</td> <td>2400/F(kHz)</td> <td>300</td> </tr> <tr> <td>0.490-1.705</td> <td>24000/F(kHz)</td> <td>30</td> </tr> <tr> <td>1.705-30.0</td> <td>30</td> <td>30</td> </tr> <tr> <td>30-88</td> <td>100 **</td> <td>3</td> </tr> <tr> <td>88-216</td> <td>150 **</td> <td>3</td> </tr> <tr> <td>216-960</td> <td>200 **</td> <td>3</td> </tr> <tr> <td>Above 960</td> <td>500</td> <td>3</td> </tr> </tbody> </table>	Frequency (MHz)	Field strength (microvolts/meter)	Measurement distance (meters)	0.009-0.490	2400/F(kHz)	300	0.490-1.705	24000/F(kHz)	30	1.705-30.0	30	30	30-88	100 **	3	88-216	150 **	3	216-960	200 **	3	Above 960	500	3
Frequency (MHz)	Field strength (microvolts/meter)	Measurement distance (meters)																							
0.009-0.490	2400/F(kHz)	300																							
0.490-1.705	24000/F(kHz)	30																							
1.705-30.0	30	30																							
30-88	100 **	3																							
88-216	150 **	3																							
216-960	200 **	3																							
Above 960	500	3																							
Procedure:	<p>Below 1GHz:</p> <ol style="list-style-type: none"> <li>For below 1GHz, the EUT was placed on the top of a rotating table 0.8 meters above the ground at a 3 meter semi-anechoic chamber. The table was rotated 360 degrees to determine the position of the highest radiation.</li> <li>The EUT was set 3 or 10 meters away from the interference-receiving antenna, which was mounted on the top of a variable-height antenna tower.</li> <li>The antenna height is varied from one meter to four meters above the ground to determine the maximum value of the field strength. Both horizontal and vertical polarizations of the antenna are set to make the measurement.</li> <li>For each suspected emission, the EUT was arranged to its worst case and then the antenna was tuned to heights from 1 meter to 4 meters (for the test frequency of below 30MHz, the antenna was tuned to heights 1 meter) and the rotatable table was turned from 0 degrees to 360 degrees to find the maximum reading.</li> <li>The test-receiver system was set to Peak Detect Function and Specified Bandwidth with Maximum Hold Mode.</li> <li>If the emission level of the EUT in peak mode was 10dB lower than the limit specified, then testing could be stopped and the peak values of the EUT would be reported. Otherwise the emissions that did not have 10dB margin would be re-tested one by one using quasi-peak method as specified and then reported in a data sheet.</li> <li>Test the EUT in the lowest channel, the middle channel, the Highest channel.</li> <li>The radiation measurements are performed in X, Y, Z axis positioning for Transmitting mode, and found the X axis positioning which it is the worst case.</li> <li>Repeat above procedures until all frequencies measured was complete.</li> </ol> <p>Remark:</p> <ol style="list-style-type: none"> <li>Level= Read Level+ Cable Loss+ Antenna Factor- Preamp Factor</li> <li>Scan from 9kHz to 30MHz, the disturbance below 30MHz was very low. The points marked on above plots are the highest emissions could be found when testing, so only above points had been displayed. The amplitude of spurious emissions from the radiator which are attenuated more than 20dB below the limit need not be reported.</li> <li>The disturbance below 1GHz was very low and the harmonics were the highest point could be found when testing, so only the above harmonics had been displayed.</li> </ol> <p>Above 1GHz:</p>																								

	<p>a. For above 1GHz, the EUT was placed on the top of a rotating table 1.5 meters above the ground at a 3 meter fully-anechoic chamber. The table was rotated 360 degrees to determine the position of the highest radiation.</p> <p>b. The EUT was set 3 meters away from the interference-receiving antenna, which was mounted on the top of a variable-height antenna tower.</p> <p>c. The antenna height is varied from one meter to four meters above the ground to determine the maximum value of the field strength. Both horizontal and vertical polarizations of the antenna are set to make the measurement.</p> <p>d. For each suspected emission, the EUT was arranged to its worst case and then the antenna was tuned to heights from 1 meter to 4 meters (for the test frequency of below 30MHz, the antenna was tuned to heights 1 meter) and the rotatable table was turned from 0 degrees to 360 degrees to find the maximum reading.</p> <p>e. The test-receiver system was set to Peak Detect Function and Specified Bandwidth with Maximum Hold Mode.</p> <p>f. If the emission level of the EUT in peak mode was 10dB lower than the limit specified, then testing could be stopped and the peak values of the EUT would be reported. Otherwise the emissions that did not have 10dB margin would be re-tested one by one using peak or average method as specified and then reported in a data sheet.</p> <p>g. Test the EUT in the lowest channel, the middle channel, the Highest channel.</p> <p>h. The radiation measurements are performed in X, Y, Z axis positioning for Transmitting mode, and found the X axis positioning which it is the worst case.</p> <p>i. Repeat above procedures until all frequencies measured was complete.</p> <p>Remark:</p> <ol style="list-style-type: none"> <li>Level= Read Level+ Cable Loss+ Antenna Factor- Preamp Factor</li> <li>Scan from 18GHz to 40GHz, the disturbance above 18GHz was very low. The points marked on above plots are the highest emissions could be found when testing, so only above points had been displayed. The amplitude of spurious emissions from the radiator which are attenuated more than 20dB below the limit need not be reported.</li> <li>As shown in this section, for frequencies above 1GHz, the field strength limits are based on average limits. However, the peak field strength of any emission shall not exceed the maximum permitted average limits specified above by more than 20 dB under any condition of modulation. For the emissions whose peak level is lower than the average limit, only the peak measurement is shown in the report.</li> <li>The disturbance above 18GHz were very low and the harmonics were the highest point could be found when testing, so only the above harmonics had been displayed.</li> </ol>
--	--

**6.7.1 E.U.T. Operation:**

Operating Environment:	
Temperature:	25.5 °C
Humidity:	50.6 %
Atmospheric Pressure:	1010 mbar

6.7.2 Test Setup Diagram:

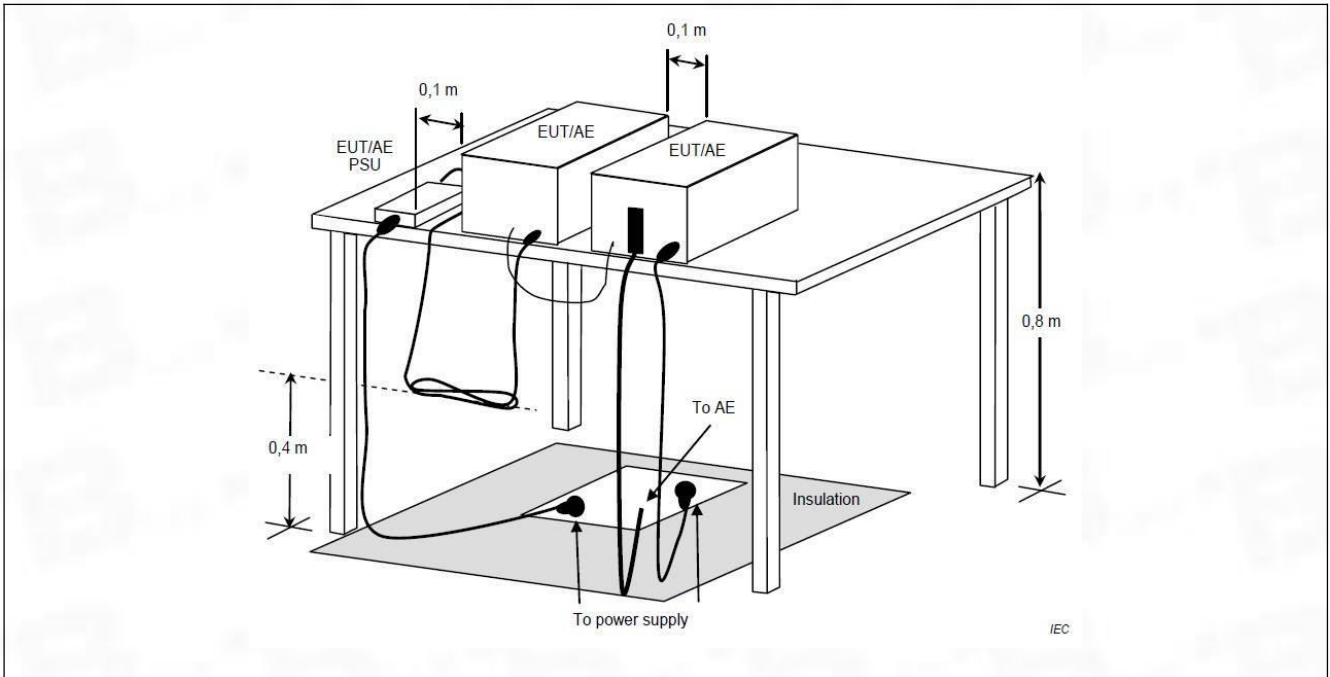



**6.7.3 Test Data:**

Note: All the mode have been tested, and only the worst case mode are in the report  
 TM1 / Polarization: Horizontal / Band: U-NII 1 / BW: 20 / CH: L

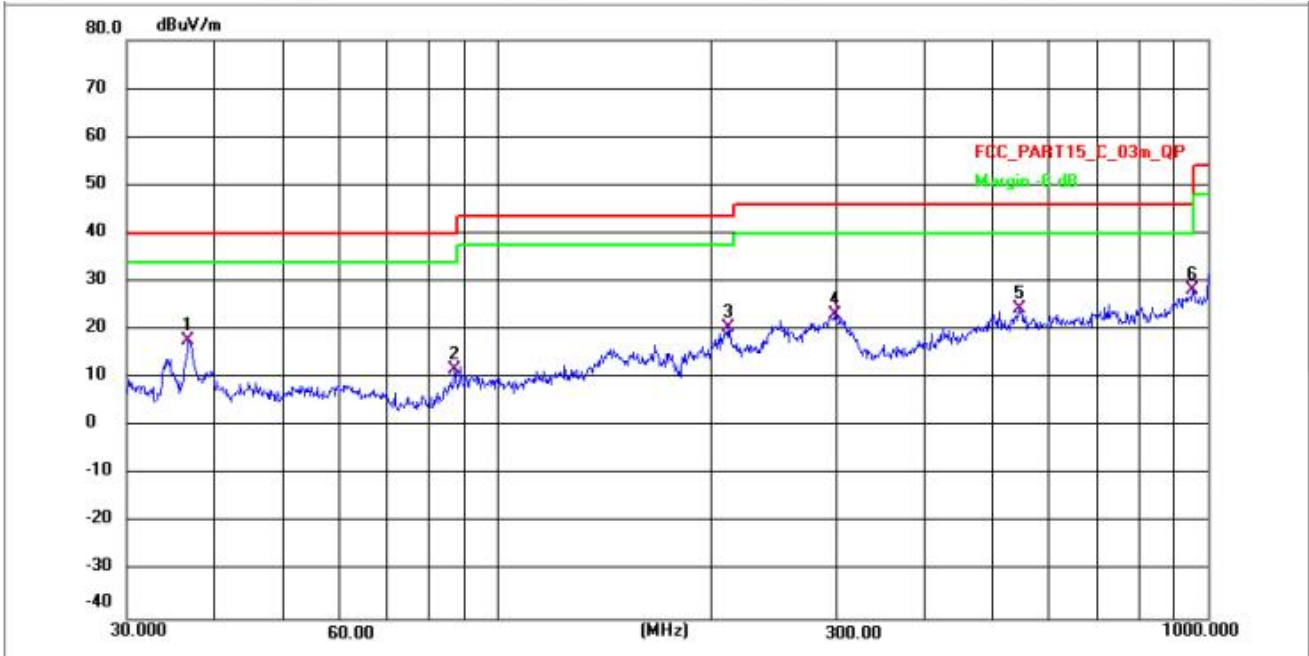

No.	Frequency (MHz)	Reading (dBuV)	Factor (dB/m)	Level (dBuV/m)	Limit (dBuV/m)	Margin (dB)	Detector	P/F
1	36.7661	36.13	-18.44	17.69	40.00	-22.31	QP	P
2	87.1116	42.22	-30.35	11.87	40.00	-28.13	QP	P
3	210.7860	47.23	-26.85	20.38	43.50	-23.12	QP	P
4	298.2681	48.46	-25.44	23.02	46.00	-22.98	QP	P
5	545.1825	46.10	-21.61	24.49	46.00	-21.51	QP	P
6 *	953.7644	49.97	-21.75	28.22	46.00	-17.78	QP	P

TM1 / Polarization: Vertical / Band: U-NII 1 / BW: 20 / CH: L

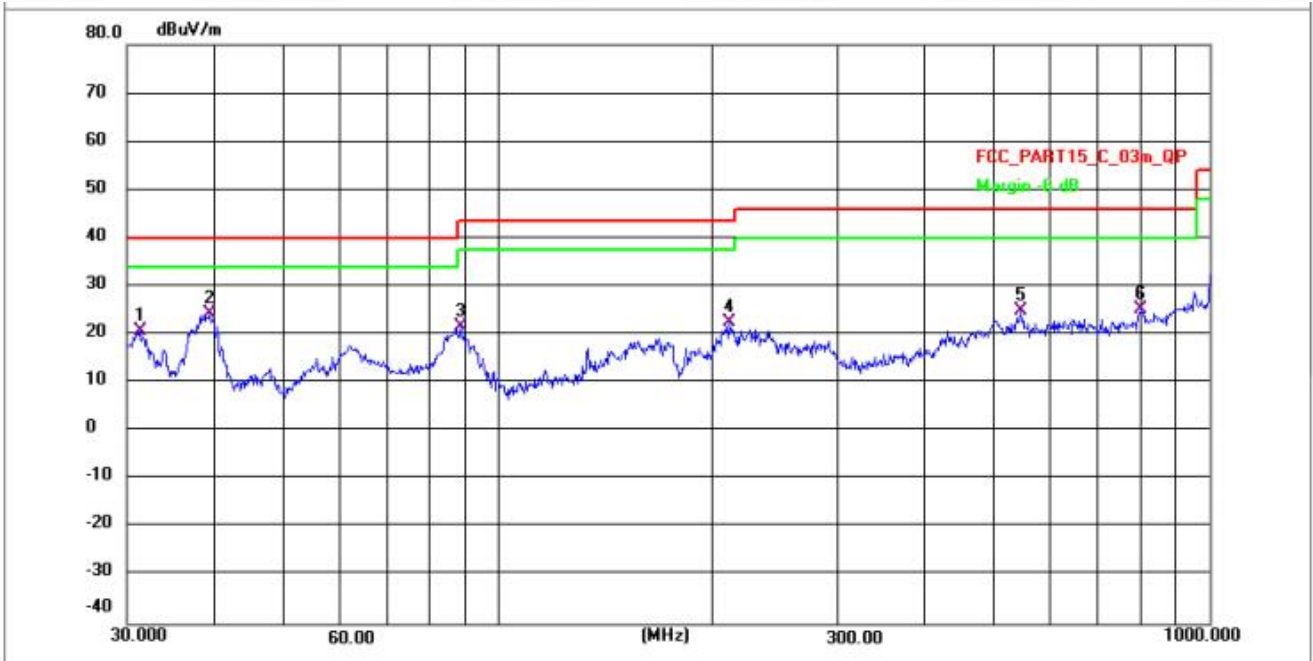

No.	Frequency (MHz)	Reading (dBuV)	Factor (dB/m)	Level (dBuV/m)	Limit (dBuV/m)	Margin (dB)	Detector	P/F
1	31.3992	41.41	-20.71	20.70	40.00	-19.30	QP	P
2 *	39.1616	44.76	-20.54	24.22	40.00	-15.78	QP	P
3	88.8080	51.73	-30.07	21.66	43.50	-21.84	QP	P
4	210.7860	49.29	-26.85	22.44	43.50	-21.06	QP	P
5	544.2276	46.58	-21.60	24.98	46.00	-21.02	QP	P
6	798.9797	48.93	-23.72	25.21	46.00	-20.79	QP	P

**6.8 Undesirable emission limits (above 1GHz)**

Test Requirement:	47 CFR Part 15.407(b)(1) 47 CFR Part 15.407(b)(2) 47 CFR Part 15.407(b)(4) 47 CFR Part 15.407(b)(10)																																																																																							
Test Method:	ANSI C63.10-2013, section 12.7.4, 12.7.5, 12.7.6																																																																																							
Test Limit:	<p>For transmitters operating in the 5.15-5.25 GHz band: All emissions outside of the 5.15-5.35 GHz band shall not exceed an e.i.r.p. of -27 dBm/MHz. For transmitters operating in the 5.25-5.35 GHz band: All emissions outside of the 5.15-5.35 GHz band shall not exceed an e.i.r.p. of -27 dBm/MHz.</p> <p>For transmitters operating solely in the 5.725-5.850 GHz band: All emissions shall be limited to a level of -27 dBm/MHz at 75 MHz or more above or below the band edge increasing linearly to 10 dBm/MHz at 25 MHz above or below the band edge, and from 25 MHz above or below the band edge increasing linearly to a level of 15.6 dBm/MHz at 5 MHz above or below the band edge, and from 5 MHz above or below the band edge increasing linearly to a level of 27 dBm/MHz at the band edge.</p> <table border="1"> <thead> <tr> <th>MHz</th> <th>MHz</th> <th>MHz</th> <th>GHz</th> </tr> </thead> <tbody> <tr> <td>0.090-0.110</td> <td>16.42-16.423</td> <td>399.9-410</td> <td>4.5-5.15</td> </tr> <tr> <td><sup>1</sup>0.495-0.505</td> <td>16.69475-16.69525</td> <td>608-614</td> <td>5.35-5.46</td> </tr> <tr> <td>2.1735-2.1905</td> <td>16.80425-16.80475</td> <td>960-1240</td> <td>7.25-7.75</td> </tr> <tr> <td>4.125-4.128</td> <td>25.5-25.67</td> <td>1300-1427</td> <td>8.025-8.5</td> </tr> <tr> <td>4.17725-4.17775</td> <td>37.5-38.25</td> <td>1435-1626.5</td> <td>9.0-9.2</td> </tr> <tr> <td>4.20725-4.20775</td> <td>73-74.6</td> <td>1645.5-1646.5</td> <td>9.3-9.5</td> </tr> <tr> <td></td> <td></td> <td>5</td> <td></td> </tr> <tr> <td>6.215-6.218</td> <td>74.8-75.2</td> <td>1660-1710</td> <td>10.6-12.7</td> </tr> <tr> <td>6.26775-6.26825</td> <td>108-121.94</td> <td>1718.8-1722.2</td> <td>13.25-13.4</td> </tr> <tr> <td></td> <td></td> <td>2</td> <td></td> </tr> <tr> <td>6.31175-6.31225</td> <td>123-138</td> <td>2200-2300</td> <td>14.47-14.5</td> </tr> <tr> <td>8.291-8.294</td> <td>149.9-150.05</td> <td>2310-2390</td> <td>15.35-16.2</td> </tr> <tr> <td>8.362-8.366</td> <td>156.52475-156.52525</td> <td>2483.5-2500</td> <td>17.7-21.4</td> </tr> <tr> <td></td> <td>25</td> <td></td> <td></td> </tr> <tr> <td>8.37625-8.38675</td> <td>156.7-156.9</td> <td>2690-2900</td> <td>22.01-23.12</td> </tr> <tr> <td>8.41425-8.41475</td> <td>162.0125-167.17</td> <td>3260-3267</td> <td>23.6-24.0</td> </tr> <tr> <td>12.29-12.293</td> <td>167.72-173.2</td> <td>3332-3339</td> <td>31.2-31.8</td> </tr> <tr> <td>12.51975-12.52025</td> <td>240-285</td> <td>3345.8-3358</td> <td>36.43-36.5</td> </tr> <tr> <td>12.57675-12.57725</td> <td>322-335.4</td> <td>3600-4400</td> <td>(<sup>2</sup>)</td> </tr> <tr> <td>13.36-13.41</td> <td></td> <td></td> <td></td> </tr> </tbody> </table> <p><sup>1</sup>Until February 1, 1999, this restricted band shall be 0.490-0.510 MHz. <sup>2</sup>Above 38.6</p> <p>The field strength of emissions appearing within these frequency bands shall not exceed the limits shown in § 15.209. At frequencies equal to or less than 1000 MHz, compliance with the limits in § 15.209 shall be demonstrated using measurement instrumentation employing a CISPR quasi-peak detector. Above 1000 MHz, compliance with the emission limits in § 15.209 shall be demonstrated based on the average value of the measured emissions. The provisions in § 15.35 apply to these measurements.</p> <p>Except as provided elsewhere in this subpart, the emissions from an intentional radiator shall not exceed the field strength levels specified in the following table:</p> <table border="1"> <thead> <tr> <th>Frequency (MHz)</th> <th>Field strength</th> <th>Measurement</th> </tr> </thead> </table>	MHz	MHz	MHz	GHz	0.090-0.110	16.42-16.423	399.9-410	4.5-5.15	<sup>1</sup> 0.495-0.505	16.69475-16.69525	608-614	5.35-5.46	2.1735-2.1905	16.80425-16.80475	960-1240	7.25-7.75	4.125-4.128	25.5-25.67	1300-1427	8.025-8.5	4.17725-4.17775	37.5-38.25	1435-1626.5	9.0-9.2	4.20725-4.20775	73-74.6	1645.5-1646.5	9.3-9.5			5		6.215-6.218	74.8-75.2	1660-1710	10.6-12.7	6.26775-6.26825	108-121.94	1718.8-1722.2	13.25-13.4			2		6.31175-6.31225	123-138	2200-2300	14.47-14.5	8.291-8.294	149.9-150.05	2310-2390	15.35-16.2	8.362-8.366	156.52475-156.52525	2483.5-2500	17.7-21.4		25			8.37625-8.38675	156.7-156.9	2690-2900	22.01-23.12	8.41425-8.41475	162.0125-167.17	3260-3267	23.6-24.0	12.29-12.293	167.72-173.2	3332-3339	31.2-31.8	12.51975-12.52025	240-285	3345.8-3358	36.43-36.5	12.57675-12.57725	322-335.4	3600-4400	( <sup>2</sup> )	13.36-13.41				Frequency (MHz)	Field strength	Measurement
MHz	MHz	MHz	GHz																																																																																					
0.090-0.110	16.42-16.423	399.9-410	4.5-5.15																																																																																					
<sup>1</sup> 0.495-0.505	16.69475-16.69525	608-614	5.35-5.46																																																																																					
2.1735-2.1905	16.80425-16.80475	960-1240	7.25-7.75																																																																																					
4.125-4.128	25.5-25.67	1300-1427	8.025-8.5																																																																																					
4.17725-4.17775	37.5-38.25	1435-1626.5	9.0-9.2																																																																																					
4.20725-4.20775	73-74.6	1645.5-1646.5	9.3-9.5																																																																																					
		5																																																																																						
6.215-6.218	74.8-75.2	1660-1710	10.6-12.7																																																																																					
6.26775-6.26825	108-121.94	1718.8-1722.2	13.25-13.4																																																																																					
		2																																																																																						
6.31175-6.31225	123-138	2200-2300	14.47-14.5																																																																																					
8.291-8.294	149.9-150.05	2310-2390	15.35-16.2																																																																																					
8.362-8.366	156.52475-156.52525	2483.5-2500	17.7-21.4																																																																																					
	25																																																																																							
8.37625-8.38675	156.7-156.9	2690-2900	22.01-23.12																																																																																					
8.41425-8.41475	162.0125-167.17	3260-3267	23.6-24.0																																																																																					
12.29-12.293	167.72-173.2	3332-3339	31.2-31.8																																																																																					
12.51975-12.52025	240-285	3345.8-3358	36.43-36.5																																																																																					
12.57675-12.57725	322-335.4	3600-4400	( <sup>2</sup> )																																																																																					
13.36-13.41																																																																																								
Frequency (MHz)	Field strength	Measurement																																																																																						

	(microvolts/meter)	distance (meters)
0.009-0.490	2400/F(kHz)	300
0.490-1.705	24000/F(kHz)	30
1.705-30.0	30	30
30-88	100 **	3
88-216	150 **	3
216-960	200 **	3
Above 960	500	3

**Procedure:**

Above 1GHz:

- For above 1GHz, the EUT was placed on the top of a rotating table 1.5 meters above the ground at a 3 meter fully-anechoic chamber. The table was rotated 360 degrees to determine the position of the highest radiation.
- The EUT was set 3 meters away from the interference-receiving antenna, which was mounted on the top of a variable-height antenna tower.
- The antenna height is varied from one meter to four meters above the ground to determine the maximum value of the field strength. Both horizontal and vertical polarizations of the antenna are set to make the measurement.
- For each suspected emission, the EUT was arranged to its worst case and then the antenna was tuned to heights from 1 meter to 4 meters (for the test frequency of below 30MHz, the antenna was tuned to heights 1 meter) and the rotatable table was turned from 0 degrees to 360 degrees to find the maximum reading.
- The test-receiver system was set to Peak Detect Function and Specified Bandwidth with Maximum Hold Mode.
- If the emission level of the EUT in peak mode was 10dB lower than the limit specified, then testing could be stopped and the peak values of the EUT would be reported. Otherwise the emissions that did not have 10dB margin would be re-tested one by one using peak or average method as specified and then reported in a data sheet.
- Test the EUT in the lowest channel, the middle channel, the Highest channel.
- The radiation measurements are performed in X, Y, Z axis positioning for Transmitting mode, and found the X axis positioning which it is the worst case.
- Repeat above procedures until all frequencies measured was complete.

**Remark:**

- Level= Read Level+ Cable Loss+ Antenna Factor- Preamp Factor
- Scan from 18GHz to 40GHz, the disturbance above 18GHz was very low. The points marked on above plots are the highest emissions could be found when testing, so only above points had been displayed. The amplitude of spurious emissions from the radiator which are attenuated more than 20dB below the limit need not be reported.
- As shown in this section, for frequencies above 1GHz, the field strength limits are based on average limits. However, the peak field strength of any emission shall not exceed the maximum permitted average limits specified above by more than 20 dB under any condition of modulation. For the emissions whose peak level is lower than the average limit, only the peak measurement is shown in the report.
- The disturbance above 18GHz were very low and the harmonics were the highest point could be found when testing, so only the above harmonics had been displayed.

**6.8.1 E.U.T. Operation:**

<b>Operating Environment:</b>	
Temperature:	25.5 °C
Humidity:	50.6 %
Atmospheric Pressure:	1010 mbar

**6.8.2 Test Data:**

Note: All the mode have been tested, and only the worst case of mode are in the report

UNII-1\_20M\_5180MHz\_Horizontal

No.	Frequency (MHz)	Reading (dBuV)	Factor (dB/m)	Level (dBuV/m)	Limit (dBuV/m)	Margin (dB)	Detector	P/F
1	1871.569	65.79	-31.13	34.66	74.00	-39.34	peak	P
2	2390.022	70.44	-30.49	39.95	74.00	-34.05	peak	P
3	3745.709	72.75	-29.03	43.72	74.00	-30.28	peak	P
4	7256.720	73.66	-24.85	48.81	74.00	-25.19	peak	P
5	10175.236	72.11	-24.37	47.74	74.00	-26.26	peak	P
6 *	14730.563	71.97	-20.83	51.14	74.00	-22.86	peak	P

UNII-1\_20M\_5180MHz\_Vertical

No.	Frequency (MHz)	Reading (dBuV)	Factor (dB/m)	Level (dBuV/m)	Limit (dBuV/m)	Margin (dB)	Detector	P/F
1	2151.966	71.50	-30.76	40.74	74.00	-33.26	peak	P
2	3104.588	73.04	-29.42	43.62	74.00	-30.38	peak	P
3	6990.119	72.54	-24.94	47.60	74.00	-26.40	peak	P
4	8456.819	73.11	-25.34	47.77	74.00	-26.23	peak	P
5	10366.711	75.51	-24.46	51.05	74.00	-22.95	peak	P
6 *	14730.563	72.97	-20.83	52.14	74.00	-21.86	peak	P

UNII-1\_20M\_5200MHz\_Horizontal

No.	Frequency (MHz)	Reading (dBuV)	Factor (dB/m)	Level (dBuV/m)	Limit (dBuV/m)	Margin (dB)	Detector	P/F
1	2304.546	71.32	-30.59	40.73	74.00	-33.27	peak	P
2	3609.140	72.25	-29.05	43.20	74.00	-30.80	peak	P
3	6691.600	74.56	-25.20	49.36	74.00	-24.64	peak	P
4	9549.733	72.25	-23.31	48.94	74.00	-25.06	peak	P
5	12634.684	70.49	-21.54	48.95	74.00	-25.05	peak	P
6 *	14730.563	71.97	-20.83	51.14	74.00	-22.86	peak	P

UNII-1\_20M\_5200MHz\_Vertical

No.	Frequency (MHz)	Reading (dBuV)	Factor (dB/m)	Level (dBuV/m)	Limit (dBuV/m)	Margin (dB)	Detector	P/F
1	3397.080	72.04	-29.15	42.89	74.00	-31.11	peak	P
2	6210.748	71.71	-25.35	46.36	74.00	-27.64	peak	P
3	8597.300	72.32	-25.12	47.20	74.00	-26.80	peak	P
4	12264.083	70.47	-21.89	48.58	74.00	-25.42	peak	P
5 *	14582.296	73.19	-21.06	52.13	74.00	-21.87	peak	P
6	17018.458	69.76	-18.21	51.55	74.00	-22.45	peak	P

UNII-1\_20M\_5240MHz\_Horizontal

No.	Frequency (MHz)	Reading (dBuV)	Factor (dB/m)	Level (dBuV/m)	Limit (dBuV/m)	Margin (dB)	Detector	P/F
1	2151.966	71.00	-30.76	40.24	74.00	-33.76	peak	P
2	3173.082	72.20	-29.36	42.84	74.00	-31.16	peak	P
3	6691.600	75.06	-25.20	49.86	74.00	-24.14	peak	P
4	10366.711	74.51	-24.46	50.05	74.00	-23.95	peak	P
5	12874.301	71.42	-21.41	50.01	74.00	-23.99	peak	P
6 *	15224.024	72.50	-20.89	51.61	74.00	-22.39	peak	P

UNII-1\_20M\_5240MHz\_Vertical

No.	Frequency (MHz)	Reading (dBuV)	Factor (dB/m)	Level (dBuV/m)	Limit (dBuV/m)	Margin (dB)	Detector	P/F
1	3123.941	72.35	-29.40	42.95	74.00	-31.05	peak	P
2	6374.430	73.79	-25.37	48.42	74.00	-25.58	peak	P
3	7885.504	72.64	-25.35	47.29	74.00	-26.71	peak	P
4	11620.485	72.27	-22.86	49.41	74.00	-24.59	peak	P
5	14730.563	71.97	-20.83	51.14	74.00	-22.86	peak	P
6 *	16519.272	70.35	-19.15	51.20	74.00	-22.80	peak	P

UNII-3\_20M\_5745MHz\_Horizontal

No.	Frequency (MHz)	Reading (dBuV)	Factor (dB/m)	Level (dBuV/m)	Limit (dBuV/m)	Margin (dB)	Detector	P/F
1	1171.965	68.81	-29.92	38.89	74.00	-35.11	peak	P
2	2068.119	69.52	-30.85	38.67	74.00	-35.33	peak	P
3	3552.219	73.20	-29.05	44.15	74.00	-29.85	peak	P
4	6990.119	73.04	-24.94	48.10	74.00	-25.90	peak	P
5	9032.901	73.94	-24.24	49.70	74.00	-24.30	peak	P
6 *	13626.671	71.47	-21.00	50.47	74.00	-23.53	peak	P

UNII-3\_20M\_5745MHz\_Vertical

No.	Frequency (MHz)	Reading (dBuV)	Factor (dB/m)	Level (dBuV/m)	Limit (dBuV/m)	Margin (dB)	Detector	P/F
1	2209.958	70.95	-30.70	40.25	74.00	-33.75	peak	P
2	3173.082	72.70	-29.36	43.34	74.00	-30.66	peak	P
3	6210.748	73.21	-25.35	47.86	74.00	-26.14	peak	P
4	8232.524	73.00	-25.43	47.57	74.00	-26.43	peak	P
5	11066.496	72.45	-23.39	49.06	74.00	-24.94	peak	P
6 *	15224.024	72.00	-20.89	51.11	74.00	-22.89	peak	P

UNII-3\_20M\_5785MHz\_Horizontal

No.	Frequency (MHz)	Reading (dBuV)	Factor (dB/m)	Level (dBuV/m)	Limit (dBuV/m)	Margin (dB)	Detector	P/F
1	2119.252	70.27	-30.79	39.48	74.00	-34.52	peak	P
2	3173.082	73.70	-29.36	44.34	74.00	-29.66	peak	P
3	6758.661	72.55	-25.14	47.41	74.00	-26.59	peak	P
4	8876.318	72.02	-24.56	47.46	74.00	-26.54	peak	P
5	11066.496	73.95	-23.39	50.56	74.00	-23.44	peak	P
6 *	15354.388	72.96	-21.17	51.79	74.00	-22.21	peak	P

UNII-3\_20M\_5785MHz\_Vertical

No.	Frequency (MHz)	Reading (dBuV)	Factor (dB/m)	Level (dBuV/m)	Limit (dBuV/m)	Margin (dB)	Detector	P/F
1	2830.728	69.66	-29.80	39.86	74.00	-34.14	peak	P
2	4122.364	71.15	-28.94	42.21	74.00	-31.79	peak	P
3	6501.896	72.85	-25.38	47.47	74.00	-26.53	peak	P
4	9032.901	73.94	-24.24	49.70	74.00	-24.30	peak	P
5	12020.179	71.13	-22.17	48.96	74.00	-25.04	peak	P
6 *	15532.938	72.44	-21.50	50.94	74.00	-23.06	peak	P

UNII-3\_20M\_5825MHz\_Horizontal

No.	Frequency (MHz)	Reading (dBuV)	Factor (dB/m)	Level (dBuV/m)	Limit (dBuV/m)	Margin (dB)	Detector	P/F
1	2539.217	70.46	-30.30	40.16	74.00	-33.84	peak	P
2	3338.193	72.81	-29.20	43.61	74.00	-30.39	peak	P
3	6323.050	73.52	-25.36	48.16	74.00	-25.84	peak	P
4	8895.581	71.85	-24.52	47.33	74.00	-26.67	peak	P
5	12634.684	70.49	-21.54	48.95	74.00	-25.05	peak	P
6 *	15224.024	72.00	-20.89	51.11	74.00	-22.89	peak	P

UNII-3\_20M\_5825MHz\_Vertical

No.	Frequency (MHz)	Reading (dBuV)	Factor (dB/m)	Level (dBuV/m)	Limit (dBuV/m)	Margin (dB)	Detector	P/F
1	2282.999	70.58	-30.62	39.96	74.00	-34.04	peak	P
2	3114.475	72.59	-29.41	43.18	74.00	-30.82	peak	P
3	5967.895	72.75	-25.43	47.32	74.00	-26.68	peak	P
4	7304.066	73.23	-24.84	48.39	74.00	-25.61	peak	P
5	9032.901	73.94	-24.24	49.70	74.00	-24.30	peak	P
6 *	13626.671	71.47	-21.00	50.47	74.00	-23.53	peak	P

UNII-3\_40M\_5755MHz\_Horizontal

No.	Frequency (MHz)	Reading (dBuV)	Factor (dB/m)	Level (dBuV/m)	Limit (dBuV/m)	Margin (dB)	Detector	P/F
1	4247.304	78.03	-29.31	48.72	74.00	-25.28	peak	P
2	6224.604	79.77	-29.82	49.95	74.00	-24.05	peak	P
3	8839.684	81.43	-30.04	51.39	74.00	-22.61	peak	P
4	9819.954	82.73	-30.82	51.91	74.00	-22.09	peak	P
5	12121.845	83.44	-31.31	52.13	74.00	-21.87	peak	P
6	15780.456	84.29	-33.70	50.59	74.00	-23.41	peak	P

UNII-3\_40M\_5755MHz\_Vertical

No.	Frequency (MHz)	Reading (dBuV)	Factor (dB/m)	Level (dBuV/m)	Limit (dBuV/m)	Margin (dB)	Detector	P/F
1	4097.357	78.28	-29.18	49.10	74.00	-24.90	peak	P
2	6074.657	80.02	-29.69	50.33	74.00	-23.67	peak	P
3	8689.737	81.68	-29.91	51.77	74.00	-22.23	peak	P
4	9670.007	82.98	-30.69	52.29	74.00	-21.71	peak	P
5	11971.898	83.69	-31.18	52.51	74.00	-21.49	peak	P
6	15630.509	84.54	-33.57	50.97	74.00	-23.03	peak	P

UNII-3\_40M\_5795MHz\_Horizontal

No.	Frequency (MHz)	Reading (dBuV)	Factor (dB/m)	Level (dBuV/m)	Limit (dBuV/m)	Margin (dB)	Detector	P/F
1	4347.445	78.53	-28.60	49.93	74.00	-24.07	peak	P
2	6324.745	80.27	-29.11	51.16	74.00	-22.84	peak	P
3	8939.825	81.93	-29.33	52.60	74.00	-21.40	peak	P
4	9920.095	83.23	-30.11	53.12	74.00	-20.88	peak	P
5	12221.986	83.94	-30.60	53.34	74.00	-20.66	peak	P
6	15880.597	84.79	-32.99	51.80	74.00	-22.20	peak	P

UNII-3\_40M\_5795MHz\_Vertical

No.	Frequency (MHz)	Reading (dBuV)	Factor (dB/m)	Level (dBuV/m)	Limit (dBuV/m)	Margin (dB)	Detector	P/F
1	4643.305	78.52	-29.59	48.93	74.00	-25.07	peak	P
2	6620.605	80.26	-30.10	50.16	74.00	-23.84	peak	P
3	9235.685	81.92	-30.32	51.60	74.00	-22.40	peak	P
4	10215.955	83.22	-31.10	52.12	74.00	-21.88	peak	P
5	12517.846	83.93	-31.59	52.34	74.00	-21.66	peak	P
6	16176.457	84.78	-33.98	50.80	74.00	-23.20	peak	P



## 7 Test Setup Photos

Conducted Emission at AC power line

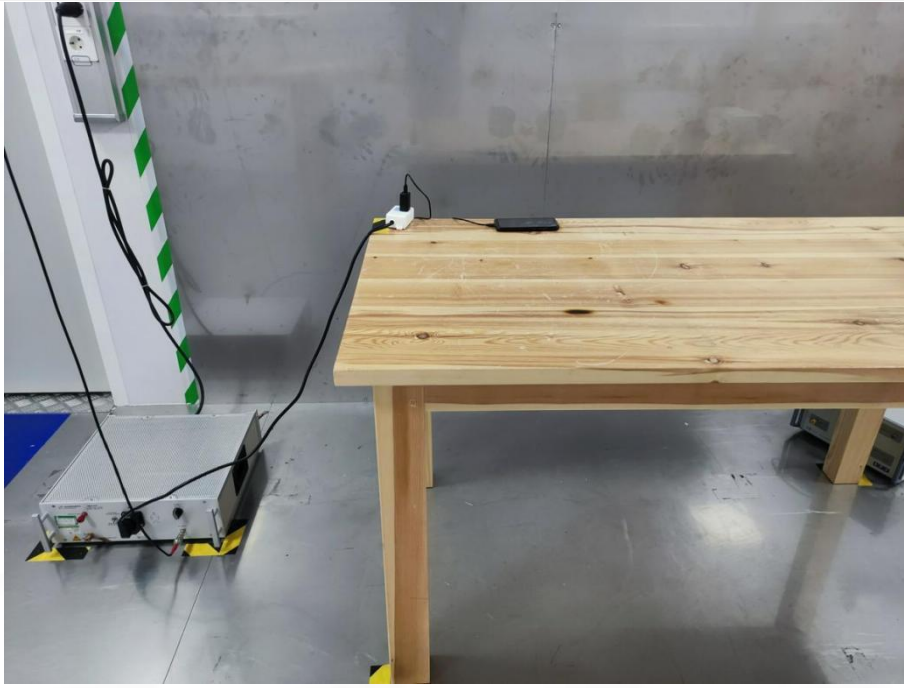

Band edge emissions (Radiated)  
Undesirable emission limits (above 1GHz)



Undesirable emission limits (below 1GHz)



## 8 EUT Constructional Details (EUT Photos)

Please refer to the report No.BTF230921R00301

# Appendix

# 1. Duty Cycle

## 1.1 Ant1

### 1.1.1 Test Result

Ant1							
Mode	TX Type	Frequency (MHz)	T_on (ms)	Period (ms)	Duty Cycle (%)	Duty Cycle Correction Factor (dB)	Max. DC Variation (%)
802.11a	SISO	5180	1.393	1.427	97.62	0.10	0.03
		5200	1.394	1.428	97.62	0.10	0.03
		5240	1.393	1.428	97.55	0.11	0.03
		5745	1.393	1.428	97.55	0.11	0.03
		5785	1.394	1.428	97.62	0.10	0.03
		5825	1.393	1.428	97.55	0.11	0.03
802.11n (HT20)	SISO	5180	1.302	1.336	97.46	0.11	0.03
		5200	1.302	1.336	97.46	0.11	0.03
		5240	1.301	1.336	97.38	0.12	0.03
		5745	1.301	1.336	97.38	0.12	0.03
		5785	1.301	1.335	97.45	0.11	0.03
802.11n (HT40)	SISO	5190	0.649	0.683	95.02	0.22	0.00
		5230	0.649	0.683	95.02	0.22	0.00
		5755	0.649	0.683	95.02	0.22	0.03
		5795	0.649	0.683	95.02	0.22	0.00
		5180	1.301	1.336	97.38	0.12	0.03
802.11ac (VHT20)	SISO	5200	1.301	1.335	97.45	0.11	0.03
		5240	1.301	1.336	97.38	0.12	0.03
		5745	8.383	8.413	99.64	0.02	0.00
		5785	8.383	8.413	99.64	0.02	0.04
		5825	8.384	8.414	99.64	0.02	0.00
802.11ac (VHT40)	SISO	5190	0.648	0.682	95.01	0.22	0.03
		5230	0.648	0.683	94.88	0.23	0.03
		5755	0.637	0.671	94.93	0.23	0.04
		5795	0.637	0.671	94.93	0.23	0.03

### 1.1.2 Test Graph

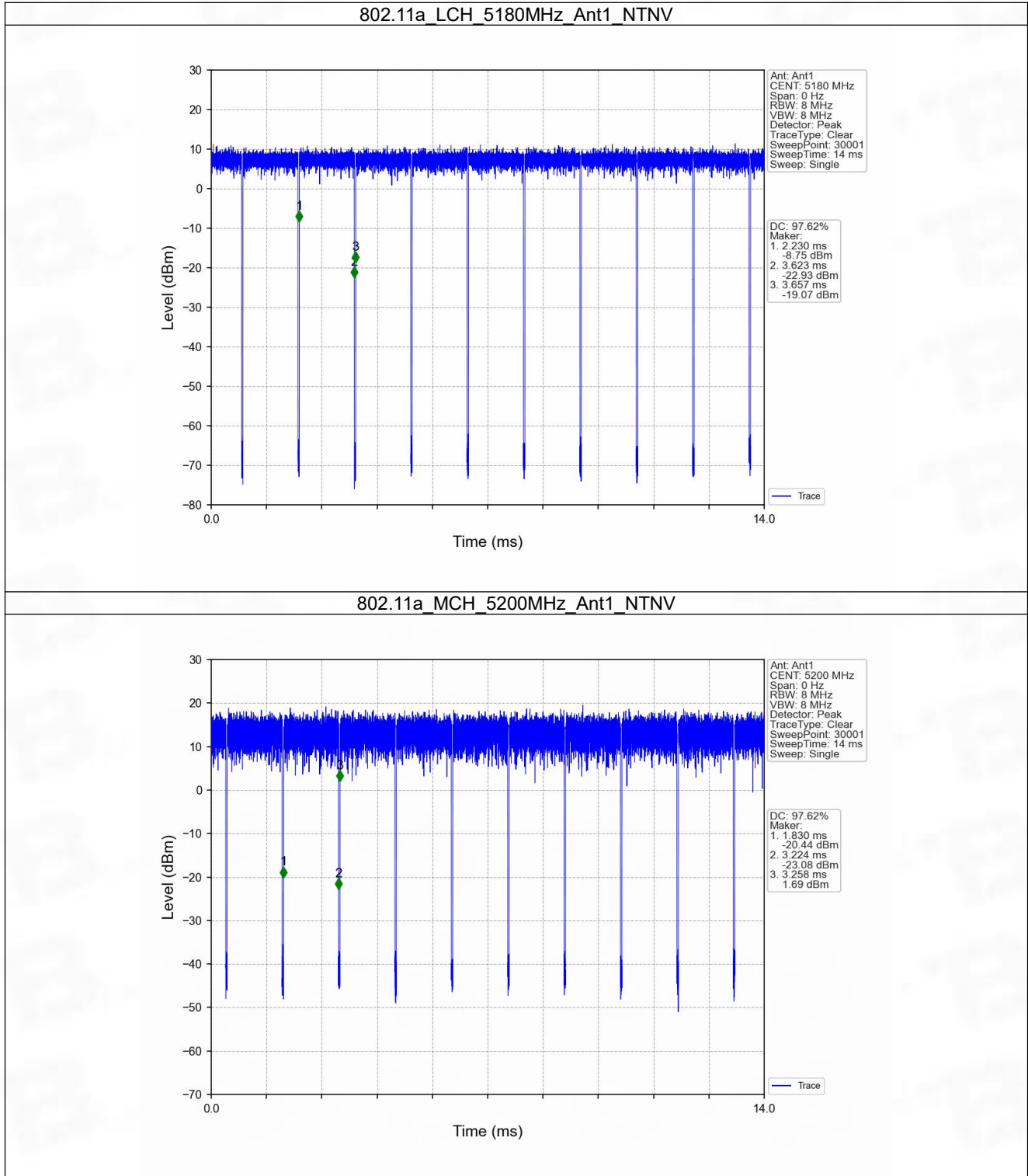

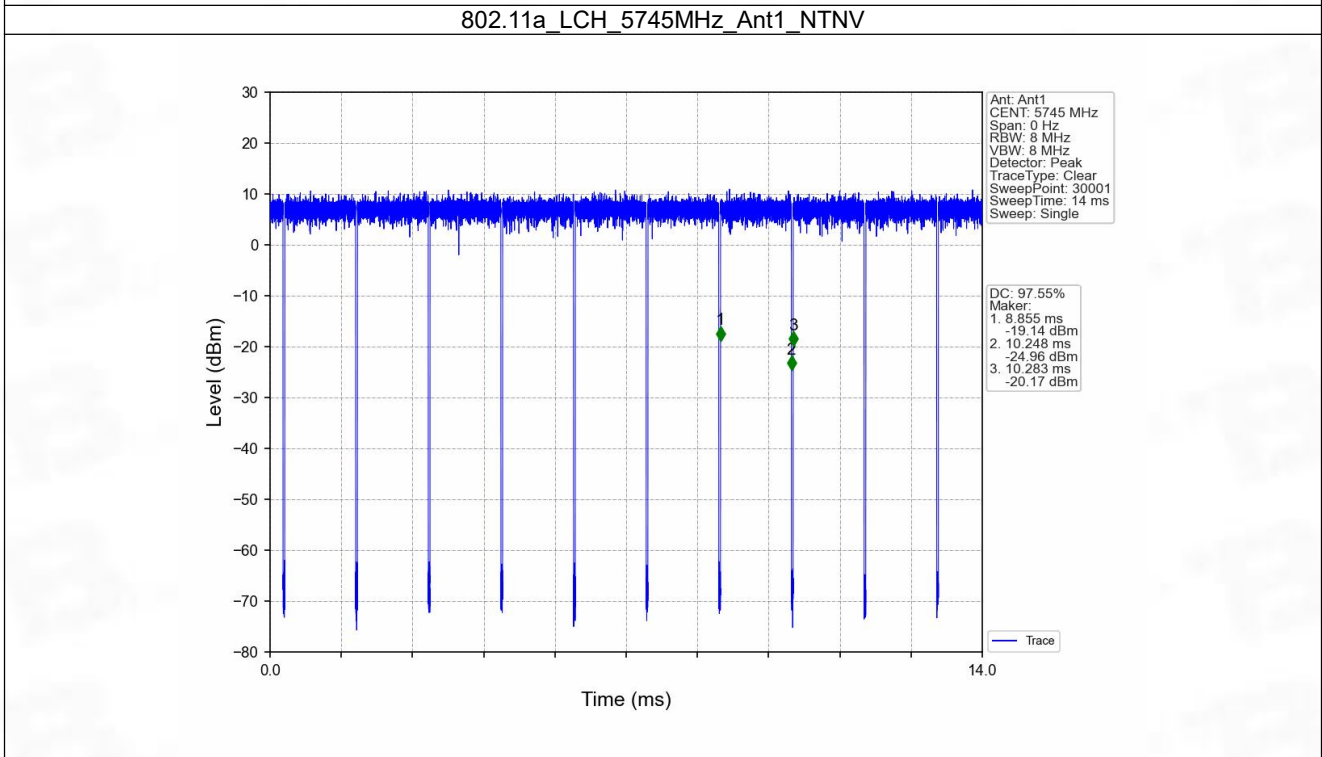
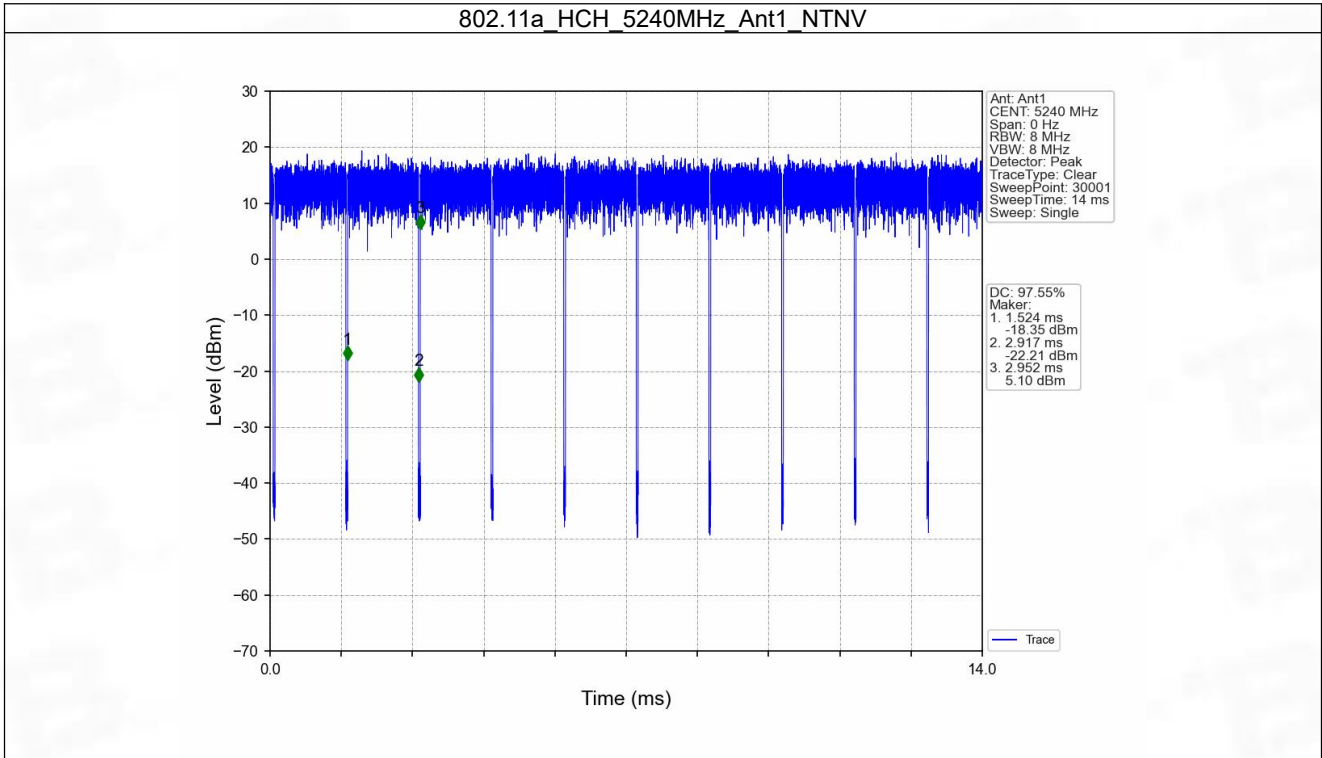

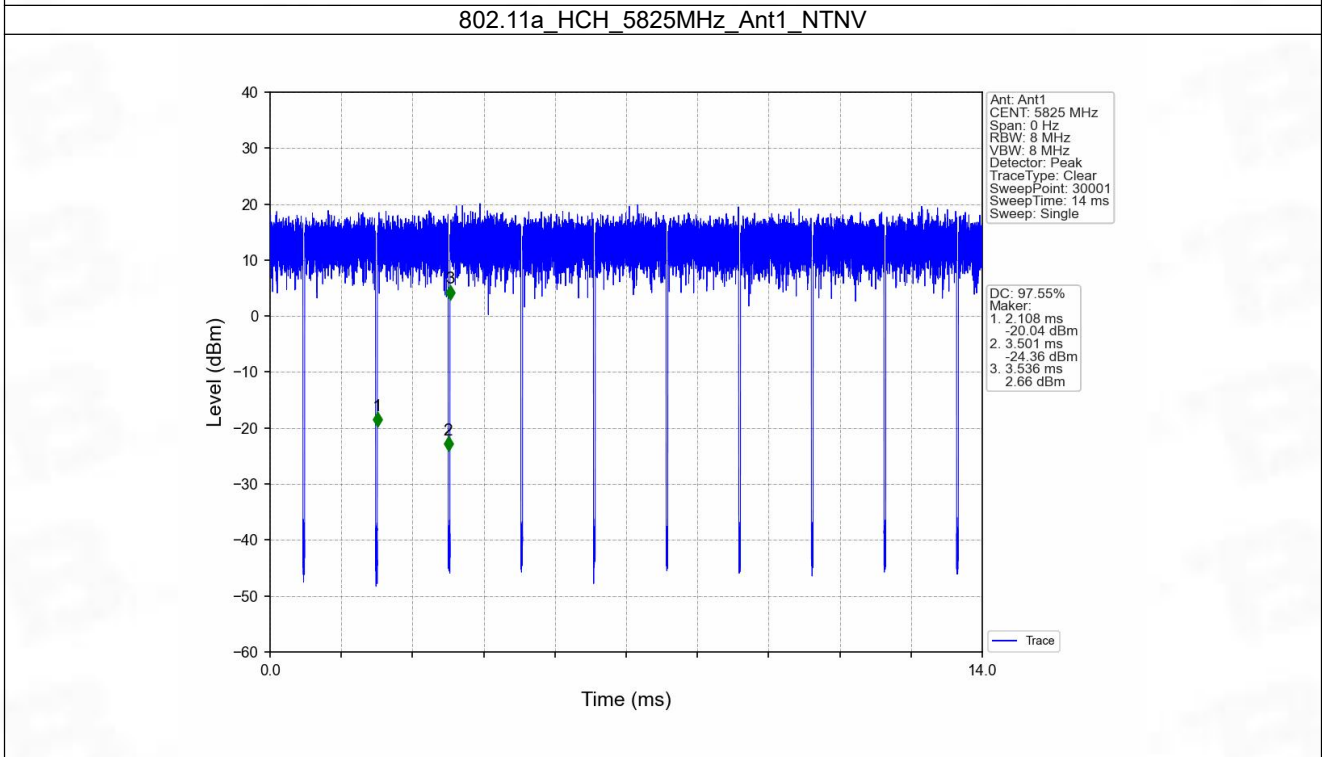
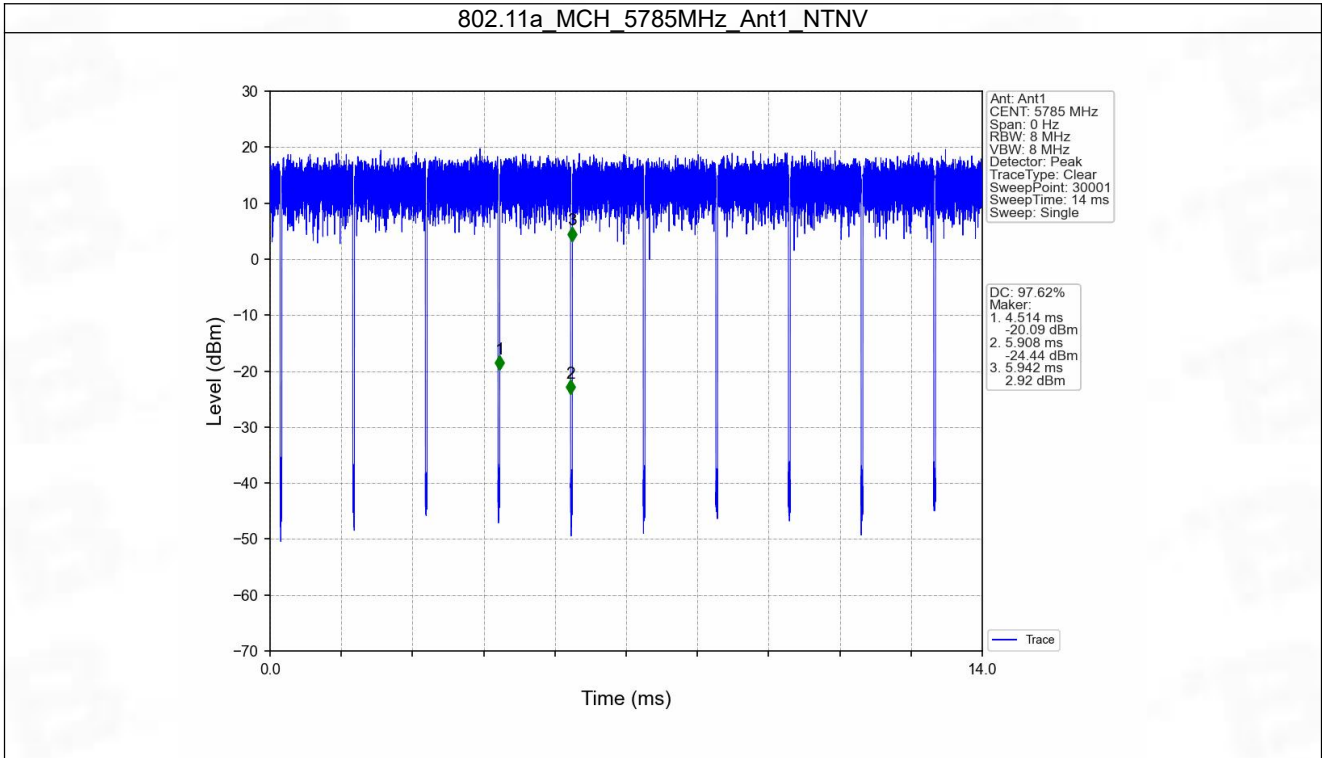



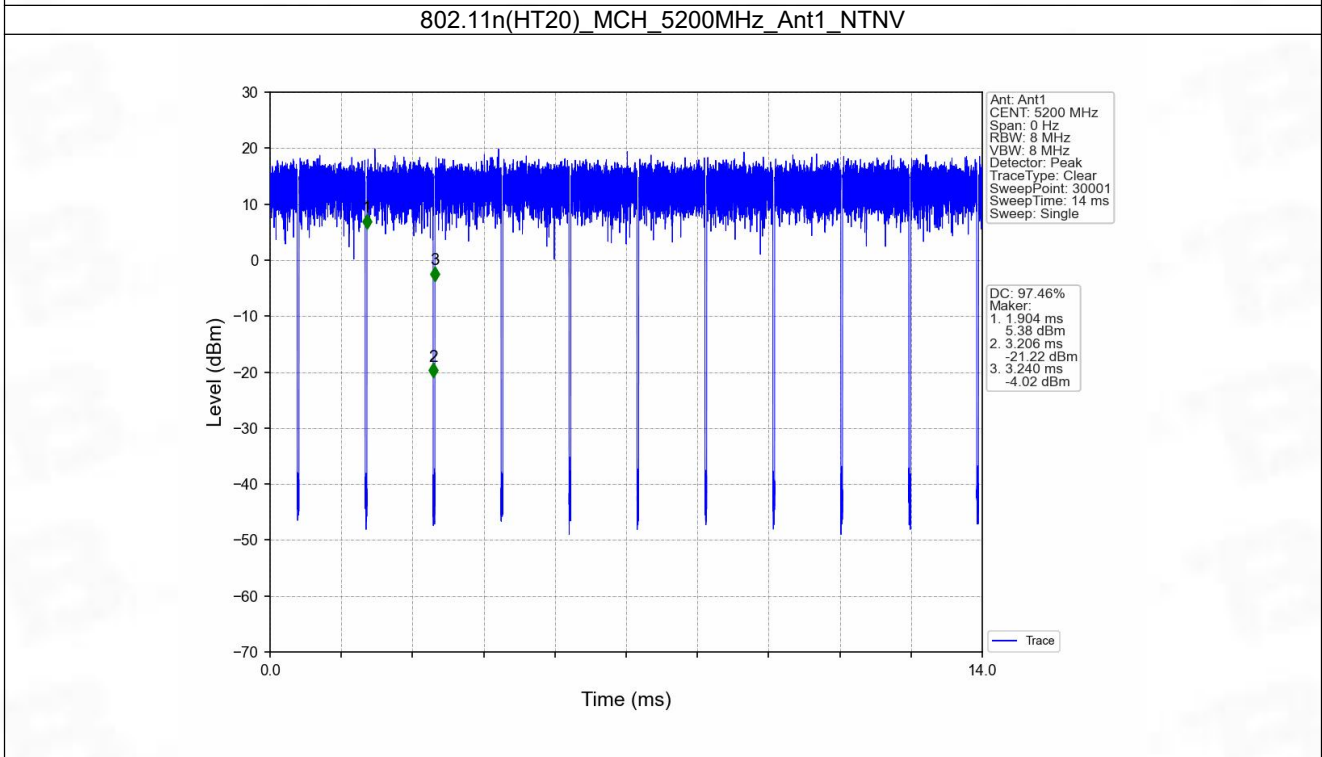
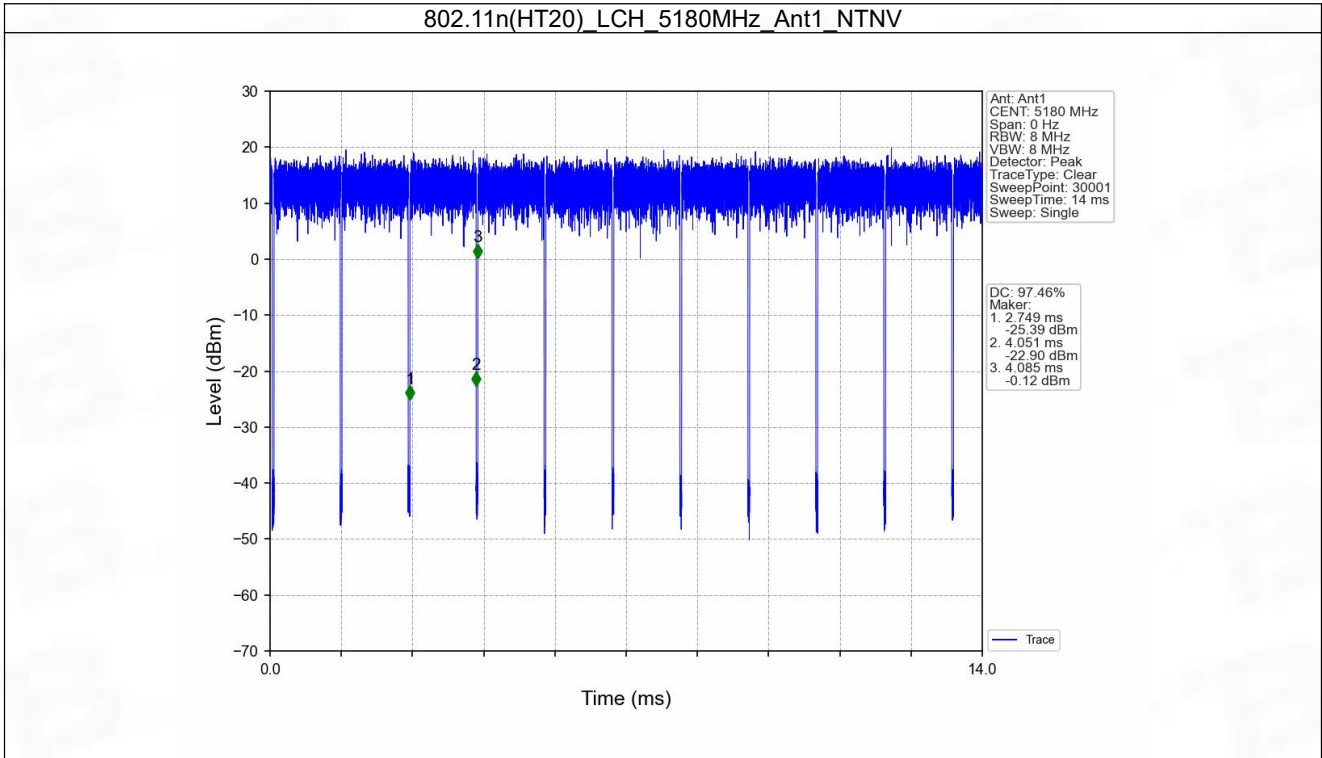

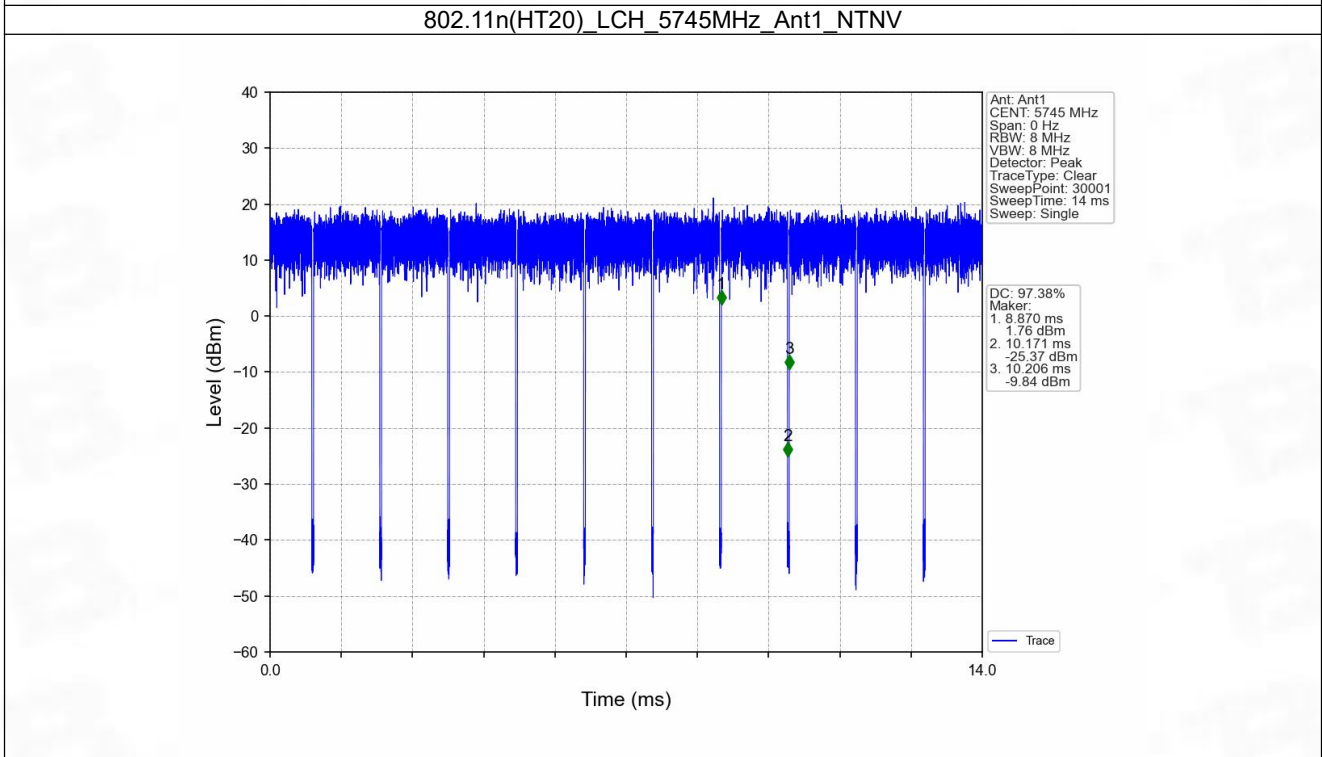
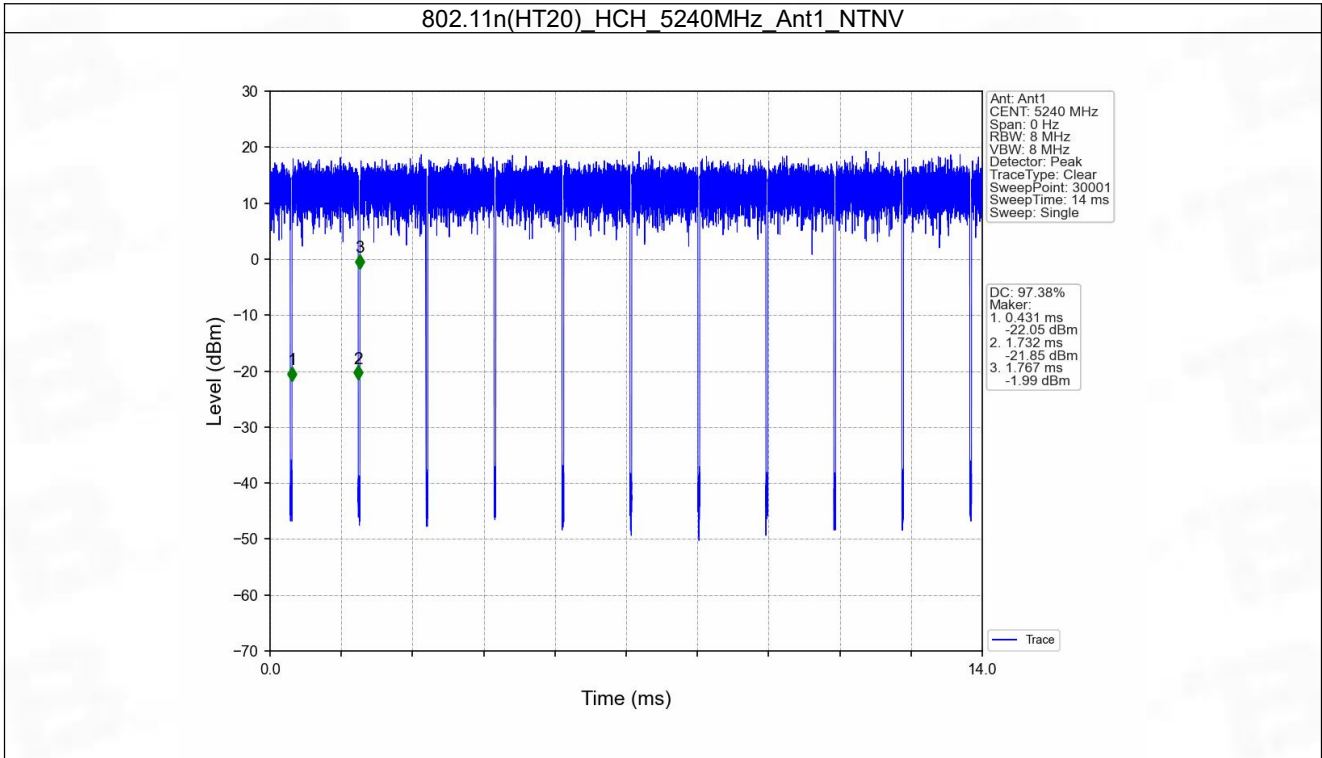

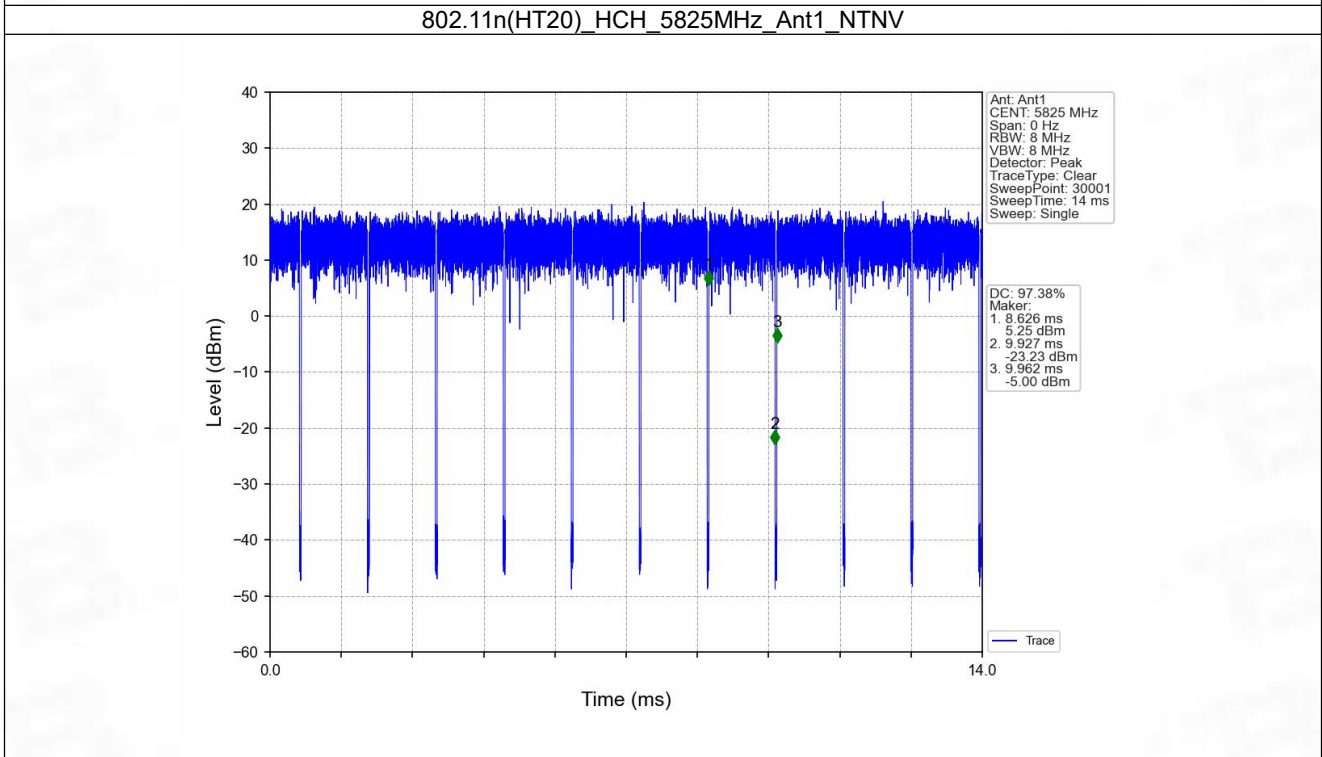
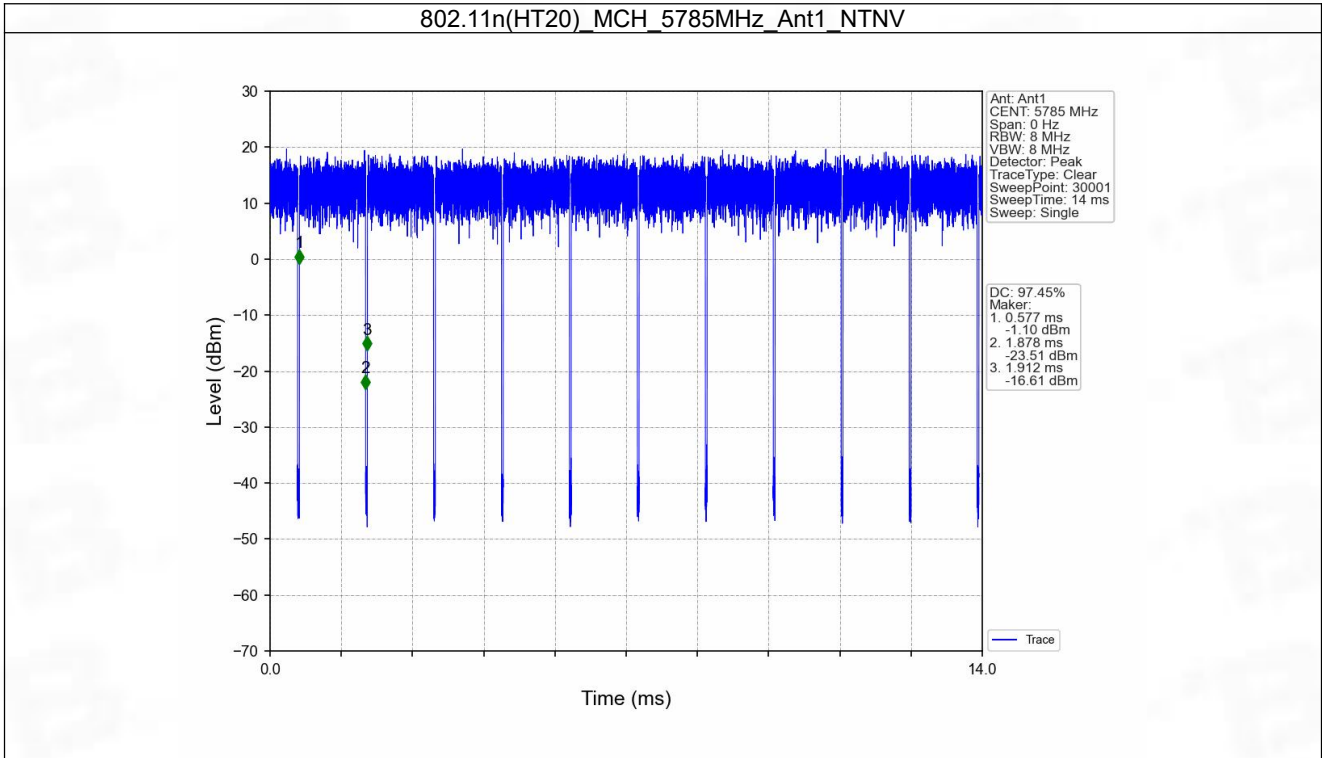

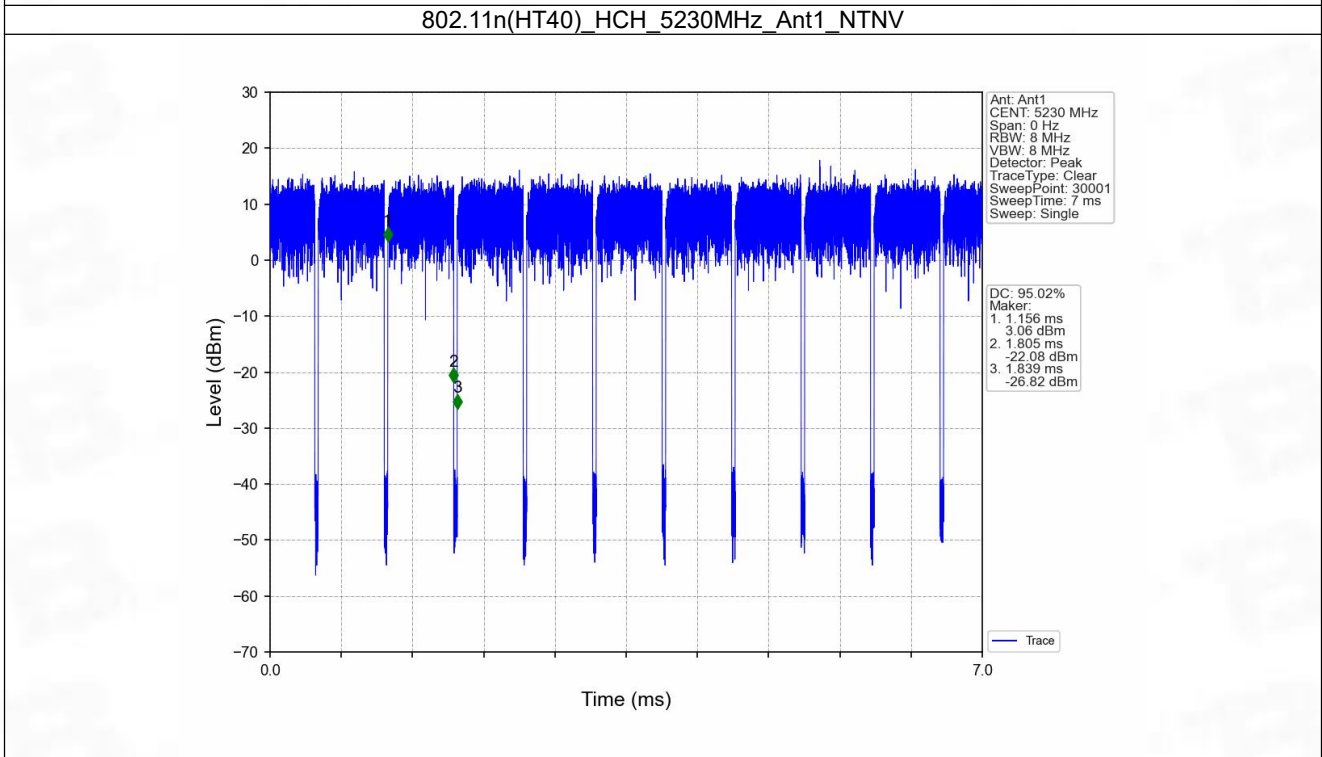
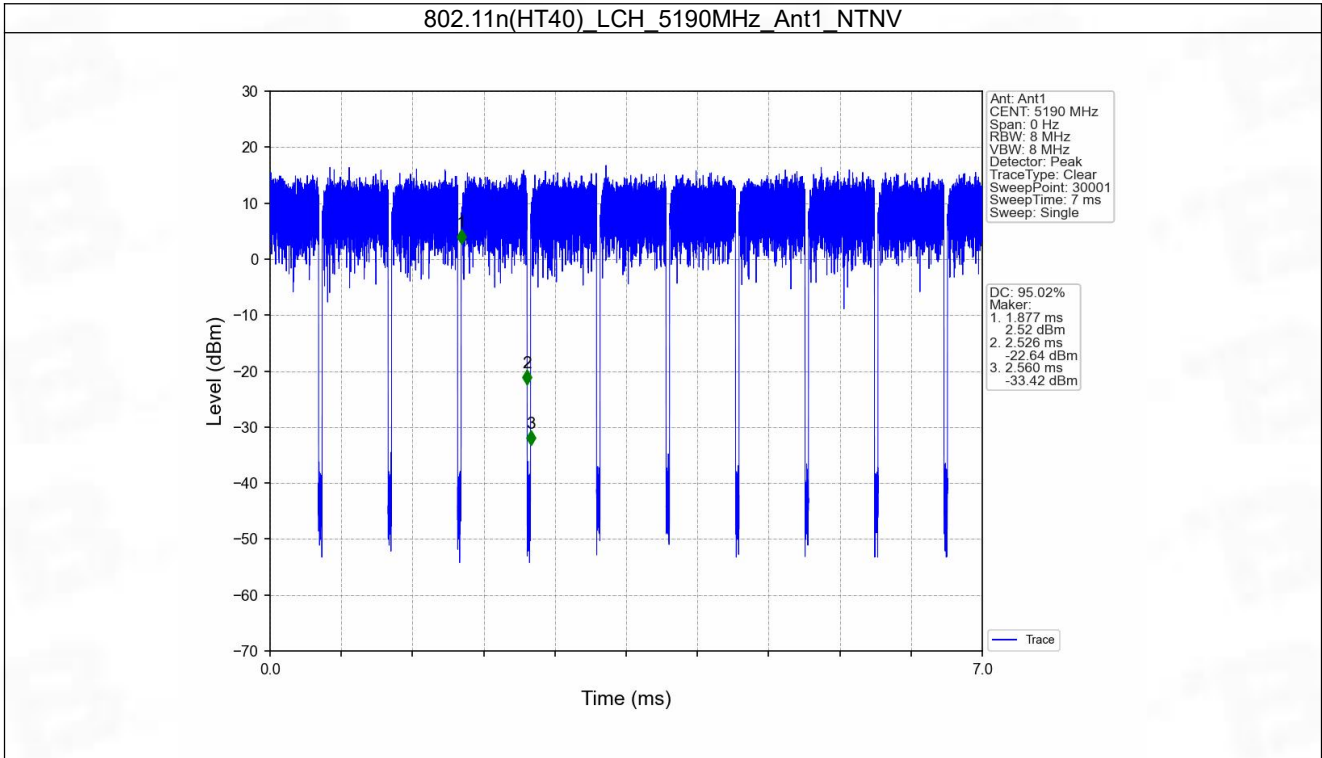

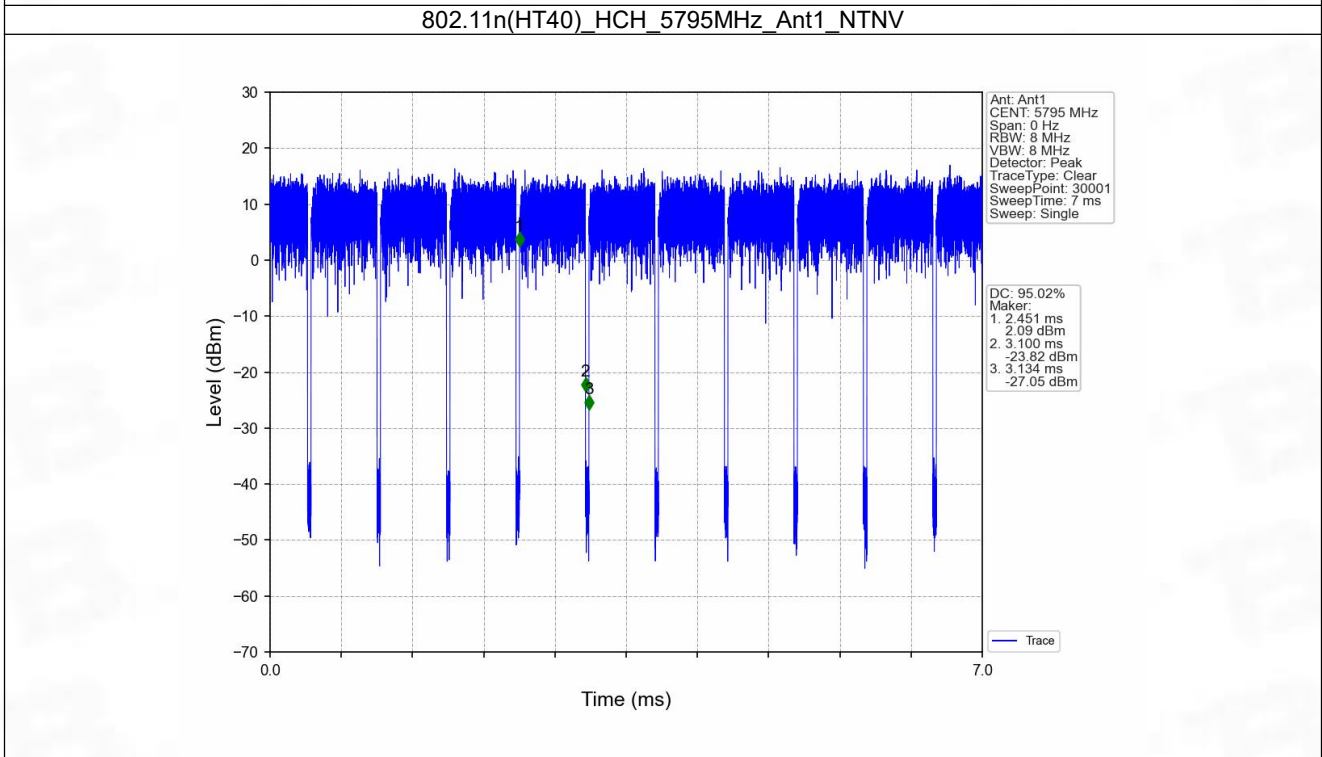
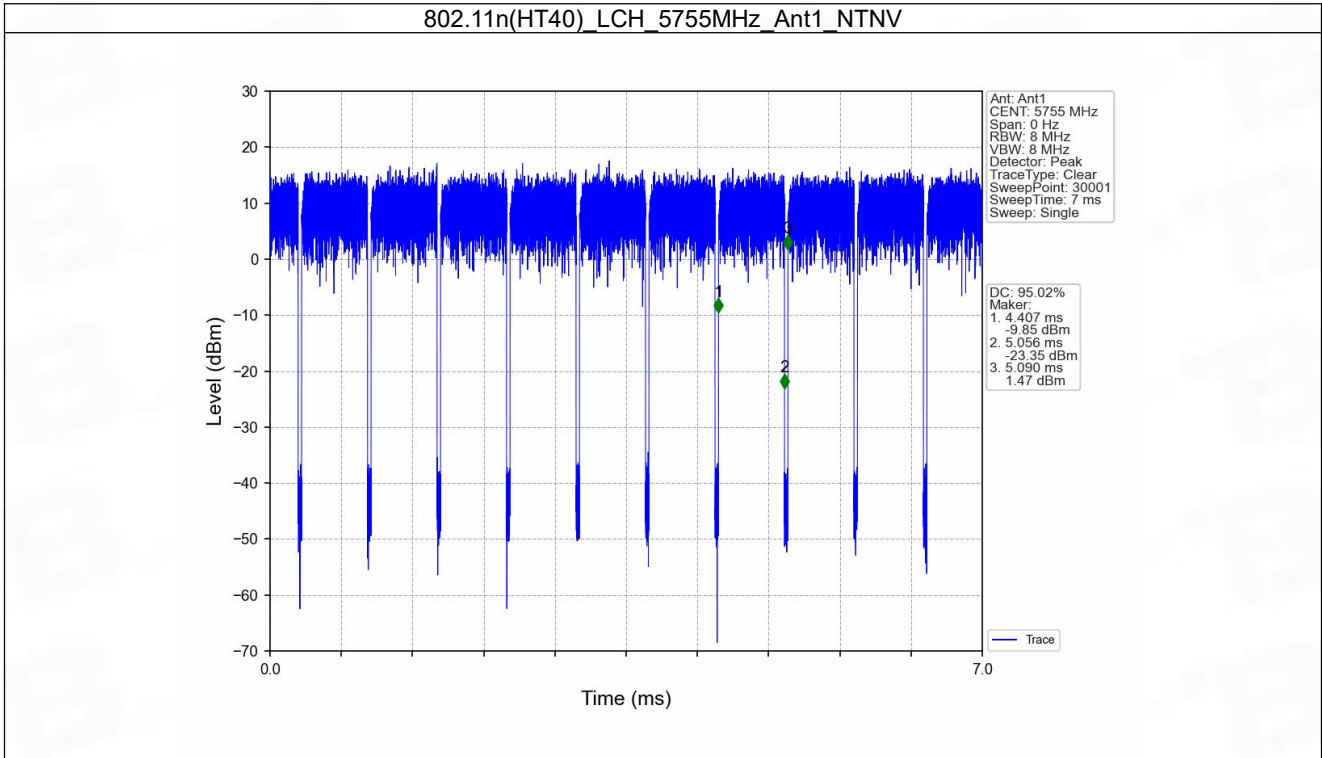

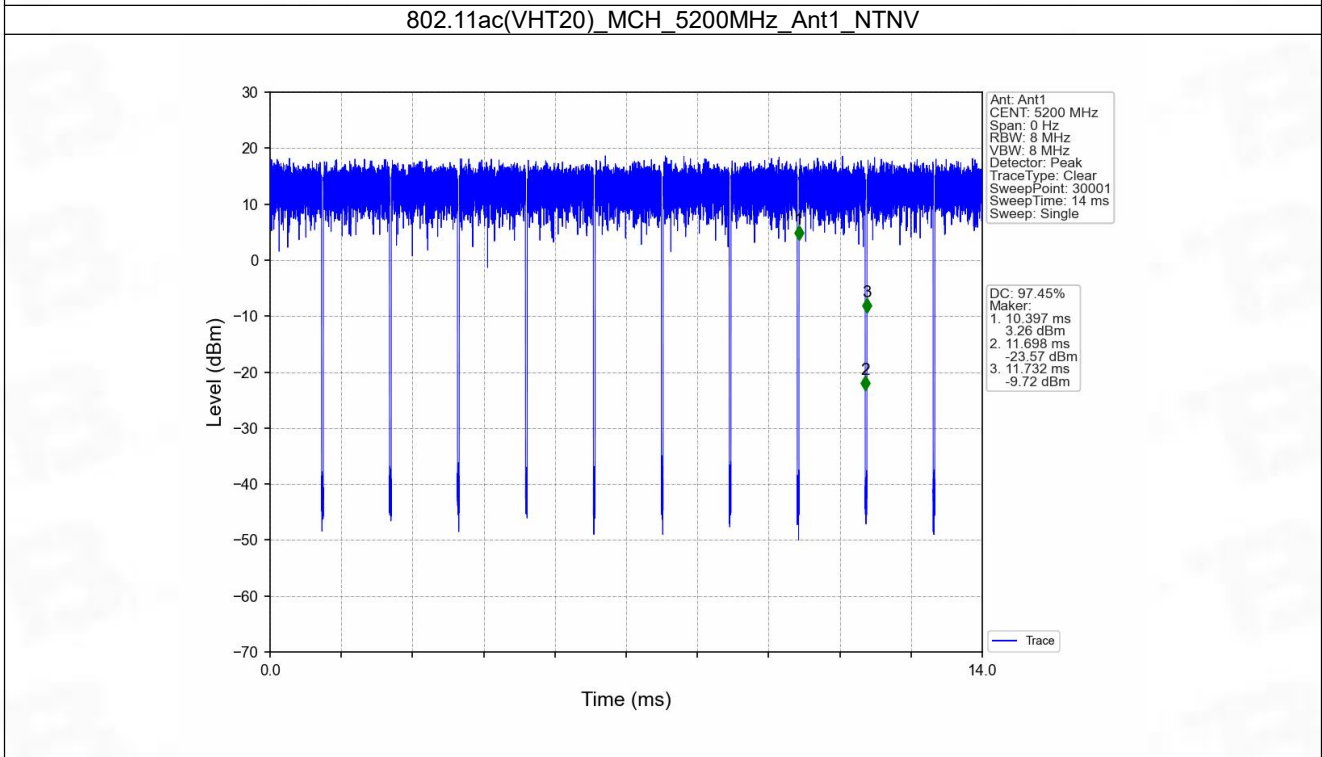
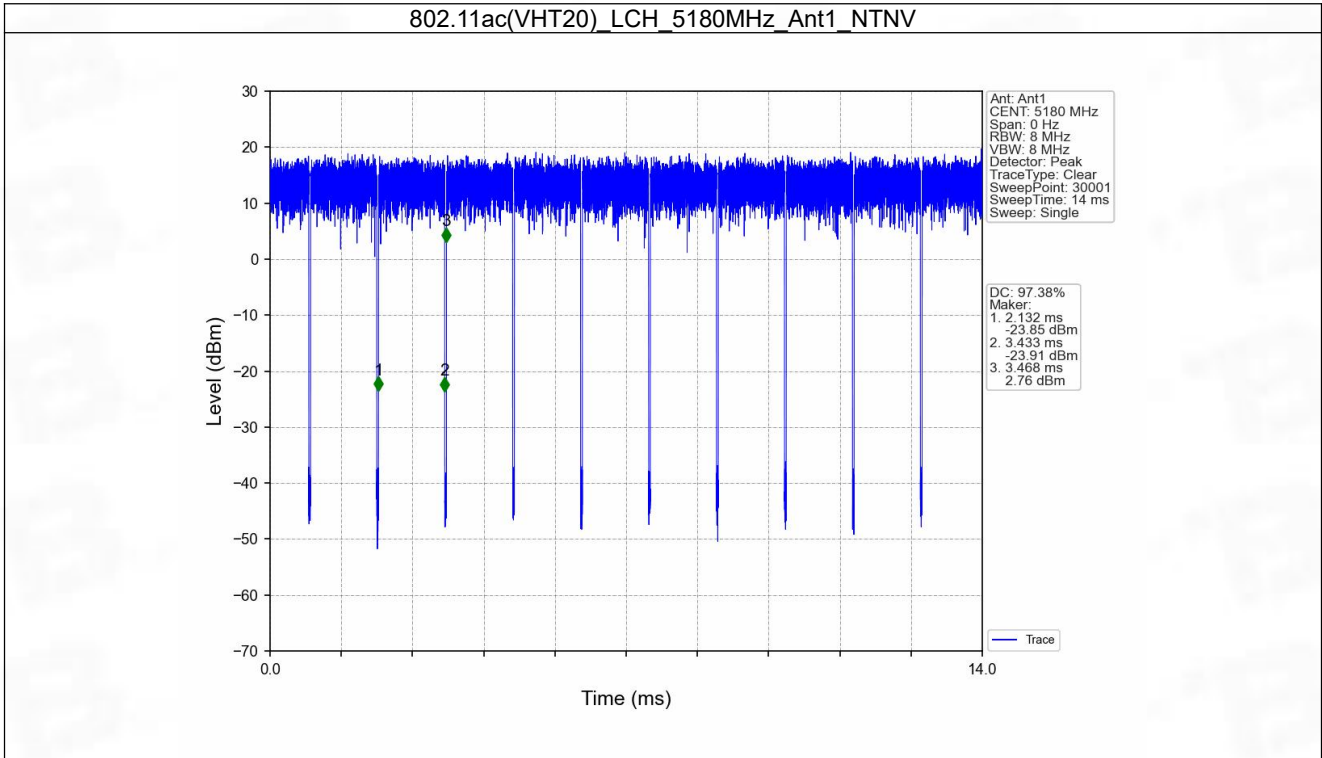

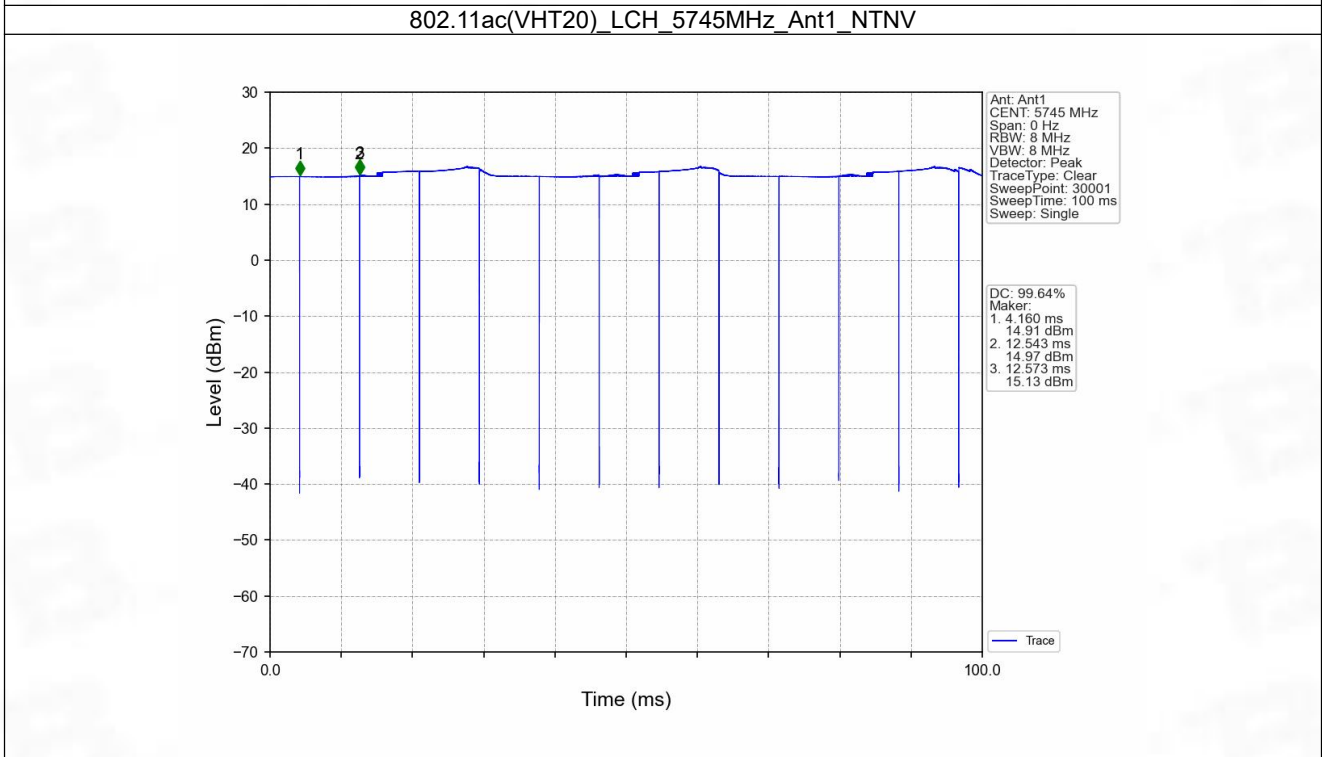
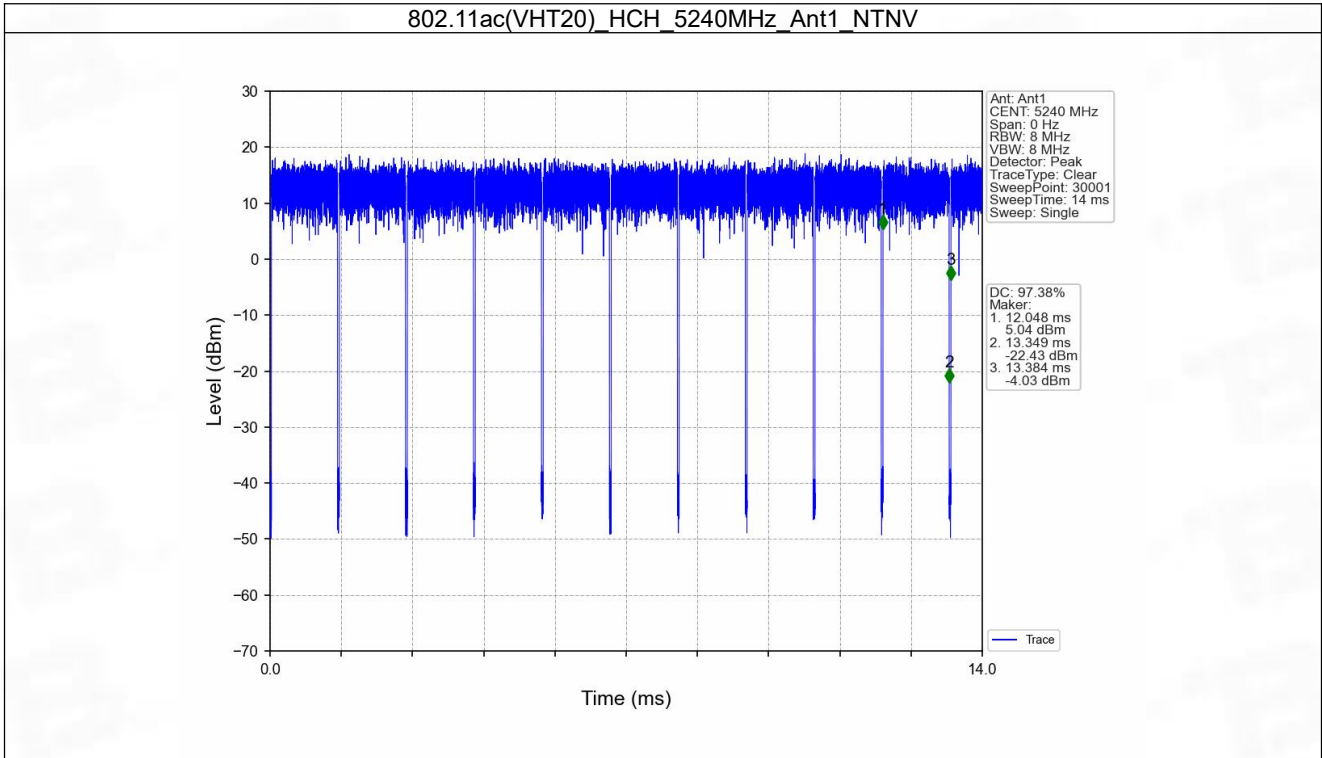

802.11ac(VHT20)\_MCH\_5785MHz\_Ant1\_NTNV

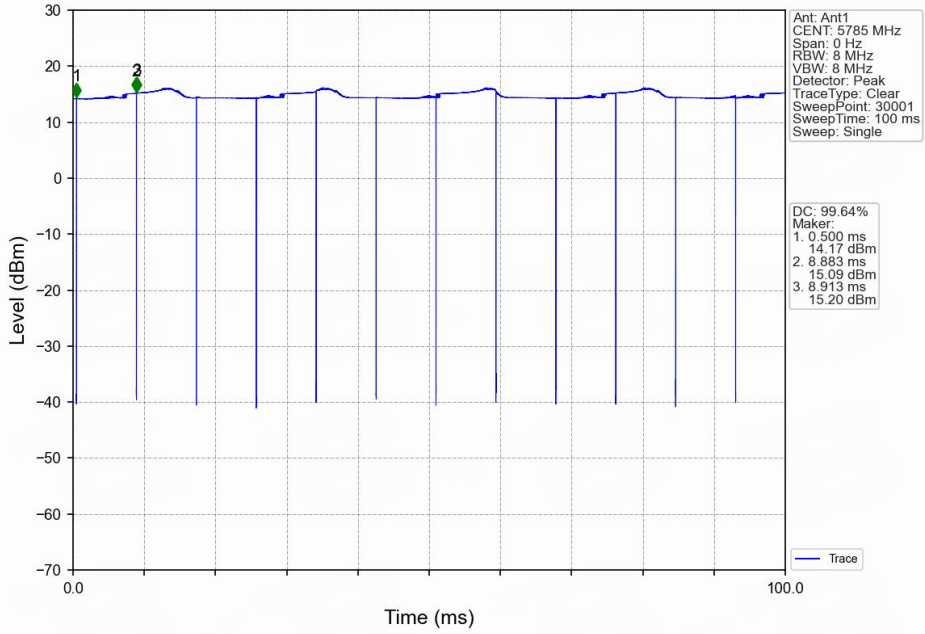

802.11ac(VHT20)\_HCH\_5825MHz\_Ant1\_NTNV

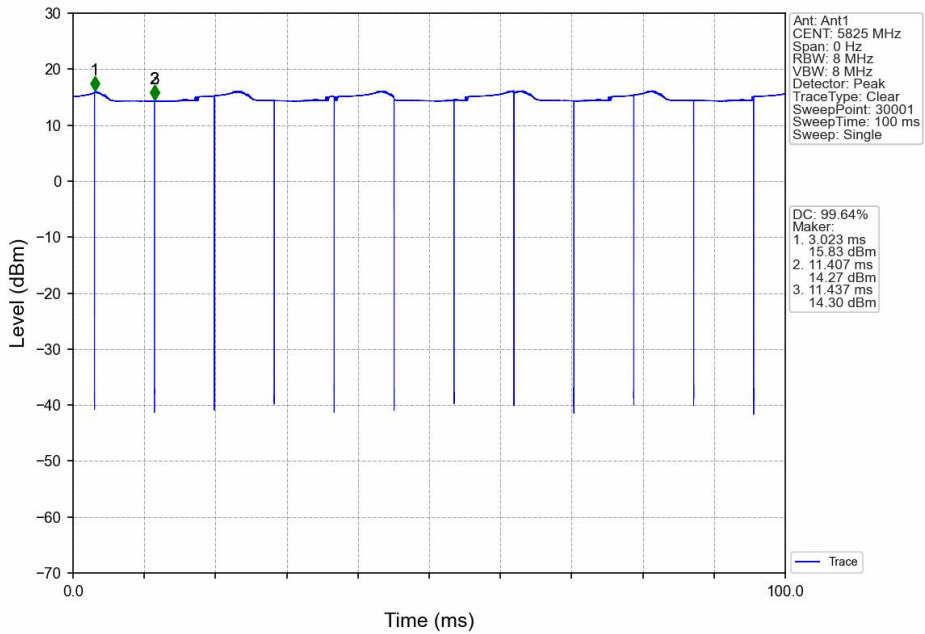



802.11ac(VHT40)\_LCH\_5190MHz\_Ant1\_NTNV

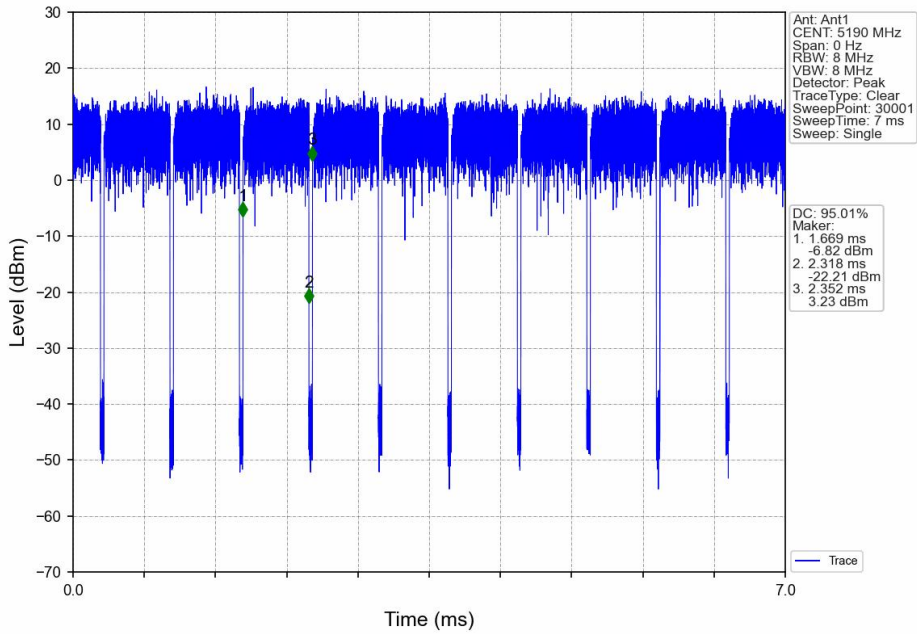

802.11ac(VHT40)\_HCH\_5230MHz\_Ant1\_NTNV

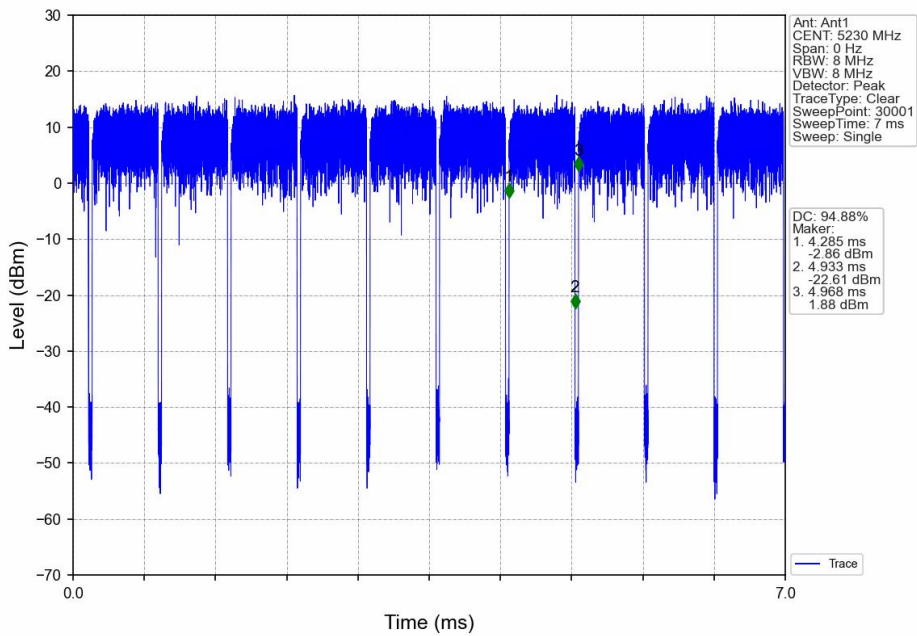

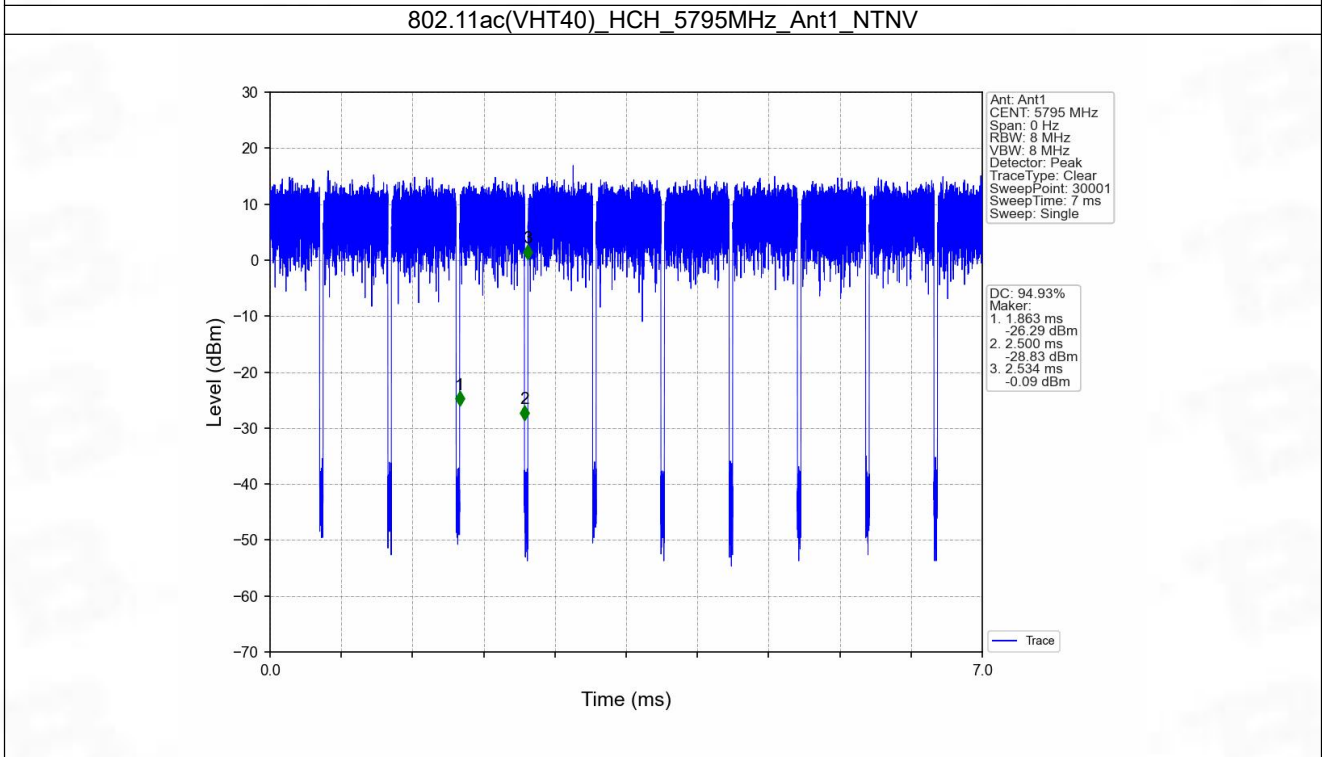
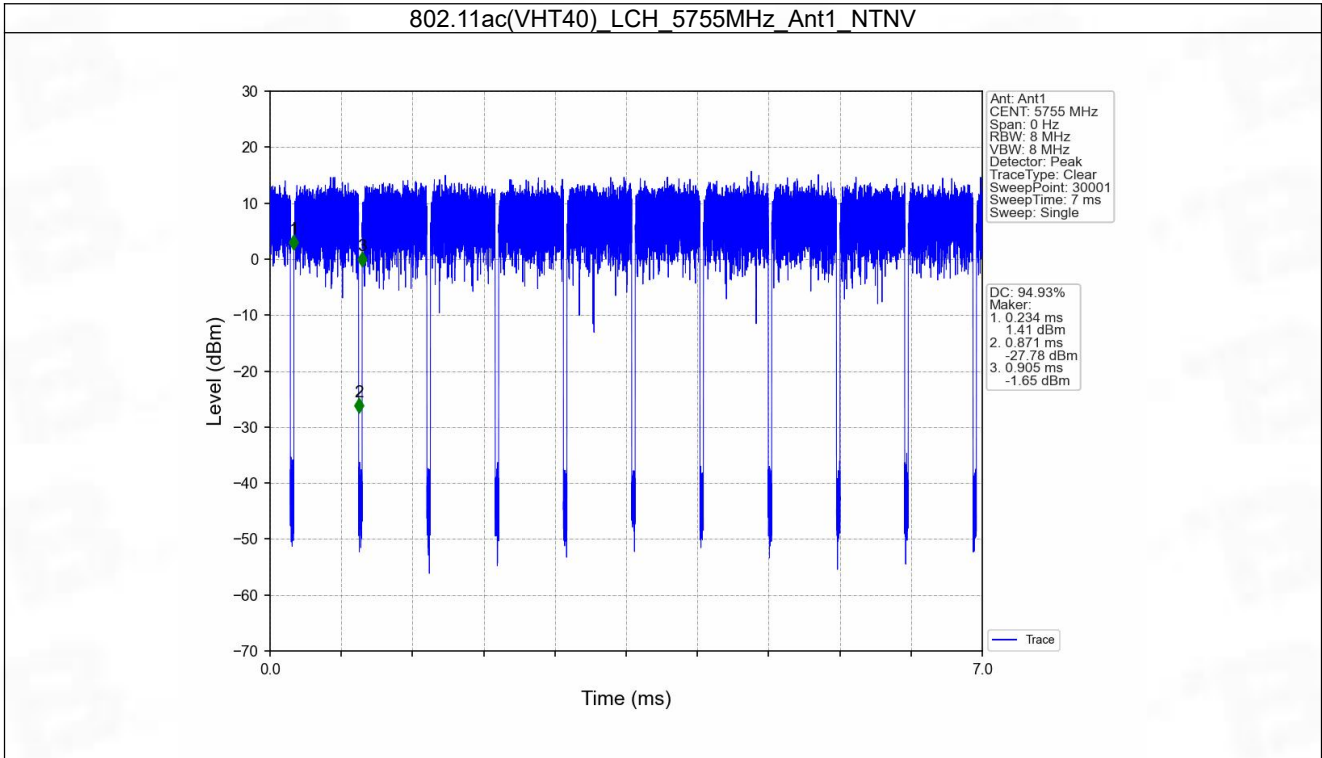

## 2. Bandwidth

### 2.1 OBW

#### 2.1.1 Test Result

Mode	TX Type	Frequency (MHz)	ANT	99% Occupied Bandwidth (MHz)		Verdict
				Result		
802.11a	SISO	5180	1	18.300		Pass
		5200	1	18.181		Pass
		5240	1	18.110		Pass
		5745	1	17.455		Pass
		5785	1	17.481		Pass
		5825	1	17.523		Pass
802.11n (HT20)	SISO	5180	1	19.074		Pass
		5200	1	19.073		Pass
		5240	1	18.753		Pass
		5745	1	18.162		Pass
		5785	1	18.180		Pass
		5825	1	18.205		Pass
802.11n (HT40)	SISO	5190	1	37.616		Pass
		5230	1	37.515		Pass
		5755	1	36.696		Pass
		5795	1	36.657		Pass
802.11ac (VHT20)	SISO	5180	1	19.095		Pass
		5200	1	19.054		Pass
		5240	1	18.866		Pass
		5745	1	18.163		Pass
		5785	1	18.142		Pass
		5825	1	18.203		Pass
802.11ac (VHT40)	SISO	5190	1	37.392		Pass
		5230	1	37.385		Pass
		5755	1	36.514		Pass
		5795	1	36.638		Pass