

# 深圳市八方达通信有限公司

## Z5563测试报告

---

工程：毛宇峥

测试日期：2024-06-11

工程电话:13424326585

# 天线频段设计

---

射频	网络模式	GSM+W+LTE+BT+WIFI+GPS	
	频段要求	GSM: B2 B3 B5 B8 WCDMA: B2 B4 B5 LTE: B2 B4 B5 B12 B25 B26 B41 B66 B71	
	通讯天线数量	主天线	GSM+W+LTE
		分集天线	分集
三合一天线		GPS+WIFI+BT	

# 测试简介

测试系统：ETS 3D屏蔽暗室

测试环境：温度 $22^{\circ}\text{C} \pm 3^{\circ}\text{C}$ ，湿度 $50\% \pm 15\%$

测试设备：测试无源数据时，使用惠普E5071B 网络分析仪

测试有源数据时，使用MT8820C/CMW500 4G全功能综测仪

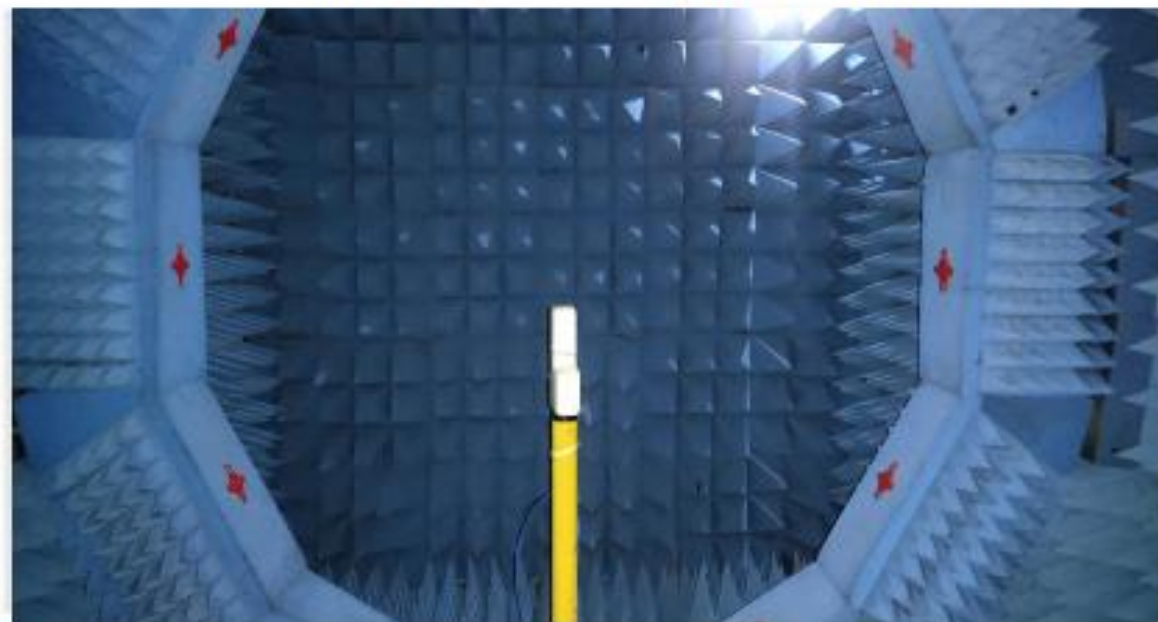

惠普 5071B 8.5GHz 网络分析仪



CMW500全功能综测仪

# Antenna size diagram

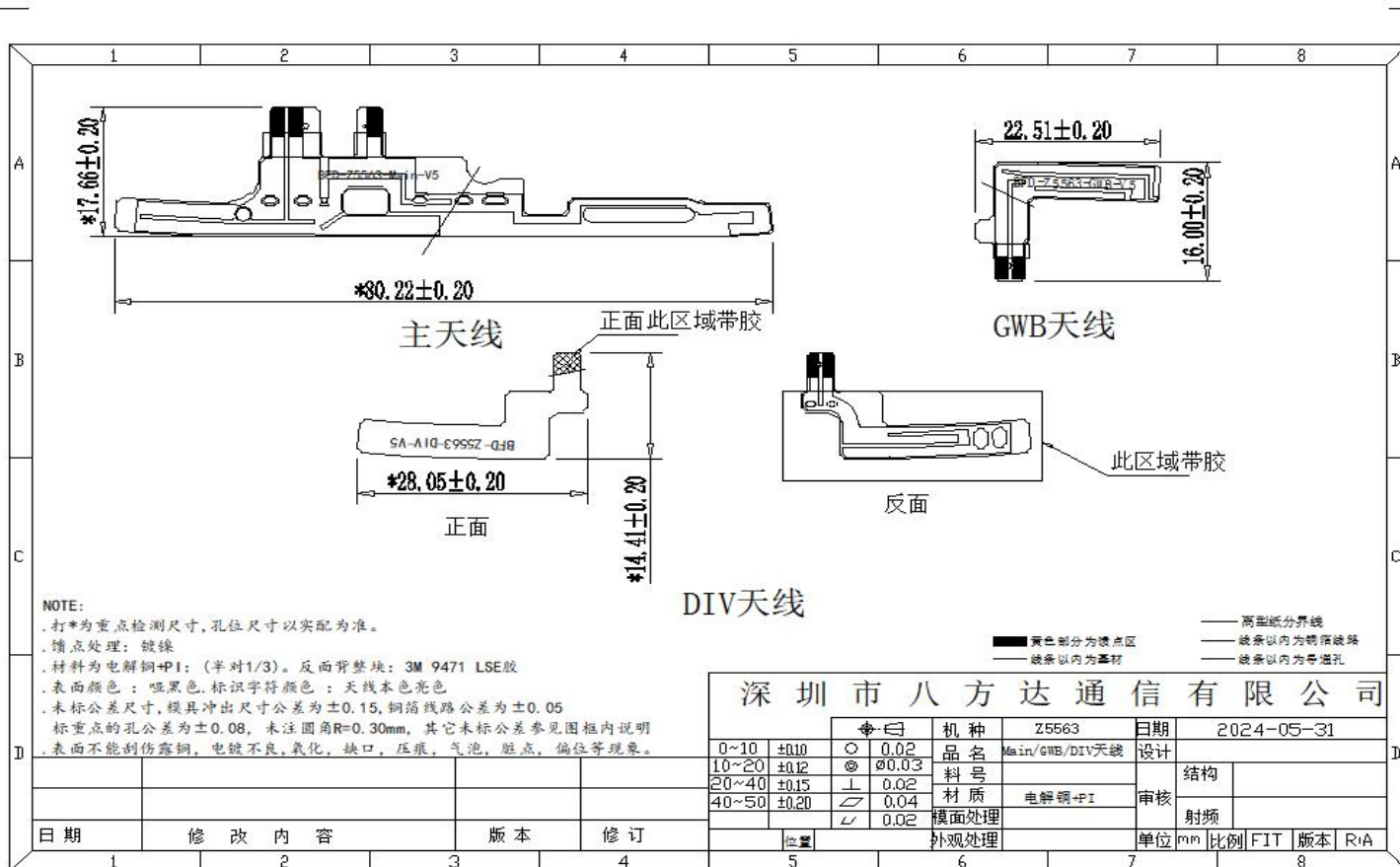

# Antenna Gain

2G	Frequency (MHZ)	Gain (MAX)
GSM850	824-894Mhz	-0.36
GSM900	880-960Mhz	-0.41
DCS1800	1710-1880Mhz	-0.32
PCS1900	1850-1990Mhz	-0.35
3G	Frequency (MHZ)	Gain (MAX)
W-B2	1850-1990Mhz	-0.35
W-B4	1710-2155Mhz	-0.31
W5-B5	824-894Mhz	-0.36

# Antenna Gain

4G	Frequency (MHZ)	Gain (MAX)
LTE-B2	1850-1990Mhz	-0.35
LTE-B4	1710-2155Mhz	-0.31
LTE-B5	824-894Mhz	-0.36
LTE-B12	698-746Mhz	-0.81
LTE-B25	1850-1995Mhz	-0.35
LTE-B26	814-894Mhz	-0.36
LTE-B41	2500-2690Mhz	0.16
LTE-B66	1710-2200MHZ	-0.31
LTE-B71	617-697.9Mhz	-1.36
2.4G-WIFI	2400-2500Mhz	-0.35
5G-WIFI	5150-5850Mhz	-0.49
BT	2400-2500Mhz	-0.35
GPS	1575Mhz	-0.24

# 617-697. 9MHz波形图

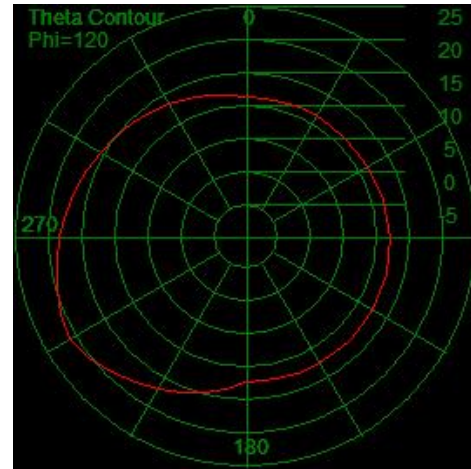
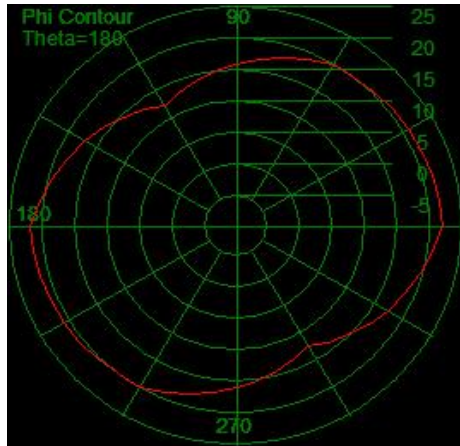
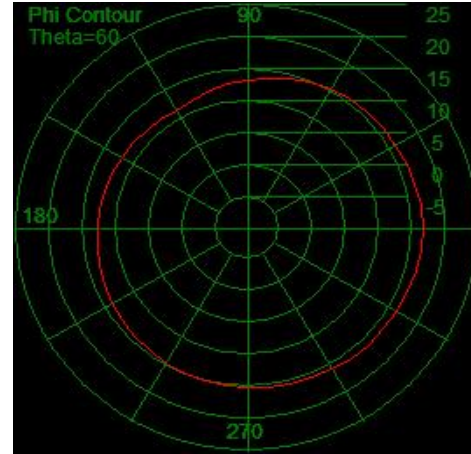
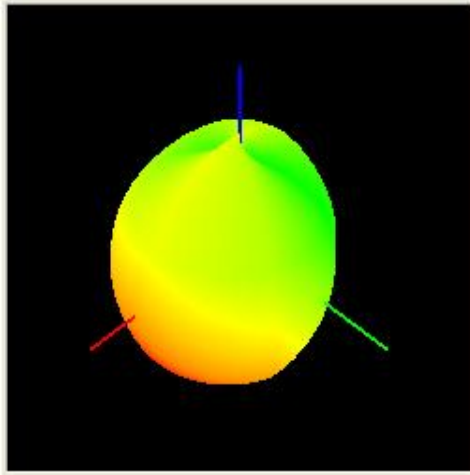

# 698-798MHz波形图

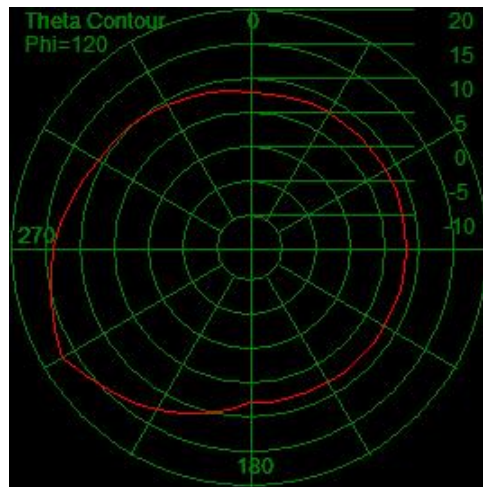
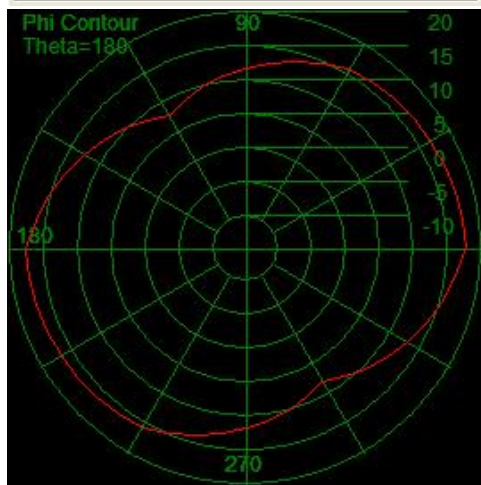
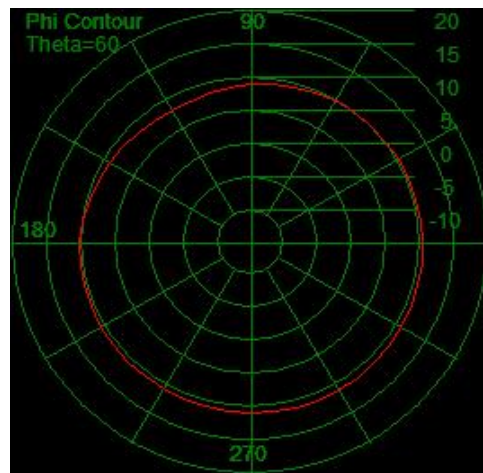
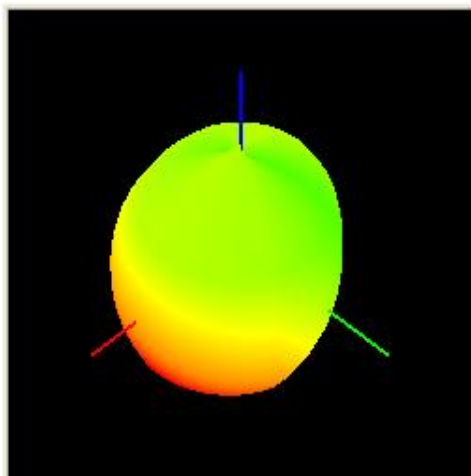



# 814-894MHz波形图

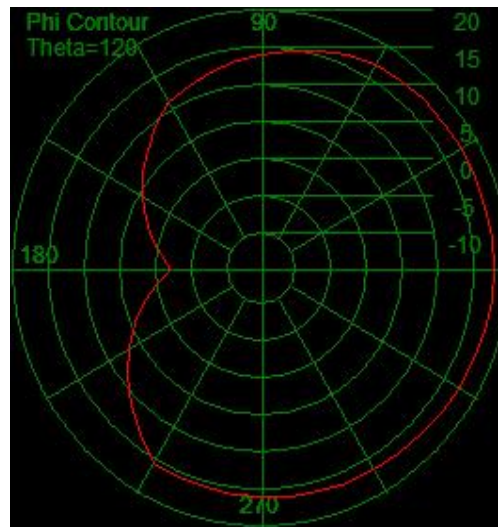
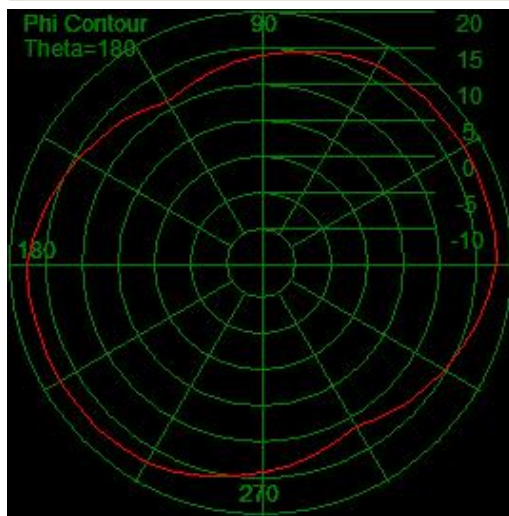
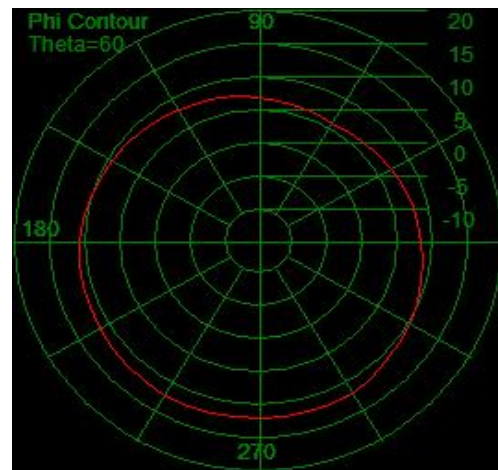
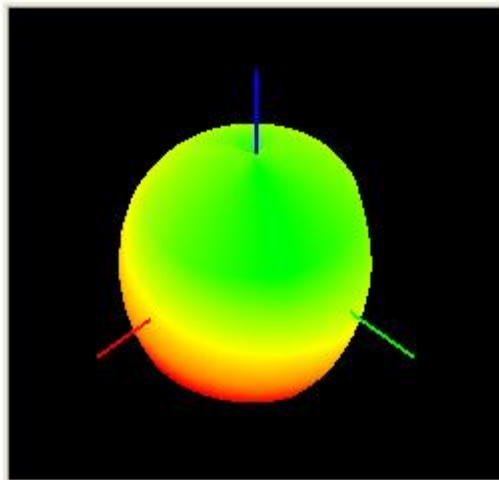

# 880-960MHz 波形图

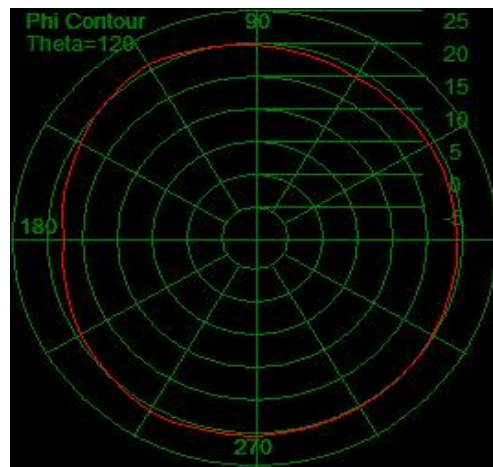
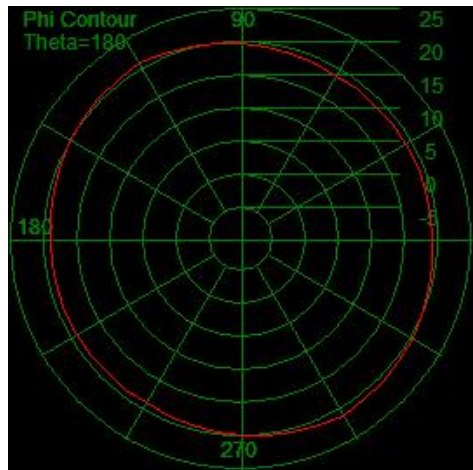
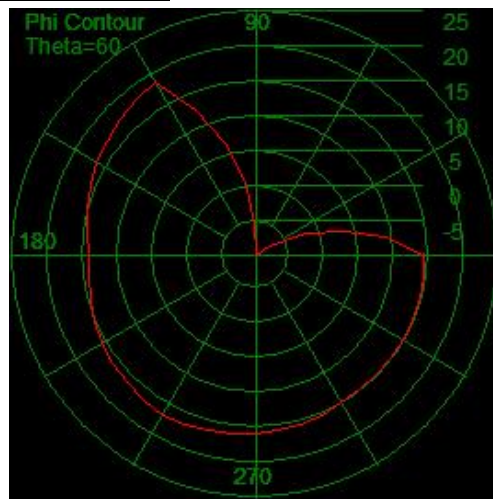
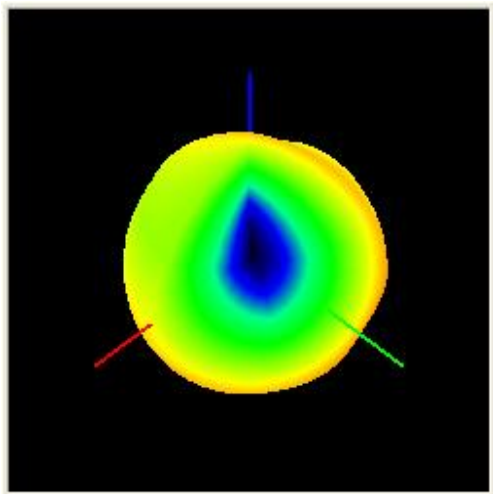

# 1710-1880MHz波形图

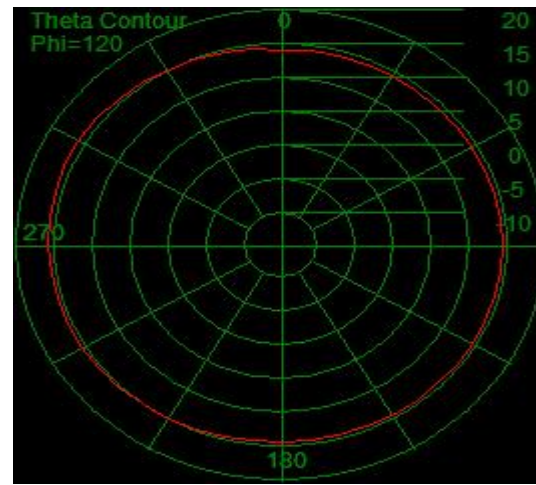
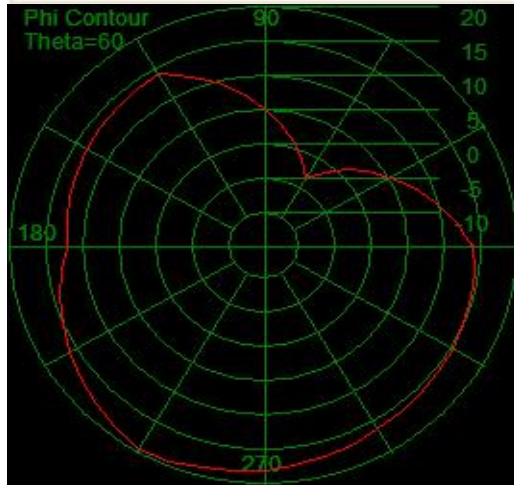
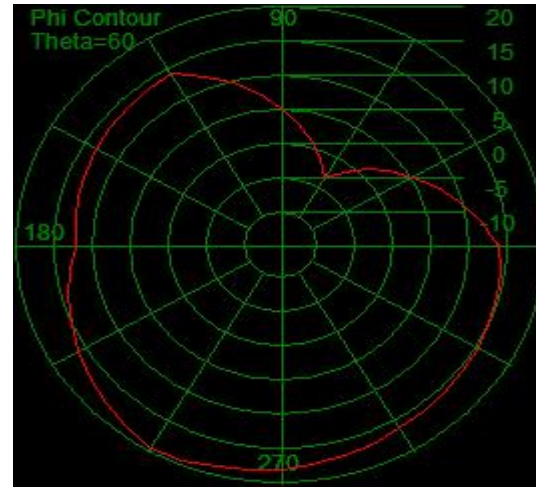
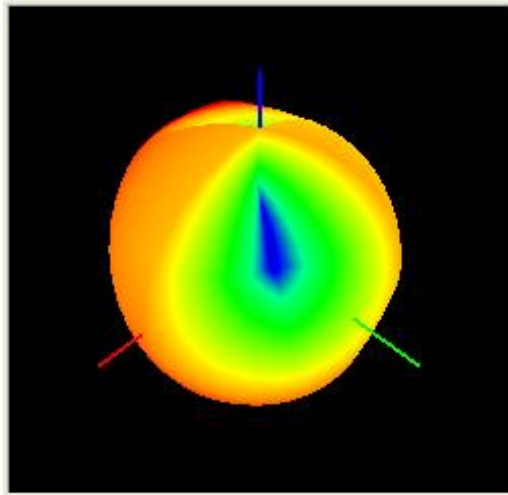

# 1880-1990MHz波形图

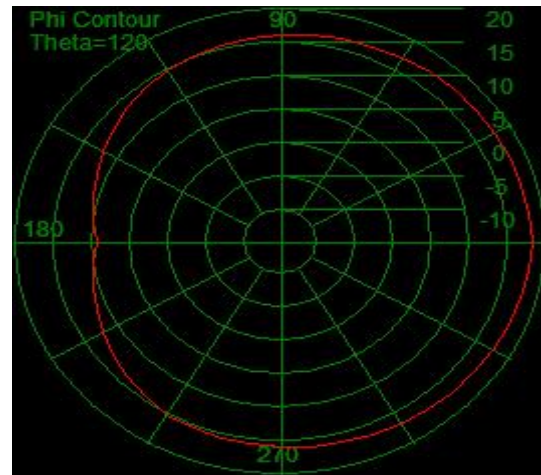
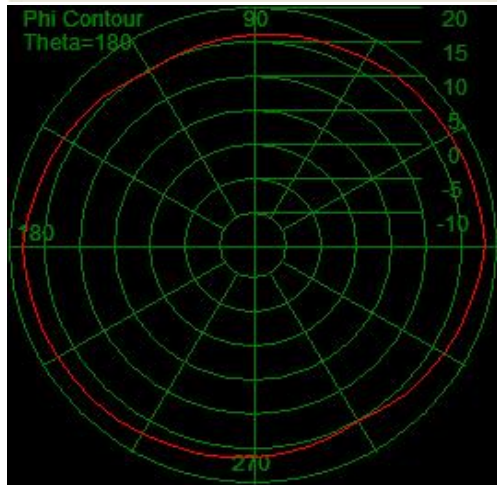
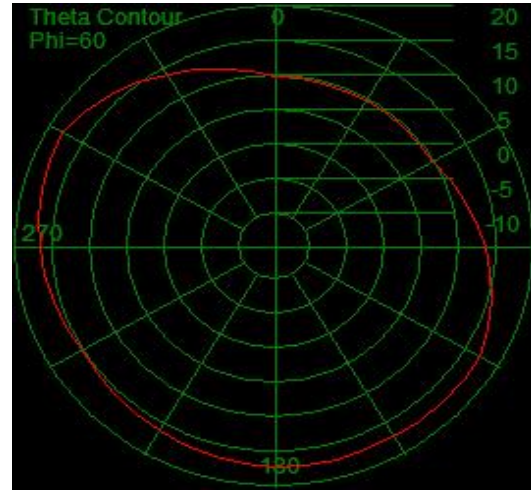
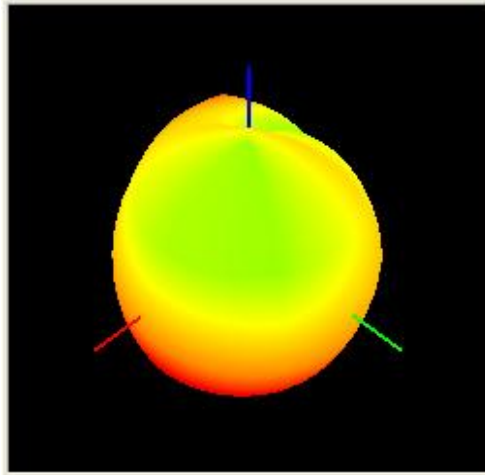



# 1920-2170MHz波形图

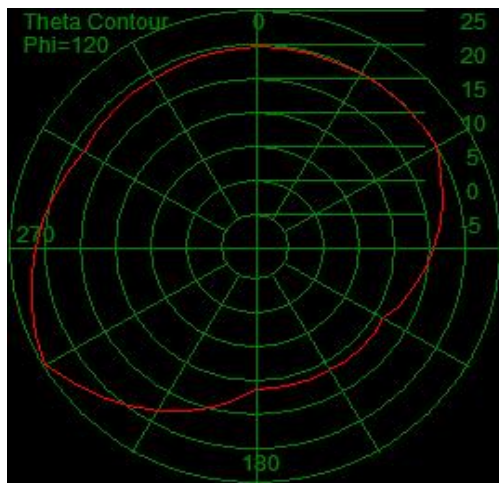
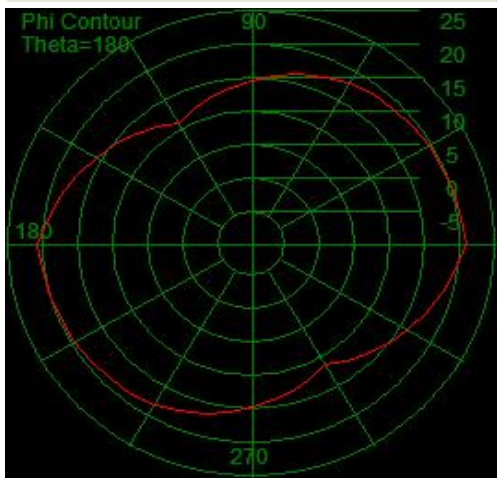
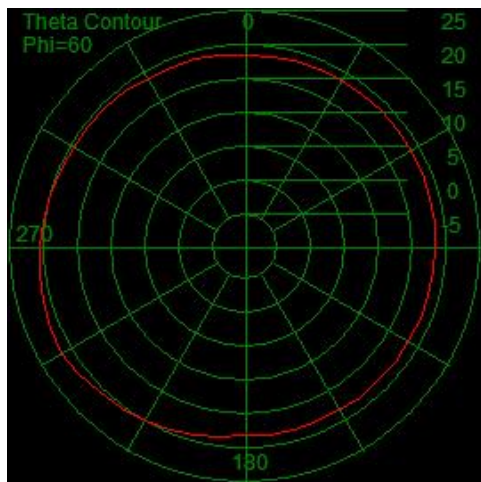
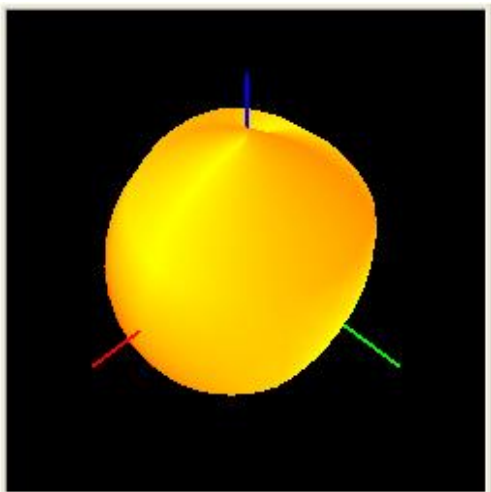

# 2300-2400MHz 波形图

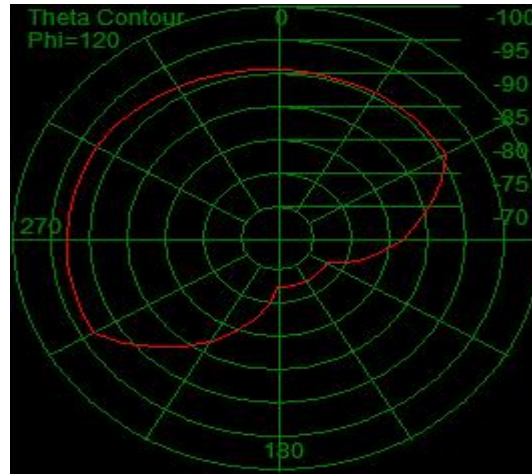
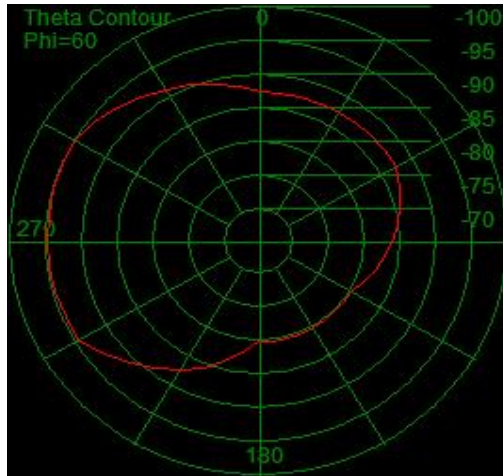
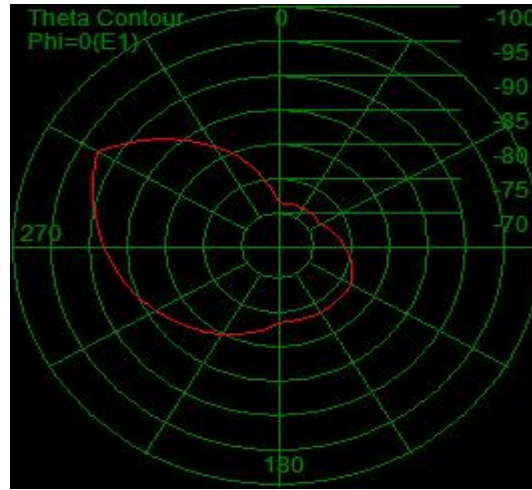
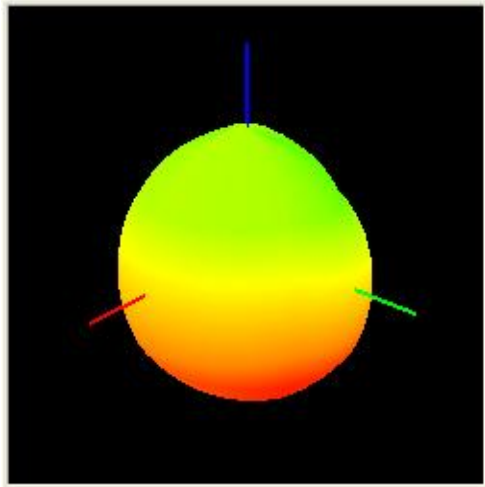

# 2500-2690MHz波形图

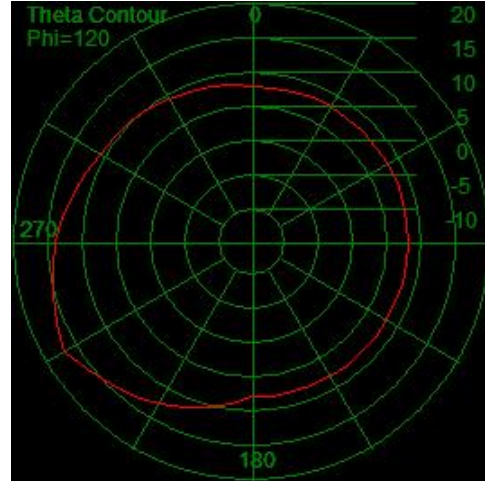
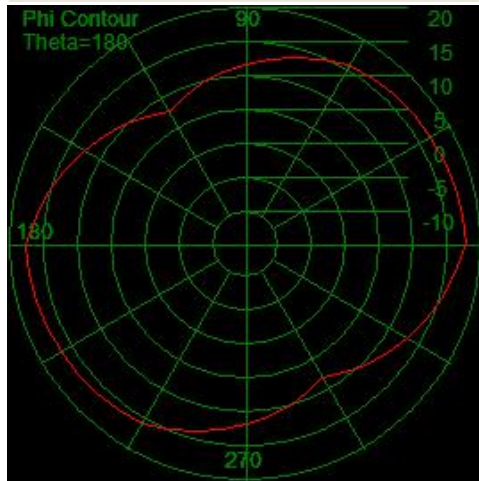
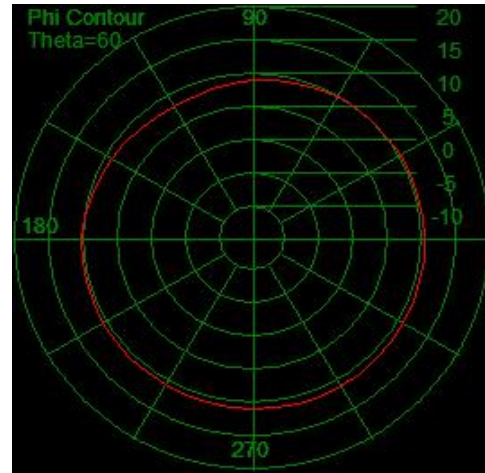
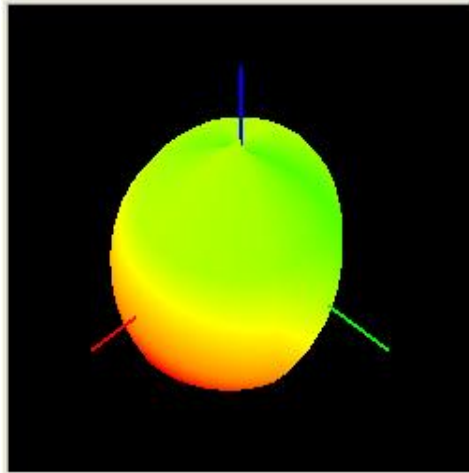

## 2. 4G-WIFI/BT 2400-2500MHz波形图

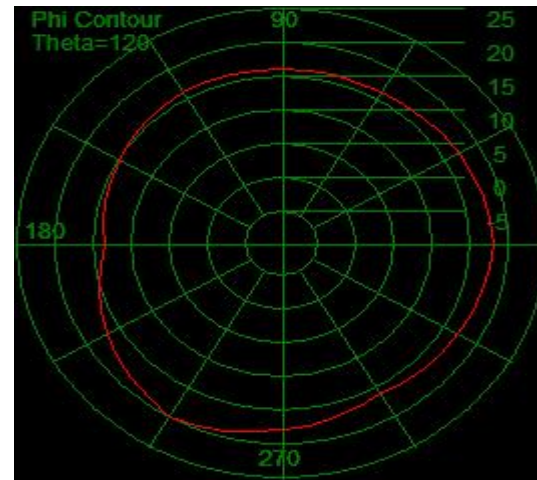
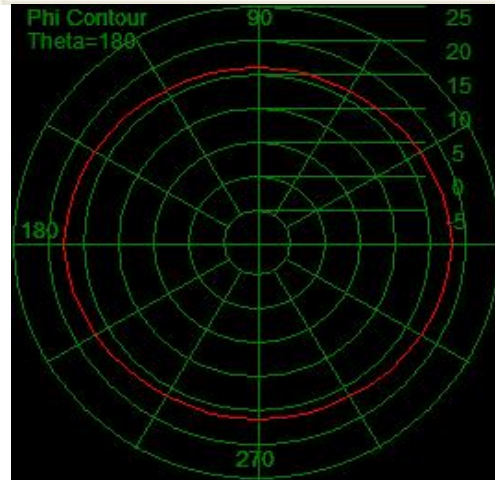
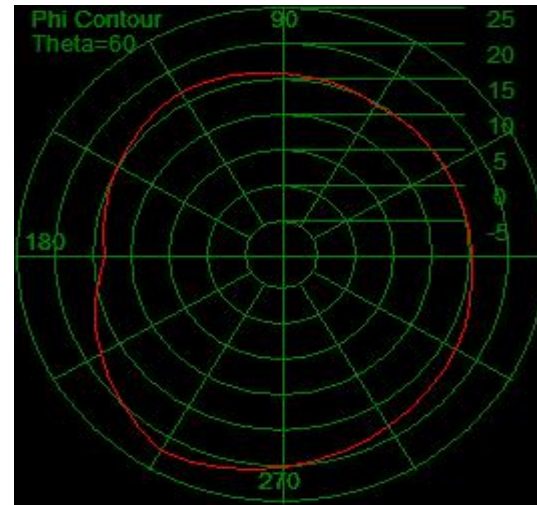
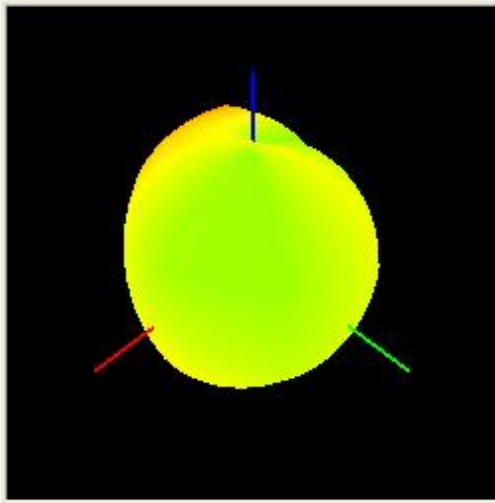



# 5G-WIFI/BT 5150-5850MHz波形图

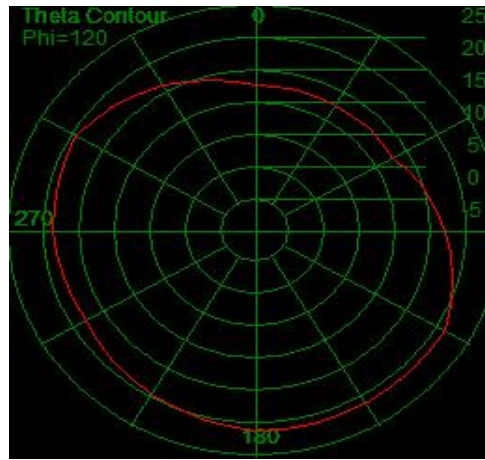
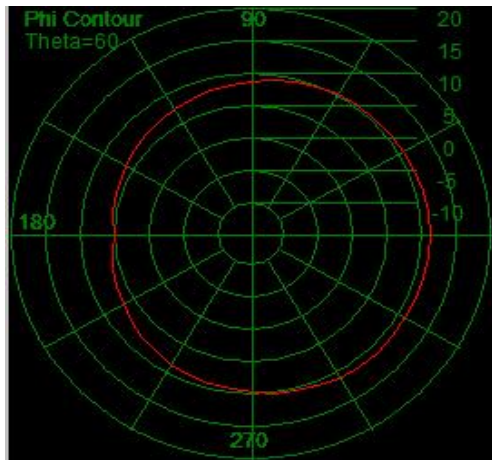
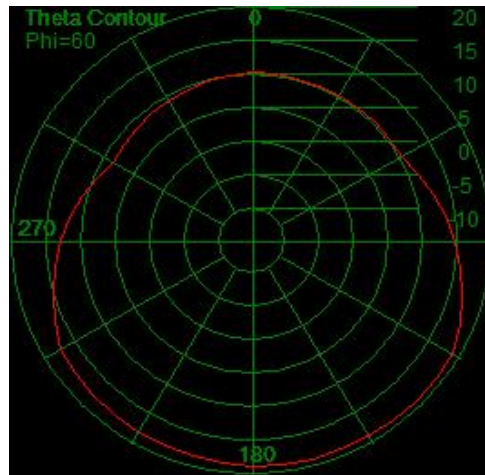
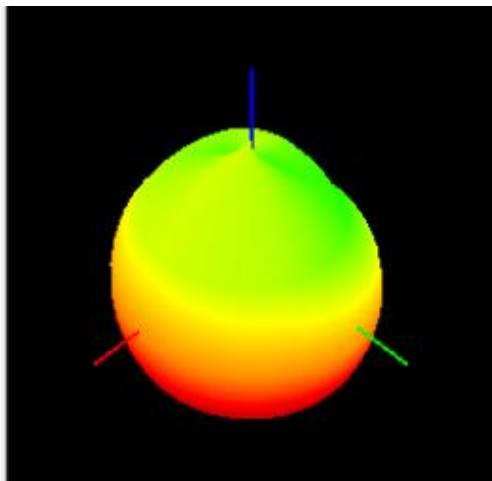

# GPS 1575.42MHz波形图

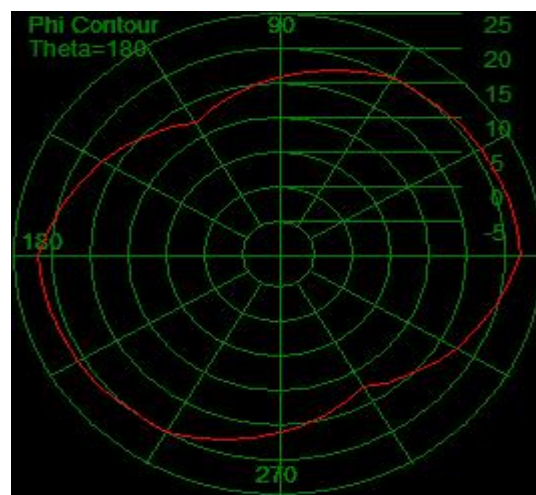
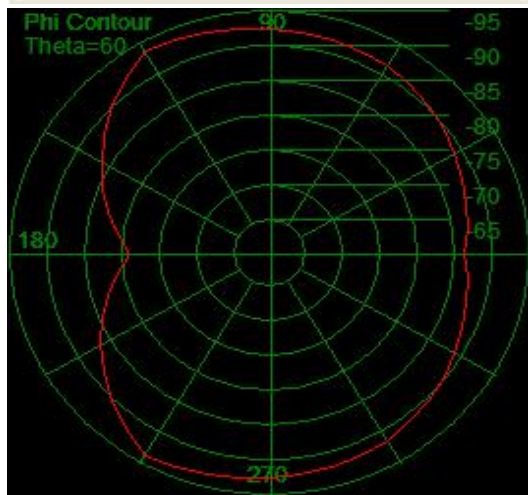
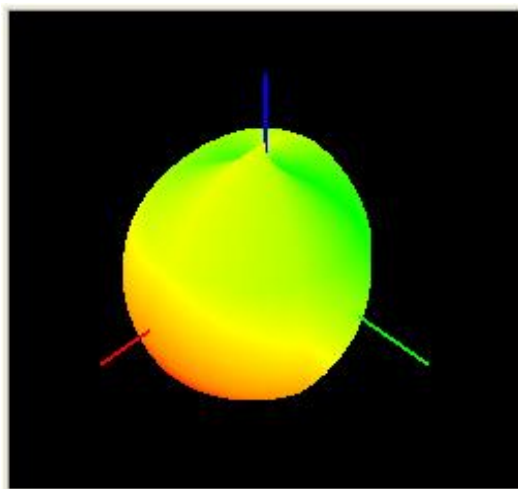

# Introduction to Antenna Information

Z5563		
Antenna type and frequency band	MAIN ANTENNA (PIFA)	2G/3G/4G
	DIV ANTENNA (PIFA)	2G/3G/4G
	GPS/WIFI/BT ANTENNA (PIFA)	L1/2. 4G. 5GWIFI/BT
Antenna materia	FPC	