

REVISED RECORD			
DATE	REV. NO.	DESCRIPTION	DATE

PMU_ANALOG

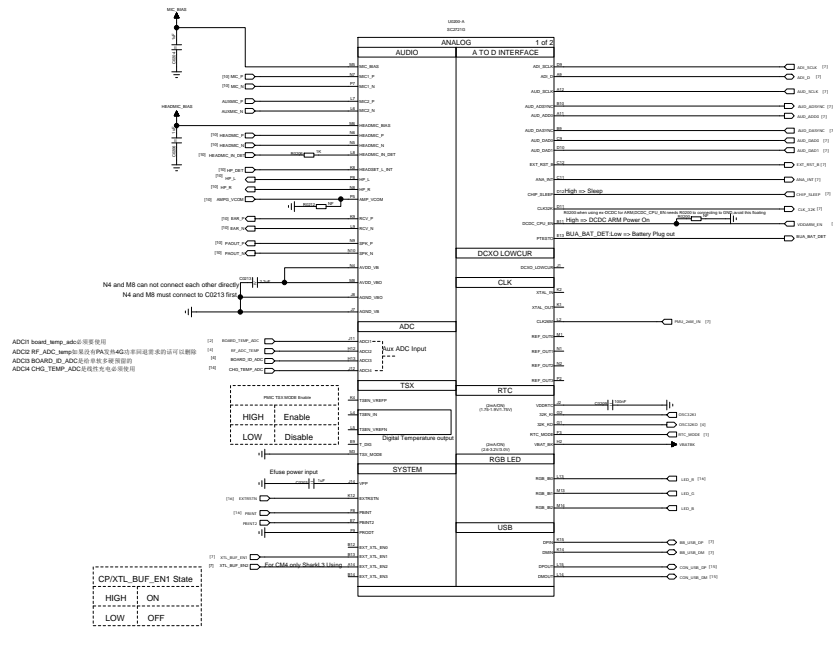

BKBT



RTC

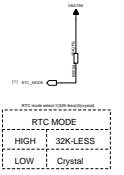

RTC Mode	Type	R0202	X0200	C0201	C0202	R0203	R0204	R0617	R0205
32K Crystal	Option	OR	Crystal	8.2pF	8.2pF	OR	NF	NF	NF
32K-less	Default	NF	NF	NF	NF	NF	10K	OR	OR

Note: 32K-less only use in DCXO&TCXO mode and TSX

TITLE & AREA		
EQUIPMENT NO.		
DESIGNER	DATE	DEPARTMENT
		Hardware DEPT.
EDA	DATE	COMPANY
		Spreadtrum communications, Inc.
APPROVED	DATE	
		CONFIDENTIAL AND PROPRIETARY

REV	DATE	APPROVAL	DATE

PMU_POWER

INPUT	Description
VBAT_AUD	VBAT power input for audio
VBAT_PA	VBAT power input for audio speaker PA
VBATA	VBAT power input for LDO
VBATR	VBAT power input for KP_LED_VIB_VBATBK_Flash_LED
VBATC	VBAT power input for LDO
VBAT_DRV	VBAT power input for DCDC

Default: VBAT R0300-SMT
 Option 1: VBAT_PA R0316/R0307-SMT

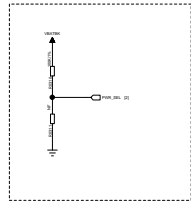
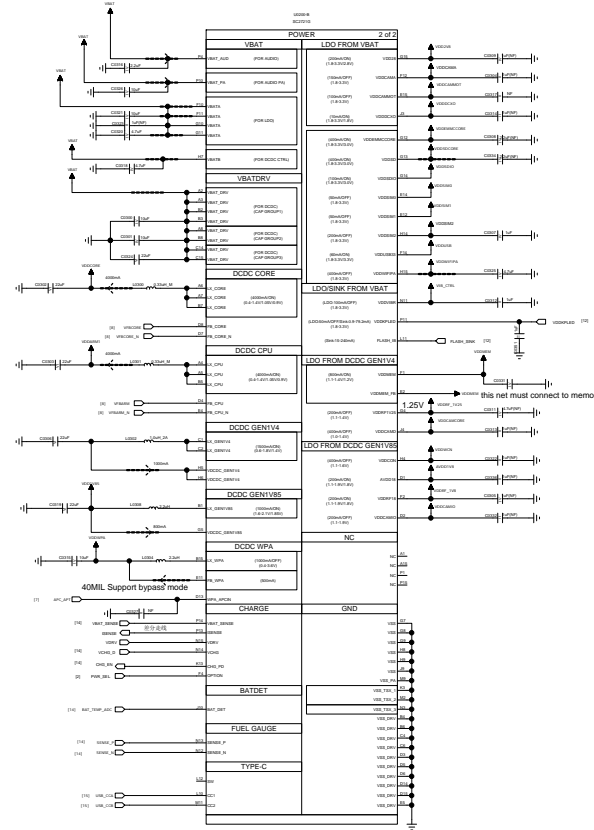
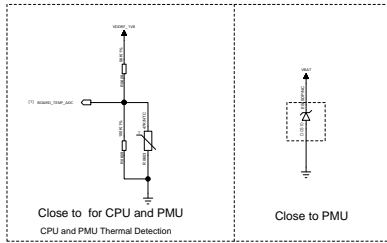

PMU_SEL	Platform	R0310	R0311	VDDARM	VDDCORE
HIGH	SharkL3	100K	NF	0.9V	0.9V/0.7V
LOW	SharkL2	NF	0ohm	1.05V	1.05V/0.8V

SC2721 DCDC output

Input Power	Power Name	Output Voltage (V)	Output Current	Default Voltage	Default
VBAT	DCDCCPU	0.4-1.4/1.05/0.9	400mA	0.9V	ON
	DCDCCORE	0.4-1.4/1.05/0.9	400mA	0.9V	ON
	DCDCMEM	1.1-1.4	800mA	1.2V	ON
	DCDCGEN1V85	1.6-2.1	1000mA	1.85V	ON
	DCDCWPA	0.4-3.6	1000mA		OFF

SC2721 LDO output

Input Power	Power Name	Output Voltage (V)	Output Current	Default Voltage	Default
LDO from VBAT	VDDCAMA	1.8-3.3	150mA	2.8V	OFF
	VDDCAMMOT	1.8-3.3	100mA	2.8V	OFF
	VDDSIM0	1.8-3.3	50mA	1.8V	OFF
	VDDSIM1	1.8-3.3	50mA	1.8V	OFF
	VDDSIM2	1.8-3.3	200mA	1.8V	OFF
	VDD28	1.8-3.3	200mA	2.8V	ON
	VDDMEMCCORE	1.8-3.3	400mA	3.0V	ON
	VDDSDCORE	1.8-3.3	400mA	3.0V	ON
	VDDSDIO	1.8-3.3	100mA	3.0V	ON
	VBATBK	2.6-3.2	2mA	3.0V	ON
	VDDVIB	1.8-3.3	100mA	3.3V	OFF
	VDDKPLED	1.8-3.3	LDO 50mA/Sink 0.9-29.2mA		
	VDDWIFIPA	1.8-3.3	400mA	3.3V	OFF
	VDDDCXO	1.8-3.3	10mA	1.8V	ON
	VDDUSB33	1.8-3.3	60mA	3.3V	ON
LDO from DCDCGEN	VDDCAMD	1.0-1.4	400mA		OFF
	VDD_CON	1.1-1.6	400mA		OFF
	VDD_MEM	1.1-1.4	800mA	1.2V	ON
	VDDCAMIO	1.1-1.9	200mA		OFF
	AVDD18	1.1-1.9	200mA	1.8V	ON
VDDRF18	1.1-1.9	200mA	1.8V	ON	
VDDRF1V25	1.1-1.4	200mA		OFF	

EXT DCDC ARM

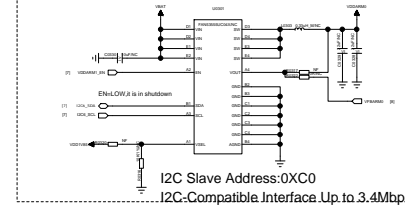

SC1893A(VDDARM) C0328-22uF C0328-22uF U0301-FANES1850-C04X C0320-10uF R0316-10K1% L0303-0.33uH M R0322-HR
 SC1893E(VDDARM) C0328-22uF C0328-22uF U0301-HC C0320-10uF R0316-10K1% L0303-0.33uH M R0322-HC

REV	DATE	DESCRIPTION

DESIGNER	DATE	Hardware DEPT.
QA	DATE	Company
APPROVED	DATE	Spreadtrum communications, Inc.

REVISION HISTORY			
DATE	DESCRIPTION	APPROVED BY	DATE

eMMC+LPDDR3

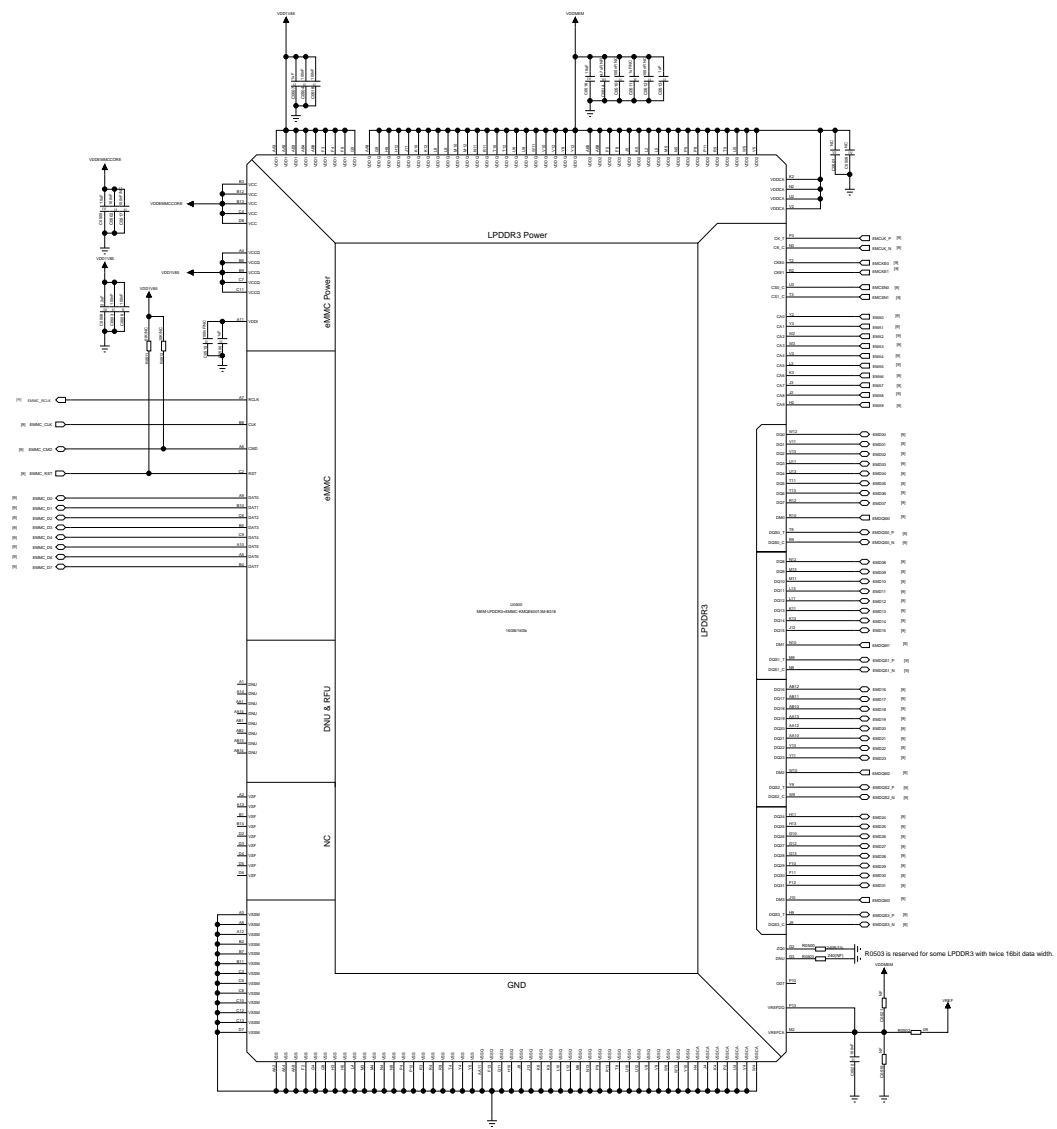

DESIGNER		DATE	APPROVED BY
DRAWN		DATE	APPROVED BY
CHECKED		DATE	APPROVED BY
APPROVED		DATE	APPROVED BY
TITLE & REV			
REQUIREMENT NO.			
DEPARTMENT			
Hardware DEPT.			
COMPANY			
Spreadtrum communications, Inc.			
CONFIDENTIAL AND PROPRIETARY			

LTE/WCDMA PAM

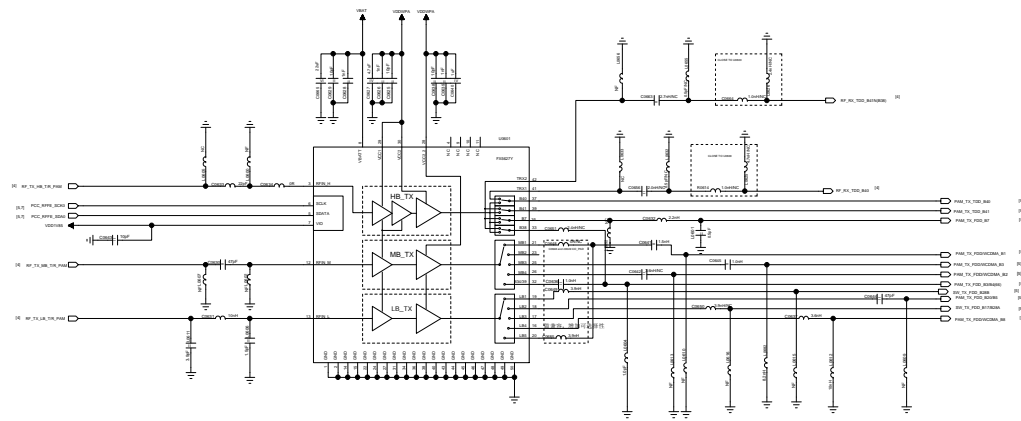

NTC

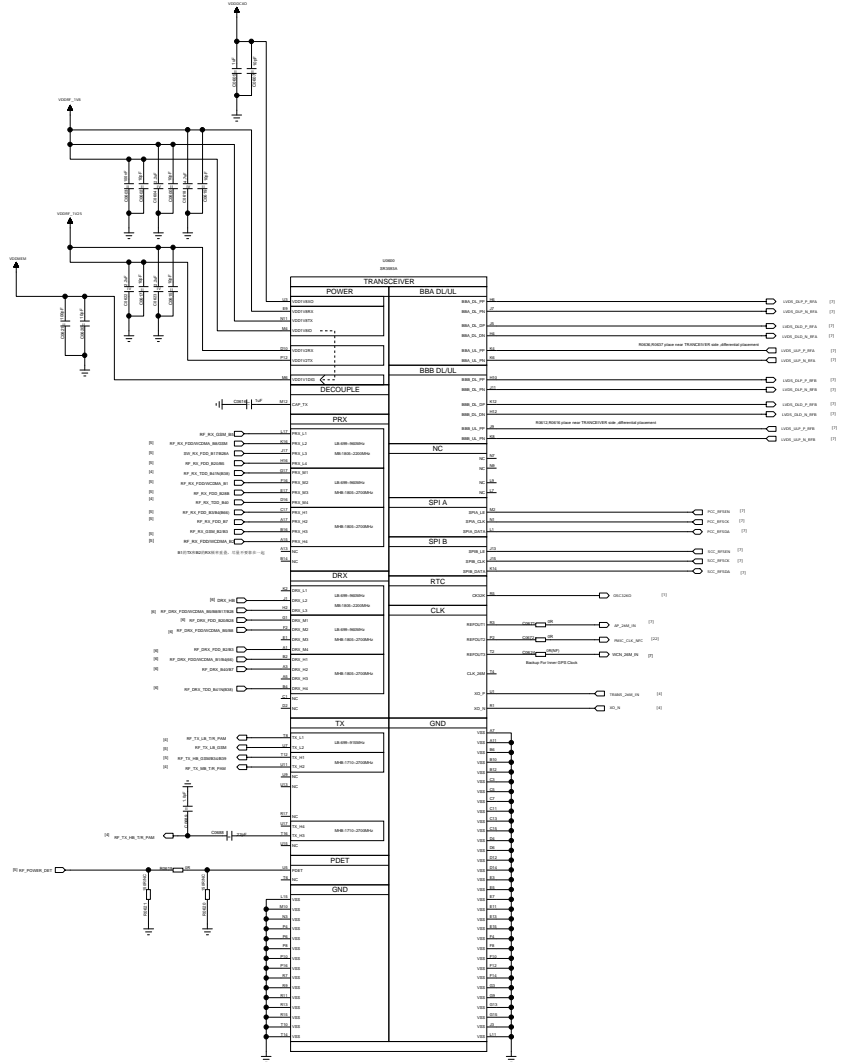
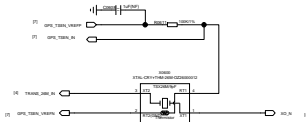
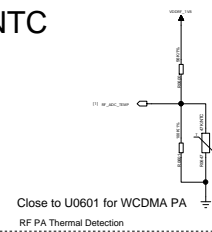

REVISION HISTORY			
REV.	REASON	APPROVAL	DATE

TITLE & REV.			
DESCRIPTION			
DESIGNER	DATE	DESIGN NO.	Hardware DEPT.
PCB	DATE	CONTRACT	Spreadtrum communications, Inc.
APPROVED	DATE	CONFIDENTIAL AND PROPRIETARY	

Primary LMB Antenna

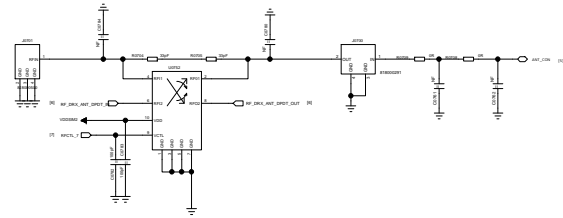

TDD B34/B39/GSM PA + Switch

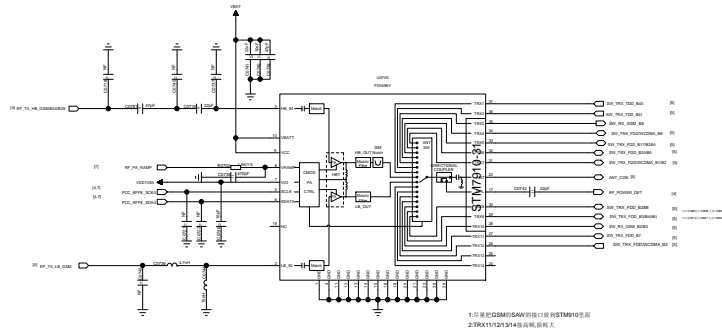

FDDLTE/WCDMA_B71

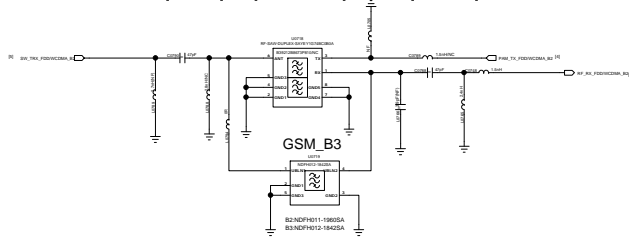
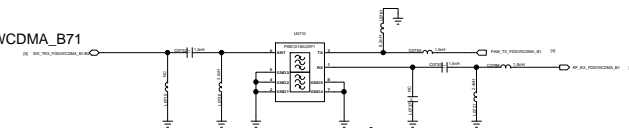

FDDLTE/WCDMA_B2

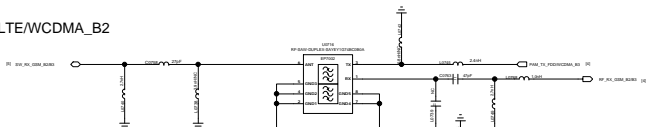

FDDLTE_B4(66)

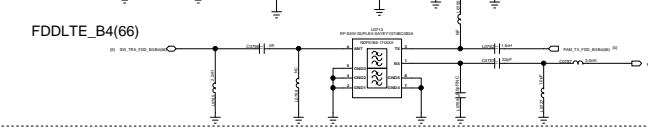

FDDLTE_B7

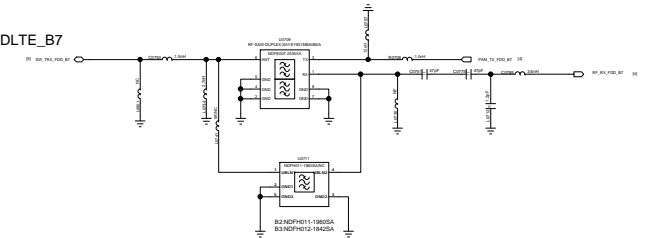

FDDLTE/WCDMA_B13

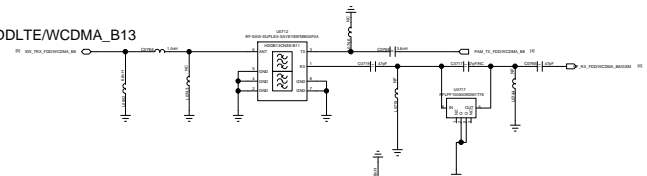

FDDLTE_B5

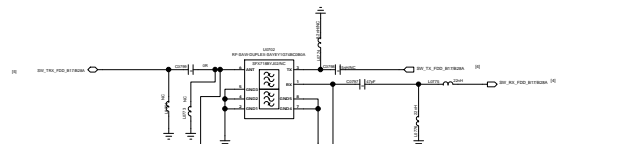
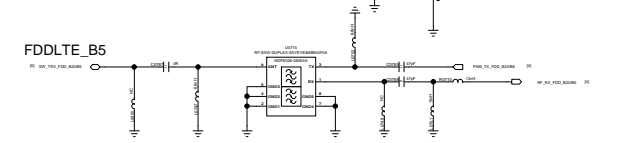

GSM_B8

FDDLTE/12/17

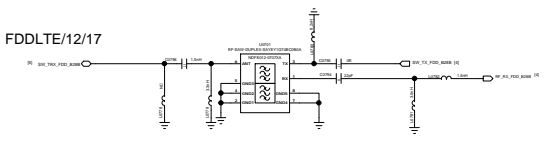

TDD_B40 TRX

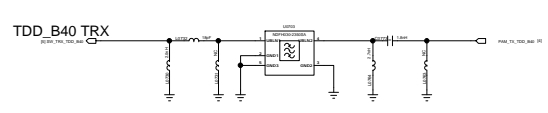

TDD_B41 TRX

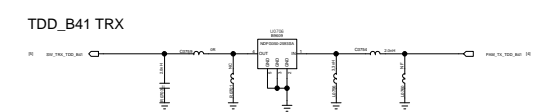

TITLE & REV			
DESCRIPTION			
DESIGNER	DATE	DEPT	Hardware DEPT.
CHK	DATE	COMPANY	Spreadtrum communications, Inc.
APPROVED	DATE	CONFIDENTIAL AND PROPRIETARY	

APPROVAL RECORD			
DATE	BY	APPROVAL	DATE

Diversity LTE LMB Path

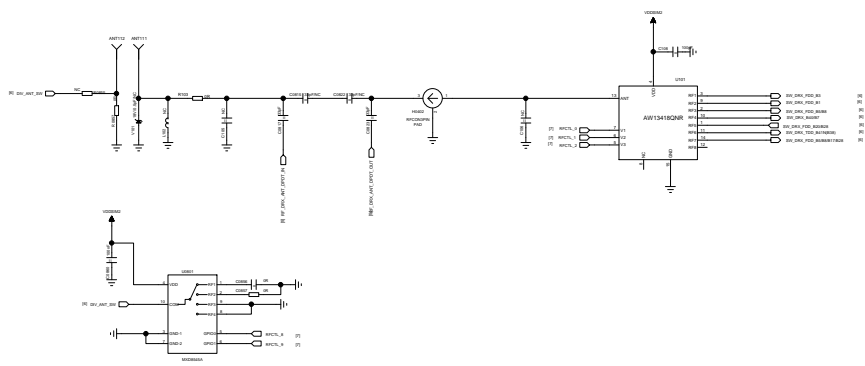

M Band Diversity RX Path

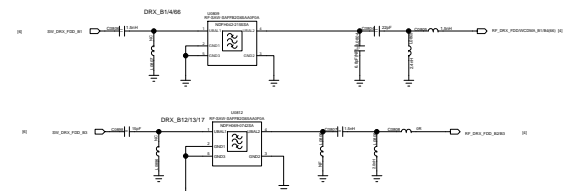

L Band Diversity RX Path

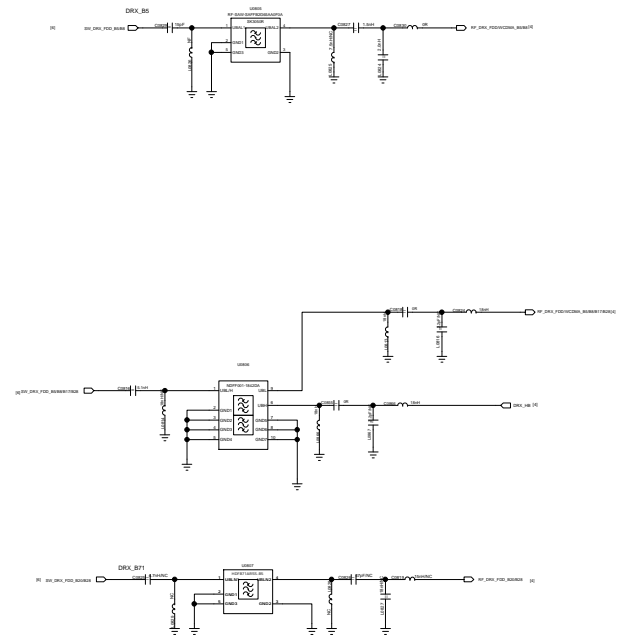

H Band Diversity RX Path

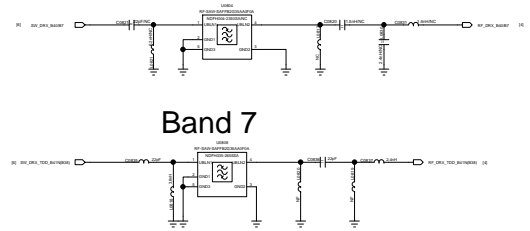

Band 7

TITLE & REV			
DESCRIPTION REV			
DESIGNER	DATE	DESIGN NAME	Hardware DEPT.
EDA	DATE	COMPANY	Spreadtrum communications, Inc.
APPROVED	DATE	CONFIDENTIAL AND PROPRIETARY	

REV	REVNO	APPNO	DATE

DIGITAL

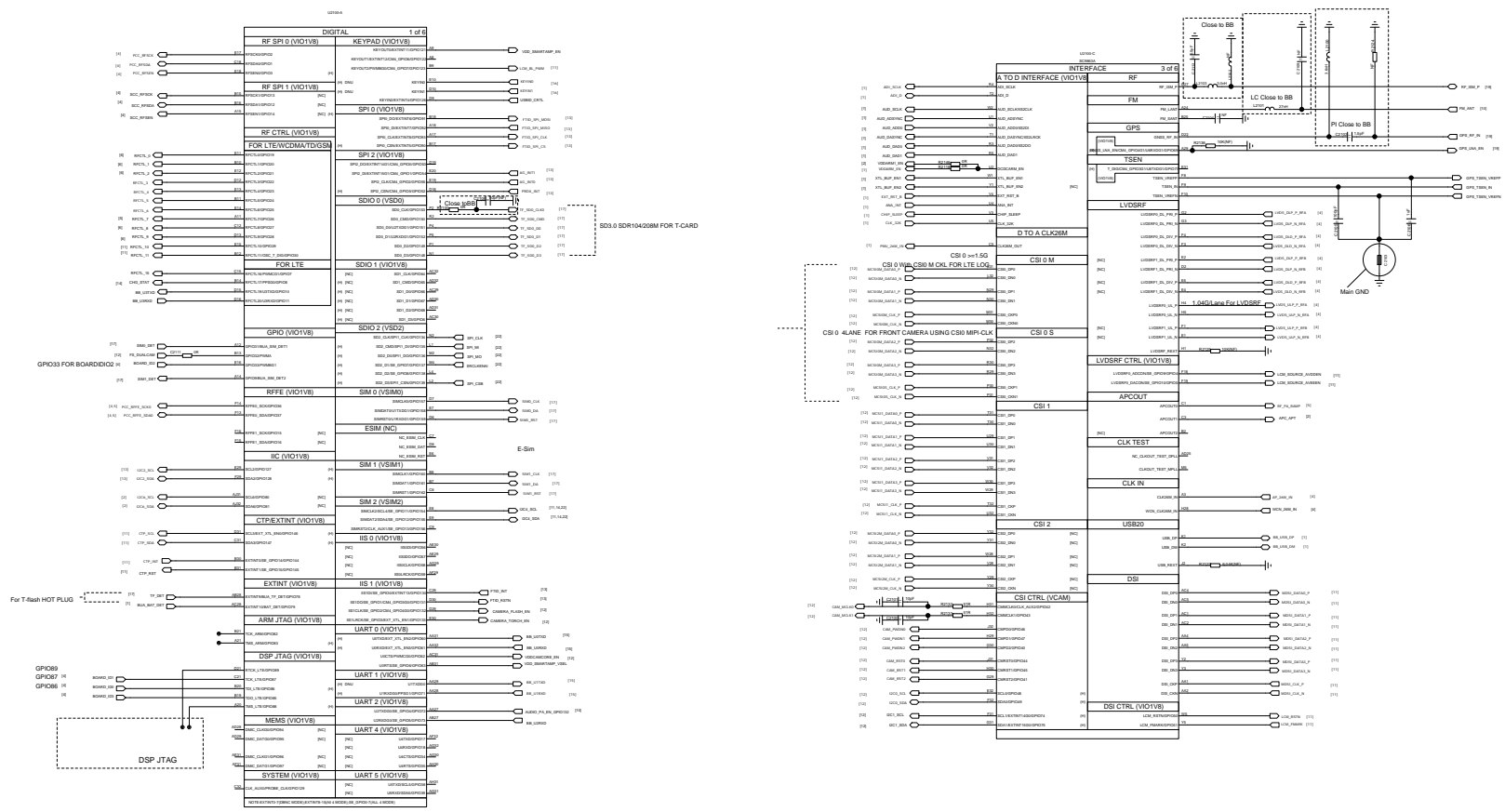

REVNO	REVNO	APPNO	DATE

Hardware DEPT.
Spreadtrum communications, Inc.

REVISION HISTORY			
DATE	BY	DESCRIPTION	DATE

POWER

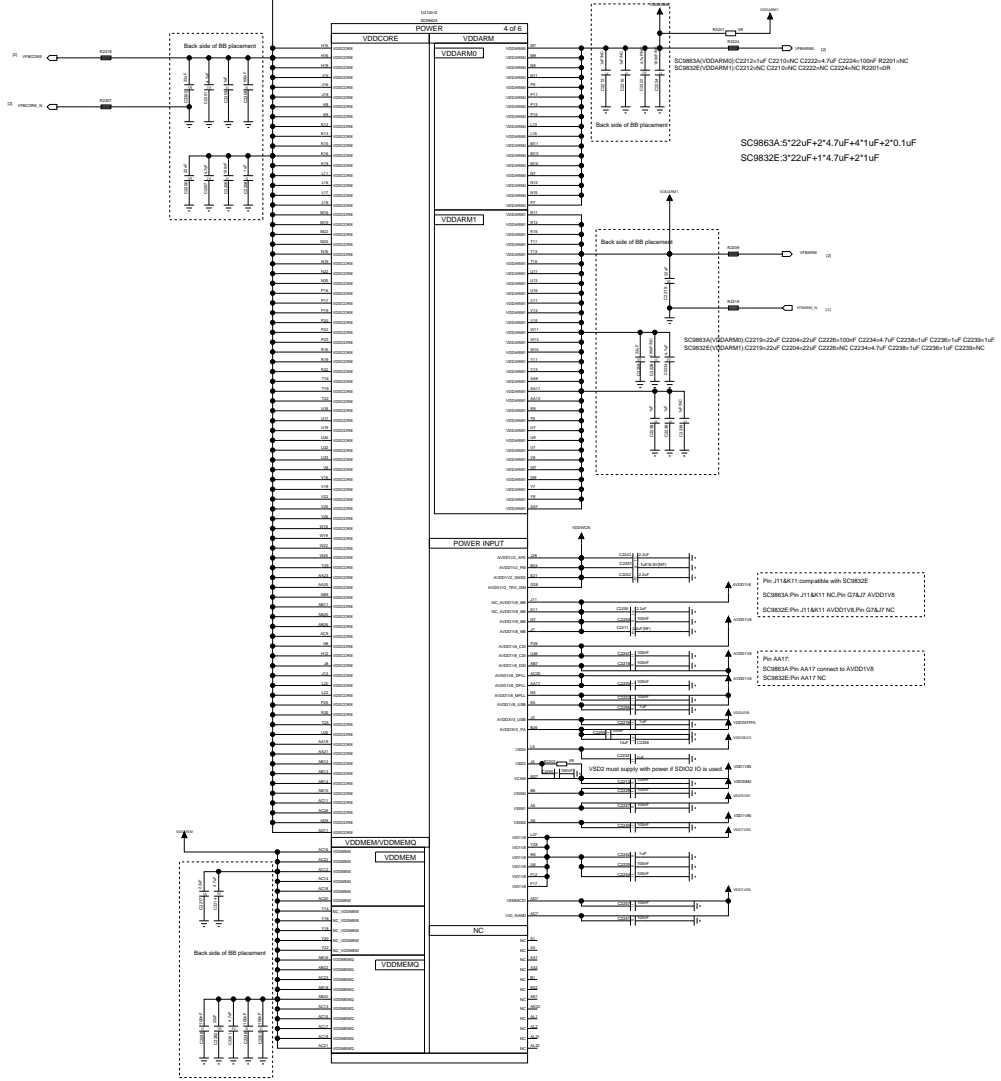

GND

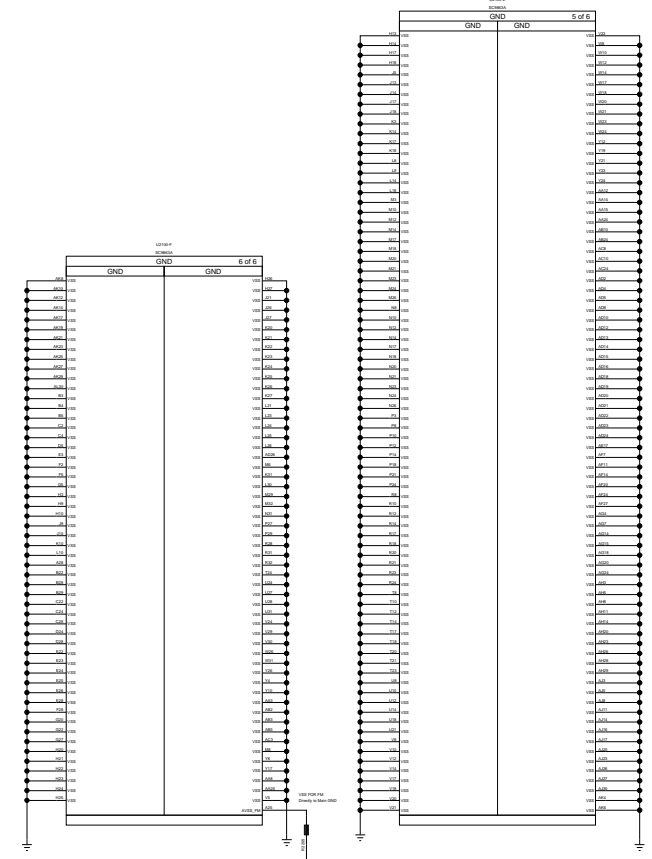

REVISION HISTORY			
DATE	DESCRIPTION	APPROVED BY	DATE

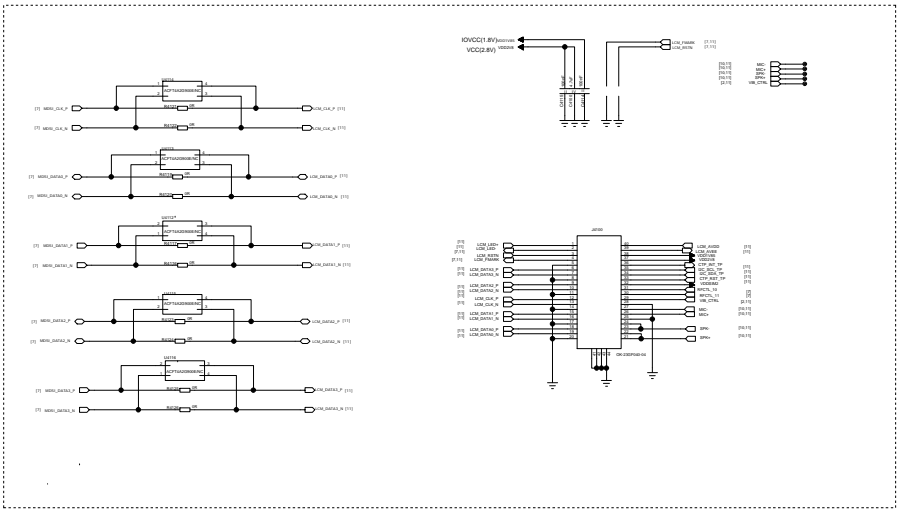

REVISION HISTORY			
DATE	REASON	APPROVAL	DATE

Rear Dual Camera 0:13M

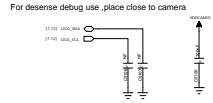
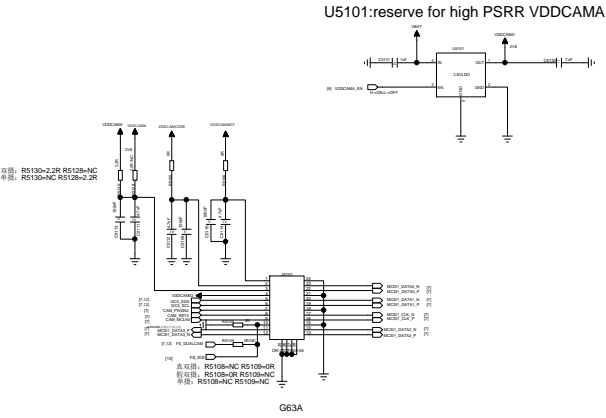

Rear Daul Camera

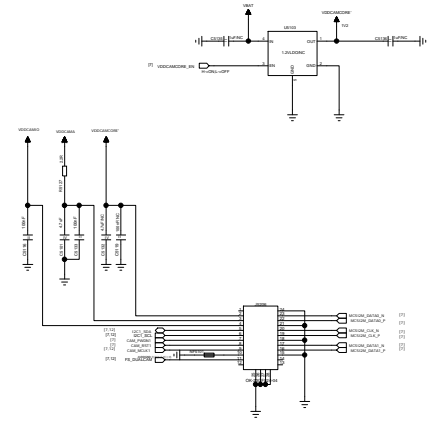

Front Camera 2:16M

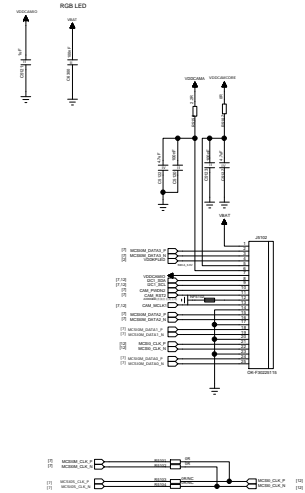

FLASH LED_BACK

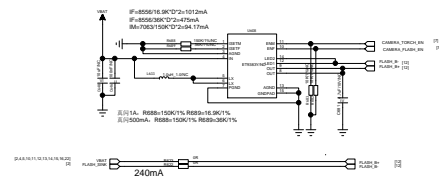

BACK LED

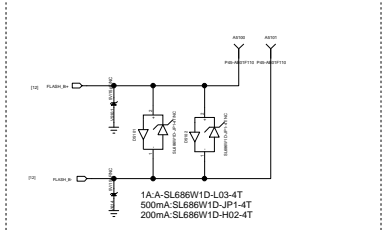

Front LED

Accelerometer

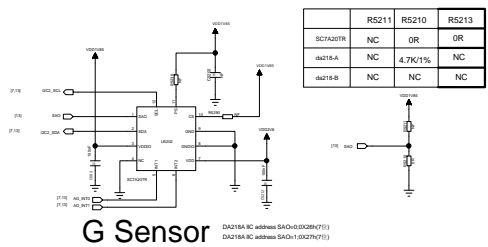

G Sensor

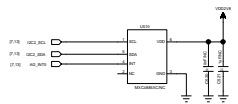

ALS & PROX

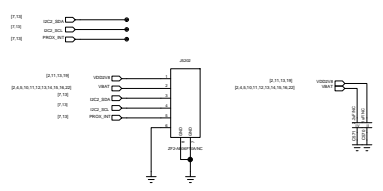

	LTR-553ALS-WA
SIZE	3.94 x 2.38 x 1.35
1	SDA
2	INT
3	LDR
4	LED K
5	LED A
6	GND
7	SCL
8	VDD
9	VDD

Accelerometer&GYRO: ICM-20600

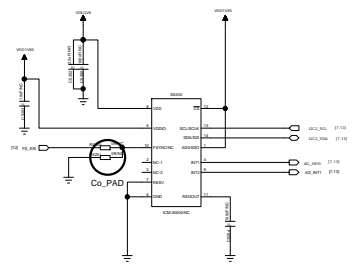

Magnetic Sensor:AK09911C

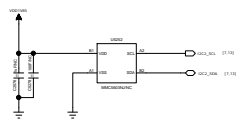

IIC address: 0x30 (7位)

Pin	Definition
VDD	2.4V - 3.6V
VID	1.65V - VDD
CAD	Address select Note : connect to VDD,not VID

FingerPrint ID

NOTE:FPC=LAYOUT LINE<10MM
(BACKUP)

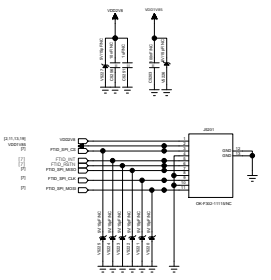

I2C ADDRESS

	Manufacturer	MPN	Address
A sensor	BOSONH	BM4255	0b0011001 (SDCA=1)
M sensor	ASAHIKASEI	AK09911	0b0001101 (CAD=1)
ALS & PROX	LITEON	LTR-553ALS-WA	0b100011
A&G Sensor	InvenSense	ICM-20600	SA0=0.0b11010000 SA1=0.0b11010001
M sensor	AKM	AK09918C	0b0001100 (R-W)

TITLE & REV.		
REVISION HISTORY		
DESIGNER	DATE	DESCRIPTION
EDA	DATE	Hardware DEPT.
APPROVED	DATE	Spreadtrum communications, Inc.
CONFIDENTIAL AND PROPRIETARY		

Revision History			
CR	Rev No.	Entered	By

5pin Micro USB

USB BOOT CONTROL
 NBOOT = Float---->NAND BOOT
 NBOOT = 0 ---->USB BOOT
 PBINT2 is only for auto power on.

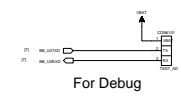
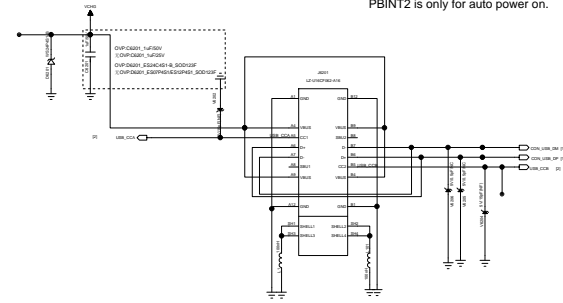

OVP

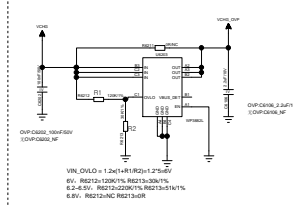

UART POINT



MARK POINT



SharkLE strapping pin

Ball name	Signal name in boot code	Value	Description	Default value
U1TXD	USB_DOWNLOAD_EN	0	USB download enable (time out)	1(=1,wp0)
AUD_DAD1	ARM_BOOT_MD0	000	Reserved	
		001	TIC/NAND Toggle	
AUD_DADD	ARM_BOOT_MD1	010	MLC/SLC NAND Flash(ON)	11(=1,wp0)
		011	SLC boot (no time out)	
		100	MLC/SLC NAND Flash(Toggle)	(MSB=02)
		101	no NAND/Flash/ROM/EEPROM	(LSB=03)
AD1_SCLK	ARM_BOOT_MD2	110	Reserved	
		111	MMC boot	

Title & Rev.		
Description		
DESIGNER	DATE	DEPARTMENT
		Hardware DEPT.
DATA	DATE	COMPANY
		Spreadtrum communications, Inc.
APPROVED	DATE	

Revision History			
CR	REV	DESCRIPTION	DATE

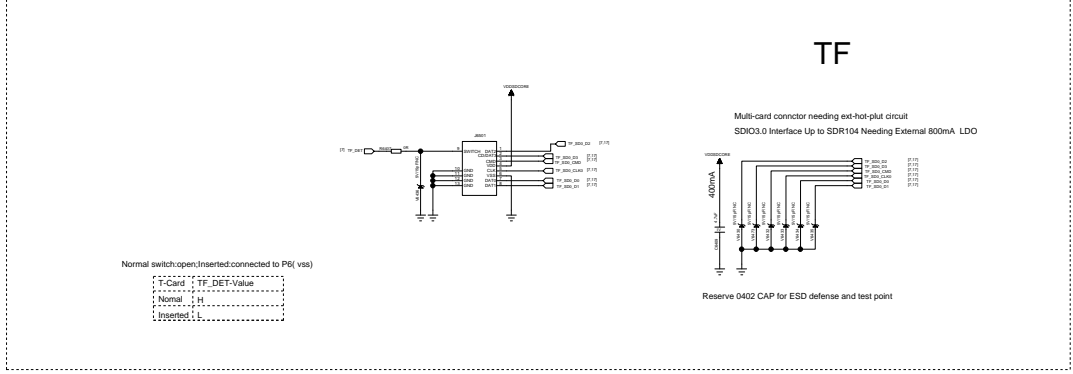
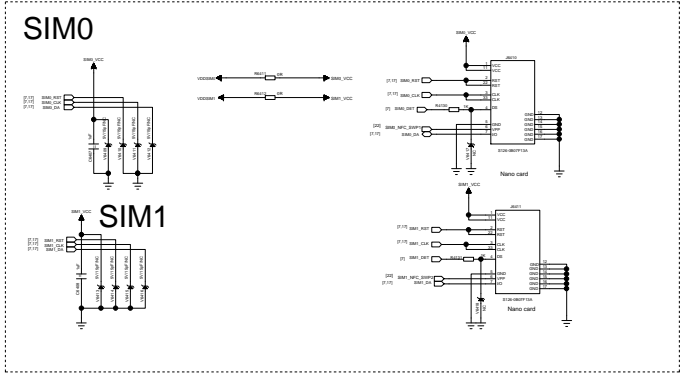

Title & Rev			
Equipment No.			
DESIGNER	DATE	APPROVED	Hardware DEPT.
DATA	DATE	DATE	Spreadtrum communications, Inc.
APPROVED	DATE	DATE	CONFIDENTIAL AND PROPRIETARY

6

5

4

3

2

1

REVISION RECORD			
DATE	DESCRIPTION	APPROVED BY	DATE

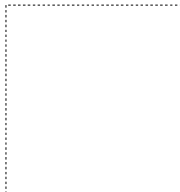

D

D

C

C

B

B

A

A

TITLE & REV.		REVISIONS:	
DESIGNED BY:	DATE:	APPROVED BY:	DATE:
		Hardware DEPT.	
		Spreadtrum communications, Inc.	
		CONFIDENTIAL AND PROPRIETARY	

APPROVAL RECORD			
CHK	DATE	APPROVED BY	DATE

Audio_SUB

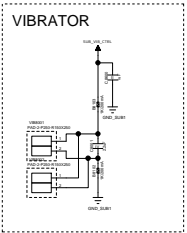
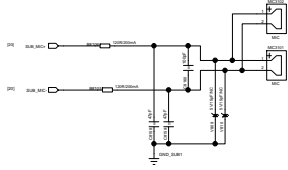
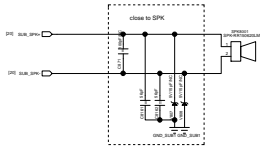
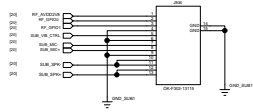

ANT_SUB

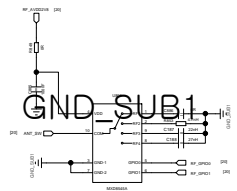
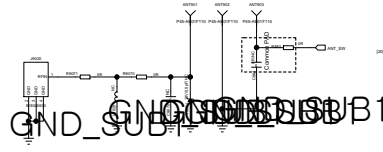

DESIGNER		DATE		APPROVED BY		DATE	

TITLE & REV.			
EQUIPMENT NO.			
DESIGNER	DATE	APPROVED BY	DATE
Hardware DEPT.			
Company			
Spreadtrum communications, Inc.			
CONFIDENTIAL AND PROPRIETARY			

REVISION RECORD			
LINE	DESCRIPTION	DATE	BY

ANT_SUB

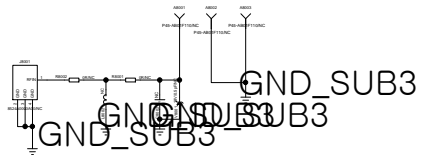

DATE:		DATE:		DATE:		DATE:		DATE:	
DESIGNED:		DATE:		CODE:		REV:		DRAWING NO.	
QUALITY CONTROL:		DATE:		A0		REV:		DRAWING NO.	
RELEASED:		DATE:		SCALE:		SHEET		22	

REVISION HISTORY			
LINE	REV. NO.	APPROVED	DATE

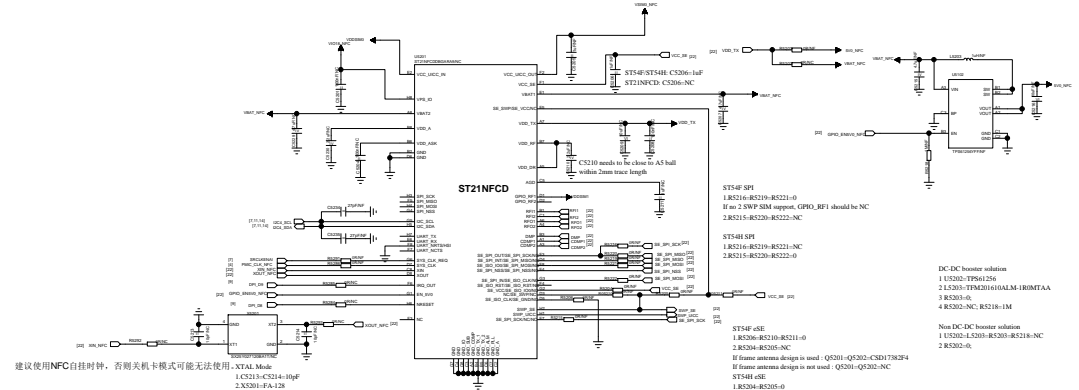

建议使用NFC自挂时钟，否则关机卡模式可能无法使用。ATX14. Mode: 1 CS213-CS214-10uF 2 X5201-FA128 3 R5206-R5201-NC

As for co-lock mode, if customers need to pass CT NFC certification, recommended to increase NFC antenna size > 150mm² to ensure enough PCB distance margin.

Co-Check Mode: 1 CS213-CS214-X5201-NC 2 R5206-R5201-0 ohm

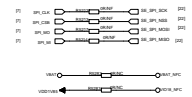

SE ball name definition for ST54F, ST54H, and ST21NFC, respectively

Ball	ST21NFC	ST54F	ST54H
D3	NC	SE_SWP	NC
D4	NC	SE_SPI_MISO	SE_SPI_INT
D5	NC	SE_GND	SE_ISO_CLK
E3	NC	SE_SPI_SCK	SE_SPI_OUT(MISO)
E4	NC	SE_SPI_NSS	SE_SPI_NSS
E5	NC	SE_VCC	SE_SWP
E7	NC	NC	SE_SPI_SCK
E8	NC	SE_SPI_MOSI	SE_ISO_IO0
F4	NC	SE_ISO_RST	SE_ISO_RST
Q2	NC	SE_ISO_IO0	SE_VCC
Q3	NC	SE_ISO_CLK	SE_SPI_IN(MOSI)

ST54F SPI
1 R5216-R5219-R5221-0
If use 2 SWP SIM support, QW03_BF1 should be NC
2 R5215-R5220-R5222-NC

ST54H SPI
1 R5216-R5219-R5221-NC
2 R5215-R5220-R5222-0

DC-DC booster solution
1 U3202-TPS61256
2 L3203-TPM21016(0ALM1R0MTAA)
3 R5201-0
4 R5202-NC; R5218-1M

Non DC-DC booster solution
1 U3202-L3209-R5201-R5218-NC
2 R5202-0

ST54F eSE
1 R5206-R5210-R5211-0
2 R5204-R5205-NC
If frame antenna design is used - Q5201-Q5202-CSD1782F4
If frame antenna design is not used - Q5201-Q5202-NC

ST54H eSE
1 R5204-R5205-0
2 R5206-R5210-R5211-NC

ST21NFC
1 R5204-R5205-R5206-R5210-R5211-NC

Recommended NFC antenna spec, below
1. L @ 13.56MHz is 0.2uH ± 0.6uH
2. Freq. ant > 10MHz
R5209 is damping resistor. The purpose of R5209 is to get network Q=15
3. Antenna Q=20
4. Antenna turns 2-6 turns

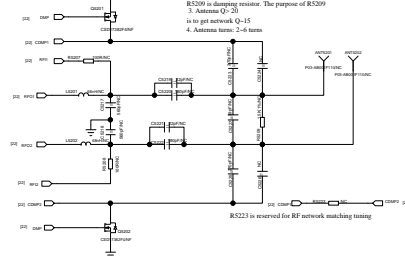

- 1. ST21NFC - 1 SWP SIM Only
- 1 R5212-R5223-0 ohm
- 2 Q5201-Q5202-Q5203-NC
- 3 R5201-R5202-R5203-R5204-R5205-R5206-R5221-NC
- 2. ST21NFC - 2 SWP SIM
- 1 Q5201-CSD1782F4-Q5202-Q5203-CSD1782F4
- 2 R5204-R5205-1M; R5206-1K; R5201-R5202-R5203-R5221-R5222-0 ohm
- 3. ST54F - 1 SWP SIM + 1 SWP eSE
- 1 R5212-R5223-0 ohm
- 2 R5201-R5202-R5203-R5204-R5205-R5206-R5221-NC; Q5201-Q5202-Q5203-NC

