

SHENZHEN DEWEIMA COMMUNICATION EQUIPMENT CO. , LTD

Antenna Report

Date:**2023. 08. 22**

Test Equipment

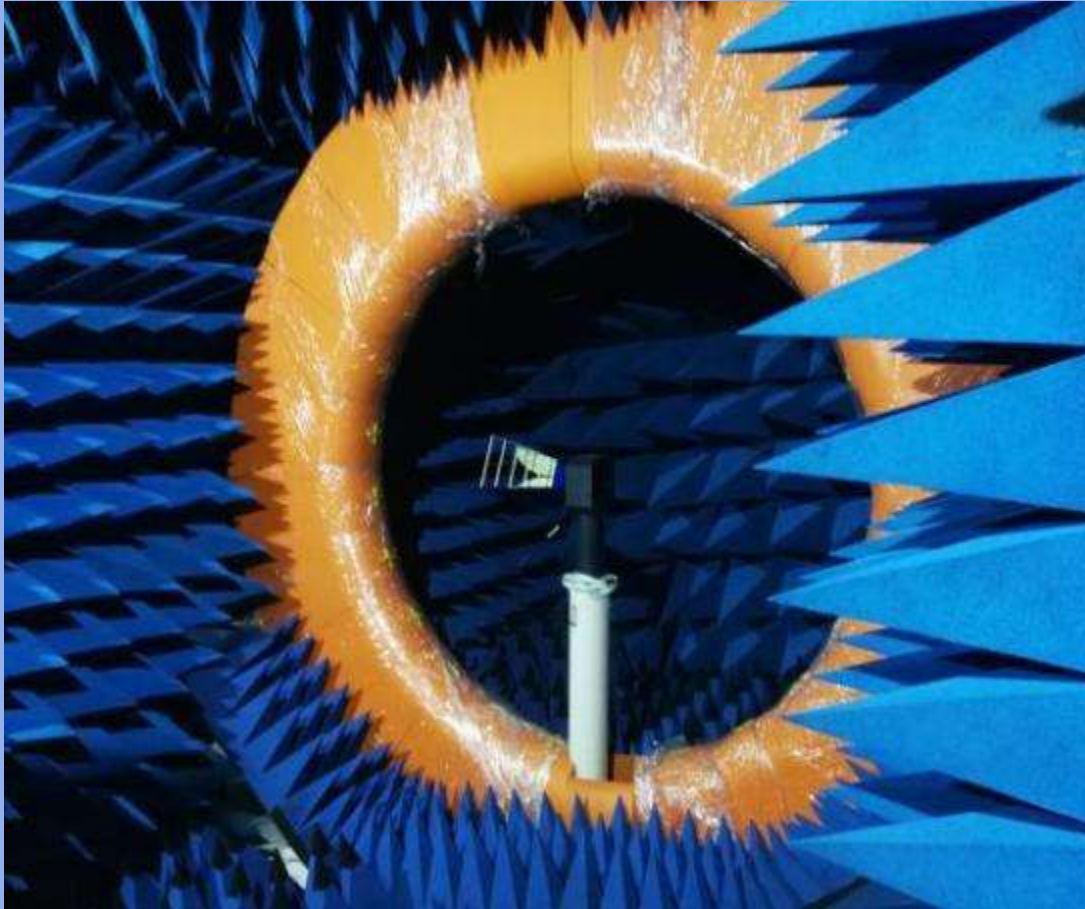

A 24-probe microwave chamber



R&S CMW500

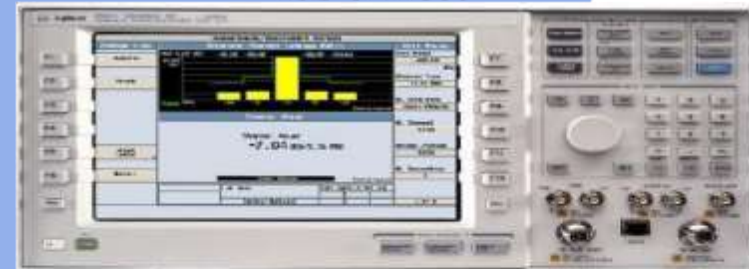

Agilent E5515C



Agilent Technologies E5071B

Antenna Switch and Matching Circuit

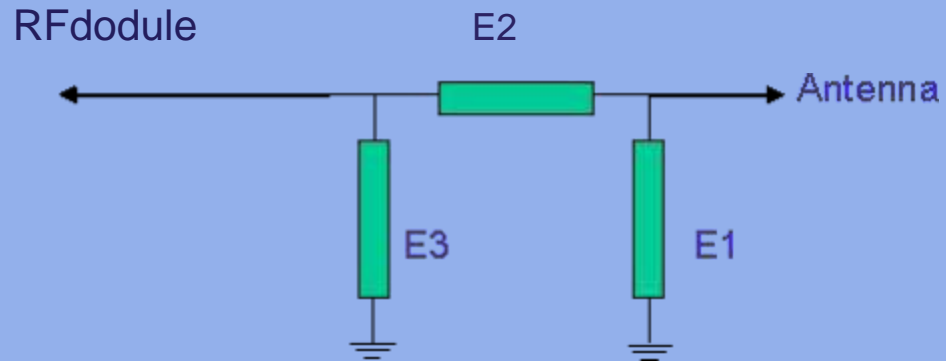

Element	Value
E1(0201)	NC
E2(0201)	0Ω
E3(0201)	NC

Project information

1

Custom: SwellPro Technology Co., Ltd

2

Project:ANT-5.8GHz SRD(aircraft)

3

Frequency Band:5150MHz~5850MHz

4

Antenna model:D424-0009-2

V_{swr}/Loss

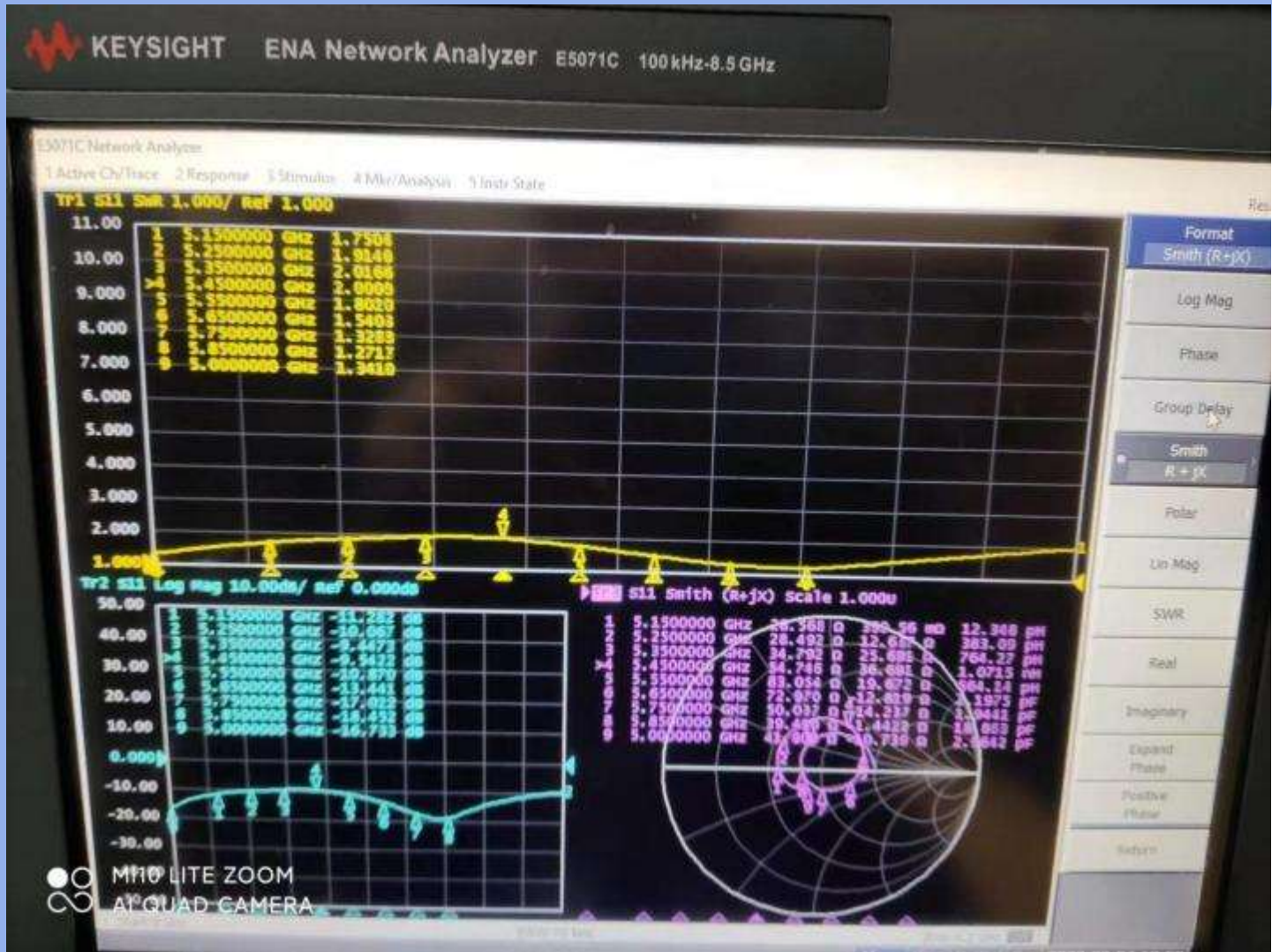

MP10 LITE ZOOM
AT QUAD CAMERA

Efficiency/Gain

Frequency/MHz	Efficiency / %	MaxGain/dBi
5150	66.22	1.9
5200	65.11	2.22
5250	70.35	1.93
5300	69.43	1.98
5350	69.62	2.16
5400	65.75	2.25
5450	62.22	2.31
5500	64.14	2.47
5550	70.72	2.2
5600	67.31	2.41
5650	71.85	1.97
5700	68.33	2.03
5750	70.54	1.85
5800	67.5	2.23
5850	71.1	1.76

3D Drawing

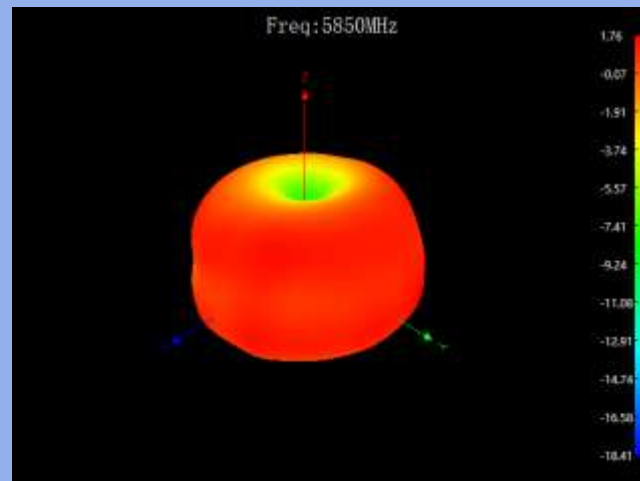
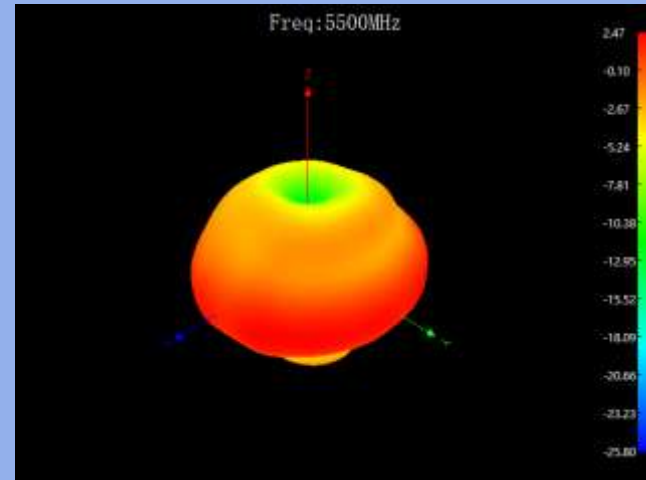
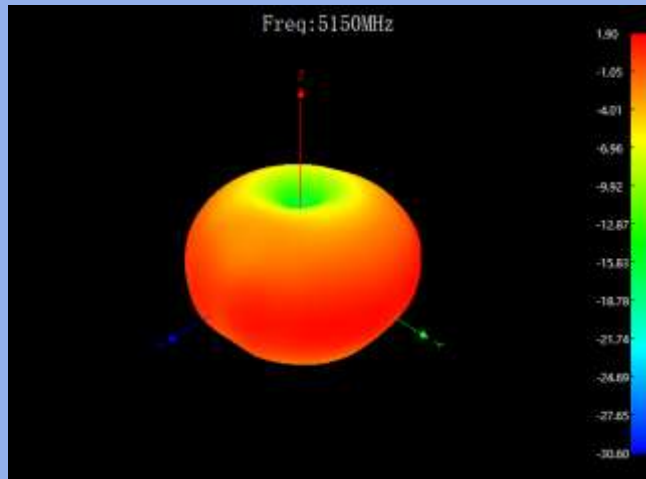

AntennaSize (mm)

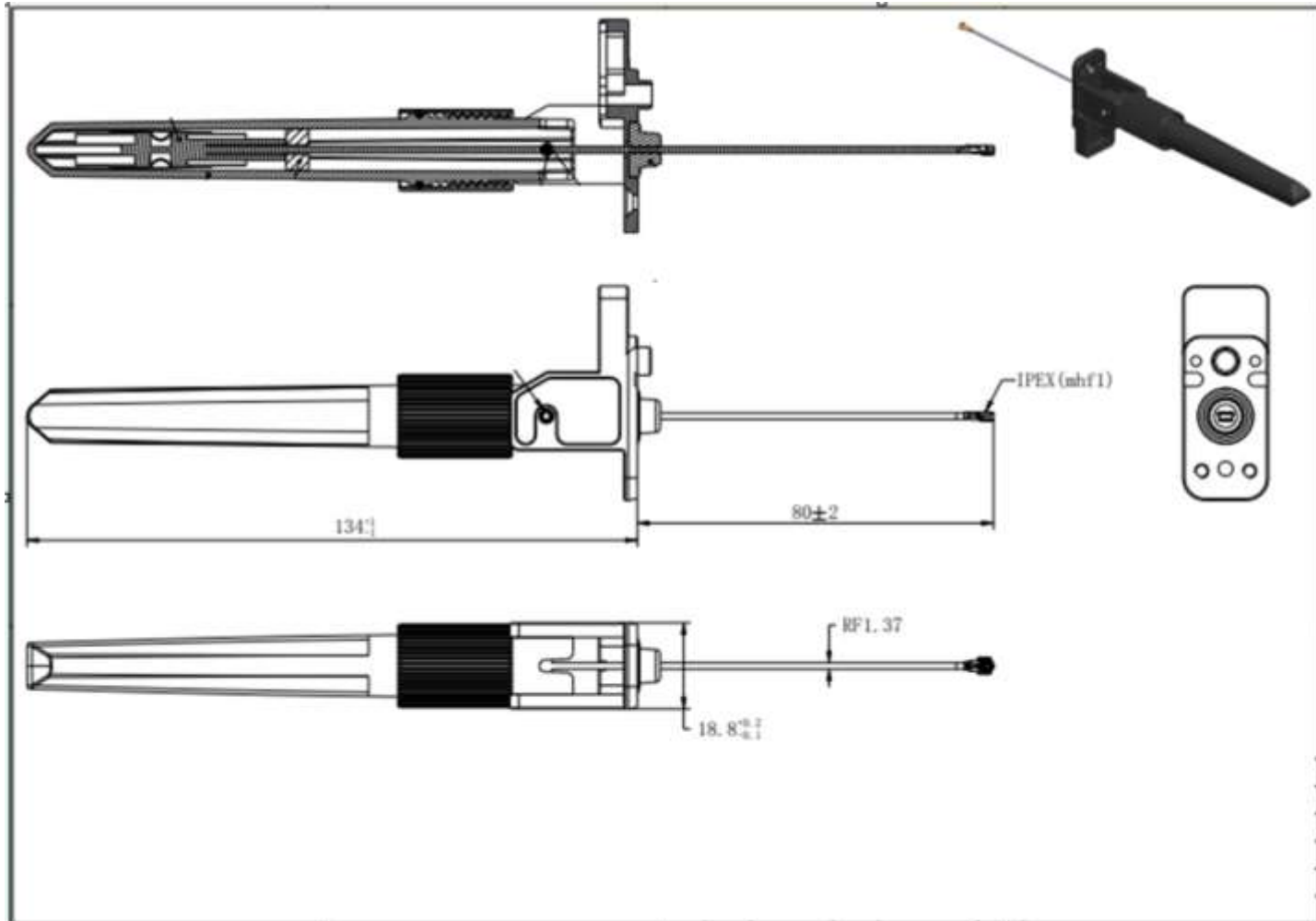



Thank You !

manufacturer: Shenzhen Deweima Communication Equipment
CO.,Ltd

Address: Floor 3, 1# youyi Building , Chuangye Road 2, Part
23, Baoan, Shenzhen, China