

Test Report

FCC ID:2AQRI-YF-021H

Date of issue: Aug. 29, 2018

Report Number:	MTi180806E019
Sample Description:	Android AD Player
Model(s):	YF-021H
Applicant:	Shenzhen Young-Feel Electronic Technology Co., LTD
Address:	6 Floor D, No.575 GuanHongTai Industrial Building, GuShu 1st Road, XiXiang Town, Baoan District, Shenzhen, GuangDong, China
Date of Test:	June 26, 2018 to Aug. 29, 2018

Shenzhen Microtest Co., Ltd.
<http://www.mtitest.com>

This test report is valid for the tested samples only. It cannot be reproduced except in full without prior written consent of Shenzhen Microtest Co., Ltd.

Tel:(86-755)88850135

Fax: (86-755) 88850136

Web: <http://www.mtitest.com>

E-mail: mti@51mti.com

Address: No.102A & 302A, East Block, Hengfang Industrial Park, Xingye Road, Xixiang, Bao'an District, Shenzhen, Guangdong, China

Table of Contents

1	GENERAL INFORMATION	5
1.1	DESCRIPTION OF EUT	5
1.2	OPERATION CHANNEL LIST	5
1.3	TEST CHANNEL LIST	6
1.4	ANCILLARY EQUIPMENT LIST	6
1.5	DESCRIPTION OF SUPPORT UNITS	6
2	SUMMARY OF TEST RESULTS	7
3	TEST FACILITIES AND ACCREDITATIONS	8
3.1	TEST LABORATORY	8
3.2	ENVIRONMENTAL CONDITIONS	8
3.3	MEASUREMENT UNCERTAINTY	8
3.4	TEST SOFTWARE	8
4	EQUIPMENT LIST	9
5	TEST RESULT	10
5.1	ANTENNA REQUIREMENT	10
5.1.1	<i>Standard requirement</i>	10
5.1.2	<i>EUT Antenna</i>	10
5.2	PEAK OUTPUT POWER	11
5.2.1	<i>Limit</i>	11
5.2.2	<i>Test setup</i>	11
5.2.3	<i>Test procedure</i>	11
5.2.4	<i>Test results</i>	11
5.3	CONDUCTED EMISSION	15
5.3.1	<i>Limits</i>	15
5.3.2	<i>Test setup</i>	15
5.3.3	<i>Test procedure</i>	16
5.3.4	<i>Test results</i>	16
5.4	RADIATED SPURIOUS EMISSION	21
5.4.1	<i>Limits</i>	21
5.4.2	<i>Test setup</i>	22
5.4.3	<i>Test procedure</i>	23
5.4.4	<i>Test results</i>	24
5.4.4.1	<i>Radiation emission</i>	24
5.4.4.2	<i>Band edge – radiated</i>	28
5.4.4.3	<i>Spurious Emission in Restricted Band 3260MMHz-18000MHz</i>	29
5.5	20dB OCCUPIED CHANNEL BANDWIDTH	30
5.5.1	<i>Limit</i>	30
5.5.2	<i>Test setup</i>	30
5.5.3	<i>Test procedure</i>	30
5.5.4	<i>Test results</i>	30
5.6	CARRIER FREQUENCY SEPARATION	37
5.6.1	<i>Limit</i>	37
5.6.2	<i>Test setup</i>	37
5.6.3	<i>Test procedure</i>	37
5.6.4	<i>Test results</i>	37
5.7	DWELL TIME	45
5.7.1	<i>Limit</i>	45
5.7.2	<i>Test setup</i>	45
5.7.3	<i>Test procedure</i>	45
5.7.4	<i>Test results</i>	45

5.8	CONDUCTED SPURIOUS EMISSION AND BANDEDGE	50
5.8.1	<i>Limit</i>	50
5.8.2	<i>Test setup</i>	50
5.8.3	<i>Test procedure</i>	50
5.8.4	<i>Test results</i>	50
PHOTOGRAPHS OF THE TEST SETUP.....		57
PHOTOGRAPHS OF THE EUT.....		59

TEST REPORT

Applicant's name: Shenzhen Young-Feel Electronic Technology Co., LTD

Address: 6 Floor D, No.575 GuanHongTai Industrial Building, GuShu 1st Road, XiXiang Town, Baoan District, Shenzhen, GuangDong, China

Manufacture's name: Shenzhen Young-Feel Electronic Technology Co., LTD

Address: 6 Floor D, No.575 GuanHongTai Industrial Building, GuShu 1st Road, XiXiang Town, Baoan District, Shenzhen, GuangDong, China

Product name: Android AD Player

Trademark: Young-Feel

Model name: YF-021H

Standards: FCC Part 15.247

Test Procedure: ANSI C63.10-2013
KDB 174176 D01 Line Conducted FAQ v01r01

This device described above has been tested by Shenzhen Microtest Co., Ltd. and the test results show that the equipment under test (EUT) is in compliance with the FCC requirements. And it is applicable only to the tested sample identified in the report.

Tested by:



Demi Mu

Aug. 29, 2018

Reviewed by:



Blue Zheng

Aug. 29, 2018

Approved by:



Smith Chen

Aug. 29, 2018

1 General Information

1.1 Description of EUT

Product name:	Android AD Player
Brand name:	Young-Feel
Model name:	YF-021H
Series model:	N/A
Difference in series models:	N/A
Operation frequency:	2402-2480MHz
Modulation type:	GFSK, $\pi/4$ -DQPSK, 8DPSK
Bit Rate of transmitter:	1 Mbps, 2 Mbps, 3 Mbps
Antenna type:	PCB Antenna
Antenna gain:	4.3dBi
Max. output power:	9.030dBm
Hardware version:	V2.0
Software version:	YF_XXXG_20180623
Power supply:	DC 12V from adapter
Adapter information:	N/A
Battery:	N/A

1.2 Operation channel list

Channel	Frequency (MHz)	Channel	Frequency (MHz)	Channel	Frequency (MHz)
00	2402	27	2429	54	2456
01	2403	28	2430	55	2457
02	2404	29	2431	56	2458
03	2405	30	2432	57	2459
04	2406	31	2433	58	2460
05	2407	32	2434	59	2461
06	2408	33	2435	60	2462
07	2409	34	2436	61	2463
08	2410	35	2437	62	2464
09	2411	36	2438	63	2465

10	2412	37	2439	64	2466
11	2413	38	2440	65	2467
12	2414	39	2441	66	2468
13	2415	40	2442	67	2469
14	2416	41	2443	68	2470
15	2417	42	2444	69	2471
16	2418	43	2445	70	2472
17	2419	44	2446	71	2473
18	2420	45	2447	72	2474
19	2421	46	2448	73	2475
20	2422	47	2449	74	2476
21	2423	48	2450	75	2477
22	2424	49	2451	76	2478
23	2425	50	2452	77	2479
24	2426	51	2453	78	2480
25	2427	52	2454	--	--
26	2428	53	2455	--	--

1.3 Test channel list

Channel	Channel	Frequency (MHz)
Low	00	2402
Middle	39	2441
High	79	2480

1.4 Ancillary equipment list

Equipment	Model	S/N	Manufacturer	Certificate type
/	/	/	/	/

1.5 Description of Support Units

The EUT has been tested as an independent unit together with other necessary accessories or support units. The following support units or accessories were used to form a representative test configuration during the tests.

Item	Equipment	Brand	Model/Type No.	Series No.	Note
/	/	/	/	/	/

Note:

(1)The support equipment was authorized by Declaration of Confirmation.

(2)For detachable type I/O cable should be specified the length in cm in 『Length』 column.

2 Summary of Test Results

Test procedures according to the technical standards:

No.	Standard Section	Test Item	Result	Remark
1	15.203/15.247(c)	Antenna requirement	Pass	
2	15.247(b)(1)	Peak output power	Pass	
3	15.207	Conducted emission	Pass	
4	15.247(d)	Band edge	Pass	
5	15.205/15.209	Spurious emission	Pass	
6	15.247(a)(1)	20dB occupied bandwidth	Pass	
7	15.247(a)(1)	Carrier Frequencies Separation	Pass	
8	15.247(a)(1)	Hopping channel number	Pass	
9	15.247(a)(1)	Dwell time	Pass	

3 Test Facilities and Accreditations

3.1 Test laboratory

Test Laboratory	Shenzhen Microtest Co., Ltd.
Location	No.102A & 302A, East Block, Hengfang Industrial Park, Xingye Road, Xixiang, Bao'an District, Shenzhen, Guangdong, China
FCC Registration No.:	448573

3.2 Environmental conditions

Temperature:	20°C~30°C
Humidity	30%~70%
Atmospheric pressure	98kPa~101kPa

3.3 Measurement uncertainty

The reported uncertainty of measurement $y \pm U$ where expanded uncertainty U is based on a standard uncertainty multiplied by a coverage factor of $k=2$ providing a level of confidence of approximately 95 %

No.	Item	Uncertainty
1	Conducted Emission Test	$\pm 1.38\text{dB}$
2	RF power, conducted	$\pm 0.16\text{dB}$
3	Spurious emissions, conducted	$\pm 0.21\text{dB}$
4	All emissions, radiated(<1G)	$\pm 4.68\text{dB}$
5	All emissions, radiated(>1G)	$\pm 4.89\text{dB}$
6	Temperature	$\pm 0.5^\circ\text{C}$
7	Humidity	$\pm 2\%$

3.4 Test software

Software Name	Manufacturer	Model	Version
RF Test System	Farad	LZ-RF	Lz_Rf 3A3

4 Equipment List

Equipment No.	Equipment Name	Manufacturer	Model	Serial No.	Calibration date	Due date
MTI-E001	Spectrum Analyzer	Agilent	E4407B	MY41441082	2017/09/18	2018/09/17
MTI-E002	CMU 200 universal radio communication tester	Rohde&schwarz	CMU 200	114587	2017/09/18	2018/09/17
MTI-E004	EMI Test Receiver	Rohde&schwarz	ESPI	1000314	2017/09/18	2018/09/17
MTI-E006	Broadband antenna	schwarabeck	VULB9163	872	2017/09/18	2018/09/17
MTI-E007	Horn antenna	schwarabeck	BBHA9120D	1201	2017/09/18	2018/09/17
MTI-E014	amplifier	America	8447D	3113A06150	2017/09/18	2018/09/17
MTI-E015	Conduction Immunity Signal Generator	Schloder	CDG6000	126A1343/2015	2017/09/18	2018/09/17
MTI-E016	Coupled decoupling network	Schloder	CDA M2/M3	A2210332/2015	2017/09/18	2018/09/17
MTI-E032	Comprehensive test instrument	Rohde&schwarz	CMW500	124192	2017/09/13	2018/09/12
MTI-E034	amplifier	Agilent	8449B	3008A02400	2018/08/22	2019/08/21
MTI-E040	Spectrum analyzer	Agilent	N9020A	MY49100060	2017/09/05	2018/09/04
MTI-E041	Signal generator	Agilent	N5182A	MY49060455	2017/09/23	2018/09/22
MTI-E042	Analog signal generator	Agilent	E4421B	GB40051240	2017/09/23	2018/09/22
MTI-E043	Power probe	Dare Instruments	RPR3006W	16I00054SN016	2017/09/29	2018/09/28
MTI-E047	10dB attenuator	Mini-Circuits	UNAT-10+	15542	2017/09/24	2018/09/23
MTI-E049	spectrum analyzer	Rohde&schwarz	FSP-38	100019	2017/09/18	2018/09/17
MTI-E050	PSG Signal generator	Agilent	E8257D	MY46520873	2017/09/24	2018/09/23
MTI-E051	Active Loop Antenna 9kHz - 30MHz	Schwarzbeek	FMZB 1519 B	00044	2017/09/26	2018/09/25
MTI-E052	18-40GHz amplifier	Chengdu step Micro Technology	ZLNA-18-40G-21	1608001	2017/09/18	2018/09/17
MTI-E053	15-40G Antenna	Schwarzbeek	BBHA9170	BBHA9170582	2017/09/18	2018/09/17

Note: the calibration interval of the above test instruments is 12 months and the calibrations are traceable to international system unit (SI).

5 Test Result

5.1 Antenna requirement

5.1.1 Standard requirement

15.203 requirement: For intentional device, according to 15.203: an intentional radiator shall be designed to ensure that no antenna other than that furnished by the responsible party shall be used with the device

5.1.2 EUT Antenna

The EUT antenna is PCB antenna (4.3dBi). It comply with the standard requirement. In case of replacement of broken antenna the same antenna type must be used.

5.2 Peak output power

5.2.1 Limit

FCC Part15 Subpart C			
Section	Test Item	Limit	Frequency Range (MHz)
15.247(b)(1)	Peak output power	Power<1W(30dBm)	2400-2483.5

5.2.2 Test setup

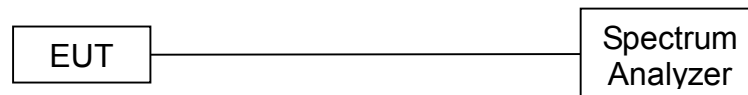

5.2.3 Test procedure

- (1) The EUT was directly connected to the spectrum analyzer and antenna output port as show in the block diagram above.
- (2) Spectrum Setting:
 RBW=1MHz, VBW=3MHz, Detector=Peak (If 20dB BW ≤1 MHz)
 RBW=3MHz, VBW=10MHz, Detector=Peak (If 20dB BW > 1 MHz)
- (3) The EUT was set to continuously transmitting in the max power during the test.

5.2.4 Test results

Test data

EUT :	Android AD Player	Model Name :	YF-021H
Temperature :	25 °C	Relative Humidity :	60%
Pressure :	1012 hPa	Test Voltage :	DC 12V from adapter

GFSK

Test Channel	Frequency (MHz)	Maximum Peak Output Power(dBm)	Limit (dBm)
CH00	2402	7.236	30
CH39	2441	6.928	30
CH78	2480	6.692	30

$\pi/4$ -DQPSK

Test Channel	Frequency (MHz)	Maximum Peak Output Power(dBm)	Limit (dBm)
CH00	2402	8.621	20.97
CH39	2441	8.939	20.97
CH78	2480	8.699	20.97

8DPSK

Test Channel	Frequency (MHz)	Maximum Peak Output Power(dBm)	Limit (dBm)
CH00	2402	8.799	20.97
CH39	2441	9.030	20.97
CH78	2480	8.864	20.97

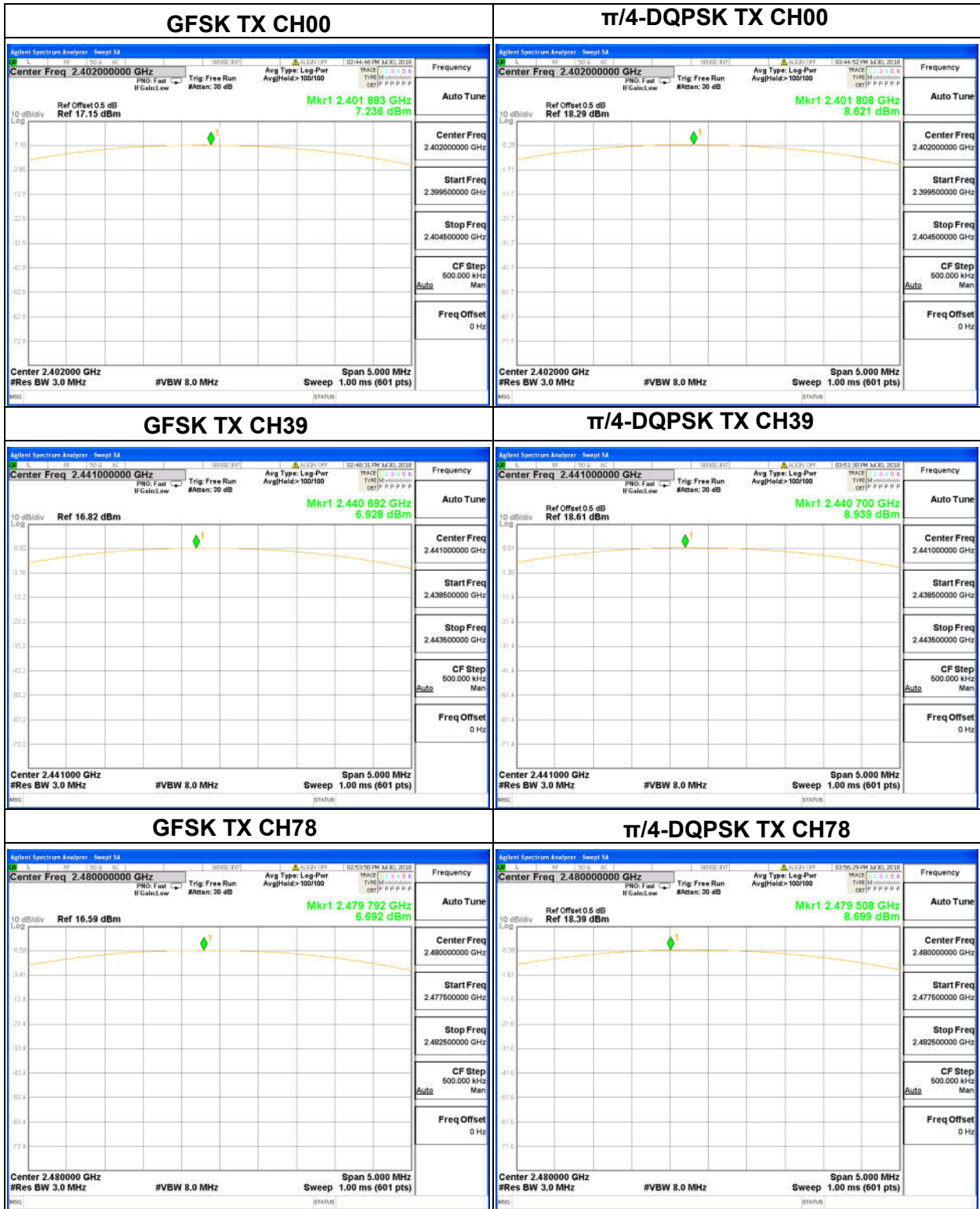

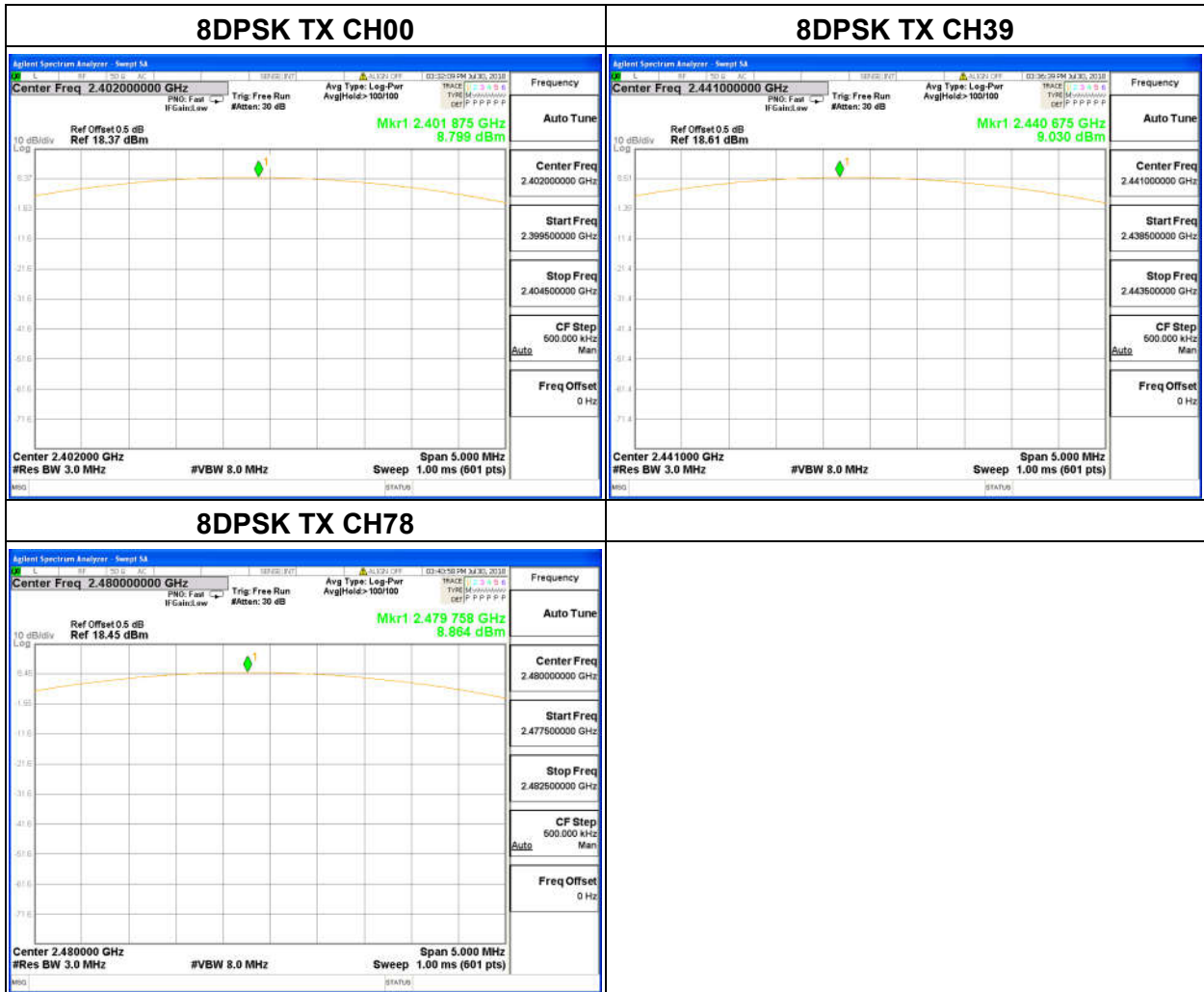

5.3 Conducted emission

5.3.1 Limits

FREQUENCY (MHz)	Class B (dBuV)	
	Quasi-peak	Average
0.15 -0.5	66 - 56 *	56 - 46 *
0.50 -5.0	56.00	46.00
5.0 -30.0	60.00	50.00

Note

(1)The tighter limit applies at the band edges.

(2)The limit of " * " marked band means the limitation decreases linearly with the logarithm of the frequency in the range.

5.3.2 Test setup

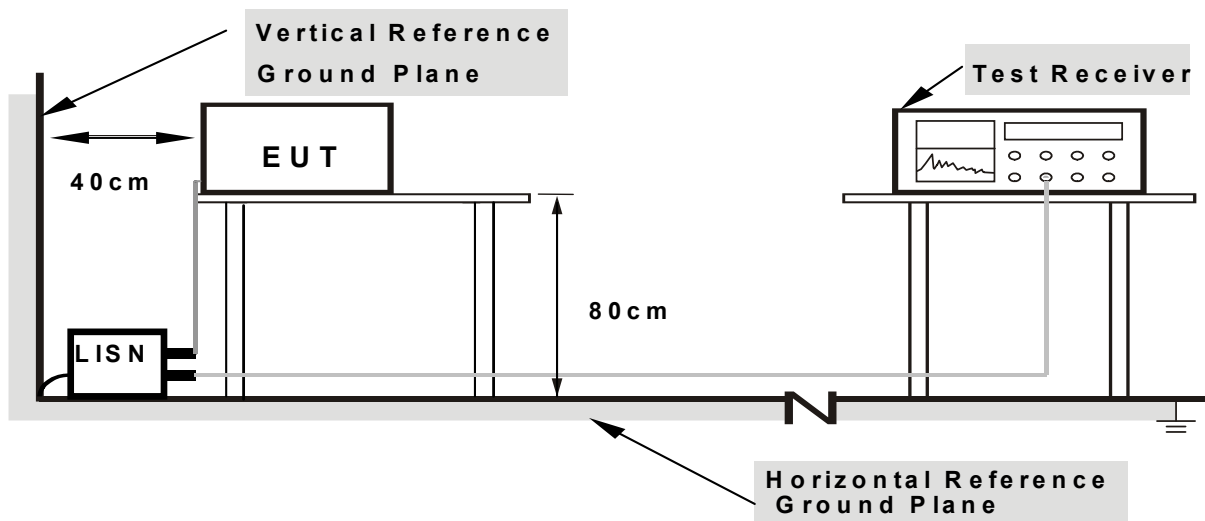

Note: 1.Support units were connected to second LISN .

2.Both of LISNs (AMN) are 80 cm from EUT and at least 80 from other units and other metal planes

5.3.3 Test procedure

a. EUT Operating Conditions

The EUT was configured for testing in a typical fashion (as a customer would normally use it). The EUT has been programmed to continuously transmit during test. This operating condition was tested and used to collect the included data.

b. The following table is the setting of the receiver

Receiver Parameters	Setting
Attenuation	10 dB
Start Frequency	0.15 MHz
Stop Frequency	30 MHz
IF Bandwidth	9 kHz

- c. The EUT was placed 0.8 meters from the horizontal ground plane with EUT being connected to the power mains through a line impedance stabilization network (LISN). All other support equipments powered from additional LISN(s). The LISN provide 50 Ohm/ 50uH of coupling impedance for the measuring instrument.
- d. Interconnecting cables that hang closer than 40 cm to the ground plane shall be folded back and forth in the center forming a bundle 30 to 40 cm long.
- e. I/O cables that are not connected to a peripheral shall be bundled in the center. The end of the cable may be terminated, if required, using the correct terminating impedance. The overall length shall not exceed 1 m.
- f. LISN at least 80 cm from nearest part of EUT chassis.

For the actual test configuration, please refer to the related Item –EUT Test Photos.

5.3.4 Test results

Test data

EUT :	Android AD Player	Model Name. :	YF-021H
Temperature :	26 °C	Relative Humidity :	54%
Pressure :	1010hPa	Phase :	L
Test Voltage :	DC 12V from adapter AC 120V/60Hz	Test Mode :	TX

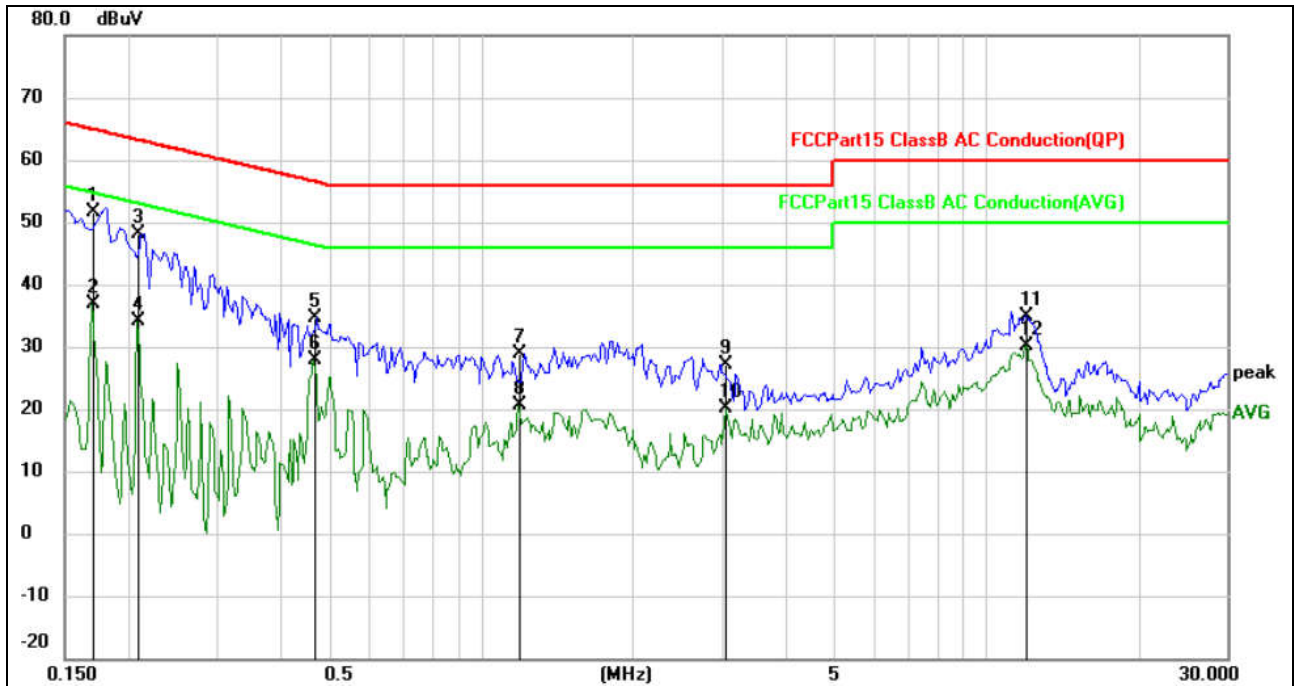

No.	Mk.	Freq.	Reading Level	Correct Factor	Measurement	Limit	Over	Detector	Comment
		MHz	dBuV	dB	dBuV	dBuV	dB		
1	*	0.1695	49.98	1.57	51.55	64.98	-13.43	QP	
2		0.1695	35.27	1.57	36.84	54.98	-18.14	AVG	
3		0.2086	46.65	1.57	48.22	63.26	-15.04	QP	
4		0.2086	32.67	1.57	34.24	53.26	-19.02	AVG	
5		0.4664	33.00	1.57	34.57	56.58	-22.01	QP	
6		0.4664	26.22	1.57	27.79	46.58	-18.79	AVG	
7		1.1852	27.26	1.58	28.84	56.00	-27.16	QP	
8		1.1852	18.99	1.58	20.57	46.00	-25.43	AVG	
9		3.0469	26.17	1.01	27.18	56.00	-28.82	QP	
10		3.0469	19.24	1.01	20.25	46.00	-25.75	AVG	
11		11.9961	34.42	0.36	34.78	60.00	-25.22	QP	
12		11.9961	29.78	0.36	30.14	50.00	-19.86	AVG	

EUT :	Android AD Player	Model Name. :	YF-021H
Temperature :	26 °C	Relative Humidity :	54%
Pressure :	1010hPa	Phase :	N
Test Voltage :	DC 12V from adapter AC 120V/60Hz	Test Mode :	TX

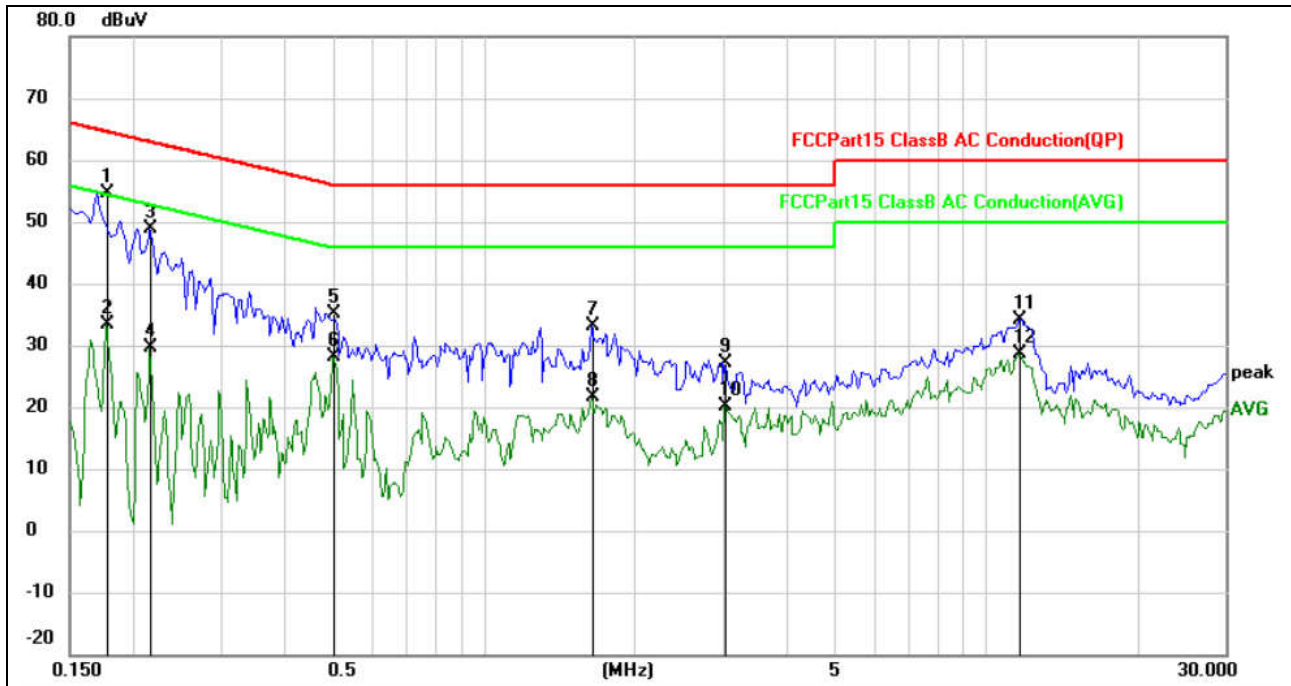

No.	Mk.	Freq. MHz	Reading Level dBuV	Correct Factor dB	Measure- ment dBuV	Limit dBuV	Over dB	Detector	Comment
1	*	0.1773	52.95	1.57	54.52	64.61	-10.09	QP	
2		0.1773	31.76	1.57	33.33	54.61	-21.28	AVG	
3		0.2164	47.40	1.57	48.97	62.96	-13.99	QP	
4		0.2164	28.03	1.57	29.60	52.96	-23.36	AVG	
5		0.5016	33.68	1.57	35.25	56.00	-20.75	QP	
6		0.5016	26.59	1.57	28.16	46.00	-17.84	AVG	
7		1.6383	31.58	1.58	33.16	56.00	-22.84	QP	
8		1.6383	19.97	1.58	21.55	46.00	-24.45	AVG	
9		3.0195	26.16	1.02	27.18	56.00	-28.82	QP	
10		3.0195	19.16	1.02	20.18	46.00	-25.82	AVG	
11		11.6250	33.67	0.36	34.03	60.00	-25.97	QP	
12		11.6250	28.39	0.36	28.75	50.00	-21.25	AVG	

EUT :	Android AD Player	Model Name. :	YF-021H
Temperature :	26 °C	Relative Humidity :	54%
Pressure :	1010hPa	Phase :	L
Test Voltage :	DC 12V from adapter AC 240V/60Hz	Test Mode :	TX

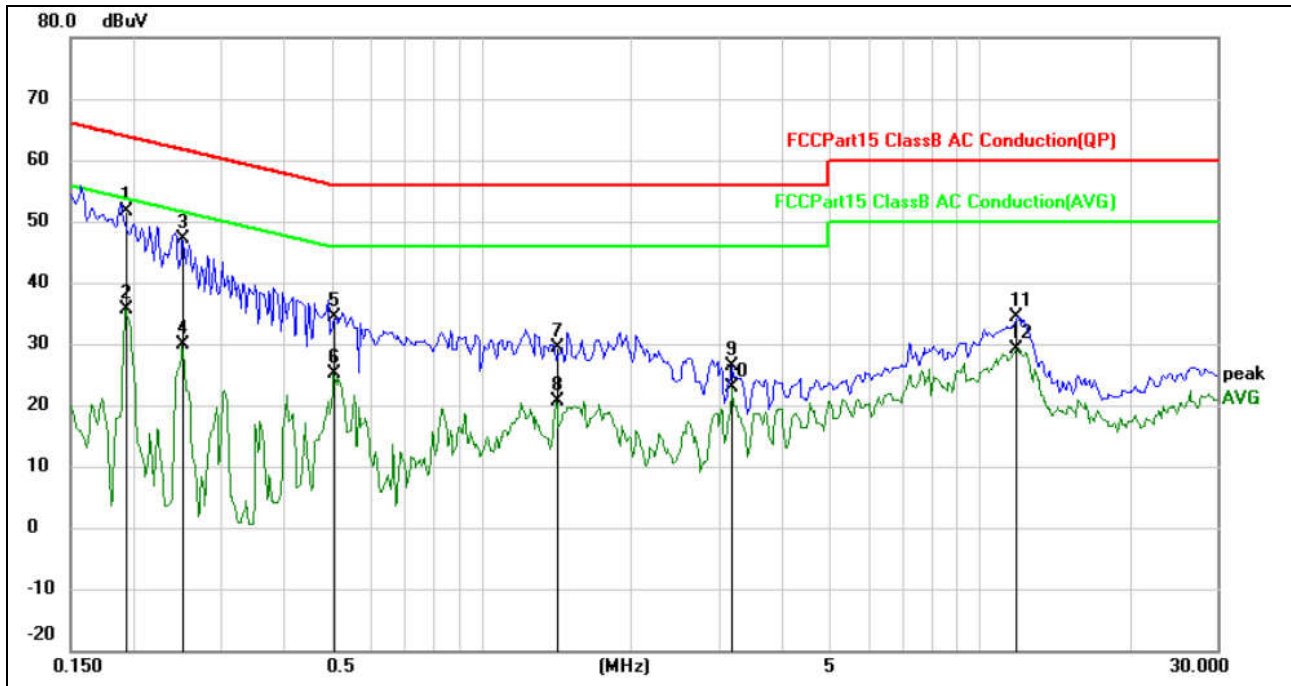

No.	Mk.	Freq. MHz	Reading Level dBuV	Correct Factor dB	Measure- ment dBuV	Limit dBuV	Over dB	Detector	Comment
1	*	0.1928	50.09	1.57	51.66	63.92	-12.26	QP	
2		0.1928	34.14	1.57	35.71	53.92	-18.21	AVG	
3		0.2515	45.55	1.57	47.12	61.71	-14.59	QP	
4		0.2515	28.29	1.57	29.86	51.71	-21.85	AVG	
5		0.5053	32.78	1.57	34.35	56.00	-21.65	QP	
6		0.5053	23.52	1.57	25.09	46.00	-20.91	AVG	
7		1.4155	27.85	1.58	29.43	56.00	-26.57	QP	
8		1.4155	19.16	1.58	20.74	46.00	-25.26	AVG	
9		3.1875	25.38	1.00	26.38	56.00	-29.62	QP	
10		3.1875	21.78	1.00	22.78	46.00	-23.22	AVG	
11		11.8202	33.98	0.36	34.34	60.00	-25.66	QP	
12		11.8202	28.89	0.36	29.25	50.00	-20.75	AVG	

EUT :	Android AD Player	Model Name. :	YF-021H
Temperature :	26 °C	Relative Humidity :	54%
Pressure :	1010hPa	Phase :	N
Test Voltage :	DC 12V from adapter AC 240V/60Hz	Test Mode :	TX

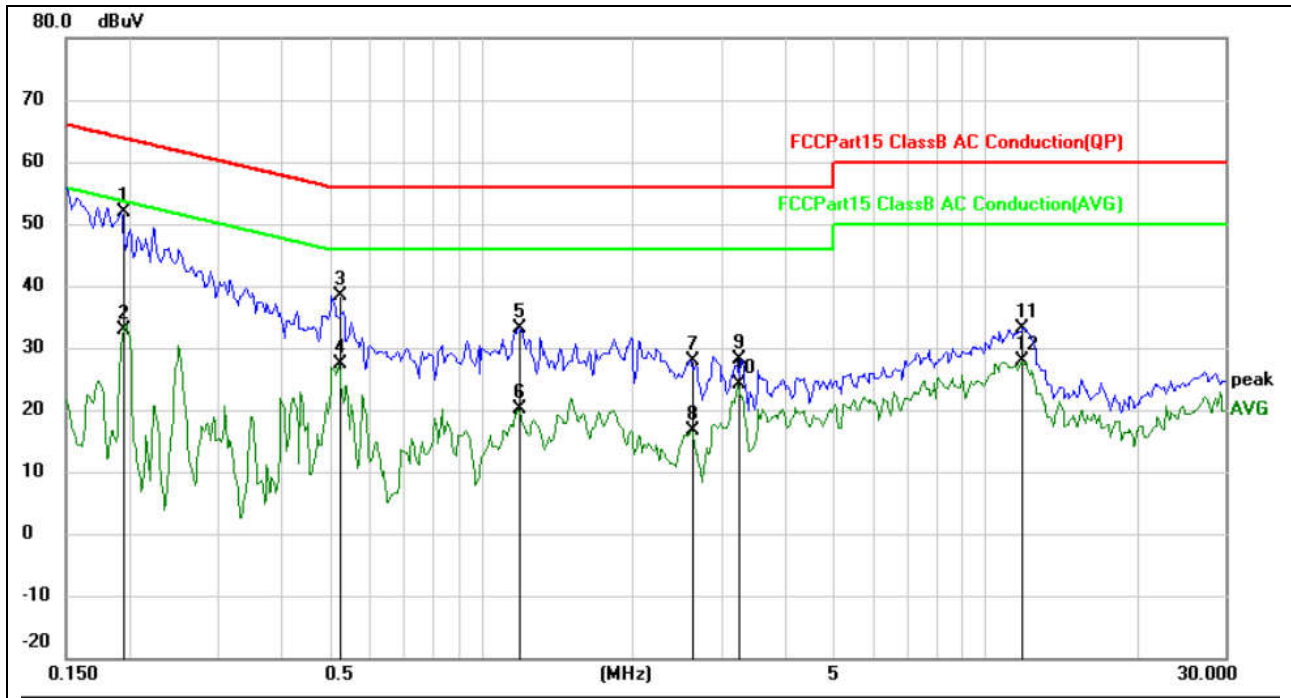

No.	Mk.	Freq. MHz	Reading Level dBuV	Correct Factor dB	Measure- ment dBuV	Limit dBuV	Over dB	Detector	Comment
1	*	0.1955	50.19	1.57	51.76	63.80	-12.04	QP	
2		0.1955	31.22	1.57	32.79	53.80	-21.01	AVG	
3		0.5211	36.78	1.57	38.35	56.00	-17.65	QP	
4		0.5211	25.82	1.57	27.39	46.00	-18.61	AVG	
5		1.1852	31.49	1.58	33.07	56.00	-22.93	QP	
6		1.1852	18.49	1.58	20.07	46.00	-25.93	AVG	
7		2.6187	26.71	1.19	27.90	56.00	-28.10	QP	
8		2.6187	15.36	1.19	16.55	46.00	-29.45	AVG	
9		3.2344	27.19	0.99	28.18	56.00	-27.82	QP	
10		3.2344	23.16	0.99	24.15	46.00	-21.85	AVG	
11		11.8164	32.72	0.36	33.08	60.00	-26.92	QP	
12		11.8164	27.46	0.36	27.82	50.00	-22.18	AVG	

5.4 Radiated spurious emission

5.4.1 Limits

20dBc in any 100 kHz bandwidth outside the operating frequency band. In case the emission fall within the restricted band specified on 15.205(a), then the 15.209(a) limit in the table below has to be followed.

Frequency (MHz)	Field Strength (micovolts/meter)	Measurement Distance (meters)
0.009~0.490	2400/F(KHz)	300
0.490~1.705	24000/F(KHz)	30
1.705~30.0	30	30
30~88	100	3
88~216	150	3
216~960	200	3
Above 960	500	3

Spectrum Parameter	Setting
Attenuation	Auto
Start Frequency	1000 MHz
Stop Frequency	10th carrier harmonic
RB / VB (emission in restricted band)	1 MHz / 1 MHz for Peak, 1 MHz / 10Hz for Average

Receiver Parameter	Setting
Attenuation	Auto
Start ~ Stop Frequency	9kHz~150kHz / RB 200Hz for QP
Start ~ Stop Frequency	150kHz~30MHz / RB 9kHz for QP
Start ~ Stop Frequency	30MHz~1000MHz / RB 120kHz for QP

5.4.2 Test setup

Radiated emission test-up frequency below 30MHz

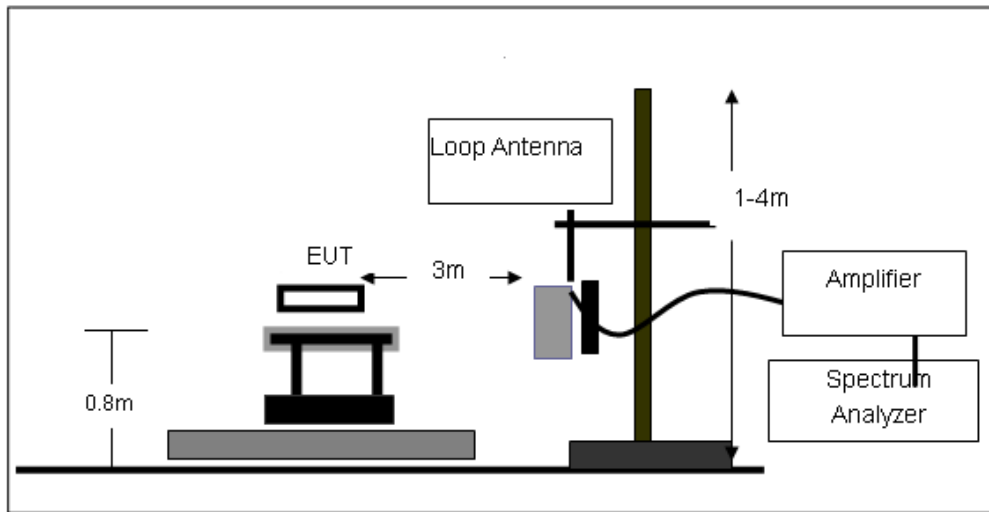

Radiated emission test-up frequency 30MHz~1GHz

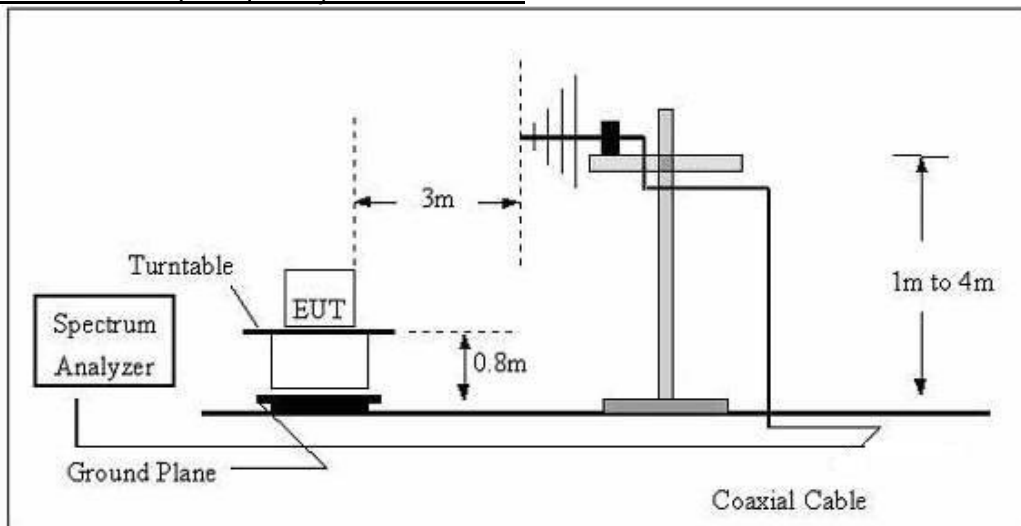

Radiated emission test-up frequency above 1GHz

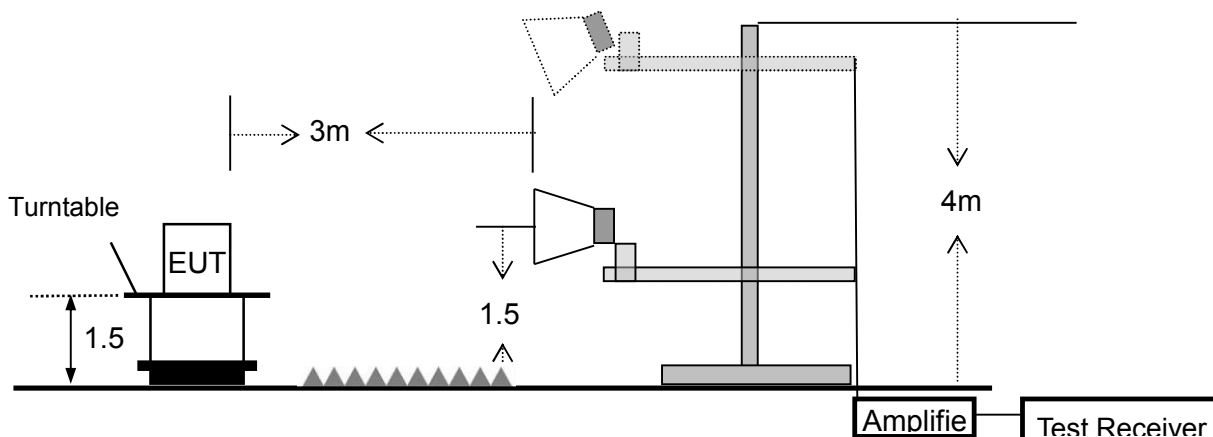

5.4.3 Test procedure

- a. The measuring distance of at 3 m shall be used for measurements at frequency up to 1GHz. For frequencies above 1GHz, any suitable measuring distance may be used.
- b. The EUT was placed on the top of a rotating table 0.8 m for below 1GHz and 1.5m for above 1GHz the ground at a 3 meter. The table was rotated 360 degrees to determine the position of the highest radiation.
- c. The height of the equipment or of the substitution antenna shall be 0.8 m for below 1GHz and 1.5m for above 1GHz; the height of the test antenna shall vary between 1 m to 4 m. Both horizontal and vertical polarizations of the antenna are set to make the measurement.
- d. For the radiated emission test above 1GHz:

Place the measurement antenna away from each area of the EUT determined to be a source of emissions at the specified measurement distance, while keeping the measurement antenna aimed at the source of emissions at each frequency of significant emissions, with polarization oriented for maximum response. The measurement antenna may have to be higher or lower than the EUT, depending on the radiation pattern of the emission and staying aimed at the emission source for receiving the maximum signal. The final measurement antenna elevation shall be that which maximizes the emissions. The measurement antenna elevation for maximum emissions shall be restricted to a range of heights of from 1 m to 4 m above the ground or reference ground plane.

e. The initial step in collecting conducted emission data is a spectrum analyzer peak detector mode pre-scanning the measurement frequency range. Significant peaks are then marked and then Quasi Peak detector mode re-measured.

f. If the Peak Mode measured value compliance with and lower than Quasi Peak Mode Limit, the EUT shall be deemed to meet QP Limits and then no additional QP Mode measurement performed.

g. For the actual test configuration, please refer to the related Item –EUT Test Photos.

Note: Both horizontal and vertical antenna polarities were tested and performed pretest to three orthogonal axis. The worst case emissions were reported

During the radiated emission test, the Spectrum Analyzer was set with the following configurations:

Frequency Band (MHz)	Function	Resolution bandwidth	Video Bandwidth
30 to 1000	QP	120 kHz	300 kHz
Above 1000	Peak	1 MHz	1 MHz
	Average	1 MHz	10 Hz

Note: for the frequency ranges below 30 MHz, a narrower RBW is used for these ranges but the measured value should add a RBW correction factor (RBWCF) where $RBWCF [dB] = 10 * \lg(100 [kHz] / \text{narrower RBW [kHz]})$. , the narrower RBW is 1 kHz and RBWCF is 20 dB for the frequency 9 kHz to 150 kHz, and the narrower RBW is 10 kHz and RBWCF is 10 dB for the frequency 150 kHz to 30 MHz.

5.4.4 Test results

5.4.4.1 Radiation emission

Below 30MHz

EUT:	Android AD Player	Model Name:	YF-021H
Temperature:	20 °C	Relative Humidity:	48%
Pressure:	1010 hPa	Test Voltage:	DC 12V from adapter
Test Mode:	TX	Polarization :	--

Freq.	Reading	Limit	Margin	State
(MHz)	(dBuV/m)	(dBuV/m)	(dB)	P/F
--	--	--	--	Pass
--	--	--	--	Pass

Note:

The amplitude of spurious emissions which are attenuated by more than 20dB below the permissible value has no need to be reported.

Distance extrapolation factor = $40 \log(\text{specific distance}/\text{test distance})$ (dB);

Limit line = specific limits(dBuV) + distance extrapolation factor.

Between 30MHz – 1GHz

Note1 : Emission Level = Meter Reading + Factor, Margin= Emission Level- Limit, Factor = Antenna Factor + Cable Loss – Pre-amplifier.

Note2 : The peak value is less than the AV value, AV value is not required Factor added by measurement software automatically.

EUT :	Android AD Player	Model Name :	YF-021H
Relative Humidity:	52%	Phase:	H
Pressure:	1010 hPa	Test Voltage :	DC 12V from adapter
Test Mode :	TX		

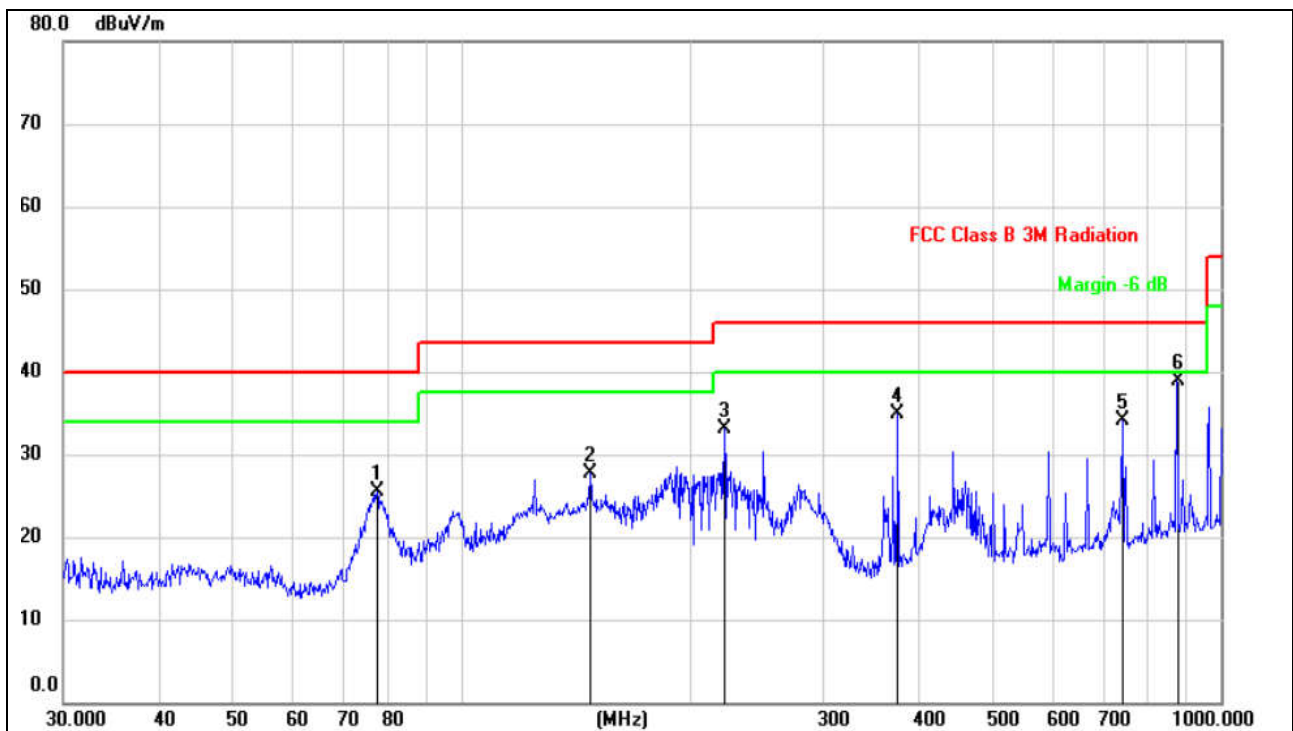

No.	Mk.	Freq. MHz	Reading Level dBuV	Correct Factor dBuV/m	Measure- ment dBuV/m	Limit dBuV/m	Over dB	Detector
1		77.5926	41.10	-15.61	25.49	40.00	-14.51	QP
2		147.9214	43.07	-15.43	27.64	43.50	-15.86	QP
3		222.1698	45.29	-12.13	33.16	46.00	-12.84	QP
4		375.9385	43.64	-8.83	34.81	46.00	-11.19	QP
5		742.2586	40.68	-6.57	34.11	46.00	-11.89	QP
6	*	875.2470	43.81	-4.96	38.85	46.00	-7.15	QP

EUT :	Android AD Player	Model Name :	YF-021H
Relative Humidity:	52%	Phase:	V
Pressure:	1010 hPa	Test Voltage :	DC 12V from adapter
Test Mode :	TX		

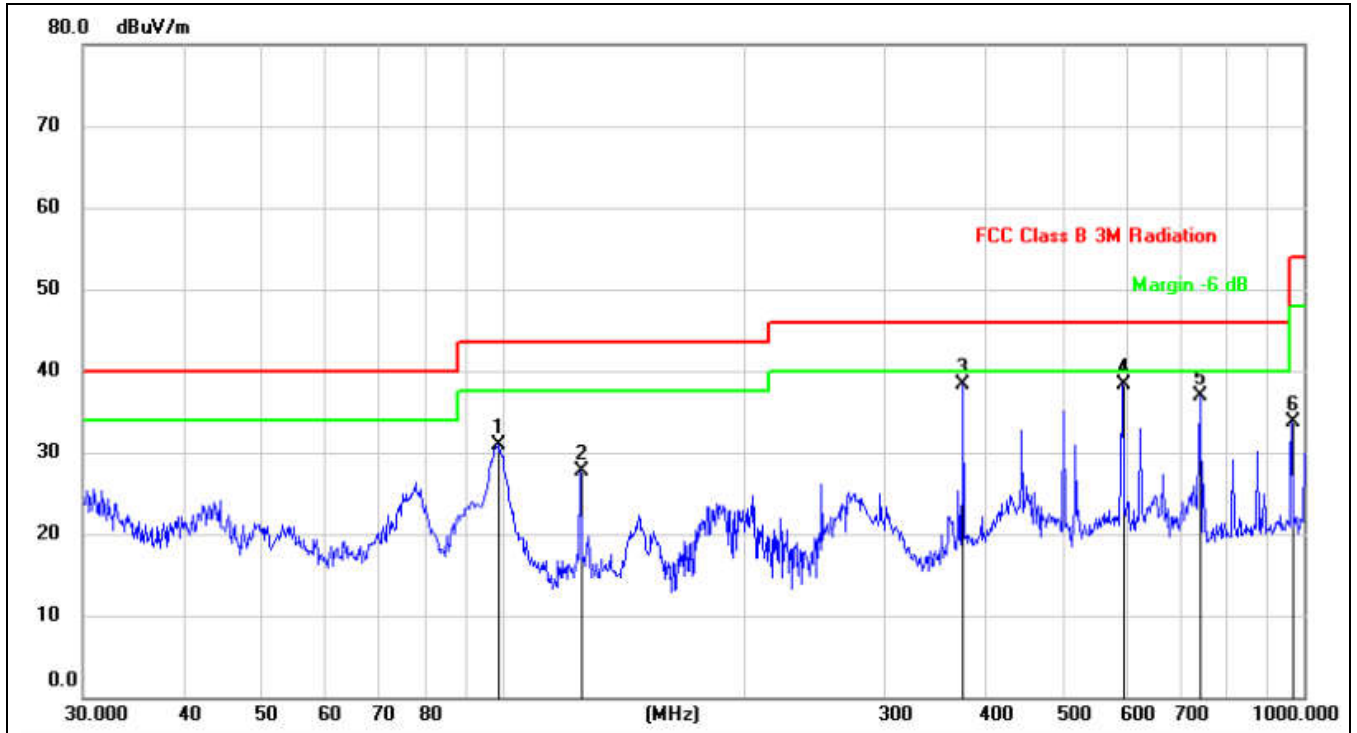

No.	Mk.	Freq.	Reading Level	Correct Factor	Measurement	Limit	Over	Detector
		MHz	dBuV	dBuV/m	dBuV/m	dBuV/m	dB	
1		98.8326	43.13	-12.29	30.84	43.50	-12.66	QP
2		125.0066	41.26	-13.55	27.71	43.50	-15.79	QP
3		375.9385	47.16	-8.83	38.33	46.00	-7.67	QP
4	*	593.0497	45.39	-7.00	38.39	46.00	-7.61	QP
5		742.2586	43.48	-6.57	36.91	46.00	-9.09	QP
6		965.5421	37.93	-4.23	33.70	54.00	-20.30	QP

1G-25GHz

- Note: (1) All Readings are Peak Value (VBW=3MHz) and AV Value (VBW=10Hz).
 (2) Emission Level= Antenna Factor + Cable Loss + Read Level - Preamp Factor
 (3) All other emissions more than 20dB below the limit.

All the modulation modes have been tested, and the worst result was report as below:

Frequency (MHz)	Read Level (dBμV)	Cable loss (dB)	Antenna Factor (dB/m)	Preamp Factor (dB)	Emission Level (dBμV/m)	Limits (dBμV/m)	Margin (dB)	Remark	Comment
Low Channel (2402 MHz)(8DPSK)--Above 1G									
4804.11	62.77	5.21	35.59	44.30	59.27	74.00	-14.73	Pk	Vertical
4804.11	40.81	5.21	35.59	44.30	37.31	54.00	-16.69	AV	Vertical
7206.21	61.57	6.48	36.27	44.60	59.72	74.00	-14.28	Pk	Vertical
7206.21	44.17	6.48	36.27	44.60	42.32	54.00	-11.68	AV	Vertical
4804.12	62.45	5.21	35.55	44.30	58.91	74.00	-15.09	Pk	Horizontal
4804.12	43.95	5.21	35.55	44.30	40.41	54.00	-13.59	AV	Horizontal
7206.22	62.34	6.48	36.27	44.52	60.57	74.00	-13.43	Pk	Horizontal
7206.22	46.82	6.48	36.27	44.52	45.05	54.00	-8.95	AV	Horizontal
Mid Channel (2441 MHz)(8DPSK)--Above 1G									
4882.32	63.90	5.21	35.66	44.20	60.57	74.00	-13.43	Pk	Vertical
4882.32	43.56	5.21	35.66	44.20	40.23	54.00	-13.77	AV	Vertical
7323.22	61.38	7.10	36.50	44.43	60.55	74.00	-13.45	Pk	Vertical
7323.22	47.87	7.10	36.50	44.43	47.04	54.00	-6.96	AV	Vertical
4882.13	60.53	5.21	35.66	44.20	57.20	74.00	-16.80	Pk	Horizontal
4882.13	49.68	5.21	35.66	44.20	46.35	54.00	-7.65	AV	Horizontal
7323.13	60.59	7.10	36.50	44.43	59.76	74.00	-14.24	Pk	Horizontal
7323.13	41.81	7.10	36.50	44.43	40.98	54.00	-13.02	AV	Horizontal
High Channel (2480 MHz)(8DPSK)-- Above 1G									
4960.31	66.09	5.21	35.52	44.21	62.61	74.00	-11.39	Pk	Vertical
4960.31	43.27	5.21	35.52	44.21	39.79	54.00	-14.21	AV	Vertical
7440.27	61.03	7.10	36.53	44.60	60.06	74.00	-13.94	Pk	Vertical
7440.27	44.64	7.10	36.53	44.60	43.67	54.00	-10.33	AV	Vertical
4960.25	67.48	5.21	35.52	44.21	64.00	74.00	-10.00	Pk	Horizontal
4960.25	48.10	5.21	35.52	44.21	44.62	54.00	-9.38	AV	Horizontal
7440.13	61.22	7.10	36.53	44.60	60.25	74.00	-13.75	Pk	Horizontal
7440.13	45.76	7.10	36.53	44.60	44.79	54.00	-9.21	AV	Horizontal

5.4.4.2 Band edge – radiated

All the modulation modes have been tested, and the worst result was report as below:

Frequency (MHz)	Meter Reading (dBμV)	Cable Loss (dB)	Antenna Factor dB/m	Preamplifier Factor (dB)	Emission Level (dBμV/m)	Limits (dBμV/m)	Margin (dB)	Detector Type	Comment
1Mbps (8DPSK)-hopping									
2310.00	56.36	2.97	27.80	43.80	43.33	74	-30.67	Pk	Horizontal
2310.00	44.76	2.97	27.80	43.80	31.73	54	-22.27	AV	Horizontal
2310.00	58.24	2.97	27.80	43.80	45.21	74	-28.79	Pk	Vertical
2310.00	42.87	2.97	27.80	43.80	29.84	54	-24.16	AV	Vertical
2390.00	58.43	3.14	27.21	43.80	44.98	74	-29.02	Pk	Vertical
2390.00	43.79	3.14	27.21	43.80	30.34	54	-23.66	AV	Vertical
2390.00	56.52	3.14	27.21	43.80	43.07	74	-30.93	Pk	Horizontal
2390.00	42.29	3.14	27.21	43.80	28.84	54	-25.16	AV	Horizontal
2483.50	57.80	3.58	27.70	44.00	45.08	74	-28.92	Pk	Vertical
2483.50	42.88	3.58	27.70	44.00	30.16	54	-23.84	AV	Vertical
2483.50	60.27	3.58	27.70	44.00	47.55	74	-26.45	Pk	Horizontal
2483.50	43.38	3.58	27.70	44.00	30.66	54	-23.34	AV	Horizontal
1Mbps(8DPSK)-Non-hopping									
2310.00	56.36	2.97	27.80	43.80	43.33	74	-30.67	Pk	Horizontal
2310.00	43.82	2.97	27.80	43.80	30.79	54	-23.21	AV	Horizontal
2310.00	59.77	2.97	27.80	43.80	46.74	74	-27.26	Pk	Vertical
2310.00	43.19	2.97	27.80	43.80	30.16	54	-23.84	AV	Vertical
2390.00	58.48	3.14	27.21	43.80	45.03	74	-28.97	Pk	Vertical
2390.00	43.09	3.14	27.21	43.80	29.64	54	-24.36	AV	Vertical
2390.00	57.06	3.14	27.21	43.80	43.61	74	-30.39	Pk	Horizontal
2390.00	43.20	3.14	27.21	43.80	29.75	54	-24.25	AV	Horizontal
2483.50	58.12	3.58	27.70	44.00	45.40	74	-28.60	Pk	Vertical
2483.50	42.52	3.58	27.70	44.00	29.80	54	-24.20	AV	Vertical
2483.50	60.12	3.58	27.70	44.00	47.40	74	-26.60	Pk	Horizontal
2483.50	42.69	3.58	27.70	44.00	29.97	54	-24.03	AV	Horizontal

5.4.4.3 Spurious Emission in Restricted Band 3260MHz-18000MHz

All the modulation modes have been tested, and the worst result was report as below:

Frequency (MHz)	Reading Level (dB μ V)	Cable Loss (dB)	Antenna Factor (dB/m)	Preamplifier Factor (dB)	Emission Level (dB μ V/m)	Limits (dB μ V/m)	Margin (dB)	Detector Type	Comment
3260	60.21	4.04	29.57	44.70	49.12	74	-24.88	Pk	Vertical
3260	50.02	4.04	29.57	44.70	38.93	54	-15.07	AV	Vertical
3260	61.49	4.04	29.57	44.70	50.40	74	-23.60	Pk	Horizontal
3260	51.25	4.04	29.57	44.70	40.16	54	-13.84	AV	Horizontal
3332	64.69	4.26	29.87	44.40	54.42	74	-19.58	Pk	Vertical
3332	54.55	4.26	29.87	44.40	44.28	54	-9.72	AV	Vertical
3332	63.91	4.26	29.87	44.40	53.64	74	-20.36	Pk	Horizontal
3332	52.29	4.26	29.87	44.40	42.02	54	-11.98	AV	Horizontal
17797	44.12	10.99	43.95	43.50	55.56	74	-18.44	Pk	Vertical
17797	33.69	10.99	43.95	43.50	45.13	54	-8.87	AV	Vertical
17788	44.24	11.81	43.69	44.60	55.14	74	-18.86	Pk	Horizontal
17788	32.64	11.81	43.69	44.60	43.54	54	-10.46	AV	Horizontal

5.5 20dB occupied channel bandwidth

5.5.1 Limit

FCC Part15 (15.247) , Subpart C			
Section	Test Item	Limit	Frequency Range (MHz)
15.247a(1)	20dB bandwidth	N/A	2400-2483.5

5.5.2 Test setup

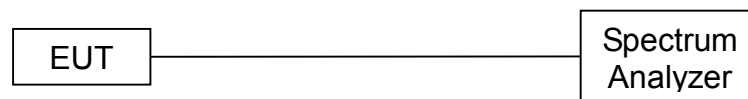

5.5.3 Test procedure

- (1) The EUT was directly connected to the spectrum analyzer and antenna output port as show in the block diagram above.
- (2) Spectrum Setting:
Bandwidth: RBW=30 kHz, VBW=100 kHz, detector= Peak

5.5.4 Test results

Test data

EUT :	Android AD Player	Model Name :	YF-021H
Temperature :	25 °C	Relative Humidity :	60%
Pressure :	1012 hPa	Test Voltage :	DC 12V from adapter

Mode	Frequency (MHz)	20dB Bandwidth (MHz)	Limit (kHz)	Result
GFSK	2402	1.038	N/A	Pass
	2441	1.040	N/A	Pass
	2480	1.041	N/A	Pass
$\pi/4$ -DQPSK	2402	1.368	N/A	Pass
	2441	1.369	N/A	Pass
	2480	1.370	N/A	Pass
8DPSK	2402	1.305	N/A	Pass
	2441	1.306	N/A	Pass
	2480	1.308	N/A	Pass

Test plots

GFSK mode

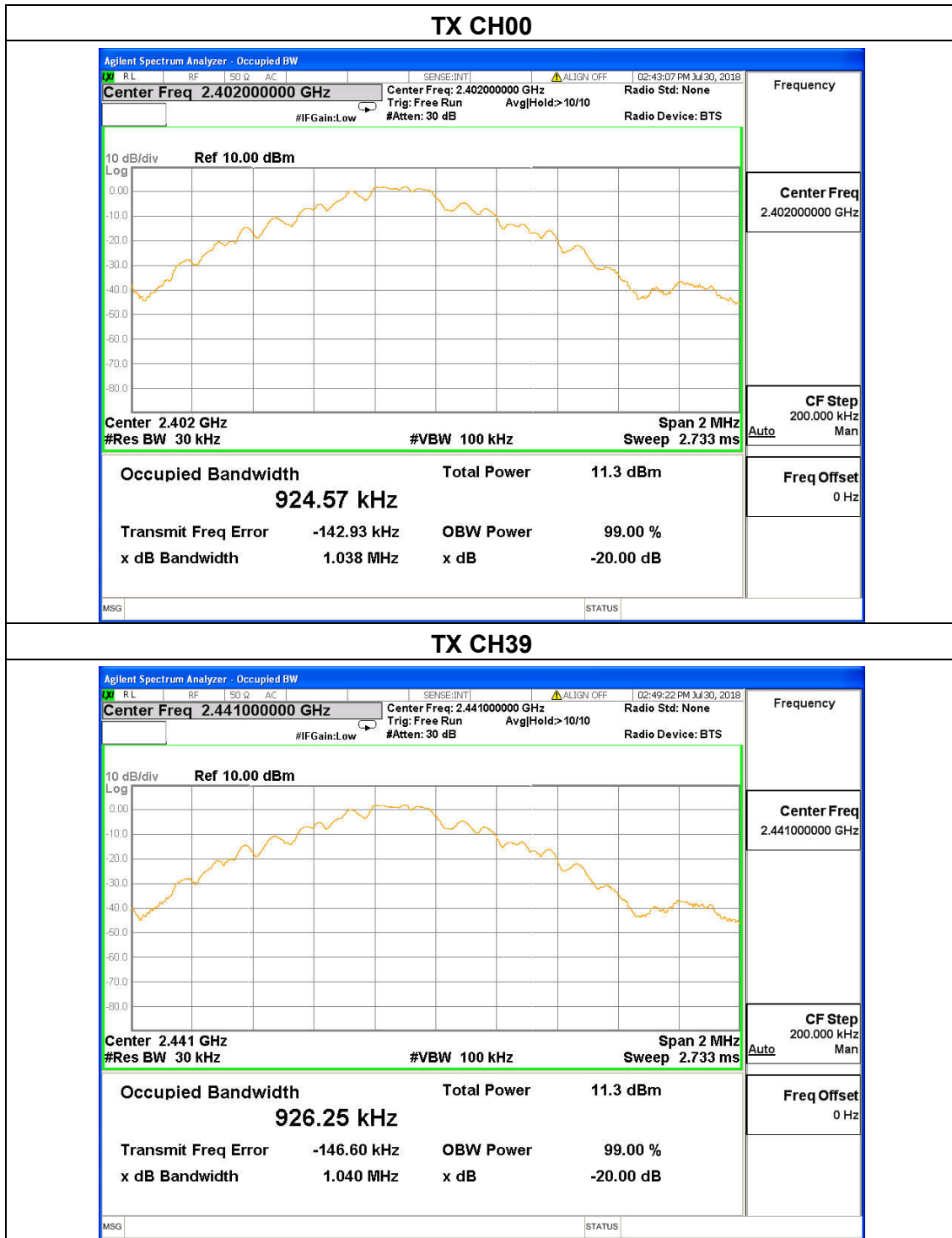

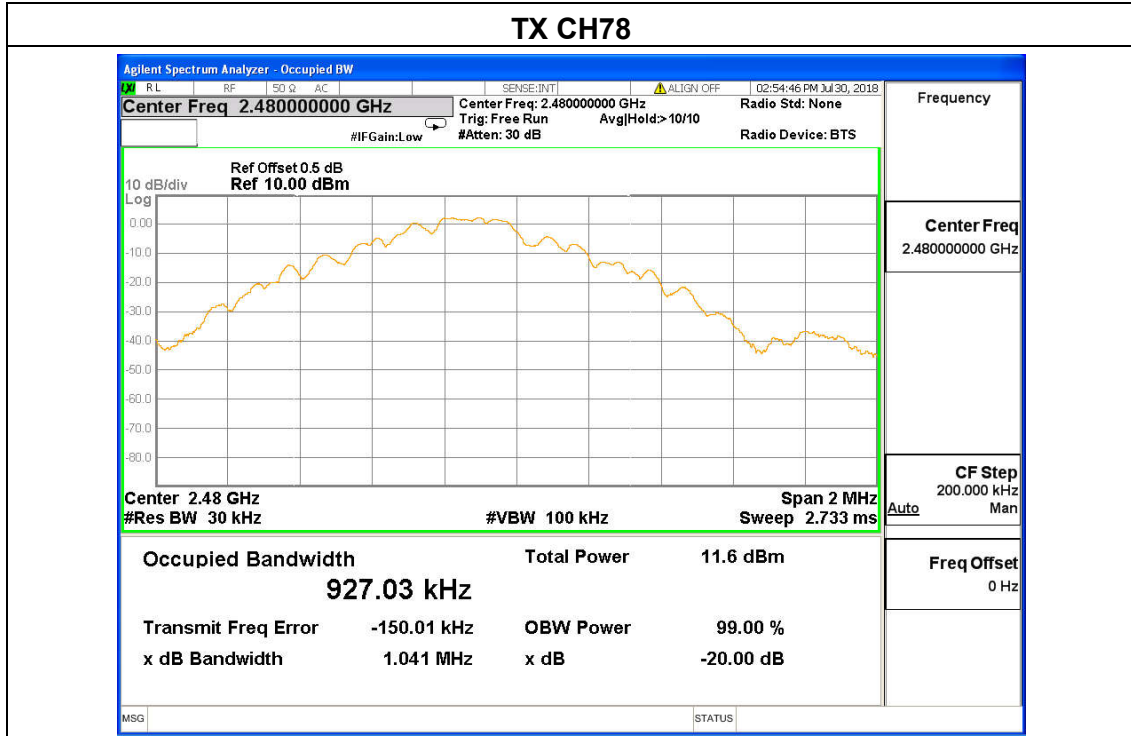

$\pi/4$ -DQPSK

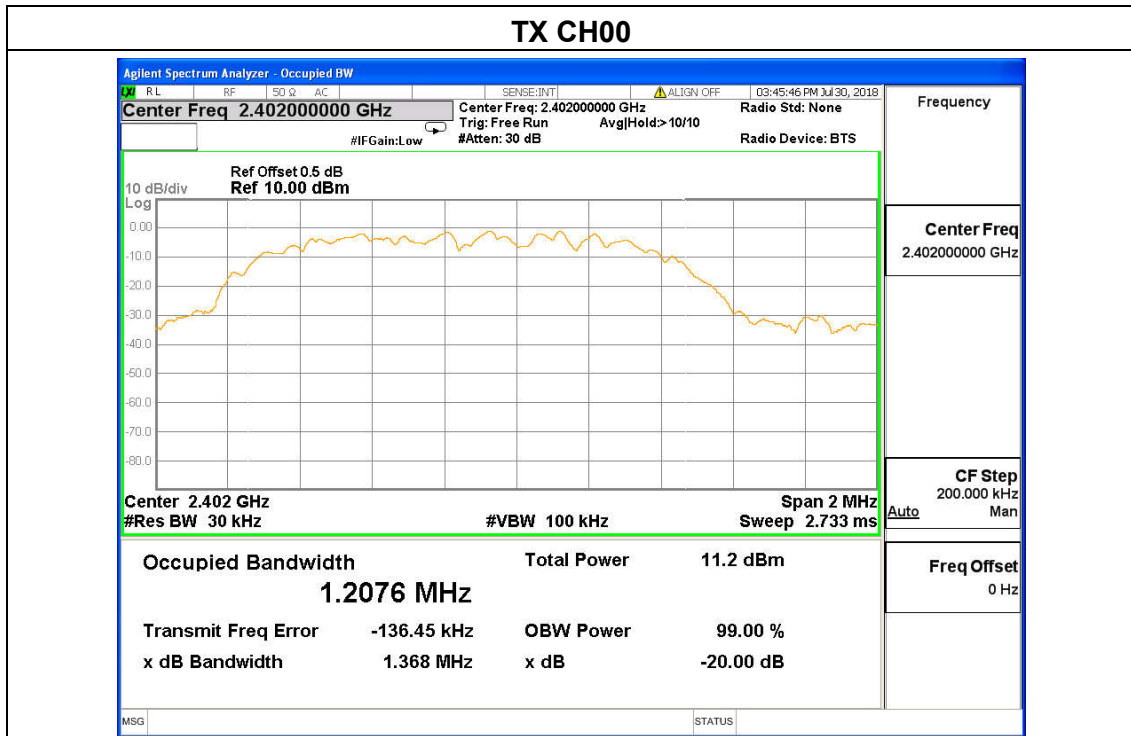

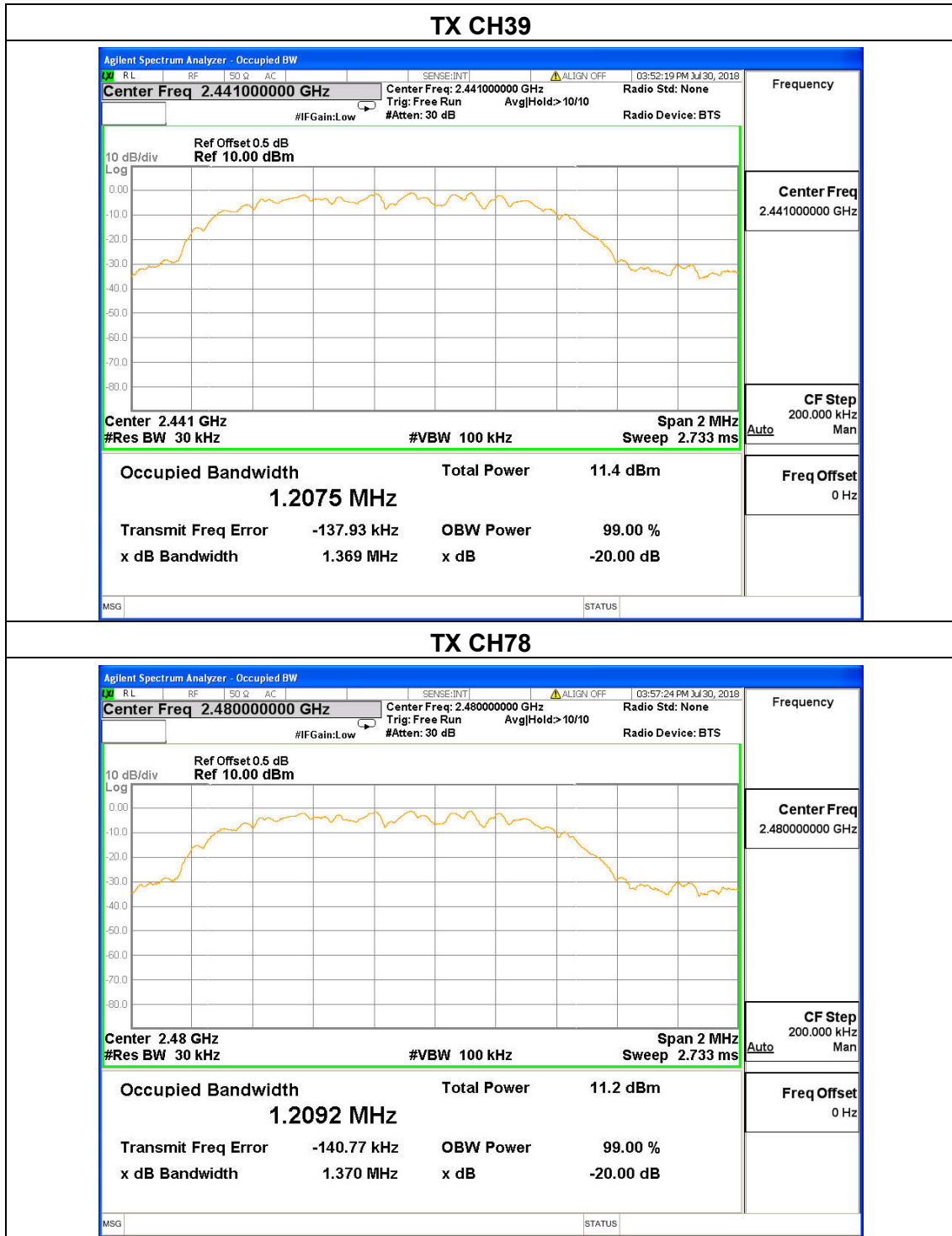

8DPSK mode

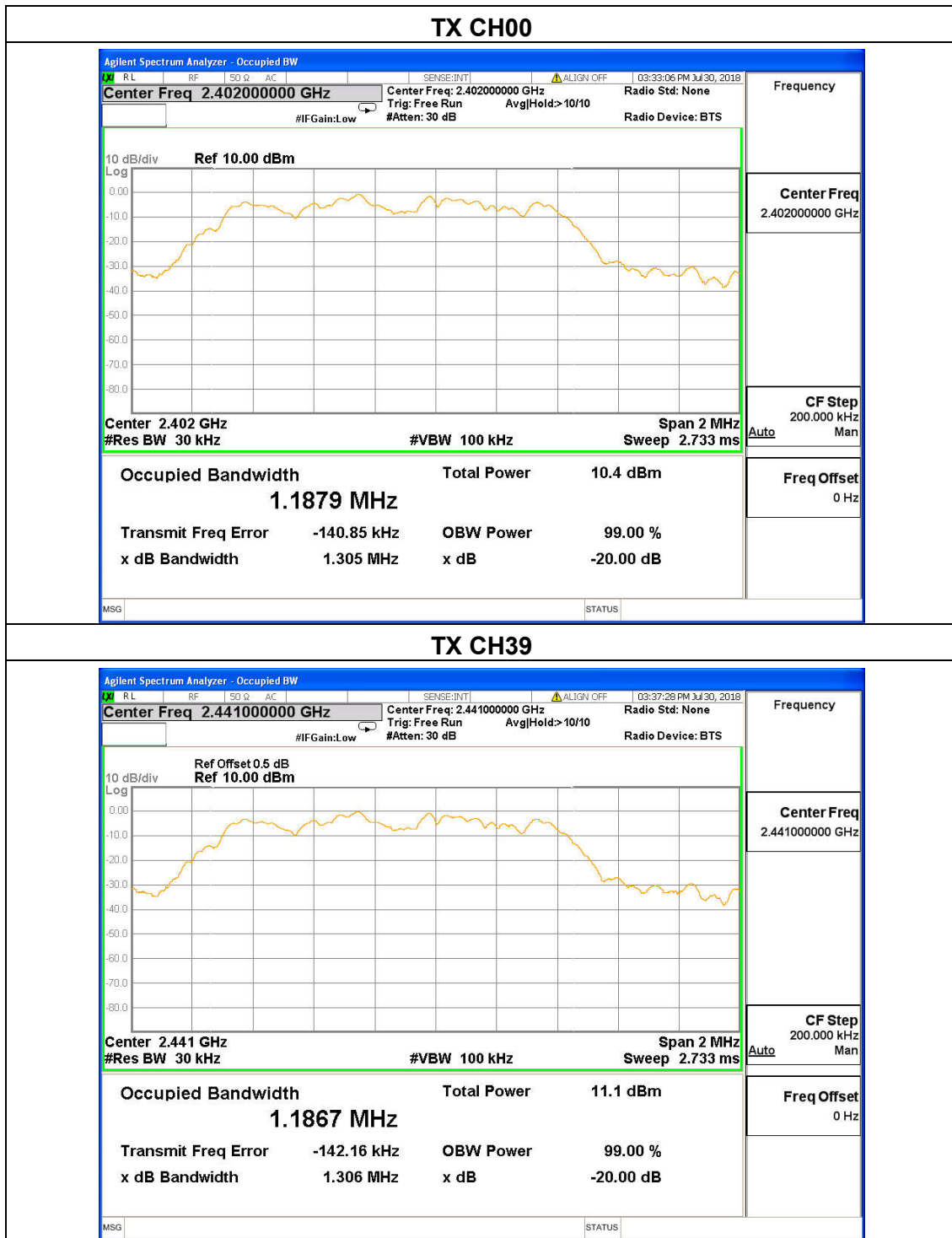

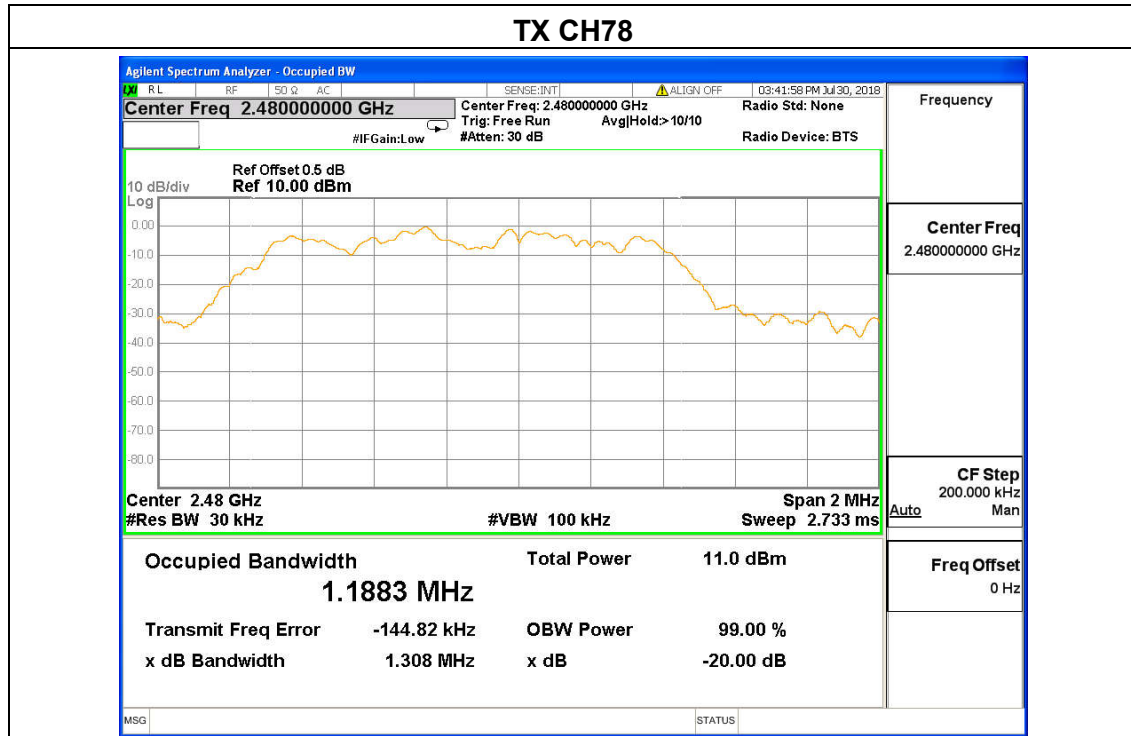

5.6 Carrier frequency separation

5.6.1 Limit

FCC Part15 (15.247) , Subpart C			
Section	Test Item	Limit	Frequency Range (MHz)
15.247(a)(1)	Channel Separation	>25KHz or >two-thirds of the 20 dB bandwidth (Which is greater)	2400-2483.5

5.6.2 Test setup

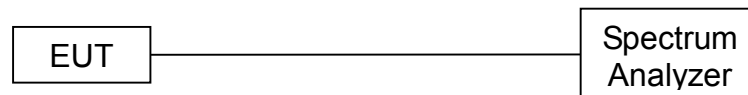

5.6.3 Test procedure

- (1) The EUT was directly connected to the spectrum analyzer and antenna output port as show in the block diagram above.
- (2) Spectrum Setting:
RBW=30 kHz, VBW=100 kHz, detector= Peak, Sweep Time =auto.
- (3) The EUT was set to the Hopping Mode for Channel Separation Test and continuously transmitting for the Test.

5.6.4 Test results

Test data

EUT :	Android AD Player	Model Name :	YF-021H
Temperature :	25 °C	Relative Humidity :	60%
Pressure :	1012 hPa	Test Voltage :	DC 12V from adapter
Test Mode :	GFSK Mode, $\pi/4$ -DQPSK, 8DPSK /CH00, CH39, CH78		

Mode	Channel	Frequency (MHz)	Test Result (KHz)	Limit (kHz)		Result
GFSK	Low	2402	1000	692.000	2/3 of 20dB BW	Pass
	Middle	2441	1000	693.333	2/3 of 20dB BW	Pass
	High	2480	1000	694.000	2/3 of 20dB BW	Pass
$\pi/4$ -DQPSK	Low	2402	1000	912.000	2/3 of 20dB BW	Pass
	Middle	2441	1000	912.667	2/3 of 20dB BW	Pass
	High	2480	1000	913.333	2/3 of 20dB BW	Pass
8DPSK	Low	2402	1000	870.000	2/3 of 20dB BW	Pass
	Middle	2441	1000	870.667	2/3 of 20dB BW	Pass
	High	2480	1000	872.000	2/3 of 20dB BW	Pass

Test plots

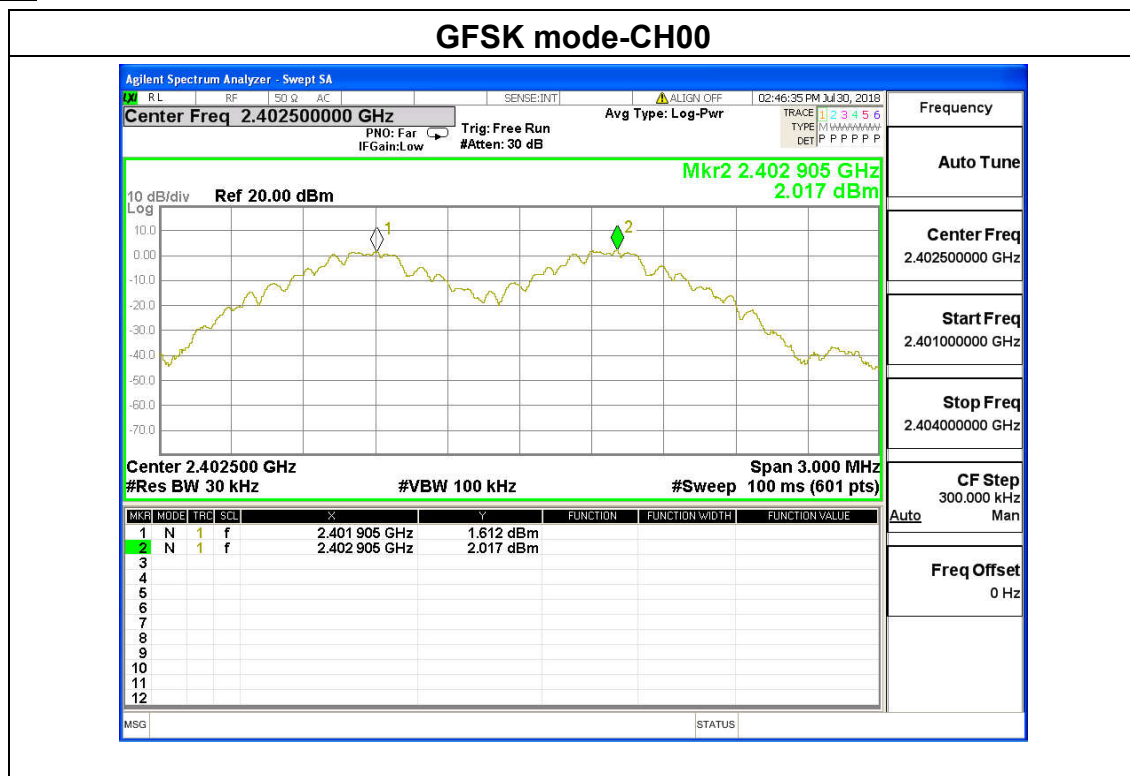

GFSK mode-CH39

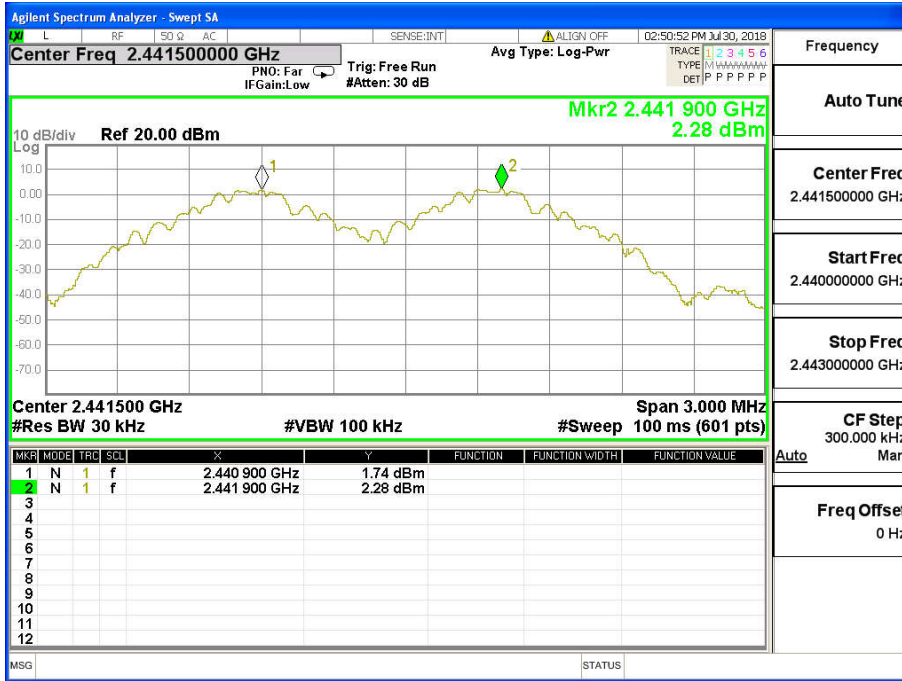

GFSK mode-CH78

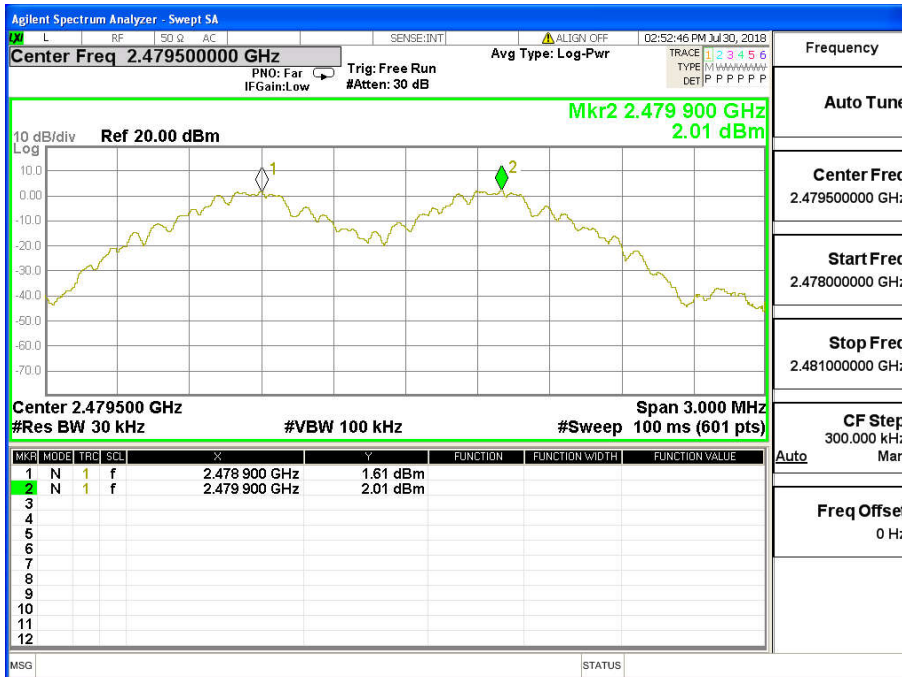

$\pi/4$ -DQPSK mode-CH00

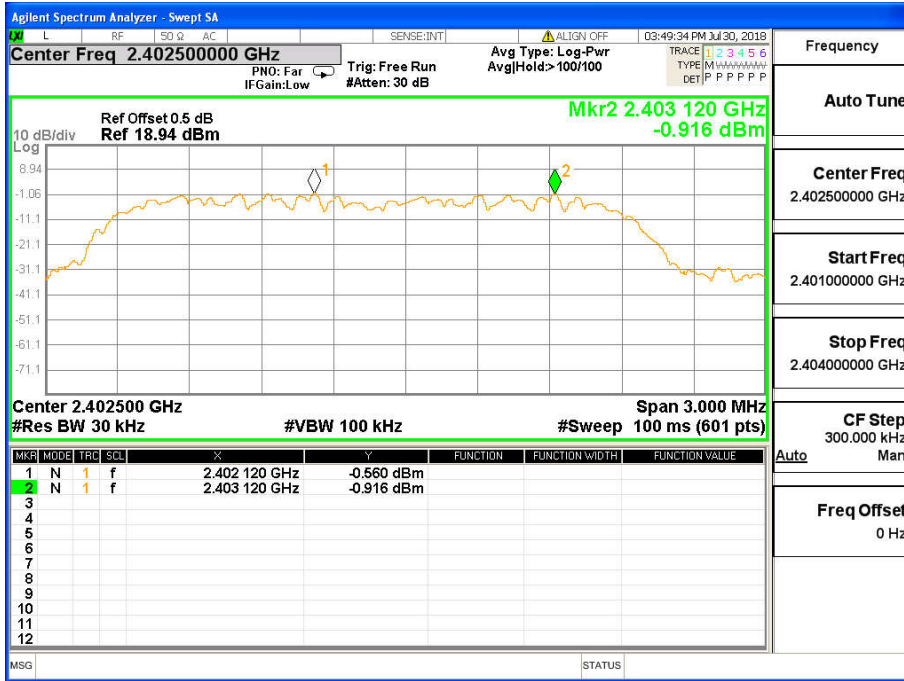

$\pi/4$ -DQPSK mode-CH39

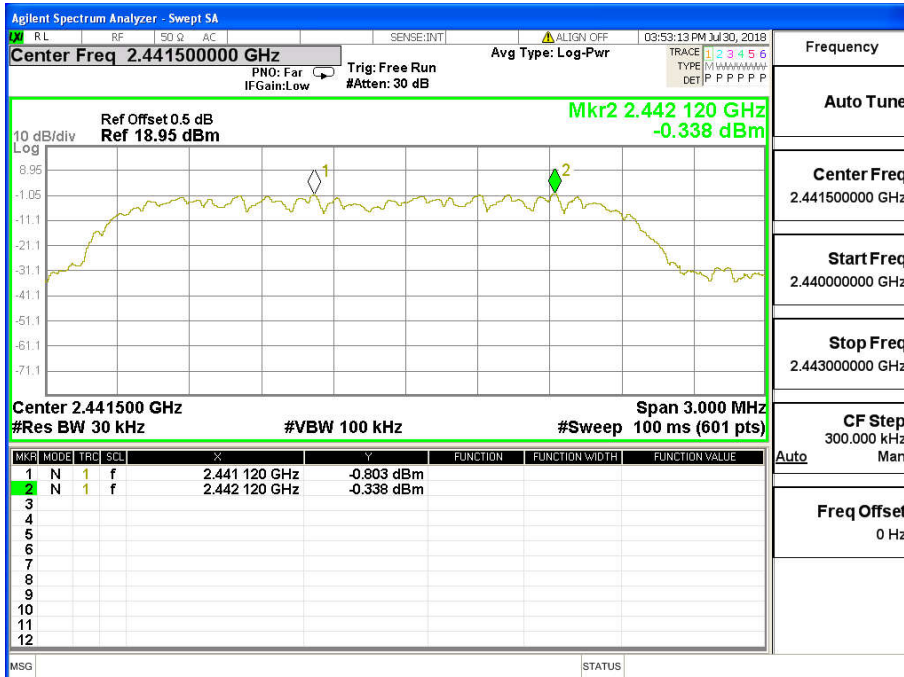

$\pi/4$ -DQPSK mode-CH78

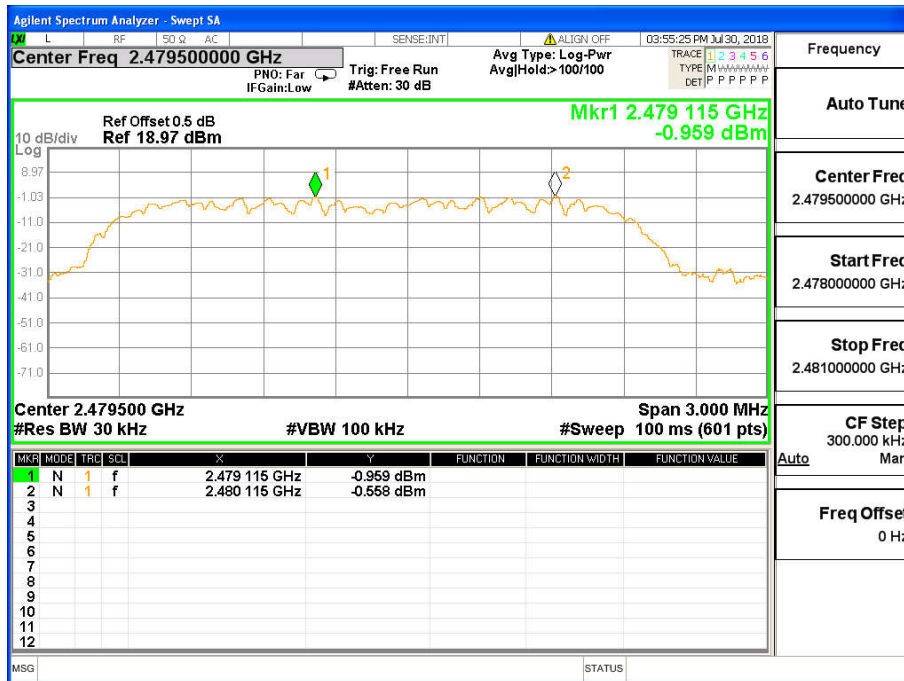

8DPSK mode-CH00

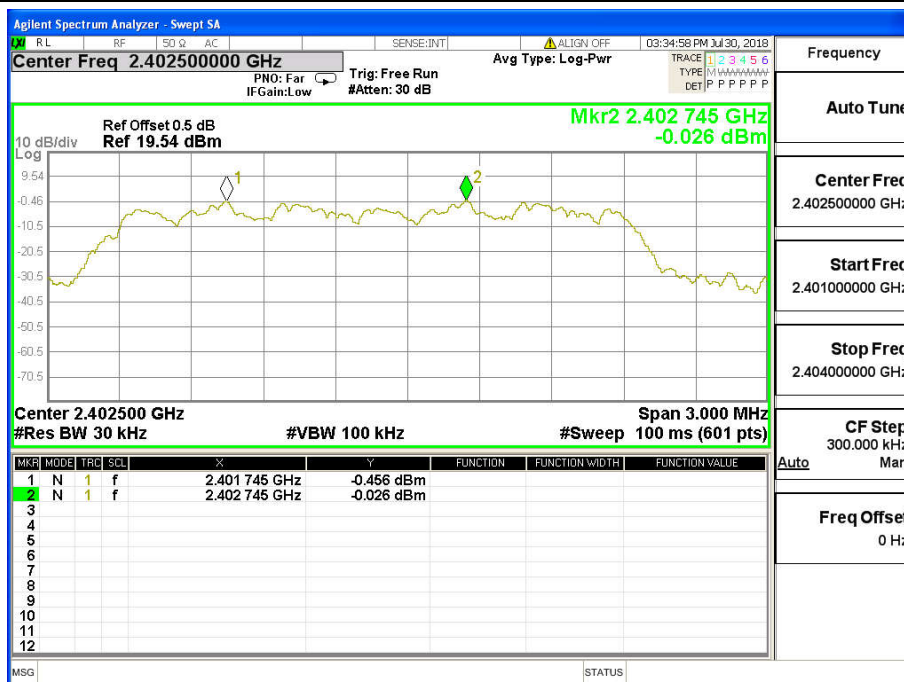

8DPSK mode-39

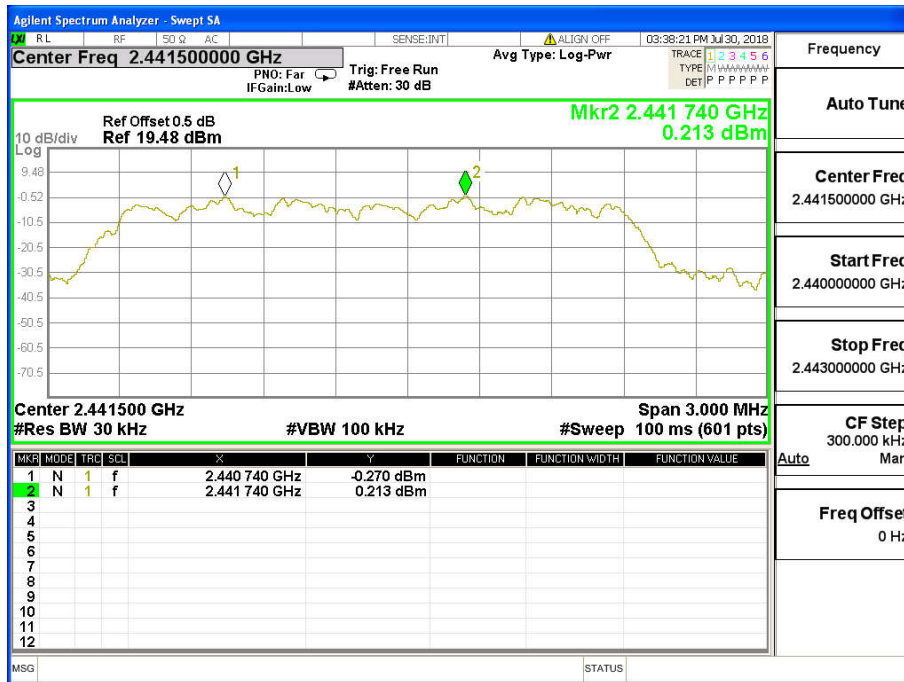

8DPSK mode-CH78

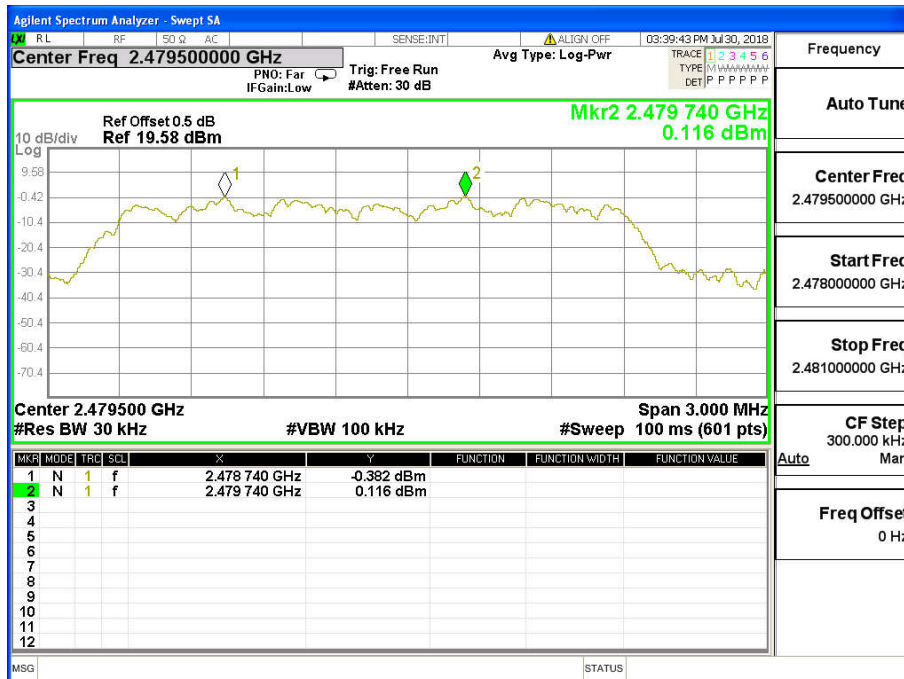

HOPPING CHANNEL

Mode	Quantity of Hopping Channel	Limit	Results
GFSK, $\pi/4$ -DQPSK, 8DPSK	79	>15	Pass

Test plots

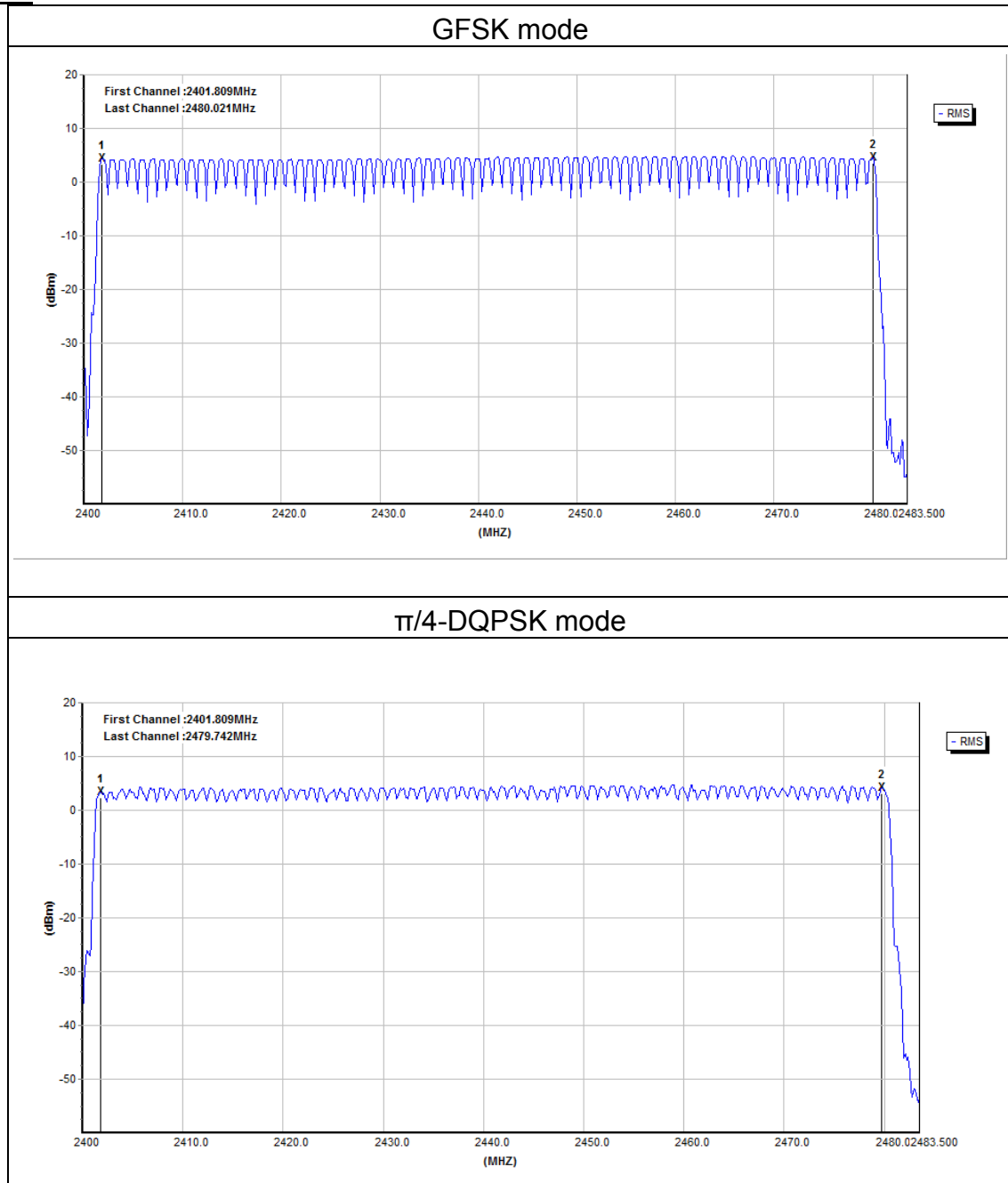

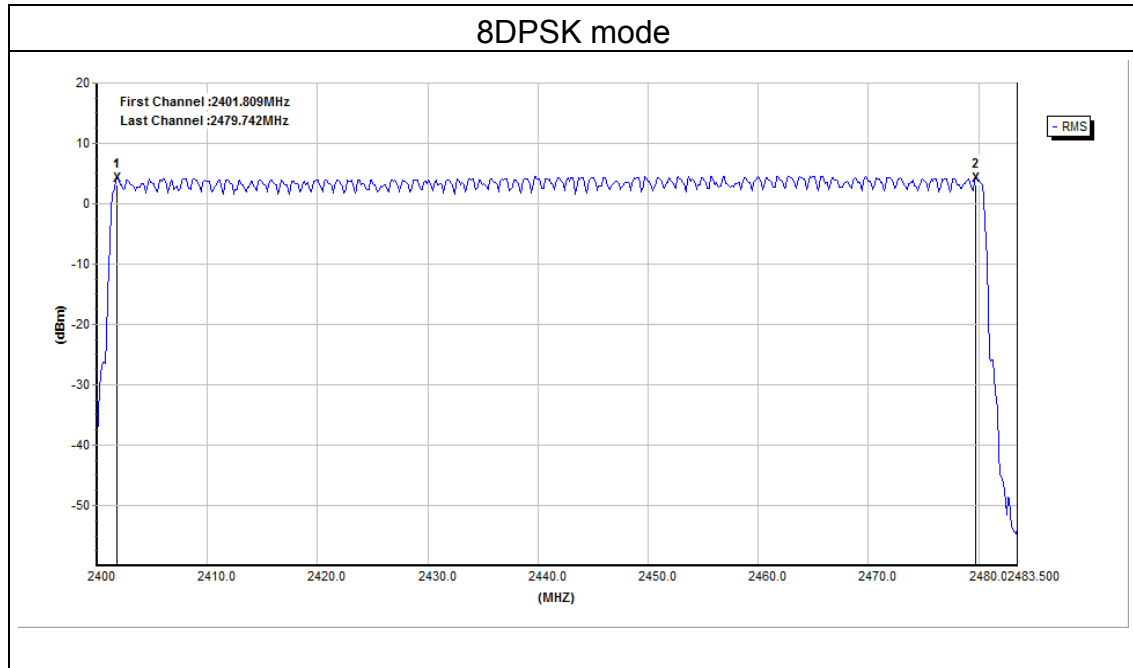

5.7 Dwell time

5.7.1 Limit

FCC Part15 (15.247) , Subpart C			
Section	Test Item	Limit	Frequency Range (MHz)
15.247(a)(a)	Dwell time	0.4 sec	2400-2483.5

5.7.2 Test setup

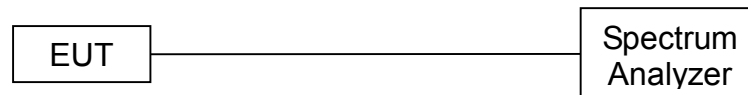

5.7.3 Test procedure

- (1) The EUT was directly connected to the spectrum analyzer and antenna output port as show in the block diagram above.
- (2) Spectrum Setting: RBW=1MHz, VBW=1MHz, Span=0Hz, Detector=Peak
- (3) Use video trigger with the trigger level set to enable triggering only on full pulses.
- (4) Sweep Time is more than once pulse time.
- (5) Set the center frequency on any frequency would be measure and set the frequency span to zero span.
- (6) Measure the maximum time duration of one single pulse.
- (7) Set the EUT for packet transmitting.
- (8) Measure the maximum time duration of one single pulse.
- (9) The EUT was set to the Hopping Mode for Dwell Time Test

5.7.4 Test results

Test data

EUT :	Android AD Player	Model Name :	YF-021H
Temperature :	25 °C	Relative Humidity :	60%
Pressure :	1012 hPa	Test Voltage :	DC 12V from adapter
Test Mode :	GFSK, $\pi/4$ -DQPSK, 8DPSK /CH39		

Mode	Data Packet	Frequency (MHz)	Pulse Duration (ms)	Dwell Time (ms)	Limit(s)	Conclusion
GFSK	DH1	2441	0.40	128.00	<0.4	Pass
	DH3	2441	1.66	265.60	<0.4	Pass
	DH5	2441	2.91	310.40	<0.4	Pass
$\pi/4$ DQPSK	2DH1	2441	0.41	131.20	<0.4	Pass
	2DH3	2441	1.65	264.00	<0.4	Pass
	2DH5	2441	2.91	310.40	<0.4	Pass
8DPSK	3DH1	2441	0.41	131.20	<0.4	Pass
	3DH3	2441	1.66	265.60	<0.4	Pass
	3DH5	2441	2.91	310.40	<0.4	Pass

Note1: A period time = 0.4 (s) * 79 = 31.6(s)

Note2:

DH1 time slot = Pulse Duration * (1600/(2*79)) * A period time

DH3 time slot = Pulse Duration * (1600/(4*79)) * A period time

DH5 time slot = Pulse Duration * (1600/(6*79)) * A period time

Note3: For GFSK, $\pi/4$ -DQPSK and 8DPSK: The test period: T= 0.4 Second/Channel x 79 Channel = 31.6 s

Test plots

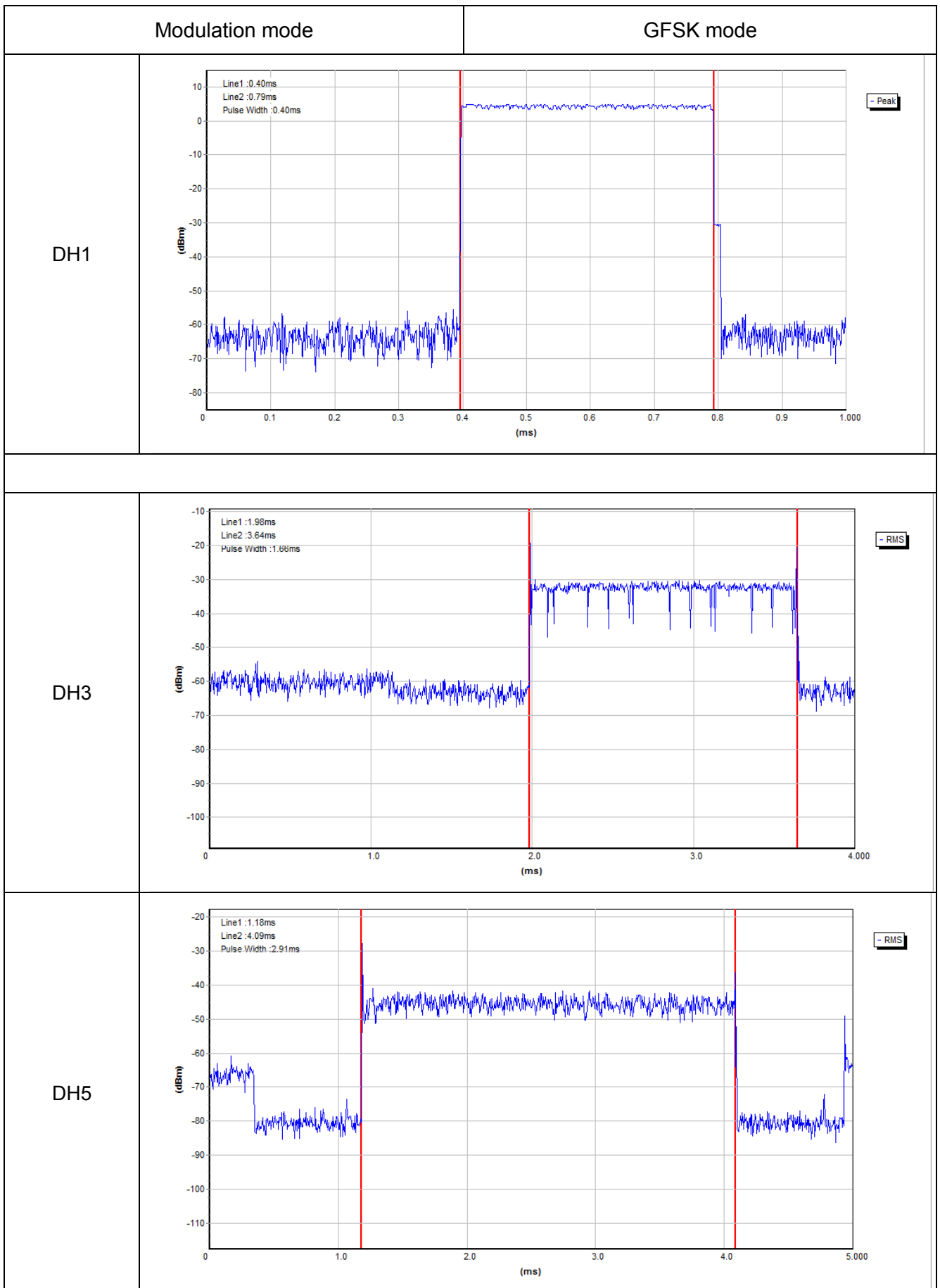

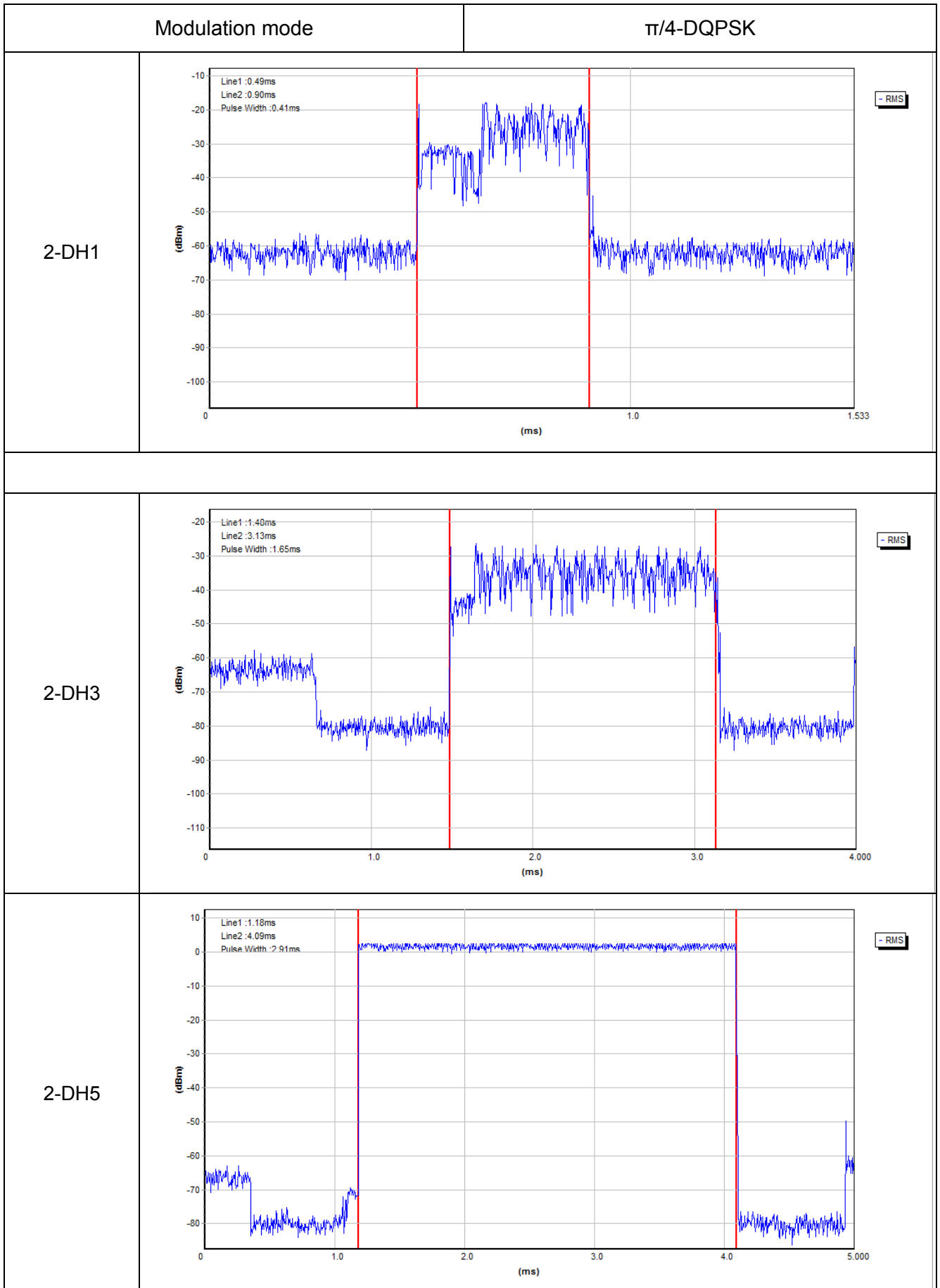

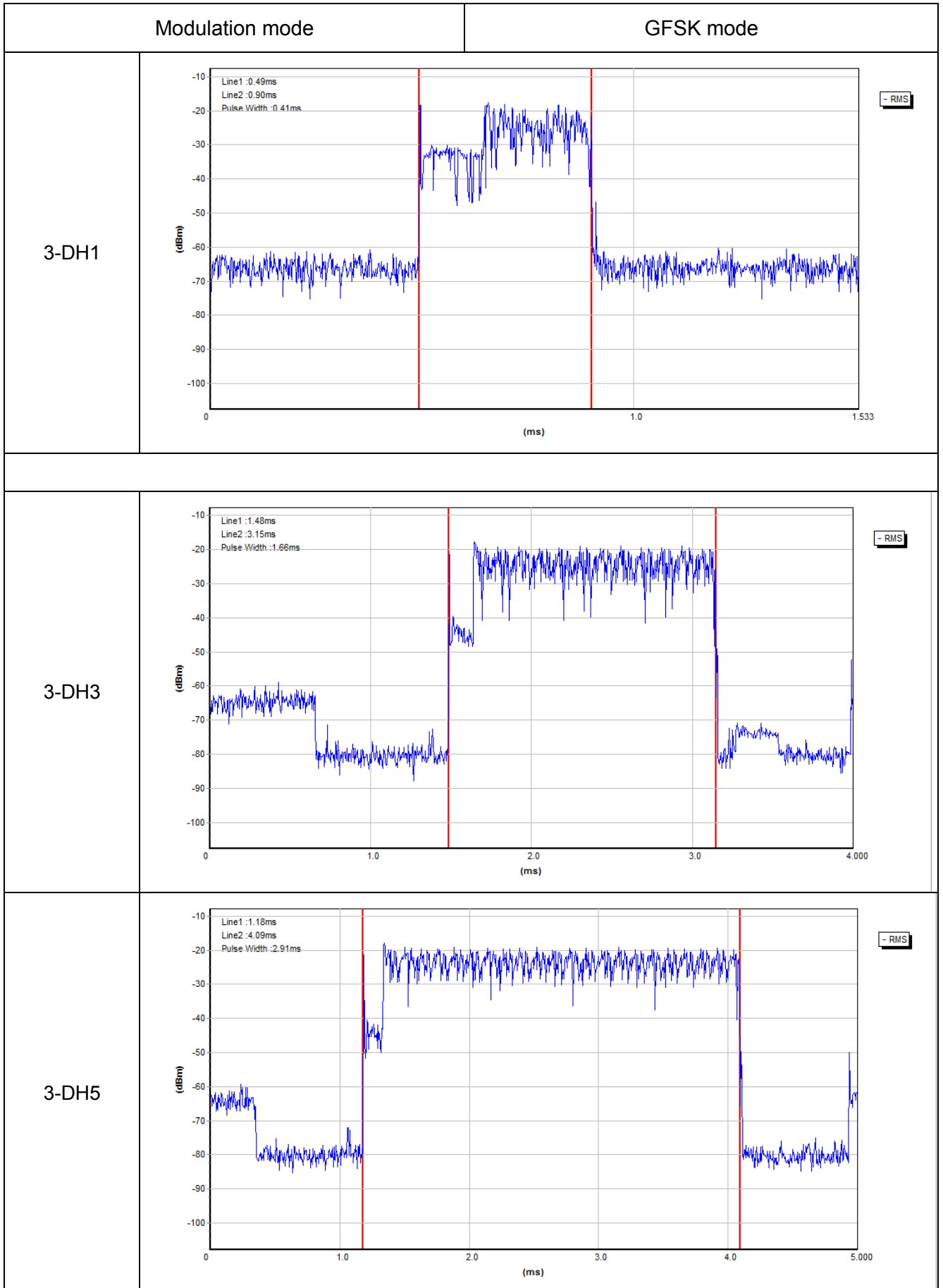

5.8 Conducted spurious emission and bandedge

5.8.1 Limit

In any 100 kHz bandwidth outside the frequency band in which the spread spectrum or digitally modulated intentional radiator is operating, the radio frequency power that is produced by the intentional radiator shall be at least 20 dB below that in the 100 kHz bandwidth within the band that contains the highest level of the desired power, based on either an RF conducted or a radiated measurement, provided the transmitter demonstrates compliance with the peak conducted power limits. If the transmitter complies with the conducted power limits based on the use of RMS averaging over a time interval, as permitted under paragraph (b)(3) of this section, the attenuation required under this paragraph shall be 30 dB instead of 20 dB. Attenuation below the general limits specified in §15.209(a) is not required. In addition, radiated emissions which fall in the restricted bands, as defined in §15.205(a), must also comply with the radiated emission limits specified in §15.209(a) (see §15.205(c)).

5.8.2 Test setup

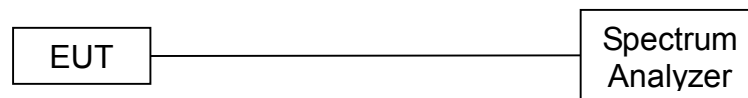

5.8.3 Test procedure

- a) Check the calibration of the measuring instrument using either an internal calibrator or a known signal from an external generator.
- b) Position the EUT without connection to measurement instrument. Turn on the EUT and connect its antenna terminal to measurement instrument via a low loss cable. Then set it to any one measured frequency within its operating range, and make sure the instrument is operated in its linear range.
- c) Set RBW to 100 kHz and VBW of spectrum analyzer to 300 kHz with a convenient frequency span including 100 kHz bandwidth from band edge.
- d) Measure the highest amplitude appearing on spectral display and set it as a reference level. Plot the graph with marking the highest point and edge frequency.
- e) Repeat above procedures until all measured frequencies were complete.

5.8.4 Test results

Test data

EUT :	Android AD Player	Model Name :	YF-021H
Temperature :	25 °C	Relative Humidity :	60%
Pressure :	1012 hPa	Test Voltage :	DC 12V from adapter

Test plots

GFSK: Band Edge, Left Side

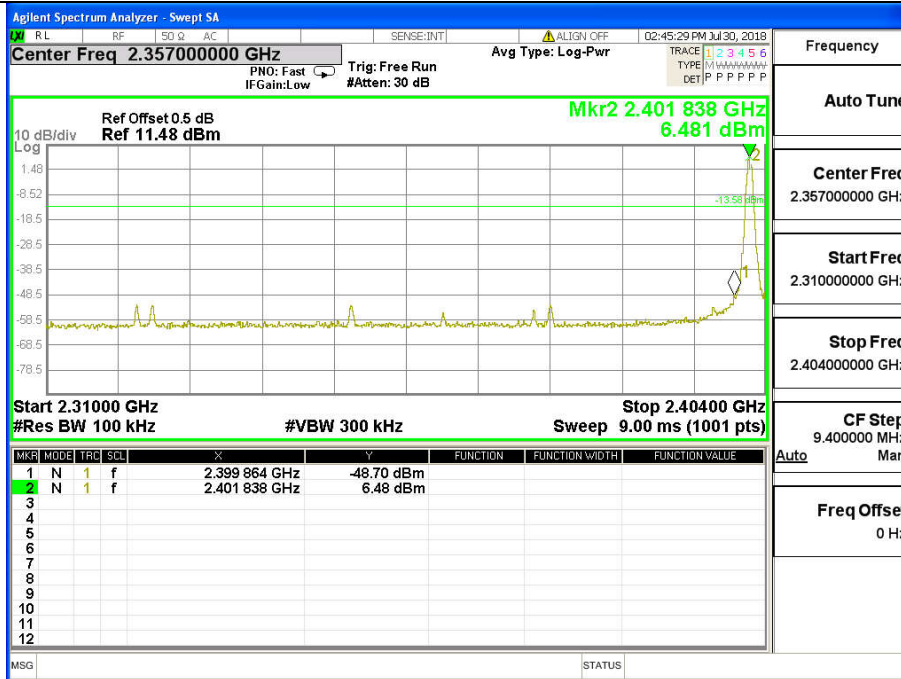

GFSK: Band Edge, Right Side

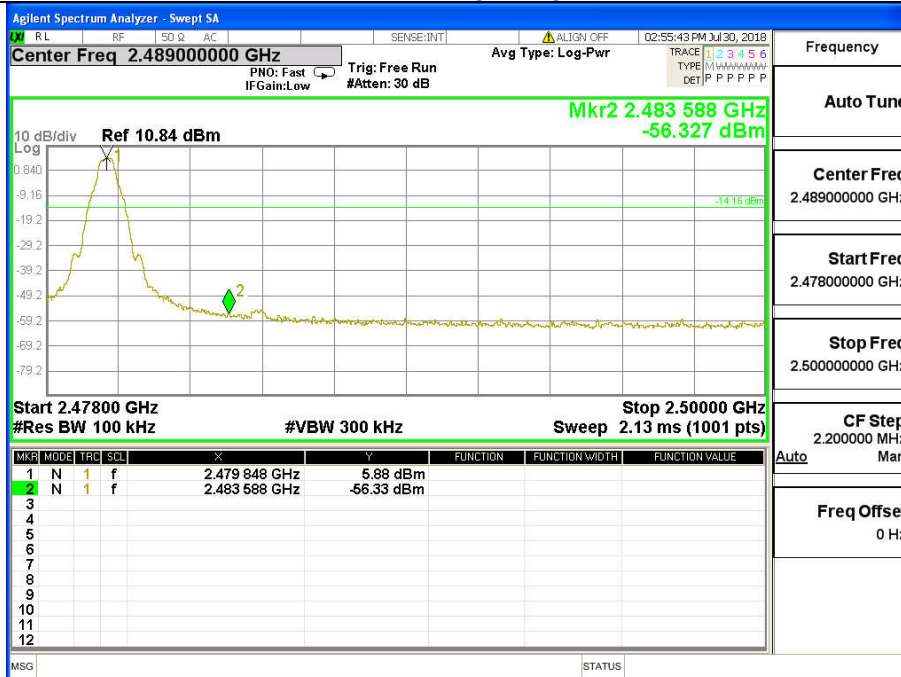

$\pi/4$ -DQPSK: Band Edge, Left Side

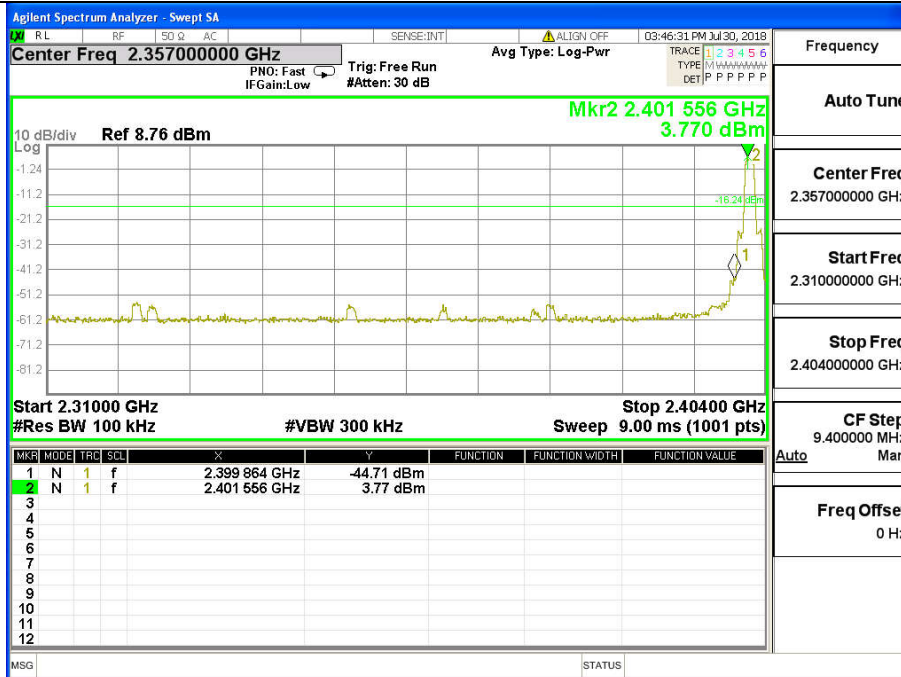

$\pi/4$ -DQPSK: Band Edge, Right Side

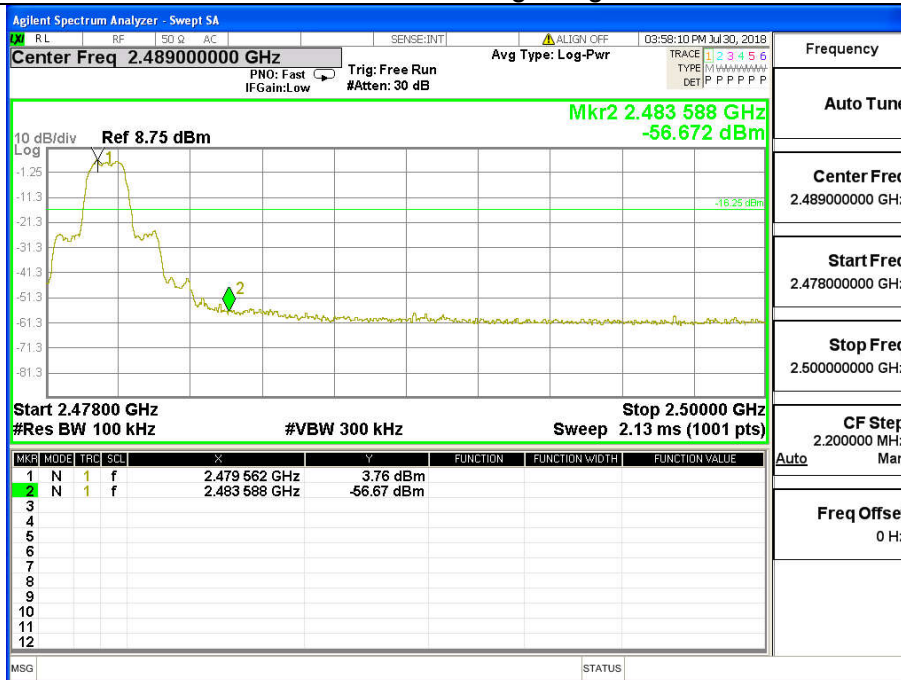

8DPSK: Band Edge, Left Side

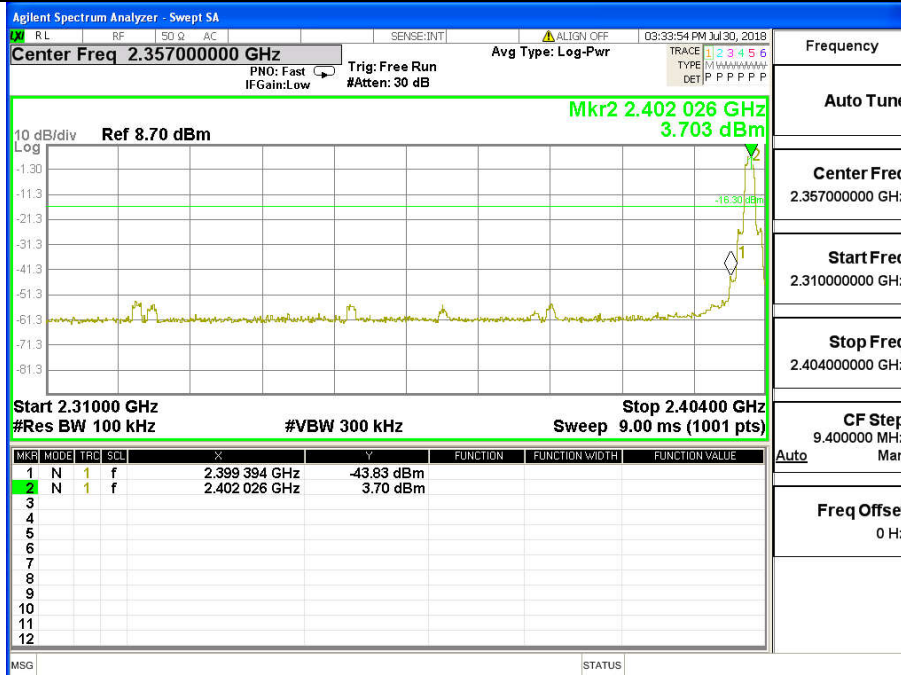

8DPSK: Band Edge, Right Side

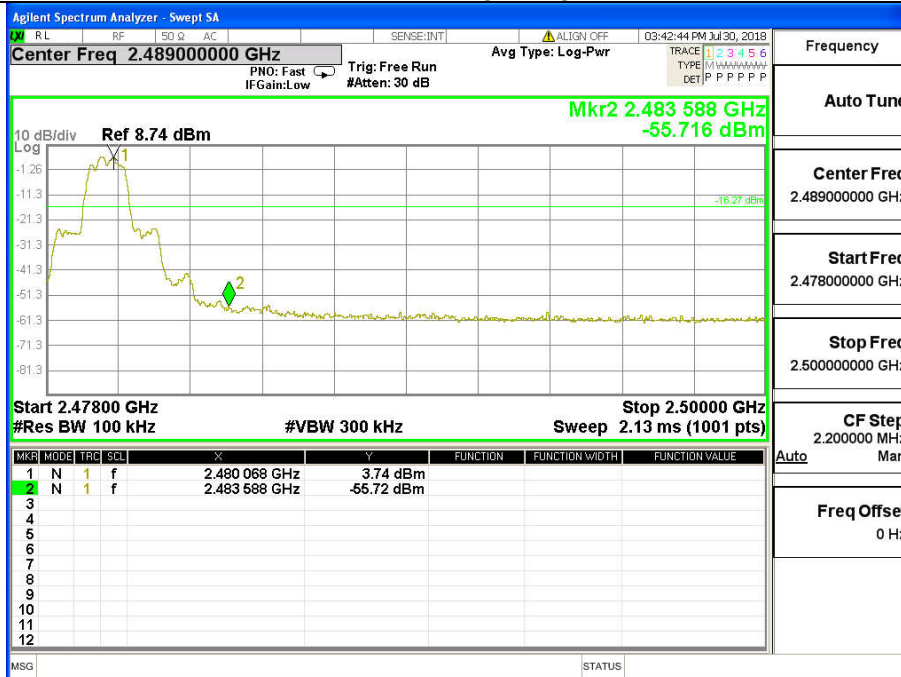

Hopping Mode
Test plots

GFSK: Band Edge, Left Side

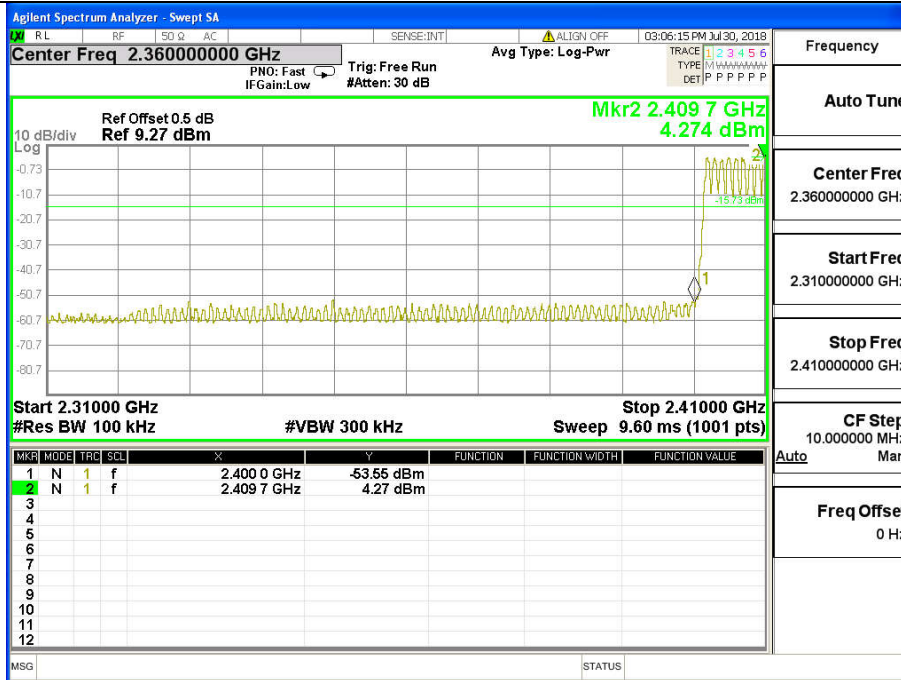

GFSK: Band Edge, Right Side

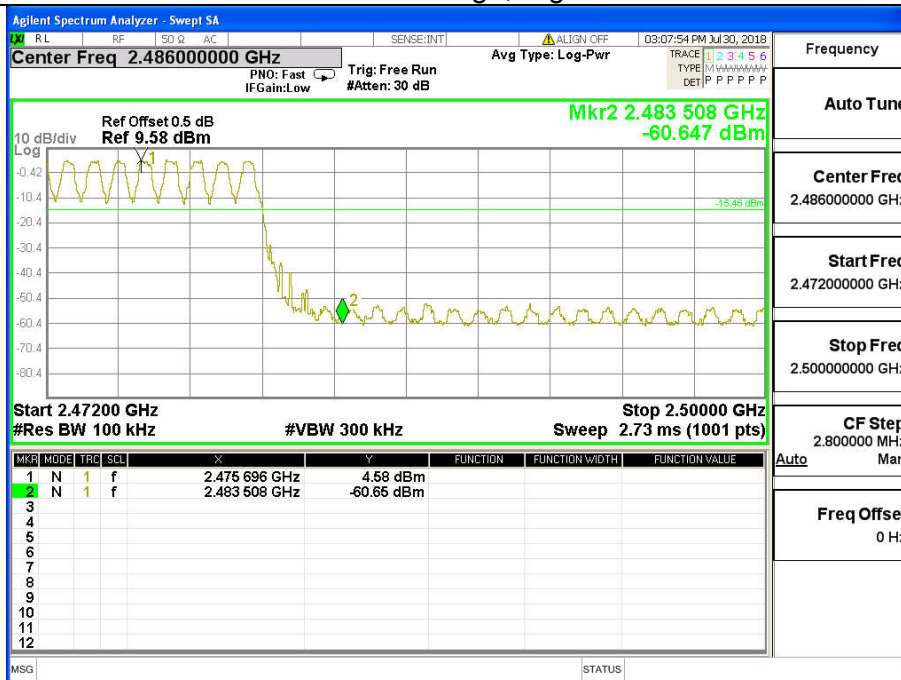

$\pi/4$ -DQPSK: Band Edge, Left Side

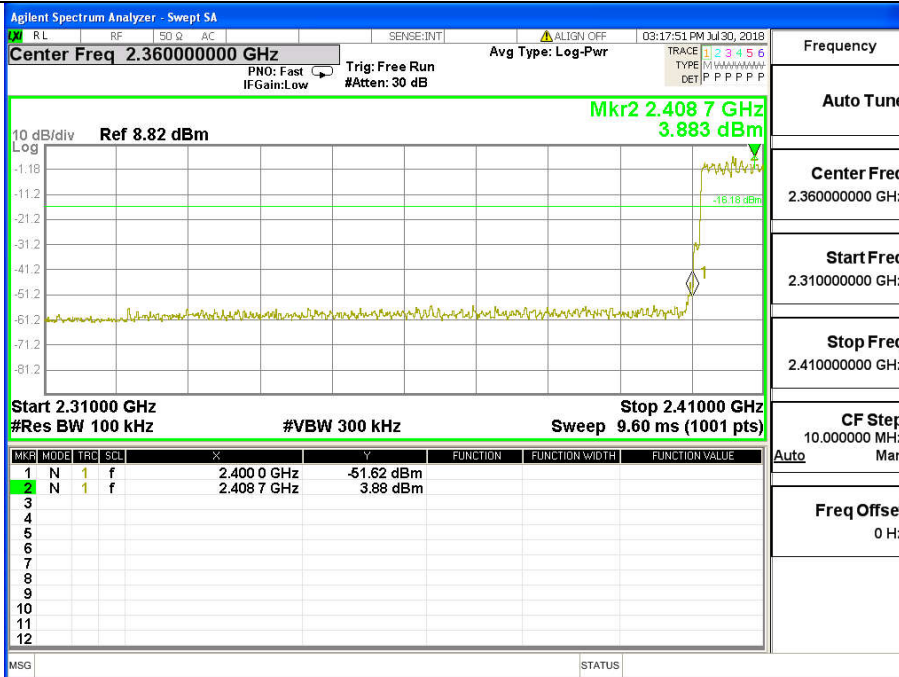

$\pi/4$ -DQPSK Band Edge, Right Side

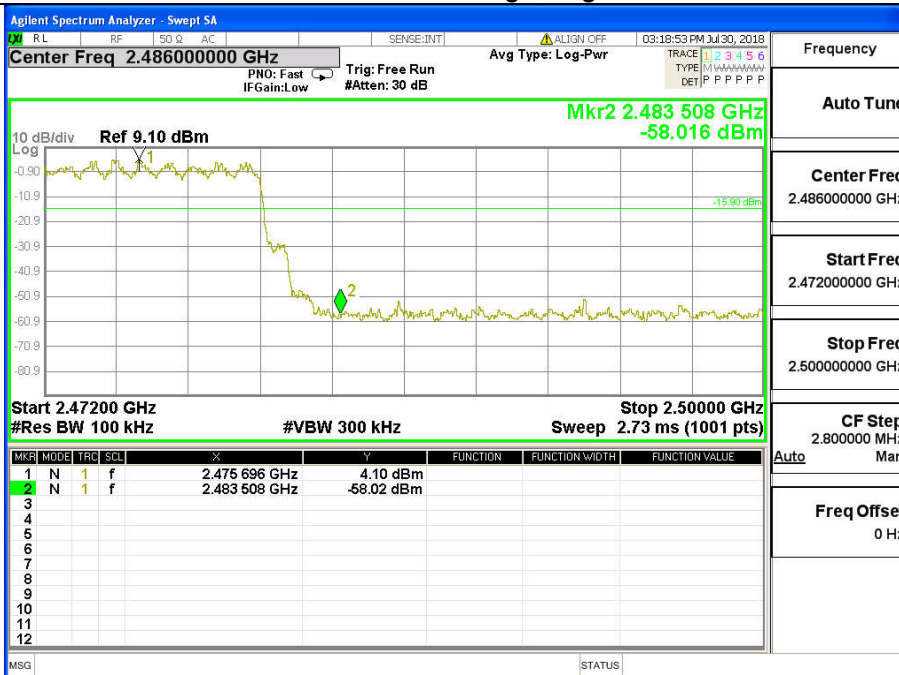

8DPSK: Band Edge, Left Side

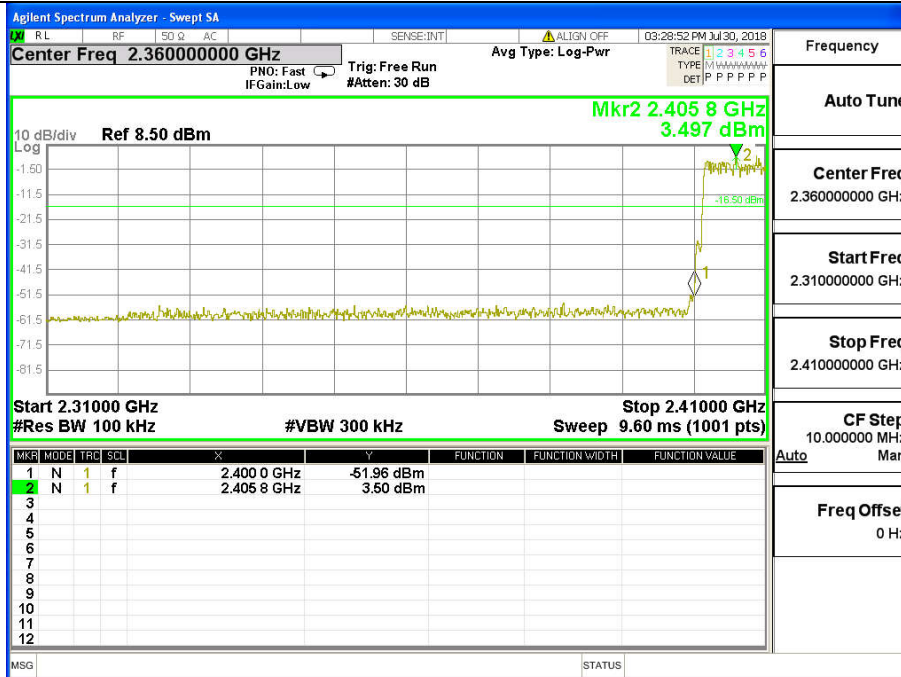

8DPSK Band Edge, Right Side

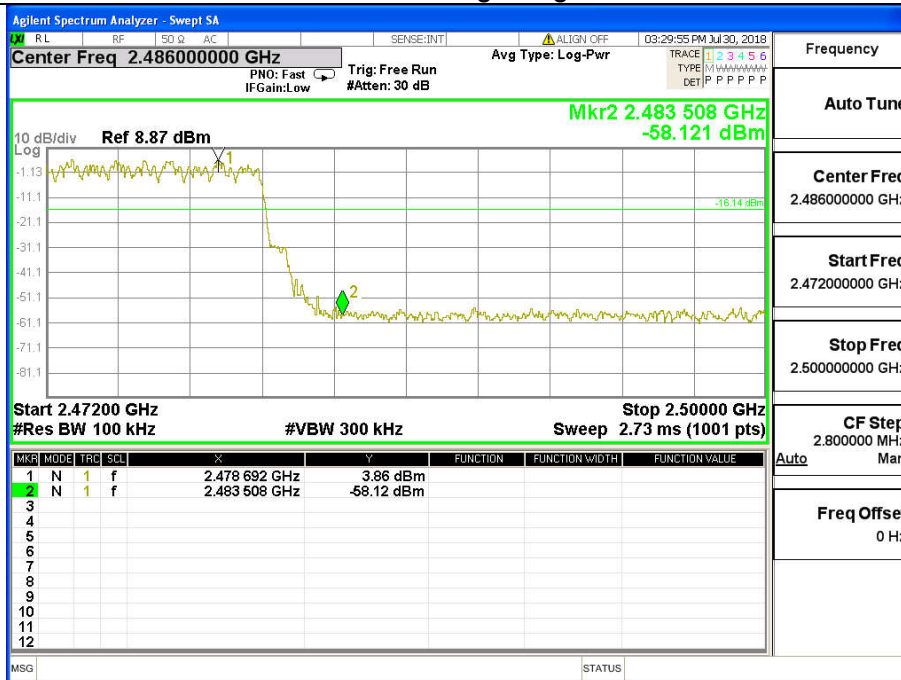

Photographs of the Test Setup

Radiated emission

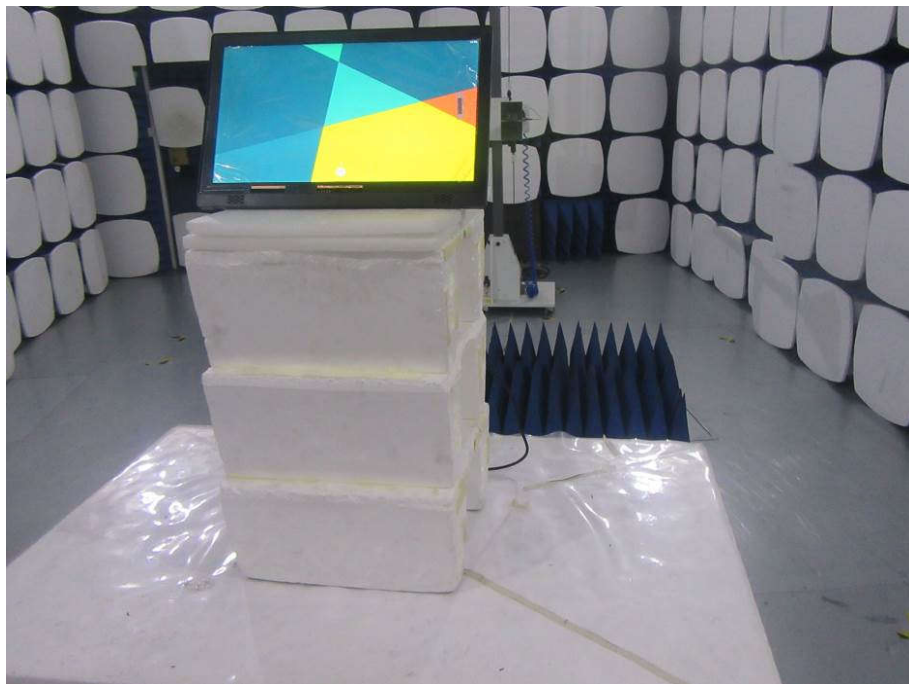
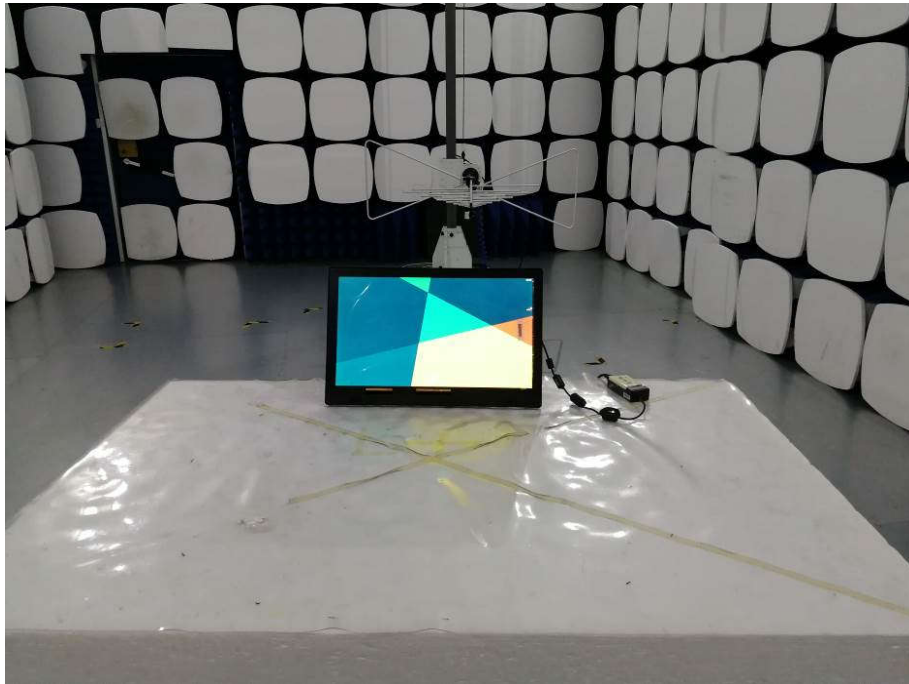

Conducted emission



PHOTOGRAPHS OF THE EUT

See the APPENDIX 1: EUT PHOTO in the report No.: MTi180806E019-1.

----END OF REPORT----