

技术参数

台灯色温	冷光 5500K±500K	暖光 3000K±280K	自然光 4200K±400K
工作电压	12V	调光	五级触控调光
产品照度	>1000LUX	功率	9W
显指	>80Ra	光通量	>400Lm

产品售后服务保证卡

适用范围:

- * 本产品自购买日起,正常使用情况下保证一年免费服务,若超过保质期将收取一定零件成本费用。
- * 如需更换零件的服务,依照本公司服务零件检修价目表收费。
- * 在下列情况时,虽然在有效保证期间内,恕不免费保证。
 - 1.因天灾地震、鼠祸公害、未正常使用所导致故障或损坏的。
 - 2.购买后的运送、移动落下、保存不当等所造成的故障或损坏。
 - 3.损耗品如零件、灯珠等。
 - 4.保证书信息记录不完全,未填入购买日期、无购买盖章的。
 - 5.特殊环境不保修,如潮湿、硫磺区、海边高盐分及船上等易腐蚀地区。
 - 6.未按照使用说明使用者。
 - 7.特殊约定销售的产品。
- * 产品返厂维修时,送修时应自行妥善包装维修品,以免在运送途中造成损害。
- * 自行拆装产品导致的产品故障,制造方概不负责。

重要!
感谢您购买本产品。
为保证您的权益,请妥善填写,谢谢!

姓名	
地址	
电话	
发票号码	
购买日期	
产品型号	
经销商	ⓘ 本栏请加盖经销商印章。
注意 *请妥善保留您的产品保证书,保修期间出示核对	
注意事项	

- * 请勿自行拆解产品,以免触电。
- * 请依照制造商指定专用适配器及电源插座使用,以维持产品正常使用。
- * 请勿过度调节产品的活动关节部分,以免灯具关节功能损坏。
- * 使用时请勿将产品置于不稳固的桌面,以免产品掉落损坏。
- * 请勿将产品置于高温或高温度的地方。
- * 为避免造成眼睛伤害,请不要直视LED灯光源。
- * 遇下列状况时,请先拔掉电源线,停止使用。
 - * 电源线或电源插头损坏或破损时。
 - * 本灯座受潮或淋到雨。
 - * 本灯座外壳、活动关节处有损坏时。
 - * 本灯座发生冒烟、火花等安全因素。
- * LED灯珠异常闪烁或损坏时。

U13Q 无线充智能台灯 使用说明书

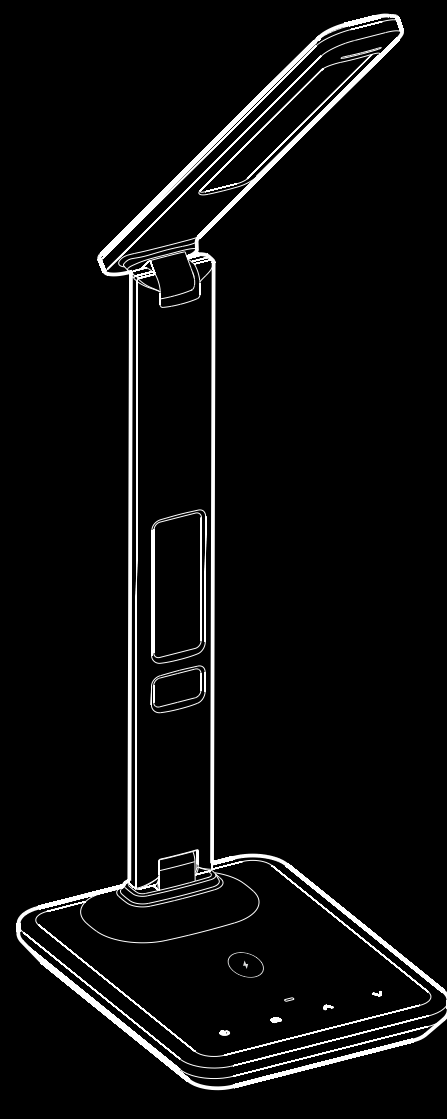

使用前请仔细阅读

产品功能

- * 智能家居无线充电功能,可以给符合Qi无线充电标准的智能手表和手机等设备进行充电。
- * 高品质生产工艺,经久耐用,通过先进的精密蚀刻技术让塑料材质的皮纹效果更逼真。
- * 触控滑动调光,让触控更优雅、便捷。
- * 五级调光满足您不同的灯光需求。
- * 三种色温模式,为您的生活提供便捷。
- * 万年历功能。

使用说明

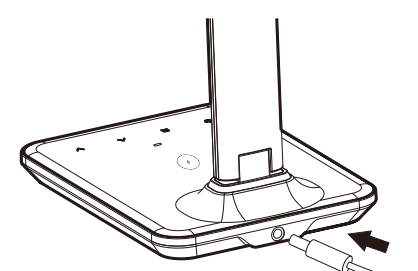

* 将电源适配器DC头插入底座后方的电源插孔内。

【注意】 内附的电源适配器为本产品专用,不能用于其它电器。

灯具照明的正常范围:

- * 灯具前使用范围为90°
- * 在调整灯臂角度时,请同时按压底座。

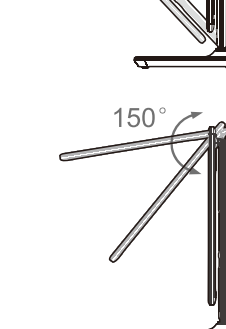

* 灯头可调整范围为150°(过度调节产品的活动关节会导致关节功能损坏)

电池更换

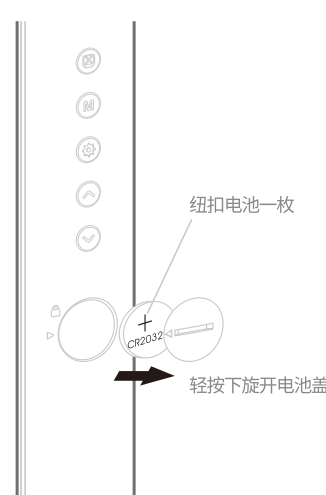

屏幕亮度



* 上电LCD自动点亮,默认为最亮

操作说明

* 台灯按键操作:(如图)



* 万年历闹钟操作说明:(如图)



* 日期和时间的设置

- 1.正常模式下,按设置键启动日期和时间的设置功能,再按一次进入下一个选项的设置设置的顺序为:时-分-年-月-日-退出
- 2.按上调和下调键进行设置,星期会随着日期的变化而自动变化。
- 3.在设置状态下,按模式键或1分钟无操作进入,将退出设置,并即时显示时间。
- 4.在正常状态下,按上调键转换12小时制或24小时制。

* 贪睡功能设置

- 1.正常状态下,按模式键进入闹钟模式
- 2.在闹钟模式下,按设置键进入闹钟设置,再按一下进入下一个选项的设置其顺序为:时-分-贪睡-音乐-退出
- 3.按上调和下调键进行设置。
- 4.在闹钟模式下,按上调和下调键可开启和关闭闹钟和贪睡功能,再按一下启动下一个功能标记。顺序为:开闹钟-开贪睡-关闹钟和贪睡
- 5.当到达闹钟时间时,闹钟将持续1分钟,贪睡时间到时,闹钟会再次响起,按设置键或任意键停止铃声。

* 温度转换

在正常状态下,按下调键以转换摄氏和华氏温度。

无线操作说明

给手机充电,把支持无线充电的手机(Qi标准无线充电设备)放在主机设备中心处平放在上盖,此时主机设备上方的红灯亮起,此时手机会显示充电状态;如果手机没有显示充电状态,请检查您的设备无线充电感应区是否有对准无线充电主机的感应区是否放在相对位置,或者将手机重新放置到感应区,如果没有上述问题请检查手机是否符合(Qi标准的无线充电设备)。

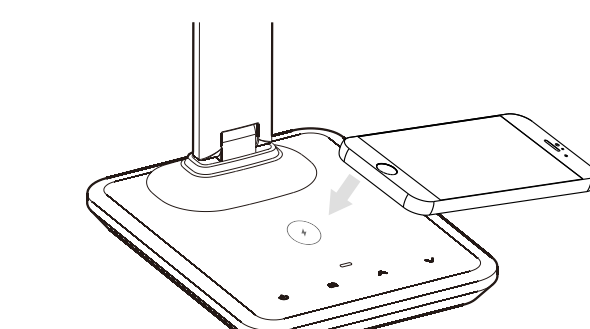

* 主机设备上方的红灯亮起,此时手机也会显示充电状态

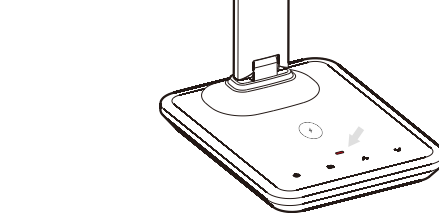

红灯亮起: 充电开始

* 给手机充满电后,绿色LED灯会亮起来,此时手机的电池符号也会显示充满电的状态。(只有自带无线充电功能的手机设备才有充满电指示功能,外加无线接收芯片则无此功能)

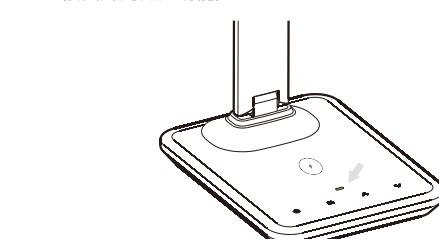

绿灯亮起: 充电完成

FUNCTION

- * Smart wireless charger. it can charge the smart watches and cell phones which is Qi wireless charging standard
- * High quality imitated leather design, can be used for long time. Advanced precision etching technology, to show more realistic imitated leather effect.
- * Touchable sliding for brightness, make it more convenient.
- * 5-grade brightness meet different lighting requirements.
- * 3 color temperature to choose.(Cold light, Warm light, Natural light)
- * Calendar.

USE MANUAL

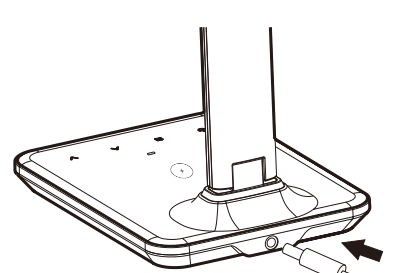

【Notice】 The power supply in the box is only for this lamp, forbid to use in other electrical appliances.

* The range of activity for lamp:

- * Lamp arm can be fold-able to 90°angle
- * Please hold the lamp base when you adjust lamp arm angle

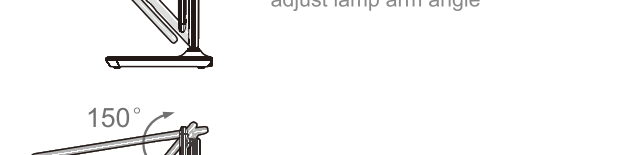

* Lamp head can be fold-able to 150° angle (It may be broken if you over-adjust)

SPECIFICATIONS

Power Supply	12V	Dimming Type	5-grade brightness touch-dimmer
Lamp Illumination	> 1000LUX	Power wattage	9W
CRI	> 80Ra	Luminous Flux	> 400Lm

Lamp Color Temperature: Cold light: 5500K±500K Warm light: 3000K±280K Natural Light: 4200K±400K

Warranty Card

Applicable for

- * Since buying date,the user enjoys one year free repair services under normal use.After one year,will be charged according to each component part cost.
- * In case change component part,will be charged according to our company's component part cost list.
- * The following situations not free repair in warranty period
 - 1)Damage caused by natural earthquake,fall disaster,and unnormal use.
 - 2)Damage caused in transportation,fall,and improper storage.
 - 3)Consumable component,such as spare parts,batteries,light bulbs,etc.
 - 4)Warranty information records is not complete,no purchase date, no buying shop seal,etc.
 - 5)Featured using environment,such as humidity,sulfur area, high salty and the ship,etc.easy corrosion area.
 - 6)Using not according to the instructions.
 - 7)Special offer.
- * When return to factory for repair,the user should make sure the LED lamp packed properly to avoid any damage during transportation.
- * Factory not responsible for the damages caused by the user themselves improper disassemble.

Important
Thank you for purchasing our products.
To guarantee your rights,please fill in this form properly.Thank you

Name	
Address	
Telephone	
Invoice number	
Purchase date	
Item number	
Dealers	ⓘ Note this field requires the dealers seal!
Warning please keep this warranty paper for repair presentation.	
Attention	

- * Do not self-disassemble the product,to avoid any electric shock.
- * Please use supplier's specified adapter and power socket, to maintain normal working
- * Please do not over-adjusting the joint activity parts, to avoid any damage to the lamp.
- * Please do not put the lamps on the unstable desk to avoid the lamps dropping out.
- * Please do not put the lamp into high temperature or high-humidity environment.
- * Please do not look at the LED light source straightly, to avoid your eyes hurt.
- * In case below conditions occur,please pull out the power cord, stop using.
- * If needed,please call for support staff:
 - *The power cord or power plug break
 - *The lamp holder clamp or rain
 - *The shell and joint activities of the lamp holder breaks
 - *The lamp holder smokes or sparks
 - *The abnormal flickering or break of the LED light bulb

U13Q Intelligent wireless charging desk lamp Operation Manual

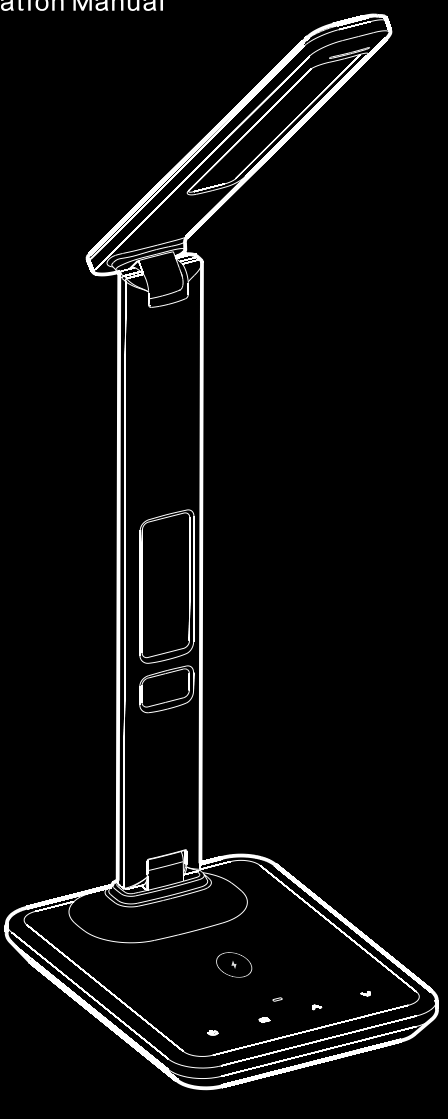

Please read it carefully before using

产品功能

- * 智能家居无线充电功能,可以给符合Qi无线充电标准的智能手表和手机等设备进行充电。
- * 高品质生产工艺,经久耐用,通过先进的精密蚀刻技术让塑料材质的皮纹效果更逼真。
- * 触控滑动调光,让触控更优雅、便捷。
- * 五级调光满足您不同的灯光需求。
- * 三种色温模式,为您的生活提供便捷。
- * 万年历功能。

使用说明

将电源适配器DC头插入底座后方的电源插孔内。

【注意】 内附的电源适配器为本产品专用,不能用于其它电器。

灯具照明的正常范围:

- * 灯具前使用范围为90°
- * 在调整灯臂角度时,请同时按压底座。

灯头可调整范围为150°(过度调节产品的活动关节会导致关节功能损坏)

电池更换

轻按下盖开电池盖

屏幕亮度

* 上电LCD自动点亮,默认为最亮

操作说明

* 台灯按键操作:(如图)

* 万年历闹钟操作说明:(如图)

日期和时间的设置

- 1.正常模式下,按设置键启动日期和时间的设置功能,再按一次进入下一个选项的设置设置的顺序为:时-分-年-月-日-退出
- 2.按上调和下调键进行设置,星期会随着日期的变化而自动变化。
- 3.在设置状态下,按模式键或1分钟无操作进入,将退出设置,并即时显示时间。
- 4.在正常状态下,按上调键转换12小时制或24小时制。

贪睡功能设置

- 1.正常状态下,按模式键进入闹钟模式
- 2.在闹钟模式下,按设置键进入闹钟设置,再按一下进入下一个选项的设置其顺序为:时-分-贪睡-音乐-退出
- 3.按上调和下调键进行设置。
- 4.在闹钟模式下,按上调和下调键可开启和关闭闹钟和贪睡功能,再按一下启动下一个功能标记。顺序为:开闹钟-开贪睡-关闹钟和贪睡
- 5.当到达闹钟时间时,闹钟将持续1分钟,贪睡时间到时,闹钟会再次响起,按设置键或任意键停止铃声。

温度转换

在正常状态下,按下调键以转换摄氏和华氏温度。

无线操作说明

给手机充电,把支持无线充电的手机(Qi标准无线充电设备)放在主机设备中心处平放在上盖,此时主机设备上方的红灯亮起,此时手机会显示充电状态;如果手机没有显示充电状态,请检查您的设备无线充电感应区是否有对准无线充电主机的感应区是否放在相对位置,或者将手机重新放置到感应区,如果没有上述问题请检查手机是否符合(Qi标准的无线充电设备)。

* 主机设备上方的红灯亮起,此时手机也会显示充电状态

红灯亮起: 充电开始

* 给手机充满电后,绿色LED灯会亮起来,此时手机的电池符号也会显示充满电的状态。(只有自带无线充电功能的手机设备才有充满电指示功能,外加无线接收芯片则无此功能)

绿灯亮起: 充电完成

FUNCTION

- * Smart wireless charger. it can charge the smart watches and cell phones which is Qi wireless charging standard
- * High quality imitated leather design, can be used for long time. Advanced precision etching technology, to show more realistic imitated leather effect.
- * Touchable sliding for brightness, make it more convenient.
- * 5-grade brightness meet different lighting requirements.
- * 3 color temperature to choose.(Cold light, Warm light, Natural light)
- * Calendar.

USE MANUAL

Insert the adaptor head into the socket behind the lamp

【Notice】 The power supply in the box is only for this lamp, forbid to use in other electrical appliances.

* The range of activity for lamp:

- * Lamp arm can be fold-able to 90°angle
- * Please hold the lamp base when you adjust lamp arm angle

Lamp head can be fold-able to 150° angle (It may be broken if you over-adjust)

REPLACEMENT BATTERY

Button battery 1pcs

Before you change the battery press the battery case and push down it Then insert 1pcs new battery and close the battery case into right position

DISPLAY SCREEN BRIGHTNESS ADJUSTMENT

- * Once you connect the power adapter the screen will default the highest brightness
- * Then press this key and choose the suitable brightness you like
- * 3 step brightness adjustment

OPERATION GUIDE

Touch operation :(see the drawing)

ON/OFF Light mode UP DOWN

Adjust screen light UP DOWN SET MODE

Calendar and alarm setting

Date and Time setting

- 1.In normal mode,press "set" key to achieve setting functions,press against to move next, sequence: Hour-Minute-Year-Month-Day.
- 2.Press "up" and "down" to setting, week changes automatically when date change.
- 3.In setting mode,press mode or stop operation in one minute to exit setting, and display time.
- 4.In normal mode,press "down" key to switch between"12H"or"24H" display.

Snooze function setting

- 1.In normal mode,press "mode" key to active alarm setting.
- 2.In alarm mode,press "set" key to set the alarm time, sequence: Hour-Minute-Snooze-Music-Exit.
- 3.Press "up"and "down"to setting
- 4.In alarm mode,press "up" and "down" to turn on/off alarm and snooze function, press again to achieve next function, sequence: alarm on- snooze on-alarm off- snooze off
- 5.When come to alarm time, will ring 1 minute, then snooze and ring again. Press any key to off alarm.

Temperature switch

In normal mode,press "down" key to switch between "F" and "C" display.

WIRELESS CHARGING INSTRUCTIONS

Put phone with Qi technical standard on the lamp base surface for charging, once light indicator turns to red and phone screen shows connecting that phone means charging successfully, if phone doesn't show connecting status, please check phone whether put to the wireless charging area correctly, or put phone on the base again, if still no working, kindly check the device whether with Qi technical standard.

* Lamp indicator light in red means that phone is charging status

The red light flashing and start charging

* The green light will light up when mobile phone is full charge . The cell phone battery symbol will also display a full charge state . (Only own function of wireless charging of mobile devices have a state of charge indicator function, there is no this indicator function if the mobile phone is equipped with a receiver when charging)

Green light , the charging is complete

FCC STATEMENT :

This device complies with Part 15 of the FCC Rules. Operation is subject to the following two conditions:

- (1) This device may not cause harmful interference, and
- (2) This device must accept any interference received, including interference that may cause undesired operation.

Warning: Changes or modifications not expressly approved by the party responsible for compliance could void the user's authority to operate the equipment.

NOTE: This equipment has been tested and found to comply with the limits for a Class B digital device, pursuant to Part 15 of the FCC Rules. These limits are designed to provide reasonable protection against harmful interference in a residential installation. This equipment generates uses and can radiate radio frequency energy and, if not installed and used in accordance with the instructions, may cause harmful interference to radio communications. However, there is no guarantee that interference will not occur in a particular installation. If this equipment does cause harmful interference to radio or television reception, which can be determined by turning the equipment off and on, the user is encouraged to try to correct the interference by one or more of the following measures:

- Reorient or relocate the receiving antenna.

- Increase the separation between the equipment and receiver.

- Connect the equipment into an outlet on a circuit different from that to which the receiver is connected.

- Consult the dealer or an experienced radio/TV technician for help.

FCC Radiation Exposure Statement:

This equipment complies with FCC radiation exposure limits set forth for an uncontrolled environment. This equipment should be installed and operated with minimum distance 20cm between the radiator & your body.