

FCC and ISED Test Report

PervasID

Flow Ranger, Model: FR 9380 (8-port FCC)

In accordance with FCC 47 CFR Part 15C, ISED
RSS-247 and ISED RSS-GEN
(RFID)

Prepared for: PervasID
St John's Innovation Centre, Cowley Road
Cambridge, CB4 0WS
UNITED KINGDOM

FCC ID: 2AQQWFR9380 IC: 24482-FR9380

COMMERCIAL-IN-CONFIDENCE

Document 75954042-02 Issue 01



Add value.
Inspire trust.

SIGNATURE

NAME	JOB TITLE	RESPONSIBLE FOR	ISSUE DATE
Matthew Russell	Senior Engineer (RF)	Authorised Signatory	15 September 2022

Signatures in this approval box have checked this document in line with the requirements of TÜV SÜD document control rules.

ENGINEERING STATEMENT

The measurements shown in this report were made in accordance with the procedures described on test pages. All reported testing was carried out on a sample equipment to demonstrate limited compliance with FCC 47 CFR Part 15C, ISED RSS-247 and ISED RSS-GEN. The sample tested was found to comply with the requirements defined in the applied rules.

RESPONSIBLE FOR	NAME	DATE	SIGNATURE
Testing	Graeme Lawler	15 September 2022	
Testing	Nandhini Mathivanan	15 September 2022	
Testing	Neil Rousell	15 September 2022	

FCC Accreditation
90987 Octagon House, Fareham Test Laboratory

ISED Accreditation
12669A Octagon House, Fareham Test Laboratory

EXECUTIVE SUMMARY

A sample of this product was tested and found to be compliant with FCC 47 CFR Part 15C: 2020, ISED RSS-247: Issue 2 (02-2017) and ISED RSS-GEN: and Issue 5 (04-2018) + A2 (02-2021) for the tests detailed in section 1.3.



DISCLAIMER AND COPYRIGHT

This non-binding report has been prepared by TÜV SÜD with all reasonable skill and care. The document is confidential to the potential Client and TÜV SÜD. No part of this document may be reproduced without the prior written approval of TÜV SÜD. © 2022 TÜV SÜD. This report relates only to the actual item/items tested.

ACCREDITATION

Our UKAS Accreditation does not cover opinions and interpretations and any expressed are outside the scope of our UKAS Accreditation. Results of tests not covered by our UKAS Accreditation Schedule are marked NUA (Not UKAS Accredited).

TÜV SÜD
is a trading name of TÜV SÜD Ltd
Registered in Scotland at East Kilbride,
Glasgow G75 0QF, United Kingdom
Registered number: SC215164

TÜV SÜD Ltd is a
TÜV SÜD Group Company

Phone: +44 (0) 1489 558100
Fax: +44 (0) 1489 558101
www.tuvsud.com/en

TÜV SÜD
Octagon House
Concorde Way
Fareham
Hampshire PO15 5RL
United Kingdom



Contents

1	Report Summary	2
1.1	Report Modification Record.....	2
1.2	Introduction.....	2
1.3	Brief Summary of Results	3
1.4	Application Form	4
1.5	Product Information	7
1.6	Deviations from the Standard.....	7
1.7	EUT Modification Record	7
1.8	Test Location.....	8
2	Test Details	9
2.1	AC Power Line Conducted Emissions	9
2.2	Frequency Hopping Systems - Average Time of Occupancy	13
2.3	Frequency Hopping Systems - Channel Separation.....	17
2.4	Frequency Hopping Systems - Number of Hopping Channels	20
2.5	Frequency Hopping Systems - 20 dB Bandwidth	23
2.6	Maximum Conducted Output Power	27
2.7	Conducted Spurious Emissions from the Antenna Port.....	29
2.8	Spurious Radiated Emissions	45
2.9	Authorised Band Edges	63
3	Photographs	68
3.1	Test Setup Photographs	68
4	Measurement Uncertainty	72



1 Report Summary

1.1 Report Modification Record

Alterations and additions to this report will be issued to the holders of each copy in the form of a complete document.

Issue	Description of Change	Date of Issue
1	First Issue	15-September-2022

Table 1

1.2 Introduction

Applicant	PervasID
Manufacturer	PervasID
Model Number(s)	FR 9380 (8-port FCC)
Serial Number(s)	10510422-0074
Hardware Version(s)	V6.4 P0.3 (serial no: 10510422-0074)
Software Version(s)	Reader software – 3_1_0_EX4; R2000 firmware – 3_1_0_EX3; DB firmware – 1_0_1_EX2, Bootloader 512d8e3
Number of Samples Tested	1
Test Specification/Issue/Date	FCC 47 CFR Part 15C: 2020 ISED RSS-247: Issue 2 (02-2017) ISED RSS-GEN: Issue 5 (04-2018) + A2 (02-2021)
Order Number	PO-0519
Date	08-December-2021
Date of Receipt of EUT	04-February-2022
Start of Test	07-February-2022
Finish of Test	23-August-2022
Name of Engineer(s)	Graeme Lawler, Nandhini Mathivanan and Neil Rousell
Related Document(s)	ANSI C63.10 (2013) ANSI C63.4 (2014) KDB 662911 D01 v02r01 KDB 996369 D04 Module Integration Guide v02



1.3 Brief Summary of Results

A brief summary of the tests carried out in accordance with FCC 47 CFR Part 15C, ISED RSS-247 and ISED RSS-GEN is shown below.

Section	Specification Clause			Test Description	Result	Comments/Base Standard
	Part 15C	RSS-247	RSS-GEN			
Configuration and Mode: RFID Transceiver						
2.1	15.207	3.1	8.8	AC Power Line Conducted Emissions	Pass	
2.2	15.247 (a)(1)	5.1	-	Frequency Hopping Systems - Average Time of Occupancy	Pass	
2.3	15.247 (a)(1)	5.1	-	Frequency Hopping Systems - Channel Separation	Pass	
2.4	15.247 (a)(1)	5.1	-	Frequency Hopping Systems - Number of Hopping Channels	Pass	
2.5	15.247 (a)(1)	5.1	6.7	Frequency Hopping Systems - 20 dB Bandwidth	Pass	
2.6	15.247 (b)	5.4	6.12	Maximum Conducted Output Power	Pass	
2.7	15.247 (d) and 15.209	3.3 and 5.5	6.13 and 8.9	Conducted Spurious Emissions from the Antenna Port	Pass	
2.8	15.247 (d) and 15.209	3.3 and 5.5	6.13 and 8.9	Spurious Radiated Emissions	Pass	
2.9	15.247 (d)	5.5	-	Authorised Band Edges	Pass	

Table 2



1.4 Application Form

Equipment Description

Technical Description: <i>(Please provide a brief description of the intended use of the equipment including the technologies the product supports)</i>	UHF RFID Distributed Antenna System - intended use detection and monitoring of UHF RFID tags	
Manufacturer:	PervasID Ltd	
Model:	FR 9380 (8-port FCC)	
Part Number:	N/A	
Hardware Version:	V6.4 P0.3 (serial no: 10510422-0074)	
Software Version:	Reader software – 3_1_0_EX4; R2000 firmware – 3_1_0_EX3; DB firmware – 1_0_1_EX2, Bootloader 512d8e3	
FCC ID of the product under test – see guidance here	2AQQWFR9380	
IC ID of the product under test – see guidance here	24482-FR9380	

Table 3

Intentional Radiators

Technology	ISM (RFID)					
Frequency Range (MHz to MHz)	902 - 928					
Conducted Declared Output Power (dBm)	33					
Antenna Gain (dBi)	8.5					
Supported Bandwidth(s) (MHz) (e.g. 1 MHz, 20 MHz, 40 MHz)						
Modulation Scheme(s) (e.g. GFSK, QPSK etc)	PR-ASK					
ITU Emission Designator (see guidance here) (not mandatory for Part 15 devices)	TBD					
Bottom Frequency (MHz)	902.75					
Middle Frequency (MHz)	914.75					
Top Frequency (MHz)	927.25					

Table 4

Un-intentional Radiators

Highest frequency generated or used in the device or on which the device operates or tunes	927.25 MHz
Lowest frequency generated or used in the device or on which the device operates or tunes	902.75 MHz
Class A Digital Device (Use in commercial, industrial or business environment) <input type="checkbox"/>	
Class B Digital Device (Use in residential environment only) <input checked="" type="checkbox"/>	

Table 5



AC Power Source

AC supply frequency:	47 – 63	Hz
Voltage	100 to 264	V
Max current:	1.8	A
Single Phase <input checked="" type="checkbox"/> Three Phase <input type="checkbox"/>		

Table 6

DC Power Source

Nominal voltage:	24	V
Extreme upper voltage:	25.2	V
Extreme lower voltage:	23.8	V
Max current:	4	A

Table 7

Battery Power Source

Voltage:		V
End-point voltage:		V (Point at which the battery will terminate)
Alkaline <input type="checkbox"/> Leclanche <input type="checkbox"/> Lithium <input type="checkbox"/> Nickel Cadmium <input type="checkbox"/> Lead Acid* <input type="checkbox"/> *(Vehicle regulated)		
Other <input type="checkbox"/>	Please detail:	

Table 8

Charging

Can the EUT transmit whilst being charged	Yes <input type="checkbox"/> No <input type="checkbox"/>
---	--

Table 9

Temperature

Minimum temperature:	0	°C
Maximum temperature:	30	°C

Table 10

Cable Loss

Adapter Cable Loss (Conducted sample)		dB
---------------------------------------	--	----

Table 11



Antenna Characteristics

Antenna connector <input checked="" type="checkbox"/>		State impedance		Ohm
Temporary antenna connector <input type="checkbox"/>		State impedance		Ohm
Integral antenna <input type="checkbox"/>	Type:		Gain	dBi
External antenna <input checked="" type="checkbox"/>	Type:	Circular polarised Directional	Gain	8.5 dBi
For external antenna only: Standard Antenna Jack <input type="checkbox"/> If yes, describe how user is prohibited from changing antenna (if not professional installed): Equipment is only ever professionally installed <input checked="" type="checkbox"/> Non-standard Antenna Jack <input checked="" type="checkbox"/>				

Table 12

Ancillaries (if applicable)

Manufacturer:	XP Power	Part Number:	AEJ100PS24
Model:	AEJ100PS24	Country of Origin:	China

Table 13

I hereby declare that the information supplied is correct and complete.

Name: Andy Bell
 Position held: VP Engineering
 Date: 4 February 2022



1.5 Product Information

1.5.1 Technical Description

The EUT is a UHF RFID Distributed Antenna System - intended use detection and monitoring of UHF RFID tags.

1.5.2 Additional Information

The manufacturer stated that all 8-ports are electrically identical, therefore conducted measurements were only performed on port 1, which is representative of results from any given port.

The equipment under test (EUT) uses antennas with multiple inputs, the radiating antenna beams do not overlap and therefore antenna port summing of conducted power is not required to calculate the total ERP.

1.6 Deviations from the Standard

No deviations from the applicable test standard were made during testing.

1.7 EUT Modification Record

The table below details modifications made to the EUT during the test programme.

The modifications incorporated during each test are recorded on the appropriate test pages.

Modification State	Description of Modification still fitted to EUT	Modification Fitted By	Date Modification Fitted
Model: FR 9380 (8-port FCC), Serial Number: 10510422-0074			
0	As supplied by the customer	Not Applicable	Not Applicable
1	<p>The unit originally supplied was a v6.5.2 but we have updated it to v6.5.4 to improve the FCC emissions and PA resilience. This is covered by ECN028 and ECN030 which can be summarised as follows:</p> <ol style="list-style-type: none"> 1. Improve the TX harmonic filtering by adjusting the output filter component values. 2. Improve radiated emissions by fitting Eccosorb to the enclosure lid. 3. Limit the maximum current the PA can draw when incorrectly loaded so that it cannot burn itself out 	Martin Neuhaus	07-June-2022

Table 14



1.8 Test Location

TÜV SÜD conducted the following tests at our Fareham Test Laboratory.

Test Name	Name of Engineer(s)	Accreditation
Configuration and Mode: RFID Transceiver		
AC Power Line Conducted Emissions	Graeme Lawler	UKAS
Frequency Hopping Systems - Average Time of Occupancy	Neil Rousell	UKAS
Frequency Hopping Systems - Channel Separation	Nandhini Mathivanan	UKAS
Frequency Hopping Systems - Number of Hopping Channels	Nandhini Mathivanan	UKAS
Frequency Hopping Systems - 20 dB Bandwidth	Nandhini Mathivanan	UKAS
Maximum Conducted Output Power	Nandhini Mathivanan	UKAS
Conducted Spurious Emissions from the Antenna Port	Neil Rousell	UKAS
Spurious Radiated Emissions	Graeme Lawler	UKAS
Authorised Band Edges	Nandhini Mathivanan	UKAS

Table 15

Office Address:

TÜV SÜD
Octagon House
Concorde Way
Fareham
Hampshire
PO15 5RL
United Kingdom



2 Test Details

2.1 AC Power Line Conducted Emissions

2.1.1 Specification Reference

FCC 47 CFR Part 15C, Clause 15.207
ISED RSS-247, Clause 3.1
ISED RSS-GEN, Clause 8.8

2.1.2 Equipment Under Test and Modification State

FR 9380 (8-port FCC), S/N: 10510422-0074 - Modification State 1

2.1.3 Date of Test

08-August-2022

2.1.4 Test Method

The test was performed in accordance with ANSI C63.10, clause 6.2.

The EUT was placed on a non-conductive table 0.8m above a reference ground plane and 0.4m away from a vertical coupling plane.

All power was connected to the EUT through an Artificial Mains Network (AMN).

Conducted disturbance voltage measurements on mains lines were made at the output of the AMN.

The EUT was set to transmit on the bottom channel for each of the 8 ports. This is the channel where the highest conducted power was measured.

2.1.5 Environmental Conditions

Ambient Temperature	18.4 °C
Relative Humidity	51.5 %



2.1.6 Test Results

RFID Transceiver

Applied supply voltage: 118 V AC

Applied supply frequency: 60 Hz

Frequency (MHz)	Level (dBuV)	Limit (dBuV)	Margin (dB)	Detector
*				

Table 16 - Neutral Line Emissions Results

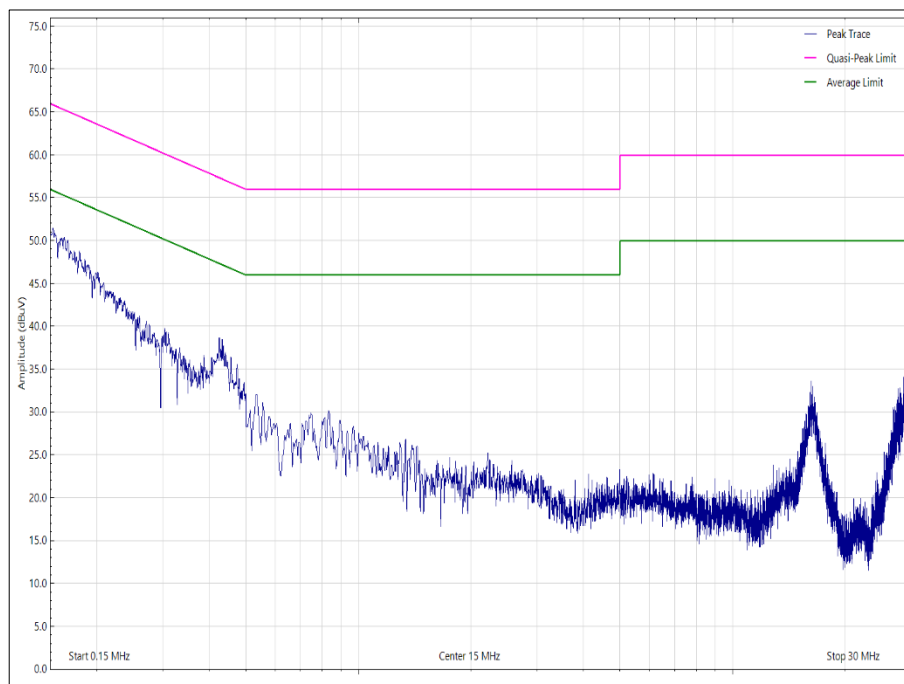

Figure 1 - Neutral Line - 150 kHz to 30 MHz



Frequency (MHz)	Level (dBuV)	Limit (dBuV)	Margin (dB)	Detector
*				

Table 17 - Live Line Emissions Results

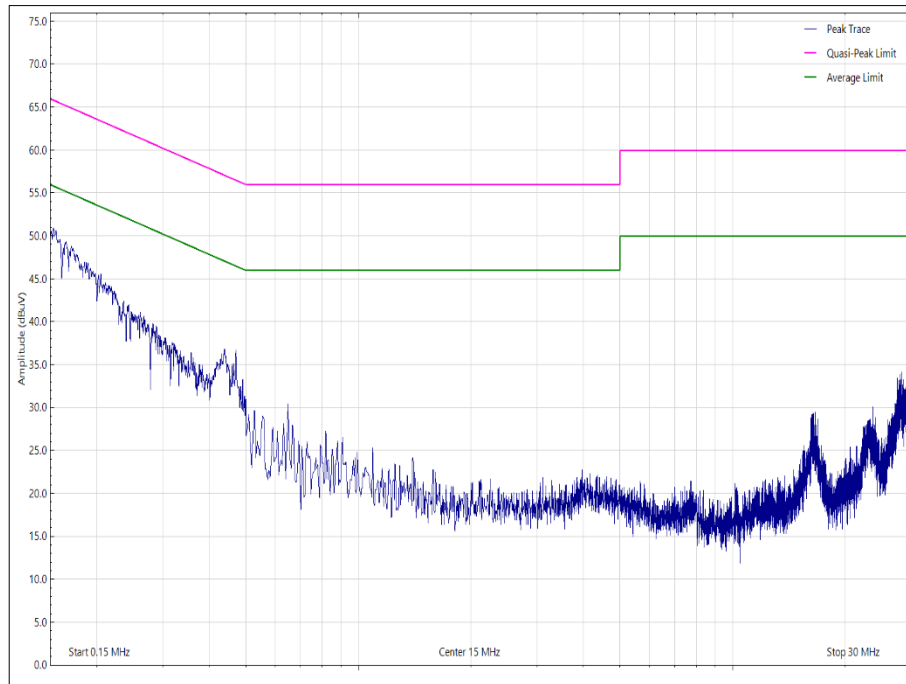

Figure 2 - Live Line - 150 kHz to 30 MHz

FCC 47 CFR Part 15, Limit Clause 15.207 and ISED RSS-GEN, Limit Clause 8.8

Frequency of Emission (MHz)	Conducted Limit (dBμV)	
	Quasi-Peak	CISPR Average
0.15 to 0.5	66 to 56*	56 to 46*
0.5 to 5	56	46
5 to 30	60	50

Table 18

*Decreases with the logarithm of the frequency.



2.1.7 Test Location and Test Equipment Used

This test was carried out in EMC Chamber 12.

Instrument	Manufacturer	Type No	TE No	Calibration Period (months)	Calibration Expires
LISN (CISPR 16, Single Phase)	Rohde & Schwarz	ESH3-Z5	1390	12	31-Jan-2023
Transient Limiter	Hewlett Packard	11947A	2378	12	13-Oct-2022
Test Receiver	Rohde & Schwarz	ESU40	3506	12	25-Mar-2023
True RMS Multimeter	Fluke	179	4006	12	29-Mar-2023
Cable (SMA to SMA, 2 m)	Rhophase	3PS-1801A-2000-3PS	4113	12	27-Jan-2023
Cable (N-Type to N-Type, 8 m)	Teledyne	PR90-088-8MTR	5450	6	06-Oct-2022
Thermo-hygro-Barometer	PCE Instruments	PCE-THB-40	5472	12	25-Mar-2023
Screened Room (12)	MVG	EMC-3	5621	36	11-Aug-2023

Table 19



2.2 Frequency Hopping Systems - Average Time of Occupancy

2.2.1 Specification Reference

FCC 47 CFR Part 15C, Clause 15.247 (a)(1)
ISED RSS-247, Clause 5.1

2.2.2 Equipment Under Test and Modification State

FR 9380 (8-port FCC), S/N: 10510422-0074 - Modification State 0

2.2.3 Date of Test

22-August-2022

2.2.4 Test Method

The test was performed in accordance with ANSI C63.10, clause 7.8.4.

2.2.5 Environmental Conditions

Ambient Temperature	23.0 °C
Relative Humidity	57.7 %



2.2.6 Test Results

RFID Transceiver

Dwell Time (ms)	Number of Transmissions	Average Occupancy Time (ms)
398.5	1	398.5

Table 20

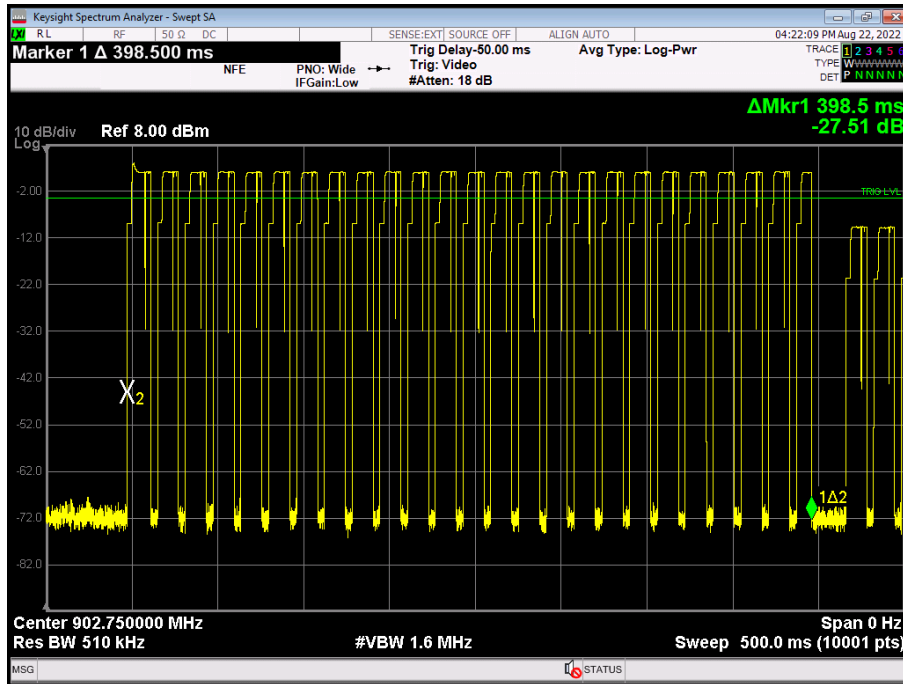

Figure 3 - Dwell Time

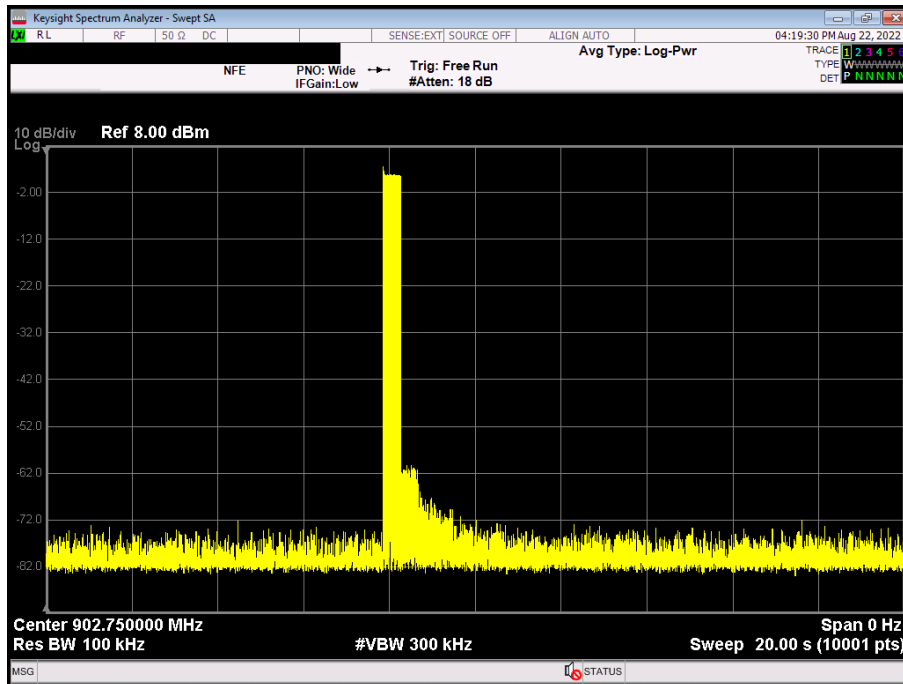

Figure 4 - Total Average Time of Occupancy

FCC 47 CFR Part 15, Limit Clause (a)(1)(i)

For frequency hopping systems operating in the 902–928 MHz band: if the 20 dB bandwidth of the hopping channel is less than 250 kHz, the system shall use at least 50 hopping frequencies and the average time of occupancy on any frequency shall not be greater than 0.4 seconds within a 20 second period; if the 20 dB bandwidth of the hopping channel is 250 kHz or greater, the system shall use at least 25 hopping frequencies and the average time of occupancy on any frequency shall not be greater than 0.4 seconds within a 10 second period. The maximum allowed 20 dB bandwidth of the hopping channel is 500 kHz.

Industry Canada RSS-247, Limit Clause 5.1 (c)

The average time of occupancy on any channel shall not be greater than 0.4 seconds within a 20-second period. If the 20 dB bandwidth of the hopping channel is 250 kHz or greater, the system shall use at least 25 hopping channels and the average time of occupancy on any channel shall not be greater than 0.4 seconds within a 10-second period.



2.2.7 Test Location and Test Equipment Used

This test was carried out in RF Laboratory 2.

Instrument	Manufacturer	Type No.	TE No.	Calibration Period (months)	Calibration Expiry Date
Multimeter	Fluke	177	3833	12	16-Dec-2022
Frequency Standard	Spectracom	SecureSync 1200-0408-0601	4393	6	01-Feb-2023
1 metre K-Type Cable	Florida Labs	KMS-180SP-39.4-KMS	4520	12	18-Nov-2022
PXA Signal Analyser	Keysight Technologies	N9030A	4654	12	24-Nov-2022
AC Programmable Power Supply	iTech	IT7324	5227	-	O/P Mon
Thermo-Hygro-Barometer	PCE Instruments	PCE-THB-40	5475	12	25-Apr-2023
Attenuator 5W 30dB DC-18GHz	Aaren	AT40A-4041-D18-30	5502	12	21-Apr-2023

Table 21

O/P Mon – Output Monitored using calibrated equipment



2.3 Frequency Hopping Systems - Channel Separation

2.3.1 Specification Reference

FCC 47 CFR Part 15C, Clause 15.247 (a)(1)
ISED RSS-247, Clause 5.1

2.3.2 Equipment Under Test and Modification State

FR 9380 (8-port FCC), S/N: 10510422-0074 - Modification State 0

2.3.3 Date of Test

07-February-2022

2.3.4 Test Method

The test was performed in accordance with ANSI C63.10, clause 7.8.2.

2.3.5 Environmental Conditions

Ambient Temperature	22.9 °C
Relative Humidity	40.0 %



2.3.6 Test Results

RFID Transceiver

Channel Separation (MHz)
0.5

Table 22

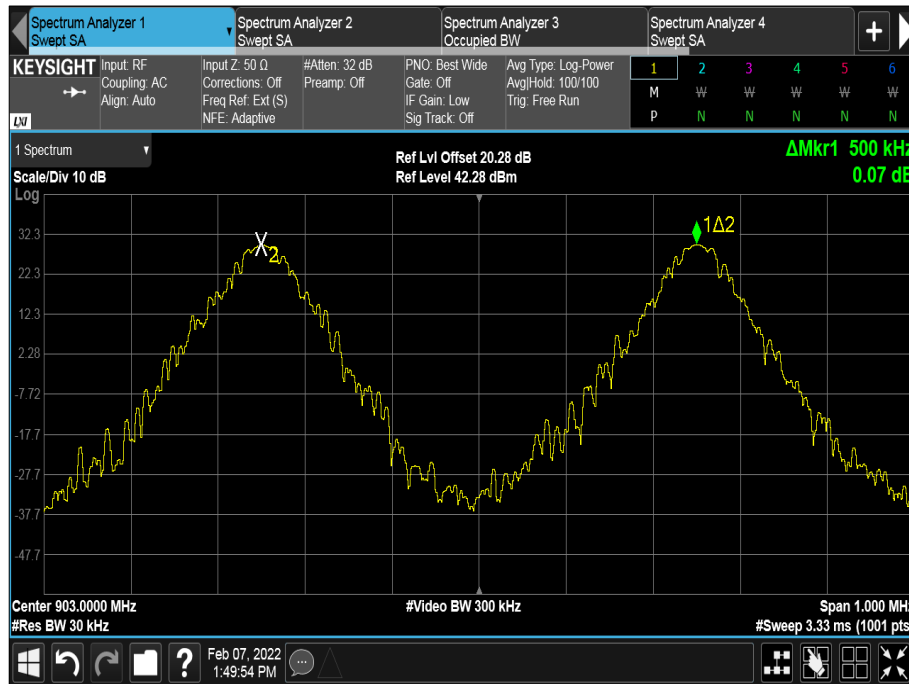

Figure 5

FCC 47 CFR Part 15, Limit Clause 15.247 (a)(1)(i)

Frequency hopping systems shall have hopping channel carrier frequencies separated by a minimum of 25 kHz or the 20 dB bandwidth of the hopping channel, whichever is greater.

ISED RSS-247, Limit Clause 5.1 (b)

FHSs shall have hopping channel carrier frequencies separated by a minimum of 25 kHz or the 20 dB bandwidth of the hopping channel, whichever is greater.



2.3.7 Test Location and Test Equipment Used

This test was carried out in RF Laboratory 2.

Instrument	Manufacturer	Type No	TE No	Calibration Period (months)	Calibration Expires
Multimeter	Iso-tech	IDM101	2424	12	20-Jan-2023
Frequency Standard	Spectracom	SecureSync 1200-0408-0601	4393	6	30-Jul-2022
EXA	Keysight Technologies	N9010B	4968	24	19-Jan-2024
Network Analyser	Keysight Technologies	E5063A	5018	12	30-Jul-2022
Electronic Calibration Module	Keysight Technologies	85093C	5188	12	22-Jul-2022
AC Programmable Power Supply	iTech	IT7324	5227	-	O/P Mon
3.5 mm 1m Cable	Junkosha	MWX221-01000DMS	5419	12	09-Jul-2022
Thermo-Hygro-Barometer	PCE Instruments	PCE-THB-40	5475	12	06-Apr-2022
Attenuator 5W 20dB DC-18GHz	Aaren	AT40A-4041-D18-20	5500	12	14-Apr-2022

Table 23

O/P Mon – Output monitored using calibrated test equipment.



2.4 Frequency Hopping Systems - Number of Hopping Channels

2.4.1 Specification Reference

FCC 47 CFR Part 15C, Clause 15.247 (a)(1)
ISED RSS-247, Clause 5.1

2.4.2 Equipment Under Test and Modification State

FR 9380 (8-port FCC), S/N: 10510422-0074 - Modification State 0

2.4.3 Date of Test

07-February-2022

2.4.4 Test Method

The test was performed in accordance with ANSI C63.10, clause 7.8.3.

2.4.5 Environmental Conditions

Ambient Temperature	22.9 °C
Relative Humidity	40.0 %



2.4.6 Test Results

RFID Transceiver

Number of hopping frequencies: 50

Verdict: Pass

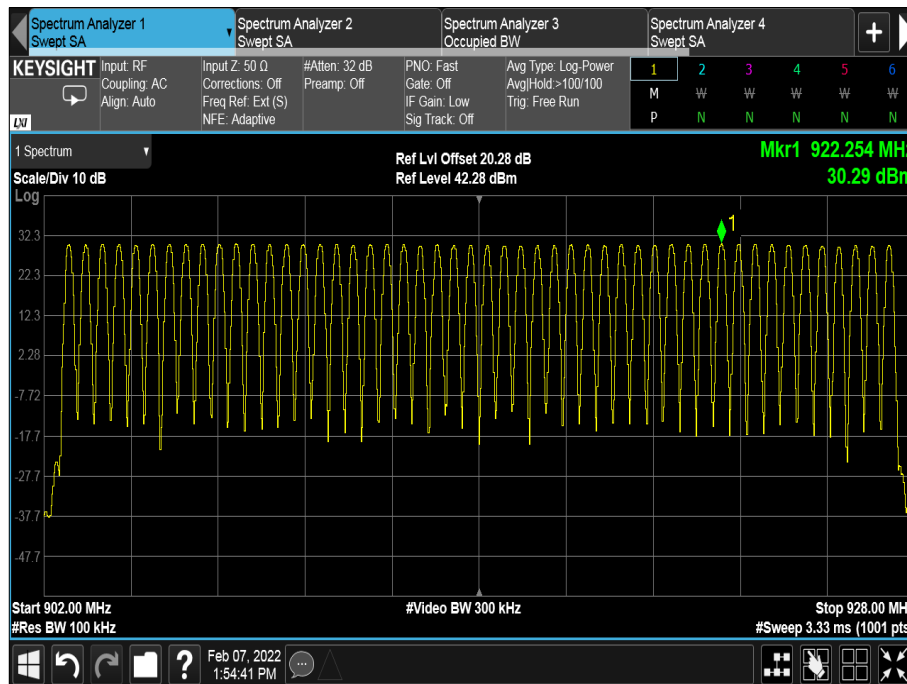

Figure 6 - Measurement Frequency Range: 902 MHz to 928 MHz

FCC 47 CFR Part 15, Limit Clause 15.247 (a)(1)(i) and ISED RSS-247, Limit Clause 5.1 (c)

If the 20 dB bandwidth of the hopping channel is less than 250 kHz, the system shall use at least 50 hopping frequencies.

If the 20 dB bandwidth of the hopping channel is 250 kHz or greater, the system shall use at least 25 hopping frequencies.



2.4.7 Test Location and Test Equipment Used

This test was carried out in RF Laboratory 1.

Instrument	Manufacturer	Type No	TE No	Calibration Period (months)	Calibration Expires
Multimeter	Iso-tech	IDM101	2424	12	20-Jan-2023
Frequency Standard	Spectracom	SecureSync 1200-0408-0601	4393	6	30-Jul-2022
EXA	Keysight Technologies	N9010B	4968	24	19-Jan-2024
Network Analyser	Keysight Technologies	E5063A	5018	12	30-Jul-2022
Electronic Calibration Module	Keysight Technologies	85093C	5188	12	22-Jul-2022
AC Programmable Power Supply	iTech	IT7324	5227	-	O/P Mon
3.5 mm 1m Cable	Junkosha	MWX221-01000DMS	5419	12	09-Jul-2022
Thermo-Hygro-Barometer	PCE Instruments	PCE-THB-40	5475	12	06-Apr-2022
Attenuator 5W 20dB DC-18GHz	Aaren	AT40A-4041-D18-20	5500	12	14-Apr-2022

Table 24

O/P Mon – Output monitored using calibrated test equipment.



2.5 Frequency Hopping Systems - 20 dB Bandwidth

2.5.1 Specification Reference

FCC 47 CFR Part 15C, Clause 15.247 (a)(1)
ISED RSS-247, Clause 5.1
ISED RSS-GEN, Clause 6.7

2.5.2 Equipment Under Test and Modification State

FR 9380 (8-port FCC), S/N: 10510422-0074 - Modification State 0

2.5.3 Date of Test

07-February-2022

2.5.4 Test Method

The test was performed in accordance with ANSI C63.10, clause 6.9.2.

2.5.5 Environmental Conditions

Ambient Temperature	22.9 °C
Relative Humidity	40.0 %



2.5.6 Test Results

RFID Transceiver

20 dB Bandwidth (kHz)		
902.75 MHz	914.75 MHz	927.25 MHz
112.617	112.879	117.922

Table 25



Figure 7 - 902.75 MHz



Figure 8 - 914.75 MHz



Figure 9 - 927.25 MHz

FCC 47 CFR Part 15, Limit Clause 15.247 (a)(1)(i) and ISD RSS-247, Limit Clause 5.1 (c)

The maximum 20 dB bandwidth of the hopping channel shall be 500 kHz.



2.5.7 Test Location and Test Equipment Used

This test was carried out in RF Laboratory 2.

Instrument	Manufacturer	Type No	TE No	Calibration Period (months)	Calibration Expires
Multimeter	Iso-tech	IDM101	2424	12	20-Jan-2023
Frequency Standard	Spectracom	SecureSync 1200-0408-0601	4393	6	30-Jul-2022
EXA	Keysight Technologies	N9010B	4968	24	19-Jan-2024
Network Analyser	Keysight Technologies	E5063A	5018	12	30-Jul-2022
Electronic Calibration Module	Keysight Technologies	85093C	5188	12	22-Jul-2022
AC Programmable Power Supply	iTech	IT7324	5227	-	O/P Mon
3.5 mm 1m Cable	Junkosha	MWX221-01000DMS	5419	12	09-Jul-2022
Thermo-Hygro-Barometer	PCE Instruments	PCE-THB-40	5475	12	06-Apr-2022
Attenuator 5W 20dB DC-18GHz	Aaren	AT40A-4041-D18-20	5500	12	14-Apr-2022

Table 26

O/P Mon – Output monitored using calibrated test equipment.



2.6 Maximum Conducted Output Power

2.6.1 Specification Reference

FCC 47 CFR Part 15C, Clause 15.247 (b)
ISED RSS-247, Clause 5.4
ISED RSS-GEN, Clause 6.12

2.6.2 Equipment Under Test and Modification State

FR 9380 (8-port FCC), S/N: 10510422-0074 - Modification State 0

2.6.3 Date of Test

07-February-2022

2.6.4 Test Method

The test was performed in accordance with ANSI C63.10, clause 11.9.1.1

2.6.5 Environmental Conditions

Ambient Temperature	22.9 °C
Relative Humidity	40.0 %



2.6.6 Test Results

RFID Transceiver

Testing was performed on the modulation/packet type with the highest conducted output power.

Frequency (MHz)	Maximum Output Power	
	dBm	mW
902.75	29.72	937.56
914.75	29.42	874.98
927.25	29.60	912.01

Table 27

FCC 47 CFR Part 15, Limit Clause 15.247 (b)(2)

For frequency hopping systems operating in the 902–928 MHz band: 1 watt for systems employing at least 50 hopping channels; and, 0.25 watts for systems employing less than 50 hopping channels.

ISED RSS-247, Limit Clause 5.4 (a)

For FHSs operating in the band 902-928 MHz, the maximum peak conducted output power shall not exceed 1.0 W, and the e.i.r.p. shall not exceed 4 W if the hopset uses 50 or more hopping channels; the maximum peak conducted output power shall not exceed 0.25 W and the e.i.r.p. shall not exceed 1 W if the hopset uses less than 50 hopping channels.

2.6.7 Test Location and Test Equipment Used

This test was carried out in RF Laboratory 2.

Instrument	Manufacturer	Type No	TE No	Calibration Period (months)	Calibration Expires
Multimeter	Iso-tech	IDM101	2424	12	20-Jan-2023
Frequency Standard	Spectracom	SecureSync 1200-0408-0601	4393	6	30-Jul-2022
EXA	Keysight Technologies	N9010B	4968	24	19-Jan-2024
Network Analyser	Keysight Technologies	E5063A	5018	12	30-Jul-2022
Electronic Calibration Module	Keysight Technologies	85093C	5188	12	22-Jul-2022
AC Programmable Power Supply	iTech	IT7324	5227	-	O/P Mon
3.5 mm 1m Cable	Junkosha	MWX221-01000DMS	5419	12	09-Jul-2022
Thermo-Hygro-Barometer	PCE Instruments	PCE-THB-40	5475	12	06-Apr-2022
Attenuator 5W 20dB DC-18GHz	Aaren	AT40A-4041-D18-20	5500	12	14-Apr-2022

Table 28

O/P Mon – Output monitored using calibrated test equipment.



2.7 Conducted Spurious Emissions from the Antenna Port

2.7.1 Specification Reference

FCC 47 CFR Part 15C, Clause 15.247 (d) and 15.209
ISED RSS-247, Clause 3.3 and 5.5
ISED RSS-GEN, Clause, 6.13 and 8.9

2.7.2 Equipment Under Test and Modification State

FR 9380 (8-port FCC), S/N: 10510422-0074 - Modification State 0

2.7.3 Date of Test

23-August-2022

2.7.4 Test Method

The EUT antenna port was connected directly to the spectrum analyser via a cable and attenuator. In addition to this test, a radiated measurement of the cabinet emissions was also performed.

This test was performed in accordance with ANSI C63.10 clause 7.8.8 for measurements in non-restricted bands.

For measurements in restricted bands a conducted procedure was used to measure the emissions from a single antenna port using the procedure described in clause 11.12.2.

2.7.5 Environmental Conditions

Ambient Temperature	23.7 °C
Relative Humidity	57.2 %



2.7.6 Test Results

RFID Transceiver

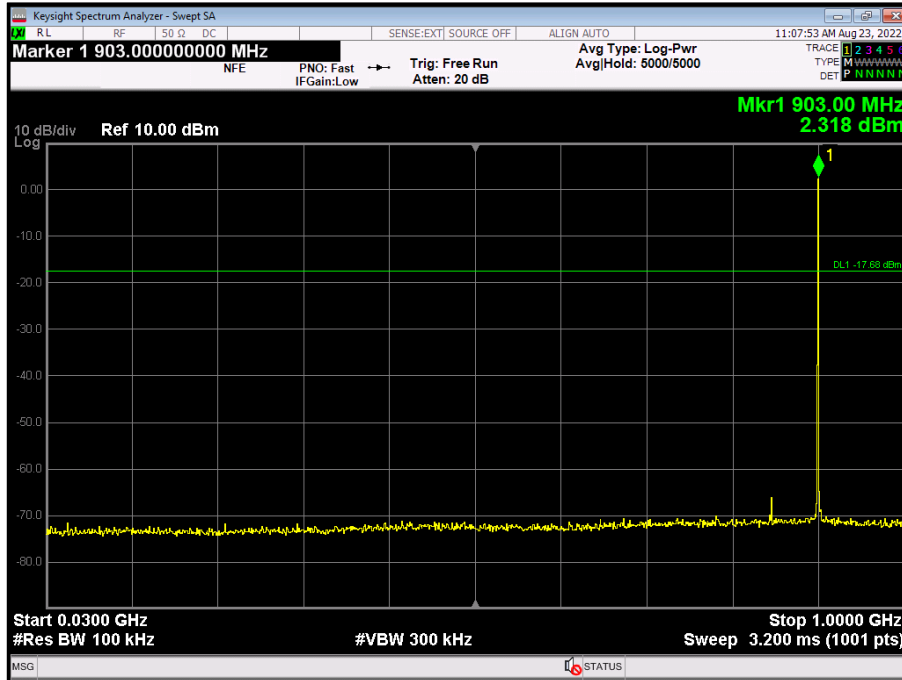

Figure 10 - Non-Restricted Band, 30 MHz to 1 GHz, 902.75 MHz

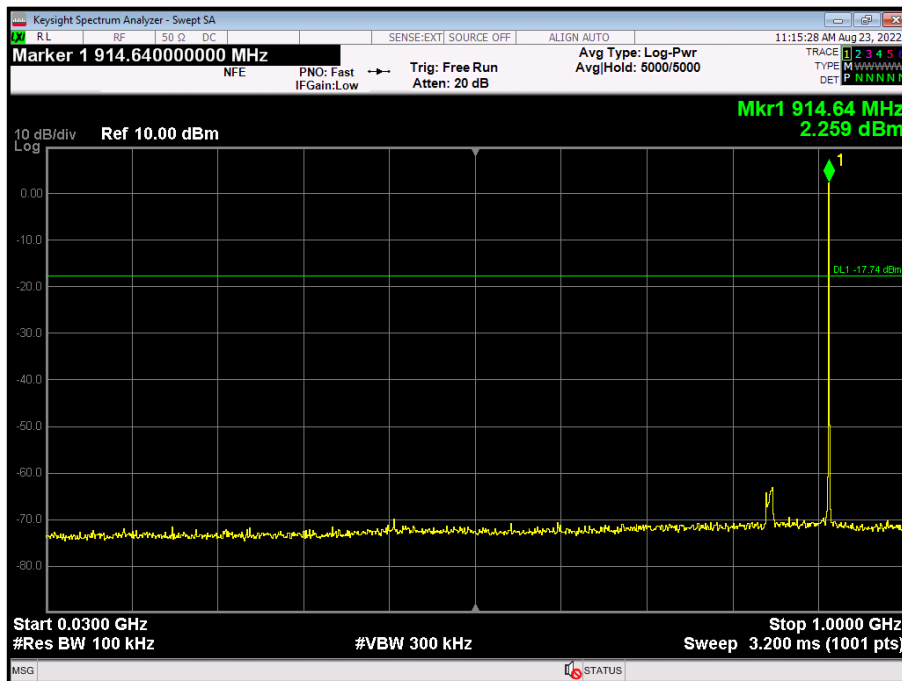

Figure 11 - Non-Restricted Band, 30 MHz to 1 GHz, 914.75 MHz

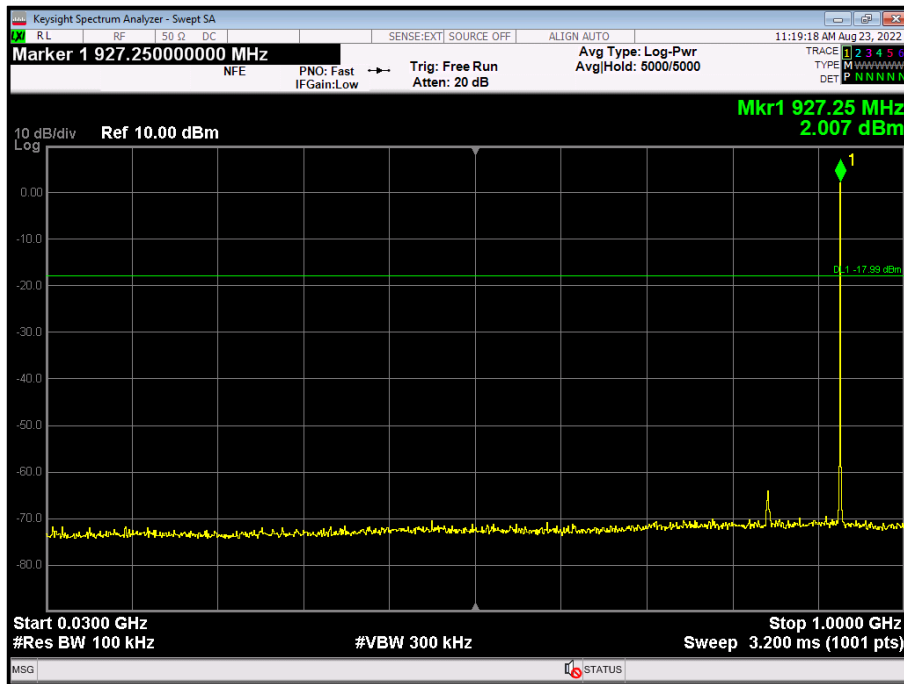

Figure 12 Non-Restricted Band, 30 MHz to 1 GHz, 927.25 MHz

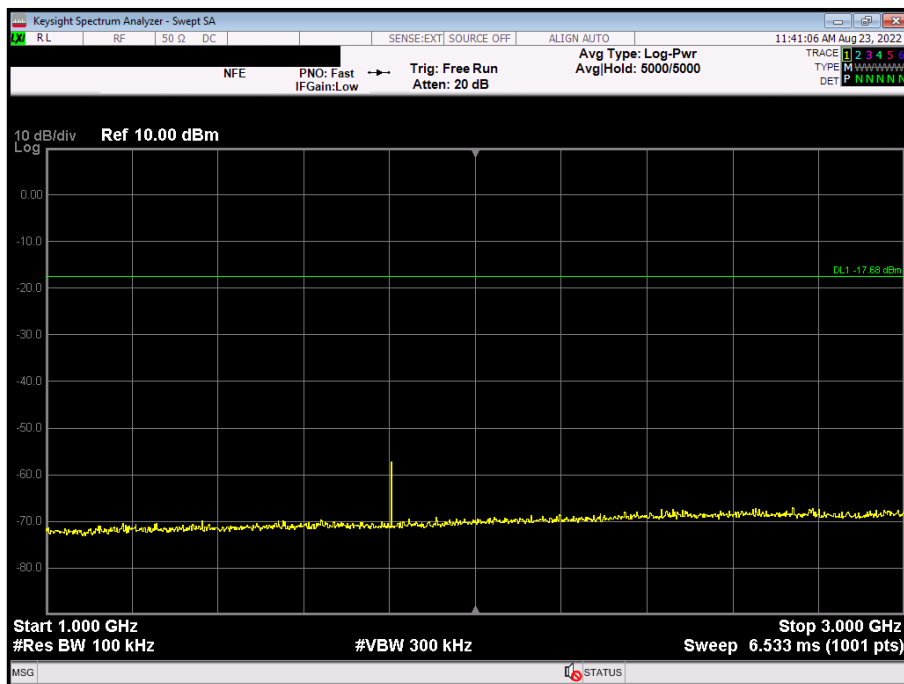

Figure 13 - Non-Restricted Band, 1 GHz to 3 GHz, 902.75 MHz

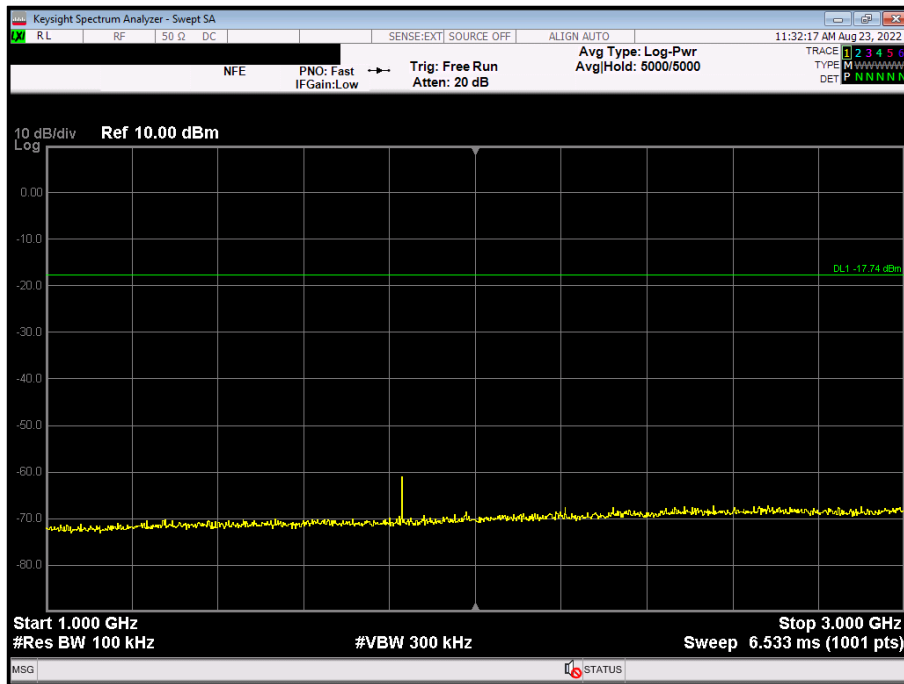

Figure 14 - Non-Restricted Band, 1 GHz to 3 GHz, 914.75 MHz

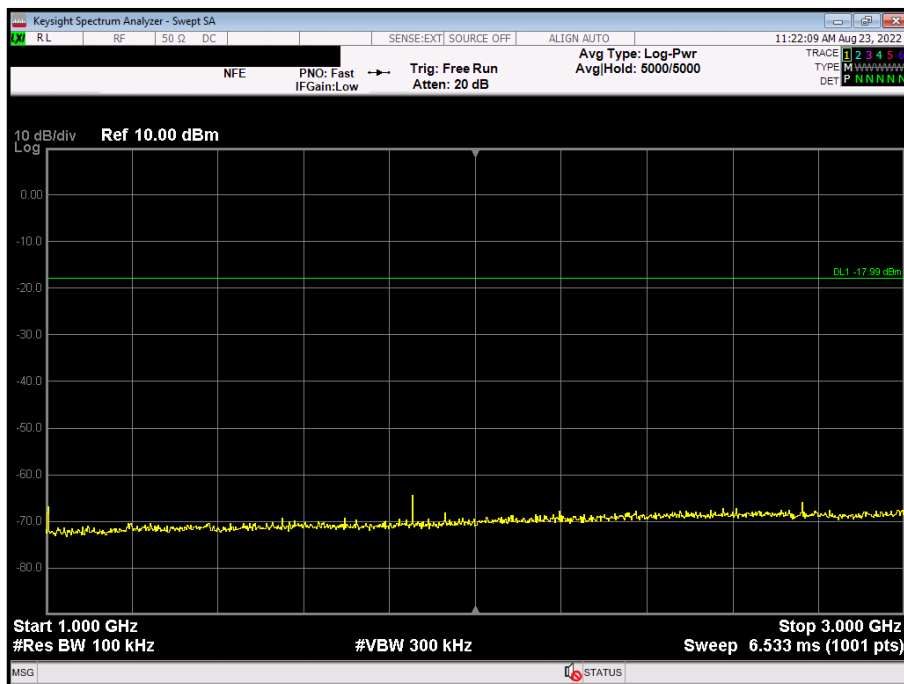

Figure 15 Non-Restricted Band, 1 GHz to 3 GHz, 927.25 MHz

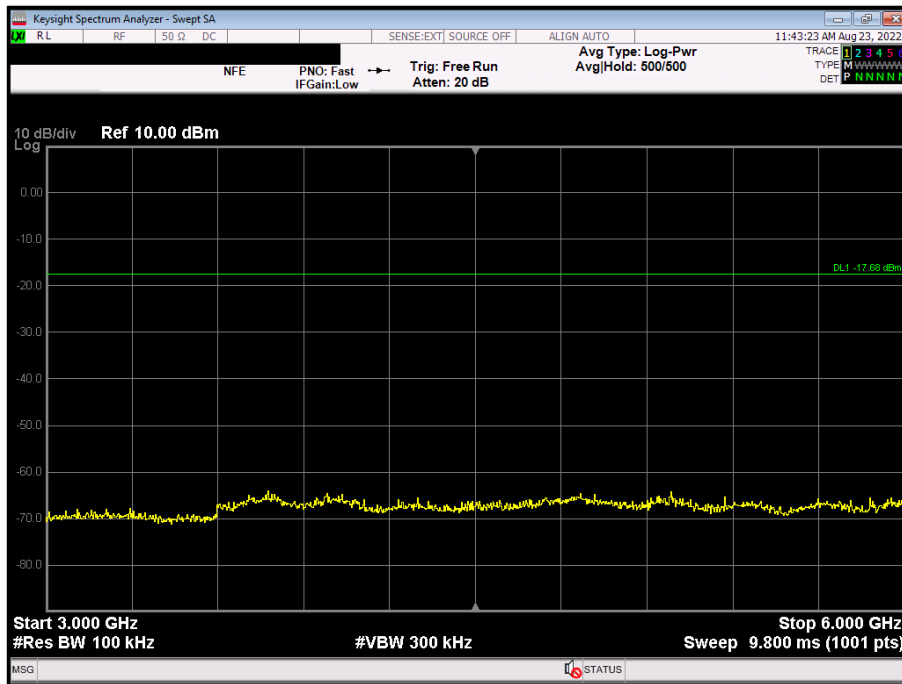

Figure 16 - Non-Restricted Band, 3 GHz to 6 GHz, 902.75 MHz

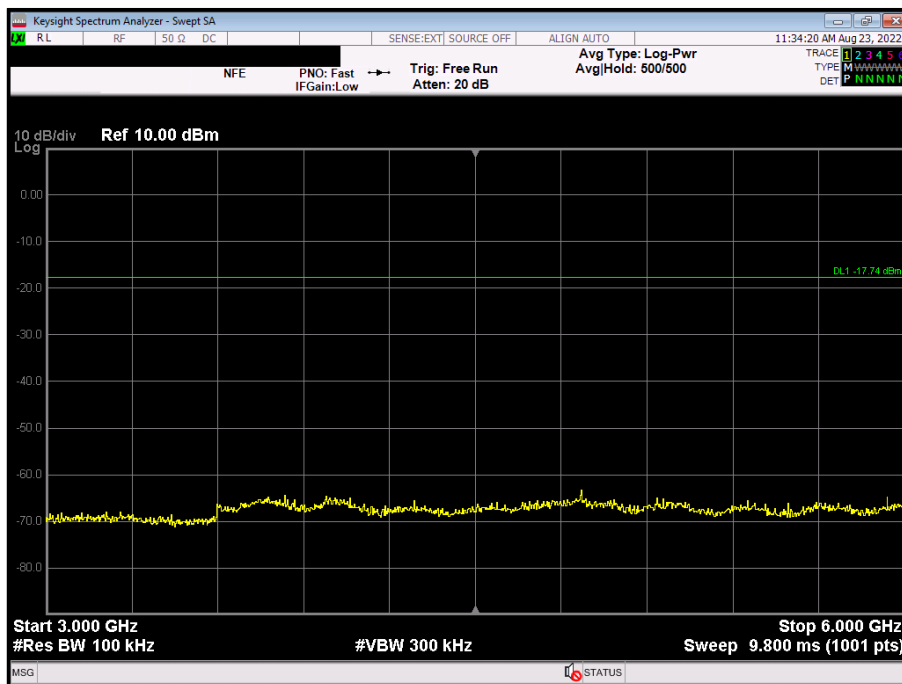

Figure 17 - Non-Restricted Band, 3 GHz to 6 GHz, 914.75 MHz

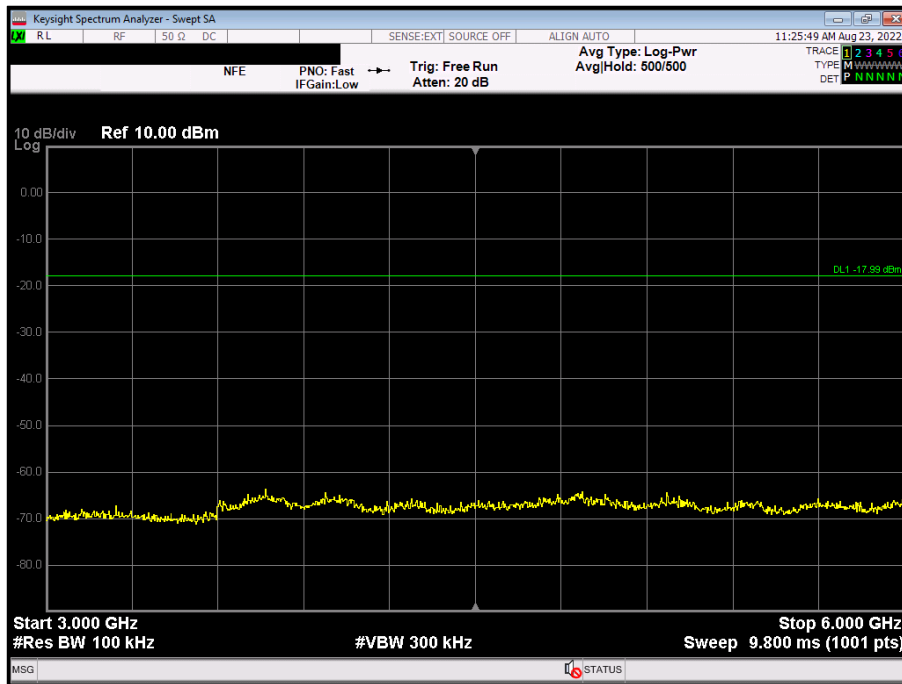

Figure 18 - Non-Restricted Band, 3 GHz to 6 GHz, 927.25 MHz

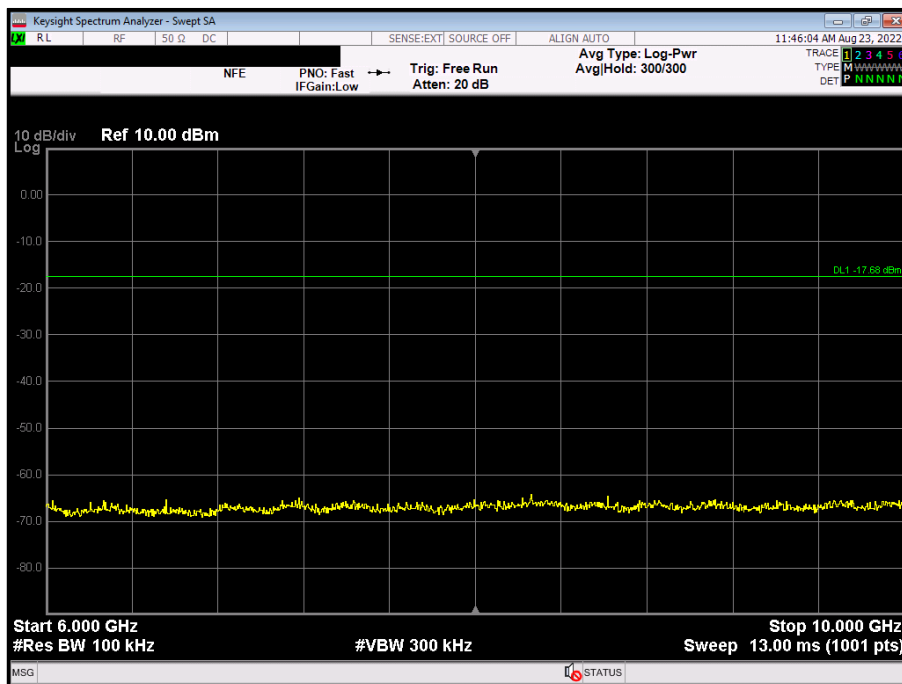

Figure 19 - Non-Restricted Band, 6 GHz to 10 GHz, 902.75 MHz

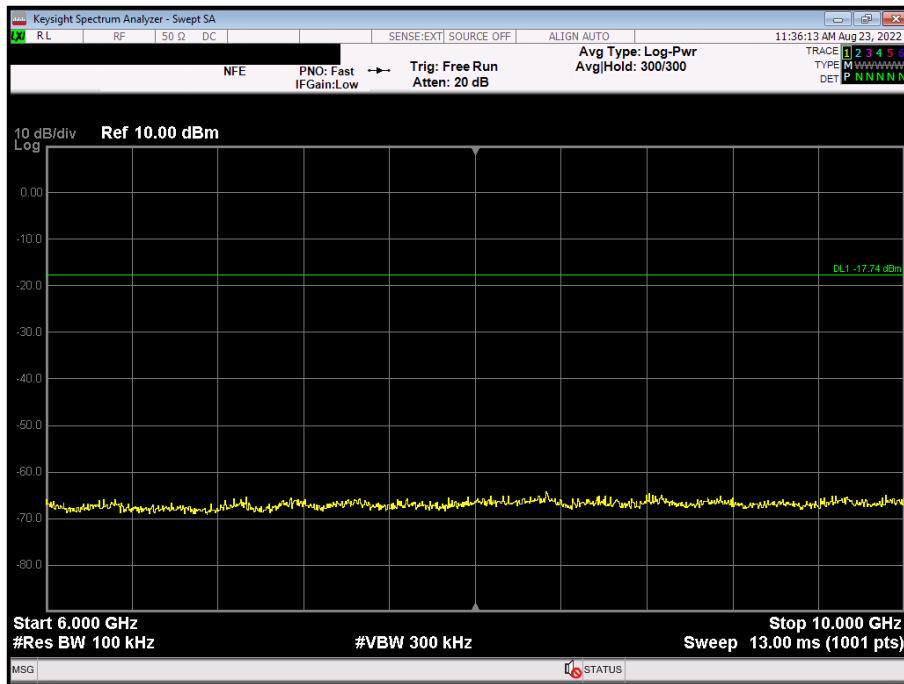

Figure 20 - Non-Restricted Band, 6 GHz to 10 GHz, 914.75 MHz

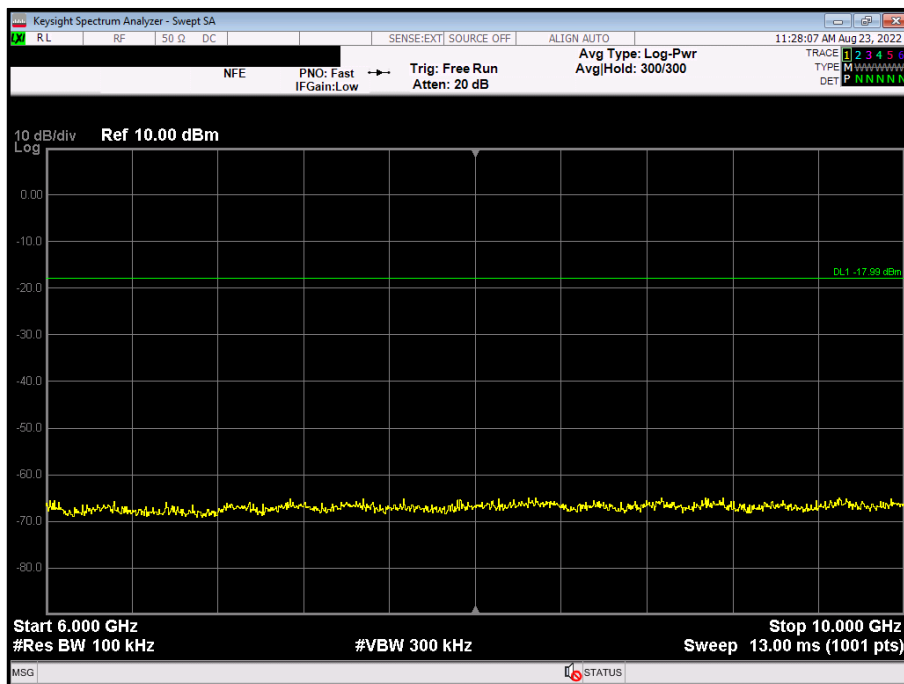

Figure 21 Non-Restricted Band, 6 GHz to 10 GHz, 927.25 MHz

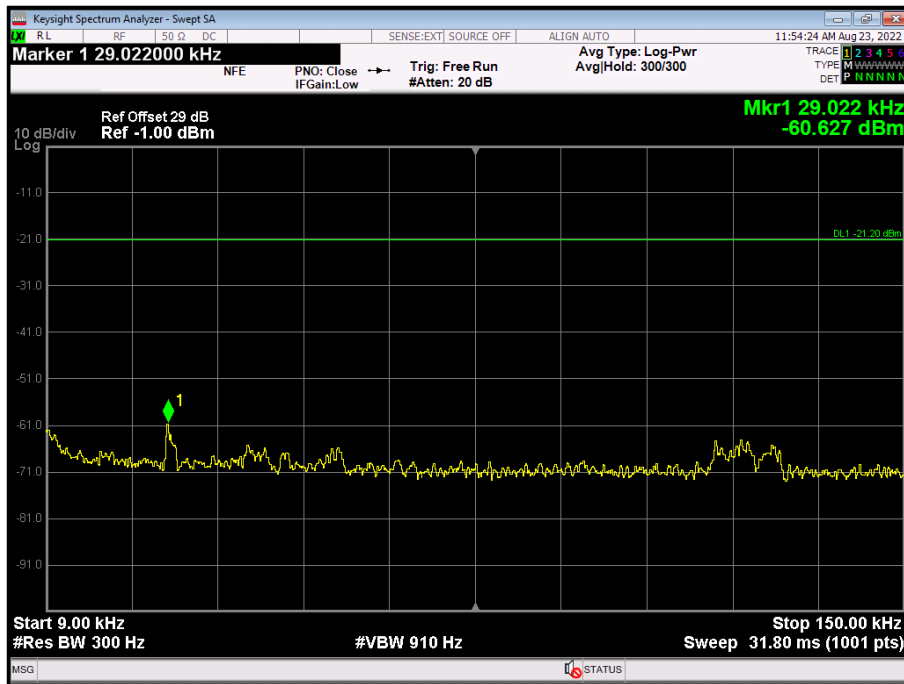

Figure 22 - Restricted Band - Peak, 9 kHz to 150 kHz, 902.75 MHz

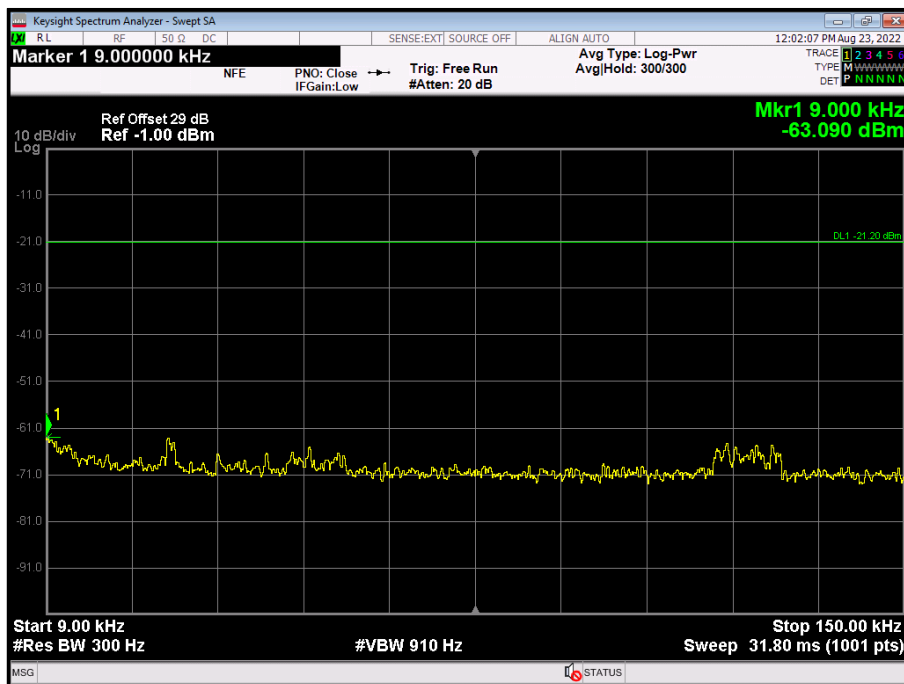

Figure 23 - Restricted Band - Peak, 9 kHz to 150 kHz, 914.75 MHz

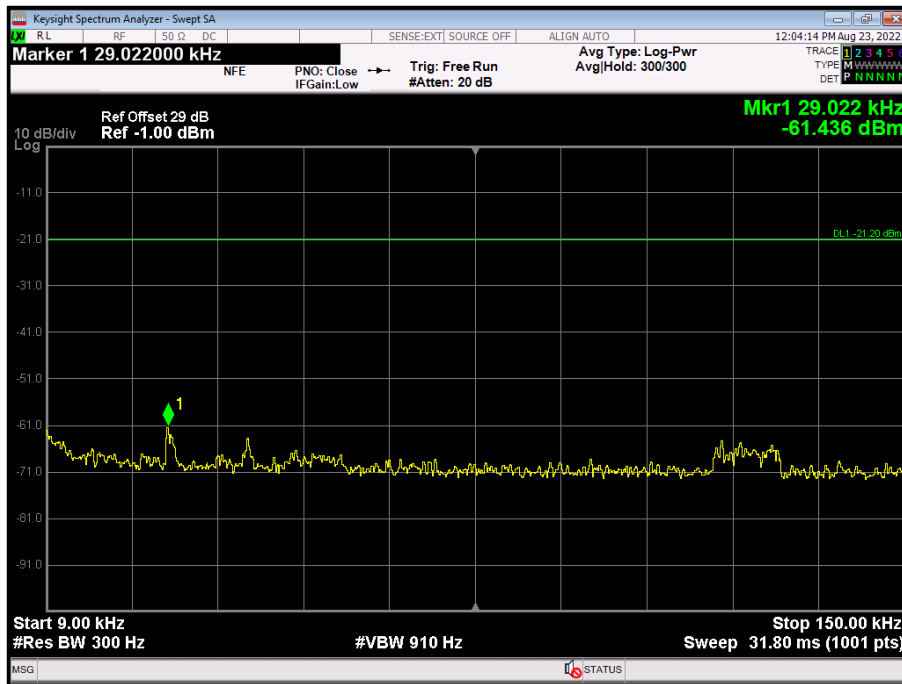

Figure 24 – Restricted Band - Peak, 9 kHz to 150 kHz, 927.25 MHz

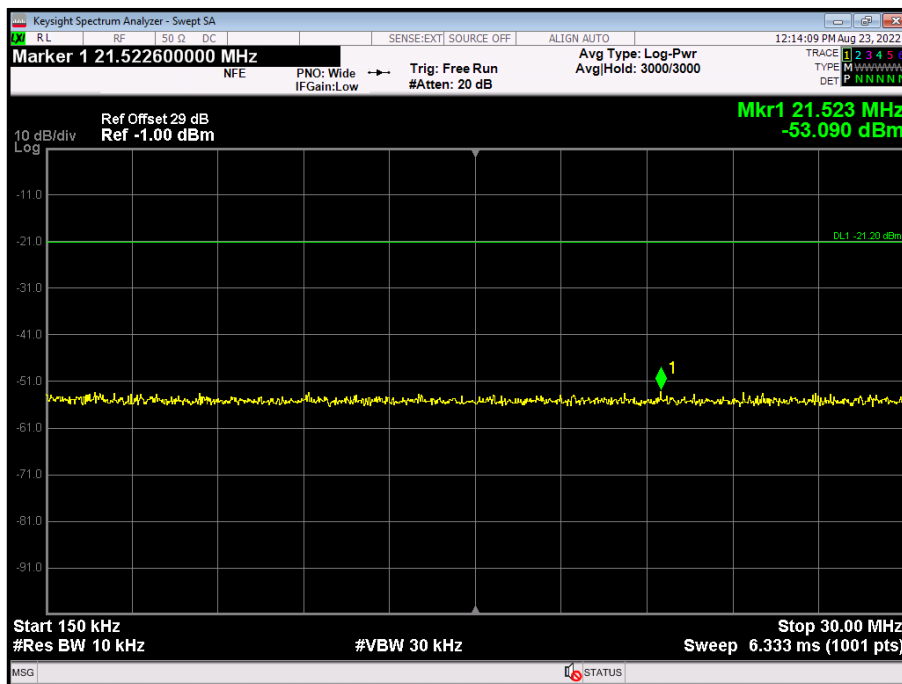

Figure 25 – Restricted Band - Peak, 150 kHz to 30 MHz, 902.75 MHz

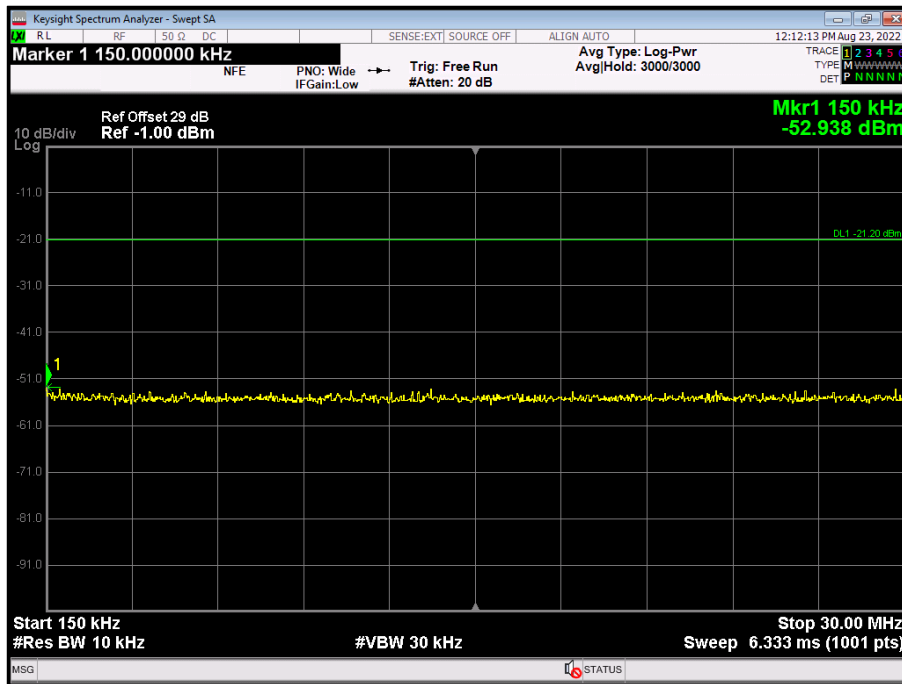

Figure 26 - Restricted Band - Peak, 150 kHz to 30 MHz, 914.75 MHz

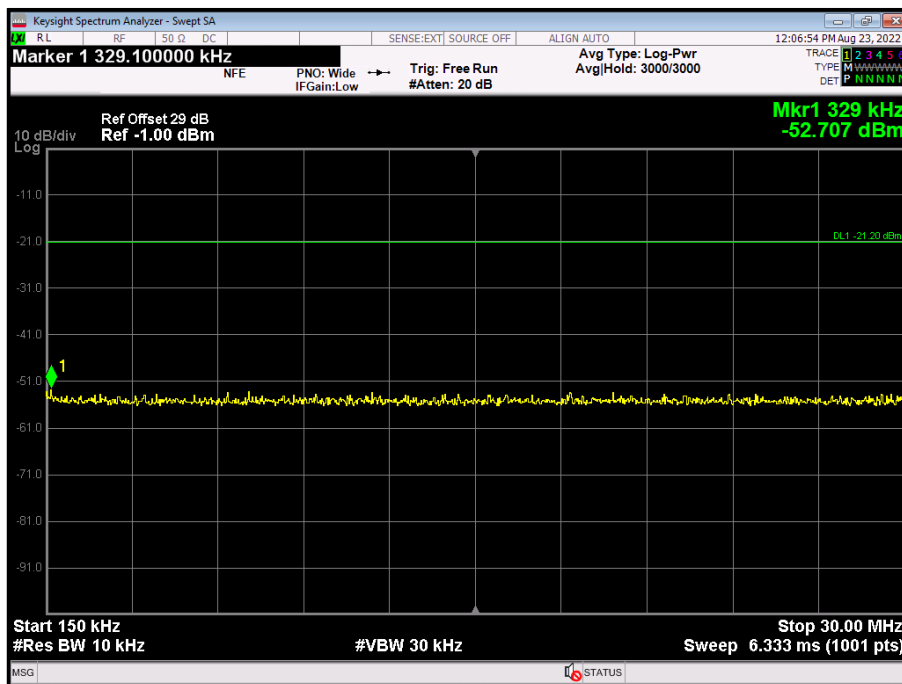

Figure 27 - Restricted Band - Peak, 150 kHz to 30 MHz, 927.25 MHz

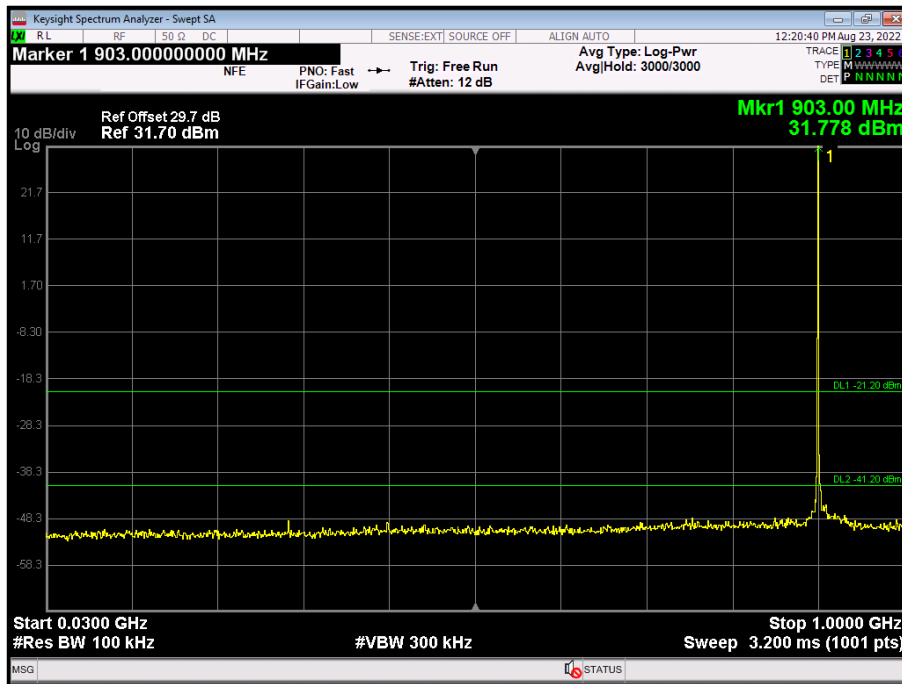

Figure 28 - Restricted Band - Peak, 30 MHz to 1 GHz, 902.75 MHz

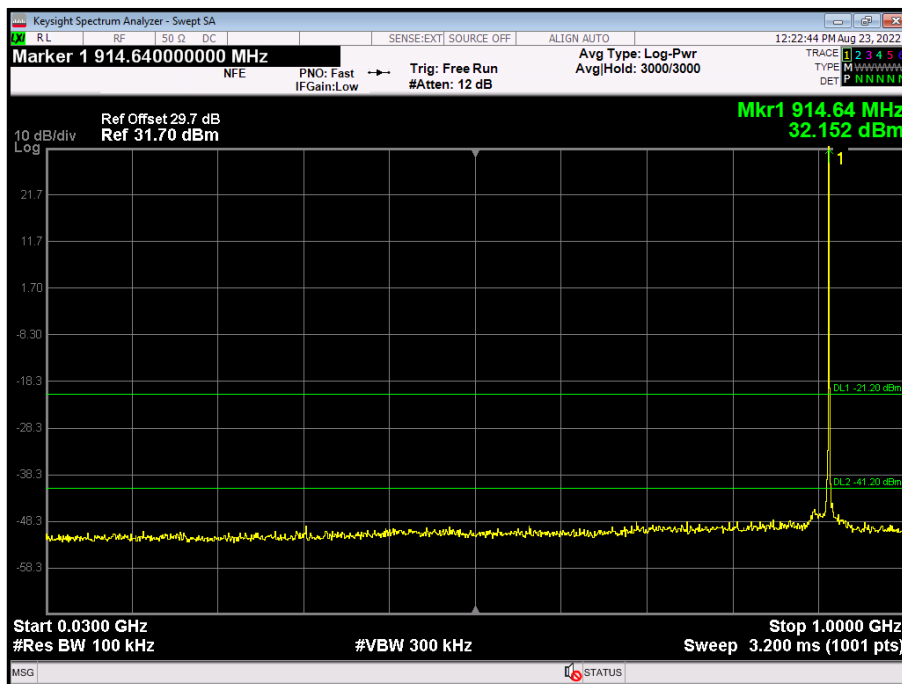

Figure 29 - Restricted Band - Peak, 30 MHz to 1 GHz, 914.75 MHz

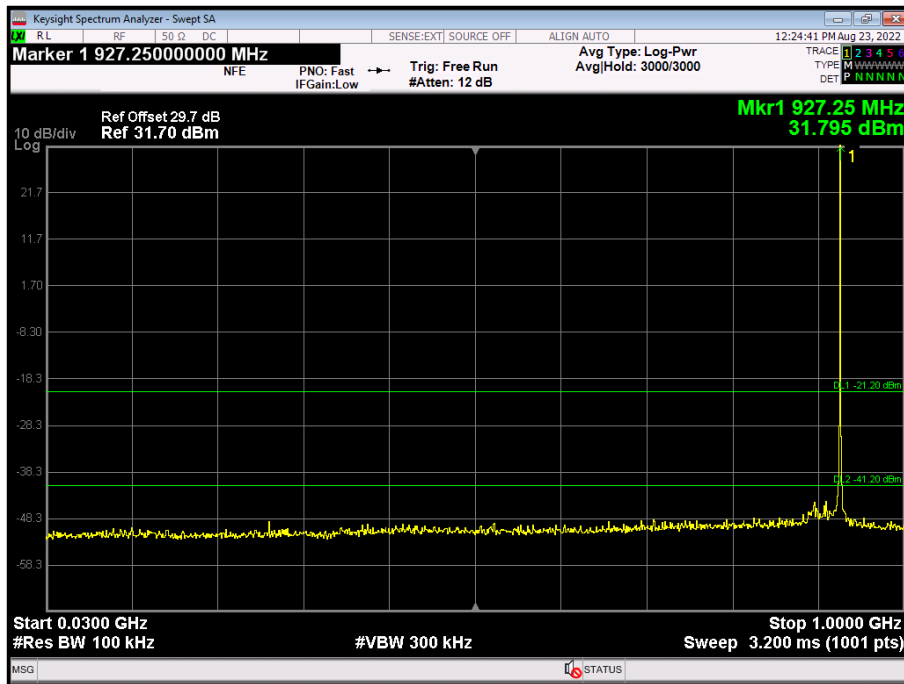

Figure 30 - Restricted Band - Peak, 30 MHz to 1 GHz, 927.25 MHz

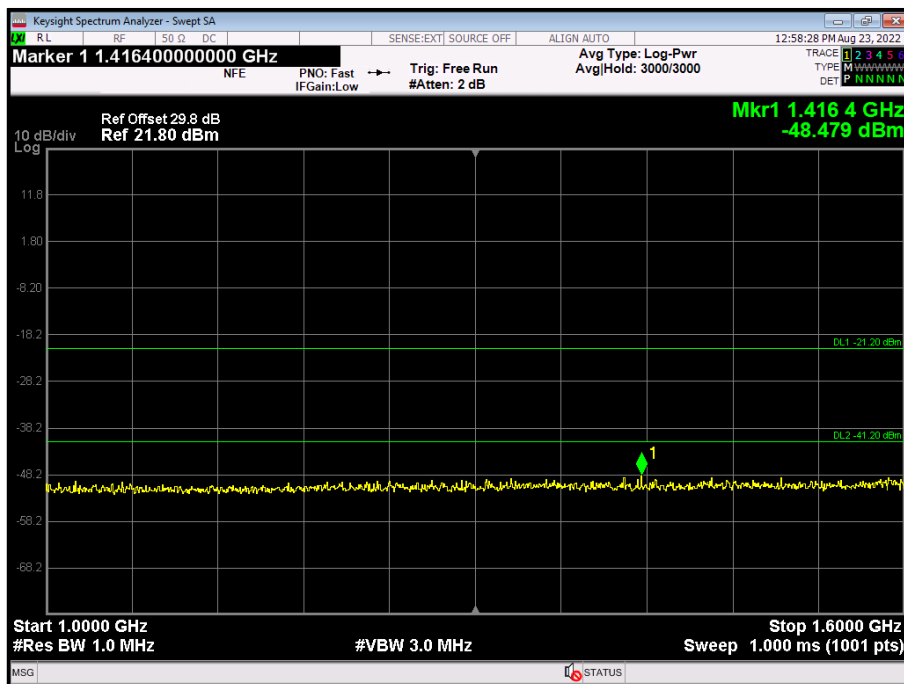

Figure 31 - Restricted Band - Peak, 1 GHz to 1.6 GHz, 902.75 MHz

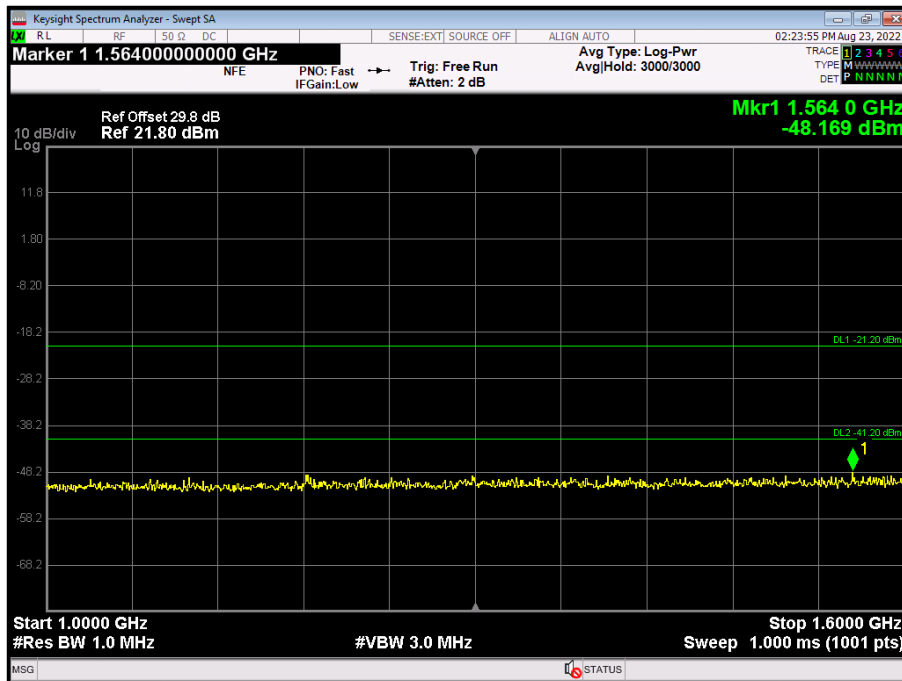

Figure 32 - Restricted Band - Peak, 1 GHz to 1.6 GHz, 914.75 MHz

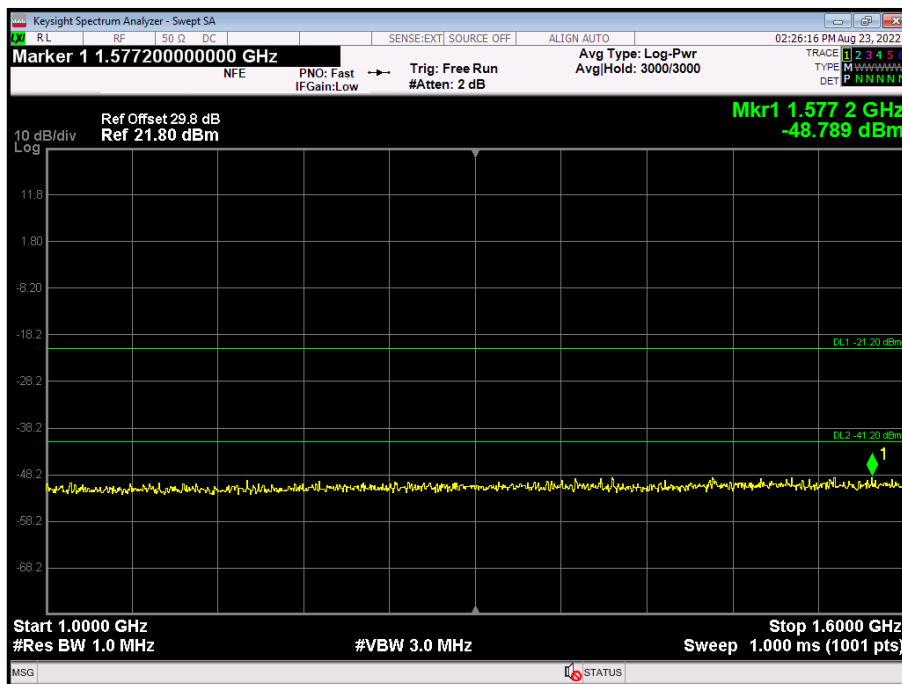

Figure 33 - Restricted Band - Peak, 1 GHz to 1.6 GHz, 927.25 MHz

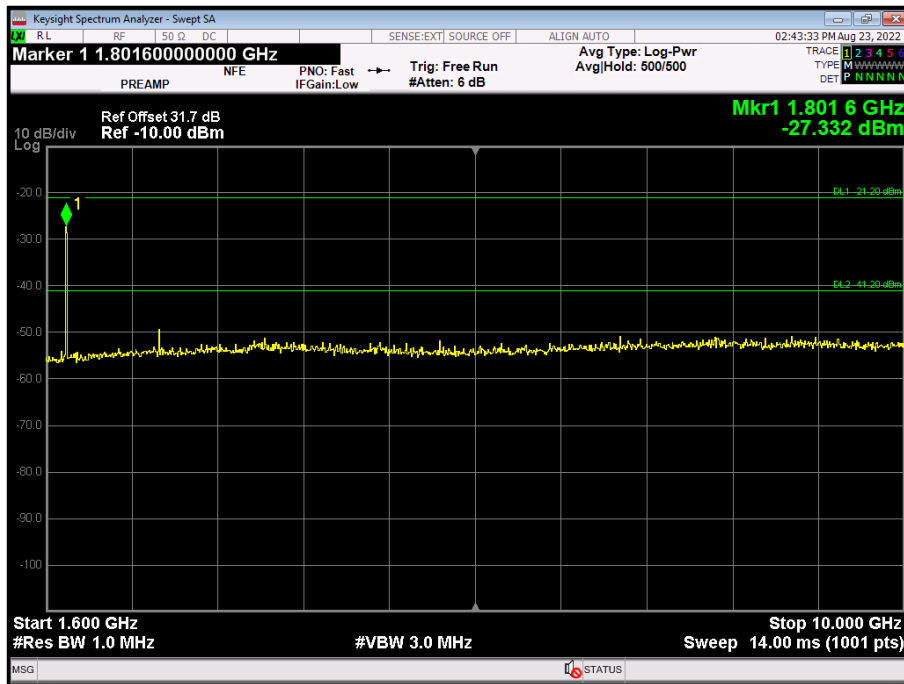

Figure 34 - Restricted Band - Peak, 1.6 GHz to 10 GHz, 902.75 MHz

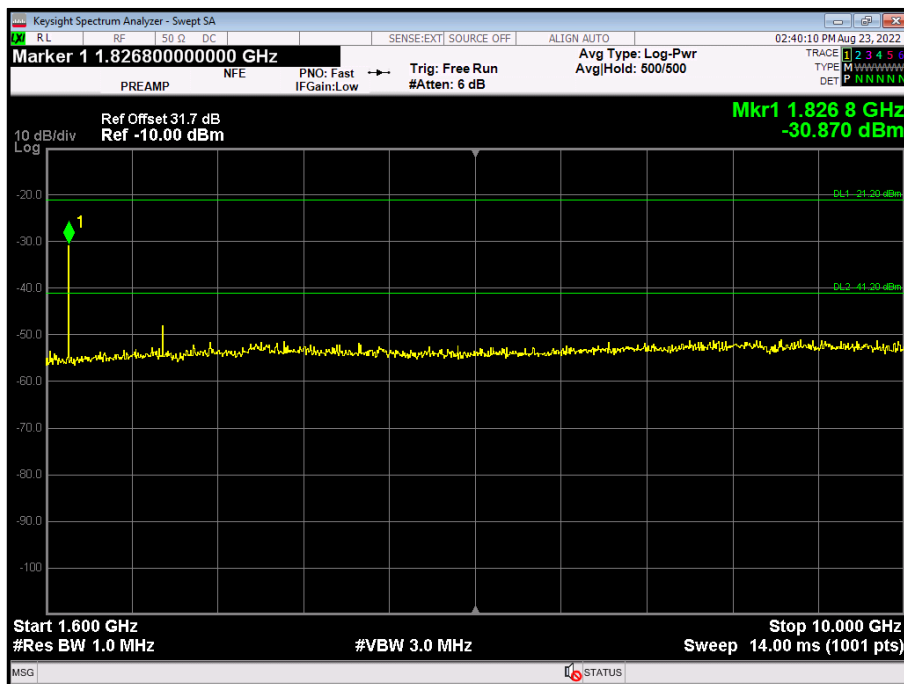

Figure 35 - Restricted Band - Peak, 1.6 GHz to 10 GHz, 914.75 MHz

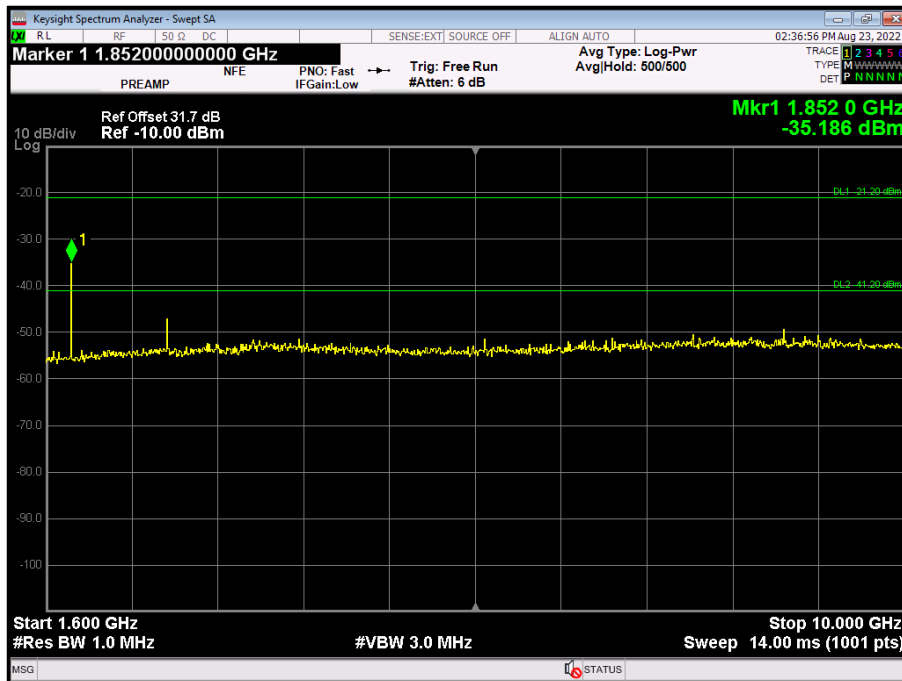

Figure 36 - Restricted Band - Peak, 1.6 GHz to 10 GHz, 927.25 MHz

FCC 47 CFR Part 15, Limit Clause 15.247 (d)

In any 100 kHz bandwidth outside the frequency band in which the spread spectrum or digitally modulated intentional radiator is operating, the radio frequency power that is produced by the intentional radiator shall be at least 20 dB below that in the 100 kHz bandwidth within the band that contains the highest level of the desired power, based on either an RF conducted or a radiated measurement, provided the transmitter demonstrates compliance with the peak conducted power limits. If the transmitter complies with the conducted power limits based on the use of RMS averaging over a time interval, as permitted under paragraph (b)(3) of this section, the attenuation required under this paragraph shall be 30 dB instead of 20 dB.

Attenuation below the general limits specified in § 15.209(a) is not required. In addition, radiated emissions which fall in the restricted bands, as defined in § 15.205(a), must also comply with the radiated emission limits specified in 15.209(a)

ISED RSS-247, Limit Clause 5.5

In any 100 kHz bandwidth outside the frequency band in which the spread spectrum or digitally modulated device is operating, the RF power that is produced shall be at least 20 dB below that in the 100 kHz bandwidth within the band that contains the highest level of the desired power, based on either an RF conducted or a radiated measurement, provided that the transmitter demonstrates compliance with the peak conducted power limits. If the transmitter complies with the conducted power limits based on the use of root-mean-square averaging over a time interval, as permitted under Section 5.4(4), the attenuation required shall be 30 dB instead of 20 dB. Attenuation below the general field strength limits specified in RSS-Gen is not required.

In addition, radiated emissions which fall in the restricted bands, as defined in RSS-GEN, clause 8.10, must also comply with the radiated emission limits specified in RSS-GEN clause 8.9.



2.7.7 Test Location and Test Equipment Used

This test was carried out in RF Laboratory 2.

Instrument	Manufacturer	Type No	TE No	Calibration Period (months)	Calibration Expires
Network Analyser	Rohde & Schwarz	ZVA 40	3548	12	24-Feb-2023
Multimeter	Fluke	177	3833	12	16-Dec-2022
Calibration Unit	Rohde & Schwarz	ZV-Z54	4368	12	24-Feb-2023
Frequency Standard	Spectracom	SecureSync 1200-0408-0601	4393	6	01-Feb-2023
1 metre K-Type Cable	Florida Labs	KMS-180SP-39.4-KMS	4520	12	18-Nov-2022
PXA Signal Analyser	Keysight Technologies	N9030A	4654	12	24-Nov-2022
High Pass filter	Wainwright	WHKX12-1290-1500-18000-80SS	4962	12	19-May-2023
AC Programmable Power Supply	iTech	IT7324	5227	-	O/P Mon
Thermo-Hygro-Barometer	PCE Instruments	PCE-THB-40	5475	12	25-Apr-2023
Attenuator 5W 30dB DC-18GHz	Aaren	AT40A-4041-D18-30	5502	12	21-Apr-2023

Table 29

O/P Mon – Output Monitored using calibrated equipment



2.8 Spurious Radiated Emissions

2.8.1 Specification Reference

FCC 47 CFR Part 15C, Clause 15.247 (d) and 15.209
ISED RSS-247, Clause 3.3 and 5.5
ISED RSS-GEN, Clause, 6.13 and 8.9

2.8.2 Equipment Under Test and Modification State

FR 9380 (8-port FCC), S/N: 10510422-0074 - Modification State 0
FR 9380 (8-port FCC), S/N: 10510422-0074 - Modification State 1

2.8.3 Date of Test

27-March-2022 to 31-July-2022

2.8.4 Test Method

This test was performed in accordance with ANSI C63.10, clause 6.3, 6.5 and 6.6.

For frequencies > 1 GHz, plots for average measurements were taken in accordance with ANSI C63.10, clause 4.1.5.2.6 to characterize the EUT. Where emissions were detected, final average measurements were taken in accordance with ANSI C63.10, clause 4.1.5.2.2. A duty cycle correction factor has been added to the CISPR Average measurements.

The EUT was placed on the non-conducting platform in a manner typical of a normal installation.

Ports on the EUT were terminated with loads as described in ANSI C63.4 clause 6.2.4. For EUT's with multiple connectors of the same type, additional interconnecting cables were connected, and pre-scans performed to determine whether the level of the emissions were increased by >2 dB.

The plots shown are the characterisation of the EUT. The limits on the plots represent the most stringent case for restricted bands, (74/54 dBuV/m) when compared to 20 dBc outside restricted bands. The limits shown have been used as a threshold to determine where further measurements are necessary. Where results are within 10 dB of the limits shown on the plots, further investigation was carried out and reported in results tables.

The following conversion can be applied to convert from dB μ V/m to μ V/m:

$10^{(\text{Field Strength in dB}\mu\text{V/m}/20)}$.

Where formal measurements have been necessary, the results have been presented in the emissions table.

For testing below 1 GHz, the EUT has been powered by a linear power supply. Above 1 GHz, the EUT has been powered by the supplied SMPSU.

2.8.5 Example Test Setup Diagram

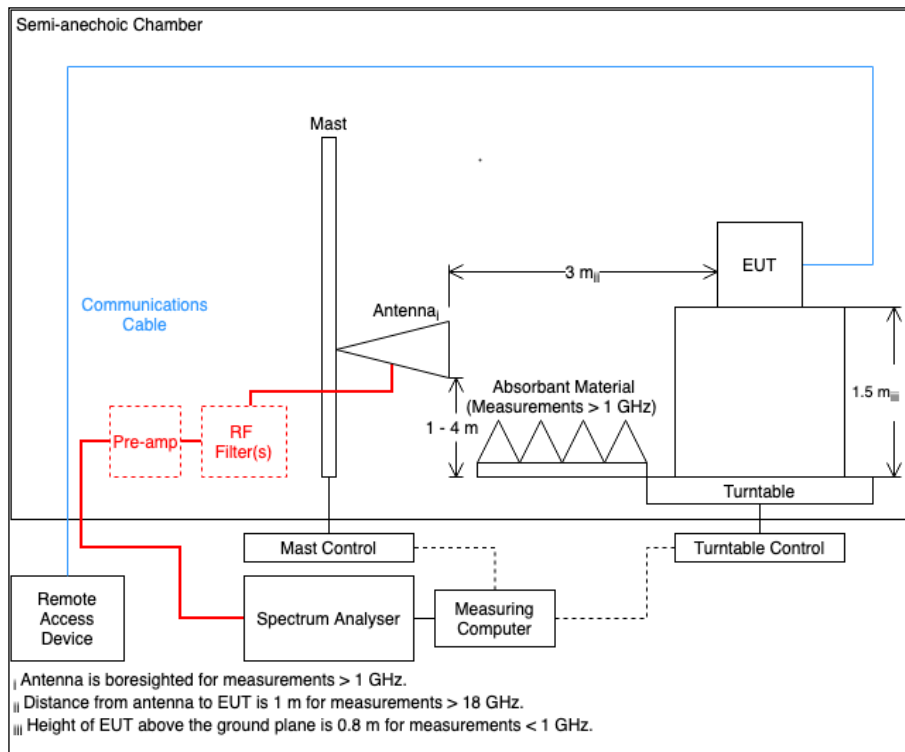

Figure 37

2.8.6 Environmental Conditions

Ambient Temperature	19.3 - 24.1 °C
Relative Humidity	27.5 - 44.0 %



2.8.7 Test Results

RFID Transceiver

Frequency (MHz)	Level (dBµV/m)	Limit (dBµV/m)	Margin (dB)	Detector	Angle (°)	Height (cm)	Polarisation	Orientation
324.779	43.33	46.02	2.69	Q-Peak	61	104	Horizontal	N/A
329.622	42.02	46.02	4.00	Q-Peak	279	100	Horizontal	N/A

Table 30 - 902.75 MHz, 30 MHz to 1 GHz

No other emissions were detected within 10 dB of the limit.

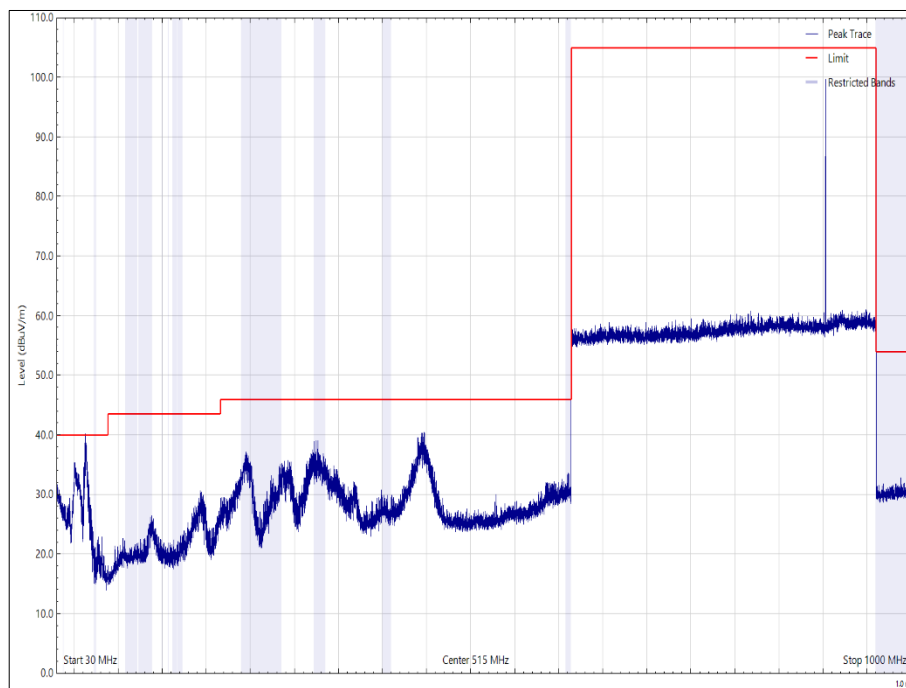

Figure 38 - 902.75 MHz, 30 MHz to 1 GHz, Vertical, N/A Orientation

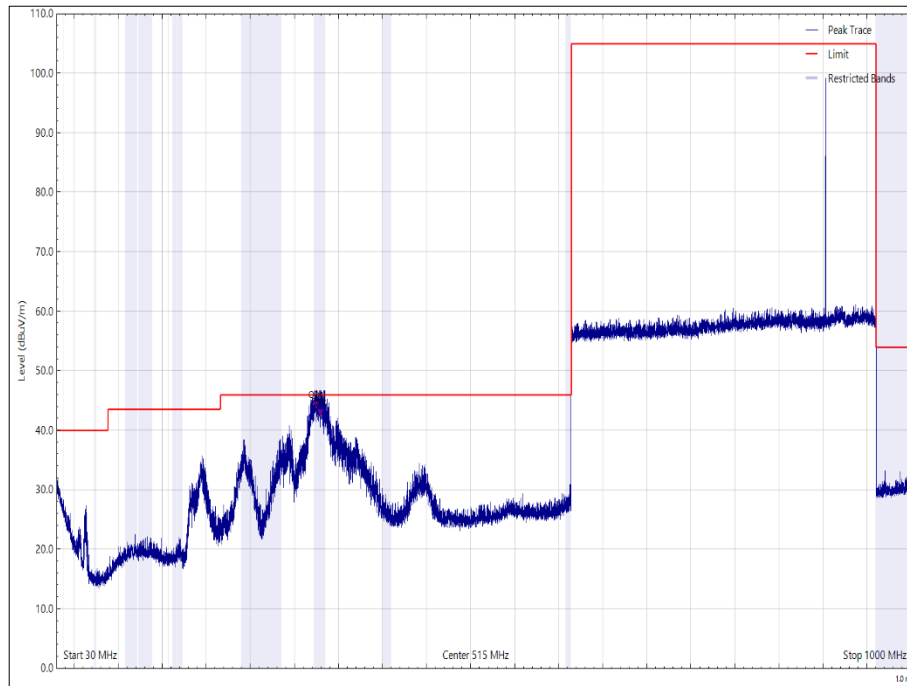

Figure 39 - 902.75 MHz, 30 MHz to 1 GHz, Horizontal, N/A Orientation



Frequency (MHz)	Level (dBµV/m)	Limit (dBµV/m)	Margin (dB)	Detector	Angle (°)	Height (cm)	Polarisation	Orientation
2708.276	48.16	53.98	5.82	CISPR Average	341	100	Vertical	N/A
2708.094	44.69	53.98	9.29	CISPR Average	48	107	Horizontal	N/A

Table 31 - 902.75 MHz, 1 GHz to 10 GHz

No other emissions were detected within 10 dB of the limit.

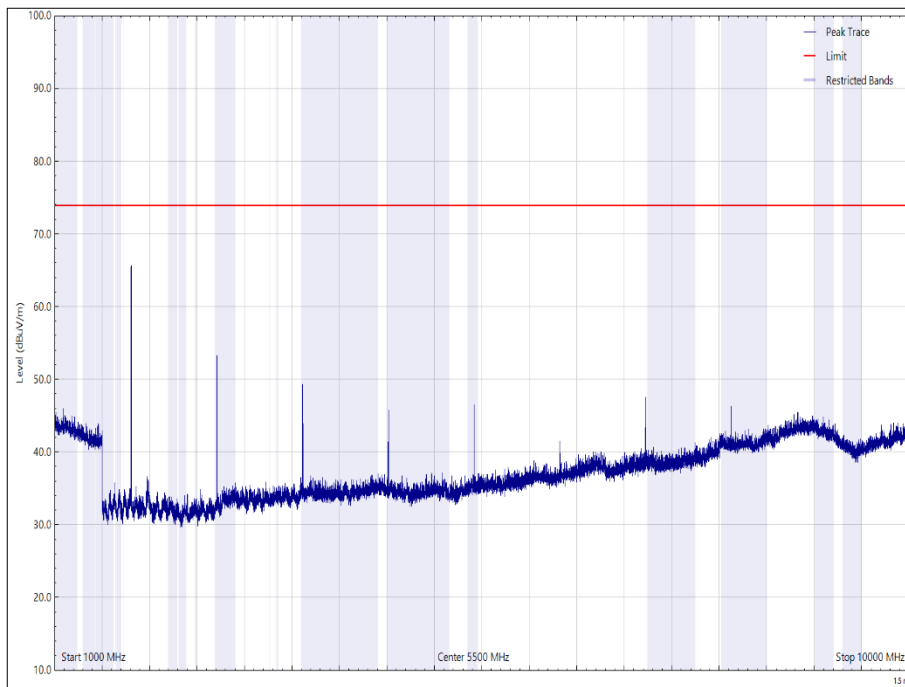

Figure 40 - 902.75 MHz, 1 GHz to 10 GHz, Vertical, N/A Orientation - Peak

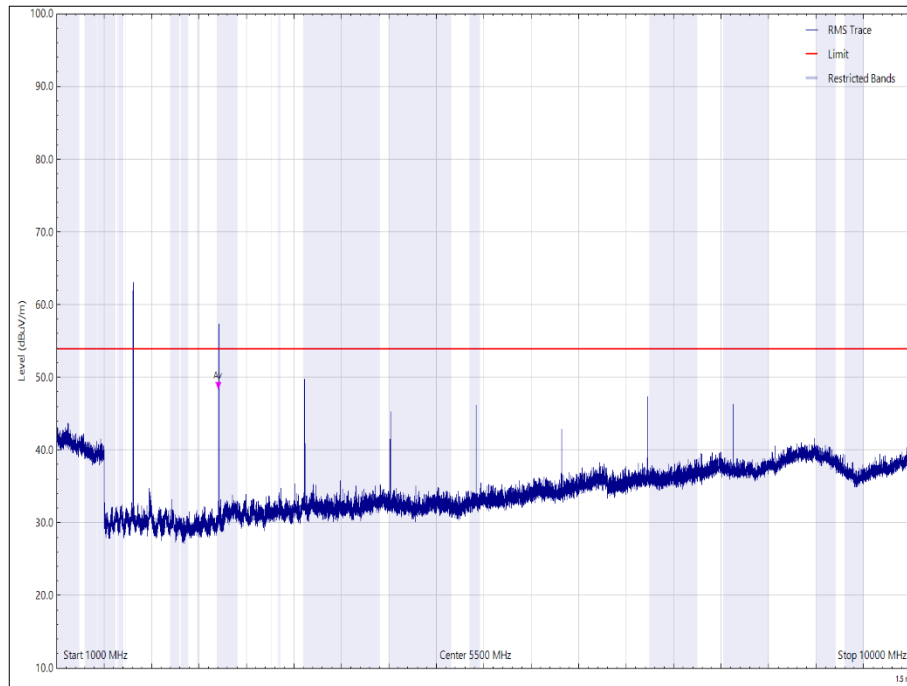

Figure 41 - 902.75 MHz, 1 GHz to 10 GHz, Vertical, N/A Orientation - Average

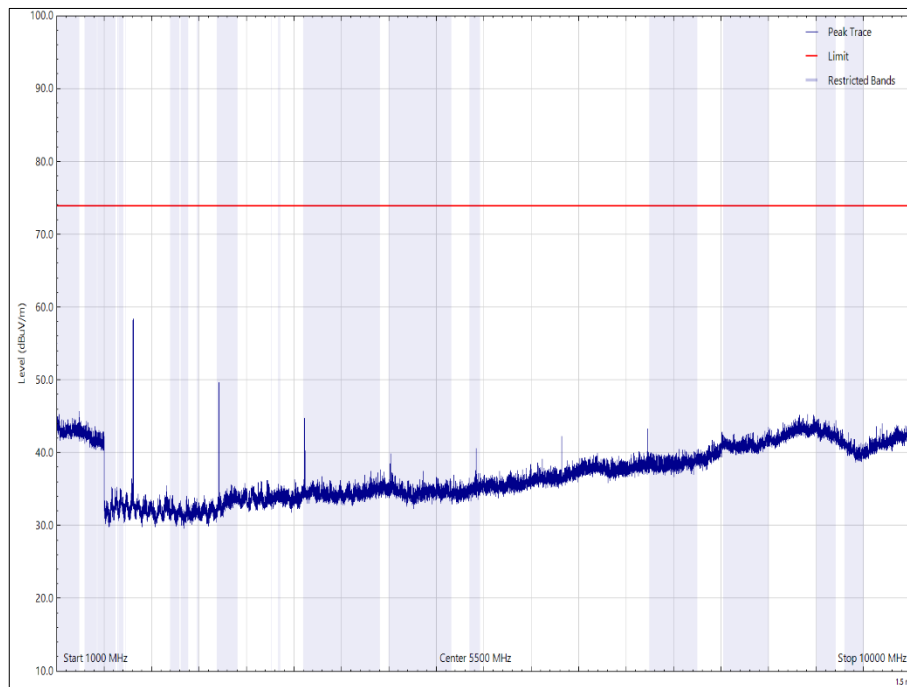

Figure 42 - 902.75 MHz, 1 GHz to 10 GHz, Horizontal, N/A Orientation - Peak

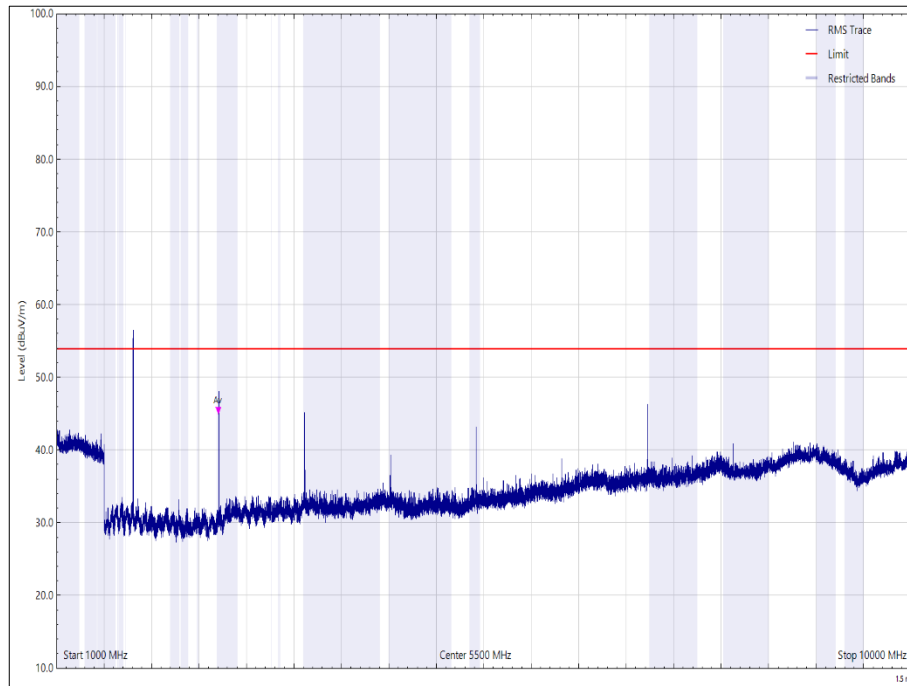

Figure 43 - 902.75 MHz, 1 GHz to 10 GHz, Horizontal, N/A Orientation - Average



Frequency (MHz)	Level (dBµV/m)	Limit (dBµV/m)	Margin (dB)	Detector	Angle (°)	Height (cm)	Polarisation	Orientation
321.738	38.02	46.02	8.00	Q-Peak	360	353	Vertical	N/A
325.563	43.70	46.02	2.32	Q-Peak	60	100	Horizontal	N/A
328.257	41.91	46.02	4.11	Q-Peak	272	100	Horizontal	N/A

Table 32 - 914.75 MHz, 30 MHz to 1 GHz

No other emissions were detected within 10 dB of the limit.

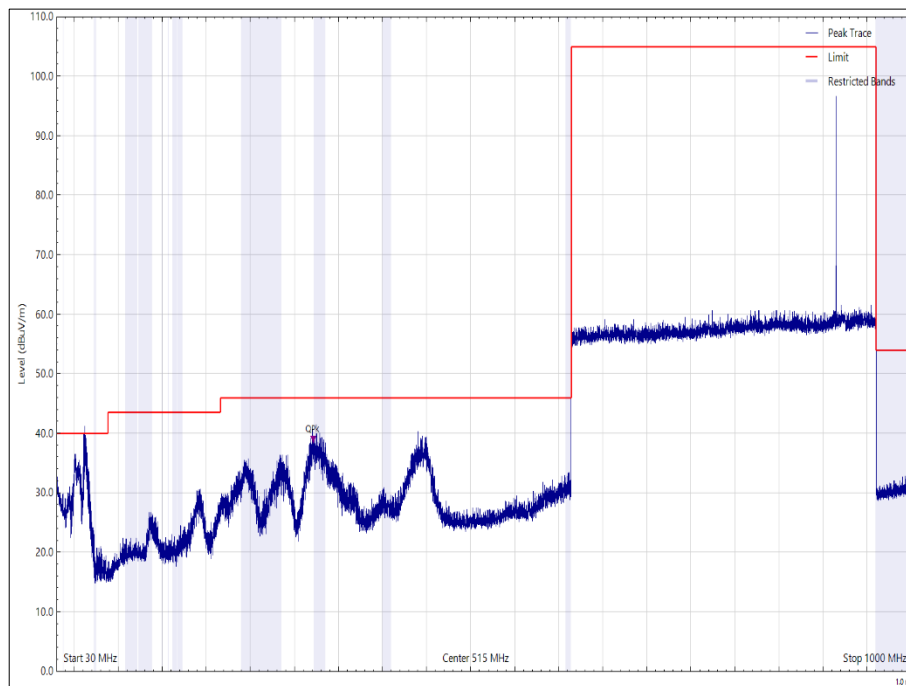

Figure 44 - 914.75 MHz, 30 MHz to 1 GHz, Vertical, N/A Orientation

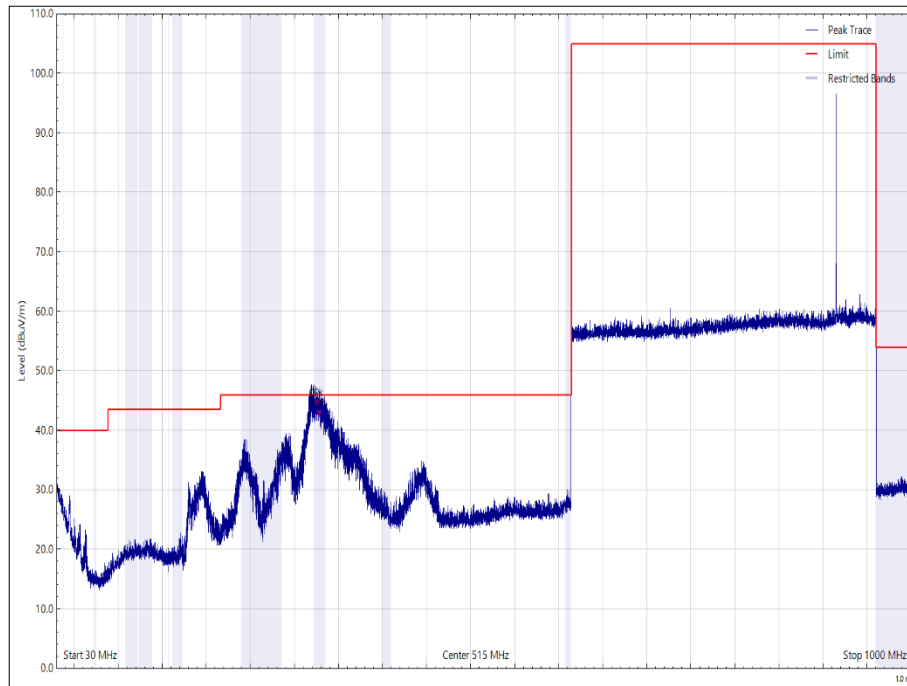

Figure 45 - 914.75 MHz, 30 MHz to 1 GHz, Horizontal, N/A Orientation



Frequency (MHz)	Level (dBµV/m)	Limit (dBµV/m)	Margin (dB)	Detector	Angle (°)	Height (cm)	Polarisation	Orientation
2744.312	48.94	53.98	5.04	CISPR Average	32	108	Vertical	N/A
3658.689	47.58	53.98	6.40	CISPR Average	300	105	Vertical	N/A

Table 33 - 914.75 MHz - 1 GHz to 10 GHz

No other emissions were detected within 10 dB of the limit.

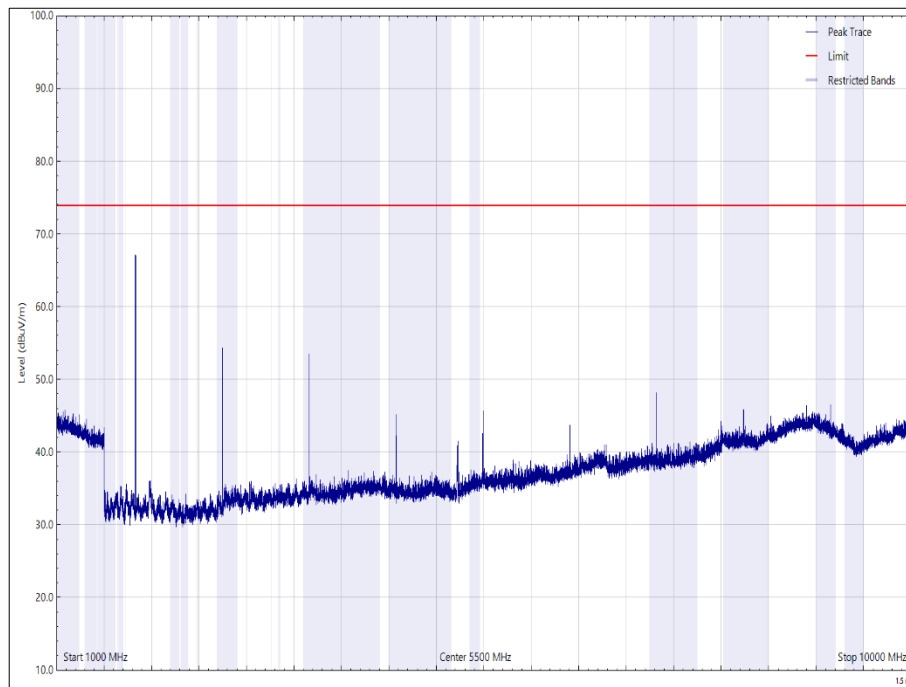

Figure 46 - 914.75 MHz - 1 GHz to 10 GHz, Vertical, N/A Orientation - Peak

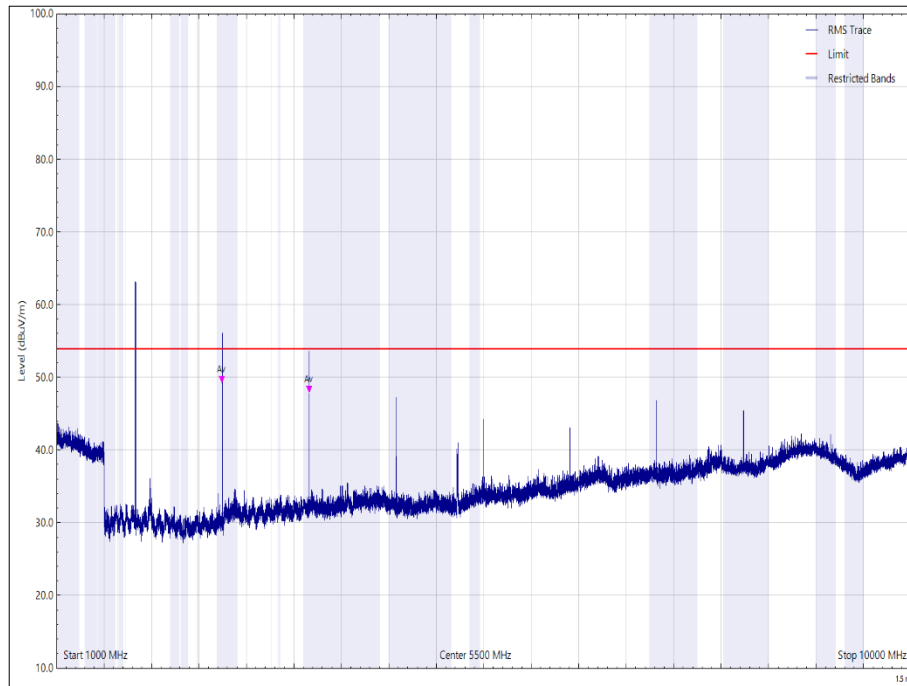

Figure 47 - 914.75 MHz - 1 GHz to 10 GHz, Vertical, N/A Orientation - Average

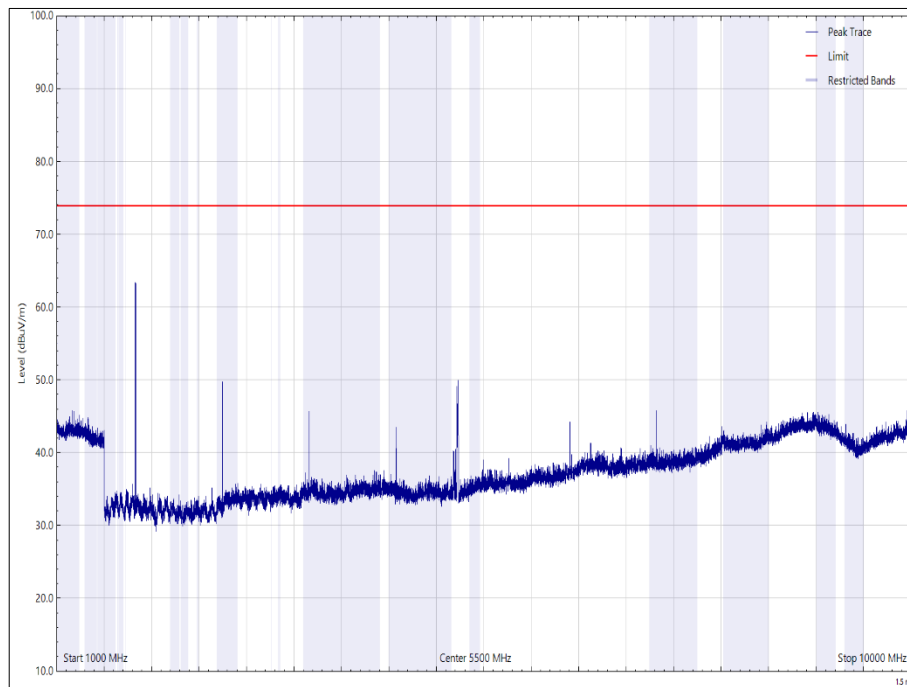

Figure 48 - 914.75 MHz - 1 GHz to 10 GHz, Horizontal, N/A Orientation - Peak

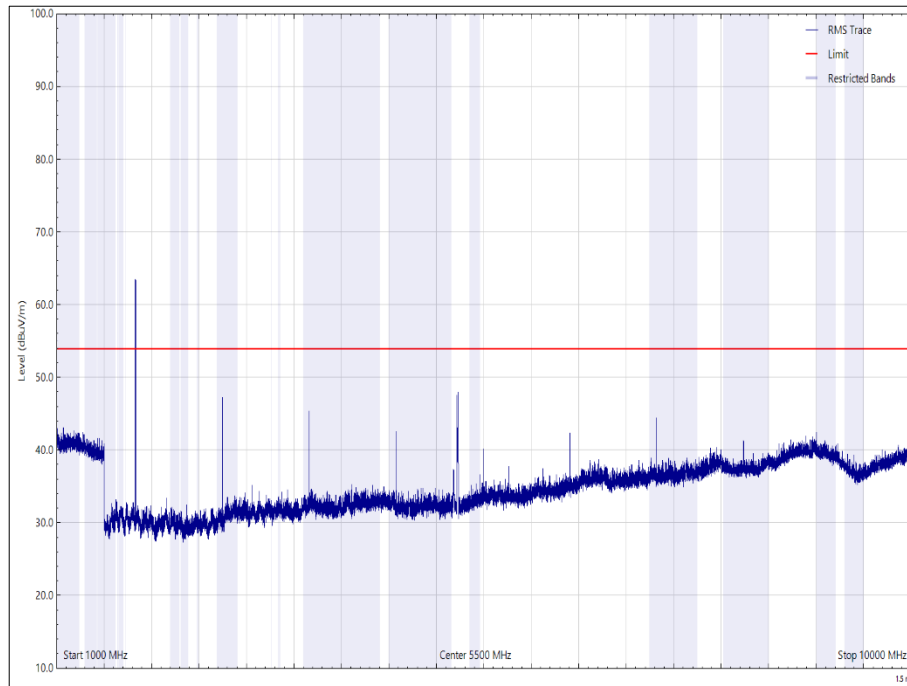

Figure 49 - 914.75 MHz - 1 GHz to 10 GHz, Horizontal, N/A Orientation - Average



Frequency (MHz)	Level (dBµV/m)	Limit (dBµV/m)	Margin (dB)	Detector	Angle (°)	Height (cm)	Polarisation	Orientation
323.333	42.21	46.02	3.81	Q-Peak	53	110	Horizontal	N/A
332.831	42.04	46.02	3.98	Q-Peak	289	100	Horizontal	N/A

Table 34 - 927.25 MHz, 30 MHz to 1 GHz

No other emissions were detected within 10 dB of the limit.

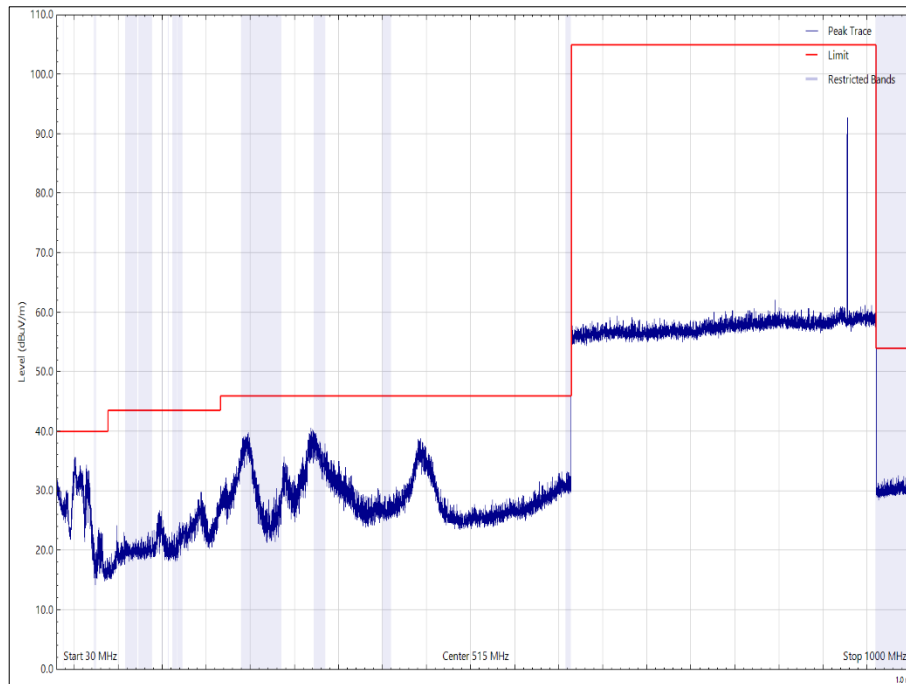

Figure 50 - 927.25 MHz, 30 MHz to 1 GHz, Vertical, N/A Orientation

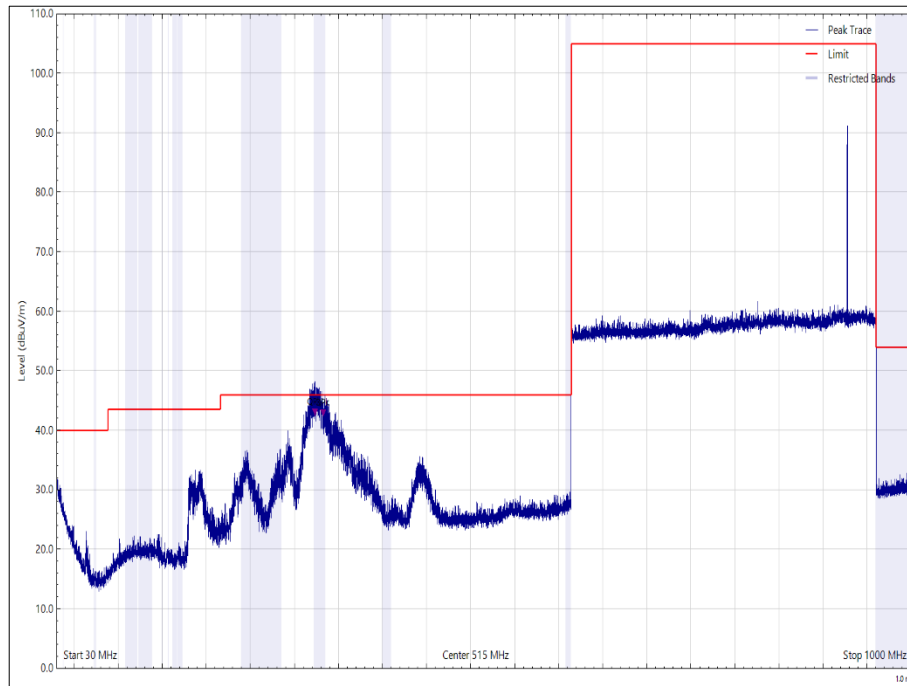

Figure 51 - 927.25 MHz, 30 MHz to 1 GHz, Horizontal, N/A Orientation



Frequency (MHz)	Level (dBµV/m)	Limit (dBµV/m)	Margin (dB)	Detector	Angle (°)	Height (cm)	Polarisation	Orientation
2781.623	49.94	53.98	4.04	CISPR Average	183	100	Vertical	N/A
2781.685	47.33	53.98	6.65	CISPR Average	87	110	Horizontal	N/A
3708.904	44.94	53.98	9.04	CISPR Average	126	120	Horizontal	N/A
3709.203	44.91	53.98	9.07	CISPR Average	203	104	Vertical	N/A
4636.269	48.02	53.98	5.96	CISPR Average	6	227	Vertical	N/A

Table 35 - 927.25 MHz - 1 GHz to 10 GHz

No other emissions were detected within 10 dB of the limit.

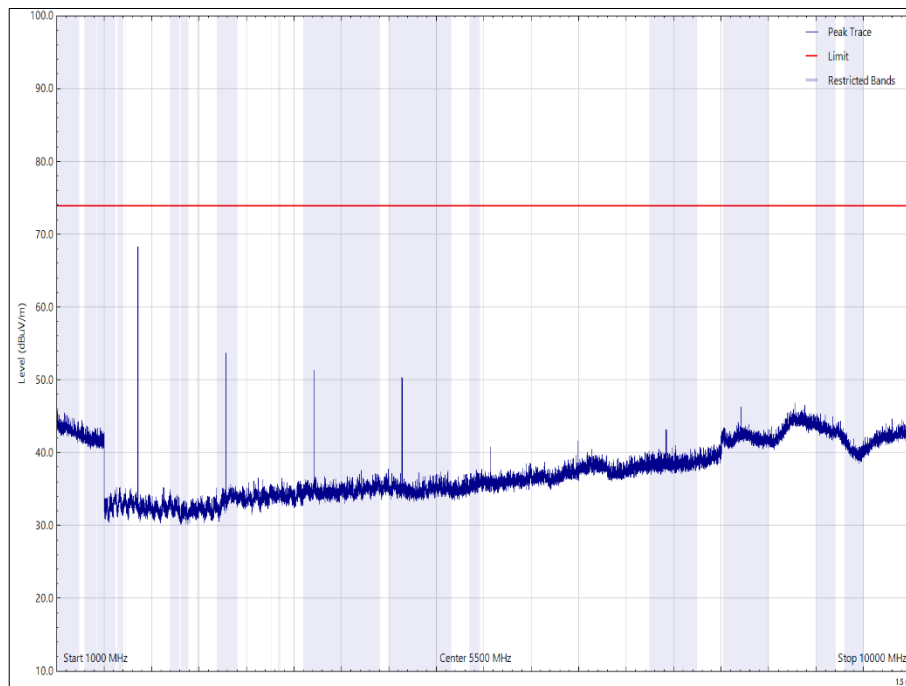

Figure 52 - 927.25 MHz - 1 GHz to 10 GHz, Vertical, N/A Orientation - Peak

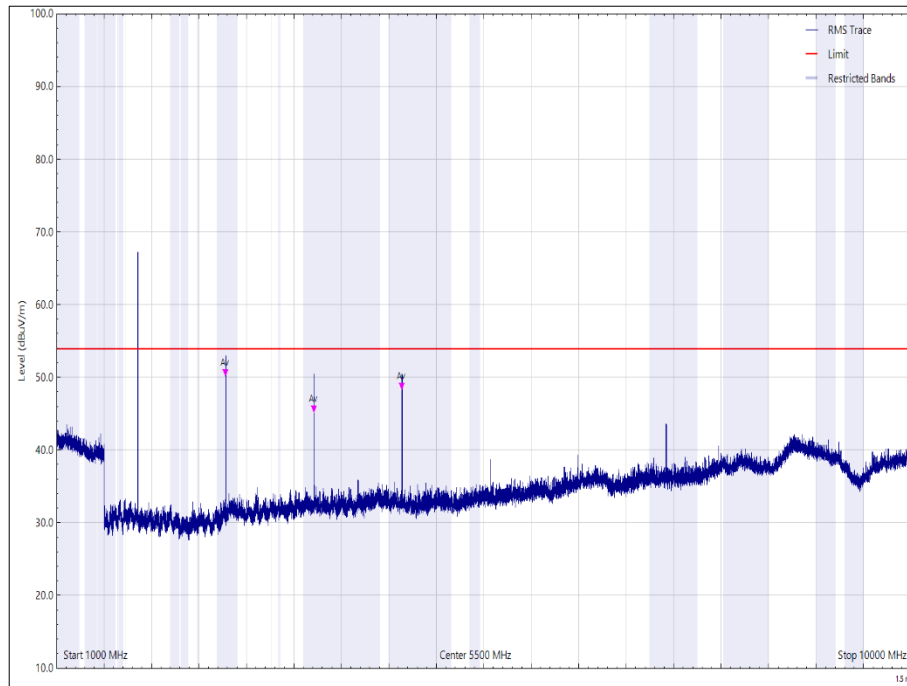

Figure 53 - 927.25 MHz - 1 GHz to 10 GHz, Vertical, N/A Orientation - Average

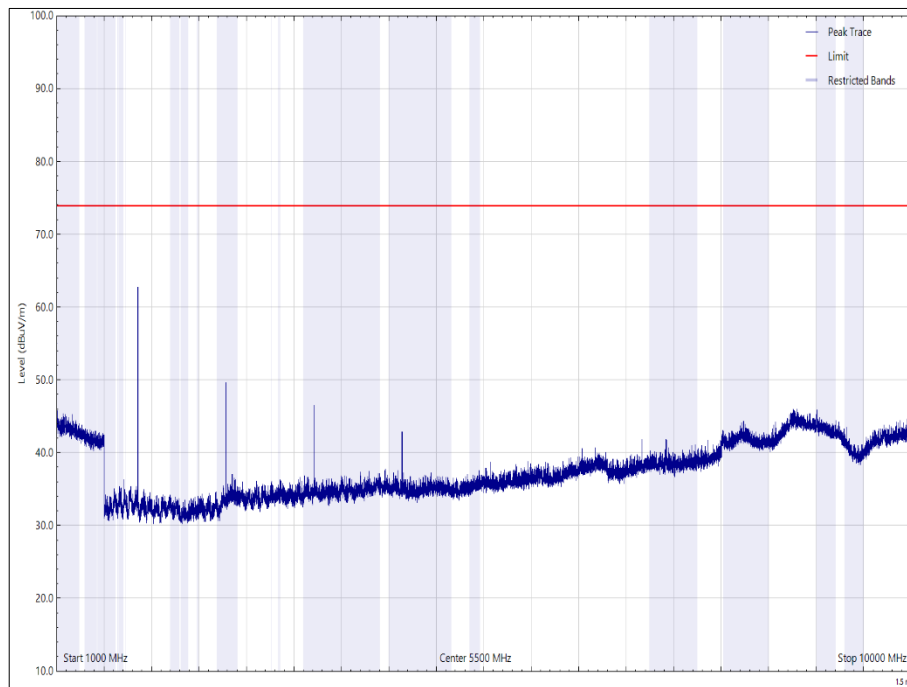

Figure 54 - 927.25 MHz - 1 GHz to 10 GHz, Horizontal, N/A Orientation - Peak

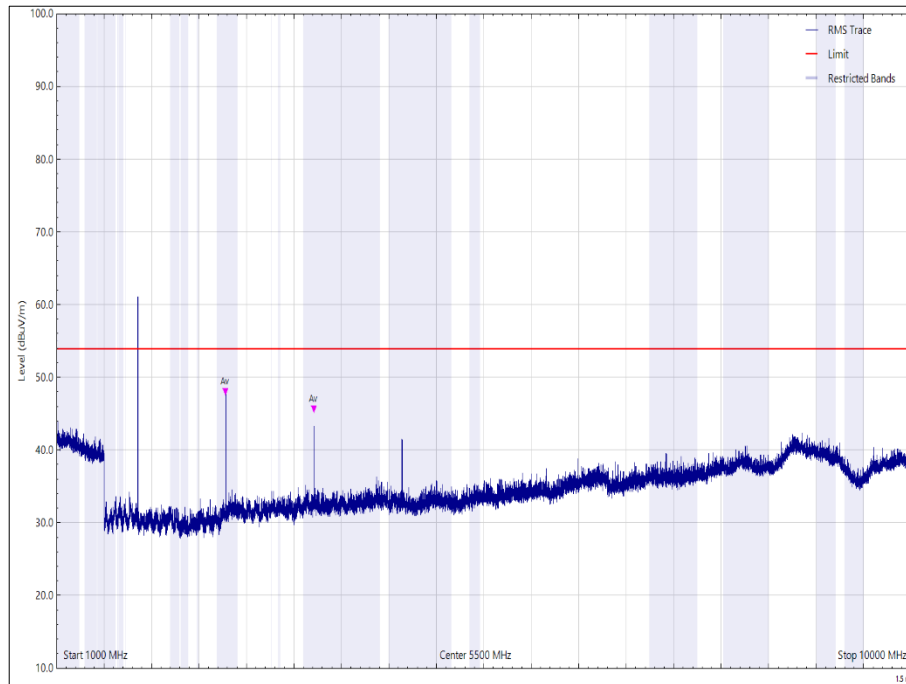

Figure 55 - 927.25 MHz - 1 GHz to 10 GHz, Horizontal, N/A Orientation - Average

FCC 47 CFR Part 15, Limit Clause 15.247 (d)

In any 100 kHz bandwidth outside the frequency band in which the spread spectrum or digitally modulated intentional radiator is operating, the radio frequency power that is produced by the intentional radiator shall be at least 20 dB below that in the 100 kHz bandwidth within the band that contains the highest level of the desired power, based on either an RF conducted or a radiated measurement, provided the transmitter demonstrates compliance with the peak conducted power limits. If the transmitter complies with the conducted power limits based on the use of RMS averaging over a time interval, as permitted under paragraph (b)(3) of this section, the attenuation required under this paragraph shall be 30 dB instead of 20 dB.

Attenuation below the general limits specified in § 15.209(a) is not required. In addition, radiated emissions which fall in the restricted bands, as defined in § 15.205(a), must also comply with the radiated emission limits specified in 15.209(a)

ISED RSS-247, Limit Clause 5.5

In any 100 kHz bandwidth outside the frequency band in which the spread spectrum or digitally modulated device is operating, the RF power that is produced shall be at least 20 dB below that in the 100 kHz bandwidth within the band that contains the highest level of the desired power, based on either an RF conducted or a radiated measurement, provided that the transmitter demonstrates compliance with the peak conducted power limits. If the transmitter complies with the conducted power limits based on the use of root-mean-square averaging over a time interval, as permitted under Section 5.4(4), the attenuation required shall be 30 dB instead of 20 dB. Attenuation below the general field strength limits specified in RSS-Gen is not required.

In addition, radiated emissions which fall in the restricted bands, as defined in RSS-GEN, clause 8.10, must also comply with the radiated emission limits specified in RSS-GEN clause 8.9.



2.8.8 Test Location and Test Equipment Used

This test was carried out in EMC Chamber 12.

Instrument	Manufacturer	Type No	TE No	Calibration Period (months)	Calibration Expires
Antenna with attenuator (Bilog, 30 MHz to 3 GHz)	Schaffner	CBL6143	287	24	14-Oct-2022
DC Power Supply	Hewlett Packard	6269B	1909	-	TU
Comb Generator	Schaffner	RSG1000	3034	-	TU
Test Receiver	Rohde & Schwarz	ESU40	3506	12	18-Mar-2022
True RMS Multimeter	Fluke	179	4006	12	29-Mar-2023
Cable (K-Type to K-Type, 2 m)	Scott Cables	KPS-1501-2000-KPS	4526	6	06-Mar-2022
High Pass filter	Wainwright	WHKX12-1290-1500-18000-80SS	4961	12	25-Mar-2022
High Pass filter	Wainwright	WHKX12-1290-1500-18000-80SS	4962	12	19-May-2023
Cable (N-Type to N-Type, 1 m)	Rosenberger	LU7-036-1000	5031	12	23-Jul-2022
Emissions Software	TUV SUD	EmX V3.1.4	5125	-	Software
Preamplifier (30dB 1GHz to 18GHz)	Schwarzbeck	BBV 9718 C	5261	12	08-Apr-2023
Pre-Amplifier (1 GHz to 18 GHz)	Schwarzbeck	BBV 9718 C	5350	12	22-Sep-2022
Cable (N-Type to N-Type, 8 m)	Teledyne	PR90-088-8MTR	5450	6	08-Mar-2022
Cable (N-Type to N-Type, 8 m)	Teledyne	PR90-088-8MTR	5450	6	06-Oct-2022
Thermo-hygro-Barometer	PCE Instruments	PCE-THB-40	5472	12	25-Mar-2023
Thermo-Hygro-Barometer	PCE Instruments	PCE-THB-40	5481	12	31-Mar-2022
Cable (K-Type to K-Type, 1 m)	Junkosha	MWX241-01000KMSKMS/A	5511	12	14-Apr-2023
Antenna (DRG, 1 GHz to 10.5 GHz)	Schwarzbeck	BBHA9120B	5611	12	15-Oct-2022
Turntable & Mast Controller	Maturo Gmbh	NCD/498/2799.01	5612	-	TU
Tilt Antenna Mast	Maturo Gmbh	TAM 4.0-P	5613	-	TU
Turntable	Maturo Gmbh	Turntable 1.5 SI-2t	5614	-	TU
Antenna (Bi-Log, 30 MHz to 1 GHz)	Teseq	CBL6111D	5615	24	16-Oct-2022
Screened Room (12)	MVG	EMC-3	5621	36	11-Aug-2023
Test Receiver	Rohde & Schwarz	ESW44	5914	12	21-Feb-2023

Table 36

TU - Traceability Unscheduled



2.9 Authorised Band Edges

2.9.1 Specification Reference

FCC 47 CFR Part 15C, Clause 15.247 (d)
ISED RSS-247, Clause, 5.5

2.9.2 Equipment Under Test and Modification State

FR 9380 (8-port FCC), S/N: 10510422-0074 - Modification State 0

2.9.3 Date of Test

07-February-2022

2.9.4 Test Method

The test was performed in accordance with ANSI C63.10, clause 6.10.4.

2.9.5 Environmental Conditions

Ambient Temperature	22.9 °C
Relative Humidity	40.0 %



2.9.6 Test Results

RFID Transceiver

Mode	Frequency (MHz)	Band Edge Frequency (MHz)	Level (dBc)
Static	902.75	902.00	62.52
Hopping	902.75	902.00	67.77
Static	927.25	928.00	65.06
Hopping	927.25	928.00	65.27

Table 37

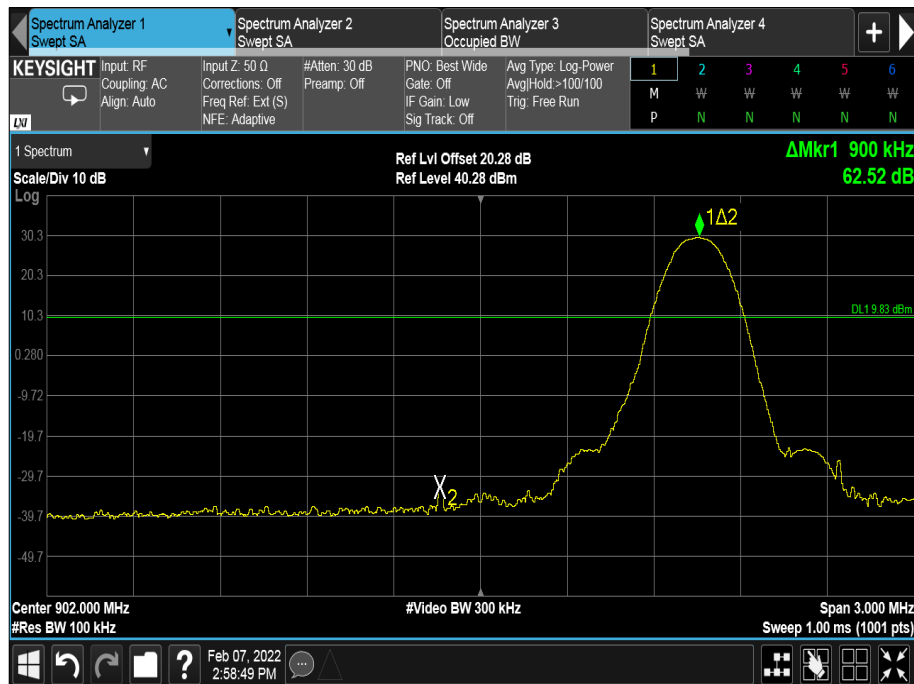

Figure 56 - Static, 902.75 MHz - Measured Frequency 902.00 MHz

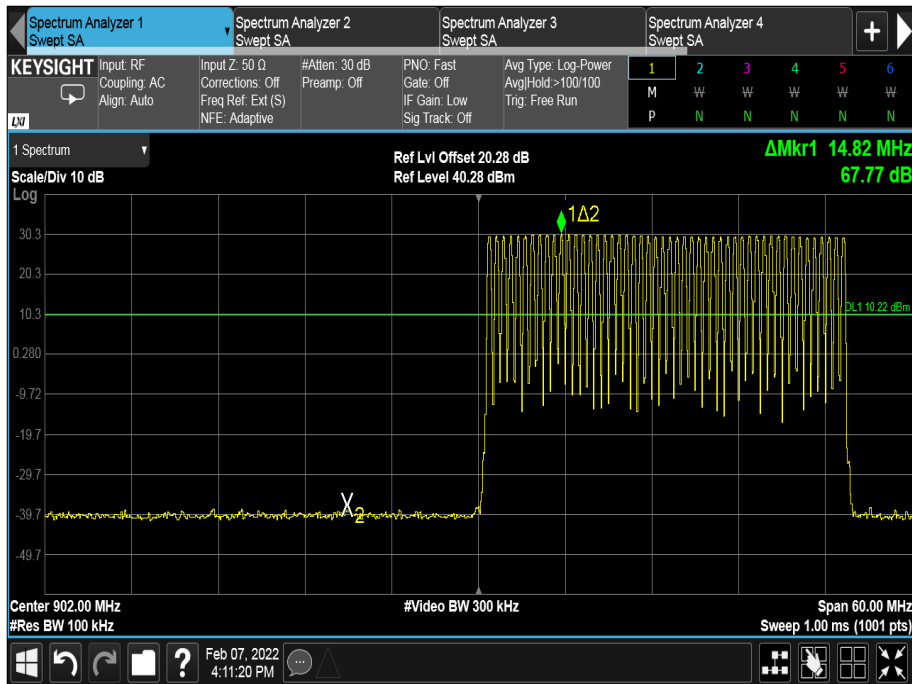

Figure 57 - Hopping, 902.75 MHz - Measured Frequency 902.00 MHz

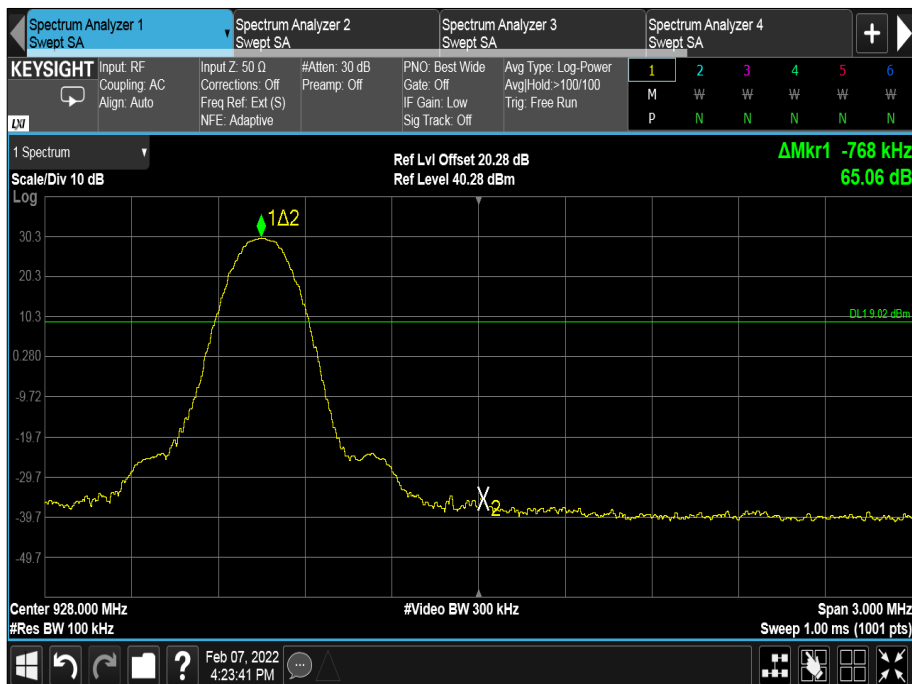

Figure 58 - Static, 927.25 MHz - Measured Frequency 928.00 MHz

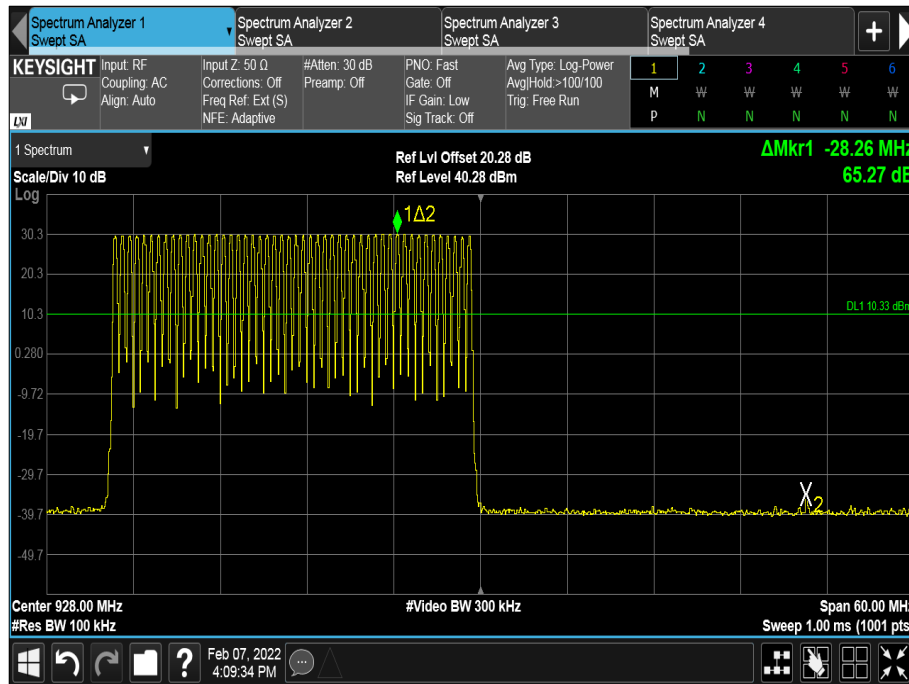

Figure 59 - Hopping, 927.25 MHz - Measured Frequency 928.00 MHz

FCC 47 CFR Part 15, Limit Clause 15.247 (d)

20 dB below the fundamental measured in a 100 kHz bandwidth using a peak detector. If the transmitter complies with the conducted power limits, based on the use of RMS averaging over a time interval, the attenuation required shall be 30 dB below the fundamental instead of 20 dB.

ISED RSS-247, Limit Clause 5.5

In any 100 kHz bandwidth outside the frequency band in which the spread spectrum or digitally modulated device is operating, the RF power that is produced shall be at least 20 dB below that in the 100 kHz bandwidth within the band that contains the highest level of the desired power, based on either an RF conducted or a radiated measurement, provided that the transmitter demonstrates compliance with the peak conducted power limits. If the transmitter complies with the conducted power limits based on the use of root-mean-square averaging over a time interval, as permitted under Section 5.4(4), the attenuation required shall be 30 dB instead of 20 dB. Attenuation below the general field strength limits specified in RSS-Gen is not required.



2.9.7 Test Location and Test Equipment Used

This test was carried out in RF Laboratory 2.

Instrument	Manufacturer	Type No	TE No	Calibration Period (months)	Calibration Expires
Multimeter	Iso-tech	IDM101	2424	12	20-Jan-2023
Frequency Standard	Spectracom	SecureSync 1200-0408-0601	4393	6	30-Jul-2022
EXA	Keysight Technologies	N9010B	4968	24	19-Jan-2024
Network Analyser	Keysight Technologies	E5063A	5018	12	30-Jul-2022
Electronic Calibration Module	Keysight Technologies	85093C	5188	12	22-Jul-2022
3.5 mm 1m Cable	Junkosha	MWX221-01000DMS	5419	12	09-Jul-2022
Thermo-Hygro-Barometer	PCE Instruments	PCE-THB-40	5475	12	06-Apr-2022
Attenuator 5W 20dB DC-18GHz	Aaren	AT40A-4041-D18-20	5500	12	14-Apr-2022
AC Programmable Power Supply	iTech	IT7324	5227	-	O/P Mon

Table 38

O/P Mon – Output monitored using calibrated test equipment.

3 Photographs

3.1 Test Setup Photographs

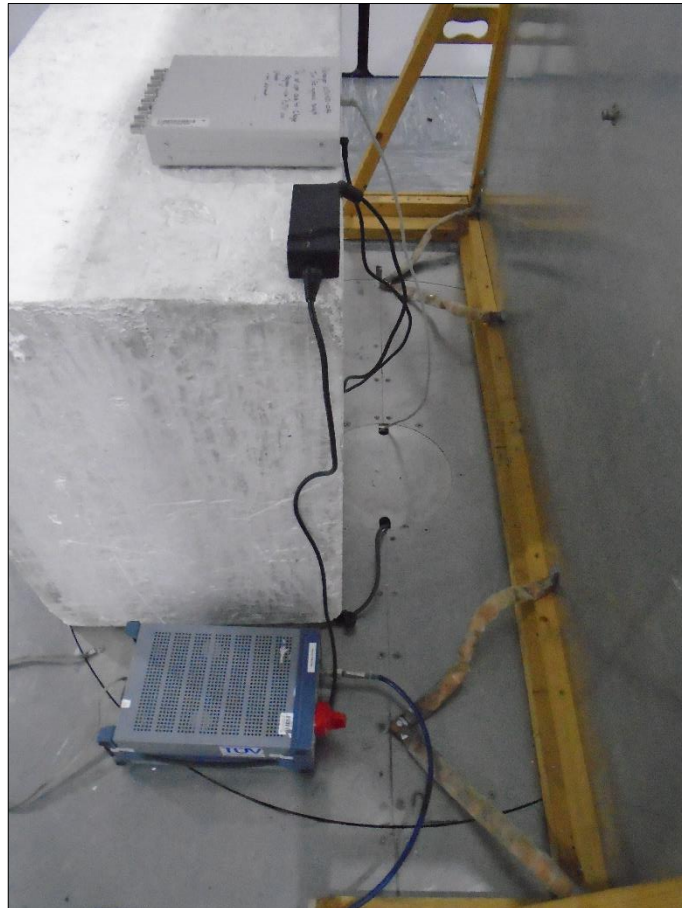

Figure 60 - AC Line Conducted Emissions



Figure 61 - AC Line Conducted Emissions

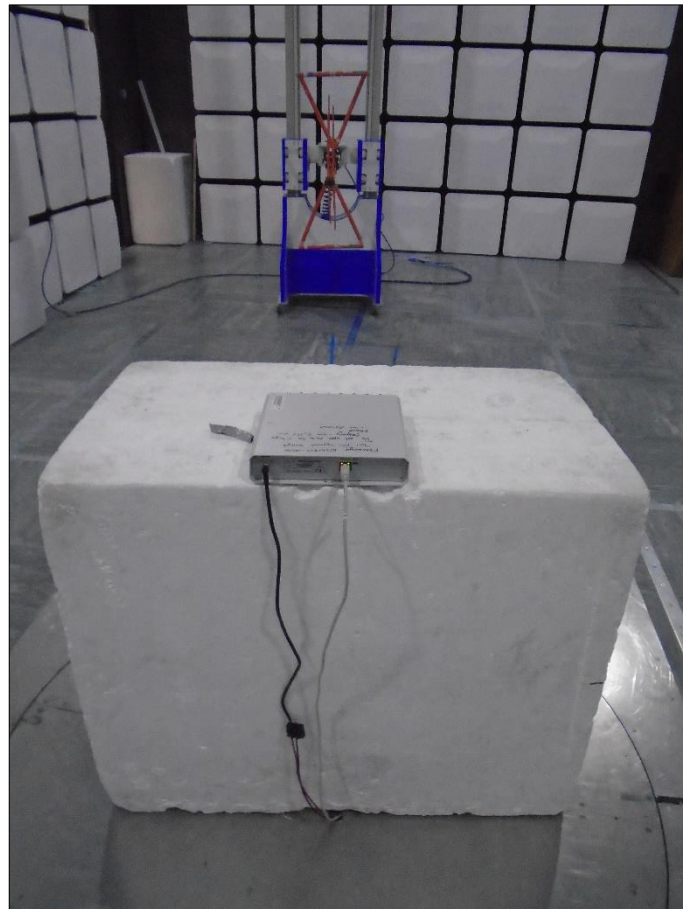

Figure 62 - Test Setup - 30 MHz to 1 GHz

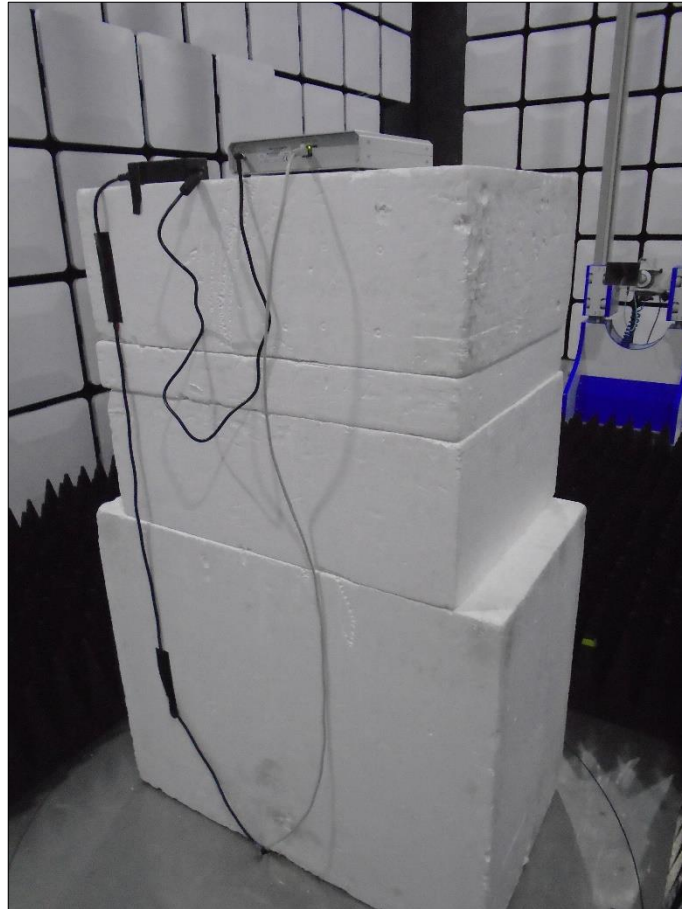

Figure 63 - Test Setup - 1 GHz to 10 GHz



4 Measurement Uncertainty

For a 95% confidence level, the measurement uncertainties for defined systems are:

Test Name	Measurement Uncertainty
AC Power Line Conducted Emissions	150 kHz to 30 MHz, LISN, ± 3.7 dB
Frequency Hopping Systems - Average Time of Occupancy	-
Frequency Hopping Systems - Channel Separation	13.325 kHz
Frequency Hopping Systems - Number of Hopping Channels	-
Frequency Hopping Systems - 20 dB Bandwidth	5.864 kHz
Maximum Conducted Output Power	± 1.38 dB
Conducted Spurious Emissions from the Antenna Port	30 MHz to 1 GHz: ± 5.2 dB 1 GHz to 40 GHz: ± 6.3 dB
Spurious Radiated Emissions	30 MHz to 1 GHz: ± 5.2 dB 1 GHz to 40 GHz: ± 6.3 dB
Authorised Band Edges	30 MHz to 1 GHz: ± 5.2 dB 1 GHz to 40 GHz: ± 6.3 dB

Table 39

Measurement Uncertainty Decision Rule – Accuracy Method

Determination of conformity with the specification limits is based on the decision rule according to IEC Guide 115:2007, Clause 4.4.3 and 4.5.1. (Procedure 2). The measurement results are directly compared with the test limit to determine conformance with the requirements of the standard.

Risk: The uncertainty of measurement about the measured result is negligible with regard to the final pass/fail decision. The measurement result can be directly compared with the test limit to determine conformance with the requirement (compare IEC Guide 115). The level of risk to falsely accept and falsely reject items is further described in ILAC-G8.