



# TEST REPORT

**Report Reference No.** .....: **TRE18070061** R/C.....: 61910

**FCC ID** .....: **2AQP-2018C200**

**Applicant's name** .....: **Shen Zhen Shi Ka Luo Jie Dian Zi Shang Wu You Xian Gong Si**

**Address** .....: 72038, 7th Floor, Gaoke Group Building, 2076 Moon Bay Avenue, Nanshan District, Shenzhen,Guangdong,China

**Manufacturer**.....: Shen zhen Shi Zhuo lian yi Dian zi shang wu You xian Gong si

**Address**.....: Fu Tian Qu Sha Tou Jie Dao Che Gong Miao Tian An Chuang Xin Cheng Ke Ji Guang Chang 1 Qi A1403-1-80 Shen Zhen, Guang Dong, China

**Test item description** .....: **two way radio**

**Trade Mark** .....: FLOUREON, Caroger

**Model/Type reference** .....: FC200

**Listed Model(s)**.....: CC200

**Standard**.....: **FCC CFR Title 47 Part 2**  
**FCC CFR Title 47 Part 95B**

**Date of receipt of test sample**.....: Jul.11, 2018

**Date of testing**.....: Jul.11, 2018 - Jul.17, 2018

**Date of issue**.....: Jul.18, 2018

**Result** .....: **PASS**

Compiled by  
( position+printed name+signature) .: File administrators Fanghui Zhu

Supervised by  
( position+printed name+signature) .: Project Engineer Edward Pan

Approved by  
( position+printed name+signature) .: RF Manager Hans Hu

**Testing Laboratory Name**.....: **Shenzhen Huatongwei International Inspection Co., Ltd.**

**Address** .....: 1/F, Bldg 3, Hongfa Hi-tech Industrial Park, Genyu Road, Tianliao, Gongming, Shenzhen, China

**Shenzhen Huatongwei International Inspection Co., Ltd. All rights reserved.**

This publication may be reproduced in whole or in part for non-commercial purposes as long as the Shenzhen Huatongwei International Inspection Co., Ltd. is acknowledged as copyright owner and source of the material. Shenzhen Huatongwei International Inspection Co., Ltd. takes no responsibility for and will not assume liability for damages resulting from the reader's interpretation of the reproduced material due to its placement and context.

*The test report merely correspond to the test sample.*

## Contents

<b><u>1</u></b>	<b><u>TEST STANDARDS AND REPORT VERSION</u></b>	<b><u>3</u></b>
1.1.	Test Standards	3
1.2.	Report revised information	3
<b><u>2</u></b>	<b><u>TEST DESCRIPTION</u></b>	<b><u>4</u></b>
<b><u>3</u></b>	<b><u>SUMMARY</u></b>	<b><u>5</u></b>
3.1	Client Information	5
3.2	Product Description	5
3.3	Test frequency list	6
3.4	Operation mode	7
3.5	EUT configuration	7
<b><u>4</u></b>	<b><u>TEST ENVIRONMENT</u></b>	<b><u>8</u></b>
4.1	Address of the test laboratory	8
4.2	Test Facility	8
4.3	Environmental conditions	9
4.4	Statement of the measurement uncertainty	9
4.5	Equipments Used during the Test	10
<b><u>5</u></b>	<b><u>TEST CONDITIONS AND RESULTS</u></b>	<b><u>12</u></b>
5.1	Carrier Output Power (ERP)	12
5.2	99% Occupied Bandwidth & 26dB Bandwidth	14
5.3	Emission Mask	15
5.4	Modulation Limit	16
5.5	Audio Frequency Response	17
5.6	Frequency stability VS Temperature	19
5.7	Frequency stability VS Voltage	20
5.8	Transmitter Radiated Spurious Emission	21
<b><u>6</u></b>	<b><u>TEST SETUP PHOTOS OF THE EUT</u></b>	<b><u>26</u></b>
<b><u>7</u></b>	<b><u>EXTERNAL AND INTERNAL PHOTOS OF THE EUT</u></b>	<b><u>27</u></b>
<b><u>8</u></b>	<b><u>APPENDIX REPORT</u></b>	<b><u>31</u></b>

# **1 TEST STANDARDS AND REPORT VERSION**

## **1.1. Test Standards**

The tests were performed according to following standards:

[FCC Rules Part 2](#): Frequency allocations and radio treaty matters; General rules and regulations

[FCC Rules Part 95B](#): PERSONAL RADIO SERVICES-Family Radio Service (FRS)

[ANSI C63.10-2013](#): American National Standard of Procedures for Compliance Testing of Unlicensed Wireless Devices.

[ANSI/TIA-603-E\(2016\)](#): Land Mobile FM or PM Communications Equipment and Performance Standards

[ANSI C63.4-2014](#): American National Standard for Methods of Measurement of Radio-Noise Emissions from Low-Voltage Electrical and Electronic Equipment in the Range of 9 kHz to 40 GHz

## **1.2. Report revised information**

Revised No.	Date of issued	Description
N/A	2018-07-18	Original

## 2 TEST DESCRIPTION

Test Item	Section in CFR 47	Result	Test Engineer
Carrier Output Power(ERP)	Part 95.567 Part 2.1046(a)	Pass	Jinquan Wu
99% Occupied Bandwidth & 26dB bandwidth	Part 95.573 Part 2.1049	Pass	Jinquan Wu
Emission Mask	Part 95.579(a)(1)(2)(3) Part 2.1049	Pass	Jinquan Wu
Modulation Limit	Part 95.575 Part 2.1047(b)	Pass	Jinquan Wu
Audio Frequency Response	Part 95.575 Part 2.1047(a)	Pass	Jinquan Wu
Frequency Stability V.S. Temperature	Part 95.565 Part 2.1055	Pass	Jinquan Wu
Frequency Stability V.S. Voltage	Part 95.565 Part 2.1055	Pass	Jinquan Wu
Transmit Radiated Spurious Emission	Part 95.579(a)(3) Part 2.1053	Pass	Jiuru Pan

### 3 SUMMARY

#### 3.1 Client Information

Applicant:	Shen Zhen Shi Ka Luo Jie Dian Zi Shang Wu You Xian Gong Si
Address:	72038, 7th Floor, Gaoke Group Building, 2076 Moon Bay Avenue, Nanshan District, Shenzhen,Guangdong,China
Manufacturer:	Shen zhen Shi Zhuo lian yi Dian zi shang wu You xian Gong si
Address:	Fu Tian Qu Sha Tou Jie Dao Che Gong Miao Tian An Chuang Xin Cheng Ke Ji Guang Chang 1 Qi A1403-1-80 Shen Zhen, Guang Dong, China

#### 3.2 Product Description

Name of EUT:	two way radio
Trade mark:	FLOUREON, Caroger
Model/Type reference:	FC200
Listed model(s):	CC200
Power supply:	DC 4.50V
Battery information:	-
Audio accessory:	-
Charger information:	-
Adapter information:	-
Hardware version:	V1.0
Software version:	V1.0
<b>RF Specification</b>	
Support Frequency Range:	462.5625MHz~ 462.7125MHz
	467.5625MHz~ 467.7125MHz
	462.5500MHz~ 462.7250MHz
Rated Output Power <sup>*2</sup> :	0.5W(27dBm), 1W(30dBm)
Modulation Type:	FM(Analog)
Emission Designator: <sup>*1</sup>	11K0F3E
Antenna Type:	Omni-direction Antenna

Note:

(1) <sup>\*1</sup> According to FCC Part 2.202 requirements, the Necessary Bandwidth is calculated as follows:

- For FM Voice Modulation

Channel Spacing = 12.5 KHz, D = 2.5 KHz max, K = 1, M = 3 KHz

$B_n = 2M + 2DK = 2*3 + 2*2.5*1 = 11 \text{ KHz}$

Emission designation: 11K0F3E

(2) The device only supports voice communication.

(3) The device has no gain and vertically polarized antenna.

(4) <sup>\*2</sup> According to FCC Part 95.567 Each FRS transmitter type must be designed such that the effective radiated power (ERP) on channels 8 through 14 does not exceed 0.5 Watts and the ERP on channels 1 through 7 and 15 through 22 does not exceed 2.0 Watts.

### 3.3 Test frequency list

According to ANSI C63.26 section 5.1.2.1:

Measurements of transmitters shall be performed and, if required, reported for each frequency band in which the EUT can be operated with the device transmitting at the number of frequencies in each band specified in Table 2.

Frequency range over which EUT operates	Number of frequencies	Location in frequency range of operation
1 MHz or less	1	Middle
1 MHz to 10 MHz	2	1 near top and 1 near bottom
More than 10 MHz	3	1 near top, 1 near middle, and 1 near bottom

Frequency Bands (MHz)	Test Channel	Test Frequency (MHz)
462.5625~462.7125	CH <sub>M1</sub>	462.6375(CH4)
467.5625~467.7125	CH <sub>M2</sub>	467.6375(CH11)
462.5500~462.7250	CH <sub>M3</sub>	462.6500(CH19)

The Product channel frequency table:

Channel No.	Center frequency (MHz)	Channel No.	Center frequency (MHz)
1	462.5625	12	467.6625
2	462.5875	13	467.6875
3	462.6125	14	467.7125
4	462.6375	15	462.5500
5	462.6625	16	462.5750
6	462.6875	17	462.6000
7	462.7125	18	462.6250
8	467.5625	19	462.6500
9	467.5875	20	462.6750
10	467.6125	21	462.7000
11	467.6375	22	462.7250

### 3.4 Operation mode

Test mode	Transmitting	FRS
		12.5kHz (Analog)
TX-FRS	√	√

Note:

√: is operation mode.

Modulation Type	Description
UM	Un-modulation
AM2	Apply a 1000 Hz tone and adjust the audio frequency generator to produce 20% of the rated system deviation.
AM6	Apply a 1000 Hz modulating signal to the transmitter from the audio frequency generator, and adjust the level to obtain 60% of full rated system deviation, then increase the level from the audio generator by 20 dB
AM5	Modulate the transmitter with a 2500 Hz sine wave at an input level 16 dB greater than that necessary to produce 50% of rated system deviation.

Test item	Modulation Type	Test mode
Output Power(ERP)	UM	TX-FRS
99% Occupied Bandwidth & 26dB bandwidth	AM6	TX-FRS
Emission Mask	AM5	TX-FRS
Modulation Limit	AM6	TX-FRS
Audio Frequency Response	AM2	TX-FRS
Frequency Stability VS Temperature	UM	TX-FRS
Frequency Stability VS Voltage	UM	TX-FRS
Transmit Radiated Spurious Emission	AM5	TX-FRS

### 3.5 EUT configuration

The following peripheral devices and interface cables were connected during the measurement:

- - supplied by the manufacturer
- - supplied by the lab

○	Power Cable	Length (m) :	/
		Shield :	/
		Detachable :	/
○	Multimeter	Manufacturer :	/
		Model No. :	/

## **4 TEST ENVIRONMENT**

### **4.1 Address of the test laboratory**

Laboratory: Shenzhen Huatongwei International Inspection Co., Ltd.

Address: 1/F, Bldg 3, Hongfa Hi-tech Industrial Park, Genyu Road, Tianliao, Gongming, Shenzhen, China

### **4.2 Test Facility**

The test facility is recognized, certified, or accredited by the following organizations:

#### **CNAS-Lab Code: L1225**

Shenzhen Huatongwei International Inspection Co., Ltd. has been assessed and proved to be in compliance with CNAS-CL01 Accreditation Criteria for Testing and Calibration Laboratories (identical to ISO/IEC17025: 2005 General Requirements) for the Competence of Testing and Calibration Laboratories.

#### **A2LA-Lab Cert. No. 3902.01**

Shenzhen Huatongwei International Inspection Co., Ltd. EMC Laboratory has been accredited by A2LA for technical competence in the field of electrical testing, and proved to be in compliance with ISO/IEC 17025: 2005 General Requirements for the Competence of Testing and Calibration Laboratories and any additional program requirements in the identified field of testing.

#### **FCC-Registration No.: 762235**

Shenzhen Huatongwei International Inspection Co., Ltd. EMC Laboratory has been registered and fully described in a report filed with the FCC (Federal Communications Commission). The acceptance letter from the FCC is maintained in our files. Registration 762235.

#### **IC-Registration No.: 5377B-1**

Two 3m Alternate Test Site of Shenzhen Huatongwei International Inspection Co., Ltd. has been registered by Certification and Engineering Bureau of Industry Canada for the performance of radiated measurements with Registration No. 5377B-1.

#### **ACA**

Shenzhen Huatongwei International Inspection Co., Ltd. EMC Laboratory can also perform testing for the Australian C-Tick mark as a result of our A2LA accreditation.



### 4.3 Environmental conditions

Atmospheric Contions	
Temperature:	21°C to 25°C
Relative Humidity:	20 % to 75 %.
Atmospheric Pressure:	860 mbar to 1060 mbar
Norminal Test Voltage:	$V_N = DC 4.50V$
Extrem Test Voltage @115% $V_N$ :	$V_H = DC 5.18V$
Extrem Test Voltage @85% $V_N$ :	$V_L = DC 3.83V$

### 4.4 Statement of the measurement uncertainty

The data and results referenced in this document are true and accurate. The reader is cautioned that there may be errors within the calibration limits of the equipment and facilities. The measurement uncertainty was calculated for all measurements listed in this test report acc. to CISPR 16 - 4 „Specification for radio disturbance and immunity measuring apparatus and methods – Part 4: Uncertainty in EMC Measurements“ and is documented in the Shenzhen Huatongwei International Inspection Co., Ltd quality system acc. to DIN EN ISO/IEC 17025. Furthermore, component and process variability of devices similar to that tested may result in additional deviation. The manufacturer has the sole responsibility of continued compliance of the device.

Hereafter the best measurement capability for Shenzhen Huatongwei laboratory is reported:

Test Items	Measurement Uncertainty	Notes
Frequency stability	25 Hz	(1)
Transmitter power conducted	0.57 dB	(1)
Transmitter power Radiated	2.20 dB	(1)
Conducted spurious emission 9KHz-40 GHz	1.60 dB	(1)
Conducted Emission 9KHz-30MHz	3.39 dB	(1)
Radiated Emission 30~1000MHz	4.65 dB	(1)
Radiated Emission 1~18GHz	5.16 dB	(1)
Radiated Emission 18-40GHz	5.54 dB	(1)
Occupied Bandwidth	35 Hz	(1)
FM deviation	25 Hz	(1)
Audio level	0.62 dB	(1)
Low Pass Filter Response	0.76 dB	(1)
Modulation Limiting	0.42 %	(1)

(1) This uncertainty represents an expanded uncertainty expressed at approximately the 95% confidence level using a coverage factor of  $k=1.96$ .

#### 4.5 Equipments Used during the Test

RF Conducted Test						
Item	Equipment	Manufacturer	Model No.	Serial No.	Last Cal. (mm-dd-yy)	Next Cal. (mm-dd-yy)
1	Analog communication tester	HP	8920A	3813A10206	11/11/2017	11/10/2018
2	Digital communication tester	Aeroflex	3920B	1001682041	11/11/2017	11/10/2018
3	Spectrum Analyzer	R&S	FSW26	103440	11/11/2017	11/10/2018
4	Signal Generator	R&S	SML02	100507	11/11/2017	11/10/2018
5	Signal Generator	IFR	2032	203002\100	11/11/2017	11/10/2018
6	RF Cable	Chengdu E-Microwave	----	----	11/11/2017	11/10/2018
7	Attenuator	Chengdu E-Microwave	EMCAXX-10RNZ-3	----	11/11/2017	11/10/2018
8	High-Pass Filter	OCEN	OSP-HPF26300P20-LC	----	11/11/2017	11/10/2018
9	High-Pass Filter	OCEN	OSP-HPF60300P20-LC	----	11/11/2017	11/10/2018
10	RF Control Unit	Tonscend	JS0806-2	N/A	11/11/2017	11/10/2018
11	Climate Chamber	ESPEC	GPL-2	----	11/10/2017	11/09/2018
12	Variable Power Supply	GW INSTEK	GPS-3030D	012578	11/11/2017	11/10/2018

<b>Radiated Emissions</b>						
Item	Equipment	Manufacturer	Model No.	Serial No.	Last Cal. (mm-dd-yy)	Next Cal. (mm-dd-yy)
1	EMI Test Receiver	R&S	ESCI	101247	11/11/2017	11/10/2018
2	Loop Antenna	R&S	HFH2-Z2	100020	11/20/2017	11/19/2018
3	Ultra-Broadband Antenna	SCHWARZBECK	VULB9163	538	04/05/2017	04/04/2020
4	Preamplifier	SCHWARZBECK	BBV 9743	9743-0022	10/18/2017	10/17/2018
5	RF Connection Cable	HUBER+SUHNER	RE-7-FL	N/A	11/21/2017	11/20/2018
6	EMI Test Software	R&S	ESK1	N/A	N/A	N/A
7	Spectrum Analyzer	R&S	FSP40	100597	11/11/2017	11/10/2018
8	Horn Antenna	SCHWARZBECK	9120D	1011	03/27/2017	03/26/2020
9	Horn Antenna	SCHWARZBECK	BBHA9170	25841	03/27/2017	03/26/2020
10	Broadband Preamplifier	SCHWARZBECK	BBV 9718	9718-248	10/18/2017	10/17/2018
11	RF Connection Cable	HUBER+SUHNER	RE-7-FH	N/A	11/21/2017	11/20/2018
12	Signal Generator	Rohde&Schwarz	SMB100A	177956	11/11/2017	11/10/2018
13	High-Pass Filter	OCEN	OSP-HPF26300P20-LC	----	11/11/2017	11/10/2018
14	High-Pass Filter	OCEN	OSP-HPF60300P20-LC	----	11/11/2017	11/10/2018
15	EMI Test Software	Audix	E3	N/A	N/A	N/A
16	Turntable	MATURO	TT2.0	/	N/A	N/A
17	Antenna Mast	MATURO	TAM-4.0-P	/	N/A	N/A

## 5 TEST CONDITIONS AND RESULTS

### 5.1 Carrier Output Power (ERP)

#### LIMIT

FCC Part FCC Part 95.567, FCC Part 2.1046

Each FRS transmitter type must be designed such that the effective radiated power (ERP) on channels 8 through 14 does not exceed 0.5 Watts and the ERP on channels 1 through 7 and 15 through 22 does not exceed 2.0 Watts. The radio shall be equipped with an integral antenna.

#### TEST CONFIGURATION

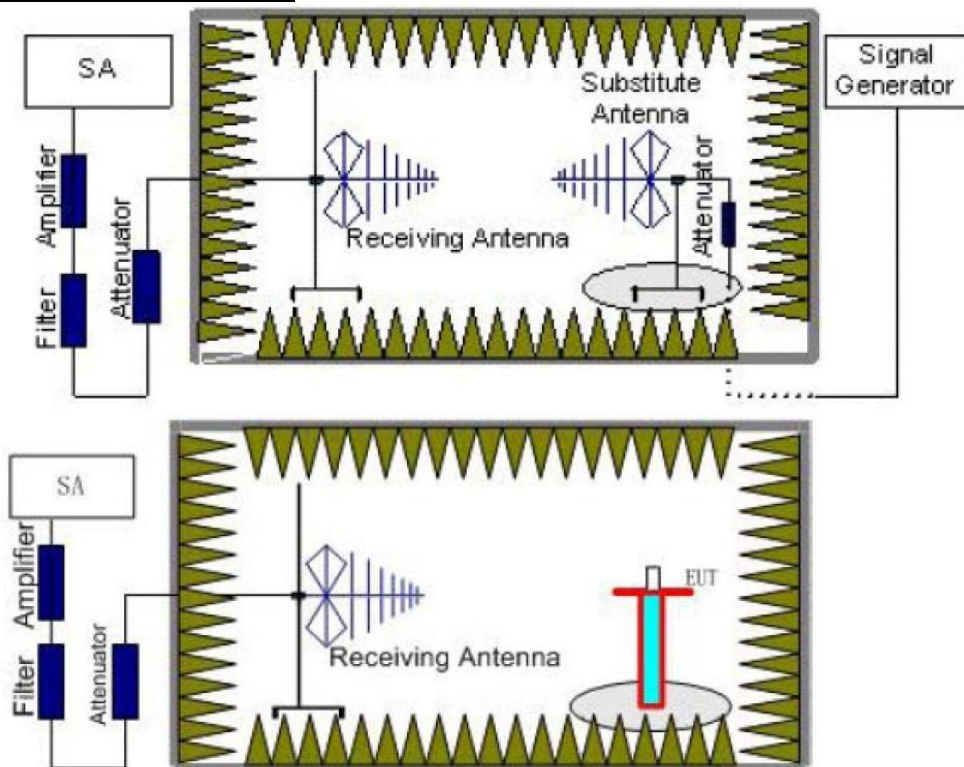

#### TEST PROCEDURE

1. EUT was placed on a 0.8 meter high non-conductive stand at a 3 meter test distance from the receive antenna. A receiving antenna was placed on the antenna mast 3 meters from the EUT for emission measurements. The height of receiving antenna is 1.0 m. Detected emissions were maximized at each frequency by rotating the EUT through 360° and adjusting the receiving antenna polarization. The radiated emission measurements of all transmit frequencies in six channels were measured with peak detector.
2. A log-periodic antenna or double-ridged waveguide horn antenna shall be substituted in place of the EUT. The log-periodic antenna will be driven by a signal generator and the level will be adjusted till the same power value on the spectrum analyzer or receiver. The level of the spurious emissions can be calculated through the level of the signal generator, cable loss, the gain of the substitution antenna and the reading of the spectrum analyzer or receiver.
3. The EUT is then put into continuously transmitting mode at its maximum power level during the test. Set Test Receiver or Spectrum RBW=100kHz, VBW=300kHz for 30MHz to 1GHz, And the maximum value of the receiver should be recorded as (Pr).
4. The EUT shall be replaced by a substitution antenna. In the chamber, an substitution antenna for the frequency band of interest is placed at the reference point of the chamber. An RF Signal source for the frequency band of interest is connected to the substitution antenna with a cable that has been constructed to not interfere with the radiation pattern of the antenna. A power (PMea) is applied to the input of the substitution antenna, and adjust the level of the signal generator output until the value of the receiver reach the previously recorded (Pr). The power of signal source (PMea) is recorded. The test should be performed by rotating the test item and adjusting the receiving antenna polarization.

5. A amplifier should be connected to the Signal Source output port. And the cable should be connect between the Amplifier and the Substitution Antenna. The cable loss (Pcl) ,the Substitution Antenna Gain (Ga) and the Amplifier Gain (PAg) should be recorded after test.  
The measurement results are obtained as described below:  
Power(EIRP)=PMea- PAg - Pcl - Ga  
We used SMF100A micowave signal generator which signal level can up to 33dBm,so we not used power Amplifier for substitution test; The measurement results are amend as described below:  
Power(EIRP)=PMea- Pcl - Ga
6. This value is EIRP since the measurement is calibrated using an antenna of known gain (2.15 dBi) and known input power.
7. ERP can be calculated from EIRP by subtracting the gain of the dipole, ERP = EIRP-2.15dBi.

**TEST MODE**

Please reference to the section 3.4

**TEST RESULTS**

Passed       Not Applicable

Operation Mode	Test Channel	Measured ERP (dBm)	Measured ERP(W)	Limit (W)	Result
TX-FRS	CHM1	29.13	0.82	≤1	Pass
	CHM2	26.98	0.50	≤0.5	
	CHM3	29.07	0.81	≤1	

## 5.2 99% Occupied Bandwidth & 26dB Bandwidth

### LIMIT

FCC Part 95.573, FCC Part 2.1049

Each FRS transmitter type must be designed such that the occupied bandwidth does not exceed 12.5 kHz.

### TEST CONFIGURATION

Test setup for Analog:

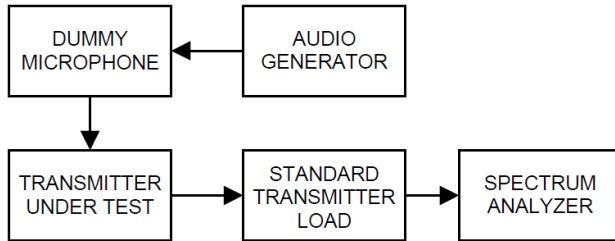

### TEST PROCEDURE

- (1) Connect the equipment as illustrated
- (2) Spectrum set as follow:  
Centre frequency = the nominal EUT channel center frequency,  
The frequency span for the spectrum analyzer shall be set wide enough to capture all modulation products including the emission skirts (typically a span of  $1.5 \times \text{OBW}$  is sufficient)  
RBW = 1% to 5% of the anticipated OBW, VBW  $\geq 3 \times \text{RBW}$ , Sweep = auto,  
Detector function = peak, Trace = max hold
- (3) Set 99% Occupied Bandwidth and 26dB Bandwidth
- (4) Measure and record the results in the test report.

### TEST MODE

Please reference to the section 3.4

### TEST RESULTS

Passed       Not Applicable

Please refer to appendix A on the section 8 appendix report

### 5.3 Emission Mask

#### LIMIT

FCC Part 95.579(a)(1)(2)(3), FCC Part 2.1049

Each FRS transmitter type must be designed to satisfy the applicable unwanted emissions limits in this paragraph.

(a) Attenuation requirements. The power of unwanted emissions must be attenuated below the carrier power output in Watts (P) by at least:

- (1) 25 dB (decibels) in the frequency band 6.25 kHz to 12.5 kHz removed from the channel center frequency.
- (2) 35 dB in the frequency band 12.5 kHz to 31.25 kHz removed from the channel center frequency.
- (3)  $43 + 10 \log (P)$  dB in any frequency band removed from the channel center frequency by more than 31.25 kHz.

#### TEST CONFIGURATION

Test setup for Analog:

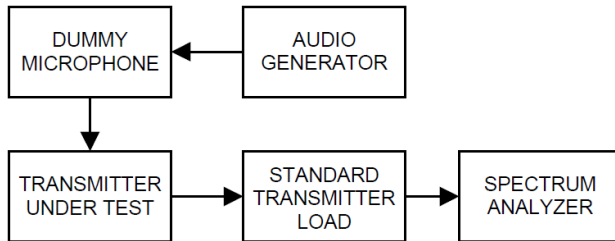

#### TEST PROCEDURE

- 1) Connect the equipment as illustrated.
- 2) Spectrum set as follow:  
Centre frequency = fundamental frequency, span=120kHz for 12.5kHz channel spacing,  
RBW=100Hz, VBW=1000Hz, Sweep = auto,  
Detector function = peak, Trace = max hold
- 3) Key the transmitter, and set the level of the unmodulated carrier to a full scale reference line. This is the 0dB reference for the measurement.
- 4) Apply Input Modulation Signal to EUT according to Section 3.4
- 5) Measure and record the results in the test report.

#### TEST MODE

Please reference to the section 3.4

#### TEST RESULTS

Passed       Not Applicable

Please refer to appendix B on the section 8 appendix report

## 5.4 Modulation Limit

### LIMIT

FCC Part 95.575, FCC Part 2.1047(b)

Each FRS transmitter type must be designed such that the peak frequency deviation does not exceed 2.5 kHz, and the highest audio frequency contributing substantially to modulation must not exceed 3.125 kHz.

### TEST CONFIGURATION

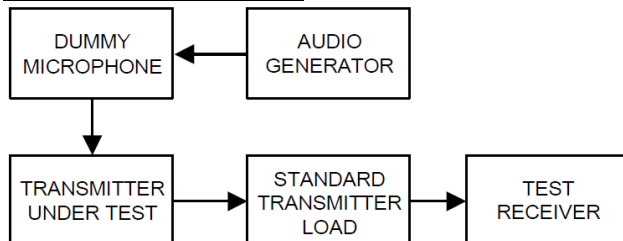

### TEST PROCEDURE

- 1) Connect the equipment as illustrated.
- 2) Adjust the transmitter per the manufacturer's procedure for full rated system deviation.
- 3) Set the test receiver to measure peak positive deviation. Set the audio bandwidth for  $\leq 0.25$  Hz to  $\geq 15,000$  Hz. Turn the de-emphasis function off.
- 4) Apply Input Modulation Signal to EUT according to Section 3.4 and vary the input level from  $-20$  to  $+20$ dB.
- 5) Measure both the instantaneous and steady-state deviation at and after the time of increasing the audio input level
- 6) Repeat step 4-5 with input frequency changing to 300Hz, 1004Hz, 1500Hz and 2500Hz in sequence.

### TEST MODE

Please reference to the section 3.4

### TEST RESULTS

Passed       Not Applicable

Please refer to appendix C on the section 8 appendix report



## 5.5 Audio Frequency Response

### LIMIT

FCC Part 95.575), FCC Part 2.1047(a):

Each FRS transmitter type must be designed such that the peak frequency deviation does not exceed 2.5 kHz, and the highest audio frequency contributing substantially to modulation must not exceed 3.125 kHz.

Voice modulated communication equipment. A curve or equivalent data showing the frequency response of the audio modulating circuit over a range of 100 to 5000 Hz shall be submitted.

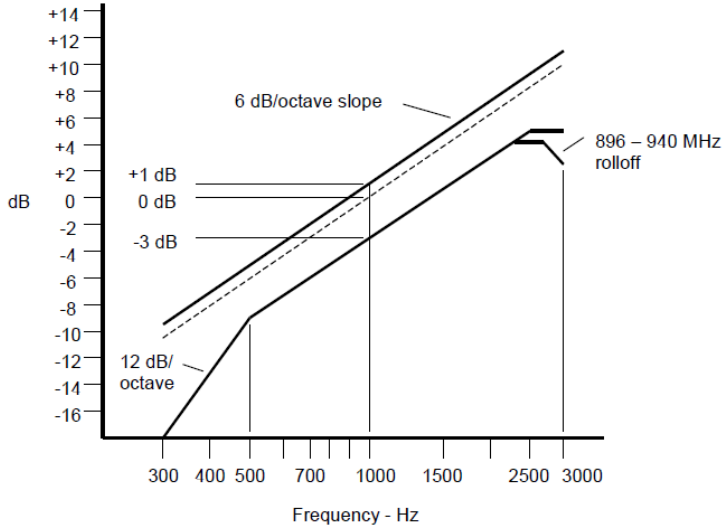

An additional 6 dB per octave attenuation is allowed from 2500 Hz to 3000 Hz in equipment operating in the 25 MHz to 869 MHz range.

### TEST CONFIGURATION

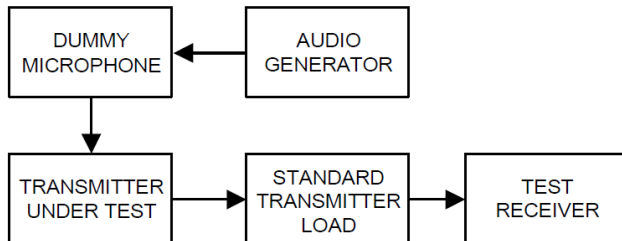

### TEST PROCEDURE

- 1) Connect the equipment as illustrated.
- 2) Set the test receiver to measure peak positive deviation. Set the audio bandwidth for 50 Hz to 15,000 Hz. Turn the de-emphasis function off.
- 3) Set the DMM to measure rms voltage.
- 4) Adjust the transmitter per the manufacturer's procedure for full rated system deviation.
- 5) Apply Input Modulation Signal to EUT according to Section 3.4
- 6) Set the test receiver to measure rms deviation and record the deviation reading.
- 7) Record the DMM reading as  $V_{REF}$ .
- 8) Set the audio frequency generator to the desired test frequency between 300 Hz and 3000 Hz.
- 9) Vary the audio frequency generator output level until the deviation reading that was recorded in step 6) is obtained.
- 10) Record the DMM reading as  $V_{FREQ}$
- 11) Calculate the audio frequency response at the present frequency as:  
audio frequency response =  $20 \log_{10} (V_{FREQ}/V_{REF})$ .
- 12) Repeat steps 8) through 11) for all the desired test frequencies

**TEST MODE**

Please reference to the section 3.4

**TEST RESULTS**

**Passed**       **Not Applicable**

Please refer to appendix D on the section 8 appendix report

## 5.6 Frequency stability VS Temperature

### LIMIT

FCC Part 95.565:

Each FRS transmitter type must be designed such that the carrier frequencies remain within  $\pm 2.5$  parts-per-million of the channel center frequencies specified in §95.563 during normal operating conditions.

### TEST CONFIGURATION

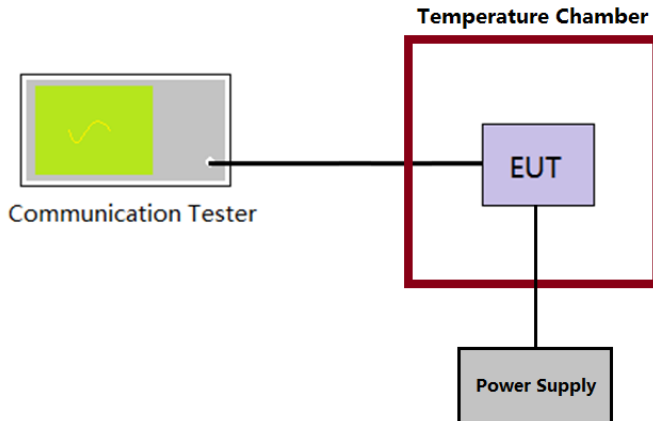

### TEST PROCEDURE

- 1) The EUT output port was connected to communication tester.
- 2) The EUT was placed inside the temperature chamber.
- 3) Turn EUT off and set the chamber temperature to  $-30^{\circ}\text{C}$ . After the temperature stabilized for approximately 30 minutes recorded the frequency as  $MCF_{\text{MHz}}$ .
- 4) Calculate the ppm frequency error by the following:  

$$\text{ppm error} = (MCF_{\text{MHz}} / ACF_{\text{MHz}} - 1) * 10^6$$
 where  
 $MCF_{\text{MHz}}$  is the Measured Carrier Frequency in MHz  
 $ACF_{\text{MHz}}$  is the Assigned Carrier Frequency in MHz
- 5) Repeat step 3 measure with  $10^{\circ}\text{C}$  increased per stage until the highest temperature of  $+50^{\circ}\text{C}$  reached.

### TEST MODE

Please reference to the section 3.4

### TEST RESULTS

Passed       Not Applicable

Please refer to appendix E on the section 8 appendix report

## 5.7 Frequency stability VS Voltage

### LIMIT

FCC Part 95.565:

Each FRS transmitter type must be designed such that the carrier frequencies remain within  $\pm 2.5$  parts-per-million of the channel center frequencies specified in §95.563 during normal operating conditions.

### TEST CONFIGURATION

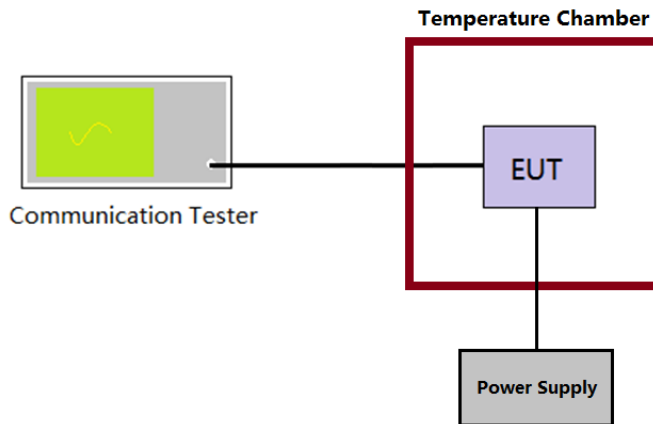

### TEST PROCEDURE

- 1) The EUT output port was connected to communication tester.
- 2) The EUT was placed inside the temperature chamber at 25°C
- 3) Record the carrier frequency of the transmitter as  $MCF_{MHz}$
- 4) Calculate the ppm frequency error by the following:  
$$ppm\ error = (MCF_{MHz} / ACF_{MHz} - 1) * 10^6$$

where  
 $MCF_{MHz}$  is the Measured Carrier Frequency in MHz  
 $ACF_{MHz}$  is the Assigned Carrier Frequency in MHz
- 5) Repeat step 3 measure with varied  $\pm 15\%$  of the nominal value measured at the input to the EUT

### TEST MODE

Please reference to the section 3.4

### TEST RESULTS

Passed       Not Applicable

Please refer to appendix F on the section 8 appendix report

### 5.8 Transmitter Radiated Spurious Emission

#### LIMIT

FCC Part 95.579(a)(3):

$43 + 10 \log (P_{\text{watts}})$

Calculation: Limit (dBm) = EL - 43 - 10 log<sub>10</sub> (TP)

Notes: EL is the emission level of the Output Power expressed in dBm,  
In this application, the EL is P (dBm).

Limit (dBm) = P (dBm) - 43 - 10 log (Pwatts) = -13 dBm

#### TEST CONFIGURATION

Below 1GHz:

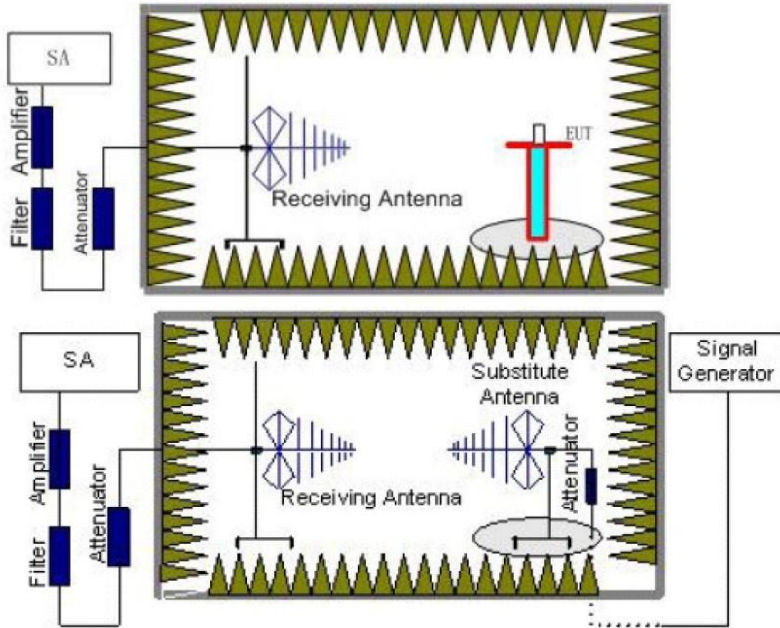

Above 1GHz:

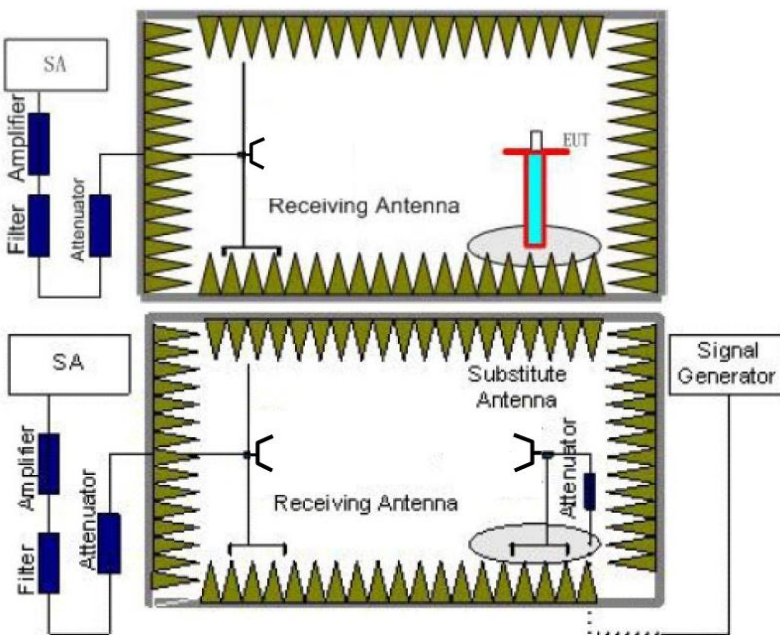

**TEST PROCEDURE**

8. Standard Transmitter Load with a 50Ω input impedance and an output impedance matched to the test equipment.
9. EUT was placed on a 0.8 meter high non-conductive stand at a 3 meter test distance from the receive antenna. A receiving antenna was placed on the antenna mast 3 meters from the EUT for emission measurements. The height of receiving antenna is 1.0 m. Detected emissions were maximized at each frequency by rotating the EUT through 360° and adjusting the receiving antenna polarization. The radiated emission measurements of all transmit frequencies in six channels were measured with peak detector.
10. A log-periodic antenna or double-ridged waveguide horn antenna shall be substituted in place of the EUT. The log-periodic antenna will be driven by a signal generator and the level will be adjusted till the same power value on the spectrum analyzer or receiver. The level of the spurious emissions can be calculated through the level of the signal generator, cable loss, the gain of the substitution antenna and the reading of the spectrum analyzer or receiver.
11. The EUT is then put into continuously transmitting mode at its maximum power level during the test. Set Test Receiver or Spectrum RBW=1MHz, VBW=3MHz for above 1GHz and RBW=100kHz, VBW=300kHz for 30MHz to 1GHz, And the maximum value of the receiver should be recorded as (Pr).
12. The EUT shall be replaced by a substitution antenna. In the chamber, a substitution antenna for the frequency band of interest is placed at the reference point of the chamber. An RF Signal source for the frequency band of interest is connected to the substitution antenna with a cable that has been constructed to not interfere with the radiation pattern of the antenna. A power (PMea) is applied to the input of the substitution antenna, and adjust the level of the signal generator output until the value of the receiver reach the previously recorded (Pr). The power of signal source (PMea) is recorded. The test should be performed by rotating the test item and adjusting the receiving antenna polarization.
13. A amplifier should be connected to the Signal Source output port. And the cable should be connect between the Amplifier and the Substitution Antenna. The cable loss (Pcl), the Substitution Antenna Gain (Ga) and the Amplifier Gain (PAg) should be recorded after test.  
The measurement results are obtained as described below:  
 $Power(EIRP) = PMea - PAg - Pcl - Ga$   
We used SMF100A microwave signal generator which signal level can up to 33dBm, so we not used power Amplifier for substitution test; The measurement results are amend as described below:  
 $Power(EIRP) = PMea - Pcl - Ga$
14. This value is EIRP since the measurement is calibrated using an antenna of known gain (2.15 dBi) and known input power.
15. ERP can be calculated from EIRP by subtracting the gain of the dipole,  $ERP = EIRP - 2.15dBi$ .

**TEST MODE**

Please reference to the section 3.4

**TEST RESULTS**

Passed       Not Applicable

TEST MODE	TX-FRS	Test Channel:	CH <sub>M1</sub>	Polarity:	Horizontal
-----------	--------	---------------	------------------	-----------	------------

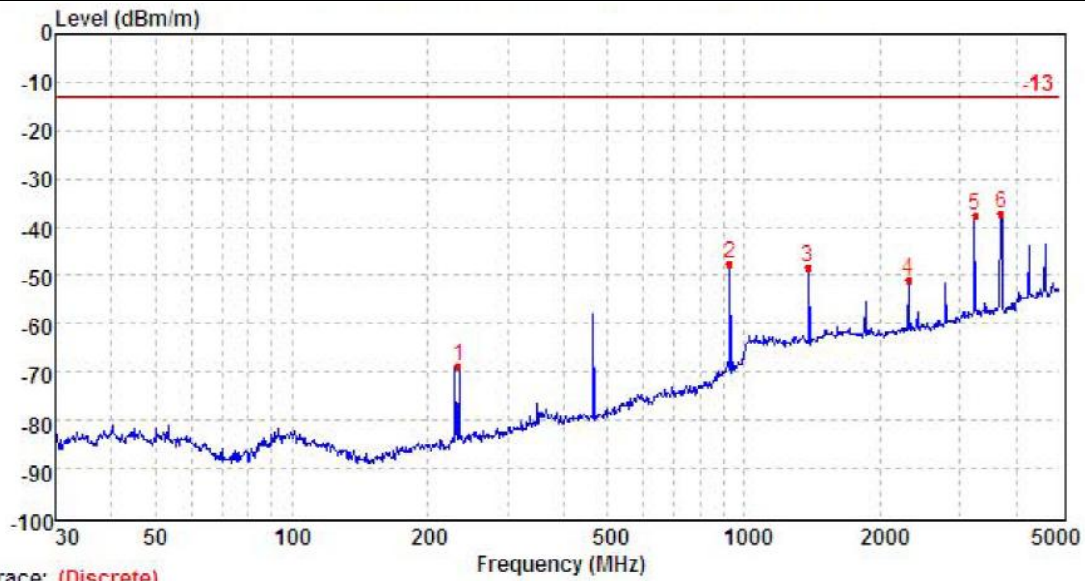

Trace: (Discrete)

Mark	Frequency MHZ	Reading dBm	Antenna dB	Cable dB	Preamp dB	Level dBm	Limit dBm	Over limit	Remark
1	233.89	-66.06	24.59	1.74	29.17	-68.90	-13.00	-55.90	Peak
2	928.26	-59.16	36.08	3.77	28.10	-47.41	-13.00	-34.41	Peak
3	1387.03	-55.84	39.71	4.98	37.12	-48.27	-13.00	-35.27	Peak
4	2313.38	-61.74	41.90	6.63	37.59	-50.80	-13.00	-37.80	Peak
5	3240.01	-51.36	43.52	7.77	37.36	-37.43	-13.00	-24.43	Peak
6	3701.22	-52.89	44.18	8.39	36.98	-37.30	-13.00	-24.30	Peak

TEST MODE	TX-FRS	Test Channel:	CH <sub>M1</sub>	Polarity:	Vertical
-----------	--------	---------------	------------------	-----------	----------

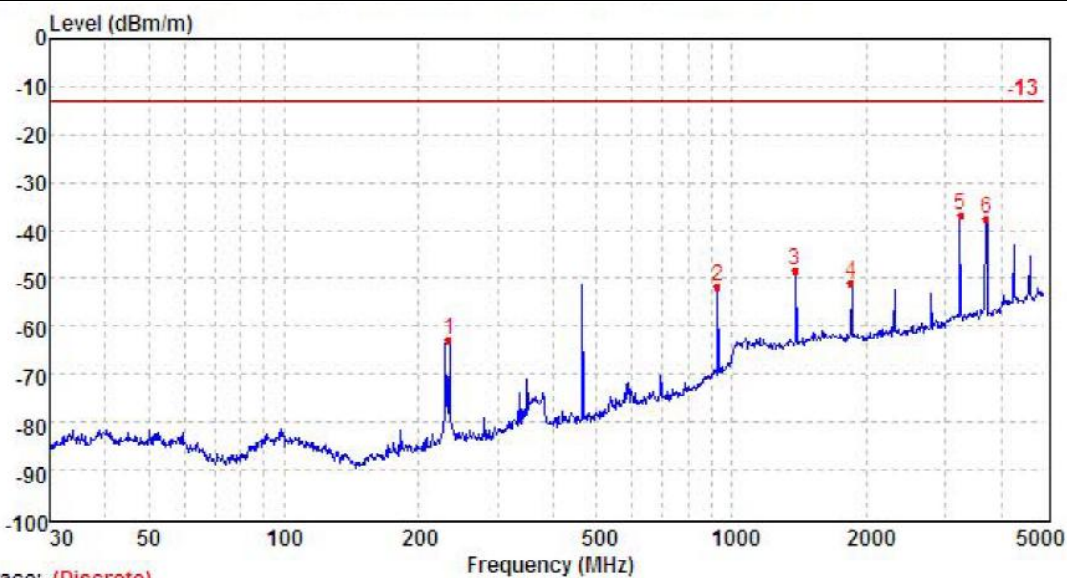

Trace: (Discrete)

Mark	Frequency MHZ	Reading dBm	Antenna dB	Cable dB	Preamp dB	Level dBm	Limit dBm	Over limit	Remark
1	233.89	-59.98	24.59	1.74	29.17	-62.82	-13.00	-49.82	Peak
2	928.26	-63.44	36.08	3.77	28.10	-51.69	-13.00	-38.69	Peak
3	1387.03	-55.91	39.71	4.98	37.12	-48.34	-13.00	-35.34	Peak
4	1850.61	-60.22	40.77	6.04	37.46	-50.87	-13.00	-37.87	Peak
5	3240.01	-50.72	43.52	7.77	37.36	-36.79	-13.00	-23.79	Peak
6	3701.22	-53.30	44.18	8.39	36.98	-37.71	-13.00	-24.71	Peak

TEST MODE	TX-FRS	Test Channel:	CH <sub>M2</sub>	Polarity:	Horizontal
-----------	--------	---------------	------------------	-----------	------------

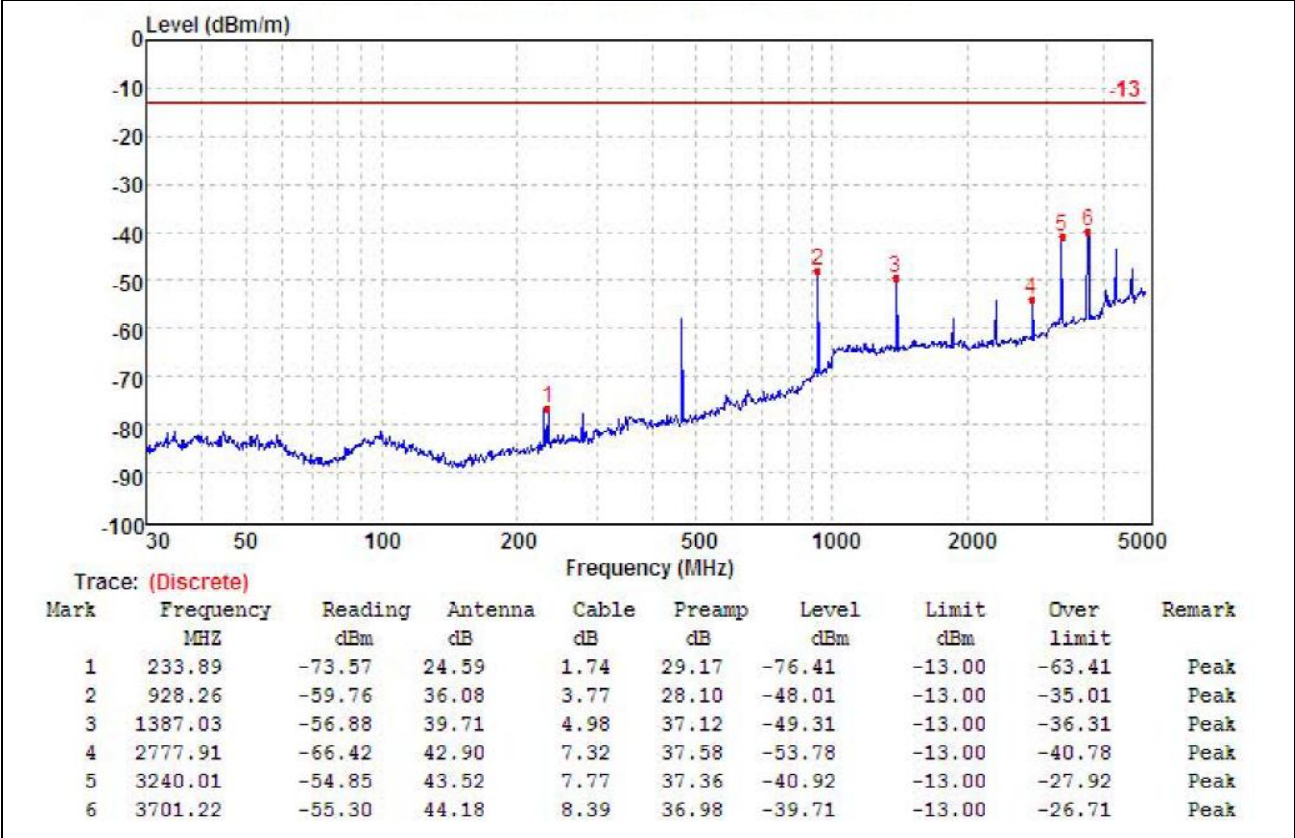

TEST MODE	TX-FRS	Test Channel:	CH <sub>M2</sub>	Polarity:	Vertical
-----------	--------	---------------	------------------	-----------	----------

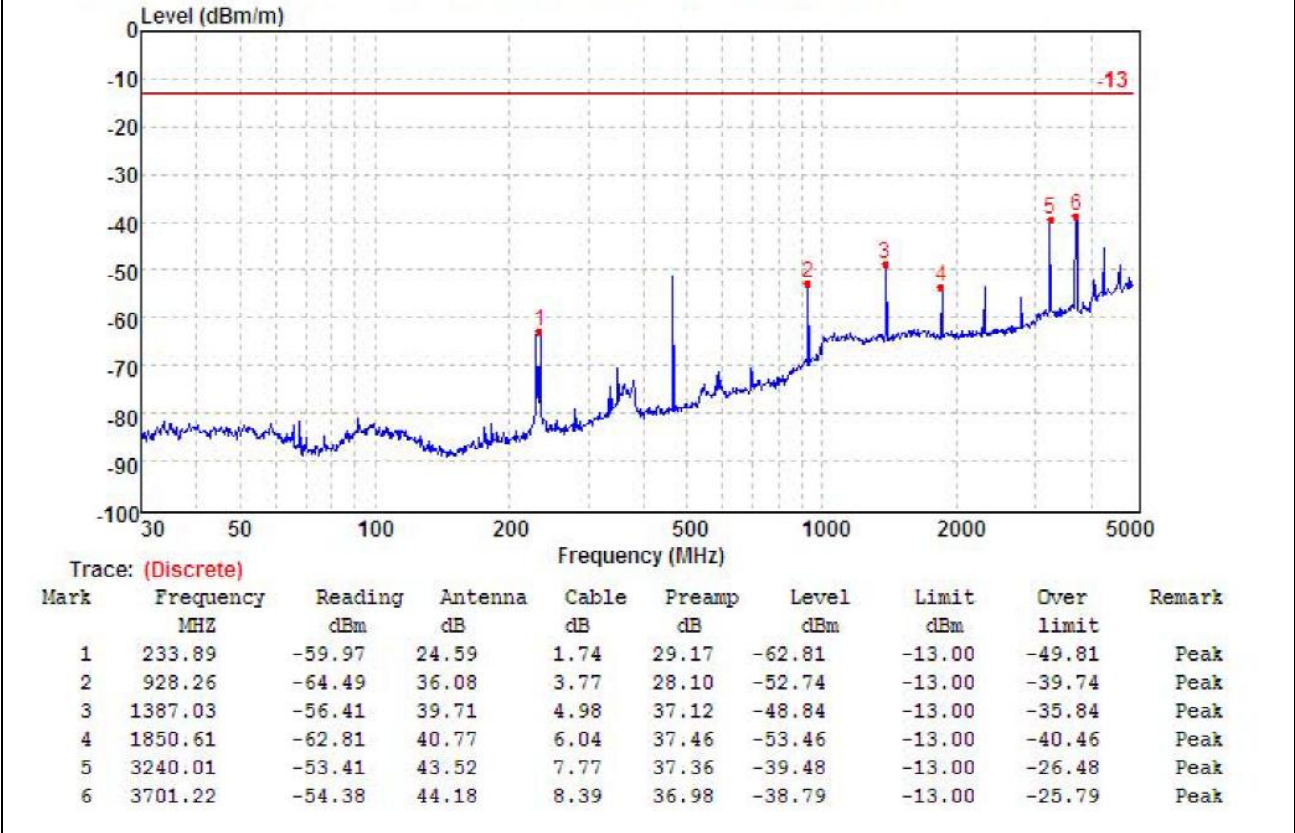



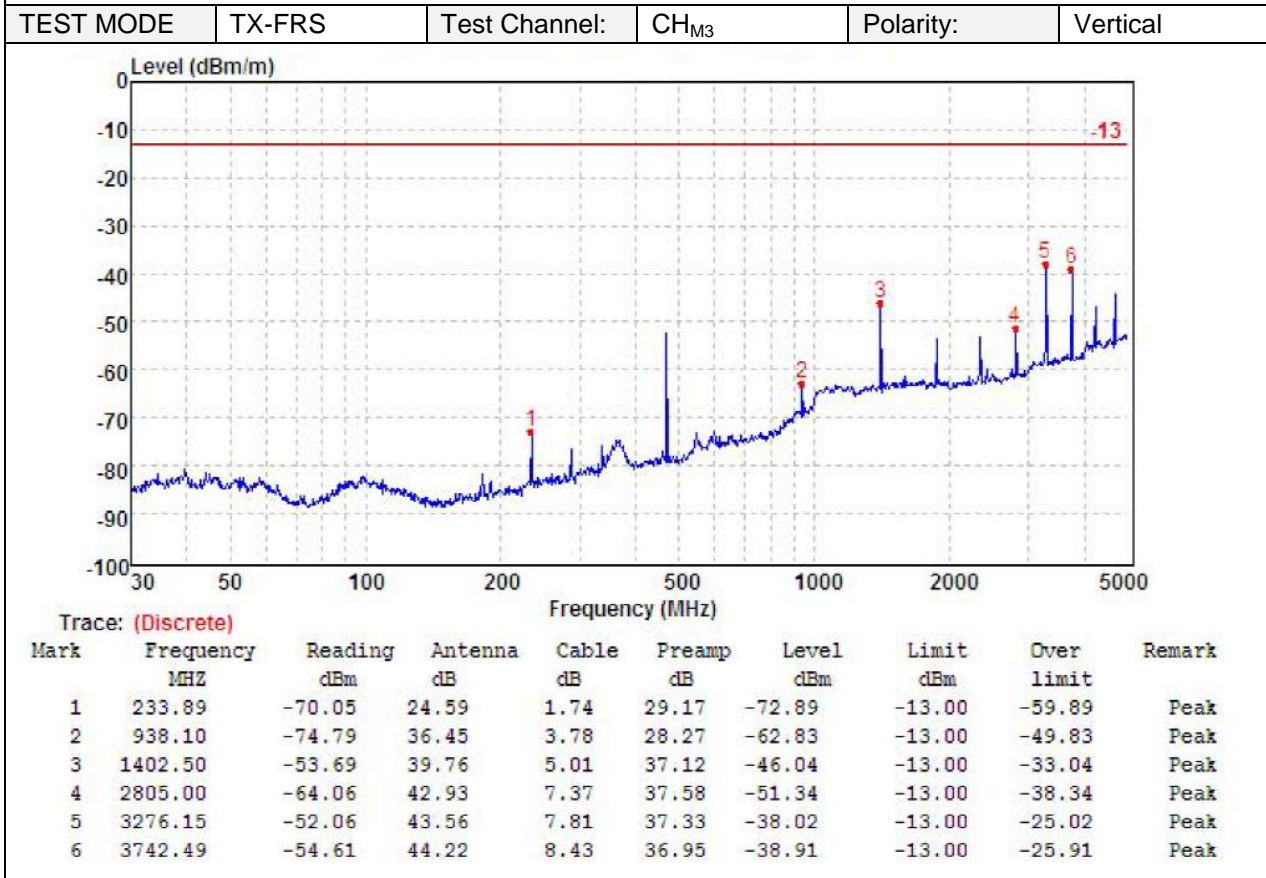
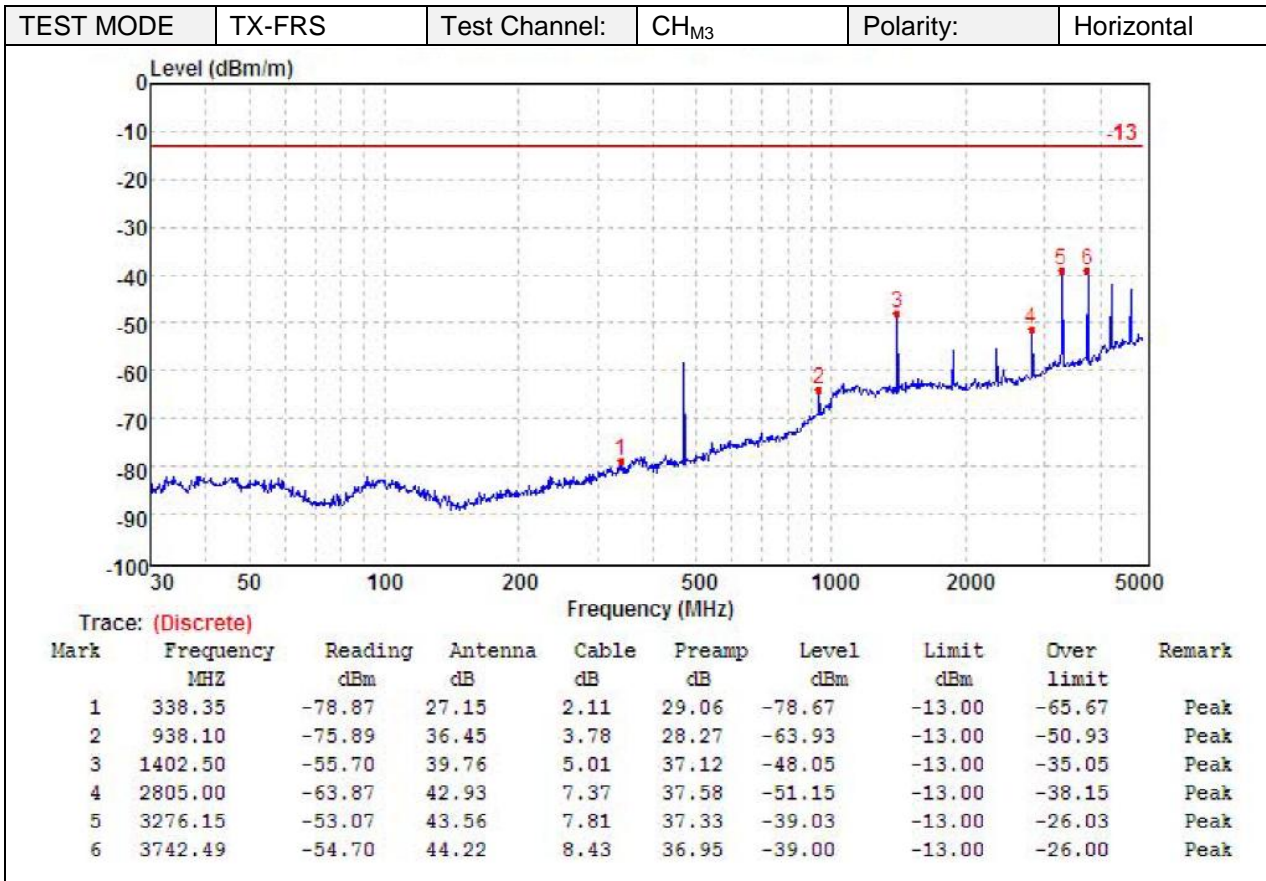

## 6 TEST SETUP PHOTOS OF THE EUT

Transmitter Radiated Spurious Emission:

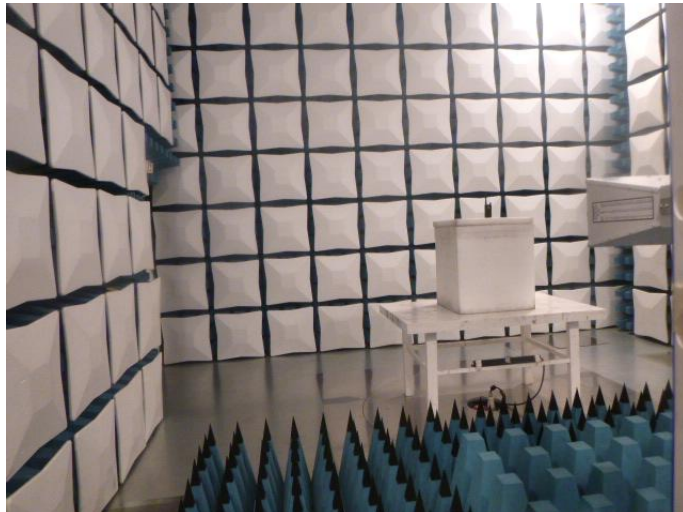
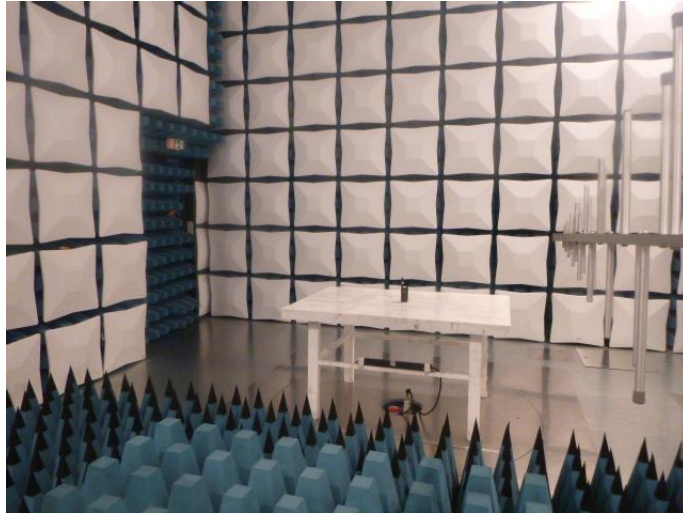

Frequency Stability:



## 7 EXTERNAL AND INTERNAL PHOTOS OF THE EUT

### External Photos of the EUT

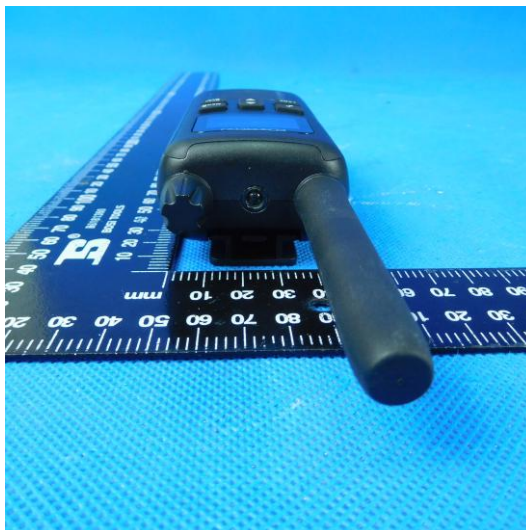

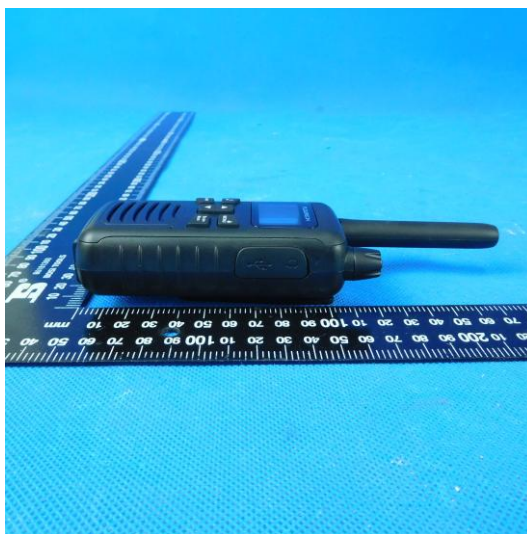
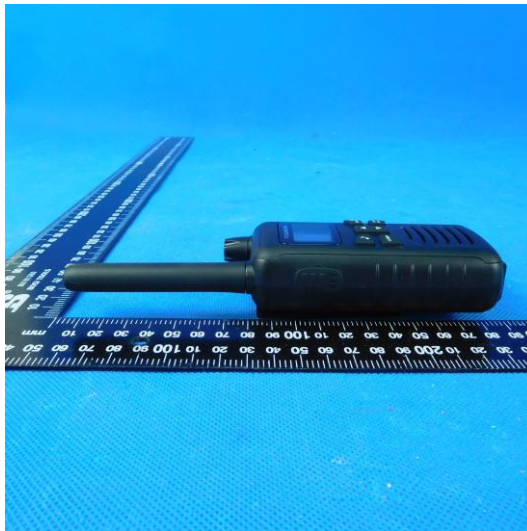

### Internal Photos of the EUT

