

ShenZhen Longtour Photology Co., Ltd.
For
Smart Power Strip
Model No.: SS30N
FCC ID: 2AQN-SS30N

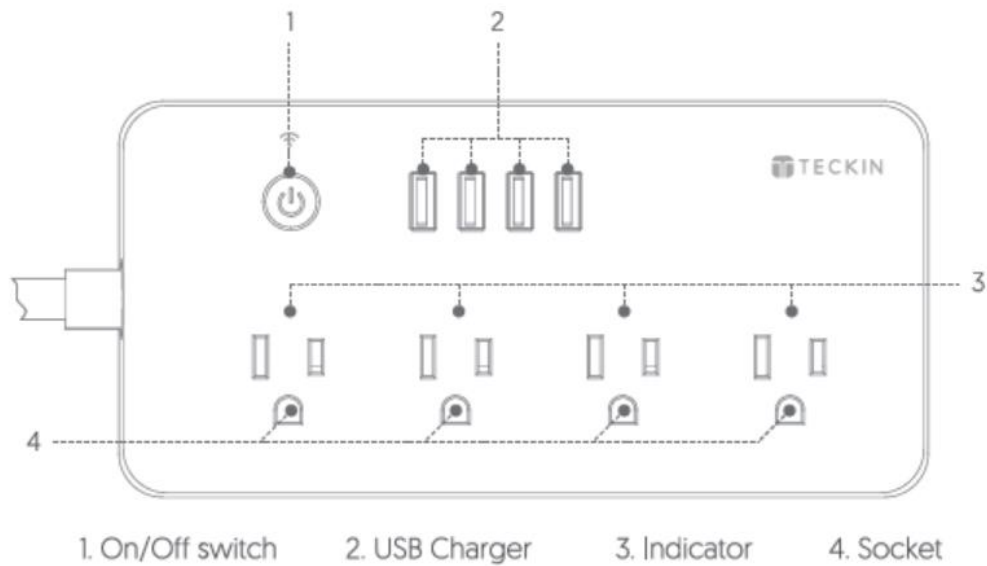

▶ Structure Introduction



▶ Parameter

Model: SS30(N)
Rated Voltage: 125V
Rated Current: 10A Max
Rated Output: 1250W
Working Temp: -10-70°C
Wi-Fi Frequency: 2.4GHz
Class 2 power unit O/P: 5V DC, 2.1A in total
FCC ID: 2AQNX-SS30N

▶ Setting Smart Life APP

Scan the QR code to download and install the Smart Life APP for iOS or Android

1. Download Smart Life from



2. Download or scan the QR code and install the Smart Life App for either IOS or Android. Once downloaded, the app will ask you to register your device. Enter your phone number or email address. If you choose phone number, you will receive a short message with an registration code. If you choose email, then you will create a password.



Attention: There's no Registration Code needed if email method chosen.

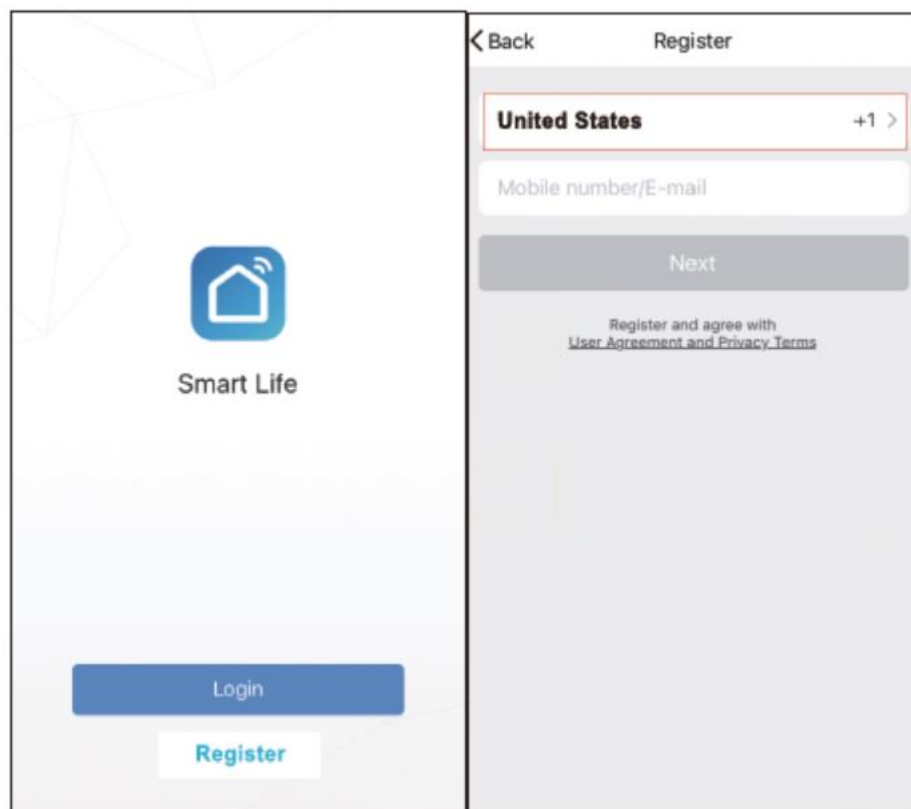

Please note: There're two modes configurations [Quick Mode / AP Mode] available for you to choose before adding the device to app. Quick Mode is recommended.

▶ Quick Mode Configuration (Common)

1. Before connect with Smart Power Strip , please make sure your smart phone or device is connecting with your home Wi-Fi.
2. Make sure the Smart Power Strip device is ready to connect (the blue light button flashes 2 times per second) after plug in the socket. Otherwise , you should keep pressing the power button over 6 seconds to reset the device.

PS: The Smart Power Strip can only support 2.4GHz Wi-Fi. If you have problem with connecting , please try to adjust your router to 2.4GHz.

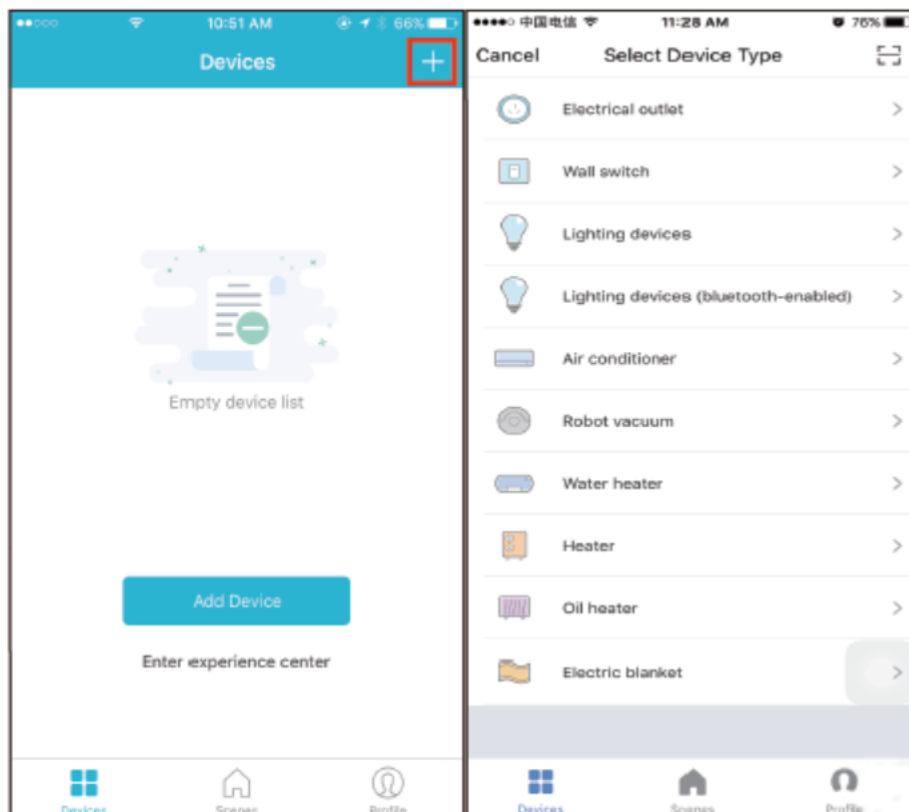

3. Open App and click to add device.

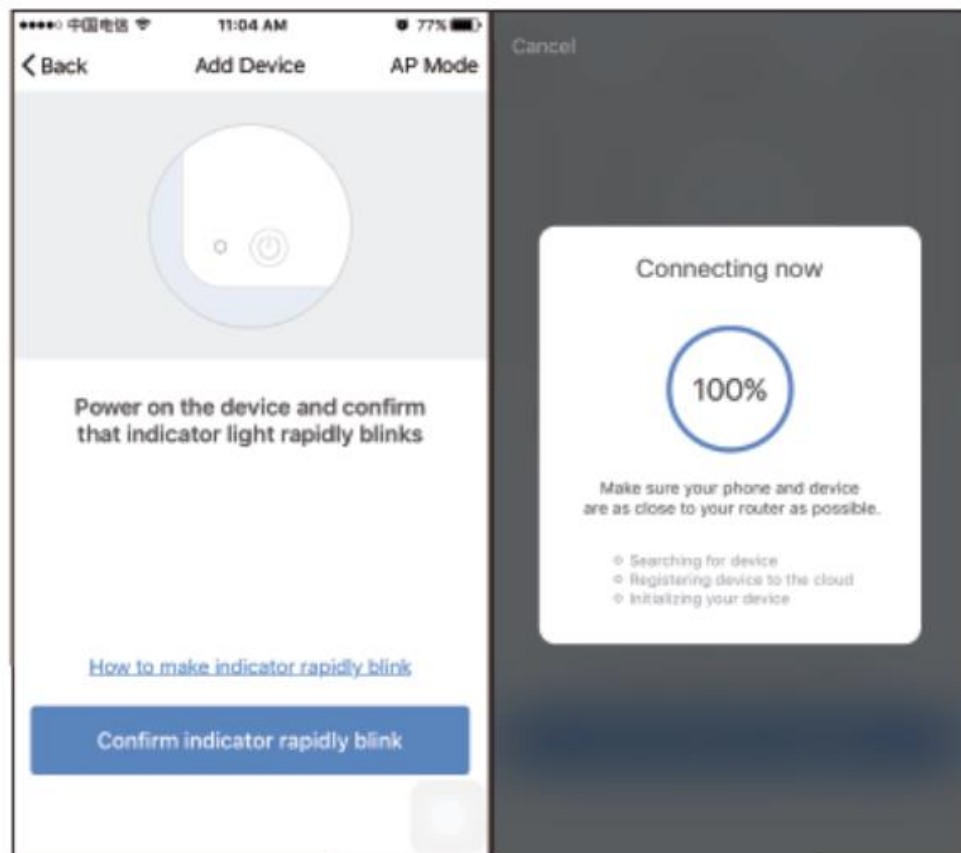

4. Select Wi-Fi network , input Wi-Fi password, connect and click.

5. Once connection finished ,the App will prompt the the connection , then click ok.

▶ AP Mode Configuration

1. Before connect with Smart Power Strip, please make sure your smart phone or device is connecting with your home Wi-Fi.
2. Make sure Smart power strip is ready to connect (the blue light button of Wi-Fi device flashes 1 times per 2 seconds) after plug in the socket. Method to enter AP mode: Make smart power strip enter quick mode first. When the blue button flashes Rapidly, press and hold the power button on the strip for 6 seconds until the indicator light blinks slowly.

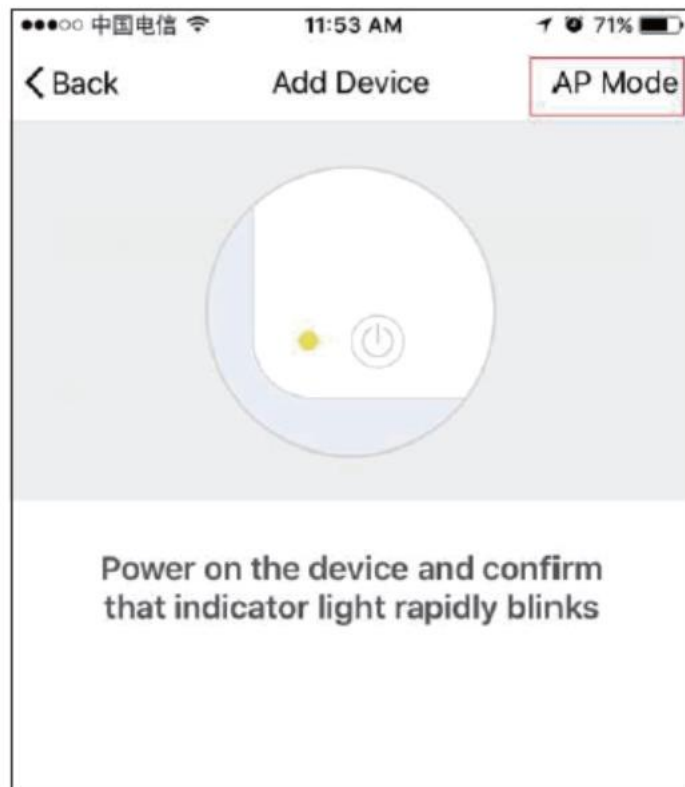

3. Click the Icon "+" at the top right corner of the App.

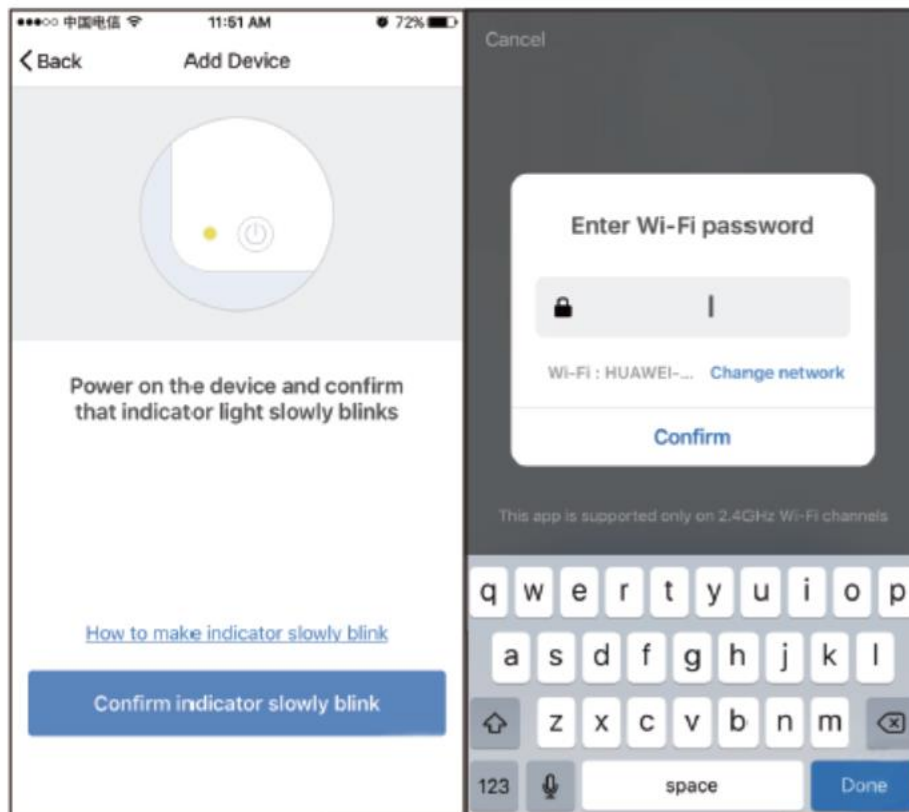

4. Select device type and click AP mode to Add device.

5. Go to Wi-Fi setting in your smart phone and select the "Smart Life-XXX" for your Wi-Fi, and no need to input password.

6. Go back to App and press device name which is Smart Life-XXX and confirm device.

7. Once connected, the App will prompt the connection, and click "Done".

Please refer to the connection instructions of the "Smart Life" App if you want to connect to Google Home or Alexa [Echo].

IOS System

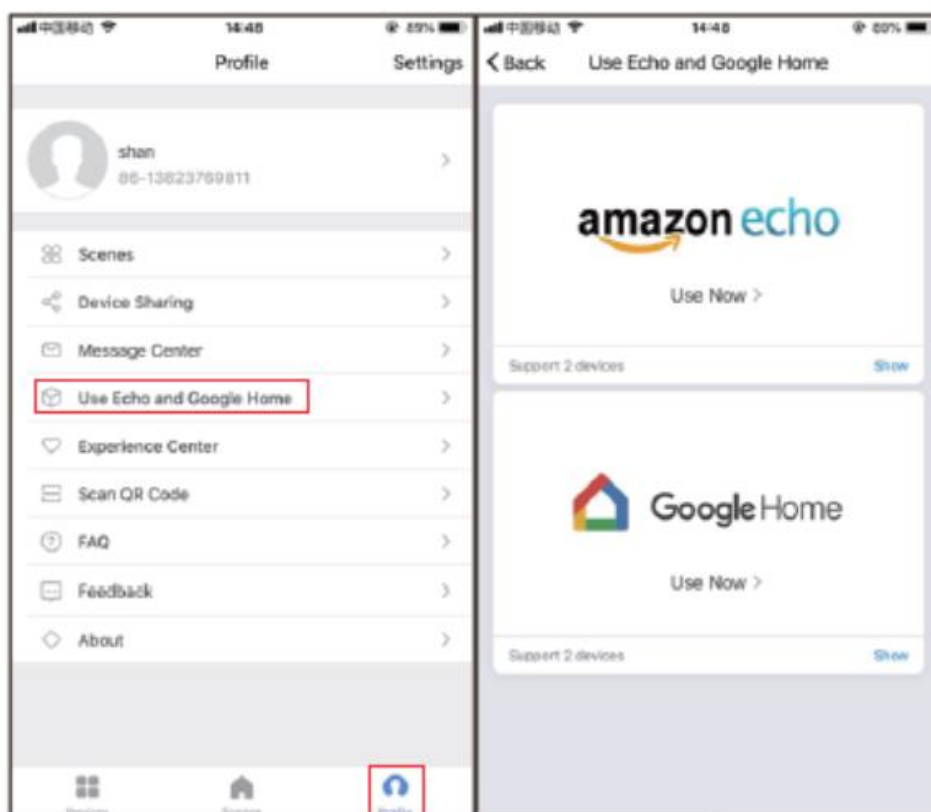

Android System

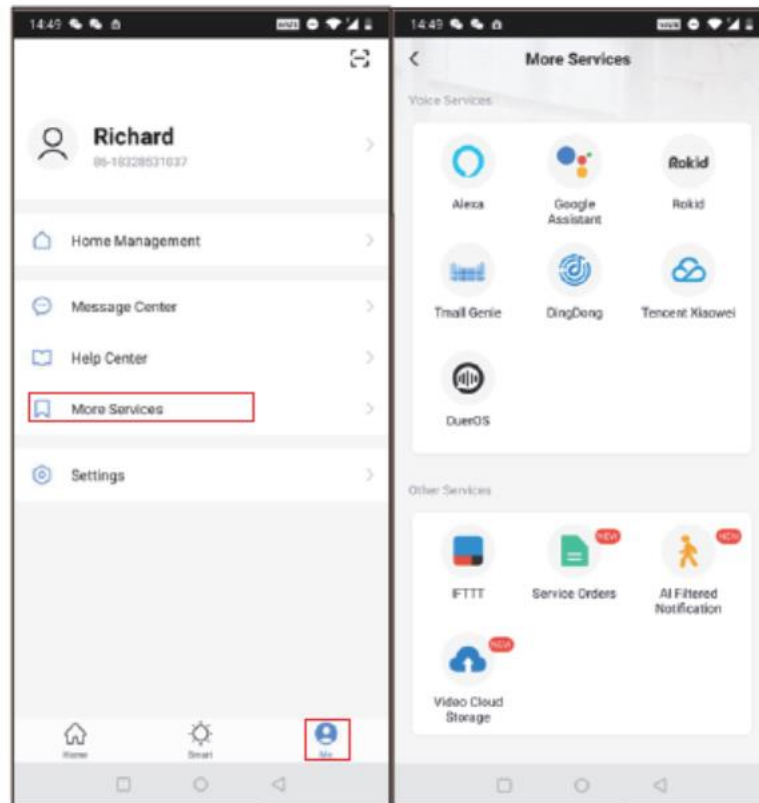

- Note : Why does the smart power strip automatically power off?

Answer : The maximum power of the smart power strip is 1250W; when its power is greater than 1250W, it will automatically power off to protect the device and itself.

Solution : Remove a device so that the power is less than 1250W, the smart power strip will automatically resume function. If it still does not work after removing a device, please reconnect.

▶ FAQ

- Please check whether device is connected with power and your phone is connected with Wi-Fi.
- Check routers: If router is dual-band router, please select 2.4GHz network and add device. You also need to open the router broadcasting function.
- Set up wireless router: Set encryption method as WPA2-PSK authorization type as AES, or set both as auto. Wireless mode cannot be only.
- Please name router Wi-Fi in English. In order to stay strong Wi-Fi signal, please keep device and router within certain distance.
- Check whether connected devices have reached the Maximum number router connection. If so, please try to turn off the Wi-Fi connection of some devices.
- Make sure router wireless MAC filtering function is enabled.
- Remove the device from the filter list and make sure that router is not prohibiting device from connection.
- Make sure the entered password is correct when adding new device.

▶ Warranty

The product carries a one-year warranty from purchase date. Please feel free to contact us when you have any product problem.

Teckin customer service email:

support.us@teckinhome.com

FCC Statement

This device complies with part 15 of the FCC Rules. Operation is subject to the following two conditions:

(1) This device may not cause harmful interference, and (2) this device must accept any interference received, including interference that may cause undesired operation. Any Changes or modifications not expressly approved by the party responsible for compliance could void the user's authority to operate the equipment.

Note: This equipment has been tested and found to comply with the limits for a Class B digital device, pursuant to part 15 of the FCC Rules. These limits are designed to provide reasonable protection against harmful interference in a residential installation. This equipment generates uses and can radiate radio frequency energy and, if not installed and used in accordance with the instructions, may cause harmful interference to radio communications. However, there is no guarantee that interference will not occur in a particular installation. If this equipment does cause harmful interference to radio or television reception, equipment generates, uses and can radiate radio frequency energy and, if not installed and used in accordance with the instructions, may cause harmful interference to radio communications. However, there is no guarantee that interference will not occur in a particular installation. If this equipment does cause harmful interference to radio or television reception,

- Reorient or relocate the receiving antenna.
- Increase the separation between the equipment and receiver.
- Connect the equipment into an outlet on a circuit different from that to which the receiver is connected.
- Consult the dealer or an experienced radio/TV technician for help.

FCC RF Radiation Exposure Statement

The equipment should be installed and operated with minimum distance 20cm between the radiator and your body.