

HUACAI KEYI INDUSTRY COMMERCE CO.,LTD.

THE REMOTE CONTROL OF FOLDING SELFIE 4 CHANNEL FOLDABLE DRONE

6182-1DC

INSTRUCTION MANUAL

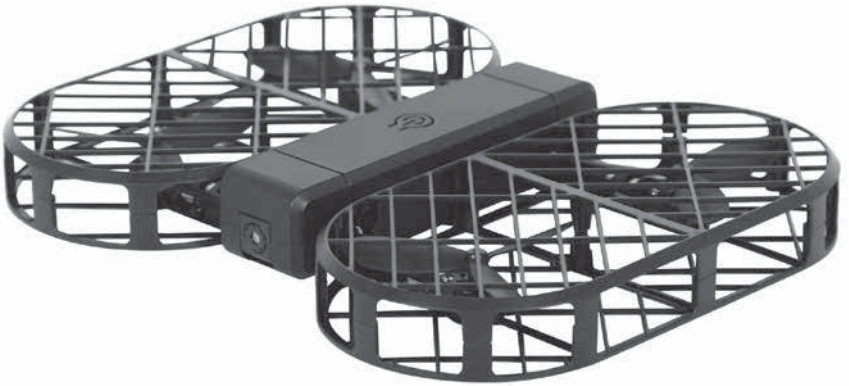

# THANK YOU.

Thank you for your purchase of Protocol's **Pixie Foldable Drone with Live Streaming Camera**. You are about to experience the best of what remote control flight has to offer. We strongly recommend that you take the time to read this manual thoroughly. It contains many tips and instructions on how to get the most out of this aircraft and maintain it for a long life.

As with any aircraft, this is a precision flying machine. Treat it well and enjoy all the fun it has to offer, flight after flight.

# TABLE OF CONTENTS

<b>01</b>	Safety & Precautions
<b>02</b>	Parts
<b>04</b>	Remote Battery Installation
<b>05</b>	Charging the Drone
<b>06</b>	Start-Up Procedure
<b>08</b>	Operation
<b>10</b>	Tips on 360° Flips
<b>12</b>	Speed Modes
<b>13</b>	Trim Adjustment
<b>14</b>	Troubleshooting
<b>16</b>	Flying Outdoors
<b>17</b>	Replacement Parts & Limited Warranty

# SAFETY WARNINGS

## HAVE FUN, BUT SAFETY FIRST!

- Read and follow instructions on how to synchronize electronics before each flight.
- To prevent damage to people or property, always avoid contact with other objects while in flight.
- Inspect aircraft prior to each flight and do not fly if damaged.
- Never expose product or any of its electronic parts to moisture, water, or heat sources.
- To prevent overheating, allow battery a cool-down period before recharging.
- To prolong engine life, allow a cool-down period between flights.
- Use only the charger and/or charging cable that is supplied with this item.
- Do not strike, cut, or pierce the internal battery or subject it to hard impacts.
- Do not mix old and new batteries or mix different types of batteries.
- Never attempt to modify function of vehicle or controller or attempt repairs using parts other than those supplied by Protocol. Spare parts are available at [www.ProtocolNY.com](http://www.ProtocolNY.com)

**THIS DEVICE USES COMPONENTS THAT OPERATE AT HIGH SPEEDS.  
AS WITH ANY SUCH DEVICE, USE CAUTION TO OPERATE SAFELY.**

**FAILURE TO FOLLOW ANY OF THESE GUIDELINES MAY RESULT IN BODILY  
INJURY OR DAMAGE TO PERSONAL OR PUBLIC PROPERTY.**

# PARTS

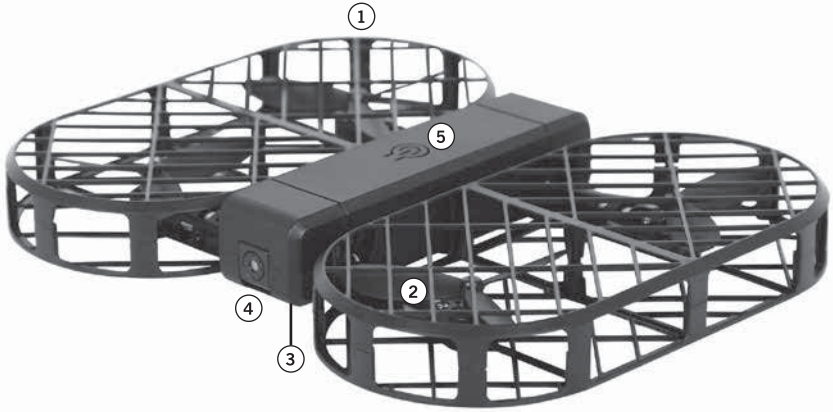

## DRONE

1. Cage
2. Blade
3. Battery Compartment
4. Camera
5. Power Switch

# PARTS

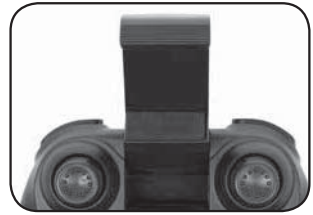

## REMOTE

1. Power Switch
2. Flip 360°
3. Forward/Backward
4. Bank Left/Right
5. Throttle
6. Turn Left/Right
7. Take Off/Landing
8. Trimmer
9. Speed Mode Selector
10. Emergency Stop
11. Compass Mode
12. Calibrate

## SPARE PARTS INCLUDED

- Replacement Blades

# REMOTE BATTERY INSTALLATION

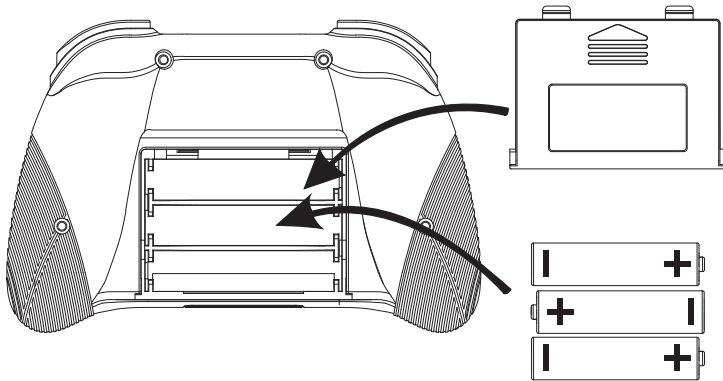

Remove battery cover from controller. Insert 3 x 'AAA' batteries according to indicated polarities. Replace battery cover.

1. Install batteries carefully.
2. Do not mix old and new batteries.
3. Do not mix different types of batteries.

## PHONE MOUNT

Pull the center portion of the remote up to expose the phone mount.

Pull up the top part of the clamp and insert the phone





# CHARGING THE DRONE BATTERY

1. Remove the battery from the drone.
2. Connect the USB charging cable to the battery.
3. Plug the charger into a USB port. The USB light will turn off while charging and will turn on once fully charged.
4. Plug the battery back into the drone.  
Charging time: approximately 40-60 minutes  
Flying time: approximately 5 minutes

- \* Low Battery Signal:  
The lights on the drone will begin to flash in flight to indicate low battery.

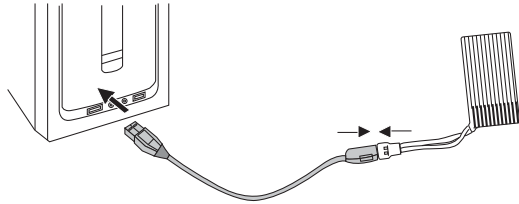

DO NOT CHARGE OVERNIGHT OR BEYOND THE CHARGING TIME STATED.  
DO NOT LEAVE BATTERY UNATTENDED.

\*Battery: Li-Po, 3.7V, 380mAh

If you purchased extra batteries, allow the engines to cool between flights in order to prolong engine life.

## CAUTION WHEN CHARGING

1. When charging, place product on a dry, well-ventilated surface and keep away from heat sources.
2. Always use adult supervision while charging.
3. In order to increase battery longevity, avoid repeat charging and excessive discharging.
4. As battery temperature is high immediately after flight, charge after cooling down for higher efficiency.
5. Do not strike or subject battery to hard impacts or sharp surfaces.
6. Do not use any other charger than that which is supplied with this item.
7. Do not use or leave battery near a heat source such as fire or space heater; exposure to heat may result in reduced performance or in some cases dangerous conditions.
8. If battery is left in charging state for an extended period of time after being fully charged, the battery may automatically discharge.
9. Never leave the battery unattended during charging.
10. Do not disassemble battery.
11. Do not submerge battery in water.

# START-UP PROCEDURE

Before flying, the drone and transmitter must be turned on in sequence and synchronized.

1. Turn on the drone and place it on an even surface. The blue lights on the drone are at the front and the yellow are at the back.
2. Turn on the remote control by pressing the power button for 2 seconds. The remote will beep twice.
3. Both indicators on the drone and the remote will flash while they are syncing.
4. Push the throttle up and then down to sync. You will hear two beeps and the lights will go steady to indicate the drone has synced.
5. Your drone is now synchronized, and in stand-by mode awaiting Engine Idle command.

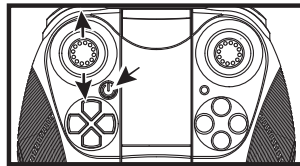

## NOTE:

If after 30 seconds, it has not recognized the drone, turn off the controller and repeat Start-Up procedure.

## STARTING THE ENGINE; ENGINE IDLE

After synchronizing the drone, push the throttle up and release to go into Idle Mode. Do not hold the throttle up or the drone will lift off.

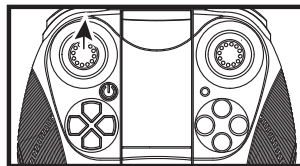

# START-UP PROCEDURE

## COMPASS MODE

Users have the option to exit the default orientation (blue lights at the front, yellow lights at the back). In Compass Mode, users can operate the drone without orientation. Regardless of where the drone is pointing, it will turn left or right according to the remote's command.

Compass Mode is good for beginners and is useful for drones that fly too far away for the user to be able to tell the orientation.

Follow the below instructions to change to Compass Mode:

1. It is easiest to set up Compass Mode before flight. Sync and turn on the engines.
2. Make sure your drone is aligned with the remote as indicated in the picture.
3. Press the Compass Mode button to enter Compass Mode.
4. Press the Compass Mode button again to leave Compass Mode.

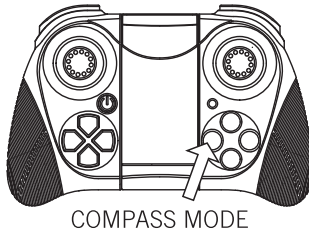
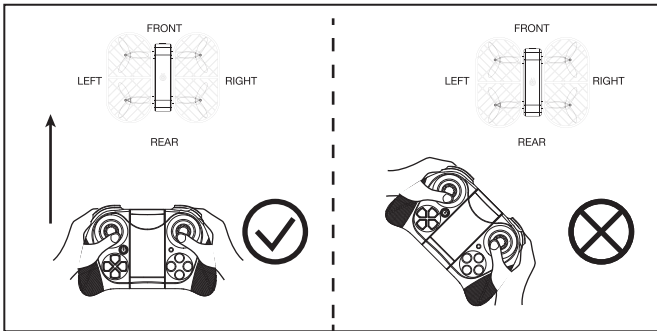

# OPERATION: FLYING THE DRONE

## TAKE-OFF:

1. Press the take off button. The drone will hover a few feet off the ground. Then gently advance the throttle to a desired height and release. The drone will hover at that height.\*

OR

2. From Idle mode, gently advance the throttle up to a desired height and release. The drone will hover at that height.\*

## LANDING:

1. Press the landing button to lower the drone to the ground.

OR

2. Push down on the throttle until the drone is on the ground.

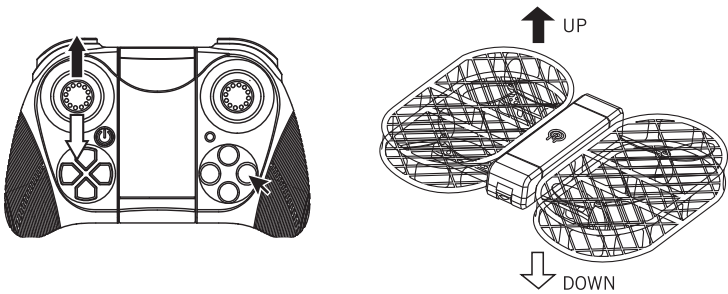

NOTE:

- **Emergency Shut Off: When in flight, press and hold the emergency stop button and the drone will shut off.**

\* The drone may drift a bit, especially in the first 30 seconds until the altitude sensor gets a good fix on the position. Some drift is normal.

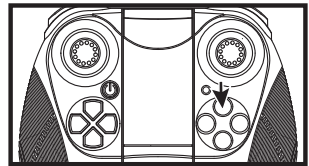

# OPERATION: FLYING THE DRONE

## FIRST TIME FLYERS!!! TAKE YOUR TIME! GO SLOW!

Practice hovering until you are comfortable with flight before attempting any other maneuvers. Make small movements letting the stick return to the center. If you start to lose control, don't panic. Just press land.

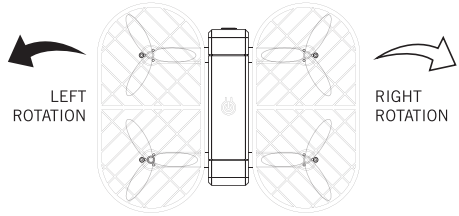
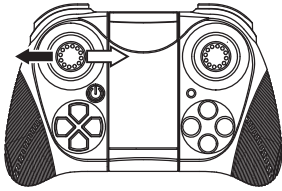

Pull the throttle left or right,  
the drone turns to the left or right.

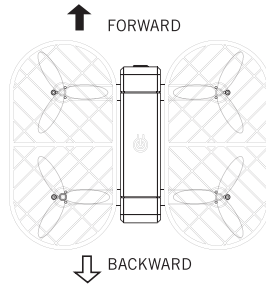
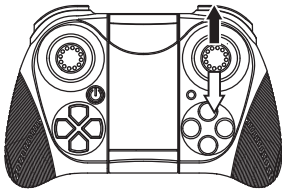

Push the direction lever up or down,  
the drone flies forward or backward.

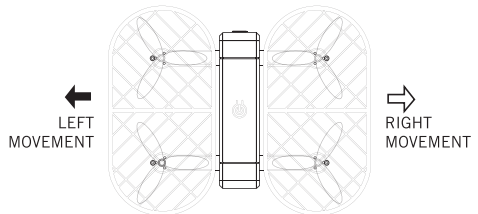
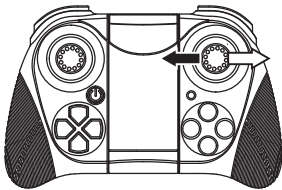

Pull the direction lever to the left or right,  
the drone banks to the left or right.

# TIPS ON 360° FLIPS

Once you have become skilled with the basics of drone flight, you can try some advanced maneuvers. At a height of at least 10 feet, press the Flip button once and move the direction lever in a desired direction to execute the flip.

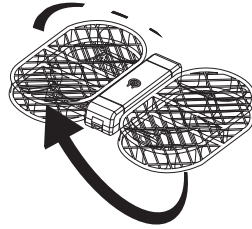
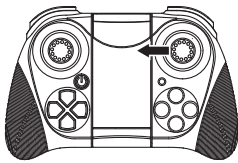
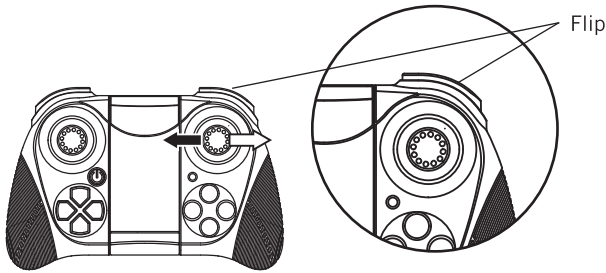

## LEFT 360° FLIP

Push the direction stick to the left and the drone will perform a 360° flip in that direction.

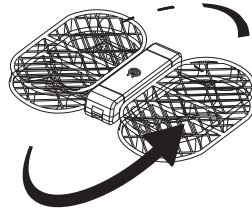
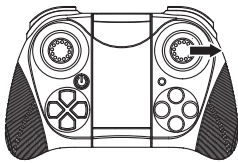

## RIGHT 360° FLIP

Push the direction stick to the right and the drone will perform a 360° flip in that direction.

## TIPS ON 360° FLIPS

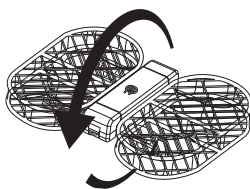
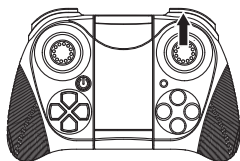

### **FORWARD 360° FLIP**

Push the direction stick forward and the drone will perform a 360° flip in that direction.

---

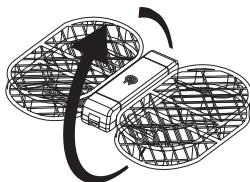
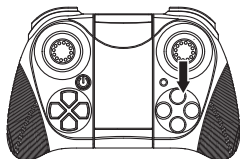

### **BACKWARD 360° FLIP**

Push the direction stick backward and the drone will perform a 360° flip in that direction.

# SPEED MODES

The Pixie features three speed modes. Choose the speed based on flight experience and level of comfort. At high speed the drone will pitch more than at low speed. Pixie is quite fast at its high speed and requires more piloting skills to fly competently. For safety take time to develop advanced skills by practicing at low speed first. The drone is preset to low speed. Press the Speed button to change the speed mode.

SPEED BUTTON

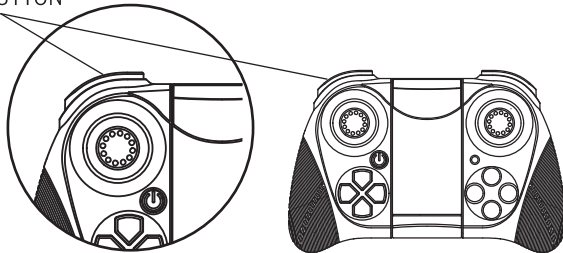



# TRIM ADJUSTMENT

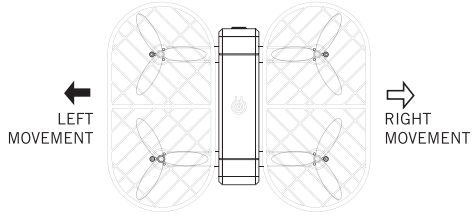
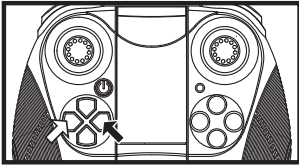

## SIDEWAYS TRIM

When the drone drifts to the left or right side unintentionally, you can correct it by pressing the trim button in the opposite direction until it evens out.

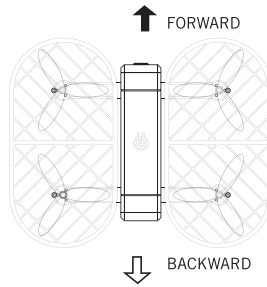
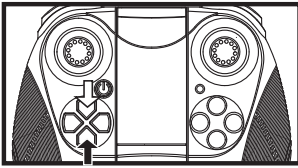

## FORWARD/BACKWARD TRIM

When the drone drifts forward/backward unintentionally, you can correct it by pressing the trim button in the opposite direction until it evens out.

\*NOTE: Trim adjustments are designed to counter drifts not caused by wind.

# TROUBLESHOOTING

## RE-CALIBRATING THE ALTITUDE SENSOR

If the drone crashes and after re-starting and trimming, it still is unstable, you have the option to re-calibrate the drone.

1. Turn on the drone and then the remote and sync.
2. Press the calibrate button.
3. The lights will flash and the remote will beep to indicate that the drone has re-calibrated.

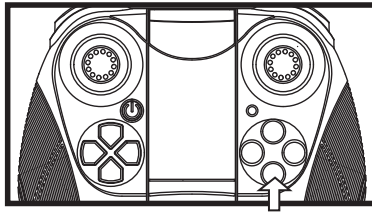

# TROUBLESHOOTING

\*Allow 15 minutes to pass between full flights as this will give the motors a chance to cool down. Failure to do so could wear out and shorten the life of the motors.

SYMPTOM	POSSIBLE CAUSE	POTENTIAL SOLUTION
Pixie does not respond	<ol style="list-style-type: none"><li>1. Communication between controller and aircraft was not synchronized during set up</li><li>2. Battery power depleted on aircraft, controller or both.</li></ol>	<ol style="list-style-type: none"><li>1. To synchronize, turn on aircraft first, place it on level ground, and then turn on controller.</li><li>2. Charge aircraft and/or replace batteries in controller.</li></ol>
Response to control inputs intermittent or erratic	<ol style="list-style-type: none"><li>1. Controller battery power nearly depleted.</li></ol>	<ol style="list-style-type: none"><li>1. Replace batteries in controller.</li></ol>
Pixie will not hover or strafe correctly	<ol style="list-style-type: none"><li>1. The aircraft was not on level ground during synchronization.</li><li>2. Trim settings are incorrect.</li></ol>	<ol style="list-style-type: none"><li>1. Re-synchronize aircraft and controller.</li><li>2. Recalibrate the Altitude Sensor.</li><li>3. Re-trim flight controls.</li></ol>

# FLYING OUTDOORS

## HOW TO PREVENT FLY AWAYS

To prevent “fly-away” situations (where drones seem to fly away out of control) it is important to first test and practice within close range before letting the drone fly too far away.

Each drone is designed to turn off the engines if the radio signal is lost. It is important to know and test the range of your drone before flying. We recommend turning on and syncing the drone and walking away while testing the engines. Keep walking and testing until it is obvious when you reach the point where the signal is not controlling the drone. This will be the control limit for the conditions in which you are flying. Distance does vary somewhat based on environmental and weather conditions, so testing the limit is advised. Fly in a range that is good for easy visual operation of the drone.

## IF YOU CAN'T SEE YOUR DRONE, THEN YOU CAN'T CONTROL YOUR DRONE.

\* Fly-aways are not covered by warranty as they are overwhelmingly caused by pilot error.

## REPLACEMENT PARTS

Thank you for your purchase of Protocol's **Pixie Foldable Drone with Live Streaming Camera**. We know that accidents can sometimes happen and that is why we offer spare parts kits on our website: **ProtocolNY.com**.

## LIMITED WARRANTY

At Protocol, we're dedicated to bringing you innovative and well-designed products that make living fun and easy. We stand behind all of our products and warrant this to be free from defects in workmanship and materials for 30 days from the date of purchase. The warranty does not cover transportation damage, misuse, accident, or similar events. Specific legal rights pertaining to this warranty may vary by state.

For service claims or questions please consult our website **[www.ProtocolNY.com](http://www.ProtocolNY.com)**.



This equipment has been tested and found to comply with the limits for a Class B digital device, pursuant to part 15 of the FCC Rules. These limits are designed to provide reasonable protection against harmful interference in a residential installation. This equipment generates, uses and can radiate radio frequency energy and, if not installed and used in accordance with the instructions, may cause harmful interference to radio communications. However, there is no guarantee that interference will not occur in a particular installation. If this equipment does cause harmful interference to radio or television reception, which can be determined by turning the equipment off and on, the user is encouraged to try to correct the interference by one or more of the following measures:

- Reorient or relocate the receiving antenna.
- Increase the separation between the equipment and receiver.
- Connect the equipment into an outlet on a circuit different from that to which the receiver is connected.
- Consult the dealer or an experienced radio/TV technician for help.

Caution: Any changes or modifications to this device not explicitly approved by manufacturer could void your authority to operate this equipment.

This device complies with part 15 of the FCC Rules. Operation is subject to the following two conditions: (1) This device may not cause harmful interference, and (2) this device must accept any interference received, including interference that may cause undesired operation.

The device has been evaluated to meet general RF exposure requirement. The device can be used in portable exposure condition without restriction.