

Report Number :TERF2209001659ER
 Operation Mode :CAT-M1 B4
 Test Mode :Tx
 EUT Pol :H Plane
 Test Frequency :1753.5 MHz

Test Site :SAC 3
 Test Date :2022-09-19
 Temp./Humi. :24.6/67
 Antenna Pol. :Vertical
 Engineer :Nick Lin

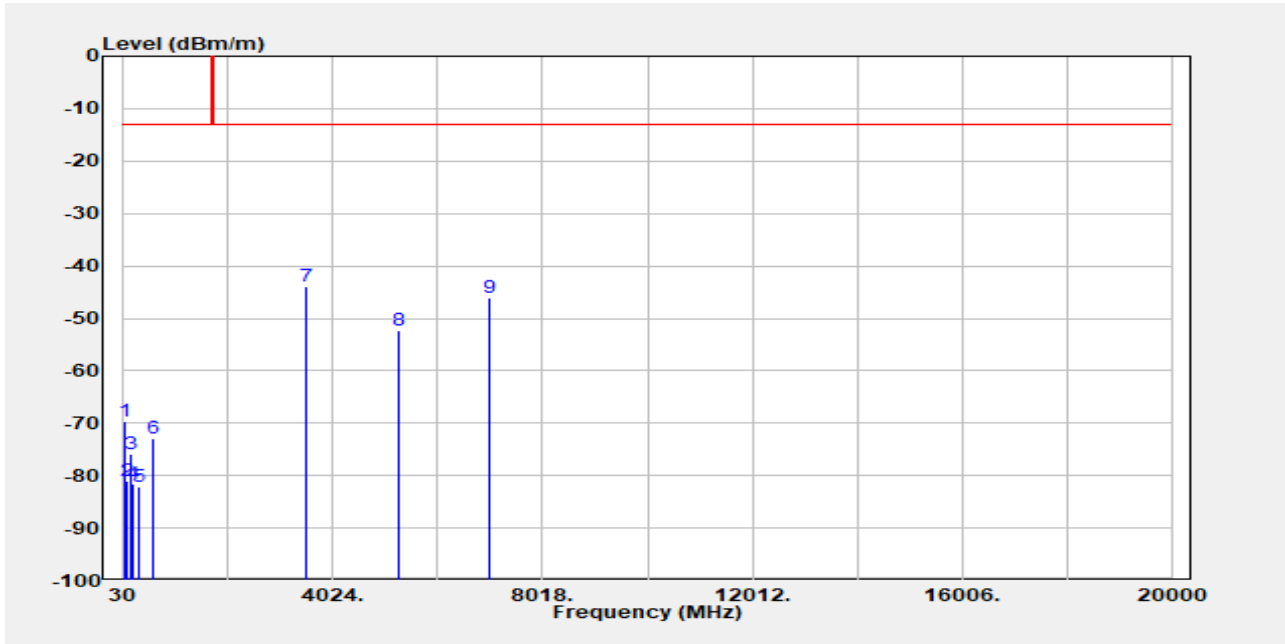

Freq. MHz	EIRP/ERP dBm	SG Output Level dBm	Antenna Gain dBi/dBd	Cable Loss dB	Limit dBm	Margin dB
63.950	-69.77	-61.27	-7.71	-0.79	-13.00	-56.77
101.780	-81.13	-71.77	-8.33	-1.03	-13.00	-68.13
156.100	-76.00	-70.53	-4.24	-1.23	-13.00	-63.00
213.330	-81.58	-78.96	-1.11	-1.50	-13.00	-68.58
321.970	-82.09	-79.14	-1.21	-1.75	-13.00	-69.09
605.210	-72.79	-69.46	-0.69	-2.64	-13.00	-59.79
3507.000	-43.99	-50.15	12.57	-6.41	-13.00	-30.99
5260.500	-52.29	-57.31	13.12	-8.10	-13.00	-39.29
7014.000	-45.97	-47.49	10.97	-9.45	-13.00	-32.97

Unless otherwise stated the results shown in this test report refer only to the sample(s) tested and such sample(s) are retained for 90 days only.

除非另有說明，此報告結果僅對測試之樣品負責，同時此樣品僅保留90天。本報告未經本公司書面許可，不可部份複製。

This document is issued by the Company subject to its General Conditions of Service printed overleaf, available on request or accessible at <http://www.sgs.com.tw/Terms-and-Conditions> and for electronic format documents, subject to Terms and Conditions for Electronic Documents at <http://www.sgs.com.tw/Terms-and-Conditions>. Attention is drawn to the limitation of liability, indemnification and jurisdiction issues defined therein. Any holder of this document is advised that information contained hereon reflects the Company's findings at the time of its intervention only and within the limits of Client's instructions, if any. The Company's sole responsibility is to its Client and this document does not exonerate parties to a transaction from exercising all their rights and obligations under the transaction documents. This document cannot be reproduced except in full, without prior written approval of the Company. Any unauthorized alteration, forgery or falsification of the content or appearance of this document is unlawful and offenders may be prosecuted to the fullest extent of the law.

Report Number :TERF2209001659ER
 Operation Mode :CAT-M1 B4
 Test Mode :Tx
 EUT Pol :H Plane
 Test Frequency :1753.5 MHz

Test Site :SAC 3
 Test Date :2022-09-19
 Temp./Humi. :24.6/67
 Antenna Pol. :Horizontal
 Engineer :Nick Lin

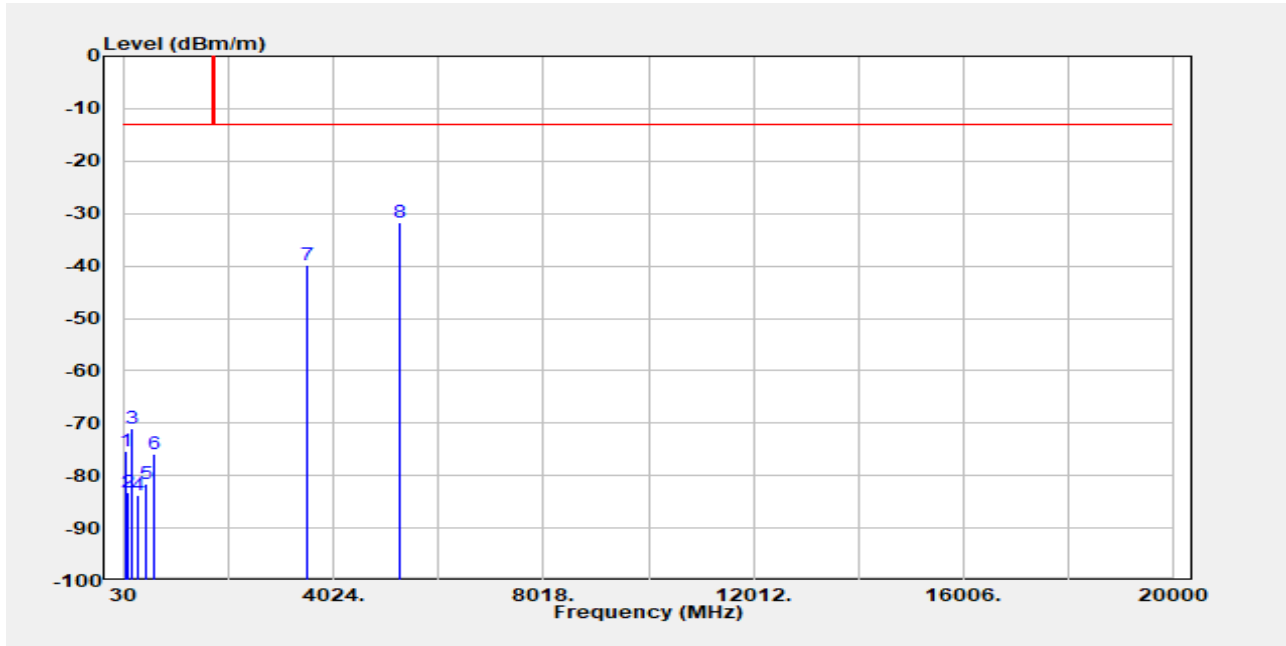

Freq. MHz	EIRP/ERP dBm	SG Output Level dBm	Antenna Gain dBi/dBd	Cable Loss dB	Limit dBm	Margin dB
65.890	-75.30	-67.14	-7.35	-0.81	-13.00	-62.30
94.020	-83.06	-74.30	-7.77	-1.00	-13.00	-70.06
155.130	-71.09	-65.56	-4.31	-1.22	-13.00	-58.09
291.900	-83.83	-80.59	-1.46	-1.78	-13.00	-70.83
450.010	-81.47	-78.18	-1.06	-2.23	-13.00	-68.47
605.210	-75.93	-72.60	-0.69	-2.64	-13.00	-62.93
3507.000	-39.72	-45.88	12.57	-6.41	-13.00	-26.72
5260.500	-31.63	-36.65	13.12	-8.10	-13.00	-18.63

Unless otherwise stated the results shown in this test report refer only to the sample(s) tested and such sample(s) are retained for 90 days only.

除非另有說明，此報告結果僅對測試之樣品負責，同時此樣品僅保留90天。本報告未經本公司書面許可，不可部份複製。

This document is issued by the Company subject to its General Conditions of Service printed overleaf, available on request or accessible at <http://www.sgs.com.tw/Terms-and-Conditions> and for electronic format documents, subject to Terms and Conditions for Electronic Documents at <http://www.sgs.com.tw/Terms-and-Conditions>. Attention is drawn to the limitation of liability, indemnification and jurisdiction issues defined therein. Any holder of this document is advised that information contained hereon reflects the Company's findings at the time of its intervention only and within the limits of Client's instructions, if any. The Company's sole responsibility is to its Client and this document does not exonerate parties to a transaction from exercising all their rights and obligations under the transaction documents. This document cannot be reproduced except in full, without prior written approval of the Company. Any unauthorized alteration, forgery or falsification of the content or appearance of this document is unlawful and offenders may be prosecuted to the fullest extent of the law.

Report Number :TERF2209001659ER
 Operation Mode :CAT-M1 B5
 Test Mode :Tx
 EUT Pol :H Plane
 Test Frequency :825.5 MHz

Test Site :SAC 3
 Test Date :2022-09-19
 Temp./Humi. :24.6/67
 Antenna Pol. :Vertical
 Engineer :Nick Lin

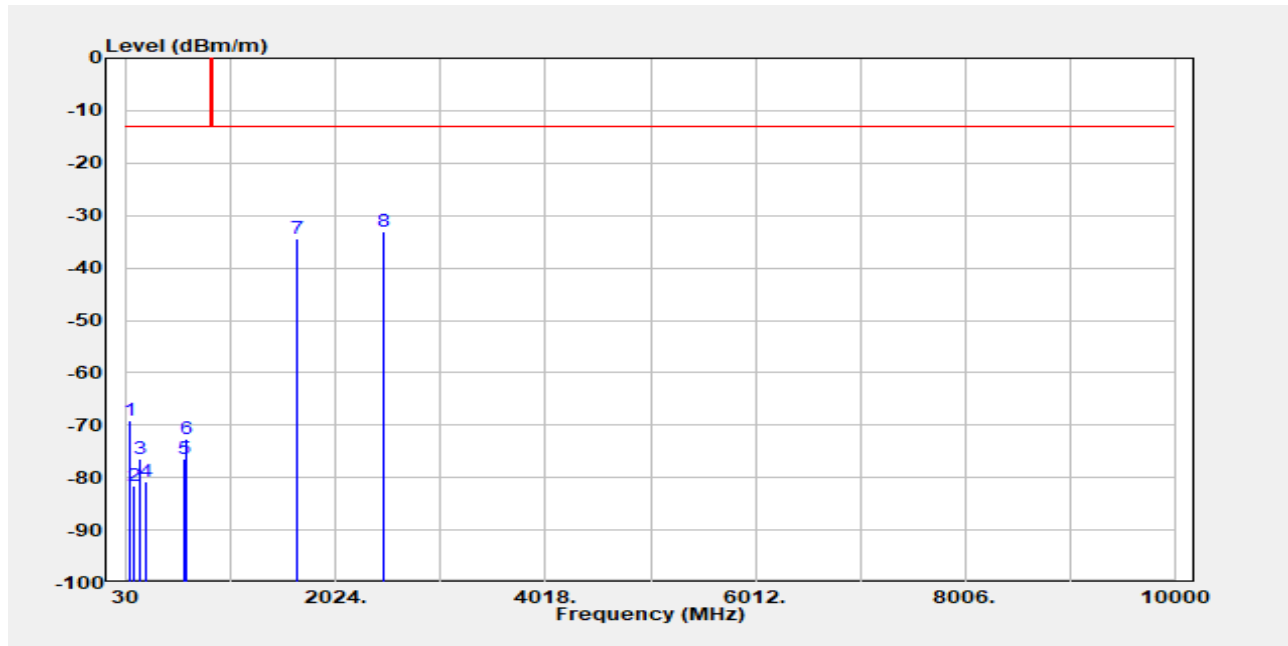

Freq. MHz	EIRP/ERP dBm	SG Output Level dBm	Antenna Gain dBi/dBd	Cable Loss dB	Limit dBm	Margin dB
63.950	-69.11	-60.61	-7.71	-0.79	-13.00	-56.11
103.720	-81.52	-72.20	-8.28	-1.04	-13.00	-68.52
156.100	-76.42	-70.96	-4.24	-1.23	-13.00	-63.42
212.360	-80.84	-78.14	-1.19	-1.50	-13.00	-67.84
572.230	-76.47	-72.98	-0.78	-2.71	-13.00	-63.47
605.210	-72.52	-69.19	-0.69	-2.64	-13.00	-59.52
1651.000	-34.36	-39.89	9.90	-4.37	-13.00	-21.36
2476.500	-33.18	-38.37	10.61	-5.41	-13.00	-20.18

Unless otherwise stated the results shown in this test report refer only to the sample(s) tested and such sample(s) are retained for 90 days only.

除非另有說明，此報告結果僅對測試之樣品負責，同時此樣品僅保留90天。本報告未經本公司書面許可，不可部份複製。

This document is issued by the Company subject to its General Conditions of Service printed overleaf, available on request or accessible at <http://www.sgs.com.tw/Terms-and-Conditions> and for electronic format documents, subject to Terms and Conditions for Electronic Documents at <http://www.sgs.com.tw/Terms-and-Conditions>. Attention is drawn to the limitation of liability, indemnification and jurisdiction issues defined therein. Any holder of this document is advised that information contained hereon reflects the Company's findings at the time of its intervention only and within the limits of Client's instructions, if any. The Company's sole responsibility is to its Client and this document does not exonerate parties to a transaction from exercising all their rights and obligations under the transaction documents. This document cannot be reproduced except in full, without prior written approval of the Company. Any unauthorized alteration, forgery or falsification of the content or appearance of this document is unlawful and offenders may be prosecuted to the fullest extent of the law.

Report Number :TERF2209001659ER
 Operation Mode :CAT-M1 B5
 Test Mode :Tx
 EUT Pol :H Plane
 Test Frequency :825.5 MHz

Test Site :SAC 3
 Test Date :2022-09-19
 Temp./Humi. :24.6/67
 Antenna Pol. :Horizontal
 Engineer :Nick Lin

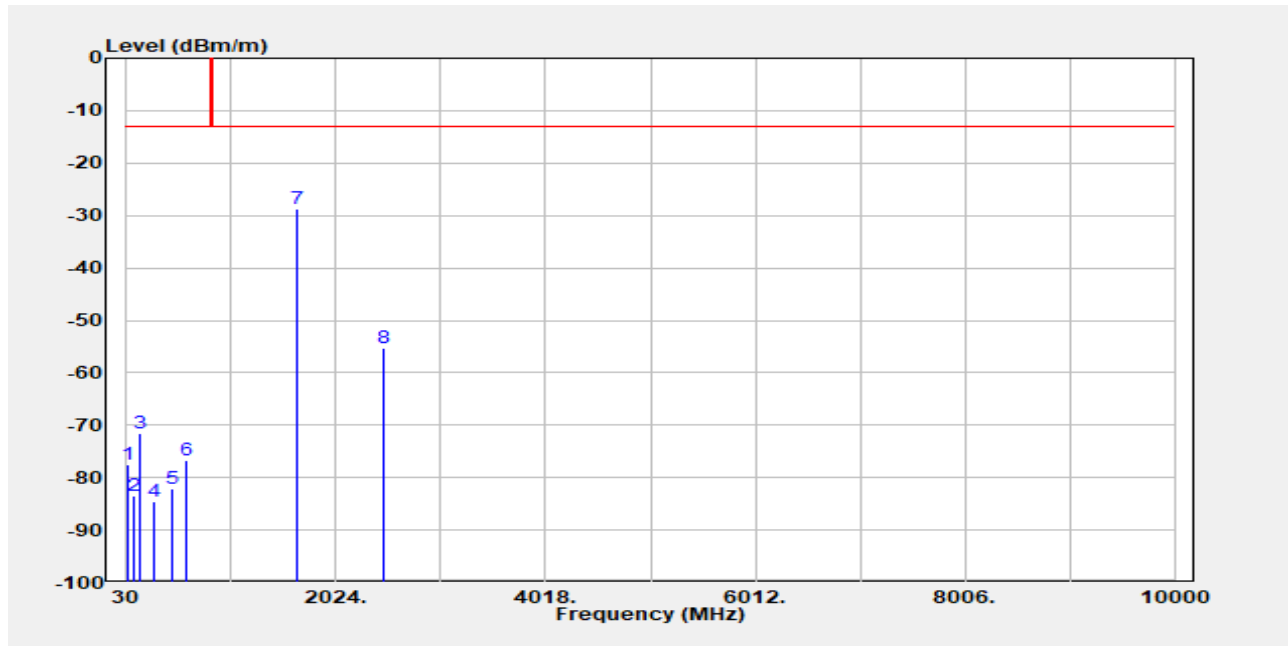

Freq. MHz	EIRP/ERP dBm	SG Output Level dBm	Antenna Gain dBi/dBd	Cable Loss dB	Limit dBm	Margin dB
47.460	-77.51	-62.81	-14.02	-0.69	-13.00	-64.51
94.990	-83.54	-74.67	-7.87	-1.00	-13.00	-70.54
158.040	-71.42	-66.13	-4.05	-1.25	-13.00	-58.42
289.960	-84.65	-81.40	-1.48	-1.77	-13.00	-71.65
467.470	-82.03	-78.62	-1.03	-2.37	-13.00	-69.03
605.210	-76.58	-73.25	-0.69	-2.64	-13.00	-63.58
1651.000	-28.81	-34.34	9.90	-4.37	-13.00	-15.81
2476.500	-55.34	-60.53	10.61	-5.41	-13.00	-42.34

Unless otherwise stated the results shown in this test report refer only to the sample(s) tested and such sample(s) are retained for 90 days only.

除非另有說明，此報告結果僅對測試之樣品負責，同時此樣品僅保留90天。本報告未經本公司書面許可，不可部份複製。

This document is issued by the Company subject to its General Conditions of Service printed overleaf, available on request or accessible at <http://www.sgs.com.tw/Terms-and-Conditions> and for electronic format documents, subject to Terms and Conditions for Electronic Documents at <http://www.sgs.com.tw/Terms-and-Conditions>. Attention is drawn to the limitation of liability, indemnification and jurisdiction issues defined therein. Any holder of this document is advised that information contained hereon reflects the Company's findings at the time of its intervention only and within the limits of Client's instructions, if any. The Company's sole responsibility is to its Client and this document does not exonerate parties to a transaction from exercising all their rights and obligations under the transaction documents. This document cannot be reproduced except in full, without prior written approval of the Company. Any unauthorized alteration, forgery or falsification of the content or appearance of this document is unlawful and offenders may be prosecuted to the fullest extent of the law.

Report Number :TERF2209001659ER
 Operation Mode :CAT-M1 B5
 Test Mode :Tx
 EUT Pol :H Plane
 Test Frequency :836.5 MHz

Test Site :SAC 3
 Test Date :2022-09-19
 Temp./Humi. :24.6/67
 Antenna Pol. :Vertical
 Engineer :Nick Lin

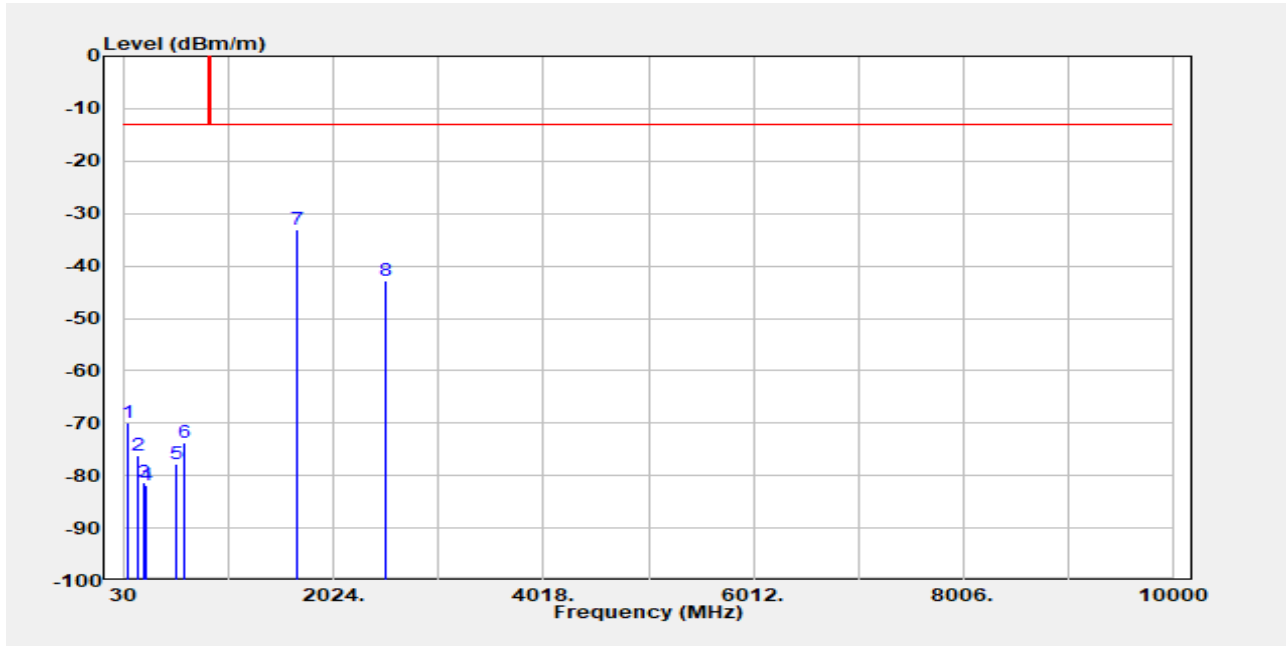

Freq. MHz	EIRP/ERP dBm	SG Output Level dBm	Antenna Gain dBi/dBd	Cable Loss dB	Limit dBm	Margin dB
65.890	-70.03	-61.87	-7.35	-0.81	-13.00	-57.03
156.100	-76.18	-70.72	-4.24	-1.23	-13.00	-63.18
212.360	-81.32	-78.62	-1.19	-1.50	-13.00	-68.32
240.490	-81.84	-78.35	-1.84	-1.65	-13.00	-68.84
523.730	-77.86	-74.80	-0.84	-2.21	-13.00	-64.86
605.210	-73.71	-70.39	-0.69	-2.64	-13.00	-60.71
1673.000	-32.96	-38.50	9.95	-4.40	-13.00	-19.96
2509.500	-42.69	-47.96	10.74	-5.46	-13.00	-29.69

Unless otherwise stated the results shown in this test report refer only to the sample(s) tested and such sample(s) are retained for 90 days only.

除非另有說明，此報告結果僅對測試之樣品負責，同時此樣品僅保留90天。本報告未經本公司書面許可，不可部份複製。

This document is issued by the Company subject to its General Conditions of Service printed overleaf, available on request or accessible at <http://www.sgs.com.tw/Terms-and-Conditions> and for electronic format documents, subject to Terms and Conditions for Electronic Documents at <http://www.sgs.com.tw/Terms-and-Conditions>. Attention is drawn to the limitation of liability, indemnification and jurisdiction issues defined therein. Any holder of this document is advised that information contained hereon reflects the Company's findings at the time of its intervention only and within the limits of Client's instructions, if any. The Company's sole responsibility is to its Client and this document does not exonerate parties to a transaction from exercising all their rights and obligations under the transaction documents. This document cannot be reproduced except in full, without prior written approval of the Company. Any unauthorized alteration, forgery or falsification of the content or appearance of this document is unlawful and offenders may be prosecuted to the fullest extent of the law.

Report Number :TERF2209001659ER
 Operation Mode :CAT-M1 B5
 Test Mode :Tx
 EUT Pol :H Plane
 Test Frequency :836.5 MHz

Test Site :SAC 3
 Test Date :2022-09-19
 Temp./Humi. :24.6/67
 Antenna Pol. :Horizontal
 Engineer :Nick Lin

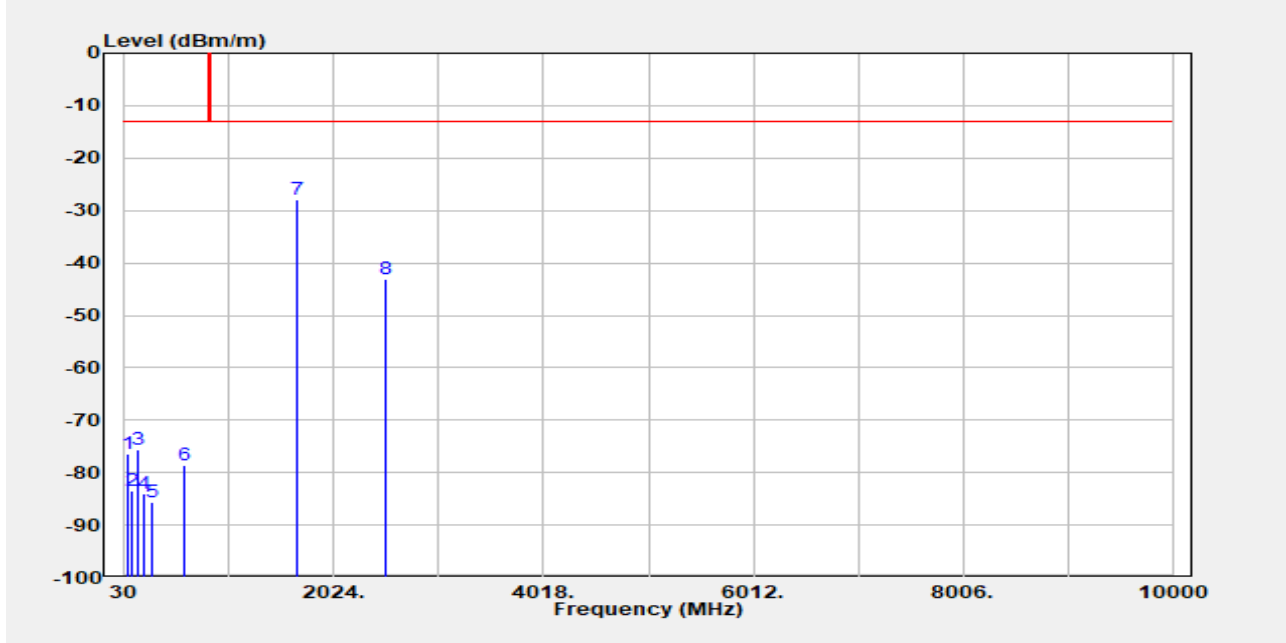

Freq. MHz	EIRP/ERP dBm	SG Output Level dBm	Antenna Gain dBi/dBd	Cable Loss dB	Limit dBm	Margin dB
63.950	-76.40	-67.90	-7.71	-0.79	-13.00	-63.40
93.050	-83.56	-74.91	-7.66	-0.99	-13.00	-70.56
157.070	-75.49	-70.24	-4.01	-1.24	-13.00	-62.49
213.330	-84.14	-81.53	-1.11	-1.50	-13.00	-71.14
293.840	-85.76	-82.52	-1.44	-1.80	-13.00	-72.76
605.210	-78.46	-75.13	-0.69	-2.64	-13.00	-65.46
1673.000	-27.88	-33.43	9.95	-4.40	-13.00	-14.88
2509.500	-43.03	-48.31	10.74	-5.46	-13.00	-30.03

Unless otherwise stated the results shown in this test report refer only to the sample(s) tested and such sample(s) are retained for 90 days only.

除非另有說明，此報告結果僅對測試之樣品負責，同時此樣品僅保留90天。本報告未經本公司書面許可，不可部份複製。

This document is issued by the Company subject to its General Conditions of Service printed overleaf, available on request or accessible at <http://www.sgs.com.tw/Terms-and-Conditions> and for electronic format documents, subject to Terms and Conditions for Electronic Documents at <http://www.sgs.com.tw/Terms-and-Conditions>. Attention is drawn to the limitation of liability, indemnification and jurisdiction issues defined therein. Any holder of this document is advised that information contained hereon reflects the Company's findings at the time of its intervention only and within the limits of Client's instructions, if any. The Company's sole responsibility is to its Client and this document does not exonerate parties to a transaction from exercising all their rights and obligations under the transaction documents. This document cannot be reproduced except in full, without prior written approval of the Company. Any unauthorized alteration, forgery or falsification of the content or appearance of this document is unlawful and offenders may be prosecuted to the fullest extent of the law.

Report Number :TERF2209001659ER
 Operation Mode :CAT-M1 B5
 Test Mode :Tx
 EUT Pol :H Plane
 Test Frequency :847.5 MHz

Test Site :SAC 3
 Test Date :2022-09-19
 Temp./Humi. :24.6/67
 Antenna Pol. :Vertical
 Engineer :Nick Lin

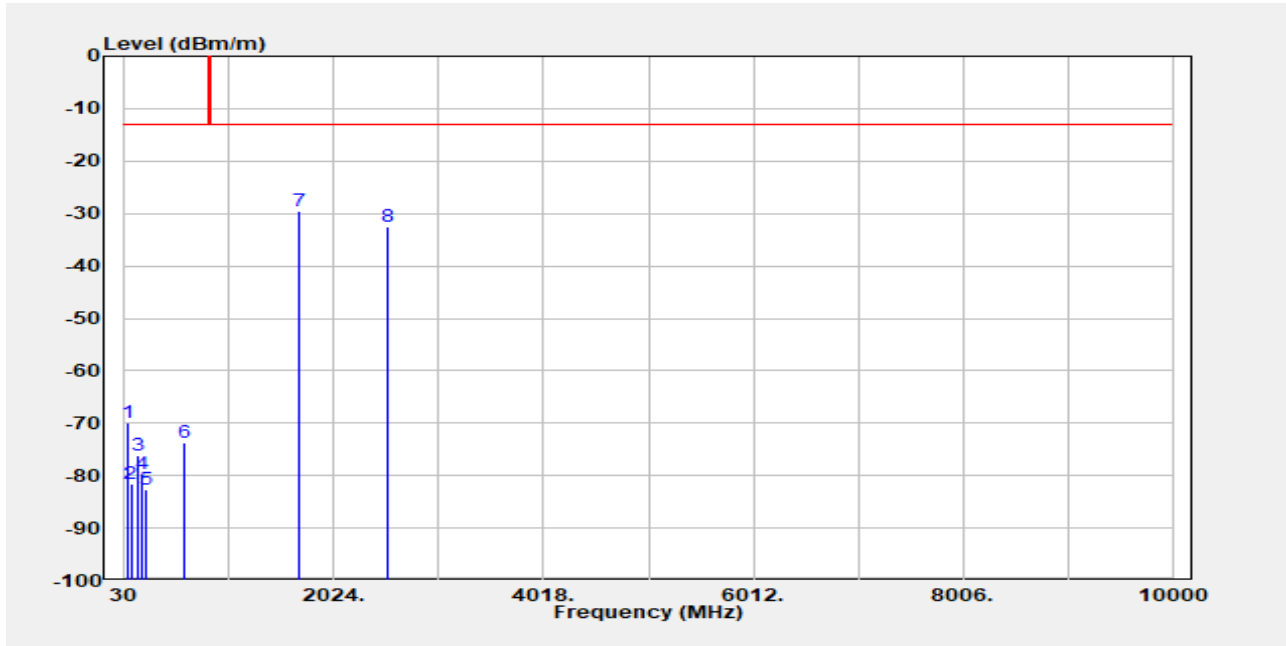

Freq. MHz	EIRP/ERP dBm	SG Output Level dBm	Antenna Gain dBi/dBd	Cable Loss dB	Limit dBm	Margin dB
63.950	-69.79	-61.30	-7.71	-0.79	-13.00	-56.79
90.140	-81.62	-73.39	-7.24	-0.98	-13.00	-68.62
151.250	-76.22	-70.31	-4.73	-1.17	-13.00	-63.22
188.110	-79.58	-76.70	-1.44	-1.44	-13.00	-66.58
239.520	-82.55	-79.10	-1.80	-1.64	-13.00	-69.55
605.210	-73.61	-70.28	-0.69	-2.64	-13.00	-60.61
1695.000	-29.55	-35.11	9.99	-4.43	-13.00	-16.55
2542.500	-32.50	-37.89	10.87	-5.48	-13.00	-19.50

Unless otherwise stated the results shown in this test report refer only to the sample(s) tested and such sample(s) are retained for 90 days only.

除非另有說明，此報告結果僅對測試之樣品負責，同時此樣品僅保留90天。本報告未經本公司書面許可，不可部份複製。

This document is issued by the Company subject to its General Conditions of Service printed overleaf, available on request or accessible at <http://www.sgs.com.tw/Terms-and-Conditions> and for electronic format documents, subject to Terms and Conditions for Electronic Documents at <http://www.sgs.com.tw/Terms-and-Conditions>. Attention is drawn to the limitation of liability, indemnification and jurisdiction issues defined therein. Any holder of this document is advised that information contained hereon reflects the Company's findings at the time of its intervention only and within the limits of Client's instructions, if any. The Company's sole responsibility is to its Client and this document does not exonerate parties to a transaction from exercising all their rights and obligations under the transaction documents. This document cannot be reproduced except in full, without prior written approval of the Company. Any unauthorized alteration, forgery or falsification of the content or appearance of this document is unlawful and offenders may be prosecuted to the fullest extent of the law.

Report Number :TERF2209001659ER
 Operation Mode :CAT-M1 B5
 Test Mode :Tx
 EUT Pol :H Plane
 Test Frequency :847.5 MHz

Test Site :SAC 3
 Test Date :2022-09-19
 Temp./Humi. :24.6/67
 Antenna Pol. :Horizontal
 Engineer :Nick Lin

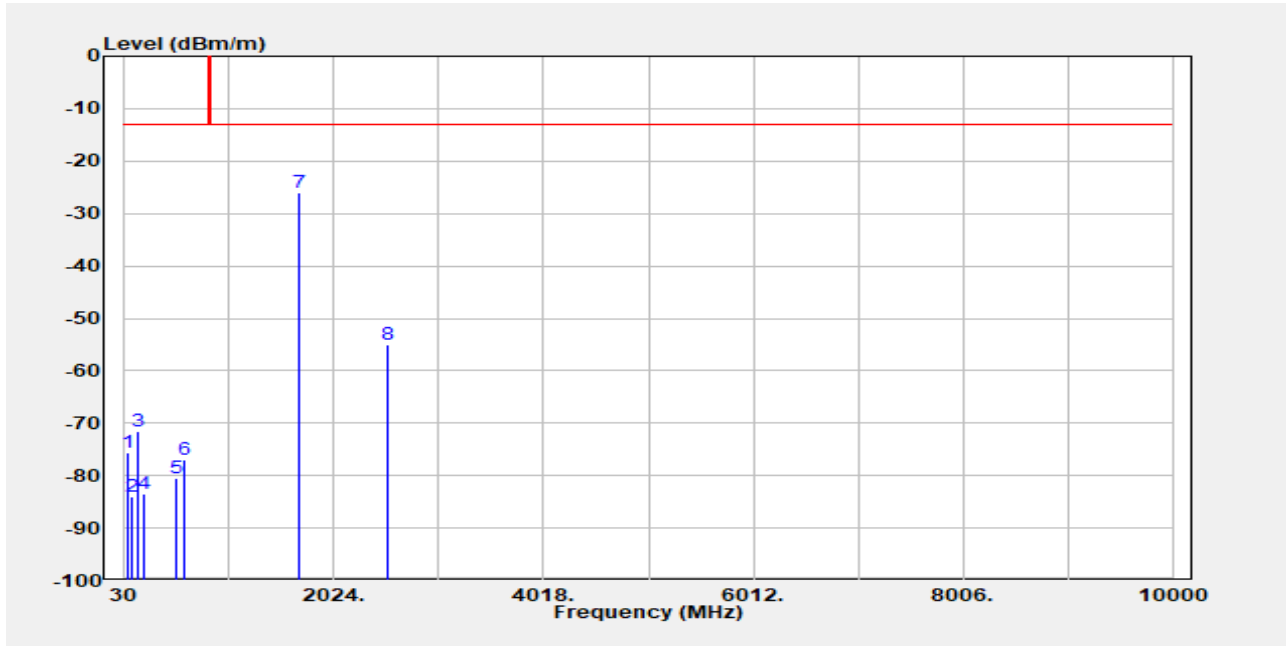

Freq. MHz	EIRP/ERP dBm	SG Output Level dBm	Antenna Gain dBi/dBd	Cable Loss dB	Limit dBm	Margin dB
64.920	-75.65	-67.36	-7.49	-0.80	-13.00	-62.65
94.990	-84.09	-75.22	-7.87	-1.00	-13.00	-71.09
148.340	-71.58	-65.36	-5.03	-1.19	-13.00	-58.58
210.420	-83.49	-80.64	-1.35	-1.50	-13.00	-70.49
529.550	-80.57	-77.66	-0.84	-2.07	-13.00	-67.57
605.210	-76.84	-73.52	-0.69	-2.64	-13.00	-63.84
1695.000	-25.98	-31.54	9.99	-4.43	-13.00	-12.98
2542.500	-55.00	-60.39	10.87	-5.48	-13.00	-42.00

Unless otherwise stated the results shown in this test report refer only to the sample(s) tested and such sample(s) are retained for 90 days only.

除非另有說明，此報告結果僅對測試之樣品負責，同時此樣品僅保留90天。本報告未經本公司書面許可，不可部份複製。

This document is issued by the Company subject to its General Conditions of Service printed overleaf, available on request or accessible at <http://www.sgs.com.tw/Terms-and-Conditions> and for electronic format documents, subject to Terms and Conditions for Electronic Documents at <http://www.sgs.com.tw/Terms-and-Conditions>. Attention is drawn to the limitation of liability, indemnification and jurisdiction issues defined therein. Any holder of this document is advised that information contained hereon reflects the Company's findings at the time of its intervention only and within the limits of Client's instructions, if any. The Company's sole responsibility is to its Client and this document does not exonerate parties to a transaction from exercising all their rights and obligations under the transaction documents. This document cannot be reproduced except in full, without prior written approval of the Company. Any unauthorized alteration, forgery or falsification of the content or appearance of this document is unlawful and offenders may be prosecuted to the fullest extent of the law.

Report Number :TERF2209001659ER
 Operation Mode :CAT-M1 B12
 Test Mode :Tx
 EUT Pol :H Plane
 Test Frequency :700.5 MHz

Test Site :SAC 3
 Test Date :2022-09-19
 Temp./Humi. :24.6/67
 Antenna Pol. :Vertical
 Engineer :Nick Lin

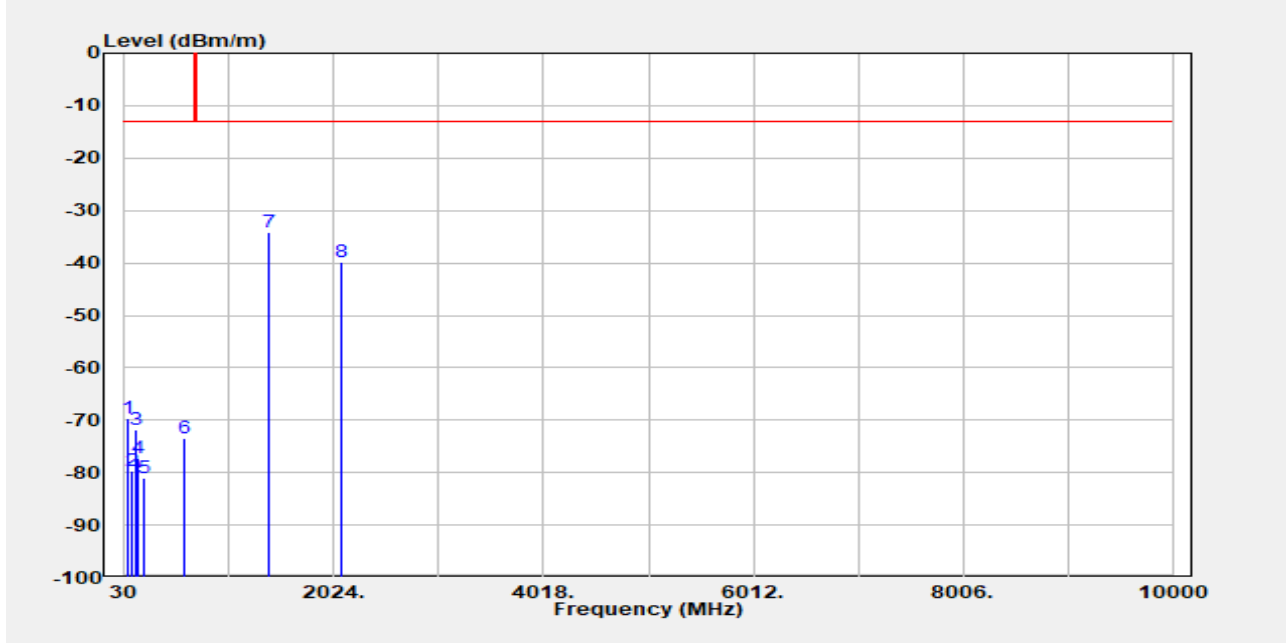

Freq. MHz	EIRP/ERP dBm	SG Output Level dBm	Antenna Gain dBi/dBd	Cable Loss dB	Limit dBm	Margin dB
64.920	-69.57	-61.28	-7.49	-0.80	-13.00	-56.57
103.720	-79.79	-70.47	-8.28	-1.04	-13.00	-66.79
141.550	-71.74	-64.73	-5.71	-1.30	-13.00	-58.74
165.800	-77.24	-72.74	-3.22	-1.29	-13.00	-64.24
211.390	-81.12	-78.35	-1.27	-1.50	-13.00	-68.12
605.210	-73.45	-70.12	-0.69	-2.64	-13.00	-60.45
1401.000	-34.18	-38.07	7.91	-4.02	-13.00	-21.18
2101.500	-39.85	-44.84	9.88	-4.89	-13.00	-26.85

Unless otherwise stated the results shown in this test report refer only to the sample(s) tested and such sample(s) are retained for 90 days only.

除非另有說明，此報告結果僅對測試之樣品負責，同時此樣品僅保留90天。本報告未經本公司書面許可，不可部份複製。

This document is issued by the Company subject to its General Conditions of Service printed overleaf, available on request or accessible at <http://www.sgs.com.tw/Terms-and-Conditions> and for electronic format documents, subject to Terms and Conditions for Electronic Documents at <http://www.sgs.com.tw/Terms-and-Conditions>. Attention is drawn to the limitation of liability, indemnification and jurisdiction issues defined therein. Any holder of this document is advised that information contained hereon reflects the Company's findings at the time of its intervention only and within the limits of Client's instructions, if any. The Company's sole responsibility is to its Client and this document does not exonerate parties to a transaction from exercising all their rights and obligations under the transaction documents. This document cannot be reproduced except in full, without prior written approval of the Company. Any unauthorized alteration, forgery or falsification of the content or appearance of this document is unlawful and offenders may be prosecuted to the fullest extent of the law.

Report Number :TERF2209001659ER
 Operation Mode :CAT-M1 B12
 Test Mode :Tx
 EUT Pol :H Plane
 Test Frequency :700.5 MHz

Test Site :SAC 3
 Test Date :2022-09-19
 Temp./Humi. :24.6/67
 Antenna Pol. :Horizontal
 Engineer :Nick Lin

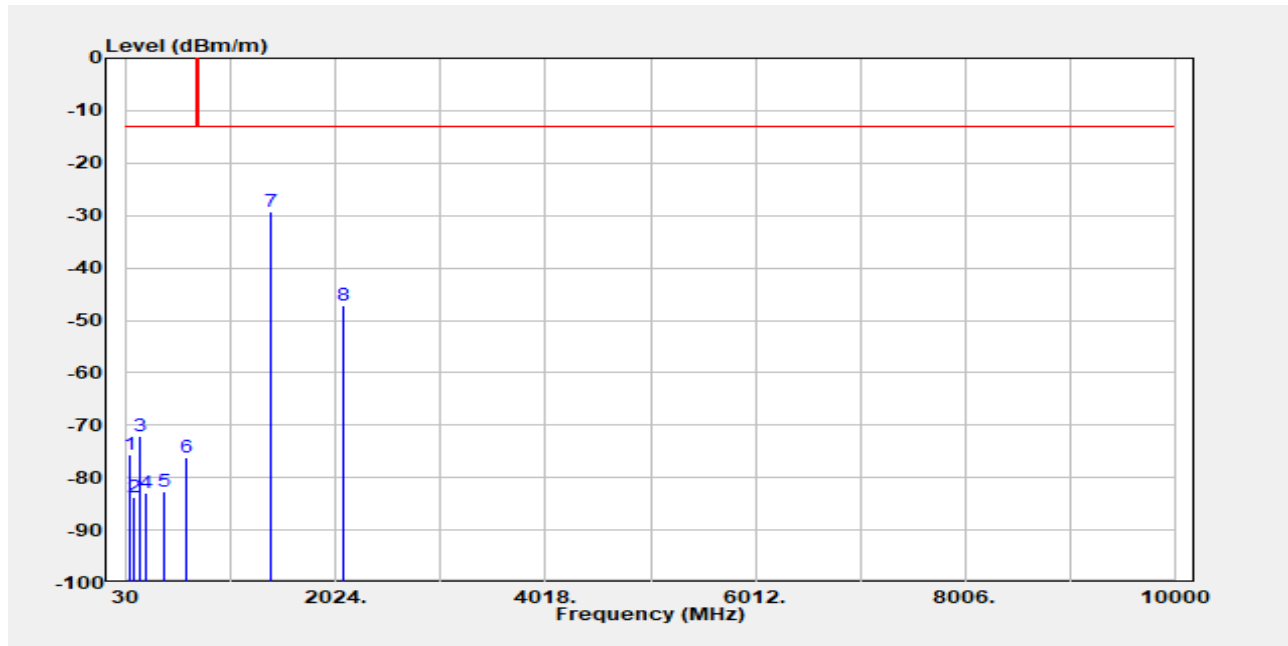

Freq. MHz	EIRP/ERP dBm	SG Output Level dBm	Antenna Gain dBi/dBd	Cable Loss dB	Limit dBm	Margin dB
64.920	-75.59	-67.30	-7.49	-0.80	-13.00	-62.59
92.080	-83.75	-75.30	-7.47	-0.99	-13.00	-70.75
156.100	-72.09	-66.62	-4.24	-1.23	-13.00	-59.09
206.540	-82.90	-79.88	-1.53	-1.49	-13.00	-69.90
385.020	-82.73	-79.46	-1.22	-2.06	-13.00	-69.73
605.210	-76.18	-72.85	-0.69	-2.64	-13.00	-63.18
1401.000	-29.14	-33.03	7.91	-4.02	-13.00	-16.14
2101.500	-47.05	-52.04	9.88	-4.89	-13.00	-34.05

Unless otherwise stated the results shown in this test report refer only to the sample(s) tested and such sample(s) are retained for 90 days only.

除非另有說明，此報告結果僅對測試之樣品負責，同時此樣品僅保留90天。本報告未經本公司書面許可，不可部份複製。

This document is issued by the Company subject to its General Conditions of Service printed overleaf, available on request or accessible at <http://www.sgs.com.tw/Terms-and-Conditions> and for electronic format documents, subject to Terms and Conditions for Electronic Documents at <http://www.sgs.com.tw/Terms-and-Conditions>. Attention is drawn to the limitation of liability, indemnification and jurisdiction issues defined therein. Any holder of this document is advised that information contained hereon reflects the Company's findings at the time of its intervention only and within the limits of Client's instructions, if any. The Company's sole responsibility is to its Client and this document does not exonerate parties to a transaction from exercising all their rights and obligations under the transaction documents. This document cannot be reproduced except in full, without prior written approval of the Company. Any unauthorized alteration, forgery or falsification of the content or appearance of this document is unlawful and offenders may be prosecuted to the fullest extent of the law.

Report Number :TERF2209001659ER
 Operation Mode :CAT-M1 B12
 Test Mode :Tx
 EUT Pol :H Plane
 Test Frequency :707.5 MHz

Test Site :SAC 3
 Test Date :2022-09-19
 Temp./Humi. :24.6/67
 Antenna Pol. :Vertical
 Engineer :Nick Lin

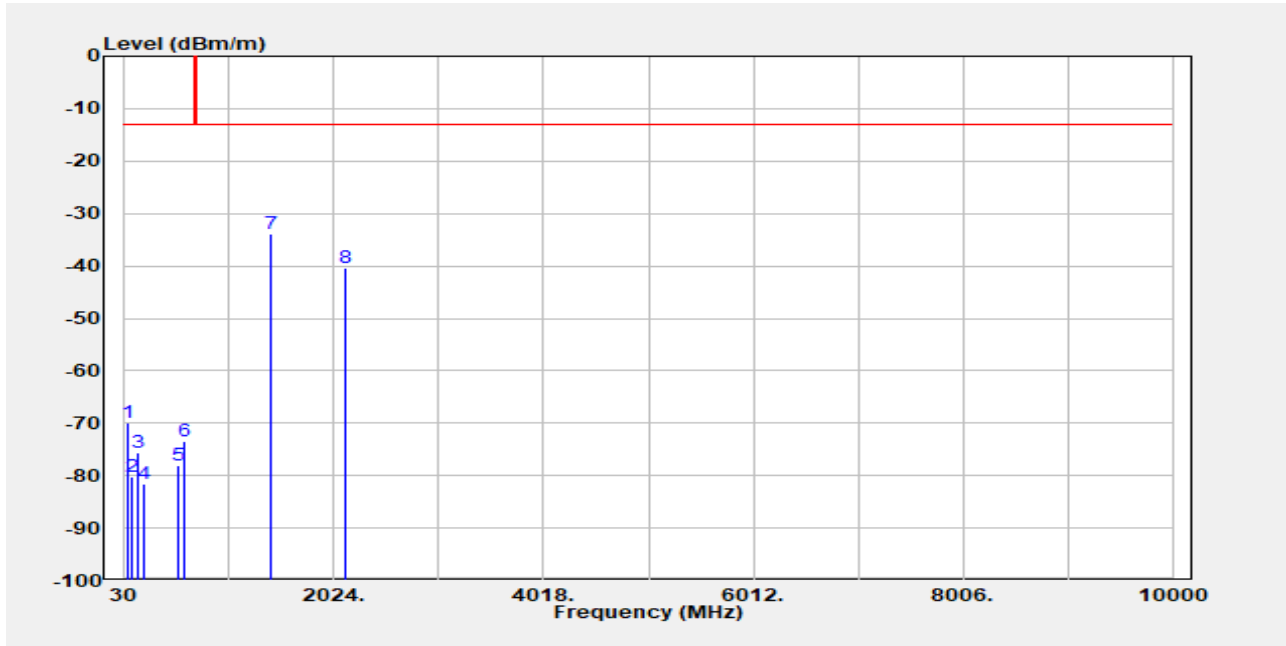

Freq. MHz	EIRP/ERP dBm	SG Output Level dBm	Antenna Gain dBi/dBd	Cable Loss dB	Limit dBm	Margin dB
63.950	-69.97	-61.47	-7.71	-0.79	-13.00	-56.97
103.720	-80.08	-70.76	-8.28	-1.04	-13.00	-67.08
156.100	-75.73	-70.27	-4.24	-1.23	-13.00	-62.73
212.360	-81.61	-78.91	-1.19	-1.50	-13.00	-68.61
537.310	-78.18	-74.90	-1.01	-2.27	-13.00	-65.18
605.210	-73.55	-70.22	-0.69	-2.64	-13.00	-60.55
1415.000	-33.85	-37.81	7.99	-4.03	-13.00	-20.85
2122.500	-40.29	-45.03	9.67	-4.93	-13.00	-27.29

Unless otherwise stated the results shown in this test report refer only to the sample(s) tested and such sample(s) are retained for 90 days only.

除非另有說明，此報告結果僅對測試之樣品負責，同時此樣品僅保留90天。本報告未經本公司書面許可，不可部份複製。

This document is issued by the Company subject to its General Conditions of Service printed overleaf, available on request or accessible at <http://www.sgs.com.tw/Terms-and-Conditions> and for electronic format documents, subject to Terms and Conditions for Electronic Documents at <http://www.sgs.com.tw/Terms-and-Conditions>. Attention is drawn to the limitation of liability, indemnification and jurisdiction issues defined therein. Any holder of this document is advised that information contained hereon reflects the Company's findings at the time of its intervention only and within the limits of Client's instructions, if any. The Company's sole responsibility is to its Client and this document does not exonerate parties to a transaction from exercising all their rights and obligations under the transaction documents. This document cannot be reproduced except in full, without prior written approval of the Company. Any unauthorized alteration, forgery or falsification of the content or appearance of this document is unlawful and offenders may be prosecuted to the fullest extent of the law.

Report Number :TERF2209001659ER
 Operation Mode :CAT-M1 B12
 Test Mode :Tx
 EUT Pol :H Plane
 Test Frequency :707.5 MHz

Test Site :SAC 3
 Test Date :2022-09-19
 Temp./Humi. :24.6/67
 Antenna Pol. :Horizontal
 Engineer :Nick Lin

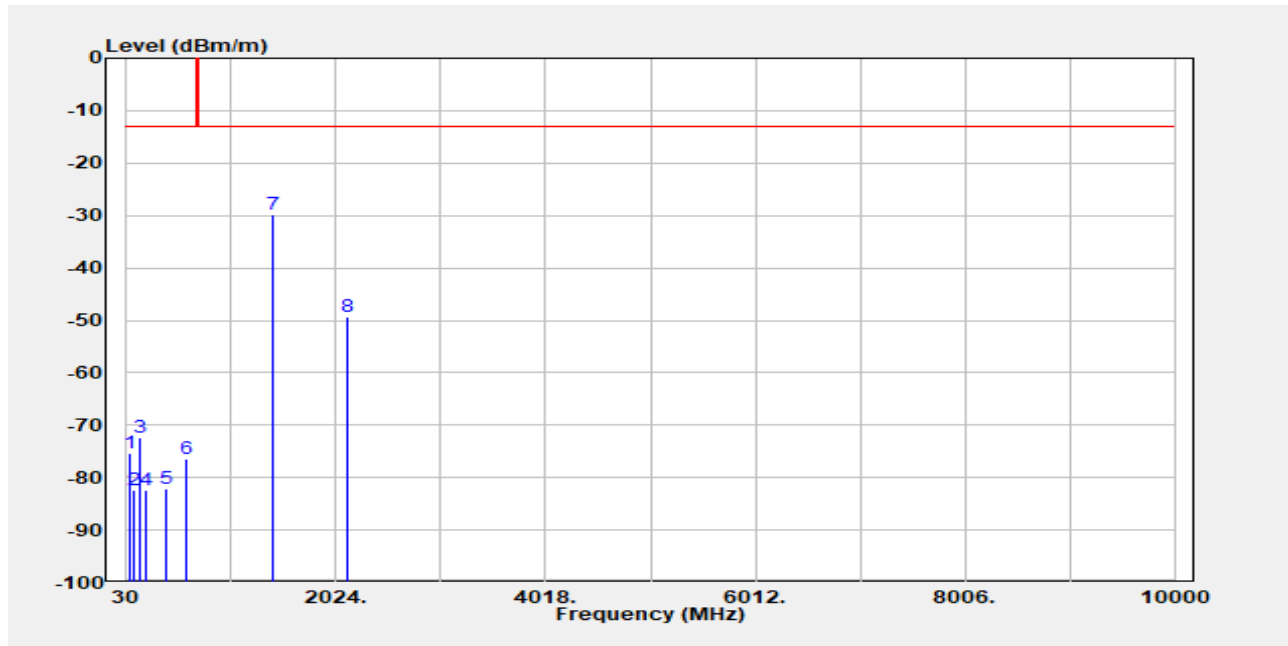

Freq. MHz	EIRP/ERP dBm	SG Output Level dBm	Antenna Gain dBi/dBd	Cable Loss dB	Limit dBm	Margin dB
64.920	-75.46	-67.17	-7.49	-0.80	-13.00	-62.46
94.020	-82.35	-73.59	-7.77	-1.00	-13.00	-69.35
155.130	-72.35	-66.82	-4.31	-1.22	-13.00	-59.35
212.360	-82.28	-79.58	-1.19	-1.50	-13.00	-69.28
399.570	-82.06	-78.29	-1.58	-2.19	-13.00	-69.06
605.210	-76.52	-73.20	-0.69	-2.64	-13.00	-63.52
1415.000	-29.91	-33.87	7.99	-4.03	-13.00	-16.91
2122.500	-49.28	-54.02	9.67	-4.93	-13.00	-36.28

Unless otherwise stated the results shown in this test report refer only to the sample(s) tested and such sample(s) are retained for 90 days only.

除非另有說明，此報告結果僅對測試之樣品負責，同時此樣品僅保留90天。本報告未經本公司書面許可，不可部份複製。

This document is issued by the Company subject to its General Conditions of Service printed overleaf, available on request or accessible at <http://www.sgs.com.tw/Terms-and-Conditions> and for electronic format documents, subject to Terms and Conditions for Electronic Documents at <http://www.sgs.com.tw/Terms-and-Conditions>. Attention is drawn to the limitation of liability, indemnification and jurisdiction issues defined therein. Any holder of this document is advised that information contained hereon reflects the Company's findings at the time of its intervention only and within the limits of Client's instructions, if any. The Company's sole responsibility is to its Client and this document does not exonerate parties to a transaction from exercising all their rights and obligations under the transaction documents. This document cannot be reproduced except in full, without prior written approval of the Company. Any unauthorized alteration, forgery or falsification of the content or appearance of this document is unlawful and offenders may be prosecuted to the fullest extent of the law.

Report Number :TERF2209001659ER
 Operation Mode :CAT-M1 B12
 Test Mode :Tx
 EUT Pol :H Plane
 Test Frequency :714.5 MHz

Test Site :SAC 3
 Test Date :2022-09-19
 Temp./Humi. :24.6/67
 Antenna Pol. :Vertical
 Engineer :Nick Lin

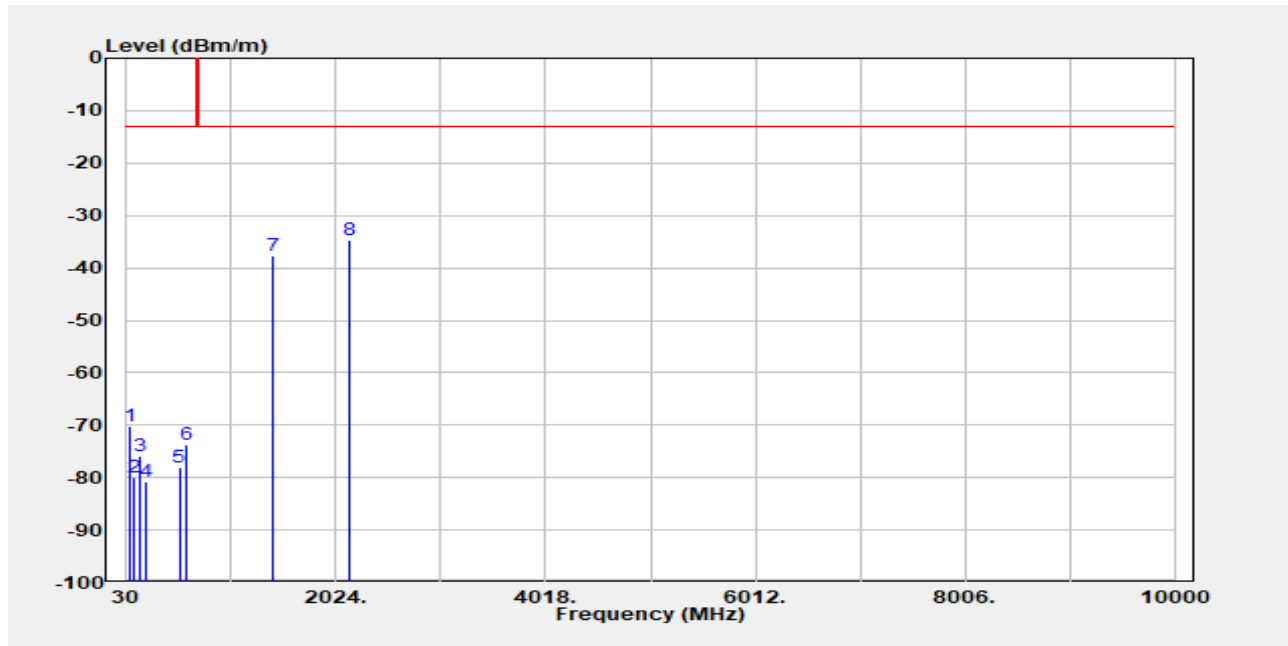

Freq. MHz	EIRP/ERP dBm	SG Output Level dBm	Antenna Gain dBi/dBd	Cable Loss dB	Limit dBm	Margin dB
64.920	-70.26	-61.97	-7.49	-0.80	-13.00	-57.26
103.720	-80.07	-70.75	-8.28	-1.04	-13.00	-67.07
156.100	-76.00	-70.53	-4.24	-1.23	-13.00	-63.00
211.390	-80.64	-77.87	-1.27	-1.50	-13.00	-67.64
530.520	-78.08	-75.15	-0.85	-2.08	-13.00	-65.08
605.210	-73.65	-70.33	-0.69	-2.64	-13.00	-60.65
1429.000	-37.69	-41.71	8.08	-4.05	-13.00	-24.69
2143.500	-34.58	-39.08	9.46	-4.97	-13.00	-21.58

Unless otherwise stated the results shown in this test report refer only to the sample(s) tested and such sample(s) are retained for 90 days only.

除非另有說明，此報告結果僅對測試之樣品負責，同時此樣品僅保留90天。本報告未經本公司書面許可，不可部份複製。

This document is issued by the Company subject to its General Conditions of Service printed overleaf, available on request or accessible at <http://www.sgs.com.tw/Terms-and-Conditions> and for electronic format documents, subject to Terms and Conditions for Electronic Documents at <http://www.sgs.com.tw/Terms-and-Conditions>. Attention is drawn to the limitation of liability, indemnification and jurisdiction issues defined therein. Any holder of this document is advised that information contained hereon reflects the Company's findings at the time of its intervention only and within the limits of Client's instructions, if any. The Company's sole responsibility is to its Client and this document does not exonerate parties to a transaction from exercising all their rights and obligations under the transaction documents. This document cannot be reproduced except in full, without prior written approval of the Company. Any unauthorized alteration, forgery or falsification of the content or appearance of this document is unlawful and offenders may be prosecuted to the fullest extent of the law.

Report Number :TERF2209001659ER
 Operation Mode :CAT-M1 B12
 Test Mode :Tx
 EUT Pol :H Plane
 Test Frequency :714.5 MHz

Test Site :SAC 3
 Test Date :2022-09-19
 Temp./Humi. :24.6/67
 Antenna Pol. :Horizontal
 Engineer :Nick Lin

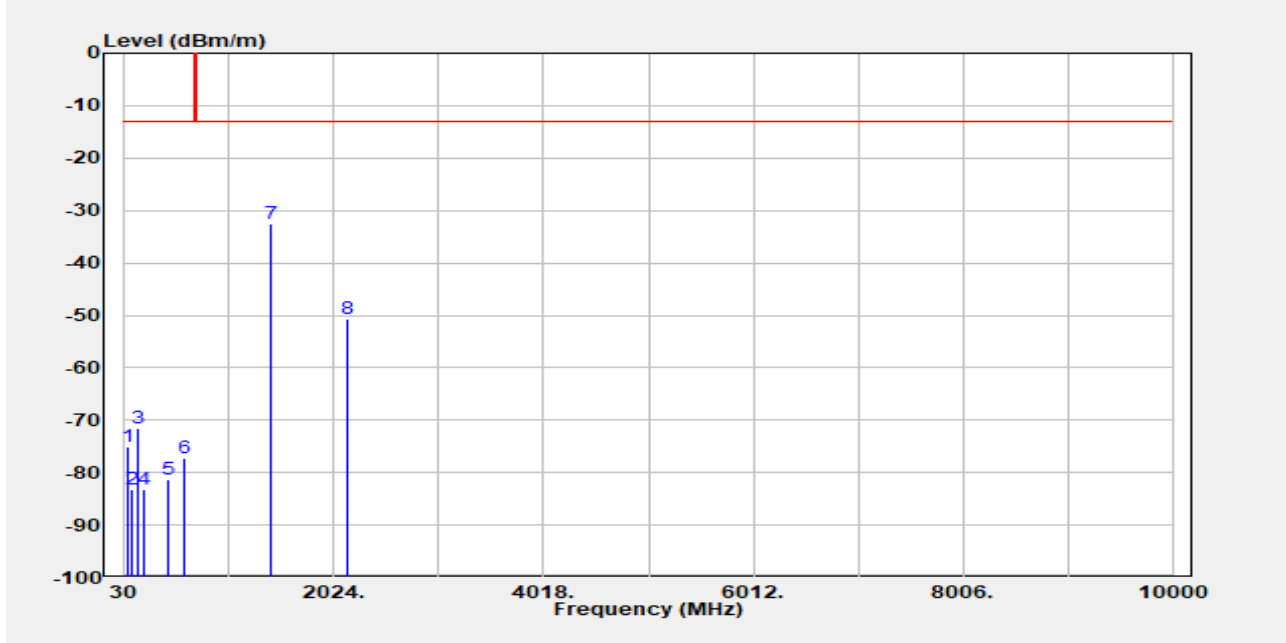

Freq. MHz	EIRP/ERP dBm	SG Output Level dBm	Antenna Gain dBi/dBd	Cable Loss dB	Limit dBm	Margin dB
63.950	-75.20	-66.70	-7.71	-0.79	-13.00	-62.20
92.080	-83.28	-74.83	-7.47	-0.99	-13.00	-70.28
156.100	-71.55	-66.09	-4.24	-1.23	-13.00	-58.55
207.510	-83.28	-80.30	-1.49	-1.49	-13.00	-70.28
449.040	-81.20	-77.87	-1.10	-2.24	-13.00	-68.20
605.210	-77.16	-73.84	-0.69	-2.64	-13.00	-64.16
1429.000	-32.40	-36.42	8.08	-4.05	-13.00	-19.40
2143.500	-50.78	-55.28	9.46	-4.97	-13.00	-37.78

Unless otherwise stated the results shown in this test report refer only to the sample(s) tested and such sample(s) are retained for 90 days only.

除非另有說明，此報告結果僅對測試之樣品負責，同時此樣品僅保留90天。本報告未經本公司書面許可，不可部份複製。

This document is issued by the Company subject to its General Conditions of Service printed overleaf, available on request or accessible at <http://www.sgs.com.tw/Terms-and-Conditions> and for electronic format documents, subject to Terms and Conditions for Electronic Documents at <http://www.sgs.com.tw/Terms-and-Conditions>. Attention is drawn to the limitation of liability, indemnification and jurisdiction issues defined therein. Any holder of this document is advised that information contained hereon reflects the Company's findings at the time of its intervention only and within the limits of Client's instructions, if any. The Company's sole responsibility is to its Client and this document does not exonerate parties to a transaction from exercising all their rights and obligations under the transaction documents. This document cannot be reproduced except in full, without prior written approval of the Company. Any unauthorized alteration, forgery or falsification of the content or appearance of this document is unlawful and offenders may be prosecuted to the fullest extent of the law.

11 FREQUENCY STABILITY MEASUREMENT

11.1 Standard Applicable

The frequency stability shall be sufficient to ensure that the fundamental emission stays within the authorized frequency block.

11.2 Test Set-up

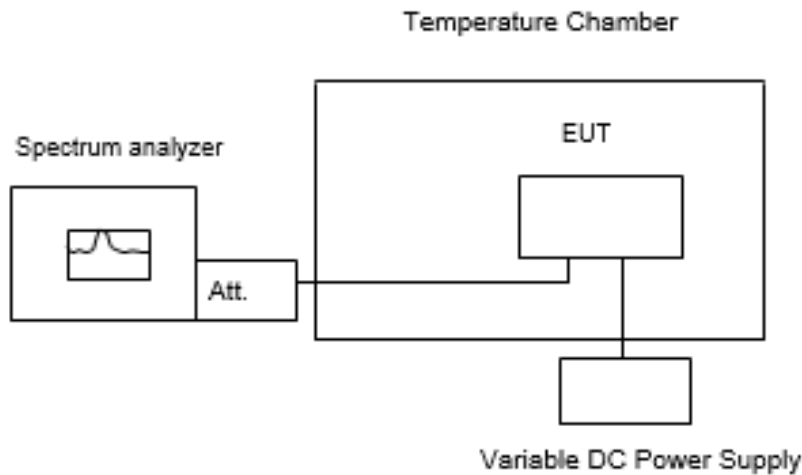

Note: Measurement setup for testing on Antenna connector

11.3 Measurement Procedure

The equipment under test was connected to an external AC or DC power supply and input rated voltage. RF output was connected to a frequency counter or spectrum analyzer via feed through attenuators. The EUT was placed inside the temperature chamber. Set the spectrum analyzer RBW low enough to obtain the desired frequency resolution and measure EUT 25°C operating frequency as reference frequency. Turn EUT off and set the chamber temperature to -30°C. After the temperature stabilized for approximately 30 minutes recorded the frequency. Repeat step measure with 10°C increased per stage until the highest temperature of +50°C reached.

Set chamber temperature to 25°C. Use a variable AC power supply / DC power source to power the EUT and set the voltage to rated voltage. Set the spectrum analyzer RBW low enough to obtain the desired frequency resolution and recorded the frequency. Reduce the input voltage to specify extreme voltage variation (+/- 15%) and endpoint as declared by the manufacturer, record the maximum frequency change.

Unless otherwise stated the results shown in this test report refer only to the sample(s) tested and such sample(s) are retained for 90 days only.

除非另有說明，此報告結果僅對測試之樣品負責，同時此樣品僅保留90天。本報告未經本公司書面許可，不可部份複製。

This document is issued by the Company subject to its General Conditions of Service printed overleaf, available on request or accessible at <http://www.sgs.com.tw/Terms-and-Conditions> and for electronic format documents, subject to Terms and Conditions for Electronic Documents at <http://www.sgs.com.tw/Terms-and-Conditions>. Attention is drawn to the limitation of liability, indemnification and jurisdiction issues defined therein. Any holder of this document is advised that information contained hereon reflects the Company's findings at the time of its intervention only and within the limits of Client's instructions, if any. The Company's sole responsibility is to its Client and this document does not exonerate parties to a transaction from exercising all their rights and obligations under the transaction documents. This document cannot be reproduced except in full, without prior written approval of the Company. Any unauthorized alteration, forgery or falsification of the content or appearance of this document is unlawful and offenders may be prosecuted to the fullest extent of the law.

11.4 Measurement Result

Note: The battery is rated 3.6V dc.

11.4.1 Cat M1

Reference Freq.:		CAT-M1 B2 Mid Channel		1880.0000	MHz 10M QPSK CH 18900
Power Supply Vdc	Temp. (°C)	Freq. (MHz)	(ppm)	Limit	
Freq. ERROR vs. VOLTAGE					
4.14	25	1879.999995	-0.0028	+/- 2.5 ppm	
3.6	25	1880.000004	0.0019		
3.06	25	1879.999998	-0.0012		
2.5 (End Point)	25	1880.000006	0.0031		
Freq. ERROR vs. Temp.					
3.6	-30	1880.000008	0.0041	+/- 2.5 ppm	
3.6	-20	1879.999991	-0.0046		
3.6	-10	1880.000002	0.0009		
3.6	0	1879.999992	-0.0042		
3.6	10	1879.999990	-0.0051		
3.6	20	1880.000005	0.0028		
3.6	30	1879.999996	-0.0022		
3.6	40	1879.999995	-0.0024		
3.6	50	1880.000001	0.0006		

Unless otherwise stated the results shown in this test report refer only to the sample(s) tested and such sample(s) are retained for 90 days only.

除非另有說明，此報告結果僅對測試之樣品負責，同時此樣品僅保留90天。本報告未經本公司書面許可，不可部份複製。
This document is issued by the Company subject to its General Conditions of Service printed overleaf, available on request or accessible at <http://www.sgs.com.tw/Terms-and-Conditions> and for electronic format documents, subject to Terms and Conditions for Electronic Documents at <http://www.sgs.com.tw/Terms-and-Conditions>. Attention is drawn to the limitation of liability, indemnification and jurisdiction issues defined therein. Any holder of this document is advised that information contained hereon reflects the Company's findings at the time of its intervention only and within the limits of Client's instructions, if any. The Company's sole responsibility is to its Client and this document does not exonerate parties to a transaction from exercising all their rights and obligations under the transaction documents. This document cannot be reproduced except in full, without prior written approval of the Company. Any unauthorized alteration, forgery or falsification of the content or appearance of this document is unlawful and offenders may be prosecuted to the fullest extent of the law.

Reference Freq.:		CAT-M1 B4 Mid Channel		1732.5000	MHz 10M QPSK CH 20175
Power Supply Vdc	Temp. (°C)	Freq. (MHz)	(ppm)	Limit	
Freq. ERROR vs. VOLTAGE					
4.14	25	1732.500007	0.0038	+/- 2.5 ppm	
3.6	25	1732.499996	-0.0023		
3.06	25	1732.499991	-0.0054		
2.5 (End Point)	25	1732.499995	-0.0027		
Freq. ERROR vs. Temp.					
3.6	-30	1732.499993	-0.0040	+/- 2.5 ppm	
3.6	-20	1732.500001	0.0007		
3.6	-10	1732.499993	-0.0040		
3.6	0	1732.499990	-0.0056		
3.6	10	1732.499998	-0.0012		
3.6	20	1732.500004	0.0025		
3.6	30	1732.499992	-0.0046		
3.6	40	1732.499996	-0.0023		
3.6	50	1732.499993	-0.0039		
Reference Freq.:		CAT-M1 B5 Mid Channel		836.5000	MHz 10M QPSK CH 20525
Power Supply Vdc	Temp. (°C)	Freq. (MHz)	(ppm)	Limit	
Freq. ERROR vs. VOLTAGE					
4.14	25	836.500009	0.0103	+/- 2.5 ppm	
3.6	25	836.499995	-0.0065		
3.06	25	836.500003	0.0039		
2.5 (End Point)	25	836.499992	-0.0097		
Freq. ERROR vs. Temp.					
3.6	-30	836.500002	0.0029	+/- 2.5 ppm	
3.6	-20	836.500002	0.0028		
3.6	-10	836.499990	-0.0116		
3.6	0	836.499993	-0.0081		
3.6	10	836.499996	-0.0049		
3.6	20	836.499998	-0.0022		
3.6	30	836.499992	-0.0095		
3.6	40	836.500010	0.0119		
3.6	50	836.500004	0.0049		

Unless otherwise stated the results shown in this test report refer only to the sample(s) tested and such sample(s) are retained for 90 days only.

除非另有說明，此報告結果僅對測試之樣品負責，同時此樣品僅保留90天。本報告未經本公司書面許可，不可部份複製。

This document is issued by the Company subject to its General Conditions of Service printed overleaf, available on request or accessible at <http://www.sgs.com.tw/Terms-and-Conditions> and for electronic format documents, subject to Terms and Conditions for Electronic Documents at <http://www.sgs.com.tw/Terms-and-Conditions>. Attention is drawn to the limitation of liability, indemnification and jurisdiction issues defined therein. Any holder of this document is advised that information contained hereon reflects the Company's findings at the time of its intervention only and within the limits of Client's instructions, if any. The Company's sole responsibility is to its Client and this document does not exonerate parties to a transaction from exercising all their rights and obligations under the transaction documents. This document cannot be reproduced except in full, without prior written approval of the Company. Any unauthorized alteration, forgery or falsification of the content or appearance of this document is unlawful and offenders may be prosecuted to the fullest extent of the law.

Reference Freq.:		CAT-M1 B12 Mid Channel		707.5000	MHz 10M QPSK CH 23095
Power Supply Vdc	Temp. (°C)	Freq. (MHz)	(ppm)	Limit	
Freq. ERROR vs. VOLTAGE					
4.14	25	707.499996	-0.0057	+/- 2.5 ppm	
3.6	25	707.499999	-0.0007		
3.06	25	707.500008	0.0109		
2.5 (End Point)	25	707.499990	-0.0139		
Freq. ERROR vs. Temp.					
3.6	-30	707.499999	-0.0009	+/- 2.5 ppm	
3.6	-20	707.499995	-0.0077		
3.6	-10	707.500006	0.0082		
3.6	0	707.500003	0.0036		
3.6	10	707.499990	-0.0141		
3.6	20	707.500003	0.0041		
3.6	30	707.499997	-0.0037		
3.6	40	707.500004	0.0059		
3.6	50	707.499993	-0.0100		

Unless otherwise stated the results shown in this test report refer only to the sample(s) tested and such sample(s) are retained for 90 days only.

除非另有說明，此報告結果僅對測試之樣品負責，同時此樣品僅保留90天。本報告未經本公司書面許可，不可部份複製。

This document is issued by the Company subject to its General Conditions of Service printed overleaf, available on request or accessible at <http://www.sgs.com.tw/Terms-and-Conditions> and for electronic format documents, subject to Terms and Conditions for Electronic Documents at <http://www.sgs.com.tw/Terms-and-Conditions>. Attention is drawn to the limitation of liability, indemnification and jurisdiction issues defined therein. Any holder of this document is advised that information contained hereon reflects the Company's findings at the time of its intervention only and within the limits of Client's instructions, if any. The Company's sole responsibility is to its Client and this document does not exonerate parties to a transaction from exercising all their rights and obligations under the transaction documents. This document cannot be reproduced except in full, without prior written approval of the Company. Any unauthorized alteration, forgery or falsification of the content or appearance of this document is unlawful and offenders may be prosecuted to the fullest extent of the law.

12 PEAK TO AVERAGE RATIO

12.1 Standard Applicable

The peak-to-average ratio (PAR) of the transmission may not exceed 13dB.

12.2 Test SET-UP

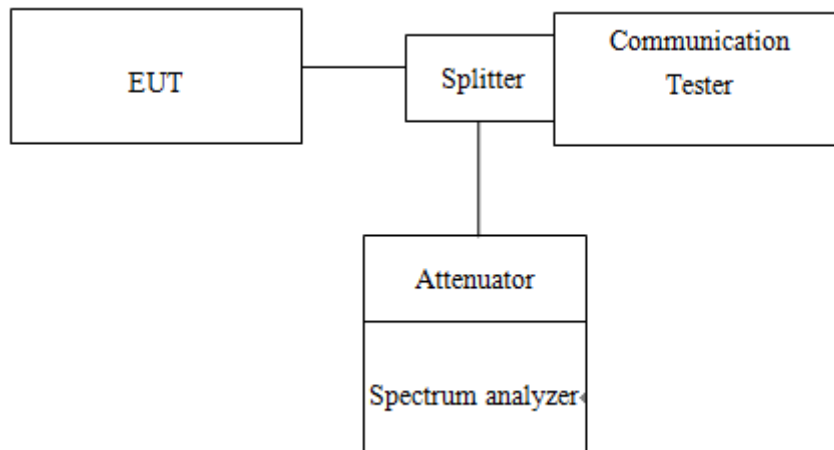

12.3 Measurement Procedure

1. KDB 971168 D01 is employed as the following procedure is proper adjusted accordingly:
2. Set resolution/measurement bandwidth \geq signal's occupied bandwidth; & internal =1ms
3. Set the number of counts to a value that stabilizes the measured CCDF curve.

Unless otherwise stated the results shown in this test report refer only to the sample(s) tested and such sample(s) are retained for 90 days only.
 除非另有說明，此報告結果僅對測試之樣品負責，同時此樣品僅保留90天。本報告未經本公司書面許可，不可部份複製。

This document is issued by the Company subject to its General Conditions of Service printed overleaf, available on request or accessible at <http://www.sgs.com.tw/Terms-and-Conditions> and for electronic format documents, subject to Terms and Conditions for Electronic Documents at <http://www.sgs.com.tw/Terms-and-Conditions>. Attention is drawn to the limitation of liability, indemnification and jurisdiction issues defined therein. Any holder of this document is advised that information contained hereon reflects the Company's findings at the time of its intervention only and within the limits of Client's instructions, if any. The Company's sole responsibility is to its Client and this document does not exonerate parties to a transaction from exercising all their rights and obligations under the transaction documents. This document cannot be reproduced except in full, without prior written approval of the Company. Any unauthorized alteration, forgery or falsification of the content or appearance of this document is unlawful and offenders may be prosecuted to the fullest extent of the law.

12.4 Measurement Result

12.4.1 Cat M1

CAT-M1 BAND 2							
Channel bandwidth: 1.4MHz				Channel bandwidth: 3MHz			
Freq. (MHz)	CH	PAPR (dB)		Freq. (MHz)	CH	PAPR (dB)	
		16QAM	Limit			16QAM	Limit
1850.7	18607	6.32	13	1851.5	18615	6.29	13
1880.0	18900	8.00	13	1880.0	18900	5.08	13
1909.3	19193	7.25	13	1908.5	19185	6.74	13

CAT-M1 BAND 2							
Channel bandwidth: 5MHz				Channel bandwidth: 10MHz			
Freq. (MHz)	CH	PAPR (dB)		Freq. (MHz)	CH	PAPR (dB)	
		16QAM	Limit			16QAM	Limit
1852.5	18625	7.11	13	1855.0	18650	6.10	13
1880.0	18900	6.55	13	1880.0	18900	6.39	13
1907.5	19175	10.04	13	1905.0	19150	6.58	13

CAT-M1 BAND 2							
Channel bandwidth: 15MHz				Channel bandwidth: 20MHz			
Freq. (MHz)	CH	PAPR (dB)		Freq. (MHz)	CH	PAPR (dB)	
		16QAM	Limit			16QAM	Limit
1857.5	18675	5.86	13	1860.0	18700	5.79	13
1880.0	18900	6.03	13	1880.0	18900	5.97	13
1902.5	19125	6.10	13	1900.0	19100	6.05	13

Unless otherwise stated the results shown in this test report refer only to the sample(s) tested and such sample(s) are retained for 90 days only.

除非另有說明，此報告結果僅對測試之樣品負責，同時此樣品僅保留90天。本報告未經本公司書面許可，不可部份複製。

This document is issued by the Company subject to its General Conditions of Service printed overleaf, available on request or accessible at <http://www.sgs.com.tw/Terms-and-Conditions> and for electronic format documents, subject to Terms and Conditions for Electronic Documents at <http://www.sgs.com.tw/Terms-and-Conditions>. Attention is drawn to the limitation of liability, indemnification and jurisdiction issues defined therein. Any holder of this document is advised that information contained hereon reflects the Company's findings at the time of its intervention only and within the limits of Client's instructions, if any. The Company's sole responsibility is to its Client and this document does not exonerate parties to a transaction from exercising all their rights and obligations under the transaction documents. This document cannot be reproduced except in full, without prior written approval of the Company. Any unauthorized alteration, forgery or falsification of the content or appearance of this document is unlawful and offenders may be prosecuted to the fullest extent of the law.

CAT-M1 BAND 4							
Channel bandwidth: 1.4MHz				Channel bandwidth: 3MHz			
Freq. (MHz)	CH	PAPR (dB)		Freq. (MHz)	CH	PAPR (dB)	
		16QAM	Limit			16QAM	Limit
1710.7	19957	6.39	13	1711.5	19965	6.13	13
1732.5	20175	6.32	13	1732.5	20175	6.09	13
1754.3	20393	6.97	13	1753.5	20385	6.82	13

CAT-M1 BAND 4							
Channel bandwidth: 5MHz				Channel bandwidth: 10MHz			
Freq. (MHz)	CH	PAPR (dB)		Freq. (MHz)	CH	PAPR (dB)	
		16QAM	Limit			16QAM	Limit
1712.5	19975	5.94	13	1715.0	20000	6.04	13
1732.5	20175	5.93	13	1732.5	20175	6.00	13
1752.5	20375	7.52	13	1750.0	20350	6.25	13

CAT-M1 BAND 4							
Channel bandwidth: 15MHz				Channel bandwidth: 20MHz			
Freq. (MHz)	CH	PAPR (dB)		Freq. (MHz)	CH	PAPR (dB)	
		16QAM	Limit			16QAM	Limit
1717.5	20025	7.56	13	1720.0	20050	5.72	13
1732.5	20175	7.47	13	1732.5	20175	5.67	13
1747.5	20325	7.52	13	1745.0	20300	5.66	13

CAT-M1 BAND 5							
Channel bandwidth: 1.4MHz				Channel bandwidth: 3MHz			
Freq. (MHz)	CH	PAPR (dB)		Freq. (MHz)	CH	PAPR (dB)	
		16QAM	Limit			16QAM	Limit
824.7	20407	6.15	13	825.5	20415	5.95	13
836.5	20525	6.20	13	836.5	20525	6.06	13
848.3	20643	6.31	13	847.5	20635	6.14	13

CAT-M1 BAND 5							
Channel bandwidth: 5MHz				Channel bandwidth: 10MHz			
Freq. (MHz)	CH	PAPR (dB)		Freq. (MHz)	CH	PAPR (dB)	
		16QAM	Limit			16QAM	Limit
826.5	20425	5.96	13	829.0	20450	5.85	13
836.5	20525	6.06	13	836.5	20525	5.91	13
846.5	20625	7.83	13	844.0	20600	5.99	13

Unless otherwise stated the results shown in this test report refer only to the sample(s) tested and such sample(s) are retained for 90 days only.

除非另有說明，此報告結果僅對測試之樣品負責，同時此樣品僅保留90天。本報告未經本公司書面許可，不可部份複製。

This document is issued by the Company subject to its General Conditions of Service printed overleaf, available on request or accessible at <http://www.sgs.com.tw/Terms-and-Conditions> and for electronic format documents, subject to Terms and Conditions for Electronic Documents at <http://www.sgs.com.tw/Terms-and-Conditions>. Attention is drawn to the limitation of liability, indemnification and jurisdiction issues defined therein. Any holder of this document is advised that information contained hereon reflects the Company's findings at the time of its intervention only and within the limits of Client's instructions, if any. The Company's sole responsibility is to its Client and this document does not exonerate parties to a transaction from exercising all their rights and obligations under the transaction documents. This document cannot be reproduced except in full, without prior written approval of the Company. Any unauthorized alteration, forgery or falsification of the content or appearance of this document is unlawful and offenders may be prosecuted to the fullest extent of the law.

CAT-M1 BAND 12							
Channel bandwidth: 1.4MHz				Channel bandwidth: 3MHz			
Freq. (MHz)	CH	PAPR (dB)		Freq. (MHz)	CH	PAPR (dB)	
		16QAM	Limit			16QAM	Limit
699.7	23017	6.79	13	700.5	23025	6.09	13
707.5	23095	7.16	13	707.5	23095	6.74	13
715.3	23173	6.83	13	714.5	23165	7.40	13

CAT-M1 BAND 12							
Channel bandwidth: 5MHz				Channel bandwidth: 10MHz			
Freq. (MHz)	CH	PAPR (dB)		Freq. (MHz)	CH	PAPR (dB)	
		16QAM	Limit			16QAM	Limit
701.5	23035	7.36	13	704.0	23060	5.89	13
707.5	23095	7.56	13	707.5	23095	5.87	13
713.5	23155	6.01	13	711.0	23130	5.84	13

Please refer to next page for test plots.

Unless otherwise stated the results shown in this test report refer only to the sample(s) tested and such sample(s) are retained for 90 days only.

除非另有說明，此報告結果僅對測試之樣品負責，同時此樣品僅保留90天。本報告未經本公司書面許可，不可部份複製。

This document is issued by the Company subject to its General Conditions of Service printed overleaf, available on request or accessible at <http://www.sgs.com.tw/Terms-and-Conditions> and for electronic format documents, subject to Terms and Conditions for Electronic Documents at <http://www.sgs.com.tw/Terms-and-Conditions>. Attention is drawn to the limitation of liability, indemnification and jurisdiction issues defined therein. Any holder of this document is advised that information contained hereon reflects the Company's findings at the time of its intervention only and within the limits of Client's instructions, if any. The Company's sole responsibility is to its Client and this document does not exonerate parties to a transaction from exercising all their rights and obligations under the transaction documents. This document cannot be reproduced except in full, without prior written approval of the Company. Any unauthorized alteration, forgery or falsification of the content or appearance of this document is unlawful and offenders may be prosecuted to the fullest extent of the law.

Band12_1.4MHz_16QAM_RB6_0_CH23017

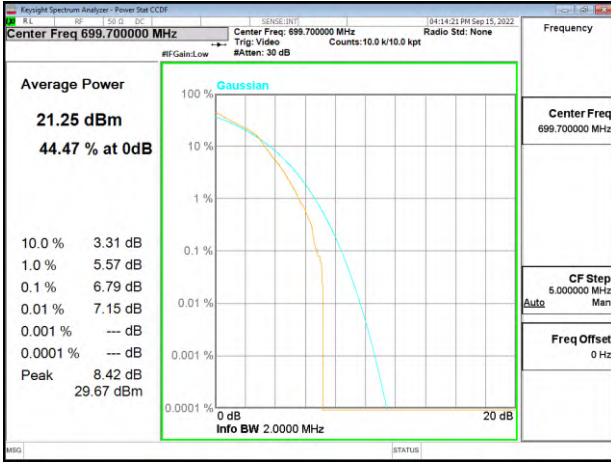

Band12_10MHz_16QAM_RB6_0_CH23060

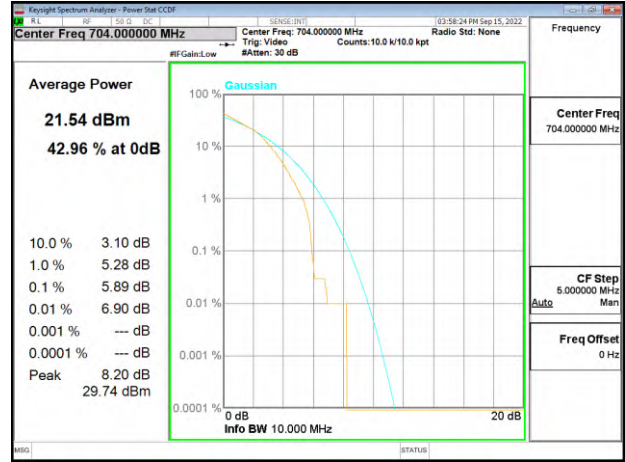

Band12_1.4MHz_16QAM_RB6_0_CH23095

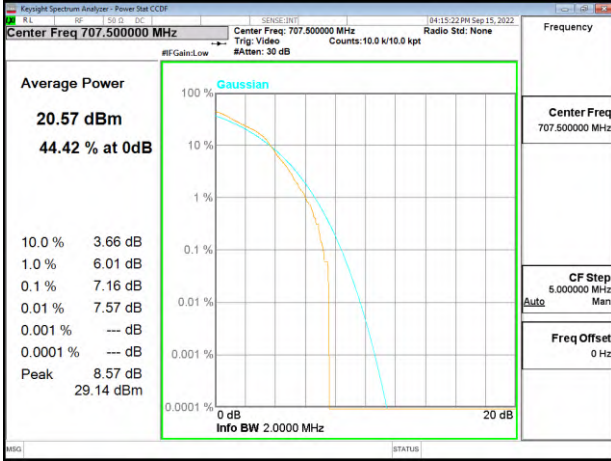

Band12_10MHz_16QAM_RB6_0_CH23095

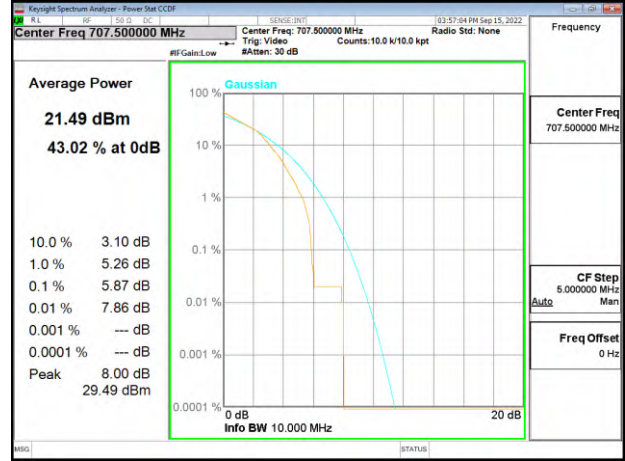

Band12_1.4MHz_16QAM_RB6_0_CH23173

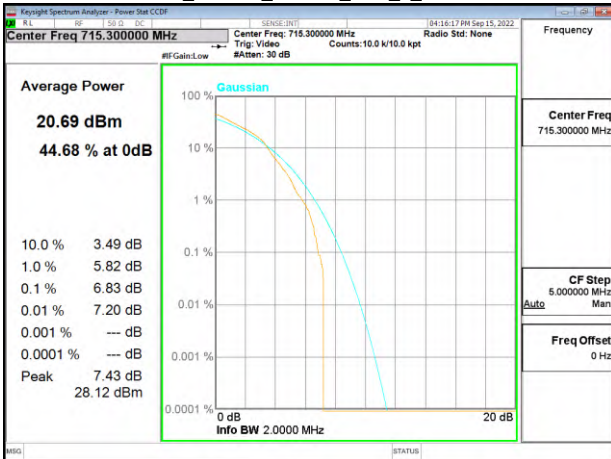

Band12_10MHz_16QAM_RB6_0_CH23130

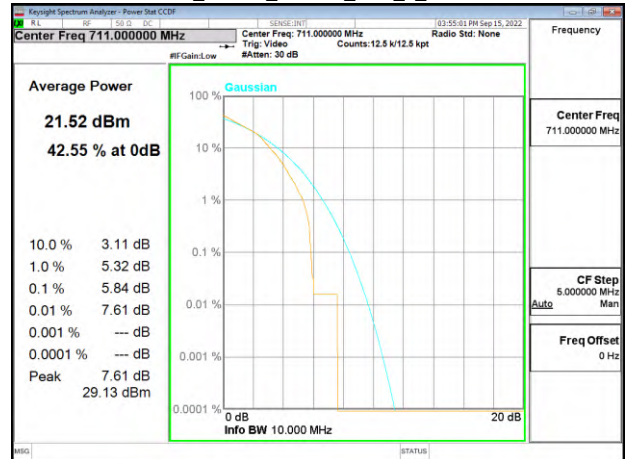

Unless otherwise stated the results shown in this test report refer only to the sample(s) tested and such sample(s) are retained for 90 days only.

除非另有說明，此報告結果僅對測試之樣品負責，同時此樣品僅保留90天。本報告未經本公司書面許可，不可部份複製。

This document is issued by the Company subject to its General Conditions of Service printed overleaf, available on request or accessible at <http://www.sgs.com.tw/Terms-and-Conditions> and for electronic format documents, subject to Terms and Conditions for Electronic Documents at <http://www.sgs.com.tw/Terms-and-Conditions>. Attention is drawn to the limitation of liability, indemnification and jurisdiction issues defined therein. Any holder of this document is advised that information contained hereon reflects the Company's findings at the time of its intervention only and within the limits of Client's instructions, if any. The Company's sole responsibility is to its Client and this document does not exonerate parties to a transaction from exercising all their rights and obligations under the transaction documents. This document cannot be reproduced except in full, without prior written approval of the Company. Any unauthorized alteration, forgery or falsification of the content or appearance of this document is unlawful and offenders may be prosecuted to the fullest extent of the law.

Band12_3MHz_16QAM_RB6_0_CH23025

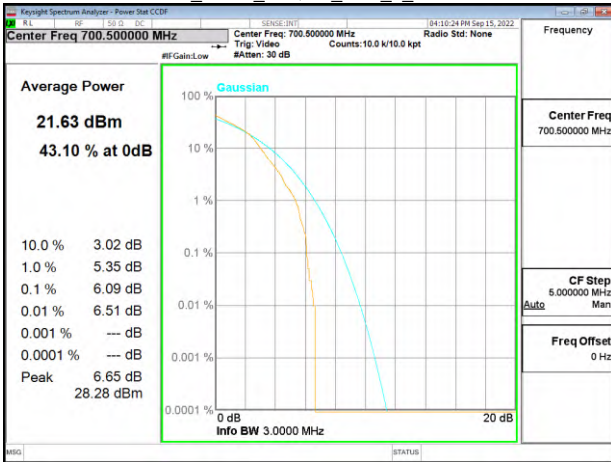

Band12_5MHz_16QAM_RB6_0_CH23035

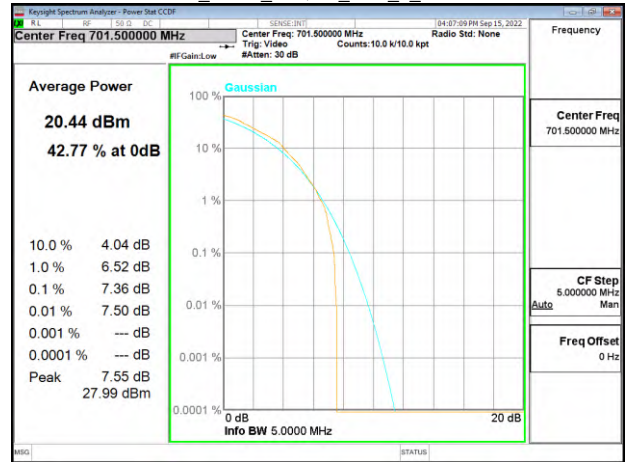

Band12_3MHz_16QAM_RB6_0_CH23095

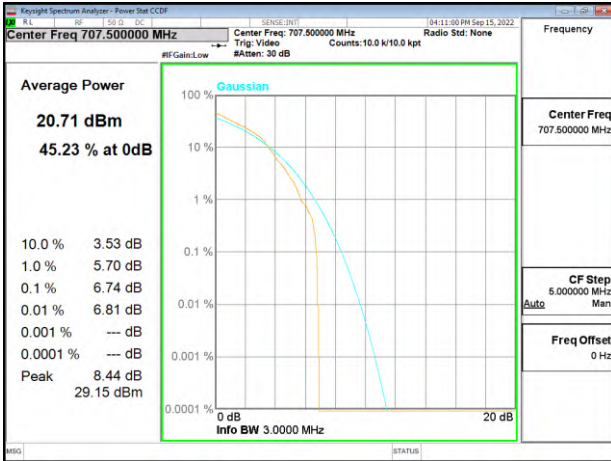

Band12_5MHz_16QAM_RB6_0_CH23095

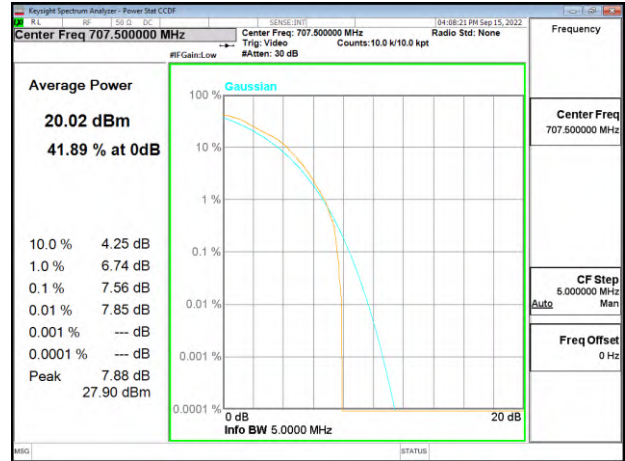

Band12_3MHz_16QAM_RB6_0_CH23165

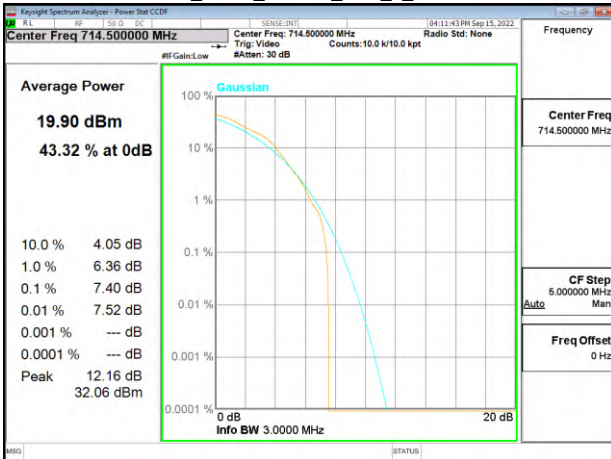

Band12_5MHz_16QAM_RB6_0_CH23155

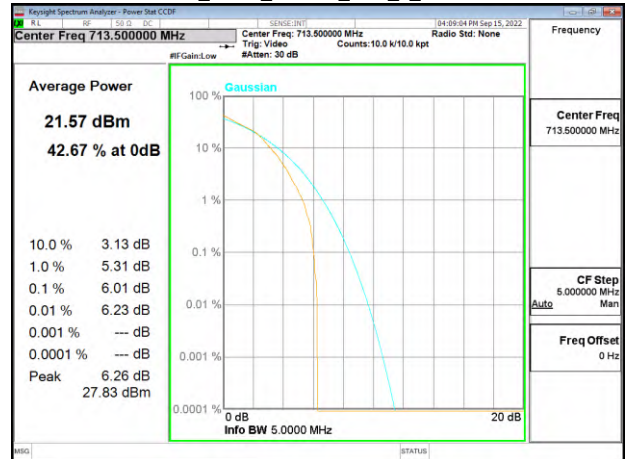

Unless otherwise stated the results shown in this test report refer only to the sample(s) tested and such sample(s) are retained for 90 days only.

除非另有說明，此報告結果僅對測試之樣品負責，同時此樣品僅保留90天。本報告未經本公司書面許可，不可部份複製。

This document is issued by the Company subject to its General Conditions of Service printed overleaf, available on request or accessible at <http://www.sgs.com.tw/Terms-and-Conditions> and for electronic format documents, subject to Terms and Conditions for Electronic Documents at <http://www.sgs.com.tw/Terms-and-Conditions>. Attention is drawn to the limitation of liability, indemnification and jurisdiction issues defined therein. Any holder of this document is advised that information contained hereon reflects the Company's findings at the time of its intervention only and within the limits of Client's instructions, if any. The Company's sole responsibility is to its Client and this document does not exonerate parties to a transaction from exercising all their rights and obligations under the transaction documents. This document cannot be reproduced except in full, without prior written approval of the Company. Any unauthorized alteration, forgery or falsification of the content or appearance of this document is unlawful and offenders may be prosecuted to the fullest extent of the law.

Band2_1.4MHz_16QAM_RB6_0_CH18607

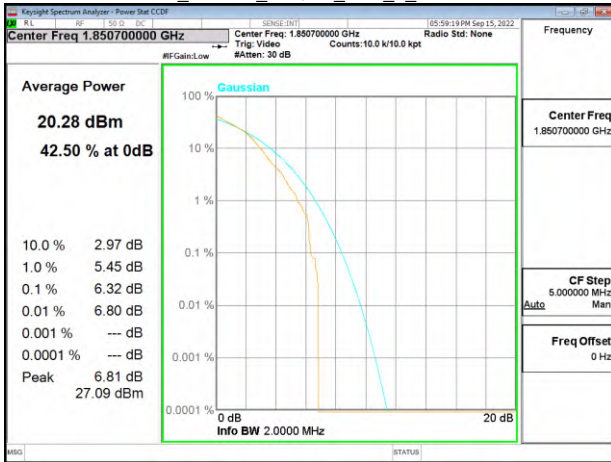

Band2_10MHz_16QAM_RB6_0_CH18650

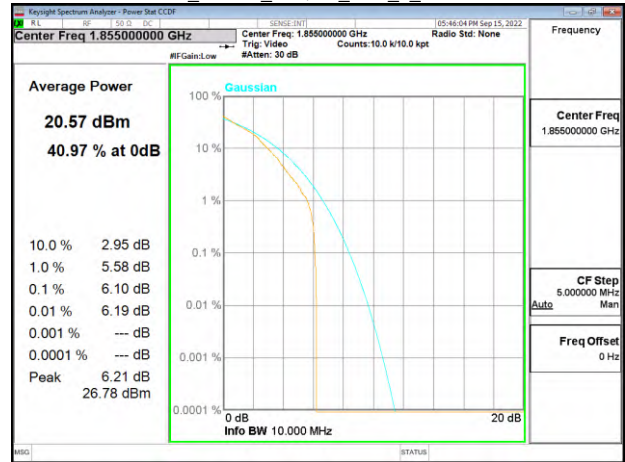

Band2_1.4MHz_16QAM_RB6_0_CH18900

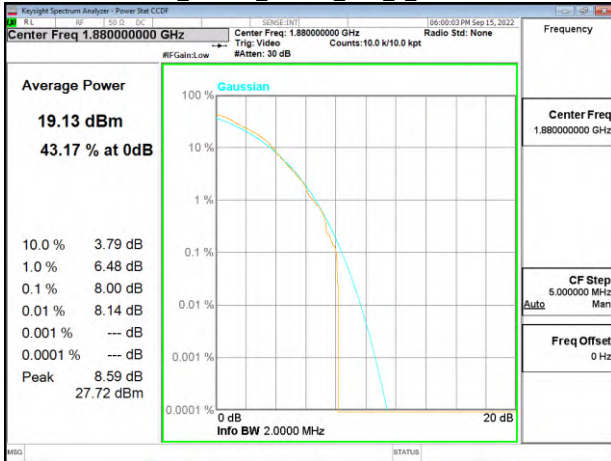

Band2_10MHz_16QAM_RB6_0_CH18900

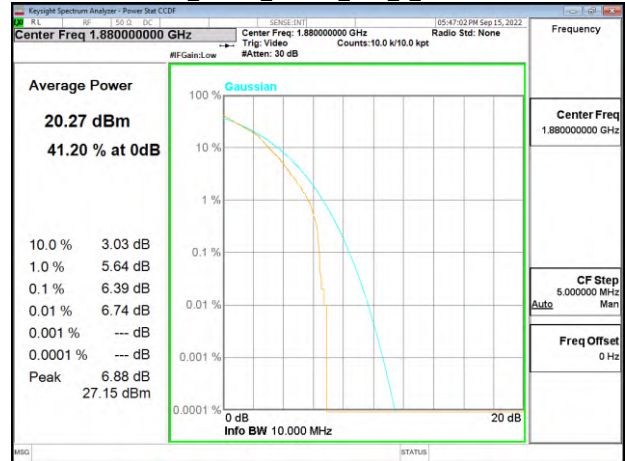

Band2_1.4MHz_16QAM_RB6_0_CH19193

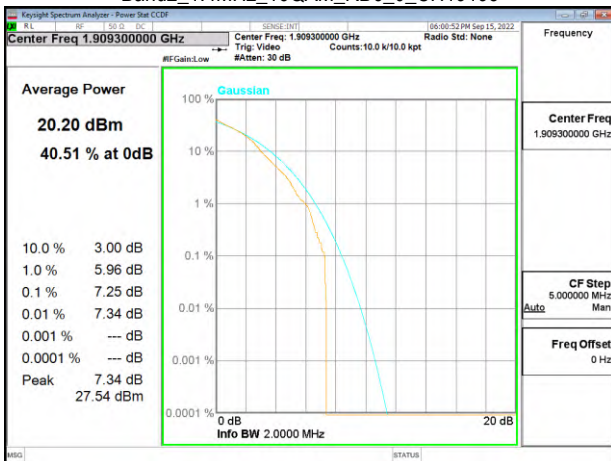

Band2_10MHz_16QAM_RB6_0_CH19150

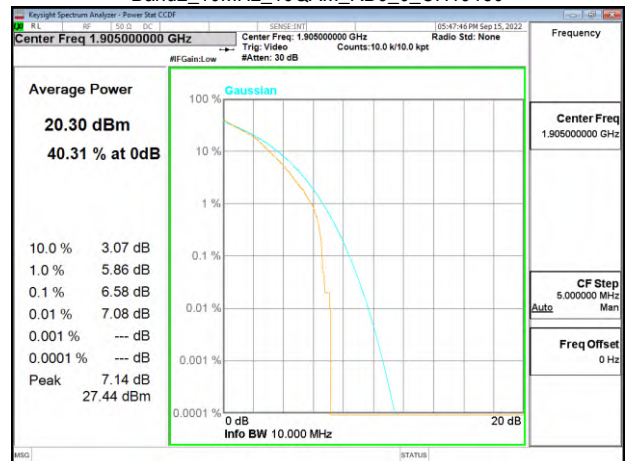

Unless otherwise stated the results shown in this test report refer only to the sample(s) tested and such sample(s) are retained for 90 days only.

除非另有說明，此報告結果僅對測試之樣品負責，同時此樣品僅保留90天。本報告未經本公司書面許可，不可部份複製。

This document is issued by the Company subject to its General Conditions of Service printed overleaf, available on request or accessible at <http://www.sgs.com.tw/Terms-and-Conditions> and for electronic format documents, subject to Terms and Conditions for Electronic Documents at <http://www.sgs.com.tw/Terms-and-Conditions>. Attention is drawn to the limitation of liability, indemnification and jurisdiction issues defined therein. Any holder of this document is advised that information contained hereon reflects the Company's findings at the time of its intervention only and within the limits of Client's instructions, if any. The Company's sole responsibility is to its Client and this document does not exonerate parties to a transaction from exercising all their rights and obligations under the transaction documents. This document cannot be reproduced except in full, without prior written approval of the Company. Any unauthorized alteration, forgery or falsification of the content or appearance of this document is unlawful and offenders may be prosecuted to the fullest extent of the law.

Band2_15MHz_16QAM_RB6_0_CH18675

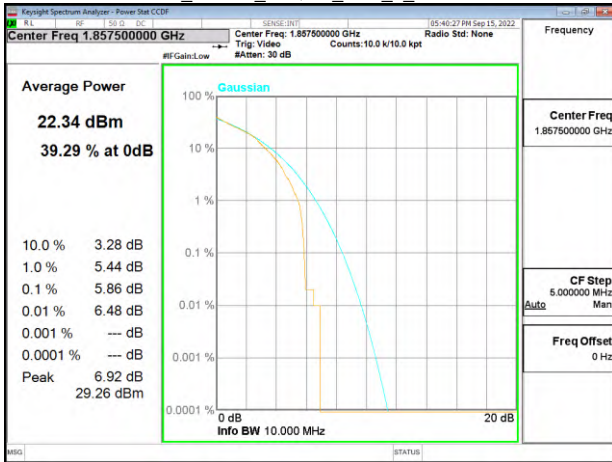

Band2_20MHz_16QAM_RB6_0_CH18700

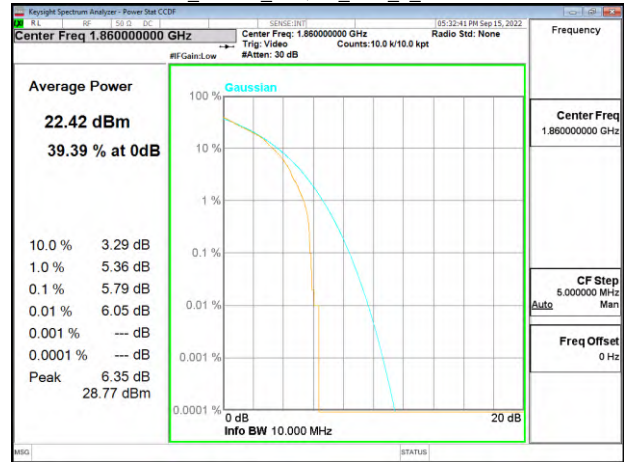

Band2_15MHz_16QAM_RB6_0_CH18900

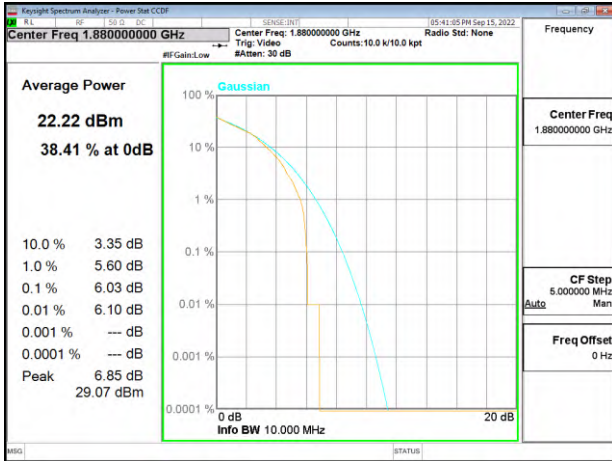

Band2_20MHz_16QAM_RB6_0_CH18900

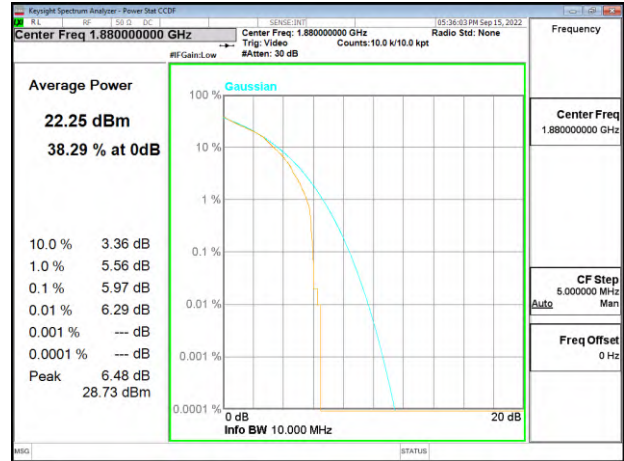

Band2_15MHz_16QAM_RB6_0_CH19125

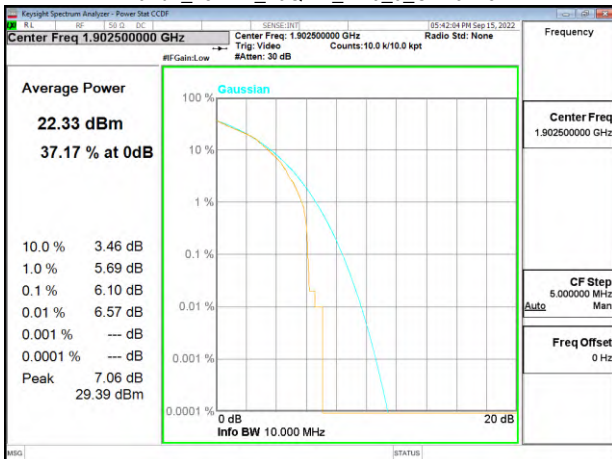

Band2_20MHz_16QAM_RB6_0_CH19100

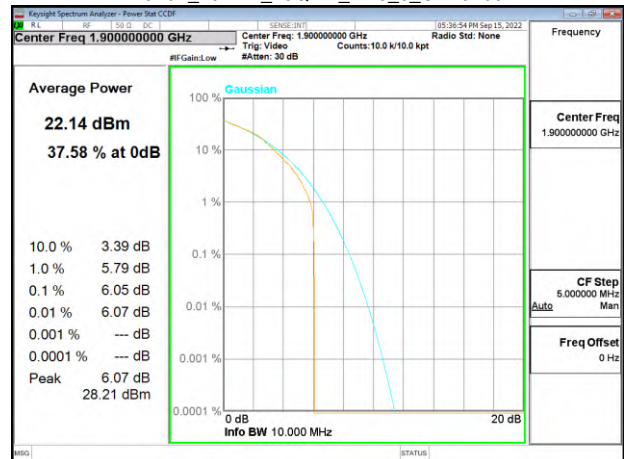

Unless otherwise stated the results shown in this test report refer only to the sample(s) tested and such sample(s) are retained for 90 days only.

除非另有說明，此報告結果僅對測試之樣品負責，同時此樣品僅保留90天。本報告未經本公司書面許可，不可部份複製。

This document is issued by the Company subject to its General Conditions of Service printed overleaf, available on request or accessible at <http://www.sgs.com.tw/Terms-and-Conditions> and for electronic format documents, subject to Terms and Conditions for Electronic Documents at <http://www.sgs.com.tw/Terms-and-Conditions>. Attention is drawn to the limitation of liability, indemnification and jurisdiction issues defined therein. Any holder of this document is advised that information contained hereon reflects the Company's findings at the time of its intervention only and within the limits of Client's instructions, if any. The Company's sole responsibility is to its Client and this document does not exonerate parties to a transaction from exercising all their rights and obligations under the transaction documents. This document cannot be reproduced except in full, without prior written approval of the Company. Any unauthorized alteration, forgery or falsification of the content or appearance of this document is unlawful and offenders may be prosecuted to the fullest extent of the law.

Band2_3MHz_16QAM_RB6_0_CH18615

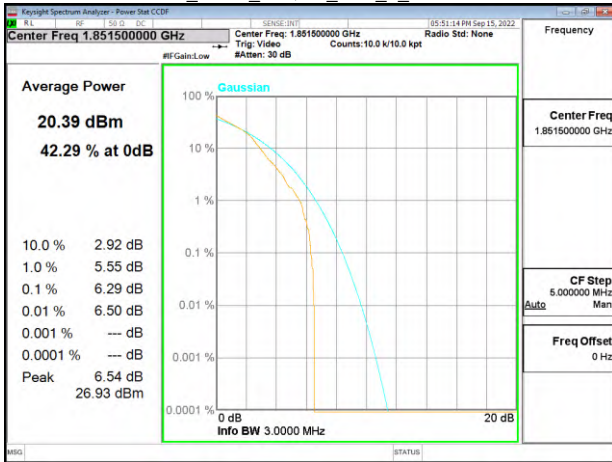

Band2_5MHz_16QAM_RB6_0_CH18625

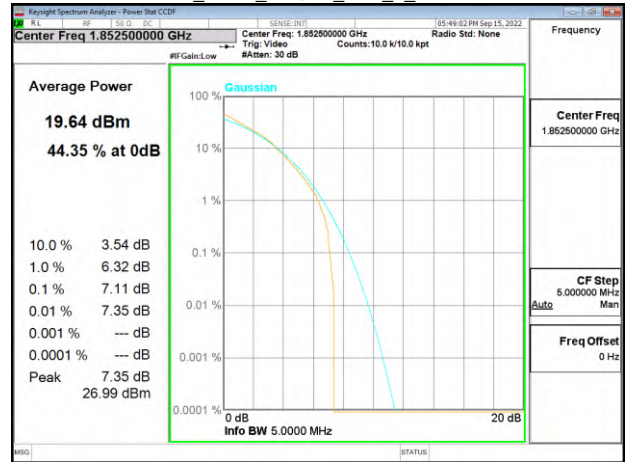

Band2_3MHz_16QAM_RB6_0_CH18900

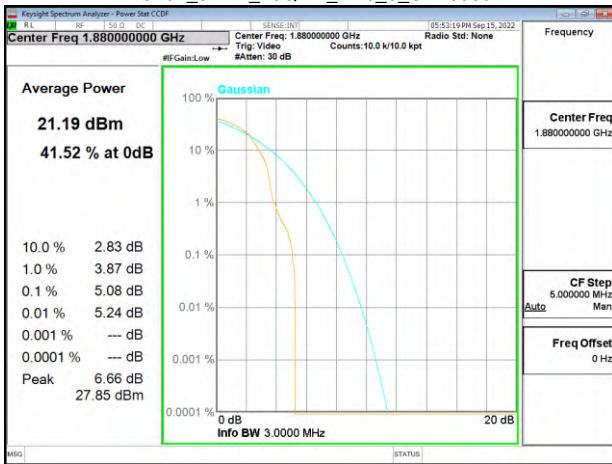

Band2_5MHz_16QAM_RB6_0_CH18900

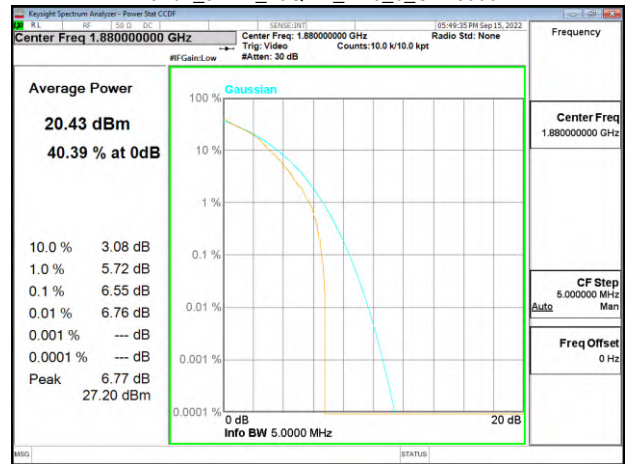

Band2_3MHz_16QAM_RB6_0_CH19185

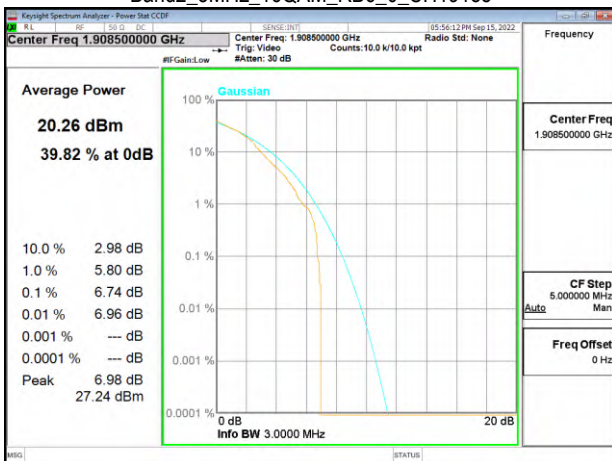

Band2_5MHz_16QAM_RB6_0_CH19175

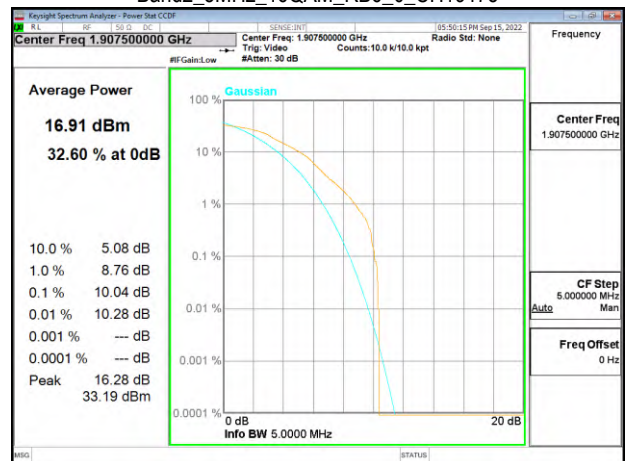

Unless otherwise stated the results shown in this test report refer only to the sample(s) tested and such sample(s) are retained for 90 days only.

除非另有說明，此報告結果僅對測試之樣品負責，同時此樣品僅保留90天。本報告未經本公司書面許可，不可部份複製。

This document is issued by the Company subject to its General Conditions of Service printed overleaf, available on request or accessible at <http://www.sgs.com.tw/Terms-and-Conditions> and for electronic format documents, subject to Terms and Conditions for Electronic Documents at <http://www.sgs.com.tw/Terms-and-Conditions>. Attention is drawn to the limitation of liability, indemnification and jurisdiction issues defined therein. Any holder of this document is advised that information contained hereon reflects the Company's findings at the time of its intervention only and within the limits of Client's instructions, if any. The Company's sole responsibility is to its Client and this document does not exonerate parties to a transaction from exercising all their rights and obligations under the transaction documents. This document cannot be reproduced except in full, without prior written approval of the Company. Any unauthorized alteration, forgery or falsification of the content or appearance of this document is unlawful and offenders may be prosecuted to the fullest extent of the law.

Band4_1.4MHz_16QAM_RB6_0_CH19957

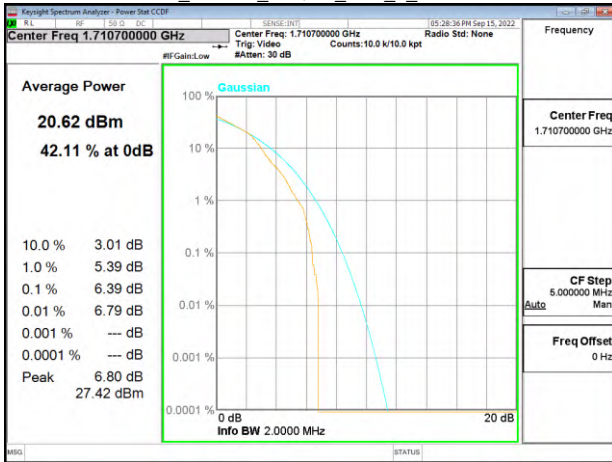

Band4_10MHz_16QAM_RB6_0_CH20000

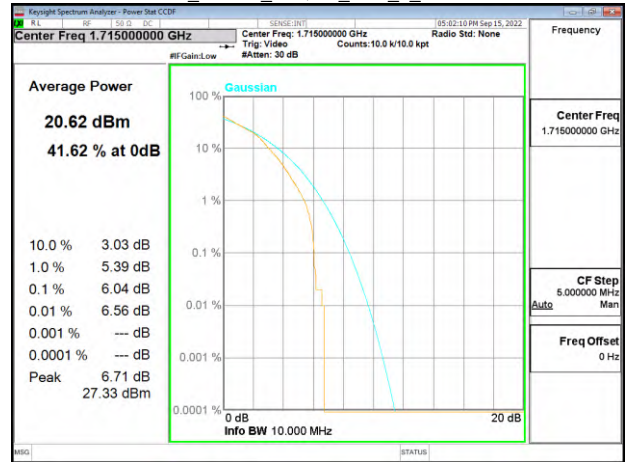

Band4_1.4MHz_16QAM_RB6_0_CH20175

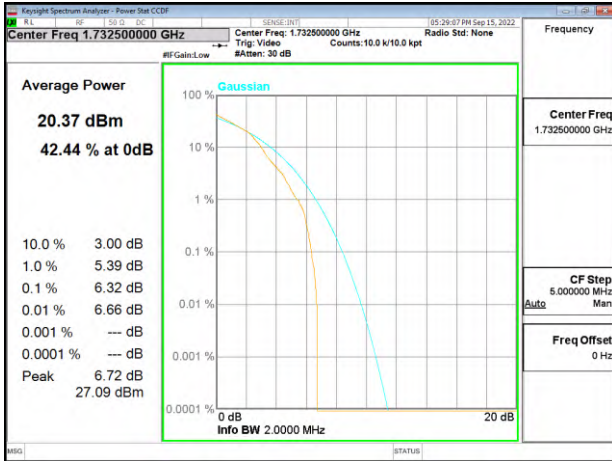

Band4_10MHz_16QAM_RB6_0_CH20175

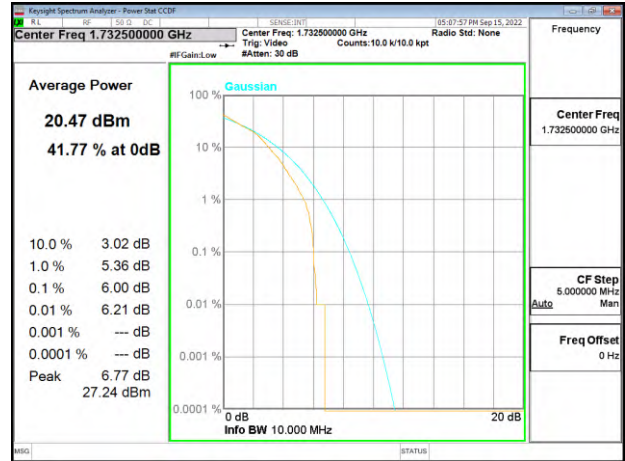

Band4_1.4MHz_16QAM_RB6_0_CH20393

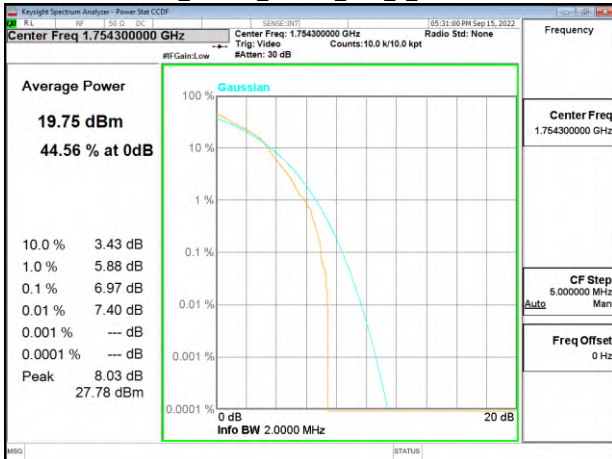

Band4_10MHz_16QAM_RB6_0_CH20350

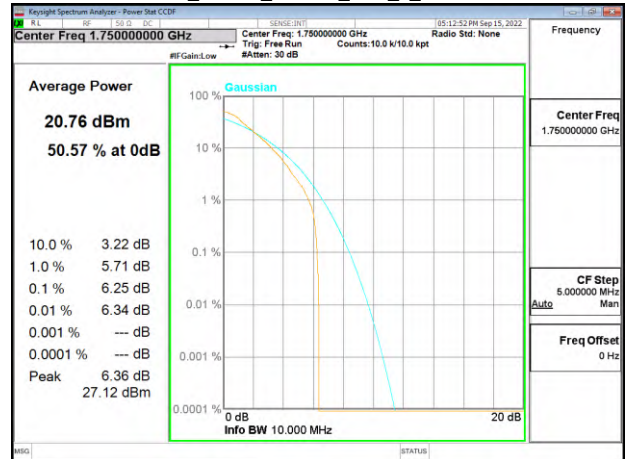

Unless otherwise stated the results shown in this test report refer only to the sample(s) tested and such sample(s) are retained for 90 days only.

除非另有說明，此報告結果僅對測試之樣品負責，同時此樣品僅保留90天。本報告未經本公司書面許可，不可部份複製。

This document is issued by the Company subject to its General Conditions of Service printed overleaf, available on request or accessible at <http://www.sgs.com.tw/Terms-and-Conditions> and for electronic format documents, subject to Terms and Conditions for Electronic Documents at <http://www.sgs.com.tw/Terms-and-Conditions>. Attention is drawn to the limitation of liability, indemnification and jurisdiction issues defined therein. Any holder of this document is advised that information contained hereon reflects the Company's findings at the time of its intervention only and within the limits of Client's instructions, if any. The Company's sole responsibility is to its Client and this document does not exonerate parties to a transaction from exercising all their rights and obligations under the transaction documents. This document cannot be reproduced except in full, without prior written approval of the Company. Any unauthorized alteration, forgery or falsification of the content or appearance of this document is unlawful and offenders may be prosecuted to the fullest extent of the law.

Band4_15MHz_16QAM_RB6_0_CH20025

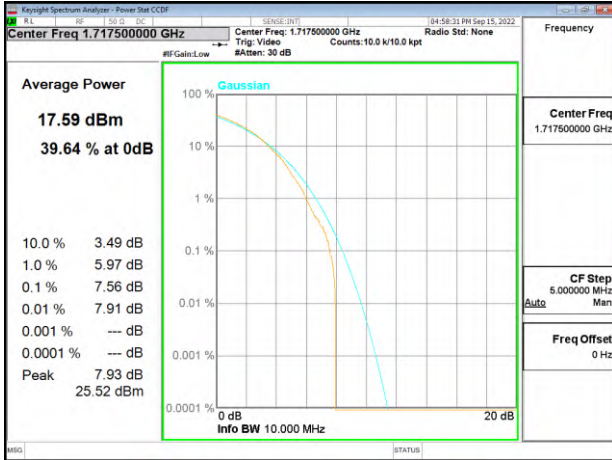

Band4_20MHz_16QAM_RB6_0_CH20050

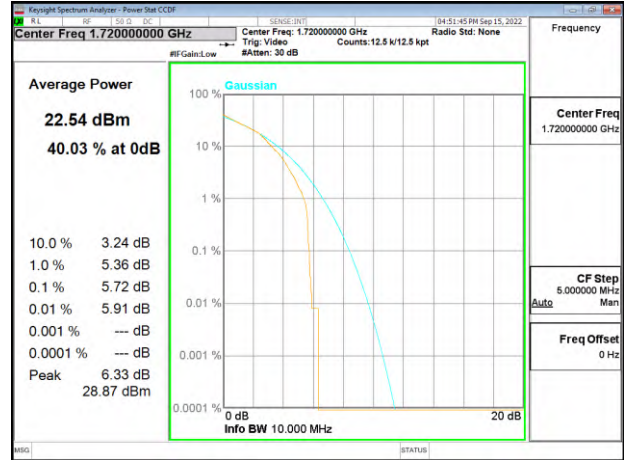

Band4_15MHz_16QAM_RB6_0_CH20175

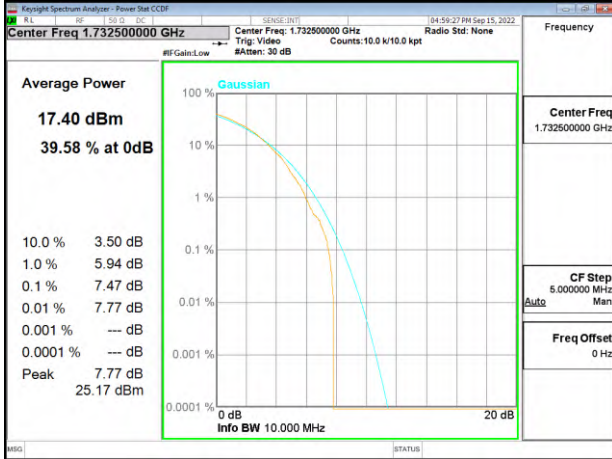

Band4_20MHz_16QAM_RB6_0_CH20175

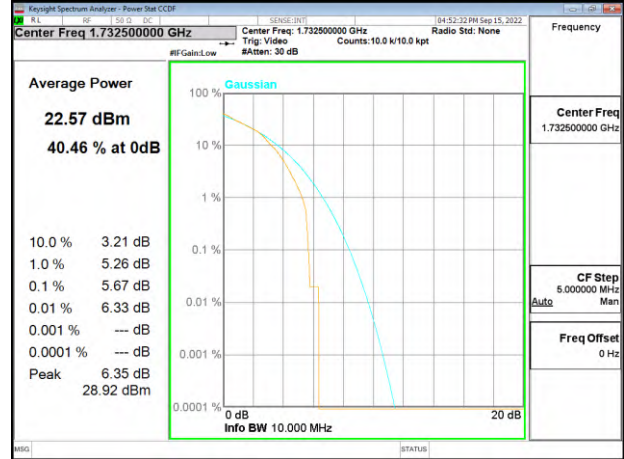

Band4_15MHz_16QAM_RB6_0_CH20325

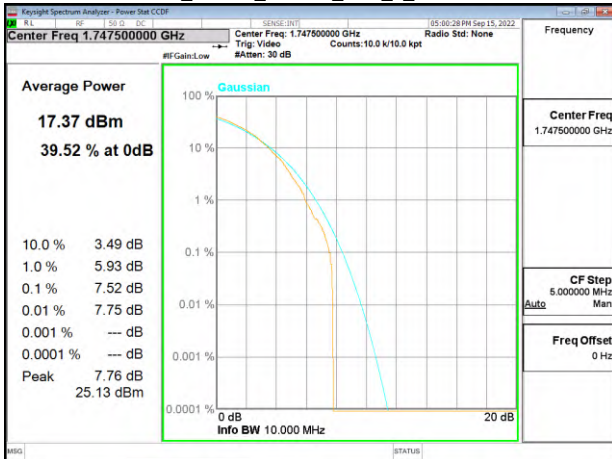

Band4_20MHz_16QAM_RB6_0_CH20300

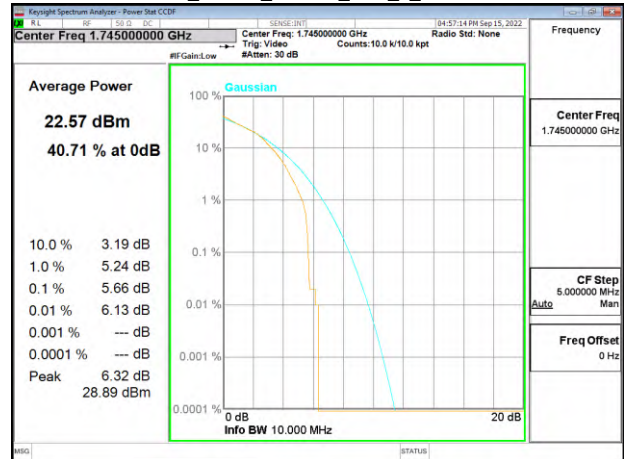

Unless otherwise stated the results shown in this test report refer only to the sample(s) tested and such sample(s) are retained for 90 days only.

除非另有說明，此報告結果僅對測試之樣品負責，同時此樣品僅保留90天。本報告未經本公司書面許可，不可部份複製。

This document is issued by the Company subject to its General Documents of Service printed overleaf, available on request or accessible at <http://www.sgs.com.tw/Terms-and-Conditions> and for electronic format documents, subject to Terms and Conditions for Electronic Documents at <http://www.sgs.com.tw/Terms-and-Conditions>. Attention is drawn to the limitation of liability, indemnification and jurisdiction issues defined therein. Any holder of this document is advised that information contained hereon reflects the Company's findings at the time of its intervention only and within the limits of Client's instructions, if any. The Company's sole responsibility is to its Client and this document does not exonerate parties to a transaction from exercising all their rights and obligations under the transaction documents. This document cannot be reproduced except in full, without prior written approval of the Company. Any unauthorized alteration, forgery or falsification of the content or appearance of this document is unlawful and offenders may be prosecuted to the fullest extent of the law.

Band4_3MHz_16QAM_RB6_0_CH19965

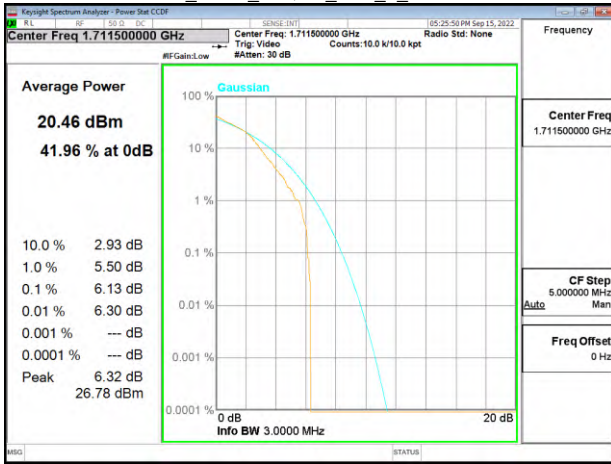

Band4_5MHz_16QAM_RB6_0_CH19975

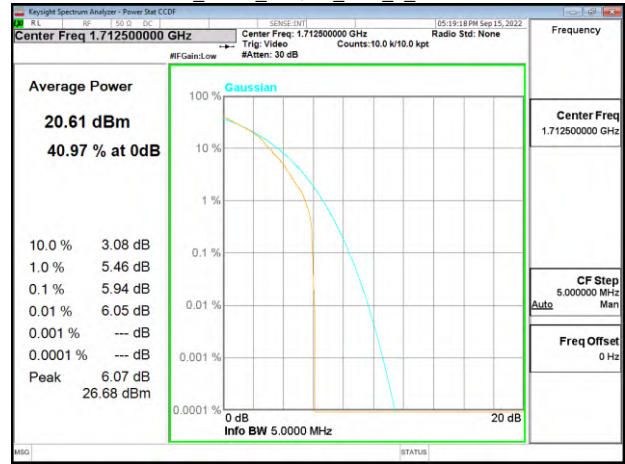

Band4_3MHz_16QAM_RB6_0_CH20175

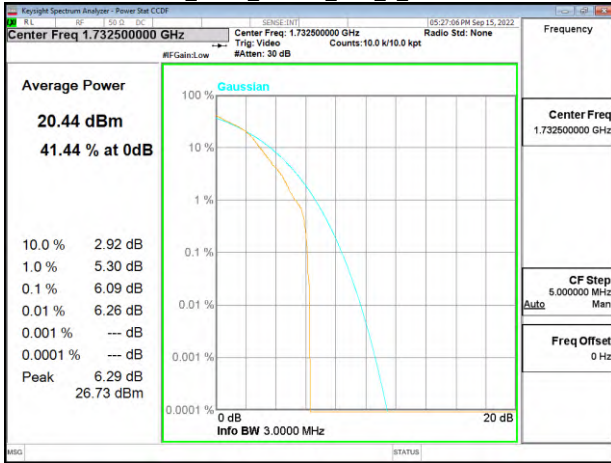

Band4_5MHz_16QAM_RB6_0_CH20175

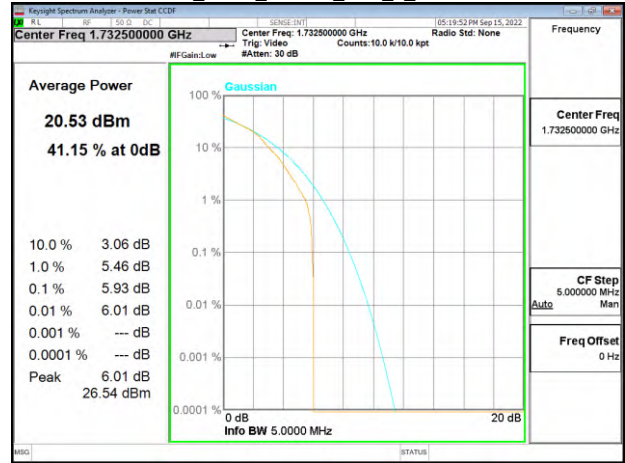

Band4_3MHz_16QAM_RB6_0_CH20385

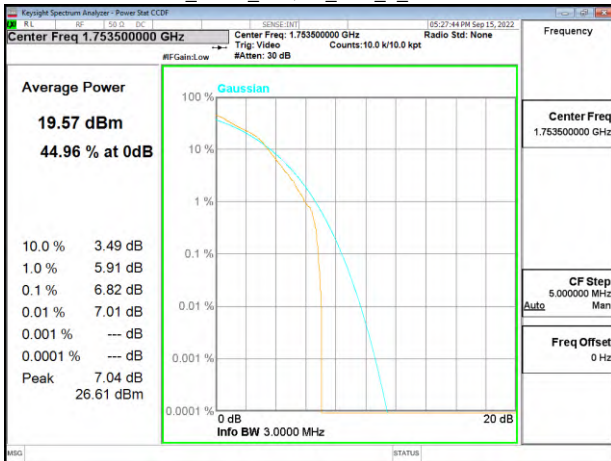

Band4_5MHz_16QAM_RB6_0_CH20375

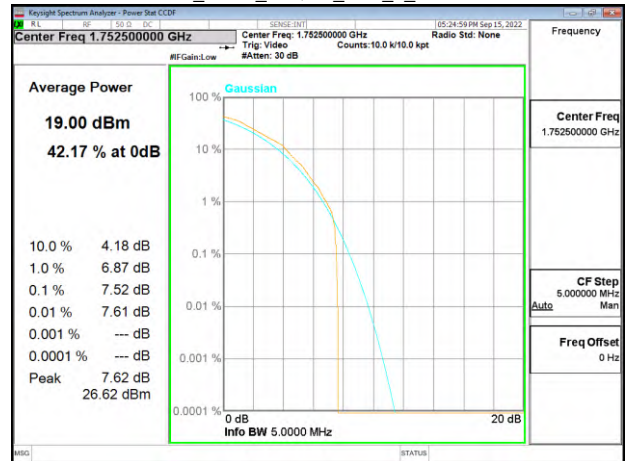

Unless otherwise stated the results shown in this test report refer only to the sample(s) tested and such sample(s) are retained for 90 days only.

除非另有說明，此報告結果僅對測試之樣品負責，同時此樣品僅保留90天。本報告未經本公司書面許可，不可部份複製。

This document is issued by the Company subject to its General Conditions of Service printed overleaf, available on request or accessible at <http://www.sgs.com.tw/Terms-and-Conditions>, and for electronic format documents, subject to Terms and Conditions for Electronic Documents at <http://www.sgs.com.tw/Terms-and-Conditions>. Attention is drawn to the limitation of liability, indemnification and jurisdiction issues defined therein. Any holder of this document is advised that information contained hereon reflects the Company's findings at the time of its intervention only and within the limits of Client's instructions, if any. The Company's sole responsibility is to its Client and this document does not exonerate parties to a transaction from exercising all their rights and obligations under the transaction documents. This document cannot be reproduced except in full, without prior written approval of the Company. Any unauthorized alteration, forgery or falsification of the content or appearance of this document is unlawful and offenders may be prosecuted to the fullest extent of the law.

Band5_1.4MHz_16QAM_RB6_0_CH20407

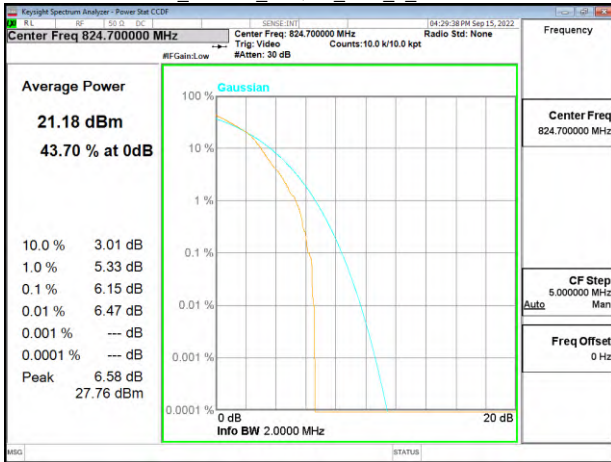

Band5_10MHz_16QAM_RB6_0_CH20450

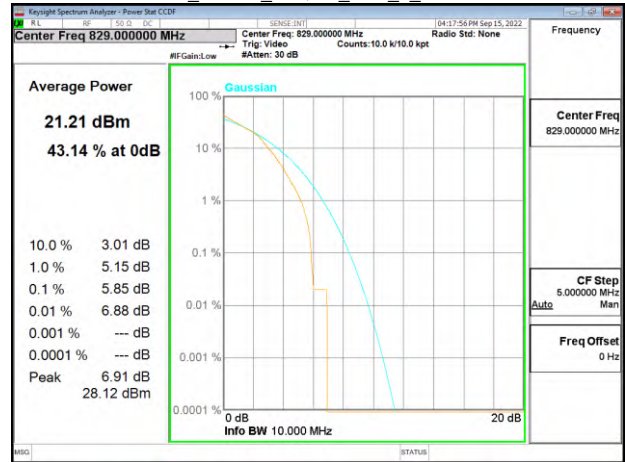

Band5_1.4MHz_16QAM_RB6_0_CH20525

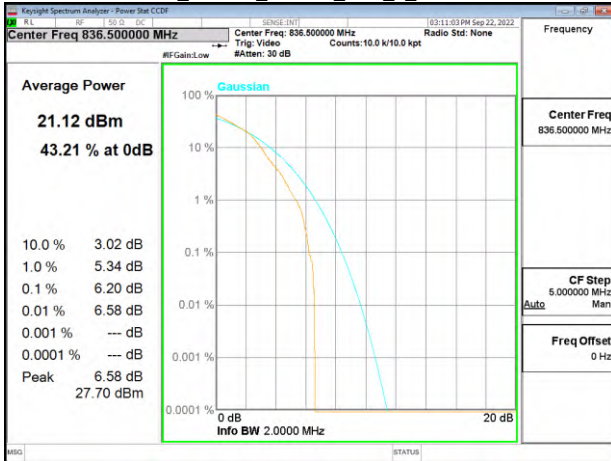

Band5_10MHz_16QAM_RB6_0_CH20525

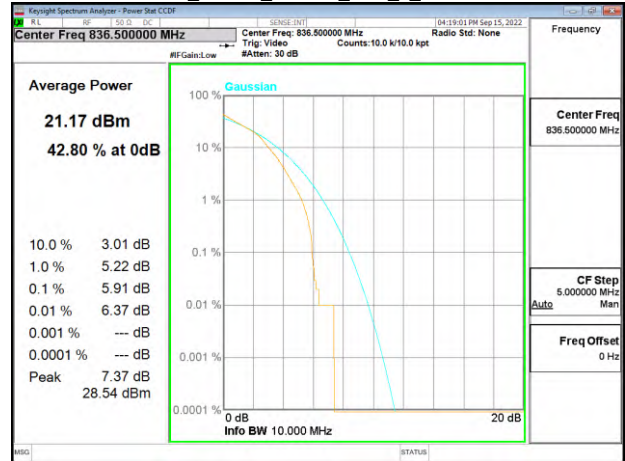

Band5_1.4MHz_16QAM_RB6_0_CH20643

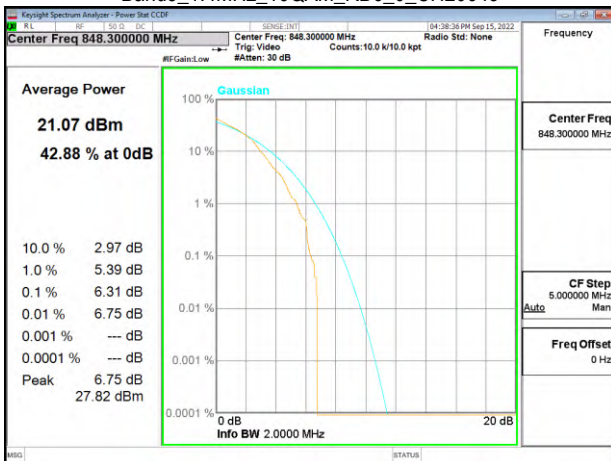

Band5_10MHz_16QAM_RB6_0_CH20600

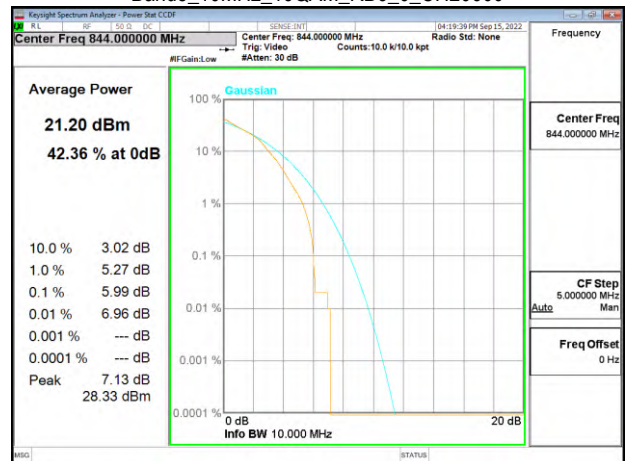

Unless otherwise stated the results shown in this test report refer only to the sample(s) tested and such sample(s) are retained for 90 days only.

除非另有說明，此報告結果僅對測試之樣品負責，同時此樣品僅保留90天。本報告未經本公司書面許可，不可部份複製。

This document is issued by the Company subject to its General Conditions of Service printed overleaf, available on request or accessible at <http://www.sgs.com.tw/Terms-and-Conditions>, and for electronic format documents, subject to Terms and Conditions for Electronic Documents at <http://www.sgs.com.tw/Terms-and-Conditions>. Attention is drawn to the limitation of liability, indemnification and jurisdiction issues defined therein. Any holder of this document is advised that information contained hereon reflects the Company's findings at the time of its intervention only and within the limits of Client's instructions, if any. The Company's sole responsibility is to its Client and this document does not exonerate parties to a transaction from exercising all their rights and obligations under the transaction documents. This document cannot be reproduced except in full, without prior written approval of the Company. Any unauthorized alteration, forgery or falsification of the content or appearance of this document is unlawful and offenders may be prosecuted to the fullest extent of the law.

Band5_3MHz_16QAM_RB6_0_CH20415

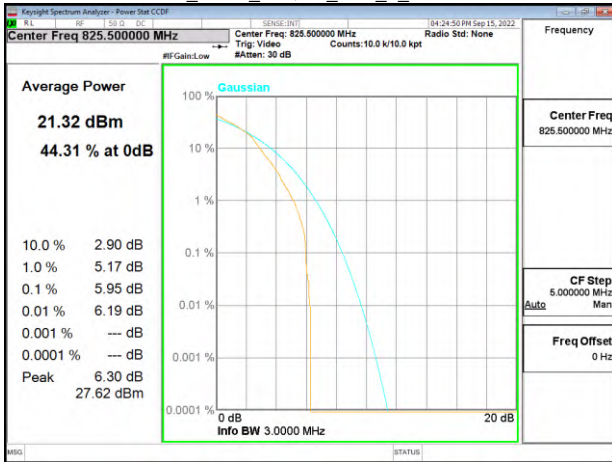

Band5_5MHz_16QAM_RB6_0_CH20425

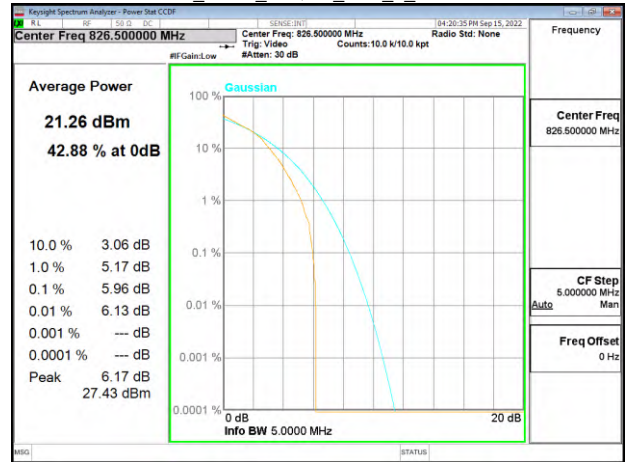

Band5_3MHz_16QAM_RB6_0_CH20525

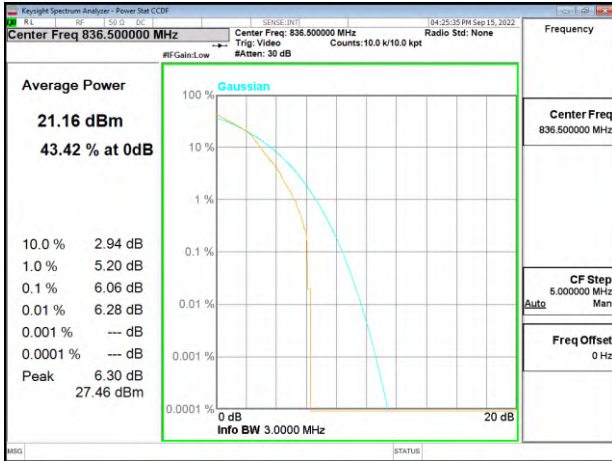

Band5_5MHz_16QAM_RB6_0_CH20525

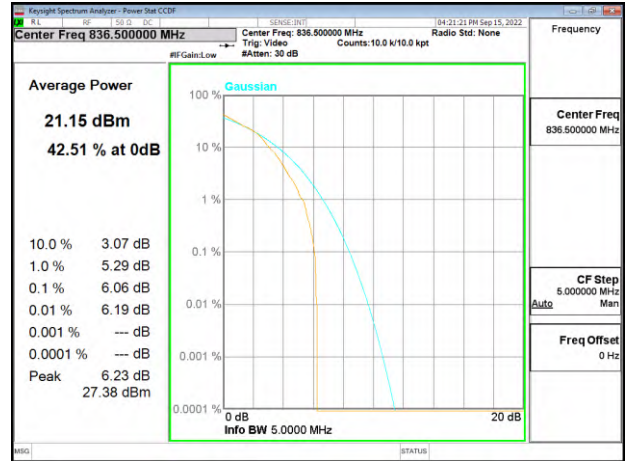

Band5_3MHz_16QAM_RB6_0_CH20635

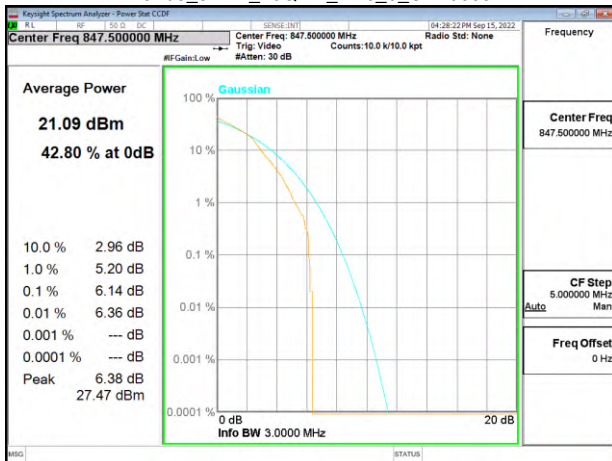

Band5_5MHz_16QAM_RB6_0_CH20625

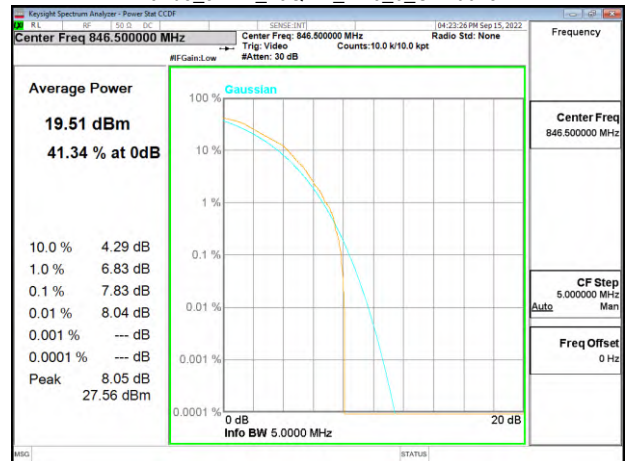

~ End of Report ~

Unless otherwise stated the results shown in this test report refer only to the sample(s) tested and such sample(s) are retained for 90 days only.

除非另有說明，此報告結果僅對測試之樣品負責，同時此樣品僅保留90天。本報告未經本公司書面許可，不可部份複製。

This document is issued by the Company subject to its General Conditions of Service printed overleaf, available on request or accessible at <http://www.sgs.com.tw/Terms-and-Conditions> and for electronic format documents, subject to Terms and Conditions for Electronic Documents at <http://www.sgs.com.tw/Terms-and-Conditions>. Attention is drawn to the limitation of liability, indemnification and jurisdiction issues defined therein. Any holder of this document is advised that information contained hereon reflects the Company's findings at the time of its intervention only and within the limits of Client's instructions, if any. The Company's sole responsibility is to its Client and this document does not exonerate parties to a transaction from exercising all their rights and obligations under the transaction documents. This document cannot be reproduced except in full, without prior written approval of the Company. Any unauthorized alteration, forgery or falsification of the content or appearance of this document is unlawful and offenders may be prosecuted to the fullest extent of the law.