

**ELECTROMAGNETIC EMISSIONS
COMPLIANCE REPORT**

Applicant: Motive Technologies, Inc.
55 Hawthorne St. Suite #400, San Francisco, CA 94105

Manufacturer: Motive Technologies, Inc.
55 Hawthorne St. Suite #400, San Francisco, CA 94105

Product Name: Asset Gateway Mini

Brand Name: Motive

Model No.: AG-31

Model Difference: N/A

Report Number: TERF2304000923ER

FCC ID 2AQM7-AG31

IC: 24516-AG31

Date of EUT Received: April 19, 2023

Date of Test: April 19, 2023~May 4, 2023

Issue Date: May 18, 2023

Approved By _____

Blue Yang**We hereby certify that:**

The above equipment was tested by SGS Taiwan Ltd. Central RF Lab The test data, data evaluation, test procedures, and equipment configurations shown in this report were made in accordance with the procedures given in ANSI C63.10:2013 and the energy emitted by the sample EUT comply with FCC rule part §15.247, ISED RSS-247.

The results of this report relate only to the sample identified in this report.

Unless otherwise stated the results shown in this test report refer only to the sample(s) tested and such sample(s) are retained for 90 days only.
除非另有說明，此報告結果僅對測試之樣品負責，同時此樣品僅保留90天。本報告未經本公司書面許可，不可部份複製。

This document is issued by the Company subject to its General Conditions of Service printed overleaf, available on request or accessible at <http://www.sgs.com.tw/Terms-and-Conditions> and for electronic format documents, subject to Terms and Conditions for Electronic Documents at <http://www.sgs.com.tw/Terms-and-Conditions>. Attention is drawn to the limitation of liability, indemnification and jurisdiction issues defined therein. Any holder of this document is advised that information contained hereon reflects the Company's findings at the time of its intervention only and within the limits of Client's instructions, if any. The Company's sole responsibility is to its Client and this document does not exonerate parties to a transaction from exercising all their rights and obligations under the transaction documents. This document cannot be reproduced except in full, without prior written approval of the Company. Any unauthorized alteration, forgery or falsification of the content or appearance of this document is unlawful and offenders may be prosecuted to the fullest extent of the law.

Revision History

Report Number	Revision	Description	Issue Date	Revised By	Remark
TERF2304000923ER	00	Original	May 18, 2023	Yuri Tsai	

Note:

- 1、The remark "*" indicates modification of the report upon requests from certification body.

Unless otherwise stated the results shown in this test report refer only to the sample(s) tested and such sample(s) are retained for 90 days only.
 除非另有說明，此報告結果僅對測試之樣品負責，同時此樣品僅保留90天。本報告未經本公司書面許可，不可部份複製。

This document is issued by the Company subject to its General Conditions of Service printed overleaf, available on request or accessible at <http://www.sgs.com.tw/Terms-and-Conditions> and for electronic format documents, subject to Terms and Conditions for Electronic Documents at <http://www.sgs.com.tw/Terms-and-Conditions>. Attention is drawn to the limitation of liability, indemnification and jurisdiction issues defined therein. Any holder of this document is advised that information contained hereon reflects the Company's findings at the time of its intervention only and within the limits of Client's instructions, if any. The Company's sole responsibility is to its Client and this document does not exonerate parties to a transaction from exercising all their rights and obligations under the transaction documents. This document cannot be reproduced except in full, without prior written approval of the Company. Any unauthorized alteration, forgery or falsification of the content or appearance of this document is unlawful and offenders may be prosecuted to the fullest extent of the law.

SGS Taiwan Ltd.

No.134,Wu Kung Road, New Taipei Industrial Park, Wuku District, New Taipei City, Taiwan/新北市五股區新北產業園區五工路 134 號

台灣檢驗科技股份有限公司

t (886-2) 2299-3279

f (886-2) 2298-0488

www.sgs.com.tw

Member of SGS Group

Table of Contents

1	GENERAL INFORMATION	4
2	SYSTEM TEST CONFIGURATION.....	7
3	SUMMARY OF TEST RESULTS.....	10
4	DESCRIPTION OF TEST MODES.....	11
5	MEASUREMENT UNCERTAINTY	13
6	MEASUREMENT EQUIPMENT USED	14
7	CONDUCTED EMISSION TEST	16
8	PEAK OUTPUT POWER MEASUREMENT	18
9	EMISSION BANDWIDTH MEASUREMENT	22
10	CONDUCTED BAND EDGES AND SPURIOUS EMISSION MEASUREMENT.....	26
11	RADIATED BANDEDGE AND SPURIOUS EMISSION MEASUREMENT.....	31
12	POWER SPECTRAL DENSITY	58
13	ANTENNA REQUIREMENT.....	61

Unless otherwise stated the results shown in this test report refer only to the sample(s) tested and such sample(s) are retained for 90 days only.

除非另有說明，此報告結果僅對測試之樣品負責，同時此樣品僅保留90天。本報告未經本公司書面許可，不可部份複製。

This document is issued by the Company subject to its General Conditions of Service printed overleaf, available on request or accessible at <http://www.sgs.com.tw/Terms-and-Conditions> and for electronic format documents, subject to Terms and Conditions for Electronic Documents at <http://www.sgs.com.tw/Terms-and-Conditions>. Attention is drawn to the limitation of liability, indemnification and jurisdiction issues defined therein. Any holder of this document is advised that information contained hereon reflects the Company's findings at the time of its intervention only and within the limits of Client's instructions, if any. The Company's sole responsibility is to its Client and this document does not exonerate parties to a transaction from exercising all their rights and obligations under the transaction documents. This document cannot be reproduced except in full, without prior written approval of the Company. Any unauthorized alteration, forgery or falsification of the content or appearance of this document is unlawful and offenders may be prosecuted to the fullest extent of the law.

1 GENERAL INFORMATION

1.1 Product Description

Product Name:	Asset Gateway Mini
Brand Name:	Motive
Model No.:	AG-31
Model Difference:	N/A
Hardware Version:	NRF9160-SICA-B1A-R7
Firmware Version:	mfw_nrf9160_1.3.3
EUT Series No.:	ACEA11DD131358
Power Supply:	6V
Test Software (Name/Version)	Tera Term Version 4.73

1.2 RF Specification

Radio Technology:	BLE
Frequency Range:	2402 – 2480MHz
Channel number:	40 channels
Modulation type:	GFSK
Transmit Power:	BLE 1M: 7.83dBm BLE 2M: 7.83dBm

1.3 Antenna Designation

Antenna Type	Freq. (MHz)	Peak Antenna Gain (dBi)
IFA	2.4GHz	3.01

Note: Antenna information is provided by the applicant.

Unless otherwise stated the results shown in this test report refer only to the sample(s) tested and such sample(s) are retained for 90 days only.

除非另有說明，此報告結果僅對測試之樣品負責，同時此樣品僅保留90天。本報告未經本公司書面許可，不可部份複製。

This document is issued by the Company subject to its General Conditions of Service printed overleaf, available on request or accessible at <http://www.sgs.com.tw/Terms-and-Conditions> and for electronic format documents, subject to Terms and Conditions for Electronic Documents at <http://www.sgs.com.tw/Terms-and-Conditions>. Attention is drawn to the limitation of liability, indemnification and jurisdiction issues defined therein. Any holder of this document is advised that information contained hereon reflects the Company's findings at the time of its intervention only and within the limits of Client's instructions, if any. The Company's sole responsibility is to its Client and this document does not exonerate parties to a transaction from exercising all their rights and obligations under the transaction documents. This document cannot be reproduced except in full, without prior written approval of the Company. Any unauthorized alteration, forgery or falsification of the content or appearance of this document is unlawful and offenders may be prosecuted to the fullest extent of the law.

1.4 Test Methodology of Applied Standards

FCC Part 15, Subpart C §15.247
 FCC KDB 558074 D01 15.247 Meas Guidance v05r02
 RSS-247 issue 2 Feb. 2017
 RSS-Gen, Issue 5 April 2018
 ANSI C63.10:2013

1.5 Test Facility

Laboratory	Test Site Address	Test Site Name	FCC Designation number	IC CAB identifier
SGS Taiwan Ltd. Central RF Lab. (TAF code 3702)	No.134, Wu Kung Road, New Taipei Industrial Park, Wuku District, New Taipei City, Taiwan.	SAC 1	TW0027	TW3702
		SAC 2		
		SAC 3		
		Conduction 1		
		Conducted 1		
		Conducted 2		
		Conducted 3		
		Conducted 4		
		Conducted 5		
		Conducted 6		
	No.2, Keji 1st Rd., Guishan District, Taoyuan City, Taiwan 333	Conduction C	TW0028	
		SAC C		
		SAC D		
		SAC G		
		Conducted A		
		Conducted B		
		Conducted C		
		Conducted D		
		Conducted E		
Conducted F				
Conducted G				

Note: Test site name is remarked on the equipment list in each section of this report as an indication where measurements occurred in specific test site and address.

Unless otherwise stated the results shown in this test report refer only to the sample(s) tested and such sample(s) are retained for 90 days only.
 除非另有說明，此報告結果僅對測試之樣品負責，同時此樣品僅保留90天。本報告未經本公司書面許可，不可部份複製。

This document is issued by the Company subject to its General Conditions of Service printed overleaf, available on request or accessible at <http://www.sgs.com.tw/Terms-and-Conditions> and for electronic format documents, subject to Terms and Conditions for Electronic Documents at <http://www.sgs.com.tw/Terms-and-Conditions>. Attention is drawn to the limitation of liability, indemnification and jurisdiction issues defined therein. Any holder of this document is advised that information contained hereon reflects the Company's findings at the time of its intervention only and within the limits of Client's instructions, if any. The Company's sole responsibility is to its Client and this document does not exonerate parties to a transaction from exercising all their rights and obligations under the transaction documents. This document cannot be reproduced except in full, without prior written approval of the Company. Any unauthorized alteration, forgery or falsification of the content or appearance of this document is unlawful and offenders may be prosecuted to the fullest extent of the law.

1.6 Special Accessories

There are no special accessories used while test was conducted.

1.7 Equipment Modifications

There was no modification incorporated into the EUT.

Unless otherwise stated the results shown in this test report refer only to the sample(s) tested and such sample(s) are retained for 90 days only.
除非另有說明，此報告結果僅對測試之樣品負責，同時此樣品僅保留90天。本報告未經本公司書面許可，不可部份複製。

This document is issued by the Company subject to its General Conditions of Service printed overleaf, available on request or accessible at <http://www.sgs.com.tw/Terms-and-Conditions> and for electronic format documents, subject to Terms and Conditions for Electronic Documents at <http://www.sgs.com.tw/Terms-and-Conditions>. Attention is drawn to the limitation of liability, indemnification and jurisdiction issues defined therein. Any holder of this document is advised that information contained hereon reflects the Company's findings at the time of its intervention only and within the limits of Client's instructions, if any. The Company's sole responsibility is to its Client and this document does not exonerate parties to a transaction from exercising all their rights and obligations under the transaction documents. This document cannot be reproduced except in full, without prior written approval of the Company. Any unauthorized alteration, forgery or falsification of the content or appearance of this document is unlawful and offenders may be prosecuted to the fullest extent of the law.

2 SYSTEM TEST CONFIGURATION

2.1 EUT Configuration

The EUT configuration for testing is installed on RF field strength measurement to meet the Commissions requirement and operating in a manner which intends to maximize its emission characteristics in a continuous normal application.

2.2 EUT Exercise

An engineering test mode (software/firmware) that applicant provided was utilized to manipulate the EUT into transmit, selection of the test channel, and modulation scheme.

2.3 Test Procedure

2.3.1 Conducted Emissions

The EUT is placed on a table which is 0.8 m above ground plane. Conducted emissions from the EUT measured in the frequency range between 0.15 MHz and 30MHz. The CISPR Quasi-Peak and Average detector mode is employed. The two LISNs provide 50uH/50 ohm of coupling impedance for the measuring instrument. Both lines of the power mains connected to the EUT were checked for maximum conducted interference.

2.3.2 Conducted Test (RF)

The active antenna port of the unlicensed wireless device is connected to the spectrum analyzer with attenuator to protect the instrumentation. If a second antenna port is available, it is tested at one operating frequency, with other port(s) appropriately terminated, to verify it has similar output characteristics as the fully tested port.

2.3.3 Radiated Emissions

The EUT is placed on a turn table. For emissions testing at or below 1 GHz, the table height shall be 0.8 m above the reference ground plane. For emission measurements above 1 GHz, the table height shall be 1.5 m. The turn table shall rotate 360 degrees to determine the position of maximum emission level. EUT is set 3m away from the receiving antenna which varied from 1m to 4m to find out the highest emission. And also, each emission was to be maximized by changing the polarization of receiving antenna both horizontal and vertical. In order to find out the max. emission, the relative positions of this transmitter (EUT) was rotated through three orthogonal axes and measurement procedures for electric field radiated emissions above 1 GHz the EUT measurement is to be made "while keeping the antenna in the 'cone of radiation' from that area and pointed at the area both in azimuth and elevation, with polarization oriented for maximum response." is still within the 3dB illumination BW of the measurement antenna.

2.4 Measurement Results Explanation Example

2.4.1 Radiated Emission Test Sites For Measurements From 9 kHz To 30 MHz

Radiated emission below 30MHz is measured in a 9m*6m*6m semi-anechoic

Unless otherwise stated the results shown in this test report refer only to the sample(s) tested and such sample(s) are retained for 90 days only.
除非另有說明，此報告結果僅對測試之樣品負責，同時此樣品僅保留90天。本報告未經本公司書面許可，不可部份複製。

This document is issued by the Company subject to its General Conditions of Service printed overleaf, available on request or accessible at <http://www.sgs.com.tw/Terms-and-Conditions> and for electronic format documents, subject to Terms and Conditions for Electronic Documents at <http://www.sgs.com.tw/Terms-and-Conditions>. Attention is drawn to the limitation of liability, indemnification and jurisdiction issues defined therein. Any holder of this document is advised that information contained hereon reflects the Company's findings at the time of its intervention only and within the limits of Client's instructions, if any. The Company's sole responsibility is to its Client and this document does not exonerate parties to a transaction from exercising all their rights and obligations under the transaction documents. This document cannot be reproduced except in full, without prior written approval of the Company. Any unauthorized alteration, forgery or falsification of the content or appearance of this document is unlawful and offenders may be prosecuted to the fullest extent of the law.

chamber, the measurements correspond to those obtained at an open-field test site.

There is a comparison data of both open-field test site and semi-Anechoic chamber, and the result came out very similar.

2.4.2 For all conducted test items:

The offset level is set in the spectrum analyzer to compensate the RF cable loss and attenuation factor between EUT conducted port and spectrum analyzer. With the offset compensation, the spectrum analyzer reading level is exactly EUT RF output level.

Unless otherwise stated the results shown in this test report refer only to the sample(s) tested and such sample(s) are retained for 90 days only.
除非另有說明，此報告結果僅對測試之樣品負責，同時此樣品僅保留90天。本報告未經本公司書面許可，不可部份複製。

This document is issued by the Company subject to its General Conditions of Service printed overleaf, available on request or accessible at <http://www.sgs.com.tw/Terms-and-Conditions> and for electronic format documents, subject to Terms and Conditions for Electronic Documents at <http://www.sgs.com.tw/Terms-and-Conditions>. Attention is drawn to the limitation of liability, indemnification and jurisdiction issues defined therein. Any holder of this document is advised that information contained hereon reflects the Company's findings at the time of its intervention only and within the limits of Client's instructions, if any. The Company's sole responsibility is to its Client and this document does not exonerate parties to a transaction from exercising all their rights and obligations under the transaction documents. This document cannot be reproduced except in full, without prior written approval of the Company. Any unauthorized alteration, forgery or falsification of the content or appearance of this document is unlawful and offenders may be prosecuted to the fullest extent of the law.

2.5 Test Configuration

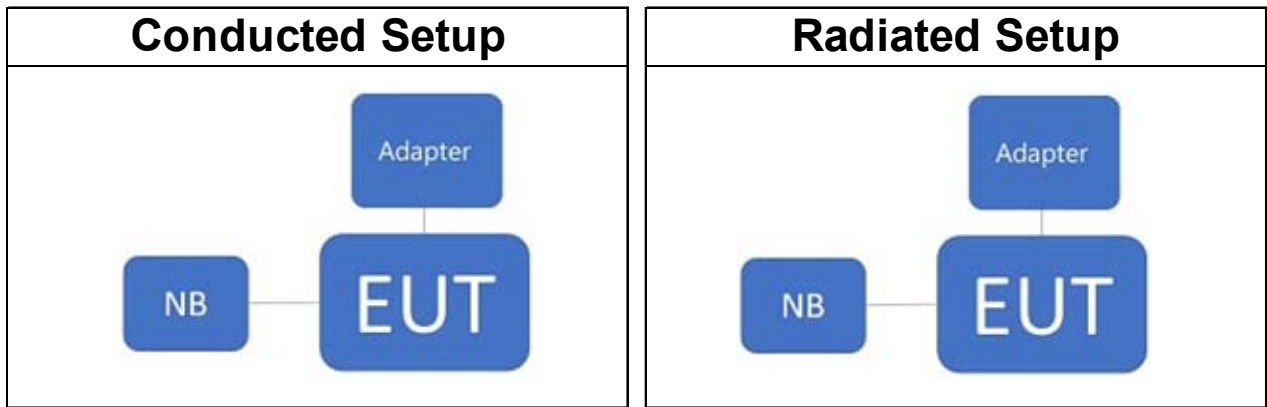

2.6 Control Unit(s)

Conducted Emission Test Site: Conducted 2					
EQUIPMENT TYPE	MFR	MODEL NUMBER	SERIAL NUMBER	LAST CAL.	CAL DUE.
Notebook	Lenovo	L480	PF-1S9NT5	N/A	N/A

Radiated Emission Test Site: SAC 2					
EQUIPMENT TYPE	MFR	MODEL NUMBER	SERIAL NUMBER	LAST CAL.	CAL DUE.
Adapter	N/A	XYY012-120100	N/A	N/A	N/A
Notebook	Lenovo	L480	PF-1D07MD	N/A	N/A

Unless otherwise stated the results shown in this test report refer only to the sample(s) tested and such sample(s) are retained for 90 days only.

除非另有說明，此報告結果僅對測試之樣品負責，同時此樣品僅保留90天。本報告未經本公司書面許可，不可部份複製。

This document is issued by the Company subject to its General Conditions of Service printed overleaf, available on request or accessible at <http://www.sgs.com.tw/Terms-and-Conditions> and for electronic format documents, subject to Terms and Conditions for Electronic Documents at <http://www.sgs.com.tw/Terms-and-Conditions>. Attention is drawn to the limitation of liability, indemnification and jurisdiction issues defined therein. Any holder of this document is advised that information contained hereon reflects the Company's findings at the time of its intervention only and within the limits of Client's instructions, if any. The Company's sole responsibility is to its Client and this document does not exonerate parties to a transaction from exercising all their rights and obligations under the transaction documents. This document cannot be reproduced except in full, without prior written approval of the Company. Any unauthorized alteration, forgery or falsification of the content or appearance of this document is unlawful and offenders may be prosecuted to the fullest extent of the law.

3 SUMMARY OF TEST RESULTS

FCC Rules	ISED Rules	Description Of Test	Result
§15.207(a)	RSS-Gen §8.8	AC Power Line Conducted Emission	N/A
§15.247(b) (3)	RSS-247 §5.4 d	Peak Output Power	Compliant
§15.247(a)(2)	RSS-247 §5.2 a RSS-Gen §6.7	Emission Bandwidth	Compliant
§15.247(d) §15.205 §15.209	RSS-247 §5.5 RSS-Gen §8.9 RSS-Gen §8.10	Radiated & Conducted Band Edge and Spurious Emission	Compliant
§15.247(e)	RSS-247 §5.2 b	Peak Power Density	Compliant
§15.203	N/A	Antenna Requirement	Compliant

Unless otherwise stated the results shown in this test report refer only to the sample(s) tested and such sample(s) are retained for 90 days only.

除非另有說明，此報告結果僅對測試之樣品負責，同時此樣品僅保留90天。本報告未經本公司書面許可，不可部份複製。

This document is issued by the Company subject to its General Conditions of Service printed overleaf, available on request or accessible at <http://www.sgs.com.tw/Terms-and-Conditions> and for electronic format documents, subject to Terms and Conditions for Electronic Documents at <http://www.sgs.com.tw/Terms-and-Conditions>. Attention is drawn to the limitation of liability, indemnification and jurisdiction issues defined therein. Any holder of this document is advised that information contained hereon reflects the Company's findings at the time of its intervention only and within the limits of Client's instructions, if any. The Company's sole responsibility is to its Client and this document does not exonerate parties to a transaction from exercising all their rights and obligations under the transaction documents. This document cannot be reproduced except in full, without prior written approval of the Company. Any unauthorized alteration, forgery or falsification of the content or appearance of this document is unlawful and offenders may be prosecuted to the fullest extent of the law.

4 DESCRIPTION OF TEST MODES

4.1 Operating Frequencies

ITEM	FREQUENCY	ITEM	FREQUENCY	ITEM	FREQUENCY
1	2402 MHz	15	2430 MHz	29	2458 MHz
2	2404 MHz	16	2432 MHz	30	2460 MHz
3	2406 MHz	17	2434 MHz	31	2462 MHz
4	2408 MHz	18	2436 MHz	32	2464 MHz
5	2410 MHz	19	2438 MHz	33	2466 MHz
6	2412 MHz	20	2440 MHz	34	2468 MHz
7	2414 MHz	21	2442 MHz	35	2470 MHz
8	2416MHz	22	2444 MHz	36	2472 MHz
9	2418 MHz	23	2446 MHz	37	2474 MHz
10	2420 MHz	24	2448 MHz	38	2476 MHz
11	2422 MHz	25	2450 MHz	39	2478 MHz
12	2424 MHz	26	2452 MHz	40	2480 MHz
13	2426 MHz	27	2454 MHz		
14	2428 MHz	28	2456 MHz		

4.2 The Worst Test Modes and Channel Details

1. The EUT has been tested under operating condition.
2. Test program used to control the EUT for staying in continuous transmitting and receiving mode is programmed.
3. The field strength of radiation emission was measured as the EUT positioned in different orthogonal planes (E1/E2/H) based on actual usage of the EUT to pre-scan the emissions for determining the worst case scenario.
4. Investigation has been done on all the possible configurations for searching the worst case.

CONDUCTED TEST				
MODE	AVAILABLE CHANNEL	TESTED CHANNEL	MODULATION	DATA RATE (Mbps)
Bluetooth LE	0 to 39	0,20,39	GFSK	1
Bluetooth LE	0 to 39	0,20,39	GFSK	2

Unless otherwise stated the results shown in this test report refer only to the sample(s) tested and such sample(s) are retained for 90 days only.

除非另有說明，此報告結果僅對測試之樣品負責，同時此樣品僅保留90天。本報告未經本公司書面許可，不可部份複製。

This document is issued by the Company subject to its General Conditions of Service printed overleaf, available on request or accessible at <http://www.sgs.com.tw/Terms-and-Conditions> and for electronic format documents, subject to Terms and Conditions for Electronic Documents at <http://www.sgs.com.tw/Terms-and-Conditions>. Attention is drawn to the limitation of liability, indemnification and jurisdiction issues defined therein. Any holder of this document is advised that information contained hereon reflects the Company's findings at the time of its intervention only and within the limits of Client's instructions, if any. The Company's sole responsibility is to its Client and this document does not exonerate parties to a transaction from exercising all their rights and obligations under the transaction documents. This document cannot be reproduced except in full, without prior written approval of the Company. Any unauthorized alteration, forgery or falsification of the content or appearance of this document is unlawful and offenders may be prosecuted to the fullest extent of the law.

RADIATED EMISSION TEST (BELOW 1 GHz)				
MODE	AVAILABLE CHANNEL	TESTED CHANNEL	MODULATION	DATA RATE (Mbps)
Bluetooth LE	0 to 39	20	GFSK	1
Bluetooth LE	0 to 39	20	GFSK	2
RADIATED EMISSION TEST (ABOVE 1 GHz)				
MODE	AVAILABLE CHANNEL	TESTED CHANNEL	MODULATION	DATA RATE (Mbps)
Bluetooth LE	0 to 39	0,20,39	GFSK	1
Bluetooth LE	0 to 39	0,20,39	GFSK	2

Unless otherwise stated the results shown in this test report refer only to the sample(s) tested and such sample(s) are retained for 90 days only.
 除非另有說明，此報告結果僅對測試之樣品負責，同時此樣品僅保留90天。本報告未經本公司書面許可，不可部份複製。

This document is issued by the Company subject to its General Conditions of Service printed overleaf, available on request or accessible at <http://www.sgs.com.tw/Terms-and-Conditions> and for electronic format documents, subject to Terms and Conditions for Electronic Documents at <http://www.sgs.com.tw/Terms-and-Conditions>. Attention is drawn to the limitation of liability, indemnification and jurisdiction issues defined therein. Any holder of this document is advised that information contained hereon reflects the Company's findings at the time of its intervention only and within the limits of Client's instructions, if any. The Company's sole responsibility is to its Client and this document does not exonerate parties to a transaction from exercising all their rights and obligations under the transaction documents. This document cannot be reproduced except in full, without prior written approval of the Company. Any unauthorized alteration, forgery or falsification of the content or appearance of this document is unlawful and offenders may be prosecuted to the fullest extent of the law.

5 MEASUREMENT UNCERTAINTY

Test Items	Uncertainty
AC Power Line Conducted Emission	+/- 2.32 dB
Output Power measurement	+/- 1 dB
Emission Bandwidth	+/- 1.53 Hz
Undesignable radiated emission measurement	+/- 1.68 dB
Peak Power Density	+/- 2.16 dB
Temperature	+/- 0.7 °C
Humidity	+/- 3 %
DC / AC Power Source	+/- 1 %

Radiated Spurious Emission Measurement Uncertainty				
Polarization: Vertical	+/-	2.8	dB	9kHz~30MHz
	+/-	4.82	dB	30MHz - 1000MHz
	+/-	4.37	dB	1GHz - 18GHz
	+/-	4.21	dB	18GHz - 40GHz
Polarization: Horizontal	+/-	2.8	dB	9kHz~30MHz
	+/-	4.54	dB	30MHz - 1000MHz
	+/-	4.37	dB	1GHz - 18GHz
	+/-	4.21	dB	18GHz - 40GHz

Note:

1. This uncertainty represents an expanded uncertainty expressed at approximately the 95% confidence level using a coverage factor of k=2.
2. The conformity assessment statement in this report is based solely on the test results, measurement uncertainty is excluded.

Unless otherwise stated the results shown in this test report refer only to the sample(s) tested and such sample(s) are retained for 90 days only.
 除非另有說明，此報告結果僅對測試之樣品負責，同時此樣品僅保留90天。本報告未經本公司書面許可，不可部份複製。

This document is issued by the Company subject to its General Conditions of Service printed overleaf, available on request or accessible at <http://www.sgs.com.tw/Terms-and-Conditions> and for electronic format documents, subject to Terms and Conditions for Electronic Documents at <http://www.sgs.com.tw/Terms-and-Conditions>. Attention is drawn to the limitation of liability, indemnification and jurisdiction issues defined therein. Any holder of this document is advised that information contained hereon reflects the Company's findings at the time of its intervention only and within the limits of Client's instructions, if any. The Company's sole responsibility is to its Client and this document does not exonerate parties to a transaction from exercising all their rights and obligations under the transaction documents. This document cannot be reproduced except in full, without prior written approval of the Company. Any unauthorized alteration, forgery or falsification of the content or appearance of this document is unlawful and offenders may be prosecuted to the fullest extent of the law.

6 MEASUREMENT EQUIPMENT USED

6.1 Emission from AC power line

N/A

6.2 Conducted Measurement

Conducted Emission Test Site: Conducted 2					
EQUIPMENT TYPE	MFR	MODEL NUMBER	SERIAL NUMBER	LAST CAL.	CAL DUE.
EXA Spectrum Analyzer	KEYSIGHT	N9010B	MY59071541	07/14/2022	07/13/2023
Test Software	SGS	Radio Test Software	Ver. 21	N.C.R	N.C.R
Power Meter	Anritsu	ML2496A	2132007	09/21/2022	09/20/2023
Power Sensor	Anritsu	MA2411B	1911391	09/21/2022	09/20/2023
Power Sensor	Anritsu	MA2411B	1911392	09/21/2022	09/20/2023
DC Block	Mini-Circuits	BLK-18-S+	1	12/13/2022	12/12/2023

Unless otherwise stated the results shown in this test report refer only to the sample(s) tested and such sample(s) are retained for 90 days only.

除非另有說明，此報告結果僅對測試之樣品負責，同時此樣品僅保留90天。本報告未經本公司書面許可，不可部份複製。

This document is issued by the Company subject to its General Conditions of Service printed overleaf, available on request or accessible at <http://www.sgs.com.tw/Terms-and-Conditions> and for electronic format documents, subject to Terms and Conditions for Electronic Documents at <http://www.sgs.com.tw/Terms-and-Conditions>. Attention is drawn to the limitation of liability, indemnification and jurisdiction issues defined therein. Any holder of this document is advised that information contained hereon reflects the Company's findings at the time of its intervention only and within the limits of Client's instructions, if any. The Company's sole responsibility is to its Client and this document does not exonerate parties to a transaction from exercising all their rights and obligations under the transaction documents. This document cannot be reproduced except in full, without prior written approval of the Company. Any unauthorized alteration, forgery or falsification of the content or appearance of this document is unlawful and offenders may be prosecuted to the fullest extent of the law.

6.3 Radiated Measurement

Radiated Emission Test Site: SAC 2					
EQUIPMENT TYPE	MFR	MODEL NUMBER	SERIAL NUMBER	LAST CAL.	CAL DUE.
Horn Antenna	RF SPIN	DRH18-E	210303A18-ES	02/24/2023	02/23/2024
Bi-log Antenna	SCHWARZBECK	VULB9168	9168-1278	03/09/2023	03/08/2024
Loop Antenna	ETS.LINDGREN	6502	148045	10/05/2022	10/04/2023
Horn Antenna	SCHWARZBECK	BBHA9170	184	12/30/2022	12/29/2023
EXA Spectrum Analyzer	KEYSIGHT	N9010B	MY60242392	12/20/2022	12/19/2023
Test Software	Audix	e3	Ver. 9.210322	N.C.R	N.C.R
EMI Test Receiver	R&S	ESCI 7	100759	08/22/2022	08/21/2023
Pre-Amplifier	EMCI	EMC330N	980826	08/31/2022	08/30/2023
Pre-Amplifier	EMCI	EMC118A45SEE	980867	08/31/2022	08/30/2023
Pre-Amplifier	EMCI	EMC184045B	980135	10/27/2022	10/26/2023
Attenuator	Mini-Circuit	BW-S10W2+	2	12/13/2022	12/12/2023
Bandreject Filter 2400-2483.5	EWT	EWT-14-0166	M1	12/13/2022	12/12/2023
4GHz High Pass Filter	WI	WHKX4.0/18G-10SS	22	12/13/2022	12/12/2023
Coaxial Cables	EMCI	EMCCFD400-NM-NM-10000	RX Cable below 1G (220238)	08/31/2022	08/30/2023
Coaxial Cables	EMCI	EMC104-SM-SM-600	RX Cable below 1G (220237)	08/31/2022	08/30/2023
Coaxial Cables	EMCI	EMC105-SM-SM-2000	RX Cable below 1G (220910)	08/31/2022	08/30/2023
Coaxial Cables	EMCI	EMC104-SM-SM-10000	RX Cable above 1G (220236)	08/31/2022	08/30/2023
Coaxial Cables	EMCI	EMC105-SM-SM-1000	RX Cable above 1G (201211)	08/31/2022	08/30/2023
Coaxial Cables	EMCI	EMC105-SM-SM-1500	RX Cable above 1G (220906)	08/31/2022	08/30/2023
Coaxial Cables	EMCI	EMC105-SM-SM-2000	RX Cable above 1G (220909)	08/31/2022	08/30/2023
Coaxial Cables	EMCI	EMCCFD400-NM-NM-10000	RX Cable below 30M (220238)	08/31/2022	08/30/2023
Coaxial Cables	EMCI	EMC105-SM-SM-2000	RX Cable below 30M (220910)	08/31/2022	08/30/2023
Site Cal	SGS	SAC 2	N/A	08/31/2022	08/30/2023

NOTE: N.C.R refers to Not Calibrated Required.

Unless otherwise stated the results shown in this test report refer only to the sample(s) tested and such sample(s) are retained for 90 days only.

除非另有說明，此報告結果僅對測試之樣品負責，同時此樣品僅保留90天。本報告未經本公司書面許可，不可部份複製。

This document is issued by the Company subject to its General Conditions of Service printed overleaf, available on request or accessible at <http://www.sgs.com.tw/Terms-and-Conditions> and for electronic format documents, subject to Terms and Conditions for Electronic Documents at <http://www.sgs.com.tw/Terms-and-Conditions>. Attention is drawn to the limitation of liability, indemnification and jurisdiction issues defined therein. Any holder of this document is advised that information contained hereon reflects the Company's findings at the time of its intervention only and within the limits of Client's instructions, if any. The Company's sole responsibility is to its Client and this document does not exonerate parties to a transaction from exercising all their rights and obligations under the transaction documents. This document cannot be reproduced except in full, without prior written approval of the Company. Any unauthorized alteration, forgery or falsification of the content or appearance of this document is unlawful and offenders may be prosecuted to the fullest extent of the law.

SGS Taiwan Ltd.

No.134,Wu Kung Road, New Taipei Industrial Park, Wuku District, New Taipei City, Taiwan/新北市五股區新北產業園區五工路 134 號

台灣檢驗科技股份有限公司

t (886-2) 2299-3279

f (886-2) 2298-0488

www.sgs.com.tw

Member of SGS Group

7 CONDUCTED EMISSION TEST

7.1 Standard Applicable:

Frequency range within 150kHz to 30MHz shall not exceed the Limit table as below.

Frequency range MHz	Limits (dB μ V)	
	Quasi-peak	Average
0.15 to 0.50	66 to 56	56 to 46
0.50 to 5	56	46
5 to 30	60	50

Note

1. The lower limit shall apply at the transition frequencies
2. The limit decreases linearly with the logarithm of the frequency in the range 0.15 MHz to 0.50 MHz.

7.2 EUT Setup:

1. The conducted emission tests were performed in the test site, using the setup in accordance with the ANSI C63.10:2013.
2. The AC/DC Power adaptor of EUT was plug-in LISN. The EUT was placed flushed with the rear of the table.
3. The LISN was connected with 120Vac/60Hz power source.

7.3 Test Setup

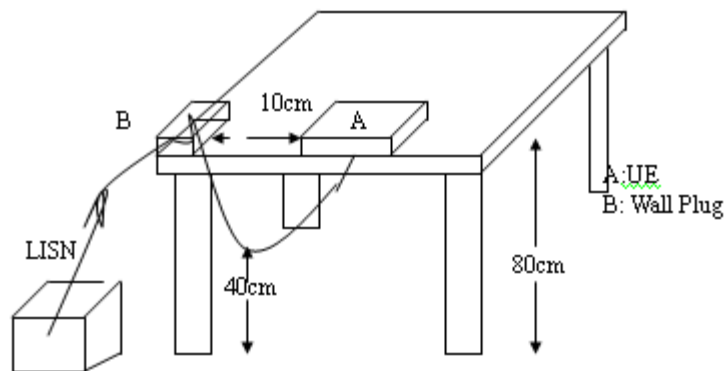

7.4 Measurement Procedure:

1. The EUT was placed on a table which is 0.8m above ground plane.

Unless otherwise stated the results shown in this test report refer only to the sample(s) tested and such sample(s) are retained for 90 days only.

除非另有說明，此報告結果僅對測試之樣品負責，同時此樣品僅保留90天。本報告未經本公司書面許可，不可部份複製。
This document is issued by the Company subject to its General Conditions of Service printed overleaf, available on request or accessible at <http://www.sgs.com.tw/Terms-and-Conditions> and for electronic format documents, subject to Terms and Conditions for Electronic Documents at <http://www.sgs.com.tw/Terms-and-Conditions>. Attention is drawn to the limitation of liability, indemnification and jurisdiction issues defined therein. Any holder of this document is advised that information contained hereon reflects the Company's findings at the time of its intervention only and within the limits of Client's instructions, if any. The Company's sole responsibility is to its Client and this document does not exonerate parties to a transaction from exercising all their rights and obligations under the transaction documents. This document cannot be reproduced except in full, without prior written approval of the Company. Any unauthorized alteration, forgery or falsification of the content or appearance of this document is unlawful and offenders may be prosecuted to the fullest extent of the law.

2. Maximum procedure was performed on the six highest emissions to ensure EUT compliance.
3. Repeat above procedures until all phases of power being supplied by given UE are completed

7.5 Measurement Result:

N/A; Powered from battery.

Unless otherwise stated the results shown in this test report refer only to the sample(s) tested and such sample(s) are retained for 90 days only.

除非另有說明，此報告結果僅對測試之樣品負責，同時此樣品僅保留90天。本報告未經本公司書面許可，不可部份複製。

This document is issued by the Company subject to its General Conditions of Service printed overleaf, available on request or accessible at <http://www.sgs.com.tw/Terms-and-Conditions> and for electronic format documents, subject to Terms and Conditions for Electronic Documents at <http://www.sgs.com.tw/Terms-and-Conditions>. Attention is drawn to the limitation of liability, indemnification and jurisdiction issues defined therein. Any holder of this document is advised that information contained hereon reflects the Company's findings at the time of its intervention only and within the limits of Client's instructions, if any. The Company's sole responsibility is to its Client and this document does not exonerate parties to a transaction from exercising all their rights and obligations under the transaction documents. This document cannot be reproduced except in full, without prior written approval of the Company. Any unauthorized alteration, forgery or falsification of the content or appearance of this document is unlawful and offenders may be prosecuted to the fullest extent of the law.

8 PEAK OUTPUT POWER MEASUREMENT

8.1 Standard Applicable:

For systems using digital modulation in the 2400-2483.5 MHz bands, the limit for peak output power is 1Watt and the e.i.r.p. shall not exceed 4 W.

If the transmitting antenna of directional gain greater than 6dBi are used the peak output power from the intentional radiator shall be reduced below the above stated value by the amount in dB that the directional gain of the Antenna exceeds 6dBi.

In case of point-to-point operation, the limit has to be reduced by 1dB for every 3dB that the directional gain of Antenna exceeds 6dBi.

Pre-analysis Check: While conducting average power measurement, duty cycle of each mode shall be checked to ensure its duty cycle in order to compensate for the loss due to insufficient ratio of duty cycle.

All duty cycle is pre-scanned, and result as obtained below shows only the most representative ones where duty cycle is conducted as the given transmission with given virtual operation that expresses the percentage.

8.2 Test Setup

8.2.1 Duty Cycle

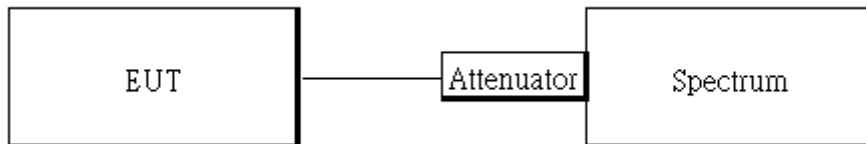

8.2.2 Output Power

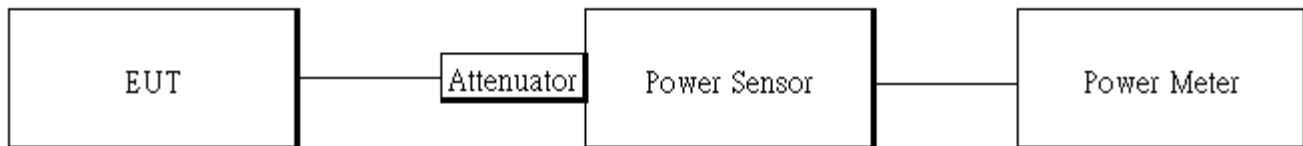

8.3 Measurement Procedure:

8.3.1 Duty Cycle

1. Place the EUT on the table and set it in transmitting mode.
2. Set span = Zero

Unless otherwise stated the results shown in this test report refer only to the sample(s) tested and such sample(s) are retained for 90 days only.
 除非另有說明，此報告結果僅對測試之樣品負責，同時此樣品僅保留90天。本報告未經本公司書面許可，不可部份複製。

This document is issued by the Company subject to its General Conditions of Service printed overleaf, available on request or accessible at <http://www.sgs.com.tw/Terms-and-Conditions> and for electronic format documents, subject to Terms and Conditions for Electronic Documents at <http://www.sgs.com.tw/Terms-and-Conditions>. Attention is drawn to the limitation of liability, indemnification and jurisdiction issues defined therein. Any holder of this document is advised that information contained hereon reflects the Company's findings at the time of its intervention only and within the limits of Client's instructions, if any. The Company's sole responsibility is to its Client and this document does not exonerate parties to a transaction from exercising all their rights and obligations under the transaction documents. This document cannot be reproduced except in full, without prior written approval of the Company. Any unauthorized alteration, forgery or falsification of the content or appearance of this document is unlawful and offenders may be prosecuted to the fullest extent of the law.

3. RBW = 8MHz, VBW = 8MHz,
4. Detector = Peak

8.3.2 Output Power

1. Place the EUT on the table and set it in transmitting mode.
2. The testing follows the Measurement Procedure of FCC KDB 558074 D01 DTS Meas. Guidance.
3. Remove the antenna from the EUT and then connect a low loss RF cable from the antenna port to the power meter.
4. Record the max. Reading as observed from Power Meter.
5. Repeat above procedures until all test default channel measured was complete.

8.4 Duty Factor:

	Duty Cycle (%) = Ton / (Ton+Toff)	Duty Factor (dB) =10*log (1/Duty Cycle)	1/T (kHz)	VBW setting (kHz)
BLE 1M	90.75	0.42	0.47	1.00
BLE 2M	91.03	0.41	0.94	1.00

BLE_1M_LowCH00-2402

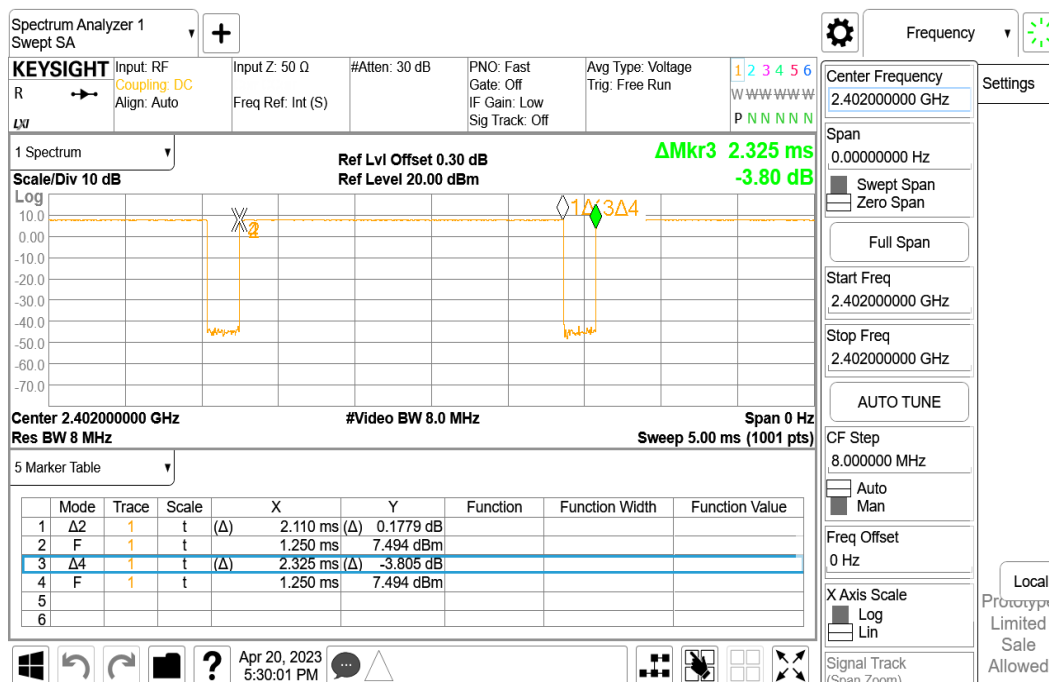

Unless otherwise stated the results shown in this test report refer only to the sample(s) tested and such sample(s) are retained for 90 days only.

除非另有說明，此報告結果僅對測試之樣品負責，同時此樣品僅保留90天。本報告未經本公司書面許可，不可部份複製。
This document is issued by the Company subject to its General Conditions of Service printed overleaf, available on request or accessible at <http://www.sgs.com.tw/Terms-and-Conditions> and for electronic format documents, subject to Terms and Conditions for Electronic Documents at <http://www.sgs.com.tw/Terms-and-Conditions>. Attention is drawn to the limitation of liability, indemnification and jurisdiction issues defined therein. Any holder of this document is advised that information contained herein reflects the Company's findings at the time of its intervention only and within the limits of Client's instructions, if any. The Company's sole responsibility is to its Client and this document does not exonerate parties to a transaction from exercising all their rights and obligations under the transaction documents. This document cannot be reproduced except in full, without prior written approval of the Company. Any unauthorized alteration, forgery or falsification of the content or appearance of this document is unlawful and offenders may be prosecuted to the fullest extent of the law.

BLE_2M_LowCH00-2402

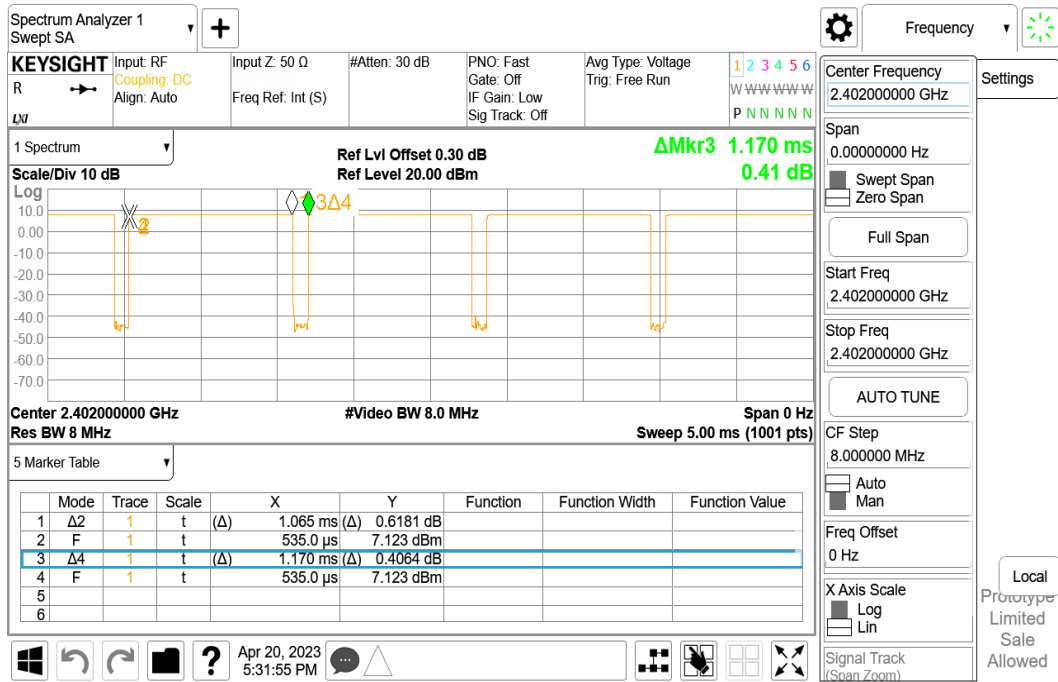

8.5 Output Power:

8.5.1 Peak & Avg

BLE 1M mode:

CH	Frequency (MHz)	Power set	Peak Power Output (dBm)	Required Limit (dBm)
Low	2402	8	7.63	30
Mid	2442	8	7.80	30
High	2480	8	7.83	30
CH	Frequency (MHz)	Power set	Max. Avg. Output include tune up tolerance Power (dBm)	Required Limit (dBm)
Low	2402	8	7.59	30
Mid	2442	8	7.76	30
High	2480	8	7.77	30

**Note: Measured by power meter, cable loss 0.3 dB + Duty cycle factor has been offsetted to the power meter for Avg. power and cable loss has been offsetted for Peak power measurement.*

Unless otherwise stated the results shown in this test report refer only to the sample(s) tested and such sample(s) are retained for 90 days only.

除非另有說明，此報告結果僅對測試之樣品負責，同時此樣品僅保留90天。本報告未經本公司書面許可，不可部份複製。

This document is issued by the Company subject to its General Conditions of Service printed overleaf, available on request or accessible at <http://www.sgs.com.tw/Terms-and-Conditions> and for electronic format documents, subject to Terms and Conditions for Electronic Documents at <http://www.sgs.com.tw/Terms-and-Conditions>. Attention is drawn to the limitation of liability, indemnification and jurisdiction issues defined therein. Any holder of this document is advised that information contained hereon reflects the Company's findings at the time of its intervention only and within the limits of Client's instructions, if any. The Company's sole responsibility is to its Client and this document does not exonerate parties to a transaction from exercising all their rights and obligations under the transaction documents. This document cannot be reproduced except in full, without prior written approval of the Company. Any unauthorized alteration, forgery or falsification of the content or appearance of this document is unlawful and offenders may be prosecuted to the fullest extent of the law.

BLE 2M mode:

CH	Frequency (MHz)	Power set	Peak Power Output (dBm)	Required Limit (dBm)
Low	2402	8	7.83	30
Mid	2442	8	7.79	30
High	2480	8	7.50	30
CH	Frequency (MHz)	Power set	Max. Avg. Output include tune up tolerance Power (dBm)	Required Limit (dBm)
Low	2402	8	7.81	30
Mid	2442	8	7.77	30
High	2480	8	7.50	30

**Note: Measured by power meter, cable loss 0.3 dB + Duty cycle factor has been offsetted to the power meter for Avg. power and cable loss has been offsetted for Peak power measurement.*

8.5.2 EIRP
EIRP BLE 1M mode

CH	Frequency (MHz)	Power set	Max. Avg. Output include tune up tolerance Power (dBm)	Antenna Gain (dBi)	EIRP (dBm)	Limit
Low	2402	8	7.59	3.01	10.60	4W= 36 dBm
Mid	2442	8	7.76	3.01	10.77	4W= 36 dBm
High	2480	8	7.77	3.01	10.78	4W= 36 dBm

* **Note:** EIRP = Average Power + Gain

EIRP BLE 2M mode

CH	Frequency (MHz)	Power set	Max. Avg. Output include tune up tolerance Power (dBm)	Antenna Gain (dBi)	EIRP (dBm)	Limit
Low	2402	8	7.81	3.01	10.82	4W= 36 dBm
Mid	2442	8	7.77	3.01	10.78	4W= 36 dBm
High	2480	8	7.50	3.01	10.51	4W= 36 dBm

* **Note:** EIRP = Average Power + Gain

Unless otherwise stated the results shown in this test report refer only to the sample(s) tested and such sample(s) are retained for 90 days only.

除非另有說明，此報告結果僅對測試之樣品負責，同時此樣品僅保留90天。本報告未經本公司書面許可，不可部份複製。

This document is issued by the Company subject to its General Conditions of Service printed overleaf, available on request or accessible at <http://www.sgs.com.tw/Terms-and-Conditions> and for electronic format documents, subject to Terms and Conditions for Electronic Documents at <http://www.sgs.com.tw/Terms-and-Conditions>. Attention is drawn to the limitation of liability, indemnification and jurisdiction issues defined therein. Any holder of this document is advised that information contained hereon reflects the Company's findings at the time of its intervention only and within the limits of Client's instructions, if any. The Company's sole responsibility is to its Client and this document does not exonerate parties to a transaction from exercising all their rights and obligations under the transaction documents. This document cannot be reproduced except in full, without prior written approval of the Company. Any unauthorized alteration, forgery or falsification of the content or appearance of this document is unlawful and offenders may be prosecuted to the fullest extent of the law.

9 EMISSION BANDWIDTH MEASUREMENT

9.1 Standard Applicable

The minimum 6 dB bandwidth shall be at least 500 kHz .

9.2 Test Setup

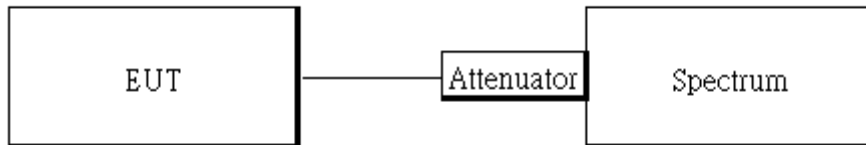

9.3 Measurement Procedure:

1. Place the EUT on the table and set it in transmitting mode.
2. Remove the antenna from the EUT and then connect a low loss RF cable from the antenna port to the spectrum analyzer.

9.3.1 FCC measurements

1. The testing follows the Measurement Procedure of the KDB 558074 D01.
2. Set the spectrum analyzer as
 RBW= 100 kHz ,
 VBW = 3 X RBW,
 Span= 2 to 5 times of the OBW,
 Sweep=auto, Detector = Peak, and Max hold.
3. Mark the upper and lower frequencies of -6dB.
4. Repeat above procedures until all test default channel is completed.

9.3.2 ISED measurements

1. The testing follows the Measurement Procedure of the RSS-Gen section 6.7.
2. Set the spectrum analyzer as
 RBW= 1 % to 5% of 99% and -6dB Bandwidth ,
 VBW \geq 3 X RBW,
 Span= large enough to capture all products of the modulation process
 Sweep=auto, Detector = Peak, and Max hold.
3. Mark the upper and lower frequencies of 99% and -6dB.
4. Repeat above procedures until all test default channel is completed.

Unless otherwise stated the results shown in this test report refer only to the sample(s) tested and such sample(s) are retained for 90 days only.
 除非另有說明，此報告結果僅對測試之樣品負責，同時此樣品僅保留90天。本報告未經本公司書面許可，不可部份複製。

This document is issued by the Company subject to its General Conditions of Service printed overleaf, available on request or accessible at <http://www.sgs.com.tw/Terms-and-Conditions> and for electronic format documents, subject to Terms and Conditions for Electronic Documents at <http://www.sgs.com.tw/Terms-and-Conditions>. Attention is drawn to the limitation of liability, indemnification and jurisdiction issues defined therein. Any holder of this document is advised that information contained hereon reflects the Company's findings at the time of its intervention only and within the limits of Client's instructions, if any. The Company's sole responsibility is to its Client and this document does not exonerate parties to a transaction from exercising all their rights and obligations under the transaction documents. This document cannot be reproduced except in full, without prior written approval of the Company. Any unauthorized alteration, forgery or falsification of the content or appearance of this document is unlawful and offenders may be prosecuted to the fullest extent of the law.

9.4 Measurement Result:

BLE 1M mode

Frequency (MHz)	6dB BW (MHz)	Required BW (MHz)	Result
2402	0.7321	≥ 0.5	PASS
2442	0.7332	≥ 0.5	PASS
2480	0.7311	≥ 0.5	PASS

BLE 2M mode

Frequency (MHz)	6dB BW (MHz)	Required BW (MHz)	Result
2402	1.175	≥ 0.5	PASS
2442	1.179	≥ 0.5	PASS
2480	1.16	≥ 0.5	PASS

BLE 1M mode

Frequency (MHz)	99%Bandwidth (MHz)
2402	1.0613
2442	1.0627
2480	1.0631

BLE 2M mode

Frequency (MHz)	99%Bandwidth (MHz)
2402	2.0486
2442	2.0632
2480	2.0903

Unless otherwise stated the results shown in this test report refer only to the sample(s) tested and such sample(s) are retained for 90 days only.

除非另有說明，此報告結果僅對測試之樣品負責，同時此樣品僅保留90天。本報告未經本公司書面許可，不可部份複製。
 This document is issued by the Company subject to its General Conditions of Service printed overleaf, available on request or accessible at <http://www.sgs.com.tw/Terms-and-Conditions> and for electronic format documents, subject to Terms and Conditions for Electronic Documents at <http://www.sgs.com.tw/Terms-and-Conditions>. Attention is drawn to the limitation of liability, indemnification and jurisdiction issues defined therein. Any holder of this document is advised that information contained hereon reflects the Company's findings at the time of its intervention only and within the limits of Client's instructions, if any. The Company's sole responsibility is to its Client and this document does not exonerate parties to a transaction from exercising all their rights and obligations under the transaction documents. This document cannot be reproduced except in full, without prior written approval of the Company. Any unauthorized alteration, forgery or falsification of the content or appearance of this document is unlawful and offenders may be prosecuted to the fullest extent of the law.

OBW_BLE 1M_LowCH00-2402MHz



OBW_BLE 2M_LowCH00-2402MHz



OBW_BLE 1M_MidCH20-2442MHz



OBW_BLE 2M_MidCH20-2442MHz



OBW_BLE 1M_HighCH39-2480MHz



OBW_BLE 2M_HighCH39-2480MHz



Unless otherwise stated the results shown in this test report refer only to the sample(s) tested and such sample(s) are retained for 90 days only.

除非另有說明，此報告結果僅對測試之樣品負責，同時此樣品僅保留90天。本報告未經本公司書面許可，不可部份複製。

This document is issued by the Company subject to its General Conditions of Service printed overleaf, available on request or accessible at <http://www.sgs.com.tw/Terms-and-Conditions> and for electronic format documents, subject to Terms and Conditions for Electronic Documents at <http://www.sgs.com.tw/Terms-and-Conditions>. Attention is drawn to the limitation of liability, indemnification and jurisdiction issues defined therein. Any holder of this document is advised that information contained hereon reflects the Company's findings at the time of its intervention only and within the limits of Client's instructions, if any. The Company's sole responsibility is to its Client and this document does not exonerate parties to a transaction from exercising all their rights and obligations under the transaction documents. This document cannot be reproduced except in full, without prior written approval of the Company. Any unauthorized alteration, forgery or falsification of the content or appearance of this document is unlawful and offenders may be prosecuted to the fullest extent of the law.

IC OBW_BLE 1M_LowCH00-2402MHz

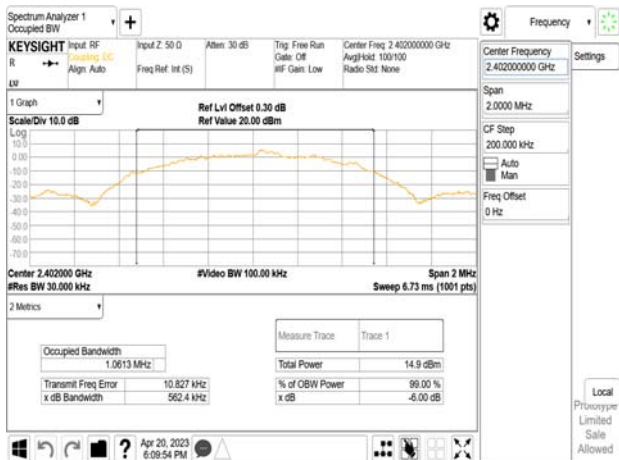

IC OBW_BLE 2M_LowCH00-2402MHz



IC OBW_BLE 1M_MidCH20-2442MHz



IC OBW_BLE 2M_MidCH20-2442MHz



IC OBW_BLE 1M_HighCH39-2480MHz



IC OBW_BLE 2M_HighCH39-2480MHz

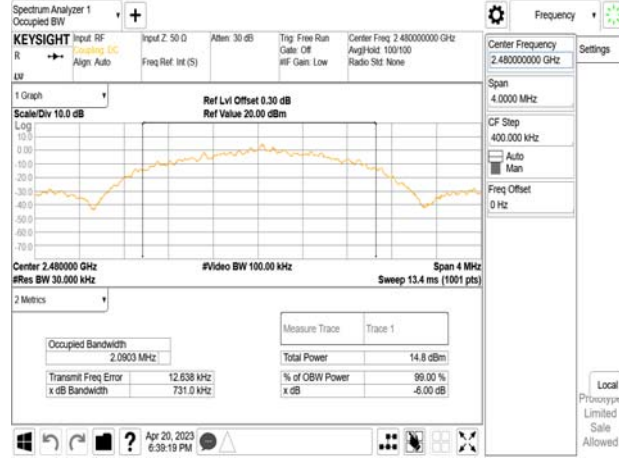

Unless otherwise stated the results shown in this test report refer only to the sample(s) tested and such sample(s) are retained for 90 days only.

除非另有說明，此報告結果僅對測試之樣品負責，同時此樣品僅保留90天。本報告未經本公司書面許可，不可部份複製。

This document is issued by the Company subject to its General Conditions of Service printed overleaf, available on request or accessible at <http://www.sgs.com.tw/Terms-and-Conditions> and for electronic format documents, subject to Terms and Conditions for Electronic Documents at <http://www.sgs.com.tw/Terms-and-Conditions>. Attention is drawn to the limitation of liability, indemnification and jurisdiction issues defined therein. Any holder of this document is advised that information contained hereon reflects the Company's findings at the time of its intervention only and within the limits of Client's instructions, if any. The Company's sole responsibility is to its Client and this document does not exonerate parties to a transaction from exercising all their rights and obligations under the transaction documents. This document cannot be reproduced except in full, without prior written approval of the Company. Any unauthorized alteration, forgery or falsification of the content or appearance of this document is unlawful and offenders may be prosecuted to the fullest extent of the law.

10 CONDUCTED BAND EDGES AND SPURIOUS EMISSION MEASUREMENT

10.1 Standard Applicable

In any 100 kHz bandwidth outside the frequency band in which the spread spectrum or digitally modulated intentional radiator is operating, the radio frequency power that is produced by the intentional radiator shall be at least 20 dB below that in the 100 kHz bandwidth within the band that contains the highest level of the desired power, based on either an RF conducted or a radiated measurement, provided the transmitter demonstrates compliance with the peak conducted power limits. In addition, radiated emissions which fall in the restricted bands, as defined in §15.205(a) & RSS-Gen §8.10, must also comply with the radiated emission limits specified in §15.209(a) & RSS-Gen §8.9.

10.2 Test Setup

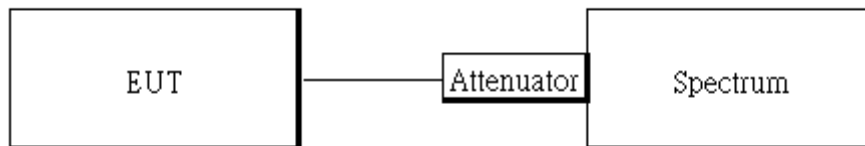

10.3 Measurement Procedure

10.3.1 Reference Level of Emission Limit:

1. Set analyzer center frequency to DTS channel center frequency.
2. The testing follows the Measurement Procedure of FCC KDB 558074 D01 DTS Meas. Guidance.
3. Set the span to 1.5 times the DTS channel bandwidth.
4. Set the RBW = 100kHz & VBW = 300 kHz.
5. Detector = peak.
6. Sweep time = auto couple.
7. Trace mode = max hold.
8. Allow trace to fully stabilize.
9. Use the peak marker function to determine the maximum amplitude level.

10.3.2 Conducted Band Edge:

1. To connect Antenna Port of EUT to Spectrum.
2. The testing follows the Measurement Procedure of FCC KDB 558074 D01 DTS Meas. Guidance.
3. Remove the antenna from the EUT and then connect a low loss RF cable from the antenna port to the spectrum analyzer.

Unless otherwise stated the results shown in this test report refer only to the sample(s) tested and such sample(s) are retained for 90 days only.
除非另有說明，此報告結果僅對測試之樣品負責，同時此樣品僅保留90天。本報告未經本公司書面許可，不可部份複製。

This document is issued by the Company subject to its General Conditions of Service printed overleaf, available on request or accessible at <http://www.sgs.com.tw/Terms-and-Conditions> and for electronic format documents, subject to Terms and Conditions for Electronic Documents at <http://www.sgs.com.tw/Terms-and-Conditions>. Attention is drawn to the limitation of liability, indemnification and jurisdiction issues defined therein. Any holder of this document is advised that information contained hereon reflects the Company's findings at the time of its intervention only and within the limits of Client's instructions, if any. The Company's sole responsibility is to its Client and this document does not exonerate parties to a transaction from exercising all their rights and obligations under the transaction documents. This document cannot be reproduced except in full, without prior written approval of the Company. Any unauthorized alteration, forgery or falsification of the content or appearance of this document is unlawful and offenders may be prosecuted to the fullest extent of the law.

4. Set start to edge frequency, and stop frequency of spectrum analyzer so as to encompass the spectrum to be examined.
5. Set the spectrum analyzer as RBW=100 kHz, VBW=300 kHz, Detector = Peak, Sweep = auto
6. Set DL as the limit = reading on marker of reference level measurement – 20dBm
7. Mark the highest readings of the emissions outside of 2400MHz~2483.5MHz.
8. Repeat above procedures until all default test channel (low and high) was complete.

10.3.3 Conducted Spurious Emission:

1. To connect Antenna Port of EUT to Spectrum.
2. The testing follows the Measurement Procedure of FCC KDB 558074 D01 DTS Meas. Guidance.
3. Set RBW = 100 kHz & VBW=300 kHz, Detector =Peak, Sweep = Auto
4. Allow trace to fully stabilize.
5. Use the peak marker function to determine the maximum power level in any 100 kHz band segment within the fundamental EBW.
6. Repeat above procedures until all default test channel measured were complete.

10.4 Measurement Result

BLE 1M_Reference Level of Limit

Frequency (MHz)	RF Power Density (dBm)	Reference Level of Limit = PSD - 20dB (dBm)
2402	7.33	-12.67
2442	7.45	-12.55
2480	7.32	-12.68

NOTE: cable loss as 0.3dB that offsets in the spectrum

NOTE: Refer to next page for plots.

BLE 2M_Reference Level of Limit

Frequency (MHz)	RF Power Density (dBm)	Reference Level of Limit = PSD - 20dB (dBm)
2402	7.34	-12.66
2442	7.49	-12.51
2480	7.28	-12.72

NOTE: cable loss as 0.3dB that offsets in the spectrum

NOTE: Refer to next page for plots.

Unless otherwise stated the results shown in this test report refer only to the sample(s) tested and such sample(s) are retained for 90 days only.

除非另有說明，此報告結果僅對測試之樣品負責，同時此樣品僅保留90天。本報告未經本公司書面許可，不可部份複製。

This document is issued by the Company subject to its General Conditions of Service printed overleaf, available on request or accessible at <http://www.sgs.com.tw/Terms-and-Conditions> and for electronic format documents, subject to Terms and Conditions for Electronic Documents at <http://www.sgs.com.tw/Terms-and-Conditions>. Attention is drawn to the limitation of liability, indemnification and jurisdiction issues defined therein. Any holder of this document is advised that information contained hereon reflects the Company's findings at the time of its intervention only and within the limits of Client's instructions, if any. The Company's sole responsibility is to its Client and this document does not exonerate parties to a transaction from exercising all their rights and obligations under the transaction documents. This document cannot be reproduced except in full, without prior written approval of the Company. Any unauthorized alteration, forgery or falsification of the content or appearance of this document is unlawful and offenders may be prosecuted to the fullest extent of the law.

Reference Level_BLE 1M_LowCH00-2402MHz

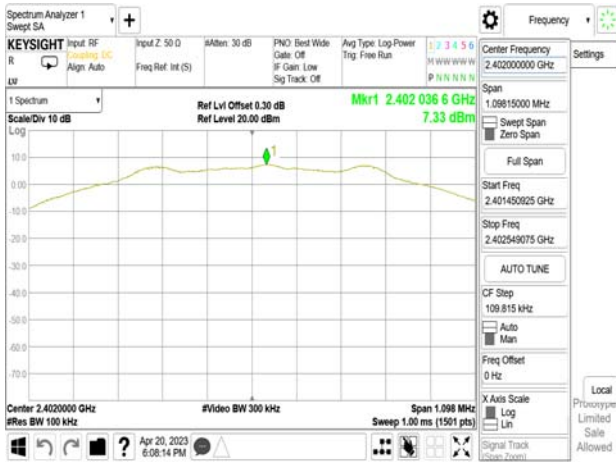

Reference Level_BLE 2M_LowCH00-2402MHz

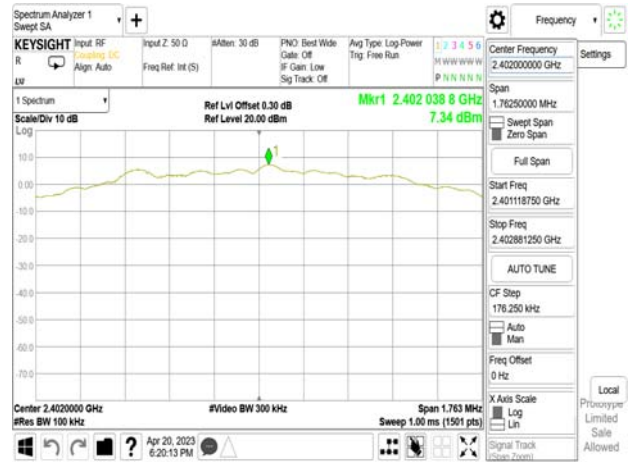

Reference Level_BLE 1M_MidCH20-2442MHz



Reference Level_BLE 2M_MidCH20-2442MHz

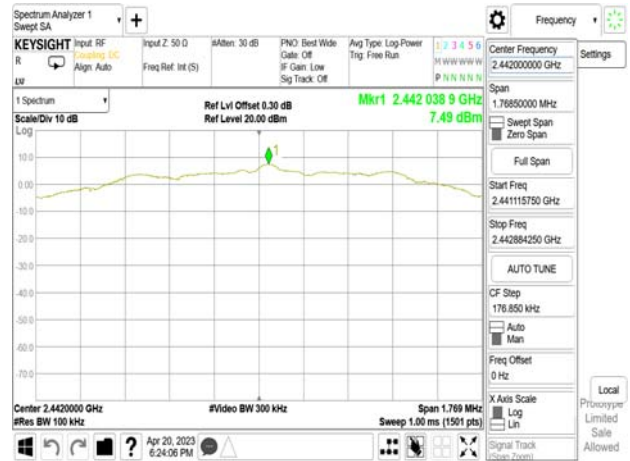

Reference Level_BLE 1M_HighCH39-2480MHz



Reference Level_BLE 2M_HighCH39-2480MHz



Unless otherwise stated the results shown in this test report refer only to the sample(s) tested and such sample(s) are retained for 90 days only.

除非另有說明，此報告結果僅對測試之樣品負責，同時此樣品僅保留90天。本報告未經本公司書面許可，不可部份複製。

This document is issued by the Company subject to its General Conditions of Service printed overleaf, available on request or accessible at <http://www.sgs.com.tw/Terms-and-Conditions> and for electronic format documents, subject to Terms and Conditions for Electronic Documents at <http://www.sgs.com.tw/Terms-and-Conditions>. Attention is drawn to the limitation of liability, indemnification and jurisdiction issues defined therein. Any holder of this document is advised that information contained hereon reflects the Company's findings at the time of its intervention only and within the limits of Client's instructions, if any. The Company's sole responsibility is to its Client and this document does not exonerate parties to a transaction from exercising all their rights and obligations under the transaction documents. This document cannot be reproduced except in full, without prior written approval of the Company. Any unauthorized alteration, forgery or falsification of the content or appearance of this document is unlawful and offenders may be prosecuted to the fullest extent of the law.

Band Edge_BLE 1M_LowCH00-2402MHz

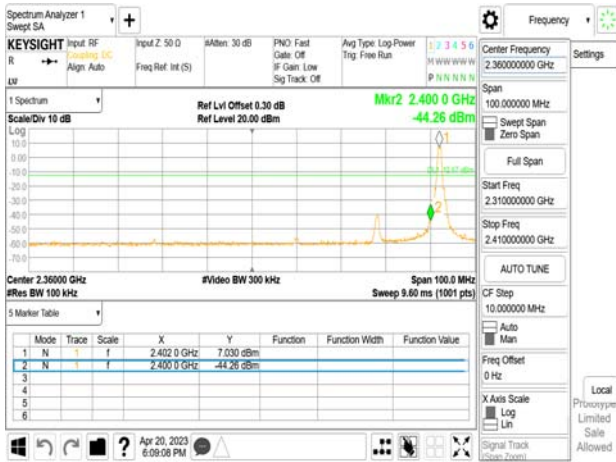

Band Edge_BLE 2M_HighCH39-2480MHz

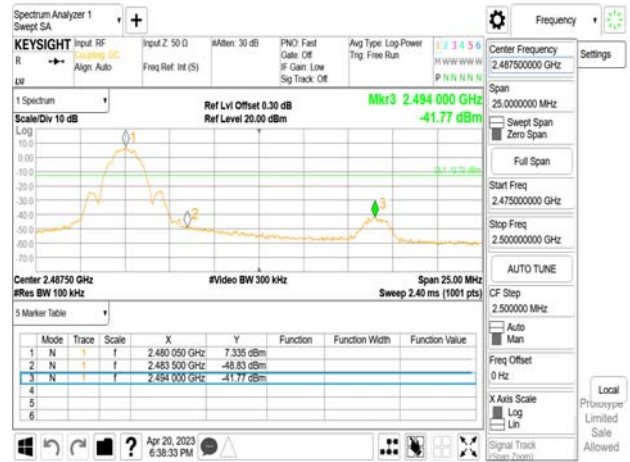

Band Edge_BLE 1M_HighCH39-2480MHz

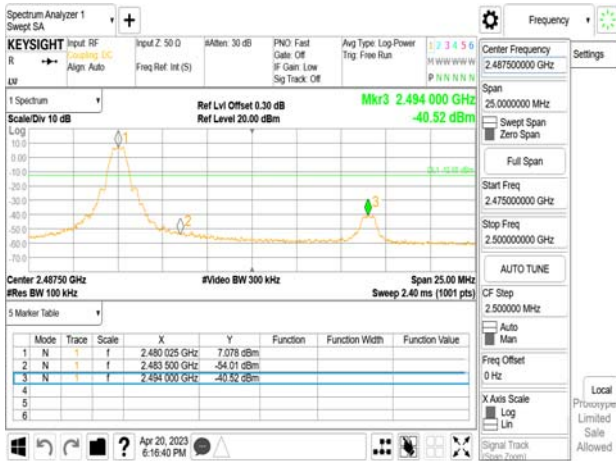

Band Edge_BLE 2M_LowCH00-2402MHz



Unless otherwise stated the results shown in this test report refer only to the sample(s) tested and such sample(s) are retained for 90 days only.

除非另有說明，此報告結果僅對測試之樣品負責，同時此樣品僅保留90天。本報告未經本公司書面許可，不可部份複製。

This document is issued by the Company subject to its General Conditions of Service printed overleaf, available on request or accessible at <http://www.sgs.com.tw/Terms-and-Conditions> and for electronic format documents, subject to Terms and Conditions for Electronic Documents at <http://www.sgs.com.tw/Terms-and-Conditions>. Attention is drawn to the limitation of liability, indemnification and jurisdiction issues defined therein. Any holder of this document is advised that information contained hereon reflects the Company's findings at the time of its intervention only and within the limits of Client's instructions, if any. The Company's sole responsibility is to its Client and this document does not exonerate parties to a transaction from exercising all their rights and obligations under the transaction documents. This document cannot be reproduced except in full, without prior written approval of the Company. Any unauthorized alteration, forgery or falsification of the content or appearance of this document is unlawful and offenders may be prosecuted to the fullest extent of the law.

Spurious Emission_BLE 1M_LowCH00-2402MHz



Spurious Emission_BLE 2M_LowCH00-2402MHz



Spurious Emission_BLE 1M_MidCH20-2442MHz



Spurious Emission_BLE 2M_MidCH20-2442MHz



Spurious Emission_BLE 1M_HighCH39-2480MHz

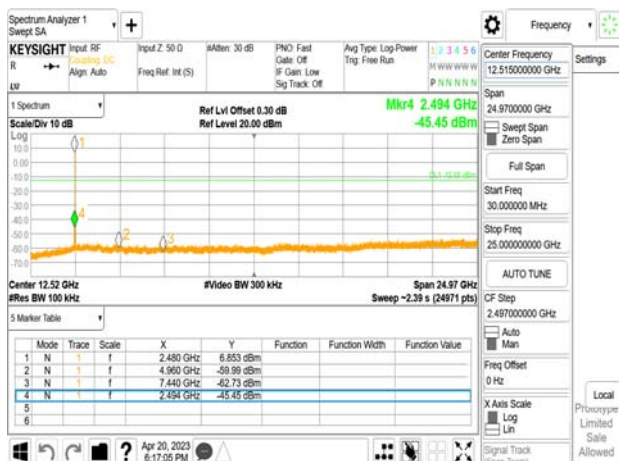

Spurious Emission_BLE 2M_HighCH39-2480MHz



Unless otherwise stated the results shown in this test report refer only to the sample(s) tested and such sample(s) are retained for 90 days only.

除非另有說明，此報告結果僅對測試之樣品負責，同時此樣品僅保留90天。本報告未經本公司書面許可，不可部份複製。

This document is issued by the Company subject to its General Conditions of Service printed overleaf, available on request or accessible at <http://www.sgs.com.tw/Terms-and-Conditions> and for electronic format documents, subject to Terms and Conditions for Electronic Documents at <http://www.sgs.com.tw/Terms-and-Conditions>. Attention is drawn to the limitation of liability, indemnification and jurisdiction issues defined therein. Any holder of this document is advised that information contained hereon reflects the Company's findings at the time of its intervention only and within the limits of Client's instructions, if any. The Company's sole responsibility is to its Client and this document does not exonerate parties to a transaction from exercising all their rights and obligations under the transaction documents. This document cannot be reproduced except in full, without prior written approval of the Company. Any unauthorized alteration, forgery or falsification of the content or appearance of this document is unlawful and offenders may be prosecuted to the fullest extent of the law.

11 RADIATED BANDEDGE AND SPURIOUS EMISSION MEASUREMENT

11.1 Standard Applicable

In any 100 kHz bandwidth outside the frequency band in which the spread spectrum or digitally modulated intentional radiator is operating, the radio frequency power that is produced by the intentional radiator shall be at least 20 dB below that in the 100 kHz bandwidth within the band that contains the highest level of the desired power, based on either an RF conducted or a radiated measurement, provided the transmitter demonstrates compliance with the peak conducted power limits. In addition, radiated emissions which fall in the restricted bands must also comply with the §15.209 and RSS-Gen §8.9 Table 5 and 6 limit as below.

And according to §15.33(a) (1) & RSS-Gen §6.13.2.a for an intentional radiator operates below 10GHz, the frequency range of measurements: to the tenth harmonic of the highest fundamental frequency or to 40GHz, whichever is lower.

Frequency (MHz)	Field strength (microvolts/meter)	Distance (meters)
0.009-0.490	2400/F(kHz)	300
0.490-1.705	24000/F(kHz)	30
1.705-30	30	30
30-88	100	3
88-216	150	3
216-960	200	3
Above 960	500	3

Note: The lower limit shall apply at the transition frequencies.

11.2 Test Setup

(A) Radiated Emission Test Set-Up, Frequency Below 30MHz.

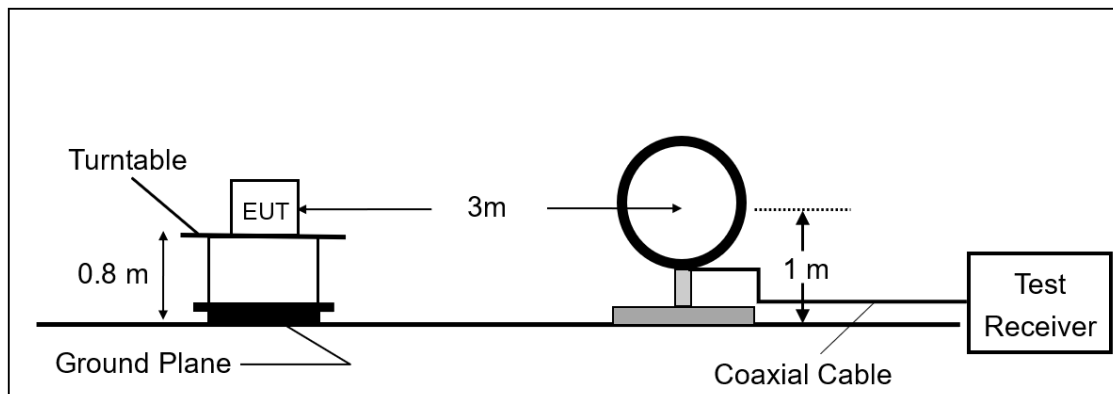

Unless otherwise stated the results shown in this test report refer only to the sample(s) tested and such sample(s) are retained for 90 days only.
 除非另有說明，此報告結果僅對測試之樣品負責，同時此樣品僅保留90天。本報告未經本公司書面許可，不可部份複製。

This document is issued by the Company subject to its General Conditions of Service printed overleaf, available on request or accessible at <http://www.sgs.com.tw/Terms-and-Conditions> and for electronic format documents, subject to Terms and Conditions for Electronic Documents at <http://www.sgs.com.tw/Terms-and-Conditions>. Attention is drawn to the limitation of liability, indemnification and jurisdiction issues defined therein. Any holder of this document is advised that information contained hereon reflects the Company's findings at the time of its intervention only and within the limits of Client's instructions, if any. The Company's sole responsibility is to its Client and this document does not exonerate parties to a transaction from exercising all their rights and obligations under the transaction documents. This document cannot be reproduced except in full, without prior written approval of the Company. Any unauthorized alteration, forgery or falsification of the content or appearance of this document is unlawful and offenders may be prosecuted to the fullest extent of the law.

(B) Radiated Emission Test Set-Up, Frequency From 30MHz to 1000MHz.

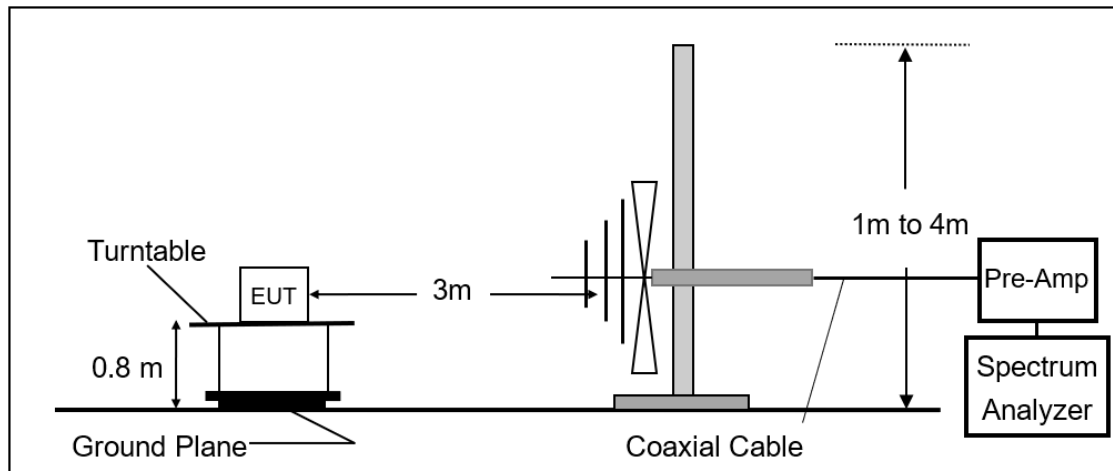

(C) Radiated Emission Test Set-Up, Frequency Above 1GHz.

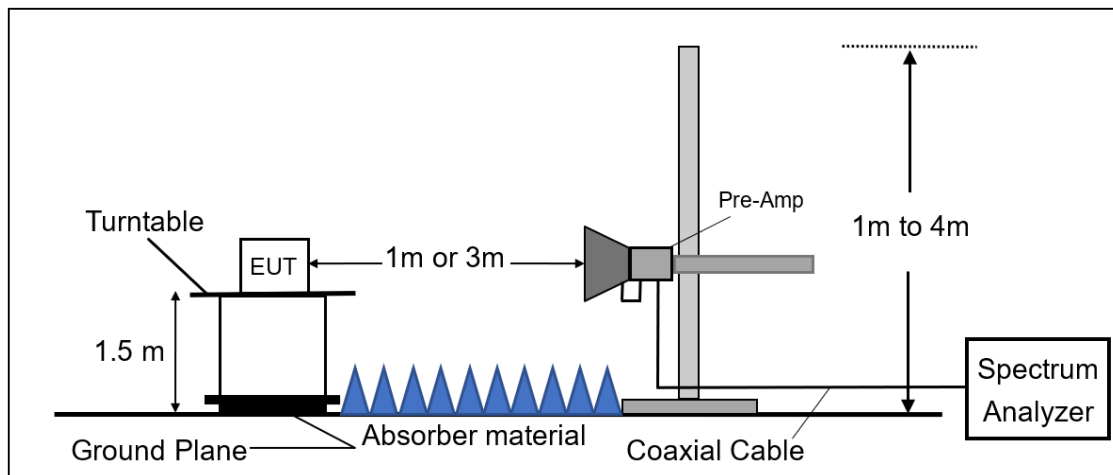

11.3 Measurement Procedure

1. The testing follows the Measurement Procedure of FCC KDB 558074 D01 DTS Meas. Guidance.
2. The EUT was placed on a turn table with 0.8m for frequency < 1GHz and 1.5m for frequency > 1GHz above ground plane.
3. The turn table shall rotate 360 degrees to determine the position of maximum emission level.
4. EUT is set 3m away from the receiving antenna which varied from 1m to 4m to find out the highest emissions.
5. Set the spectrum analyzer as RBW=100 kHz and VBW=300 kHz for Peak Detector (PK) at frequency between 30MHz and 1 GHz.
6. Use receiver mode as RBW=120 kHz for Quasi-peak (QP) at frequency between 30MHz and 1 GHz.

Unless otherwise stated the results shown in this test report refer only to the sample(s) tested and such sample(s) are retained for 90 days only.
 除非另有說明，此報告結果僅對測試之樣品負責，同時此樣品僅保留90天。本報告未經本公司書面許可，不可部份複製。

This document is issued by the Company subject to its General Conditions of Service printed overleaf, available on request or accessible at <http://www.sgs.com.tw/Terms-and-Conditions> and for electronic format documents, subject to Terms and Conditions for Electronic Documents at <http://www.sgs.com.tw/Terms-and-Conditions>. Attention is drawn to the limitation of liability, indemnification and jurisdiction issues defined therein. Any holder of this document is advised that information contained herein reflects the Company's findings at the time of its intervention only and within the limits of Client's instructions, if any. The Company's sole responsibility is to its Client and this document does not exonerate parties to a transaction from exercising all their rights and obligations under the transaction documents. This document cannot be reproduced except in full, without prior written approval of the Company. Any unauthorized alteration, forgery or falsification of the content or appearance of this document is unlawful and offenders may be prosecuted to the fullest extent of the law.

7. Set the spectrum analyzer as RBW=1 MHz, VBW=3 MHz for Maximum Emission Measurements at frequency above 1 GHz.
8. Set the spectrum analyzer as RBW=1 MHz, VBW=10 Hz (Duty cycle > 98%) or VBW ≥ 1/T (Duty cycle < 98%) for Average Emission Measurements at frequency above 1 GHz.
9. When measurement procedures for electric field radiated emissions above 1 GHz the EUT measurement is to be made “while keeping the antenna in the ‘cone of radiation’ from that area and pointed at the area both in azimuth and elevation, with polarization oriented for maximum response.” is still within the 3dB illumination BW of the measurement antenna.
10. Maximum procedure was performed on the six highest emissions to ensure EUT compliance.
11. And also, each emission was to be maximized by changing the polarization of receiving antenna both horizontal and vertical.
12. Repeat above procedures until all default test channel measured were complete.

11.4 Field Strength Calculation

The field strength is calculated by adding the Antenna Factor and Cable Factor and subtracting the Amplifier Gain and Duty Cycle Correction Factor (if any) from the measured reading. The basic equation with a sample calculation is as follows:

$$FS = RA + AF + CL - AG$$

Where *FS = Field Strength* *CL = Cable Attenuation Factor (Cable Loss)*
RA = Reading Amplitude *AG = Amplifier Gain*
AF = Antenna Factor

*The limit of the emission level is expressed in dBuV/m, which converts 20*log(uV/m)*

Actual FS(dBμV/m) = SPA. Reading level(dBμV) + Factor(dB)

Factor(dB) = Antenna Factor(dBμV/m) + Cable Loss(dB) – Pre_Amplifier Gain(dB)

11.5 Test Results of Radiated Spurious Emissions from 9 kHz to 30 MHz

The low frequency, which started from 9 kHz to 30MHz, was pre-scanned and the result which was 20dB lower than the limit per 15.31(o) & RSS-GEN §6.13.2 was not reported.

Unless otherwise stated the results shown in this test report refer only to the sample(s) tested and such sample(s) are retained for 90 days only.
 除非另有說明，此報告結果僅對測試之樣品負責，同時此樣品僅保留90天。本報告未經本公司書面許可，不可部份複製。

This document is issued by the Company subject to its General Conditions of Service printed overleaf, available on request or accessible at <http://www.sgs.com.tw/Terms-and-Conditions> and for electronic format documents, subject to Terms and Conditions for Electronic Documents at <http://www.sgs.com.tw/Terms-and-Conditions>. Attention is drawn to the limitation of liability, indemnification and jurisdiction issues defined therein. Any holder of this document is advised that information contained hereon reflects the Company's findings at the time of its intervention only and within the limits of Client's instructions, if any. The Company's sole responsibility is to its Client and this document does not exonerate parties to a transaction from exercising all their rights and obligations under the transaction documents. This document cannot be reproduced except in full, without prior written approval of the Company. Any unauthorized alteration, forgery or falsification of the content or appearance of this document is unlawful and offenders may be prosecuted to the fullest extent of the law.

11.6 Measurement Result:

11.6.1 Radiated Band Edge Measurement Result

Report Number	:TERF2304000923ER	Test Site	:SAC 2
Operation Mode	:BLE 1M	Test Date	:2023-04-28
Test Frequency	:2402 MHz	Temp./Humi.	:25.4/63
Test Mode	:Bandedge	Antenna Pol.	:Vertical
EUT Pol	:E2 Plane	Engineer	:Ricky Chen

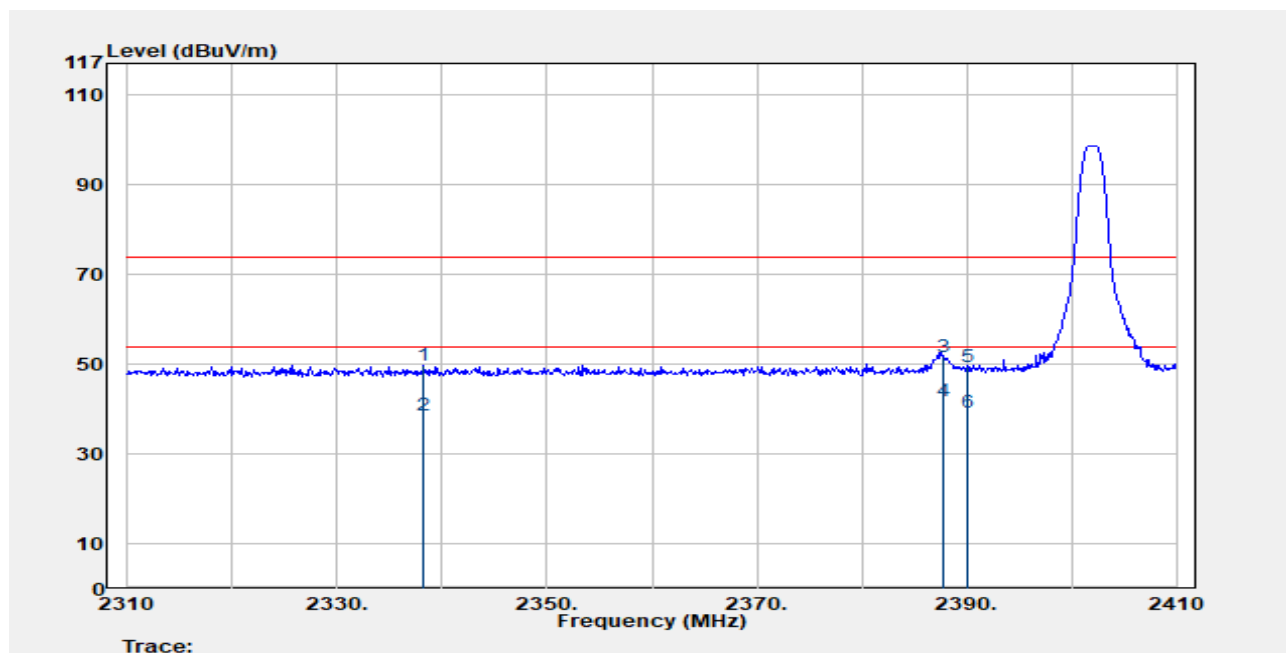

Freq. MHz	Detector Mode PK/QP/AV	Spectrum Reading Level dB μ V	Factor dB	Actual FS dB μ V/m	Limit @3m dB μ V/m	Margin dB
2338.200	Peak	54.11	-4.37	49.74	74.00	-24.26
2338.200	Average	43.05	-4.37	38.68	54.00	-15.32
2387.700	Peak	55.75	-4.18	51.57	74.00	-22.43
2387.700	Average	46.07	-4.18	41.89	54.00	-12.11
2390.000	Peak	53.51	-4.17	49.35	74.00	-24.65
2390.000	Average	43.49	-4.17	39.32	54.00	-14.68

Unless otherwise stated the results shown in this test report refer only to the sample(s) tested and such sample(s) are retained for 90 days only.

除非另有說明，此報告結果僅對測試之樣品負責，同時此樣品僅保留90天。本報告未經本公司書面許可，不可部份複製。

This document is issued by the Company subject to its General Conditions of Service printed overleaf, available on request or accessible at <http://www.sgs.com.tw/Terms-and-Conditions> and for electronic format documents, subject to Terms and Conditions for Electronic Documents at <http://www.sgs.com.tw/Terms-and-Conditions>. Attention is drawn to the limitation of liability, indemnification and jurisdiction issues defined therein. Any holder of this document is advised that information contained hereon reflects the Company's findings at the time of its intervention only and within the limits of Client's instructions, if any. The Company's sole responsibility is to its Client and this document does not exonerate parties to a transaction from exercising all their rights and obligations under the transaction documents. This document cannot be reproduced except in full, without prior written approval of the Company. Any unauthorized alteration, forgery or falsification of the content or appearance of this document is unlawful and offenders may be prosecuted to the fullest extent of the law.

Report Number :TERF2304000923ER
 Operation Mode :BLE 1M
 Test Frequency :2402 MHz
 Test Mode :Bandedge
 EUT Pol :E2 Plane

Test Site :SAC 2
 Test Date :2023-04-28
 Temp./Humi. :25.4/63
 Antenna Pol. :Horizontal
 Engineer :Ricky Chen

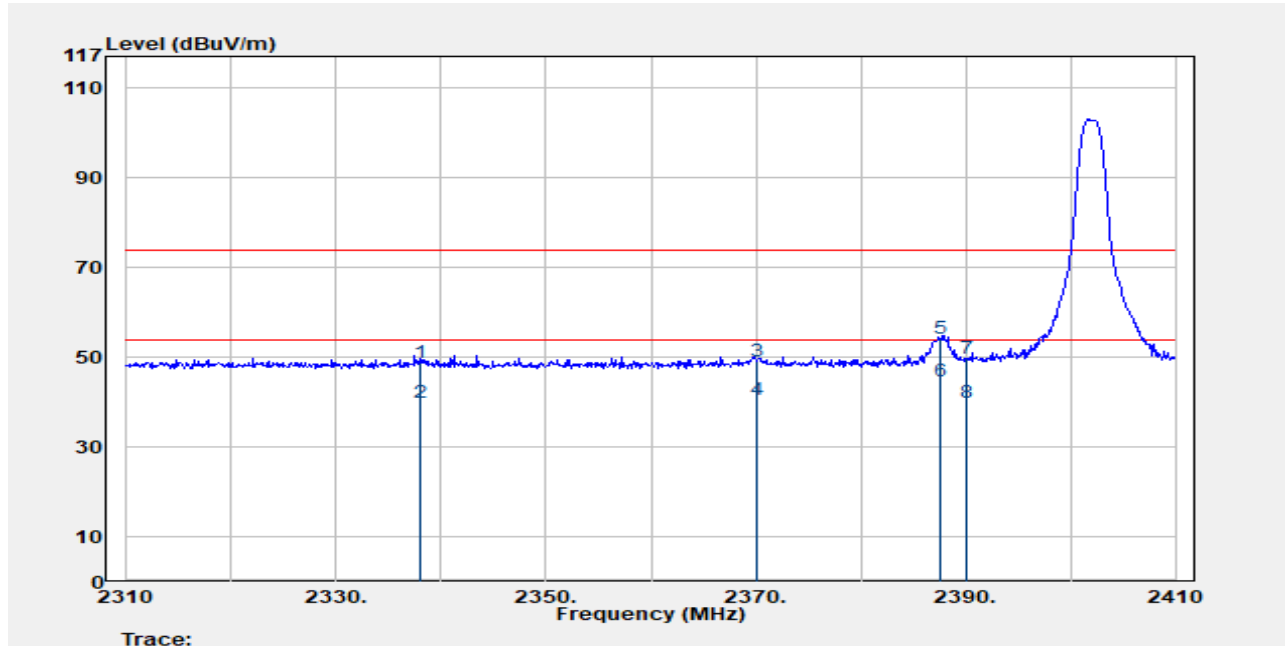

Freq. MHz	Detector Mode PK/QP/AV	Spectrum Reading Level dBμV	Factor dB	Actual FS dBμV/m	Limit @3m dBμV/m	Margin dB
2338.000	Peak	53.19	-4.37	48.82	74.00	-25.18
2338.000	Average	44.19	-4.37	39.82	54.00	-14.18
2370.100	Peak	53.49	-4.28	49.21	74.00	-24.79
2370.100	Average	44.72	-4.28	40.44	54.00	-13.56
2387.500	Peak	58.30	-4.18	54.12	74.00	-19.88
2387.500	Average	48.96	-4.18	44.78	54.00	-9.22
2390.000	Peak	53.93	-4.17	49.76	74.00	-24.24
2390.000	Average	44.14	-4.17	39.97	54.00	-14.03

Unless otherwise stated the results shown in this test report refer only to the sample(s) tested and such sample(s) are retained for 90 days only.

除非另有說明，此報告結果僅對測試之樣品負責，同時此樣品僅保留90天。本報告未經本公司書面許可，不可部份複製。

This document is issued by the Company subject to its General Conditions of Service printed overleaf, available on request or accessible at <http://www.sgs.com.tw/Terms-and-Conditions> and for electronic format documents, subject to Terms and Conditions for Electronic Documents at <http://www.sgs.com.tw/Terms-and-Conditions>. Attention is drawn to the limitation of liability, indemnification and jurisdiction issues defined therein. Any holder of this document is advised that information contained hereon reflects the Company's findings at the time of its intervention only and within the limits of Client's instructions, if any. The Company's sole responsibility is to its Client and this document does not exonerate parties to a transaction from exercising all their rights and obligations under the transaction documents. This document cannot be reproduced except in full, without prior written approval of the Company. Any unauthorized alteration, forgery or falsification of the content or appearance of this document is unlawful and offenders may be prosecuted to the fullest extent of the law.

Report Number :TERF2304000923ER
 Operation Mode :BLE 1M
 Test Frequency :2480 MHz
 Test Mode :Bandedge
 EUT Pol :E2 Plane

Test Site :SAC 2
 Test Date :2023-04-28
 Temp./Humi. :25.4/63
 Antenna Pol. :Vertical
 Engineer :Ricky Chen

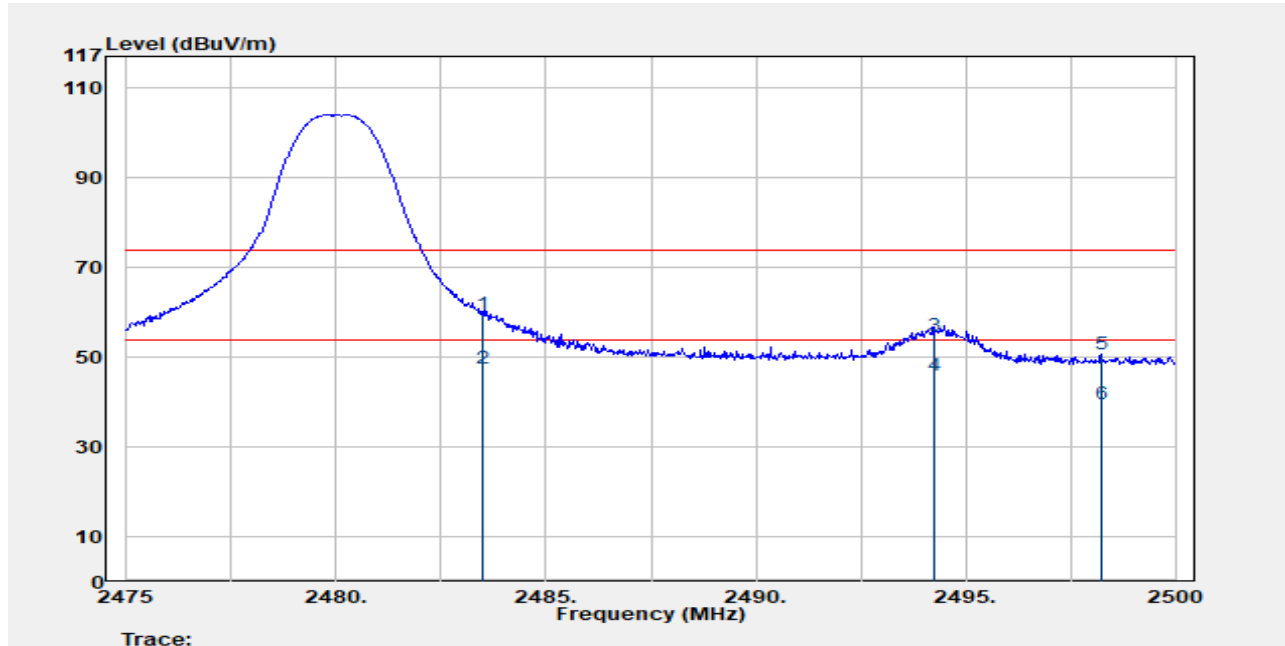

Freq. MHz	Detector Mode PK/QP/AV	Spectrum Reading Level dBμV	Factor dB	Actual FS dBμV/m	Limit @3m dBμV/m	Margin dB
2483.500	Peak	63.96	-4.26	59.70	74.00	-14.30
2483.500	Average	51.78	-4.26	47.52	54.00	-6.48
2494.275	Peak	59.06	-4.17	54.89	74.00	-19.11
2494.275	Average	50.10	-4.17	45.93	54.00	-8.07
2498.225	Peak	54.98	-4.14	50.84	74.00	-23.16
2498.225	Average	43.79	-4.14	39.65	54.00	-14.35

Unless otherwise stated the results shown in this test report refer only to the sample(s) tested and such sample(s) are retained for 90 days only.

除非另有說明，此報告結果僅對測試之樣品負責，同時此樣品僅保留90天。本報告未經本公司書面許可，不可部份複製。

This document is issued by the Company subject to its General Conditions of Service printed overleaf, available on request or accessible at <http://www.sgs.com.tw/Terms-and-Conditions> and for electronic format documents, subject to Terms and Conditions for Electronic Documents at <http://www.sgs.com.tw/Terms-and-Conditions>. Attention is drawn to the limitation of liability, indemnification and jurisdiction issues defined therein. Any holder of this document is advised that information contained hereon reflects the Company's findings at the time of its intervention only and within the limits of Client's instructions, if any. The Company's sole responsibility is to its Client and this document does not exonerate parties to a transaction from exercising all their rights and obligations under the transaction documents. This document cannot be reproduced except in full, without prior written approval of the Company. Any unauthorized alteration, forgery or falsification of the content or appearance of this document is unlawful and offenders may be prosecuted to the fullest extent of the law.

Report Number :TERF2304000923ER
 Operation Mode :BLE 1M
 Test Frequency :2480 MHz
 Test Mode :Bandedge
 EUT Pol :E2 Plane

Test Site :SAC 2
 Test Date :2023-04-28
 Temp./Humi. :25.4/63
 Antenna Pol. :Horizontal
 Engineer :Ricky Chen

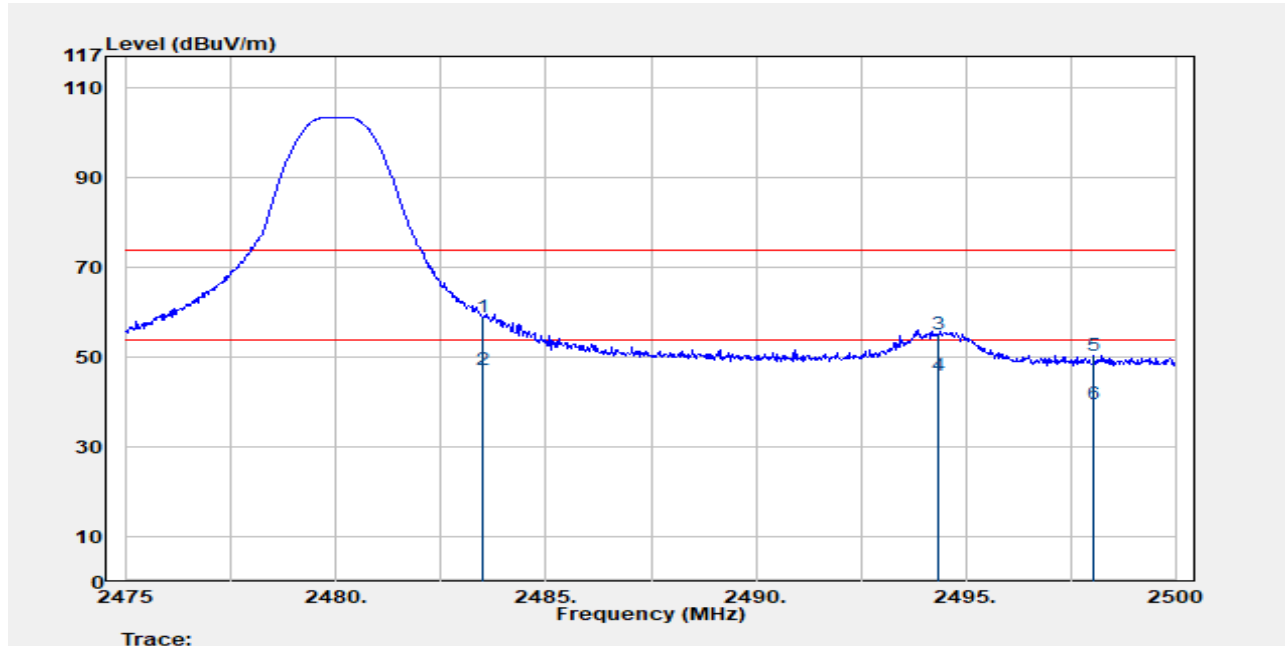

Freq. MHz	Detector Mode PK/QP/AV	Spectrum Reading Level dBμV	Factor dB	Actual FS dBμV/m	Limit @3m dBμV/m	Margin dB
2483.500	Peak	63.39	-4.26	59.13	74.00	-14.87
2483.500	Average	51.39	-4.26	47.13	54.00	-6.87
2494.350	Peak	59.37	-4.17	55.20	74.00	-18.80
2494.350	Average	50.02	-4.17	45.85	54.00	-8.15
2498.050	Peak	54.69	-4.15	50.55	74.00	-23.45
2498.050	Average	43.64	-4.15	39.49	54.00	-14.51

Unless otherwise stated the results shown in this test report refer only to the sample(s) tested and such sample(s) are retained for 90 days only.

除非另有說明，此報告結果僅對測試之樣品負責，同時此樣品僅保留90天。本報告未經本公司書面許可，不可部份複製。

This document is issued by the Company subject to its General Conditions of Service printed overleaf, available on request or accessible at <http://www.sgs.com.tw/Terms-and-Conditions> and for electronic format documents, subject to Terms and Conditions for Electronic Documents at <http://www.sgs.com.tw/Terms-and-Conditions>. Attention is drawn to the limitation of liability, indemnification and jurisdiction issues defined therein. Any holder of this document is advised that information contained hereon reflects the Company's findings at the time of its intervention only and within the limits of Client's instructions, if any. The Company's sole responsibility is to its Client and this document does not exonerate parties to a transaction from exercising all their rights and obligations under the transaction documents. This document cannot be reproduced except in full, without prior written approval of the Company. Any unauthorized alteration, forgery or falsification of the content or appearance of this document is unlawful and offenders may be prosecuted to the fullest extent of the law.

Report Number :TERF2304000923ER
 Operation Mode :BLE 2M
 Test Frequency :2402 MHz
 Test Mode :Bandedge
 EUT Pol :E2 Plane

Test Site :SAC 2
 Test Date :2023-04-28
 Temp./Humi. :25.4/63
 Antenna Pol. :Vertical
 Engineer :Ricky Chen

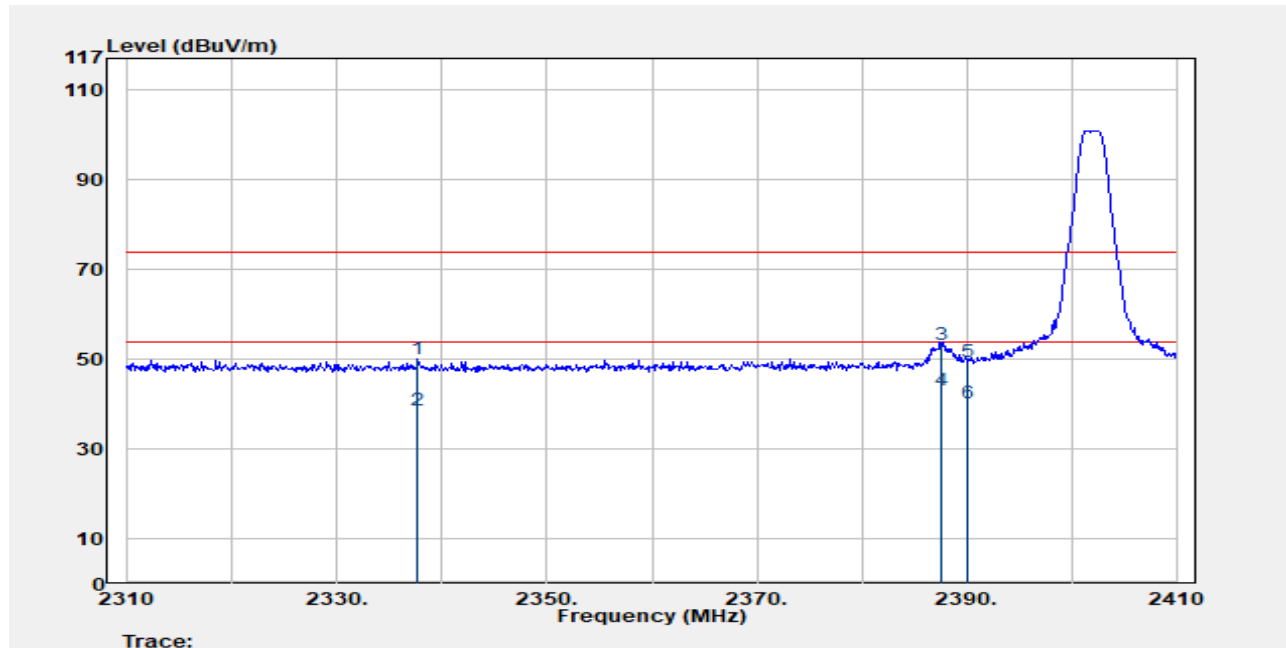

Freq. MHz	Detector Mode PK/QP/AV	Spectrum Reading Level dBμV	Factor dB	Actual FS dBμV/m	Limit @3m dBμV/m	Margin dB
2337.700	Peak	54.38	-4.37	50.01	74.00	-23.99
2337.700	Average	43.16	-4.37	38.79	54.00	-15.21
2387.600	Peak	57.39	-4.18	53.21	74.00	-20.79
2387.600	Average	47.35	-4.18	43.17	54.00	-10.83
2390.000	Peak	53.55	-4.17	49.39	74.00	-24.61
2390.000	Average	44.35	-4.17	40.18	54.00	-13.82

Unless otherwise stated the results shown in this test report refer only to the sample(s) tested and such sample(s) are retained for 90 days only.
 除非另有說明，此報告結果僅對測試之樣品負責，同時此樣品僅保留90天。本報告未經本公司書面許可，不可部份複製。

This document is issued by the Company subject to its General Conditions of Service printed overleaf, available on request or accessible at <http://www.sgs.com.tw/Terms-and-Conditions> and for electronic format documents, subject to Terms and Conditions for Electronic Documents at <http://www.sgs.com.tw/Terms-and-Conditions>. Attention is drawn to the limitation of liability, indemnification and jurisdiction issues defined therein. Any holder of this document is advised that information contained hereon reflects the Company's findings at the time of its intervention only and within the limits of Client's instructions, if any. The Company's sole responsibility is to its Client and this document does not exonerate parties to a transaction from exercising all their rights and obligations under the transaction documents. This document cannot be reproduced except in full, without prior written approval of the Company. Any unauthorized alteration, forgery or falsification of the content or appearance of this document is unlawful and offenders may be prosecuted to the fullest extent of the law.

SGS Taiwan Ltd. No.134,Wu Kung Road, New Taipei Industrial Park, Wuku District, New Taipei City, Taiwan/新北市五股區新北產業園區五工路 134 號

Report Number :TERF2304000923ER
 Operation Mode :BLE 2M
 Test Frequency :2402 MHz
 Test Mode :Bandedge
 EUT Pol :E2 Plane

Test Site :SAC 2
 Test Date :2023-04-28
 Temp./Humi. :25.4/63
 Antenna Pol. :Horizontal
 Engineer :Ricky Chen

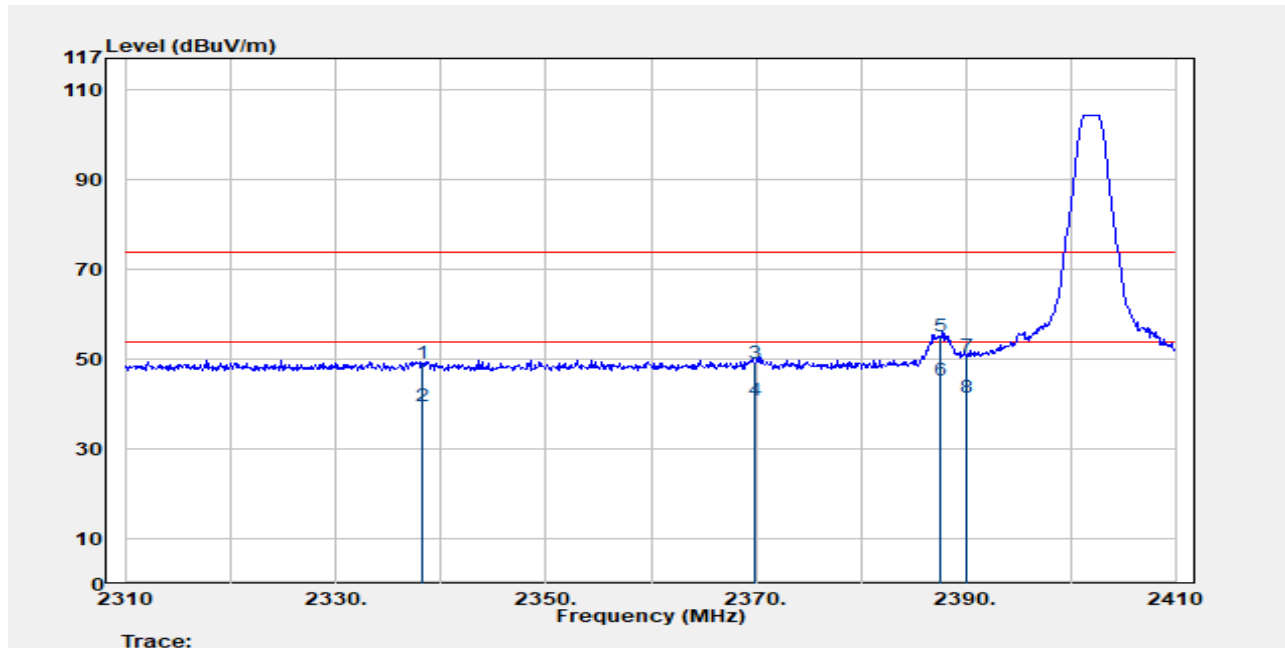

Freq. MHz	Detector Mode PK/QP/AV	Spectrum Reading Level dBμV	Factor dB	Actual FS dBμV/m	Limit @3m dBμV/m	Margin dB
2338.100	Peak	53.54	-4.37	49.17	74.00	-24.83
2338.100	Average	44.09	-4.37	39.72	54.00	-14.28
2369.900	Peak	53.54	-4.28	49.26	74.00	-24.74
2369.900	Average	45.12	-4.28	40.84	54.00	-13.16
2387.600	Peak	59.27	-4.18	55.09	74.00	-18.91
2387.600	Average	49.55	-4.18	45.37	54.00	-8.63
2390.000	Peak	54.80	-4.17	50.63	74.00	-23.37
2390.000	Average	45.62	-4.17	41.45	54.00	-12.55

Unless otherwise stated the results shown in this test report refer only to the sample(s) tested and such sample(s) are retained for 90 days only.

除非另有說明，此報告結果僅對測試之樣品負責，同時此樣品僅保留90天。本報告未經本公司書面許可，不可部份複製。

This document is issued by the Company subject to its General Conditions of Service printed overleaf, available on request or accessible at <http://www.sgs.com.tw/Terms-and-Conditions> and for electronic format documents, subject to Terms and Conditions for Electronic Documents at <http://www.sgs.com.tw/Terms-and-Conditions>. Attention is drawn to the limitation of liability, indemnification and jurisdiction issues defined therein. Any holder of this document is advised that information contained hereon reflects the Company's findings at the time of its intervention only and within the limits of Client's instructions, if any. The Company's sole responsibility is to its Client and this document does not exonerate parties to a transaction from exercising all their rights and obligations under the transaction documents. This document cannot be reproduced except in full, without prior written approval of the Company. Any unauthorized alteration, forgery or falsification of the content or appearance of this document is unlawful and offenders may be prosecuted to the fullest extent of the law.

Report Number :TERF2304000923ER
 Operation Mode :BLE 2M
 Test Frequency :2480 MHz
 Test Mode :Bandedge
 EUT Pol :E2 Plane

Test Site :SAC 2
 Test Date :2023-04-28
 Temp./Humi. :25.4/63
 Antenna Pol. :Vertical
 Engineer :Ricky Chen

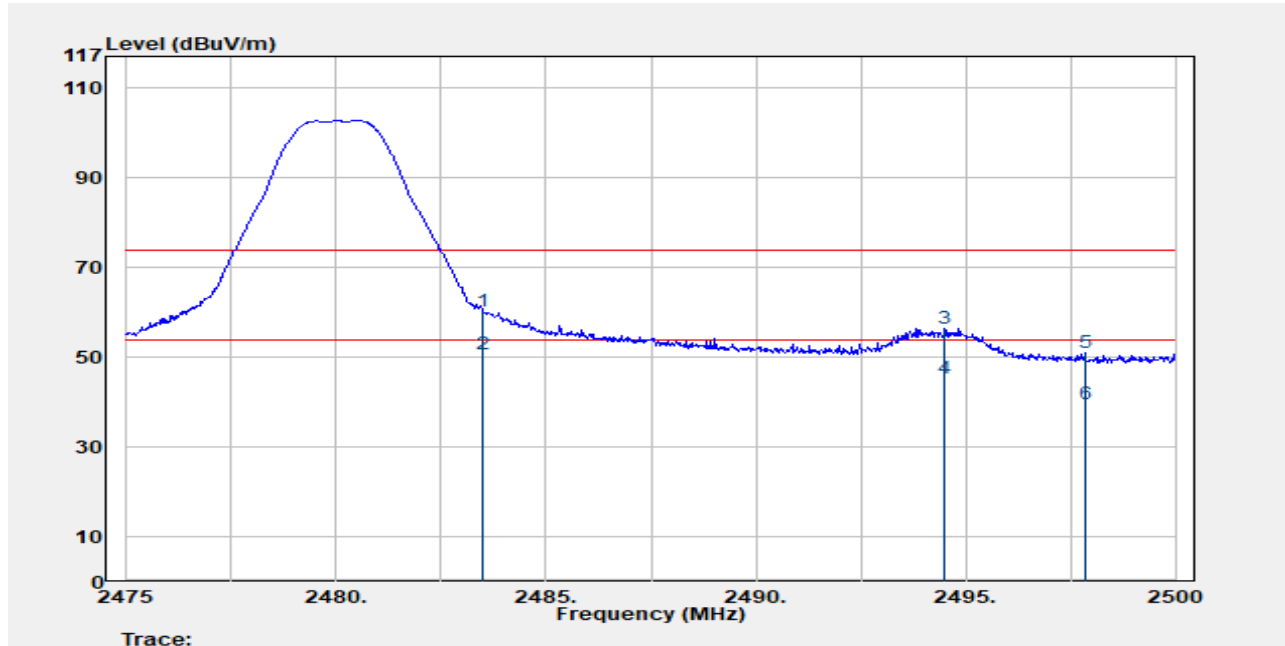

Freq. MHz	Detector Mode PK/QP/AV	Spectrum Reading Level dBμV	Factor dB	Actual FS dBμV/m	Limit @3m dBμV/m	Margin dB
2483.500	Peak	64.41	-4.26	60.15	74.00	-13.85
2483.500	Average	54.92	-4.26	50.66	54.00	-3.34
2494.500	Peak	60.68	-4.17	56.51	74.00	-17.49
2494.500	Average	49.39	-4.17	45.22	54.00	-8.78
2497.850	Peak	55.17	-4.15	51.02	74.00	-22.98
2497.850	Average	43.75	-4.15	39.60	54.00	-14.40

Unless otherwise stated the results shown in this test report refer only to the sample(s) tested and such sample(s) are retained for 90 days only.

除非另有說明，此報告結果僅對測試之樣品負責，同時此樣品僅保留90天。本報告未經本公司書面許可，不可部份複製。

This document is issued by the Company subject to its General Conditions of Service printed overleaf, available on request or accessible at <http://www.sgs.com.tw/Terms-and-Conditions> and for electronic format documents, subject to Terms and Conditions for Electronic Documents at <http://www.sgs.com.tw/Terms-and-Conditions>. Attention is drawn to the limitation of liability, indemnification and jurisdiction issues defined therein. Any holder of this document is advised that information contained hereon reflects the Company's findings at the time of its intervention only and within the limits of Client's instructions, if any. The Company's sole responsibility is to its Client and this document does not exonerate parties to a transaction from exercising all their rights and obligations under the transaction documents. This document cannot be reproduced except in full, without prior written approval of the Company. Any unauthorized alteration, forgery or falsification of the content or appearance of this document is unlawful and offenders may be prosecuted to the fullest extent of the law.

Report Number :TERF2304000923ER
 Operation Mode :BLE 2M
 Test Frequency :2480 MHz
 Test Mode :Bandedge
 EUT Pol :E2 Plane

Test Site :SAC 2
 Test Date :2023-04-28
 Temp./Humi. :25.4/63
 Antenna Pol. :Horizontal
 Engineer :Ricky Chen

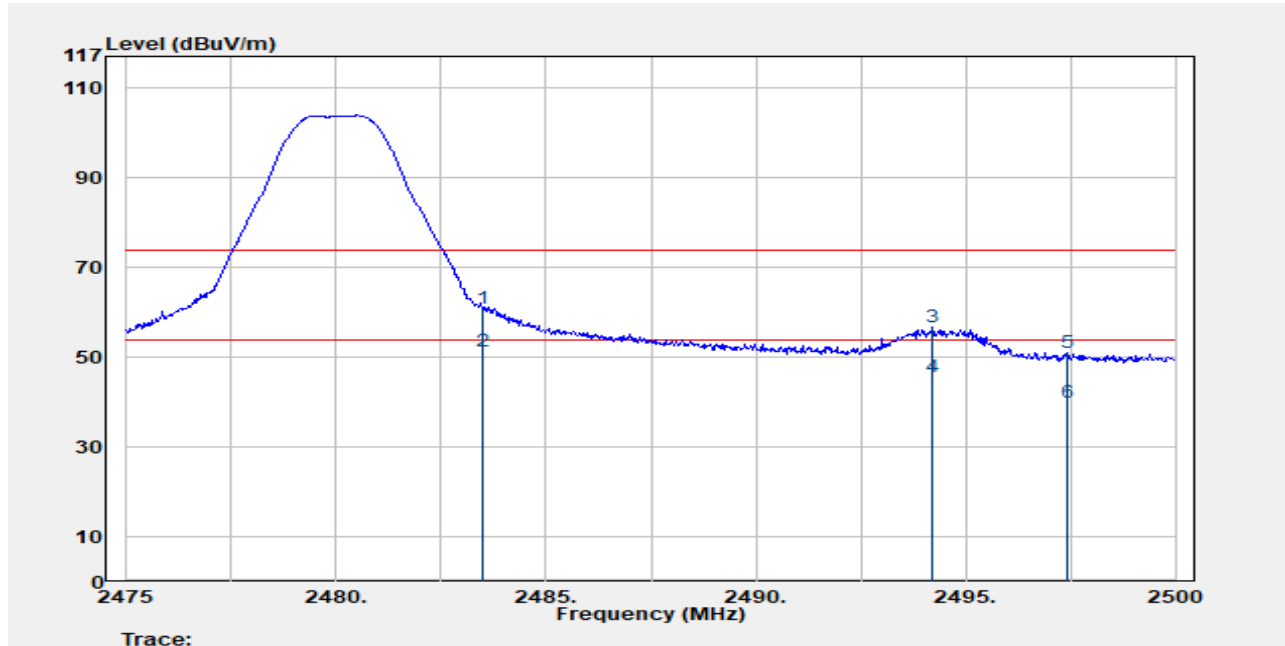

Freq. MHz	Detector Mode PK/QP/AV	Spectrum Reading Level dBμV	Factor dB	Actual FS dBμV/m	Limit @3m dBμV/m	Margin dB
2483.500	Peak	65.13	-4.26	60.87	74.00	-13.13
2483.500	Average	55.72	-4.26	51.46	54.00	-2.54
2494.225	Peak	60.85	-4.17	56.68	74.00	-17.32
2494.225	Average	49.68	-4.17	45.51	54.00	-8.49
2497.425	Peak	55.10	-4.15	50.95	74.00	-23.05
2497.425	Average	44.15	-4.15	40.00	54.00	-14.00

Unless otherwise stated the results shown in this test report refer only to the sample(s) tested and such sample(s) are retained for 90 days only.

除非另有說明，此報告結果僅對測試之樣品負責，同時此樣品僅保留90天。本報告未經本公司書面許可，不可部份複製。

This document is issued by the Company subject to its General Conditions of Service printed overleaf, available on request or accessible at <http://www.sgs.com.tw/Terms-and-Conditions> and for electronic format documents, subject to Terms and Conditions for Electronic Documents at <http://www.sgs.com.tw/Terms-and-Conditions>. Attention is drawn to the limitation of liability, indemnification and jurisdiction issues defined therein. Any holder of this document is advised that information contained hereon reflects the Company's findings at the time of its intervention only and within the limits of Client's instructions, if any. The Company's sole responsibility is to its Client and this document does not exonerate parties to a transaction from exercising all their rights and obligations under the transaction documents. This document cannot be reproduced except in full, without prior written approval of the Company. Any unauthorized alteration, forgery or falsification of the content or appearance of this document is unlawful and offenders may be prosecuted to the fullest extent of the law.

11.6.2 Radiated Spurious Emission

Report Number :TERF2304000923ER
 Operation Mode :BLE 1M
 Test Frequency :2442 MHz
 Test Mode :Tx
 EUT Pol :E2 Plane

Test Site :SAC 2
 Test Date :2023-04-28
 Temp./Humi. :25.4/63
 Antenna Pol. :Vertical
 Engineer :Ricky Chen

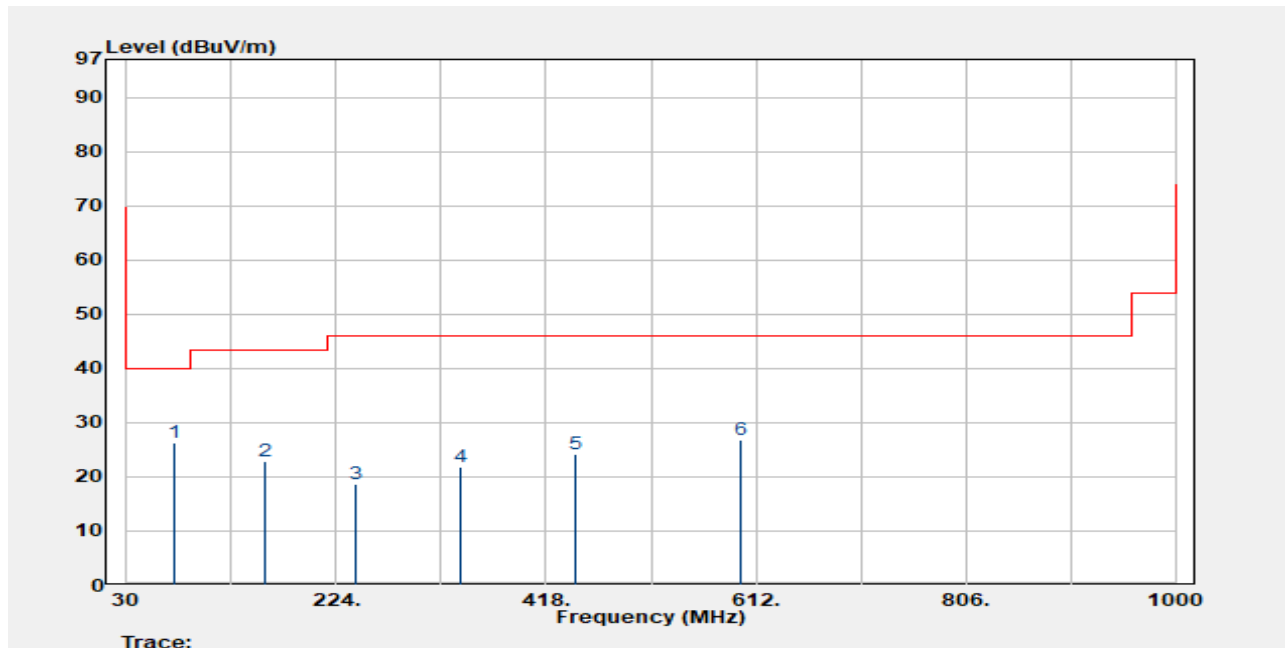

Freq. MHz	Detector Mode PK/QP/AV	Spectrum Reading Level dB μ V	Factor dB	Actual FS dB μ V/m	Limit @3m dB μ V/m	Margin dB
73.650	Peak	41.95	-15.64	26.31	40.00	-13.69
158.040	Peak	35.28	-12.44	22.84	43.50	-20.66
242.430	Peak	32.33	-13.78	18.55	46.00	-27.45
338.460	Peak	32.91	-11.05	21.85	46.00	-24.15
445.160	Peak	31.95	-7.85	24.10	46.00	-21.90
597.450	Peak	31.52	-4.74	26.78	46.00	-19.22

Unless otherwise stated the results shown in this test report refer only to the sample(s) tested and such sample(s) are retained for 90 days only.

除非另有說明，此報告結果僅對測試之樣品負責，同時此樣品僅保留90天。本報告未經本公司書面許可，不可部份複製。

This document is issued by the Company subject to its General Conditions of Service printed overleaf, available on request or accessible at <http://www.sgs.com.tw/Terms-and-Conditions> and for electronic format documents, subject to Terms and Conditions for Electronic Documents at <http://www.sgs.com.tw/Terms-and-Conditions>. Attention is drawn to the limitation of liability, indemnification and jurisdiction issues defined therein. Any holder of this document is advised that information contained hereon reflects the Company's findings at the time of its intervention only and within the limits of Client's instructions, if any. The Company's sole responsibility is to its Client and this document does not exonerate parties to a transaction from exercising all their rights and obligations under the transaction documents. This document cannot be reproduced except in full, without prior written approval of the Company. Any unauthorized alteration, forgery or falsification of the content or appearance of this document is unlawful and offenders may be prosecuted to the fullest extent of the law.

Report Number :TERF2304000923ER
 Operation Mode :BLE 1M
 Test Frequency :2442 MHz
 Test Mode :Tx
 EUT Pol :E2 Plane

Test Site :SAC 2
 Test Date :2023-04-28
 Temp./Humi. :25.4/63
 Antenna Pol. :Horizontal
 Engineer :Ricky Chen

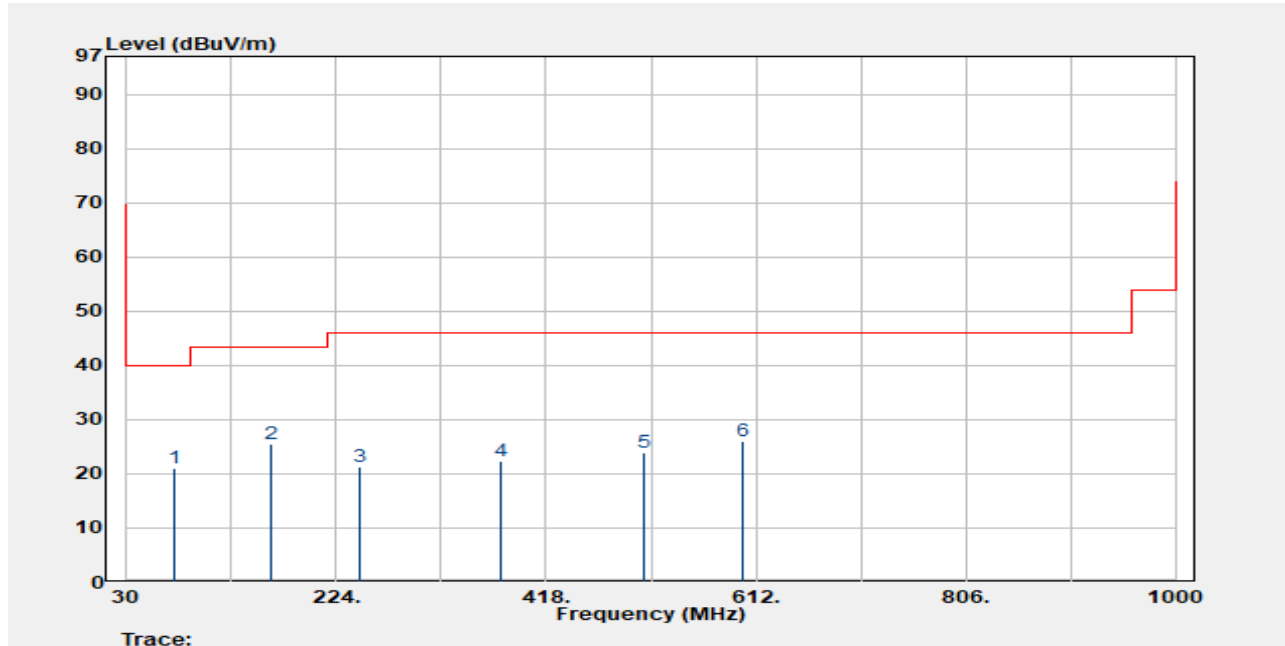

Freq. MHz	Detector Mode PK/QP/AV	Spectrum Reading Level dBμV	Factor dB	Actual FS dBμV/m	Limit @3m dBμV/m	Margin dB
73.650	Peak	36.78	-15.64	21.14	40.00	-18.86
162.890	Peak	38.09	-12.57	25.52	43.50	-17.98
245.340	Peak	34.80	-13.63	21.17	46.00	-24.83
376.290	Peak	32.28	-10.02	22.26	46.00	-23.74
509.180	Peak	31.00	-7.04	23.96	46.00	-22.04
599.390	Peak	30.40	-4.45	25.94	46.00	-20.06

Unless otherwise stated the results shown in this test report refer only to the sample(s) tested and such sample(s) are retained for 90 days only.

除非另有說明，此報告結果僅對測試之樣品負責，同時此樣品僅保留90天。本報告未經本公司書面許可，不可部份複製。

This document is issued by the Company subject to its General Conditions of Service printed overleaf, available on request or accessible at <http://www.sgs.com.tw/Terms-and-Conditions> and for electronic format documents, subject to Terms and Conditions for Electronic Documents at <http://www.sgs.com.tw/Terms-and-Conditions>. Attention is drawn to the limitation of liability, indemnification and jurisdiction issues defined therein. Any holder of this document is advised that information contained hereon reflects the Company's findings at the time of its intervention only and within the limits of Client's instructions, if any. The Company's sole responsibility is to its Client and this document does not exonerate parties to a transaction from exercising all their rights and obligations under the transaction documents. This document cannot be reproduced except in full, without prior written approval of the Company. Any unauthorized alteration, forgery or falsification of the content or appearance of this document is unlawful and offenders may be prosecuted to the fullest extent of the law.

Report Number :TERF2304000923ER
 Operation Mode :BLE 2M
 Test Frequency :2442 MHz
 Test Mode :Tx
 EUT Pol :E2 Plane

Test Site :SAC 2
 Test Date :2023-04-28
 Temp./Humi. :25.4/63
 Antenna Pol. :Vertical
 Engineer :Ricky Chen

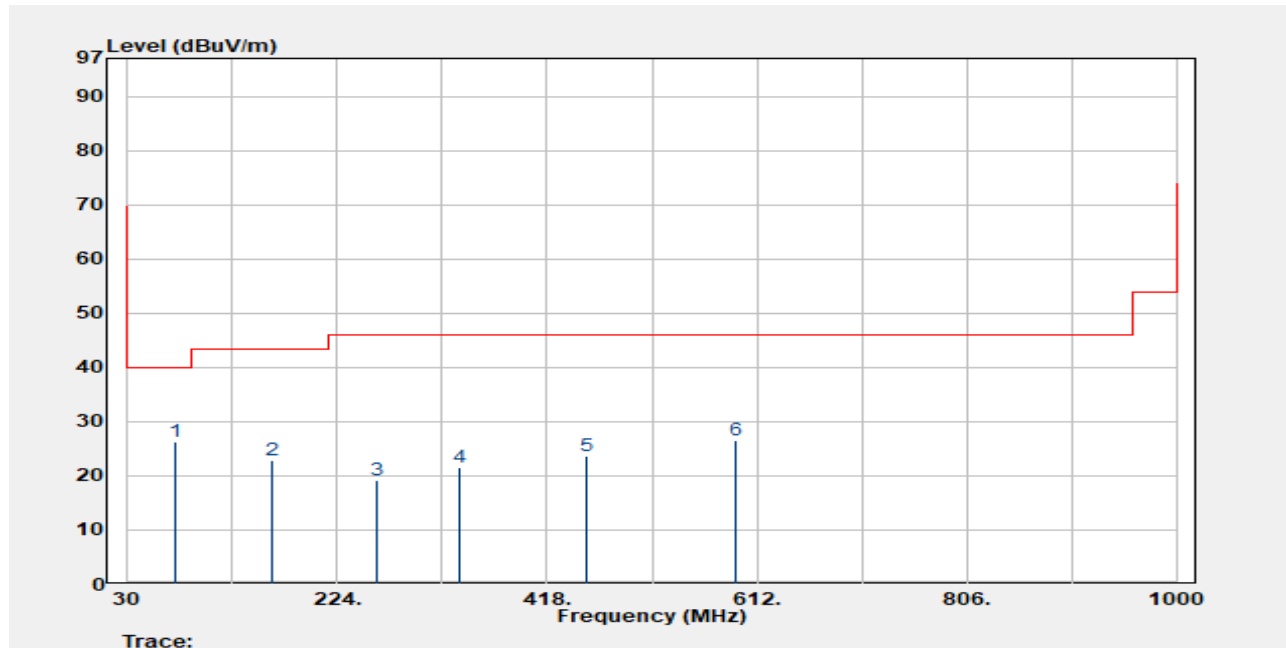

Freq. MHz	Detector Mode PK/QP/AV	Spectrum Reading Level dBμV	Factor dB	Actual FS dBμV/m	Limit @3m dBμV/m	Margin dB
74.620	Peak	42.18	-15.83	26.34	40.00	-13.66
163.860	Peak	35.53	-12.66	22.88	43.50	-20.62
259.890	Peak	32.72	-13.45	19.27	46.00	-26.73
337.490	Peak	32.50	-11.01	21.49	46.00	-24.51
453.890	Peak	31.29	-7.65	23.64	46.00	-22.36
591.630	Peak	31.41	-4.93	26.48	46.00	-19.52

Unless otherwise stated the results shown in this test report refer only to the sample(s) tested and such sample(s) are retained for 90 days only.

除非另有說明，此報告結果僅對測試之樣品負責，同時此樣品僅保留90天。本報告未經本公司書面許可，不可部份複製。

This document is issued by the Company subject to its General Conditions of Service printed overleaf, available on request or accessible at <http://www.sgs.com.tw/Terms-and-Conditions> and for electronic format documents, subject to Terms and Conditions for Electronic Documents at <http://www.sgs.com.tw/Terms-and-Conditions>. Attention is drawn to the limitation of liability, indemnification and jurisdiction issues defined therein. Any holder of this document is advised that information contained hereon reflects the Company's findings at the time of its intervention only and within the limits of Client's instructions, if any. The Company's sole responsibility is to its Client and this document does not exonerate parties to a transaction from exercising all their rights and obligations under the transaction documents. This document cannot be reproduced except in full, without prior written approval of the Company. Any unauthorized alteration, forgery or falsification of the content or appearance of this document is unlawful and offenders may be prosecuted to the fullest extent of the law.

Report Number :TERF2304000923ER
 Operation Mode :BLE 2M
 Test Frequency :2442 MHz
 Test Mode :Tx
 EUT Pol :E2 Plane

Test Site :SAC 2
 Test Date :2023-04-28
 Temp./Humi. :25.4/63
 Antenna Pol. :Horizontal
 Engineer :Ricky Chen

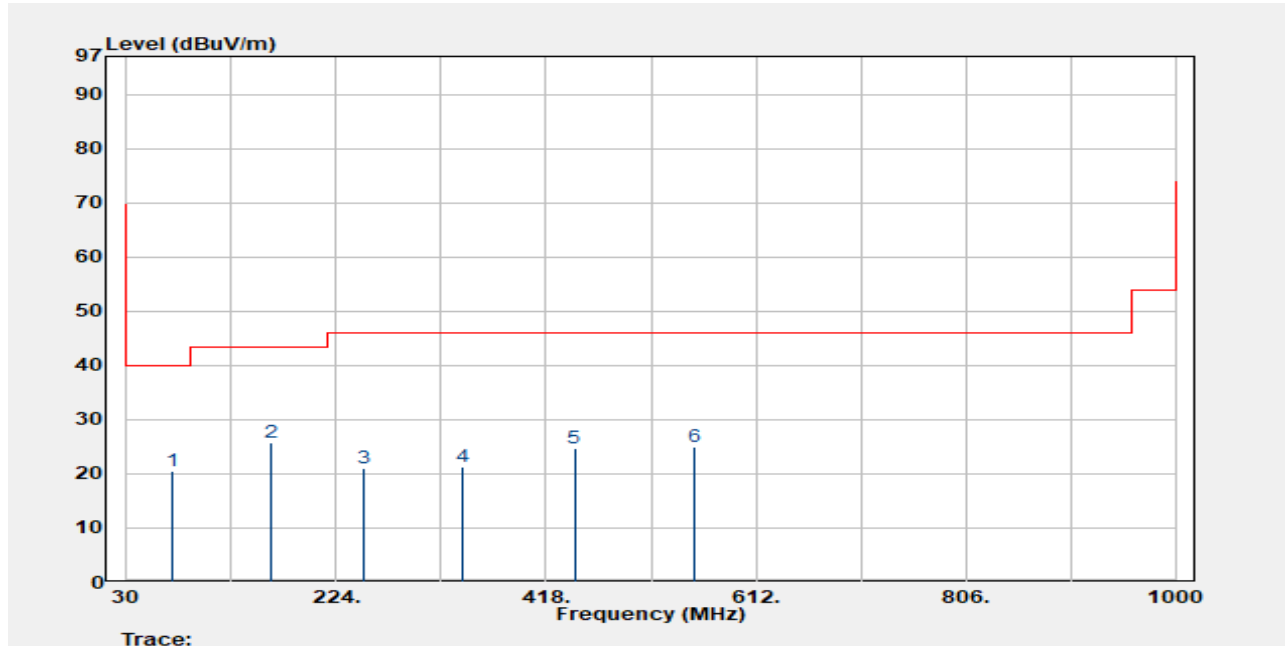

Freq. MHz	Detector Mode PK/QP/AV	Spectrum Reading Level dBμV	Factor dB	Actual FS dBμV/m	Limit @3m dBμV/m	Margin dB
72.680	Peak	35.63	-15.22	20.41	40.00	-19.59
162.890	Peak	38.20	-12.57	25.63	43.50	-17.87
249.220	Peak	34.64	-13.63	21.01	46.00	-24.99
341.370	Peak	32.38	-11.05	21.33	46.00	-24.67
444.190	Peak	32.56	-7.93	24.63	46.00	-21.37
555.740	Peak	31.24	-6.16	25.08	46.00	-20.92

Unless otherwise stated the results shown in this test report refer only to the sample(s) tested and such sample(s) are retained for 90 days only.

除非另有說明，此報告結果僅對測試之樣品負責，同時此樣品僅保留90天。本報告未經本公司書面許可，不可部份複製。

This document is issued by the Company subject to its General Conditions of Service printed overleaf, available on request or accessible at <http://www.sgs.com.tw/Terms-and-Conditions> and for electronic format documents, subject to Terms and Conditions for Electronic Documents at <http://www.sgs.com.tw/Terms-and-Conditions>. Attention is drawn to the limitation of liability, indemnification and jurisdiction issues defined therein. Any holder of this document is advised that information contained hereon reflects the Company's findings at the time of its intervention only and within the limits of Client's instructions, if any. The Company's sole responsibility is to its Client and this document does not exonerate parties to a transaction from exercising all their rights and obligations under the transaction documents. This document cannot be reproduced except in full, without prior written approval of the Company. Any unauthorized alteration, forgery or falsification of the content or appearance of this document is unlawful and offenders may be prosecuted to the fullest extent of the law.

Report Number :TERF2304000923ER
 Operation Mode :BLE 1M
 Test Frequency :2402 MHz
 Test Mode :Tx
 EUT Pol :E2 Plane

Test Site :SAC 2
 Test Date :2023-04-28
 Temp./Humi. :25.4/63
 Antenna Pol. :Vertical
 Engineer :Ricky Chen

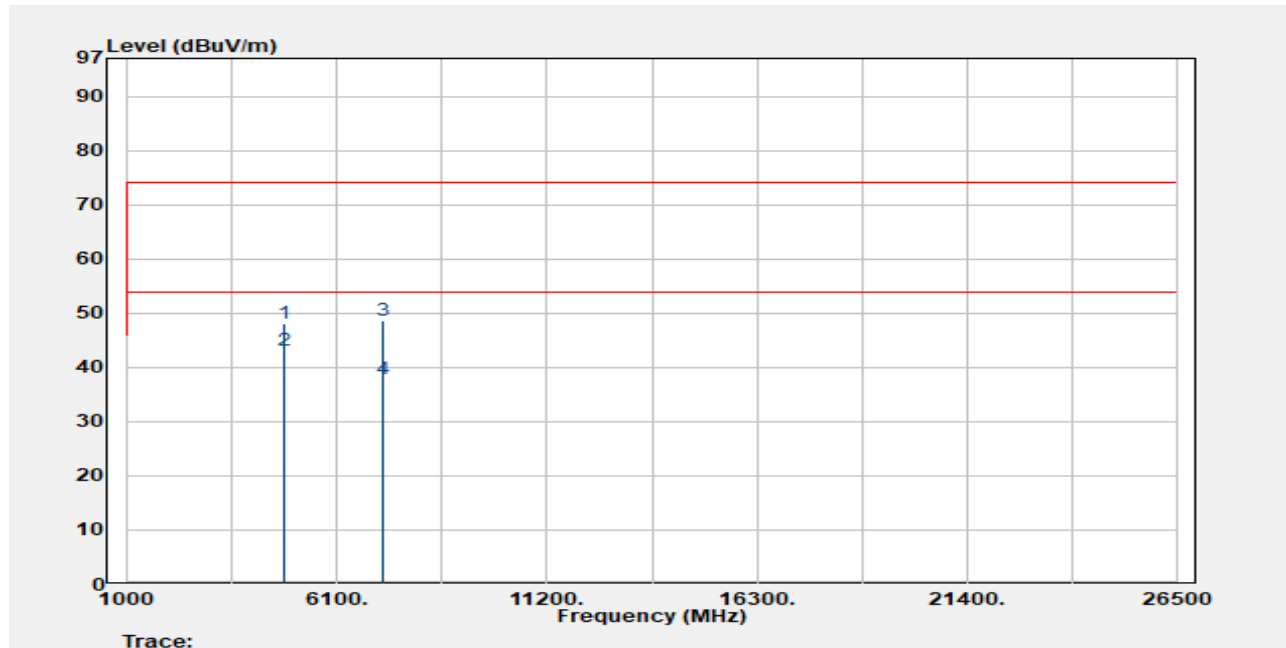

Freq. MHz	Detector Mode PK/QP/AV	Spectrum Reading Level dBμV	Factor dB	Actual FS dBμV/m	Limit @3m dBμV/m	Margin dB
4804.000	Peak	46.09	2.10	48.19	74.00	-25.81
4804.000	Average	41.12	2.10	43.22	54.00	-10.78
7206.000	Peak	40.99	7.56	48.55	74.00	-25.45
7206.000	Average	30.31	7.56	37.87	54.00	-16.13

Unless otherwise stated the results shown in this test report refer only to the sample(s) tested and such sample(s) are retained for 90 days only.

除非另有說明，此報告結果僅對測試之樣品負責，同時此樣品僅保留90天。本報告未經本公司書面許可，不可部份複製。

This document is issued by the Company subject to its General Conditions of Service printed overleaf, available on request or accessible at <http://www.sgs.com.tw/Terms-and-Conditions> and for electronic format documents, subject to Terms and Conditions for Electronic Documents at <http://www.sgs.com.tw/Terms-and-Conditions>. Attention is drawn to the limitation of liability, indemnification and jurisdiction issues defined therein. Any holder of this document is advised that information contained hereon reflects the Company's findings at the time of its intervention only and within the limits of Client's instructions, if any. The Company's sole responsibility is to its Client and this document does not exonerate parties to a transaction from exercising all their rights and obligations under the transaction documents. This document cannot be reproduced except in full, without prior written approval of the Company. Any unauthorized alteration, forgery or falsification of the content or appearance of this document is unlawful and offenders may be prosecuted to the fullest extent of the law.

Report Number :TERF2304000923ER
 Operation Mode :BLE 1M
 Test Frequency :2402 MHz
 Test Mode :Tx
 EUT Pol :E2 Plane

Test Site :SAC 2
 Test Date :2023-04-28
 Temp./Humi. :25.4/63
 Antenna Pol. :Horizontal
 Engineer :Ricky Chen

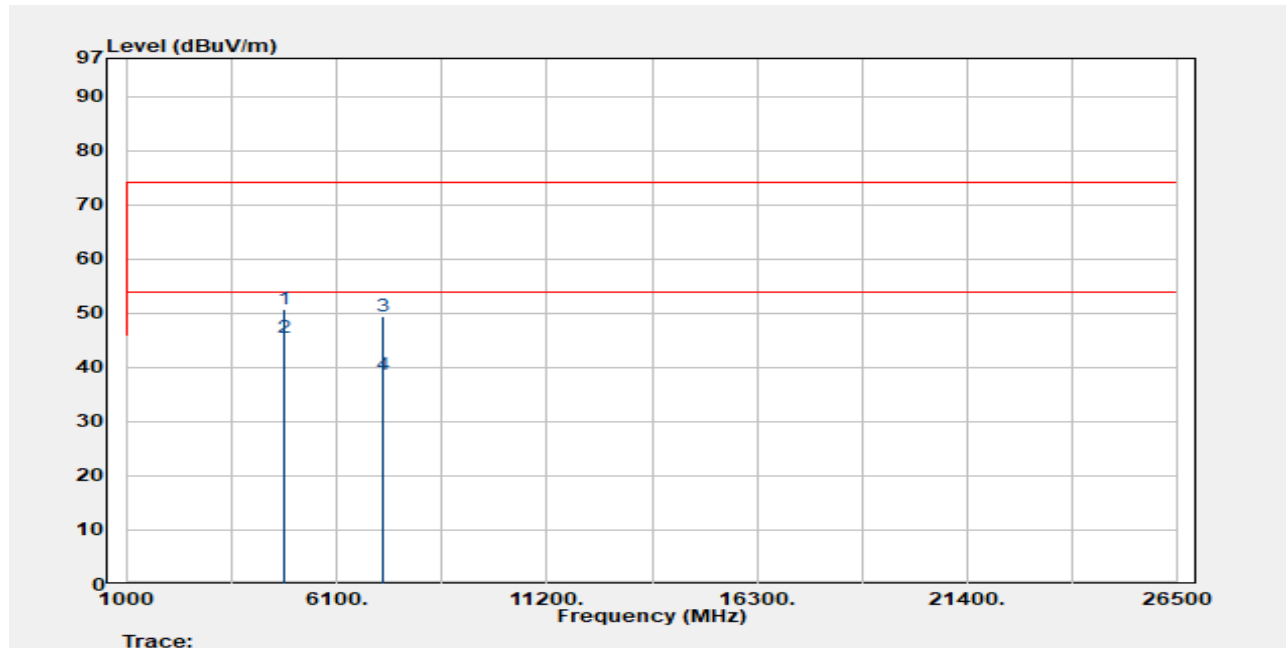

Freq. MHz	Detector Mode PK/QP/AV	Spectrum Reading Level dBμV	Factor dB	Actual FS dBμV/m	Limit @3m dBμV/m	Margin dB
4804.000	Peak	48.64	2.10	50.74	74.00	-23.26
4804.000	Average	43.32	2.10	45.42	54.00	-8.58
7206.000	Peak	41.74	7.56	49.30	74.00	-24.70
7206.000	Average	30.99	7.56	38.55	54.00	-15.45

Unless otherwise stated the results shown in this test report refer only to the sample(s) tested and such sample(s) are retained for 90 days only.

除非另有說明，此報告結果僅對測試之樣品負責，同時此樣品僅保留90天。本報告未經本公司書面許可，不可部份複製。

This document is issued by the Company subject to its General Conditions of Service printed overleaf, available on request or accessible at <http://www.sgs.com.tw/Terms-and-Conditions> and for electronic format documents, subject to Terms and Conditions for Electronic Documents at <http://www.sgs.com.tw/Terms-and-Conditions>. Attention is drawn to the limitation of liability, indemnification and jurisdiction issues defined therein. Any holder of this document is advised that information contained hereon reflects the Company's findings at the time of its intervention only and within the limits of Client's instructions, if any. The Company's sole responsibility is to its Client and this document does not exonerate parties to a transaction from exercising all their rights and obligations under the transaction documents. This document cannot be reproduced except in full, without prior written approval of the Company. Any unauthorized alteration, forgery or falsification of the content or appearance of this document is unlawful and offenders may be prosecuted to the fullest extent of the law.

Report Number :TERF2304000923ER
 Operation Mode :BLE 1M
 Test Frequency :2442 MHz
 Test Mode :Tx
 EUT Pol :E2 Plane

Test Site :SAC 2
 Test Date :2023-04-28
 Temp./Humi. :25.4/63
 Antenna Pol. :Vertical
 Engineer :Ricky Chen

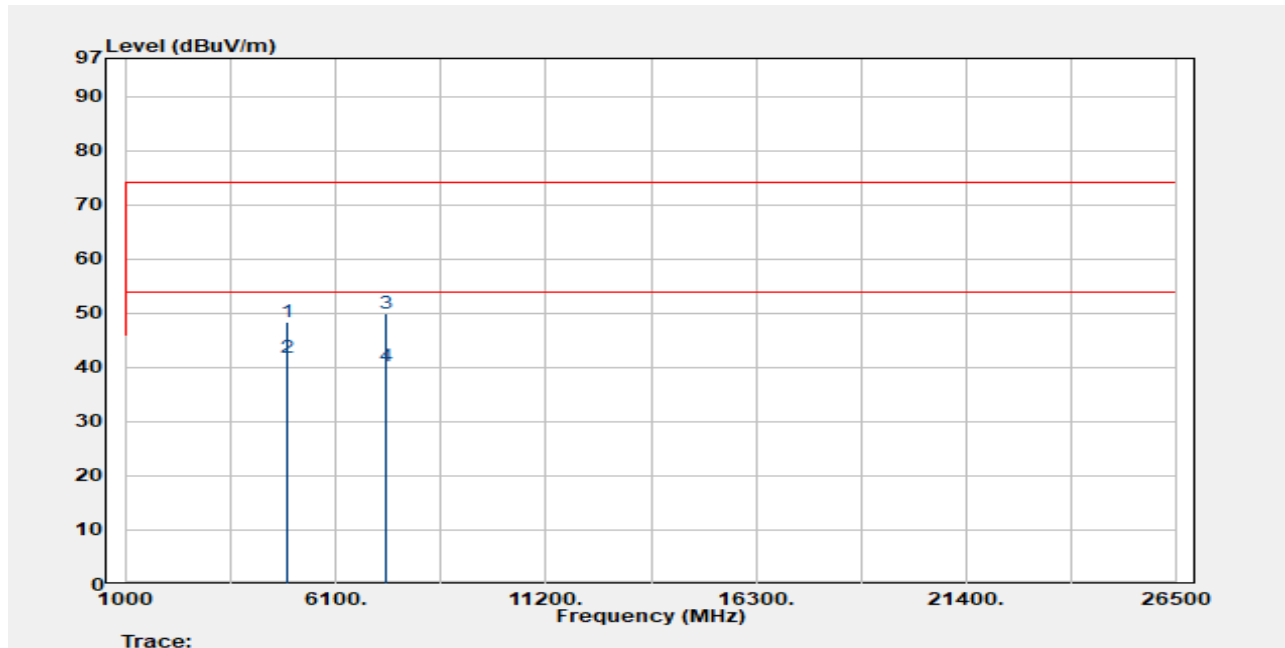

Freq. MHz	Detector Mode PK/QP/AV	Spectrum Reading Level dBμV	Factor dB	Actual FS dBμV/m	Limit @3m dBμV/m	Margin dB
4884.000	Peak	45.82	2.67	48.49	74.00	-25.51
4884.000	Average	39.07	2.67	41.74	54.00	-12.26
7326.000	Peak	42.14	7.71	49.85	74.00	-24.15
7326.000	Average	32.53	7.71	40.24	54.00	-13.76

Unless otherwise stated the results shown in this test report refer only to the sample(s) tested and such sample(s) are retained for 90 days only.

除非另有說明，此報告結果僅對測試之樣品負責，同時此樣品僅保留90天。本報告未經本公司書面許可，不可部份複製。

This document is issued by the Company subject to its General Conditions of Service printed overleaf, available on request or accessible at <http://www.sgs.com.tw/Terms-and-Conditions> and for electronic format documents, subject to Terms and Conditions for Electronic Documents at <http://www.sgs.com.tw/Terms-and-Conditions>. Attention is drawn to the limitation of liability, indemnification and jurisdiction issues defined therein. Any holder of this document is advised that information contained hereon reflects the Company's findings at the time of its intervention only and within the limits of Client's instructions, if any. The Company's sole responsibility is to its Client and this document does not exonerate parties to a transaction from exercising all their rights and obligations under the transaction documents. This document cannot be reproduced except in full, without prior written approval of the Company. Any unauthorized alteration, forgery or falsification of the content or appearance of this document is unlawful and offenders may be prosecuted to the fullest extent of the law.

Report Number :TERF2304000923ER
 Operation Mode :BLE 1M
 Test Frequency :2442 MHz
 Test Mode :Tx
 EUT Pol :E2 Plane

Test Site :SAC 2
 Test Date :2023-04-28
 Temp./Humi. :25.4/63
 Antenna Pol. :Horizontal
 Engineer :Ricky Chen

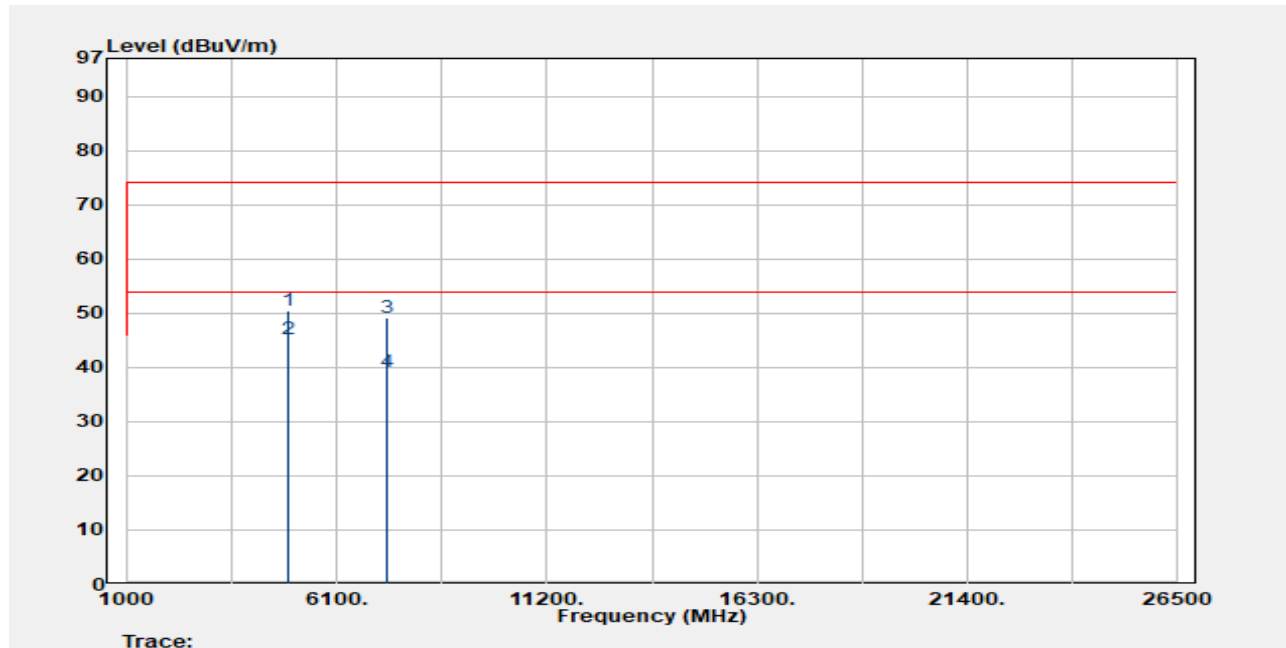

Trace:	Freq. MHz	Detector Mode PK/QP/AV	Spectrum Reading Level dBμV	Factor dB	Actual FS dBμV/m	Limit @3m dBμV/m	Margin dB
	4884.000	Peak	47.73	2.67	50.40	74.00	-23.60
	4884.000	Average	42.53	2.67	45.20	54.00	-8.80
	7326.000	Peak	41.49	7.71	49.20	74.00	-24.80
	7326.000	Average	31.46	7.71	39.17	54.00	-14.83

Unless otherwise stated the results shown in this test report refer only to the sample(s) tested and such sample(s) are retained for 90 days only.

除非另有說明，此報告結果僅對測試之樣品負責，同時此樣品僅保留90天。本報告未經本公司書面許可，不可部份複製。

This document is issued by the Company subject to its General Conditions of Service printed overleaf, available on request or accessible at <http://www.sgs.com.tw/Terms-and-Conditions> and for electronic format documents, subject to Terms and Conditions for Electronic Documents at <http://www.sgs.com.tw/Terms-and-Conditions>. Attention is drawn to the limitation of liability, indemnification and jurisdiction issues defined therein. Any holder of this document is advised that information contained hereon reflects the Company's findings at the time of its intervention only and within the limits of Client's instructions, if any. The Company's sole responsibility is to its Client and this document does not exonerate parties to a transaction from exercising all their rights and obligations under the transaction documents. This document cannot be reproduced except in full, without prior written approval of the Company. Any unauthorized alteration, forgery or falsification of the content or appearance of this document is unlawful and offenders may be prosecuted to the fullest extent of the law.

Report Number :TERF2304000923ER
 Operation Mode :BLE 1M
 Test Frequency :2480 MHz
 Test Mode :Tx
 EUT Pol :E2 Plane

Test Site :SAC 2
 Test Date :2023-04-28
 Temp./Humi. :25.4/63
 Antenna Pol. :Vertical
 Engineer :Ricky Chen

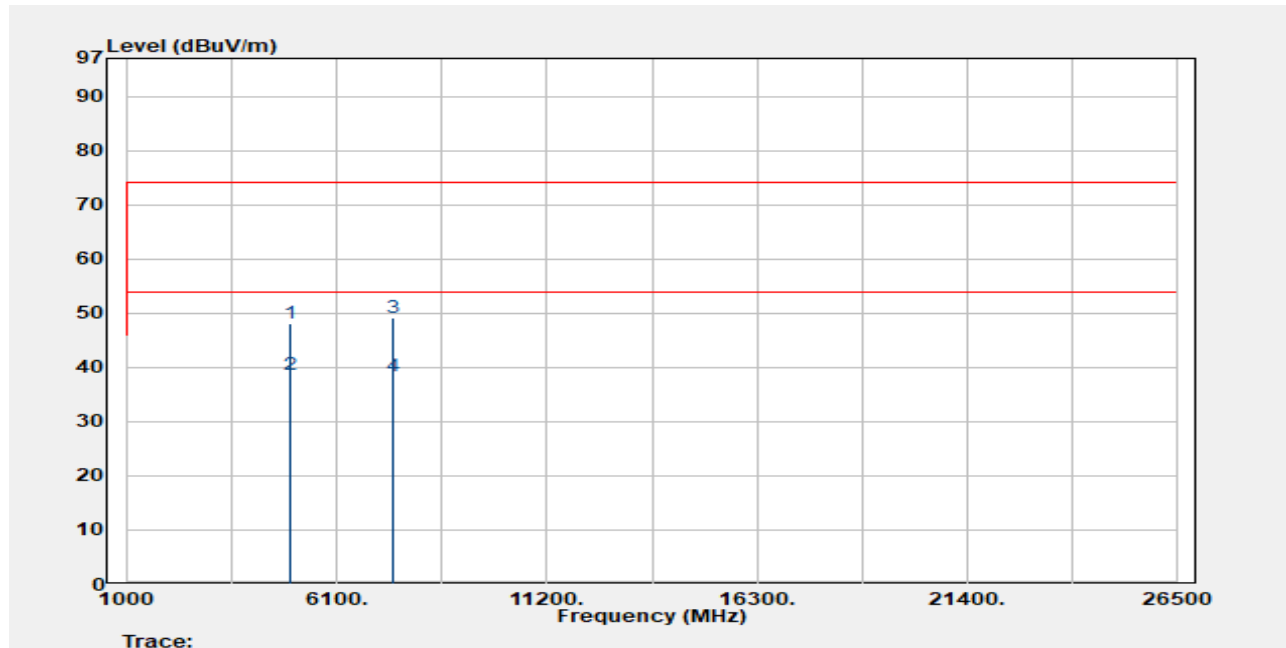

Freq. MHz	Detector Mode PK/QP/AV	Spectrum Reading Level dBμV	Factor dB	Actual FS dBμV/m	Limit @3m dBμV/m	Margin dB
4960.000	Peak	45.27	2.80	48.07	74.00	-25.93
4960.000	Average	35.79	2.80	38.59	54.00	-15.41
7440.000	Peak	41.12	7.97	49.09	74.00	-24.91
7440.000	Average	30.31	7.97	38.28	54.00	-15.72

Unless otherwise stated the results shown in this test report refer only to the sample(s) tested and such sample(s) are retained for 90 days only.

除非另有說明，此報告結果僅對測試之樣品負責，同時此樣品僅保留90天。本報告未經本公司書面許可，不可部份複製。

This document is issued by the Company subject to its General Conditions of Service printed overleaf, available on request or accessible at <http://www.sgs.com.tw/Terms-and-Conditions> and for electronic format documents, subject to Terms and Conditions for Electronic Documents at <http://www.sgs.com.tw/Terms-and-Conditions>. Attention is drawn to the limitation of liability, indemnification and jurisdiction issues defined therein. Any holder of this document is advised that information contained hereon reflects the Company's findings at the time of its intervention only and within the limits of Client's instructions, if any. The Company's sole responsibility is to its Client and this document does not exonerate parties to a transaction from exercising all their rights and obligations under the transaction documents. This document cannot be reproduced except in full, without prior written approval of the Company. Any unauthorized alteration, forgery or falsification of the content or appearance of this document is unlawful and offenders may be prosecuted to the fullest extent of the law.

Report Number :TERF2304000923ER
 Operation Mode :BLE 1M
 Test Frequency :2480 MHz
 Test Mode :Tx
 EUT Pol :E2 Plane

Test Site :SAC 2
 Test Date :2023-04-28
 Temp./Humi. :25.4/63
 Antenna Pol. :Horizontal
 Engineer :Ricky Chen

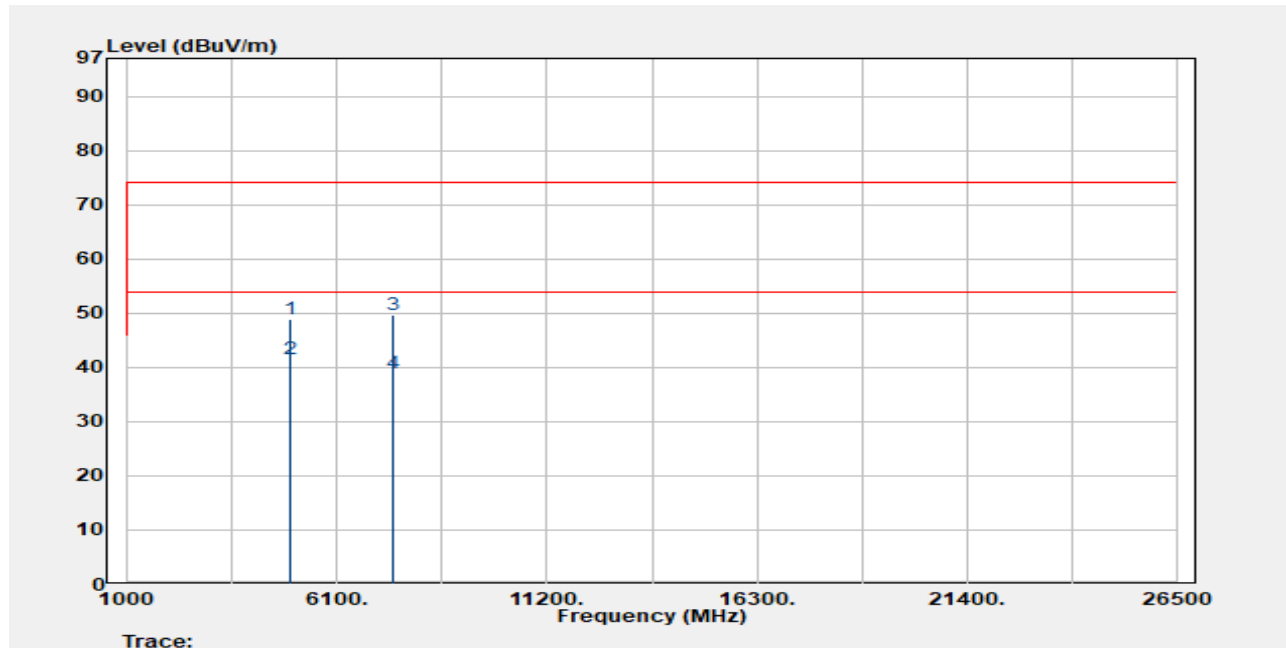

Freq. MHz	Detector Mode PK/QP/AV	Spectrum Reading Level dBμV	Factor dB	Actual FS dBμV/m	Limit @3m dBμV/m	Margin dB
4960.000	Peak	46.12	2.80	48.92	74.00	-25.08
4960.000	Average	38.62	2.80	41.42	54.00	-12.58
7440.000	Peak	41.84	7.97	49.81	74.00	-24.19
7440.000	Average	30.89	7.97	38.86	54.00	-15.14

Unless otherwise stated the results shown in this test report refer only to the sample(s) tested and such sample(s) are retained for 90 days only.

除非另有說明，此報告結果僅對測試之樣品負責，同時此樣品僅保留90天。本報告未經本公司書面許可，不可部份複製。

This document is issued by the Company subject to its General Conditions of Service printed overleaf, available on request or accessible at <http://www.sgs.com.tw/Terms-and-Conditions> and for electronic format documents, subject to Terms and Conditions for Electronic Documents at <http://www.sgs.com.tw/Terms-and-Conditions>. Attention is drawn to the limitation of liability, indemnification and jurisdiction issues defined therein. Any holder of this document is advised that information contained hereon reflects the Company's findings at the time of its intervention only and within the limits of Client's instructions, if any. The Company's sole responsibility is to its Client and this document does not exonerate parties to a transaction from exercising all their rights and obligations under the transaction documents. This document cannot be reproduced except in full, without prior written approval of the Company. Any unauthorized alteration, forgery or falsification of the content or appearance of this document is unlawful and offenders may be prosecuted to the fullest extent of the law.

Report Number :TERF2304000923ER
 Operation Mode :BLE 2M
 Test Frequency :2402 MHz
 Test Mode :Tx
 EUT Pol :E2 Plane

Test Site :SAC 2
 Test Date :2023-04-28
 Temp./Humi. :25.4/63
 Antenna Pol. :Vertical
 Engineer :Ricky Chen

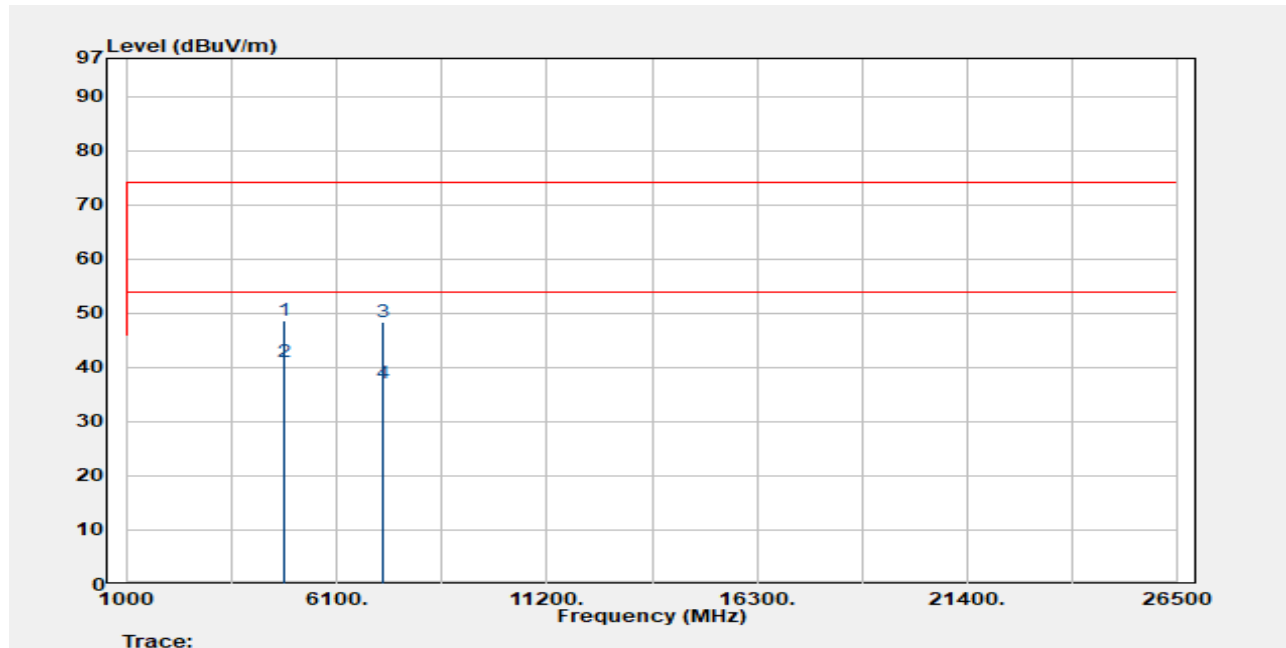

Freq. MHz	Detector Mode PK/QP/AV	Spectrum Reading Level dBμV	Factor dB	Actual FS dBμV/m	Limit @3m dBμV/m	Margin dB
4804.000	Peak	46.49	2.10	48.59	74.00	-25.41
4804.000	Average	38.82	2.10	40.92	54.00	-13.08
7206.000	Peak	40.77	7.56	48.33	74.00	-25.67
7206.000	Average	29.42	7.56	36.98	54.00	-17.02

Unless otherwise stated the results shown in this test report refer only to the sample(s) tested and such sample(s) are retained for 90 days only.

除非另有說明，此報告結果僅對測試之樣品負責，同時此樣品僅保留90天。本報告未經本公司書面許可，不可部份複製。

This document is issued by the Company subject to its General Conditions of Service printed overleaf, available on request or accessible at <http://www.sgs.com.tw/Terms-and-Conditions> and for electronic format documents, subject to Terms and Conditions for Electronic Documents at <http://www.sgs.com.tw/Terms-and-Conditions>. Attention is drawn to the limitation of liability, indemnification and jurisdiction issues defined therein. Any holder of this document is advised that information contained hereon reflects the Company's findings at the time of its intervention only and within the limits of Client's instructions, if any. The Company's sole responsibility is to its Client and this document does not exonerate parties to a transaction from exercising all their rights and obligations under the transaction documents. This document cannot be reproduced except in full, without prior written approval of the Company. Any unauthorized alteration, forgery or falsification of the content or appearance of this document is unlawful and offenders may be prosecuted to the fullest extent of the law.

Report Number :TERF2304000923ER
 Operation Mode :BLE 2M
 Test Frequency :2402 MHz
 Test Mode :Tx
 EUT Pol :E2 Plane

Test Site :SAC 2
 Test Date :2023-04-28
 Temp./Humi. :25.4/63
 Antenna Pol. :Horizontal
 Engineer :Ricky Chen

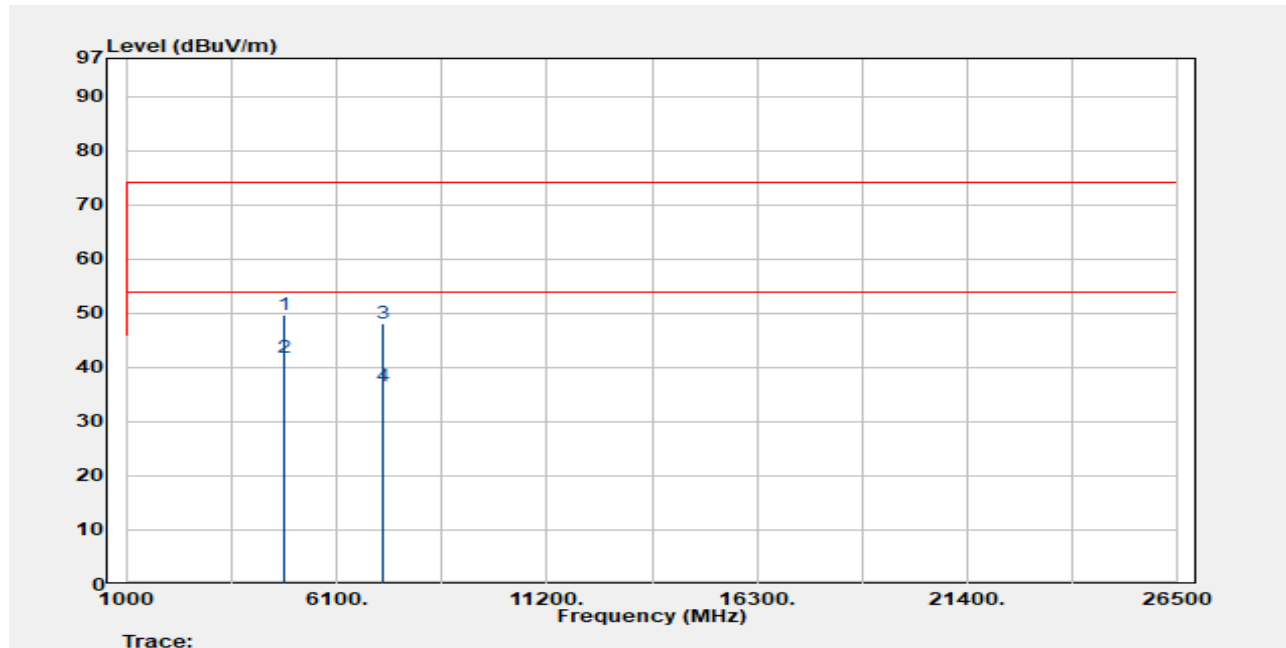

Trace:	Freq. MHz	Detector Mode PK/QP/AV	Spectrum Reading Level dBμV	Factor dB	Actual FS dBμV/m	Limit @3m dBμV/m	Margin dB
	4804.000	Peak	47.71	2.10	49.81	74.00	-24.19
	4804.000	Average	39.76	2.10	41.86	54.00	-12.14
	7206.000	Peak	40.64	7.56	48.20	74.00	-25.80
	7206.000	Average	29.09	7.56	36.65	54.00	-17.35

Unless otherwise stated the results shown in this test report refer only to the sample(s) tested and such sample(s) are retained for 90 days only.

除非另有說明，此報告結果僅對測試之樣品負責，同時此樣品僅保留90天。本報告未經本公司書面許可，不可部份複製。

This document is issued by the Company subject to its General Conditions of Service printed overleaf, available on request or accessible at <http://www.sgs.com.tw/Terms-and-Conditions> and for electronic format documents, subject to Terms and Conditions for Electronic Documents at <http://www.sgs.com.tw/Terms-and-Conditions>. Attention is drawn to the limitation of liability, indemnification and jurisdiction issues defined therein. Any holder of this document is advised that information contained hereon reflects the Company's findings at the time of its intervention only and within the limits of Client's instructions, if any. The Company's sole responsibility is to its Client and this document does not exonerate parties to a transaction from exercising all their rights and obligations under the transaction documents. This document cannot be reproduced except in full, without prior written approval of the Company. Any unauthorized alteration, forgery or falsification of the content or appearance of this document is unlawful and offenders may be prosecuted to the fullest extent of the law.

Report Number :TERF2304000923ER
 Operation Mode :BLE 2M
 Test Frequency :2442 MHz
 Test Mode :Tx
 EUT Pol :E2 Plane

Test Site :SAC 2
 Test Date :2023-04-28
 Temp./Humi. :25.4/63
 Antenna Pol. :Vertical
 Engineer :Ricky Chen

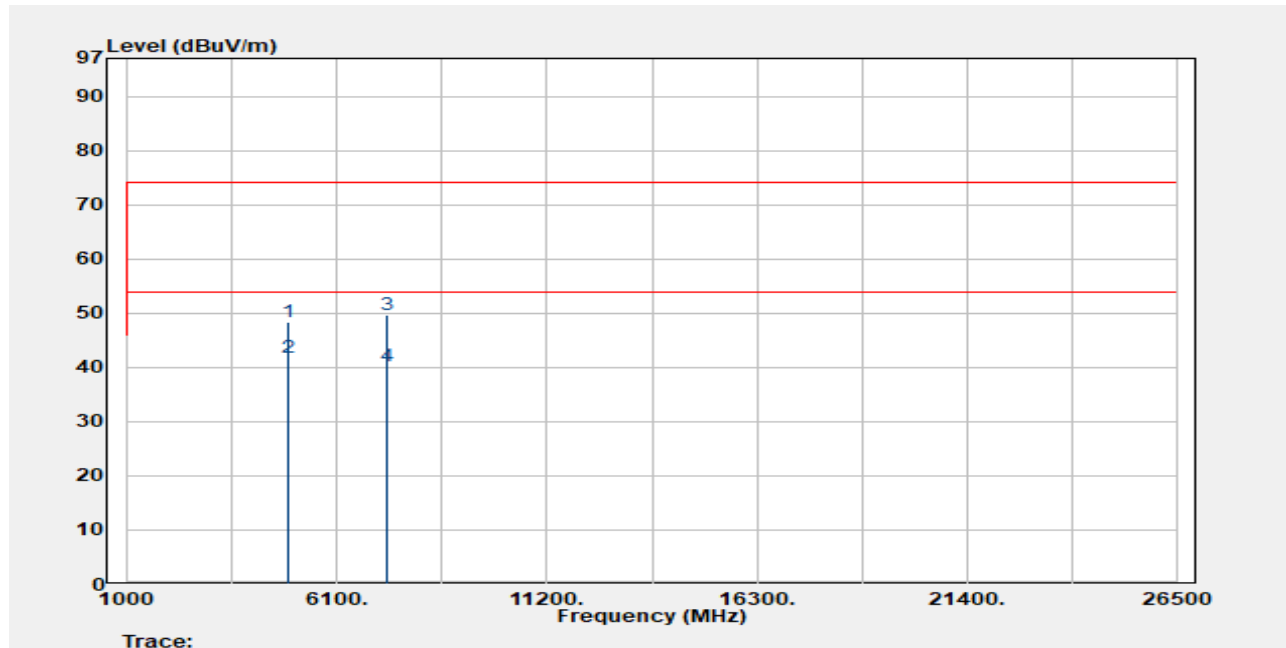

Freq. MHz	Detector Mode PK/QP/AV	Spectrum Reading Level dBμV	Factor dB	Actual FS dBμV/m	Limit @3m dBμV/m	Margin dB
4884.000	Peak	45.66	2.67	48.33	74.00	-25.67
4884.000	Average	39.03	2.67	41.70	54.00	-12.30
7326.000	Peak	42.05	7.71	49.76	74.00	-24.24
7326.000	Average	32.51	7.71	40.22	54.00	-13.78

Unless otherwise stated the results shown in this test report refer only to the sample(s) tested and such sample(s) are retained for 90 days only.

除非另有說明，此報告結果僅對測試之樣品負責，同時此樣品僅保留90天。本報告未經本公司書面許可，不可部份複製。

This document is issued by the Company subject to its General Conditions of Service printed overleaf, available on request or accessible at <http://www.sgs.com.tw/Terms-and-Conditions> and for electronic format documents, subject to Terms and Conditions for Electronic Documents at <http://www.sgs.com.tw/Terms-and-Conditions>. Attention is drawn to the limitation of liability, indemnification and jurisdiction issues defined therein. Any holder of this document is advised that information contained hereon reflects the Company's findings at the time of its intervention only and within the limits of Client's instructions, if any. The Company's sole responsibility is to its Client and this document does not exonerate parties to a transaction from exercising all their rights and obligations under the transaction documents. This document cannot be reproduced except in full, without prior written approval of the Company. Any unauthorized alteration, forgery or falsification of the content or appearance of this document is unlawful and offenders may be prosecuted to the fullest extent of the law.

Report Number :TERF2304000923ER
 Operation Mode :BLE 2M
 Test Frequency :2442 MHz
 Test Mode :Tx
 EUT Pol :E2 Plane

Test Site :SAC 2
 Test Date :2023-04-28
 Temp./Humi. :25.4/63
 Antenna Pol. :Horizontal
 Engineer :Ricky Chen

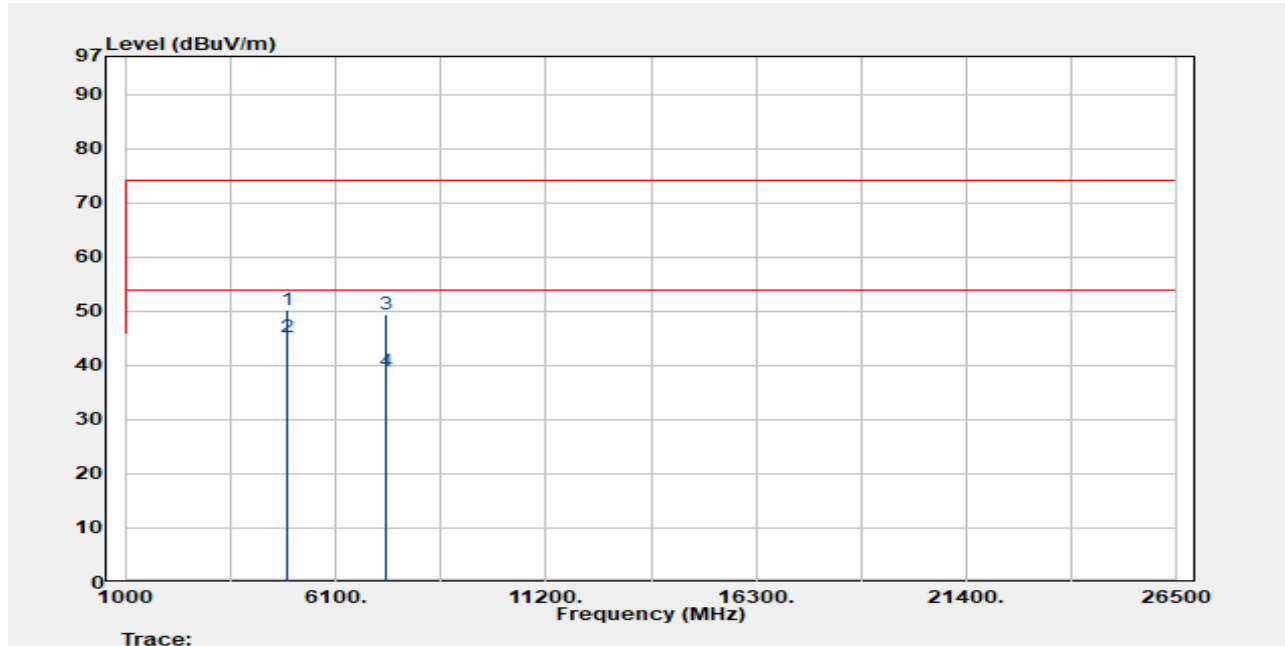

Freq. MHz	Detector Mode PK/QP/AV	Spectrum Reading Level dBμV	Factor dB	Actual FS dBμV/m	Limit @3m dBμV/m	Margin dB
4884.000	Peak	47.63	2.67	50.30	74.00	-23.70
4884.000	Average	42.56	2.67	45.23	54.00	-8.77
7326.000	Peak	41.78	7.71	49.49	74.00	-24.51
7326.000	Average	31.20	7.71	38.91	54.00	-15.09

Unless otherwise stated the results shown in this test report refer only to the sample(s) tested and such sample(s) are retained for 90 days only.

除非另有說明，此報告結果僅對測試之樣品負責，同時此樣品僅保留90天。本報告未經本公司書面許可，不可部份複製。

This document is issued by the Company subject to its General Conditions of Service printed overleaf, available on request or accessible at <http://www.sgs.com.tw/Terms-and-Conditions> and for electronic format documents, subject to Terms and Conditions for Electronic Documents at <http://www.sgs.com.tw/Terms-and-Conditions>. Attention is drawn to the limitation of liability, indemnification and jurisdiction issues defined therein. Any holder of this document is advised that information contained hereon reflects the Company's findings at the time of its intervention only and within the limits of Client's instructions, if any. The Company's sole responsibility is to its Client and this document does not exonerate parties to a transaction from exercising all their rights and obligations under the transaction documents. This document cannot be reproduced except in full, without prior written approval of the Company. Any unauthorized alteration, forgery or falsification of the content or appearance of this document is unlawful and offenders may be prosecuted to the fullest extent of the law.

Report Number :TERF2304000923ER
 Operation Mode :BLE 2M
 Test Frequency :2480 MHz
 Test Mode :Tx
 EUT Pol :E2 Plane

Test Site :SAC 2
 Test Date :2023-04-28
 Temp./Humi. :25.4/63
 Antenna Pol. :Vertical
 Engineer :Ricky Chen

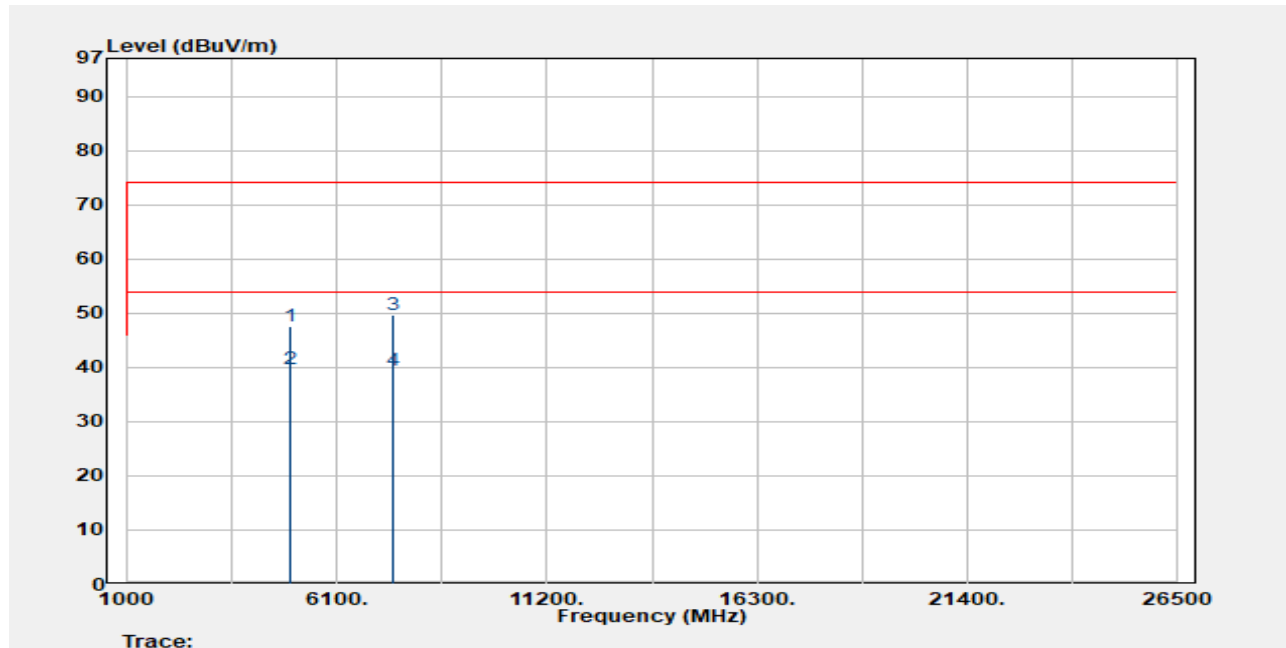

Freq. MHz	Detector Mode PK/QP/AV	Spectrum Reading Level dBμV	Factor dB	Actual FS dBμV/m	Limit @3m dBμV/m	Margin dB
4960.000	Peak	44.68	2.80	47.48	74.00	-26.52
4960.000	Average	36.98	2.80	39.78	54.00	-14.22
7440.000	Peak	41.70	7.97	49.67	74.00	-24.33
7440.000	Average	31.56	7.97	39.53	54.00	-14.47

Unless otherwise stated the results shown in this test report refer only to the sample(s) tested and such sample(s) are retained for 90 days only.

除非另有說明，此報告結果僅對測試之樣品負責，同時此樣品僅保留90天。本報告未經本公司書面許可，不可部份複製。

This document is issued by the Company subject to its General Conditions of Service printed overleaf, available on request or accessible at <http://www.sgs.com.tw/Terms-and-Conditions> and for electronic format documents, subject to Terms and Conditions for Electronic Documents at <http://www.sgs.com.tw/Terms-and-Conditions>. Attention is drawn to the limitation of liability, indemnification and jurisdiction issues defined therein. Any holder of this document is advised that information contained hereon reflects the Company's findings at the time of its intervention only and within the limits of Client's instructions, if any. The Company's sole responsibility is to its Client and this document does not exonerate parties to a transaction from exercising all their rights and obligations under the transaction documents. This document cannot be reproduced except in full, without prior written approval of the Company. Any unauthorized alteration, forgery or falsification of the content or appearance of this document is unlawful and offenders may be prosecuted to the fullest extent of the law.

Report Number :TERF2304000923ER
 Operation Mode :BLE 2M
 Test Frequency :2480 MHz
 Test Mode :Tx
 EUT Pol :E2 Plane

Test Site :SAC 2
 Test Date :2023-04-28
 Temp./Humi. :25.4/63
 Antenna Pol. :Horizontal
 Engineer :Ricky Chen

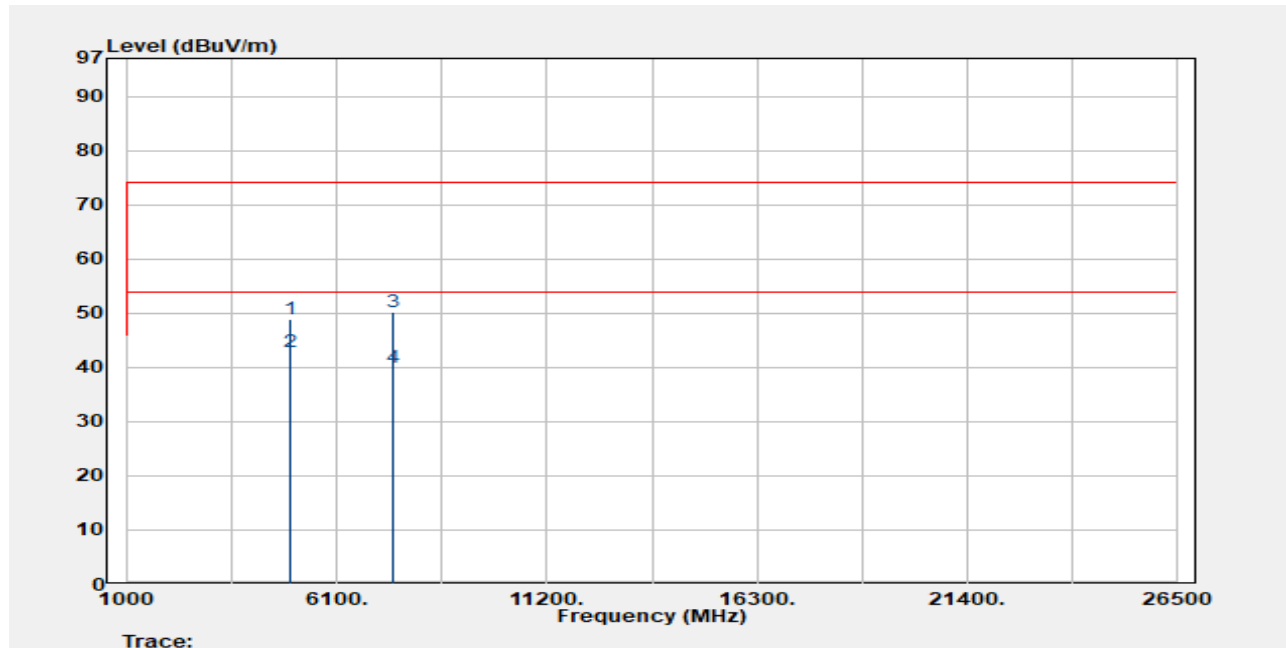

Freq. MHz	Detector Mode PK/QP/AV	Spectrum Reading Level dBμV	Factor dB	Actual FS dBμV/m	Limit @3m dBμV/m	Margin dB
4960.000	Peak	45.99	2.80	48.79	74.00	-25.21
4960.000	Average	40.12	2.80	42.92	54.00	-11.08
7440.000	Peak	42.15	7.97	50.12	74.00	-23.88
7440.000	Average	31.87	7.97	39.84	54.00	-14.16

Unless otherwise stated the results shown in this test report refer only to the sample(s) tested and such sample(s) are retained for 90 days only.

除非另有說明，此報告結果僅對測試之樣品負責，同時此樣品僅保留90天。本報告未經本公司書面許可，不可部份複製。

This document is issued by the Company subject to its General Conditions of Service printed overleaf, available on request or accessible at <http://www.sgs.com.tw/Terms-and-Conditions> and for electronic format documents, subject to Terms and Conditions for Electronic Documents at <http://www.sgs.com.tw/Terms-and-Conditions>. Attention is drawn to the limitation of liability, indemnification and jurisdiction issues defined therein. Any holder of this document is advised that information contained hereon reflects the Company's findings at the time of its intervention only and within the limits of Client's instructions, if any. The Company's sole responsibility is to its Client and this document does not exonerate parties to a transaction from exercising all their rights and obligations under the transaction documents. This document cannot be reproduced except in full, without prior written approval of the Company. Any unauthorized alteration, forgery or falsification of the content or appearance of this document is unlawful and offenders may be prosecuted to the fullest extent of the law.

12 POWER SPECTRAL DENSITY

12.1 Standard Applicable:

The power spectral density conducted from the intentional radiator to the antenna shall not be greater than 8dBm in any 3 kHz band during any time interval of continuous transmission.

12.2 Test Setup

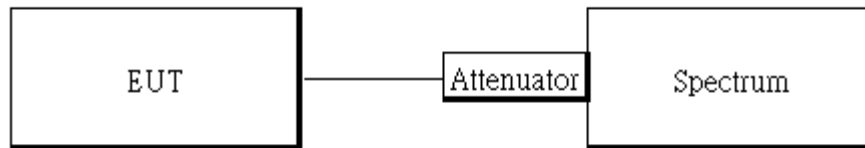

12.3 Measurement Procedure:

1. Set analyzer center frequency to DTS channel center frequency.
2. The testing follows the Measurement Procedure of FCC KDB 558074 D01 DTS Meas. Guidance.
3. Set the span to 1.5 times the DTS channel bandwidth.
4. Set the RBW = 3 kHz. & the VBW = 10 kHz
5. Detector = peak.
6. Sweep time = auto couple.
7. Trace mode = max hold.
8. Allow trace to fully stabilize.
9. Use the peak marker function to determine the maximum amplitude level.

12.4 Measurement Result:

BLE 1M mode

Frequency (MHz)	RF Power Density (dBm/3kHz)	Maximum Limit (dBm/3kHz)	Result
2402	-3.49	8	PASS
2442	-4.63	8	PASS
2480	-4.97	8	PASS

NOTE: cable loss as 0.3dB that offsets in the spectrum

Unless otherwise stated the results shown in this test report refer only to the sample(s) tested and such sample(s) are retained for 90 days only.
 除非另有說明，此報告結果僅對測試之樣品負責，同時此樣品僅保留90天。本報告未經本公司書面許可，不可部份複製。

This document is issued by the Company subject to its General Conditions of Service printed overleaf, available on request or accessible at <http://www.sgs.com.tw/Terms-and-Conditions> and for electronic format documents, subject to Terms and Conditions for Electronic Documents at <http://www.sgs.com.tw/Terms-and-Conditions>. Attention is drawn to the limitation of liability, indemnification and jurisdiction issues defined therein. Any holder of this document is advised that information contained hereon reflects the Company's findings at the time of its intervention only and within the limits of Client's instructions, if any. The Company's sole responsibility is to its Client and this document does not exonerate parties to a transaction from exercising all their rights and obligations under the transaction documents. This document cannot be reproduced except in full, without prior written approval of the Company. Any unauthorized alteration, forgery or falsification of the content or appearance of this document is unlawful and offenders may be prosecuted to the fullest extent of the law.

BLE 2M mode

Frequency (MHz)	RF Power Density (dBm/3kHz)	Maximum Limit (dBm/3kHz)	Result
2402	-8.64	8	PASS
2442	-6.63	8	PASS
2480	-8.30	8	PASS

NOTE: cable loss as 0.3dB that offsets in the spectrum

PSD_BLE 1M_LowCH00-2402MHz

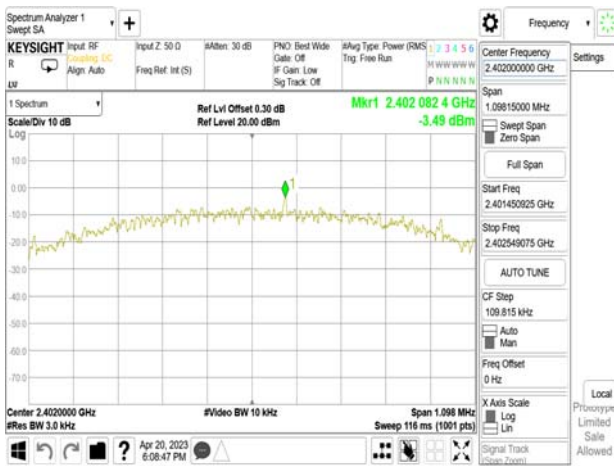

PSD_BLE 1M_HighCH39-2480MHz

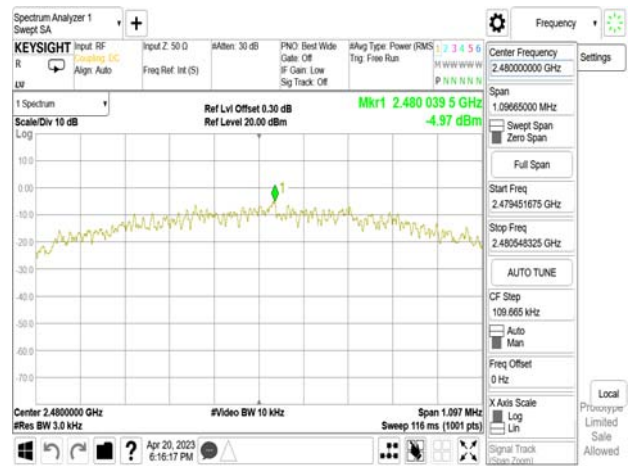

PSD_BLE 1M_MidCH20-2442MHz

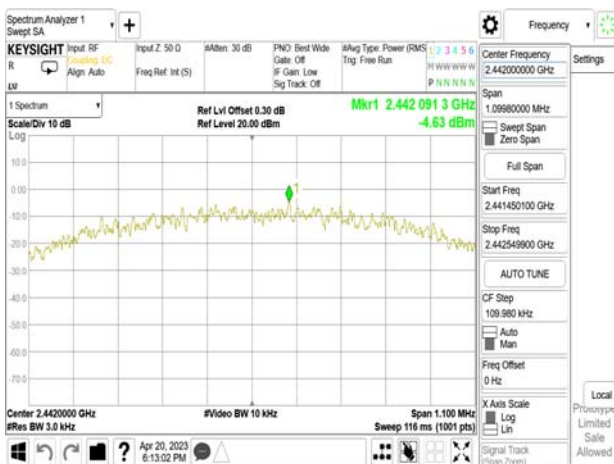

PSD_BLE 2M_LowCH00-2402MHz

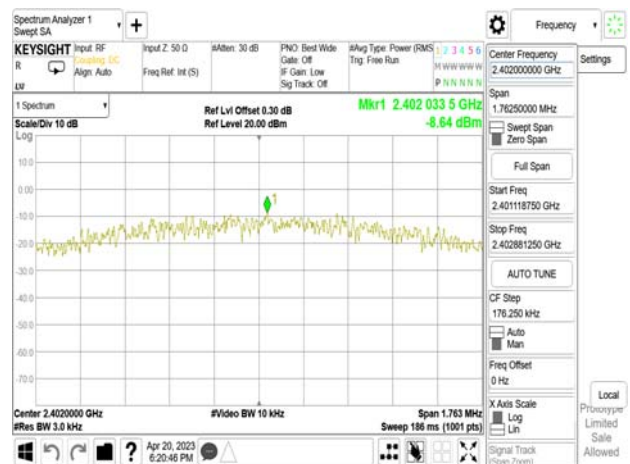

Unless otherwise stated the results shown in this test report refer only to the sample(s) tested and such sample(s) are retained for 90 days only.

除非另有說明，此報告結果僅對測試之樣品負責，同時此樣品僅保留90天。本報告未經本公司書面許可，不可部份複製。

This document is issued by the Company subject to its General Conditions of Service printed overleaf, available on request or accessible at <http://www.sgs.com.tw/Terms-and-Conditions> and for electronic format documents, subject to Terms and Conditions for Electronic Documents at <http://www.sgs.com.tw/Terms-and-Conditions>. Attention is drawn to the limitation of liability, indemnification and jurisdiction issues defined therein. Any holder of this document is advised that information contained herein reflects the Company's findings at the time of its intervention only and within the limits of Client's instructions, if any. The Company's sole responsibility is to its Client and this document does not exonerate parties to a transaction from exercising all their rights and obligations under the transaction documents. This document cannot be reproduced except in full, without prior written approval of the Company. Any unauthorized alteration, forgery or falsification of the content or appearance of this document is unlawful and offenders may be prosecuted to the fullest extent of the law.

PSD_BLE 2M_MidCH20-2442MHz

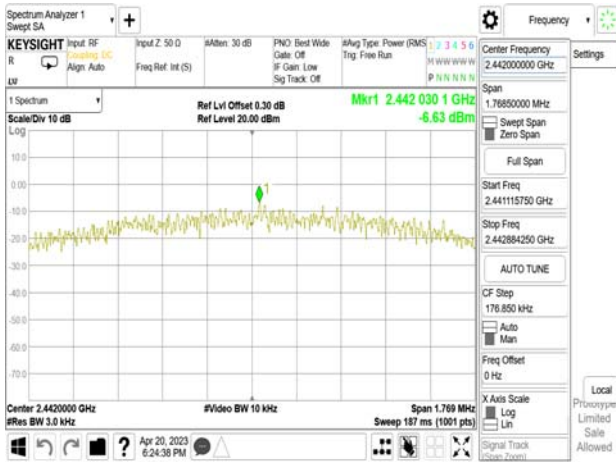

PSD_BLE 2M_HighCH39-2480MHz

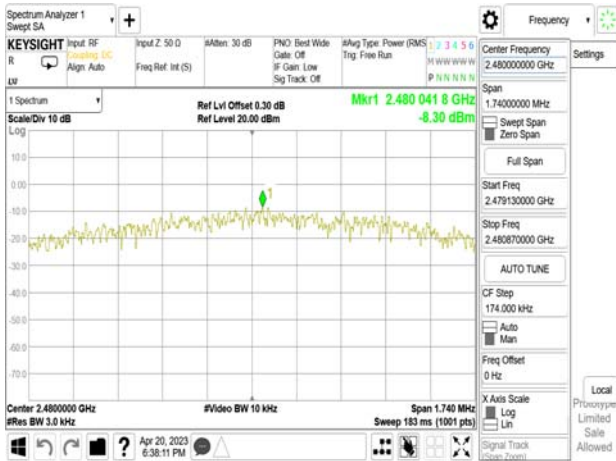

Unless otherwise stated the results shown in this test report refer only to the sample(s) tested and such sample(s) are retained for 90 days only.

除非另有說明，此報告結果僅對測試之樣品負責，同時此樣品僅保留90天。本報告未經本公司書面許可，不可部份複製。

This document is issued by the Company subject to its General Conditions of Service printed overleaf, available on request or accessible at <http://www.sgs.com.tw/Terms-and-Conditions> and for electronic format documents, subject to Terms and Conditions for Electronic Documents at <http://www.sgs.com.tw/Terms-and-Conditions>. Attention is drawn to the limitation of liability, indemnification and jurisdiction issues defined therein. Any holder of this document is advised that information contained hereon reflects the Company's findings at the time of its intervention only and within the limits of Client's instructions, if any. The Company's sole responsibility is to its Client and this document does not exonerate parties to a transaction from exercising all their rights and obligations under the transaction documents. This document cannot be reproduced except in full, without prior written approval of the Company. Any unauthorized alteration, forgery or falsification of the content or appearance of this document is unlawful and offenders may be prosecuted to the fullest extent of the law.

13 ANTENNA REQUIREMENT

13.1 Standard Applicable:

An intentional radiator shall be designed to ensure that no antenna other than that furnished by the responsible party shall be used with the device. The use of a permanently attached antenna or of an antenna that uses a unique coupling to the intentional radiator shall be considered sufficient to comply with the provisions of this section. The manufacturer may design the unit so that a broken antenna can be replaced by the user, but the use of a standard antenna jack or electrical connector is prohibited. This requirement does not apply to carrier current devices or to devices operated under the provisions of §§ 15.211, 15.213, 15.217, 15.219, 15.221, or § 15.236. Further, this requirement does not apply to intentional radiators that must be professionally installed, such as perimeter protection systems and some field disturbance sensors, or to other intentional radiators which, in accordance with § 15.31(d), must be measured at the installation site. However, the installer shall be responsible for ensuring that the proper antenna is employed so that the limits in this part are not exceeded.

13.2 Antenna Connected Construction:

The antenna complies with this requirement and no consideration of replacement. Please see EUT photo for details.

~ End of Report ~

Unless otherwise stated the results shown in this test report refer only to the sample(s) tested and such sample(s) are retained for 90 days only.
除非另有說明，此報告結果僅對測試之樣品負責，同時此樣品僅保留90天。本報告未經本公司書面許可，不可部份複製。

This document is issued by the Company subject to its General Conditions of Service printed overleaf, available on request or accessible at <http://www.sgs.com.tw/Terms-and-Conditions> and for electronic format documents, subject to Terms and Conditions for Electronic Documents at <http://www.sgs.com.tw/Terms-and-Conditions>. Attention is drawn to the limitation of liability, indemnification and jurisdiction issues defined therein. Any holder of this document is advised that information contained hereon reflects the Company's findings at the time of its intervention only and within the limits of Client's instructions, if any. The Company's sole responsibility is to its Client and this document does not exonerate parties to a transaction from exercising all their rights and obligations under the transaction documents. This document cannot be reproduced except in full, without prior written approval of the Company. Any unauthorized alteration, forgery or falsification of the content or appearance of this document is unlawful and offenders may be prosecuted to the fullest extent of the law.