



FCC RADIO TEST REPORT

Applicant : Frontiir Pte (with Frontiir Co LTD, Myanmar)
Address : 809 Yakima Drive, Fremont, California 94539,
United States
Equipment : 802.11ac 2x2 dual-band AP
Model No. : LCA-F
Trade Name : FRONTiir
FCC ID. : 2AQLFLCF

I HEREBY CERTIFY THAT :

The sample was received on Feb. 13, 2020 and the testing was completed on Mar. 19, 2020 at CerpPASS Technology Corp. The test result refers exclusively to the test presented test model / sample. Without written approval of CerpPASS Technology Corp., the test report shall not be reproduced except in full.

Approved by:

Mark Liao / Supervisor

Laboratory Accreditation:

CerpPASS Technology Corporation Test Laboratory





CONTENTS

- 1. Summary of Test Procedure and Test Results 5
 - 1.1. Applicable Standards 5
- 2. Test Configuration of Equipment under Test 6
 - 2.1. Feature of Equipment under Test..... 6
 - 2.2. Carrier Frequency of Channels 7
 - 2.3. Test Mode and Test Software 8
 - 2.4. Description of Test System..... 9
 - 2.5. General Information of Test..... 10
 - 2.6. Measurement Uncertainty 10
- 3. Test Equipment and Ancillaries Used for Tests 11
- 4. Antenna Requirements 13
 - 4.1. Standard Applicable 13
 - 4.2. Antenna Construction and Directional Gain..... 13
- 5. Test of AC Power Line Conducted Emission 14
 - 5.1. Test Limit 14
 - 5.2. Test Procedures 14
 - 5.3. Typical Test Setup 15
 - 5.4. Test Result and Data 16
 - 5.5. Test Photographs 20
- 6. Test of Spurious Emission (Radiated) 22
 - 6.1. Test Limit 22
 - 6.2. Test Procedures 23
 - 6.3. Typical Test Setup 24
 - 6.4. Test Result and Data (9kHz ~ 30MHz)..... 25
 - 6.5. Test Result and Data (30MHz ~ 1GHz)..... 25
 - 6.6. Test Result and Data (1GHz ~ 40GHz)..... 29
 - 6.7. Restricted Bands of Operation 65
 - 6.8. Test Photographs (30MHz ~ 1GHz) 66
 - 6.9. Test Photographs (1GHz ~ 40GHz) 68
- 7. On Time, Duty Cycle and Measurement methods 69
 - 7.1. Test Limit 69
 - 7.2. Test Procedure 69
 - 7.3. Test Setup Layout 69
 - 7.4. Test Result and Data 69
 - 7.5. Measurement Methods 69
- 8. 6dB Bandwidth & 99% Occupied Bandwidth 71
 - 8.1. Test Limit 71
 - 8.2. Test Procedure 71
 - 8.3. Test Setup Layout 71
 - 8.4. Test Result and Data (6dB Bandwidth) 71
 - 8.5. Test Result and Data (99% Occupied Bandwidth) 72
- 9. 26dB Bandwidth & 99% Occupied Bandwidth 81
 - 9.1. Test Limit 81
 - 9.2. Test Procedure 81



- 9.3. Test Setup Layout81
- 9.4. Test Result and Data (26dB Bandwidth)81
- 9.5. Test Result and Data (99% Occupied Bandwidth)82
- 10. Average Power..... 91
 - 10.1. Test Limit91
 - 10.2. Test Procedure92
 - 10.3. Test Setup Layout92
 - 10.4. Test Result and Data.....93
- 11. Power Spectral Density..... 95
 - 11.1. Test Limit95
 - 11.2. Test Procedure95
 - 11.3. Test Setup Layout95
 - 11.4. Test Result and Data.....96
- 12. Frequency Stability..... 105
 - 12.1. Test Procedure 105
 - 12.2. Test Setup Layout 105
 - 12.3. Test Result and Data..... 106
- 13. Radio Frequency Exposure 107
 - 13.1. Applicable Standards 107
 - 13.2. EUT Specification 107
 - 13.3. Test Results..... 107
 - 13.4. Calculation..... 108
 - 13.5. Maximum Permissible Exposure..... 109



History of this test report

Report No.	Issue Date	Description
TEFE2002059	Mar. 27, 2020	Original



1. Summary of Test Procedure and Test Results

1.1. Applicable Standards

ANSI C63.10:2013

FCC Rules and Regulations Part 15 Subpart E §15.407

KDB789033

FCC Rule	Description of Test	Result
15.203	Antenna Requirement	PASS
15.207(a)	AC Power Line Conducted Emission	PASS
15.407(b) 15.209	Radiated Spurious Emission	PASS
15.407(a)	26 dB & Occupied Bandwidth	PASS
15.407	6 dB Bandwidth	PASS
15.407 (a) & (a)(3)	Average Power	PASS
15.407(a)	Power Spectral Density	PASS
15.407(g)	Frequency Stability	PASS
2.1091	Radio Frequency Exposure	PASS

*The lab has lowered the uncertainty risk of test equipment, environment, and staff technicians according to ISO-IEC17025. Therefore we define test result as compliant when it complies with the standard without further evaluation of test result uncertainty.

*This EUT has been also tested and compiled with the requirement of FCC Part 15, Subpart B, recorded in a separate test report(TEFD2002059).



2. Test Configuration of Equipment under Test

2.1. Feature of Equipment under Test

Frequency Range	802.11b/g/n: 2400-2483.5MHz 802.11a/n/ac: 5150-5250MHz, 5725-5850MHz
Modulation Type	802.11b: CCK, DQPSK, DBPSK 802.11g/n/a: BPSK, QPSK, 16QAM, 64QAM 802.11ac: BPSK, QPSK, 16QAM, 64QAM, 256QAM
Modulation Technology	DSSS, OFDM
Data Rate	WLAN: 802.11b: 1, 2, 5.5, 11Mbps 802.11g: 6, 9, 12, 18, 24, 36, 48, 54Mbps 802.11n: MCS0 – MCS15, HT20/40 802.11a: 6, 9, 12, 18, 24, 36, 48, 54Mbps 802.11ac: MCS0 – MCS9, VHT20/40/80
Antenna Type	Internal Antenna
Antenna Gain	2400-2483.5MHz: ANT A: 4.6dBi, ANT B: 5.3dBi 5150-5250MHz: ANT A: 4.5dBi, ANT B: 4.7dBi 5725-5850MHz: ANT A: 4.5dBi, ANT B: 4.7dBi

Note:

- 1.For more details, please refer to the User’s manual of the EUT.
- 2.MIMO operational in 5GHz and 2.4GHz.



2.2. Carrier Frequency of Channels

Band: 5150MHz-5250MHz

802.11a, 802.11n HT20, 802.11ac VHT20

Channel	Frequency(MHz)	Channel	Frequency(MHz)
*36	5180	44	5220
*40	5200	*48	5240

802.11n HT40, 802.11ac VHT40

Channel	Frequency(MHz)	Channel	Frequency(MHz)
*38	5190	*46	5230

802.11ac VHT80

Channel	Frequency(MHz)
*42	5210

Band: 5725MHz -5850MHz

802.11a, 802.11n HT20, 802.11ac VHT20

Channel	Frequency(MHz)	Channel	Frequency(MHz)
*149	5745	161	5805
153	5765	*165	5825
*157	5785		

802.11n HT40, 802.11ac VHT40

Channel	Frequency(MHz)	Channel	Frequency(MHz)
*151	5755	*159	5795

802.11ac VHT80

Channel	Frequency(MHz)
*155	5775

Note: Channels remarked * are selected to perform test.



2.3. Test Mode and Test Software

- a. During testing, the interface cables and equipment positions were varied according to ANSI C63.10.
- b. The complete test system included remote workstation and EUT for RF test. The remote workstation included Notebook.
- c. An executive program, " QRCT ver. 3.0.276.0" under Windows OS system was executed to transmit and receive data via WLAN.
- d. The following test modes were performed for the test:

Conducted Emissions from the AC mains power ports	
Test Mode	Operating Description
1	802.11a (6Mbps) , Power from Adapter
2	802.11ac VHT20 (6.5Mbps) , Power from Adapter
3	802.11ac VHT40 (13.5Mbps) , Power from Adapter
4	802.11ac VHT80 (29.3Mbps) , Power from Adapter
5	802.11a (6Mbps) , Power from PoE
6	802.11ac VHT20 (6.5Mbps) , Power from PoE
7	802.11ac VHT40 (13.5Mbps) , Power from PoE
8	802.11ac VHT80 (29.3Mbps) , Power from PoE
caused "Test Mode 3, 7" generated the worst case, it was reported as the final data.	
Radiation Emissions (30MHz ~ 1GHz)	
Test Mode	Operating Description
1	802.11a (6Mbps) , Power from Adapter
2	802.11ac VHT20 (6.5Mbps) , Power from Adapter
3	802.11ac VHT40 (13.5Mbps) , Power from Adapter
4	802.11ac VHT80 (29.3Mbps) , Power from Adapter
5	802.11a (6Mbps) , Power from PoE
6	802.11ac VHT20 (6.5Mbps) , Power from PoE
7	802.11ac VHT40 (13.5Mbps) , Power from PoE
8	802.11ac VHT80 (29.3Mbps) , Power from PoE
caused "Test Mode 3, 7" generated the worst case, it was reported as the final data.	
Radiation Emissions (1GHz ~ 40GHz)	
Test Mode	Operating Description
1	802.11a (6Mbps)
2	802.11ac VHT20 (6.5Mbps)
3	802.11ac VHT40 (13.5Mbps)
4	802.11ac VHT80 (29.3Mbps)
caused "Test Mode 1~4" generated the worst case, they were reported as the final data.	



2.4. Description of Test System

RF Conducted				
Equipment	Brand	Model	Length/Type	Power cord/Length/Type
Notebook	DELL	Vostro 3560	N/A	Adapter / 1.8m / NS
Adapter	APD	WA-36A12R	1.5m / NS	N/A
RJ45 Cable	N/A	N/A	1.2m / NS	N/A
Radiated Emissions				
Equipment	Brand	Model	Length/Type	Power cord/Length/Type
Notebook	ASUS	P2430U	N/A	Adapter / 1.8m / NS
Adapter	APD	WA-36A12R	1.5m / NS	N/A
POE	Gospower	G0720-240-100	N/A	N/A
RJ45 Cable	N/A	N/A	1.2m / NS	N/A
AC Power Line Conducted Emission				
Equipment	Brand	Model	Length/Type	Power cord/Length/Type
Notebook	ASUS	P2430U	N/A	Adapter / 1.8m / NS
Adapter	APD	WA-36A12R	1.5m / NS	N/A
POE	Gospower	G0720-240-100	N/A	N/A
RJ45 Cable	N/A	N/A	1.2m / NS	N/A
RJ45 Cable	N/A	N/A	1.2m / NS	N/A

**2.5. General Information of Test**

Test Site	Cerpass Technology Corporation Test Laboratory Address: No.10, Ln. 2, Lianfu St., Luzhu Dist., Taoyuan City 33848, Taiwan (R.O.C.) Tel:+886-3-3226-888 Fax:+886-3-3226-881	
	FCC	TW1439, TW1079
	IC	4934E-1, 4934E-2
	VCCI	T-2205 for Telecommunication test C-4663 for Conducted emission test R-4218 for Radiated emission test G-10812, G-10813 for radiated disturbance above 1GHz
Frequency Range Investigated:	Conducted: from 150kHz to 30 MHz Radiation: from 30 MHz to 40,000MHz	
Test Distance:	The test distance of radiated emission from antenna to EUT is 3 M.	

Test Item	Test Site	Finish Date	Environmental Conditions	Tested By
RF Conducted	RFCON01-NK	2020/03/17	23°C / 65%	Dian Chen
Radiated Emissions	3M02-NK	2020/03/19	22°C / 48%	Vic Yeh
AC Power Line Conducted Emission	CON01-NK	2020/02/29	22°C / 49%	Leon Huang

2.6. Measurement Uncertainty

Measurement Item	Uncertainty
AC Power Line Conduction(150K~30MHz)	±1.60dB
Radiated Spurious Emission(9KHz~30MHz)	±3.405dB
Radiated Spurious Emission(30MHz~1GHz)	±5.326dB
Radiated Spurious Emission(1GHz~40GHz)	±5.011dB
6dB Bandwidth	±4.407%
26dB Bandwidth	±4.459%
Occupied Bandwidth	±4.403%
Peak Output Power(Conducted Power Meter)	±1.31dB
Power Spectral Density	±2.106dB
Duty Cycle	±0.17%
Frequency Stability	±156.543Hz



3. Test Equipment and Ancillaries Used for Tests

Test Item	Radiated Emissions				
Test Site	Semi Anechoic Room(3M02-NK)				
Instrument	Manufacturer	Model No	Serial No	Calibration Date	Valid Date
Bilog Antenna	Schwarzbeck	VULB9168	275	2019/09/24	2020/09/23
Bilog Antenna	Schwarzbeck	VULB9168	369	2019/03/29	2020/03/28
Active Loop Antenna	EMCO	6507	40855	2019/05/24	2020/05/23
Horn Antenna	EMCO	3115	31589	2019/04/01	2020/03/31
Horn Antenna	EMCO	3116	31974	2019/09/17	2020/09/16
EMI Receiver	ROHDE & SCHWARZ	ESCI	101423	2019/05/14	2020/05/13
Spectrum Analyzer	ROHDE & SCHWARZ	FSP 40	100219	2019/07/22	2020/07/21
Spectrum Analyzer	ROHDE & SCHWARZ	FSV 40-N	102151	2019/08/02	2020/08/01
Preamplifier	EM Electronics corp.	EM330	60660	2020/03/16	2021/03/15
Preamplifier	EMC INSTRUMENTS	EMC051845SE	980333	2019/09/20	2020/09/19
Preamplifier	Agilent	8449B	3008A01954	2020/03/16	2021/03/15
Preamplifier	EMC INSTRUMENTS	EMC184045	980065	2019/11/07	2020/11/06
Bluetooth Tester	ROHDE & SCHWARZ	CBT	101133	2019/04/07	2020/04/06
Cable-3in1(30M-1G)	HARBOUR INDUSTRIES	LL142	CCE1315	2019/04/09	2020/04/08
Cable-3in1(30M-1G)	HARBOUR INDUSTRIES	LL142	CCE1316	2019/09/20	2020/09/19
Cable-0.5m(1G-40G)	HUBER SUHNER	SUCOFLEX 100	805443/4	2019/05/20	2020/05/19
Cable-3m(1G-40G)	HUBER SUHNER	SUCOFLEX 100	805796/4	2019/05/20	2020/05/19
Cable-8m(1G-40G)	HUBER SUHNER	SUCOFLEX 100	805795/4	2019/05/20	2020/05/19
E3	AUDIX	v8.2014-8-6	RK-000529	NA	NA

Test Item	RF Conducted				
Test Site	RFCON01-NK				
Instrument	Manufacturer	Model No	Serial No	Calibration Date	Valid Date
Spectrum Analyzer	ROHDE & SCHWARZ	FSP 40	100219	2019/07/22	2020/07/21
Spectrum Analyzer	ROHDE & SCHWARZ	FSV 40-N	102151	2019/08/02	2020/08/01
Bluetooth Tester	ROHDE & SCHWARZ	CBT	101133	2019/04/07	2020/04/06
CAX Signal Analyzer	KEYSIGHT	N9000B	MY57100339	2019/11/25	2020/11/24
Attenuator	KEYSIGHT	8491B	MY39250703	2019/09/12	2020/09/11
TEMP & HUMI CHAMBER	T-MACHINE	TMJ-9712	T-12-040111	2019/08/28	2020/08/27
Power Meter	Anritsu	ML2495A	1224005	2019/04/11	2020/04/10
Power Sensor	Anritsu	MA2411B	1207295	2019/04/09	2020/04/08



Test Item	AC Power Line Conducted Emission				
Test Site	CON01-NK				
Instrument	Manufacturer	Model No	Serial No	Calibration Date	Valid Date
EMI Receiver	ROHDE & SCHWARZ	ESCI	100821	2019/09/16	2020/09/15
Line Impedance Stabilization Network	Schwarzbeck	NSLK 8127	8127-568	2019/03/15	2020/03/14
Pulse Limiter	ROHDE & SCHWARZ	ESH3-Z2	101934	2019/03/12	2020/03/11
Cable-6m(9k~300M)	NA	EMC5D-BM-BM-6	130606	2019/03/14	2020/03/13
E3	AUDIX	v8.2014-8-6	RK-000531	NA	NA



4. Antenna Requirements

4.1. Standard Applicable

For intentional device, according to FCC 47 CFR Section 15.203, an intentional radiator shall be designed to ensure that no antenna other than that furnished by the responsible party shall be used with the device.

And according to FCC 47 CFR Section 15.407 (a), if transmitting antennas of directional gain greater than 6dBi are used, the power shall be reduced by the amount in dB that the directional gain of the antenna exceeds 6dBi.

4.2. Antenna Construction and Directional Gain

Antenna Type	Internal Antenna
Antenna Gain	2.4GHz: ANT A: 4.6 dBi ; ANT B: 5.3 dBi 5150MHz-5250MHz: ANT A: 4.5 dBi ; ANT B: 4.7 dBi 5725MHz-5850MHz: ANT A: 4.5 dBi ; ANT B: 4.7 dBi

2412-2462MHz
For Power directional gain= $G_{ant}= 5.30$ dBi For PSD directional gain = $10 \log[(10^{G1/20} + 10^{G2/20})^2 / N_{ANT}]$ = 7.97 (dBi)
5150MHz -5250MHz
For Power directional gain= $G_{ant}= 4.70$ dBi For PSD directional gain = $10 \log[(10^{G1/20} + 10^{G2/20})^2 / N_{ANT}]$ = 7.61 (dBi)
5725MHz -5850MHz
For Power directional gain= $G_{ant}= 4.70$ dBi For PSD directional gain = $10 \log[(10^{G1/20} + 10^{G2/20})^2 / N_{ANT}]$ = 7.61 (dBi)



5. Test of AC Power Line Conducted Emission

5.1. Test Limit

Conducted Emissions were measured from 150 kHz to 30 MHz with a bandwidth of 9 KHz, according to the methods defined in ANSI C63.4-2014. The EUT was placed on a nonmetallic stand in a shielded room 0.8 meters above the ground plane. The interface cables and equipment positioning were varied within limits of reasonable applications to determine the position produced maximum conducted emissions.

Frequency (MHz)	Quasi Peak (dB μ V)	Average (dB μ V)
0.15 – 0.5	66-56*	56-46*
0.5 – 5.0	56	46
5.0 – 30.0	60	50

*Decreases with the logarithm of the frequency.

5.2. Test Procedures

- a. The EUT was placed 0.4 meter from the conducting wall of the shielding room was kept at least 80 centimeters from any other grounded conducting surface.
- b. Connect EUT to the power mains through a line impedance stabilization network (LISN).
- c. All the support units are connecting to the other LISN.
- d. The LISN provides 50 ohm coupling impedance for the measuring instrument.
- e. The FCC states that a 50 ohm, 50 micro-Henry LISN should be used.
- f. Both sides of AC line were checked for maximum conducted interference.
- g. The frequency range from 150 kHz to 30 MHz was searched.
- h. Set the test-receiver system to Peak Detect Function and Specified Bandwidth with Maximum Hold Mode.



5.3. Typical Test Setup

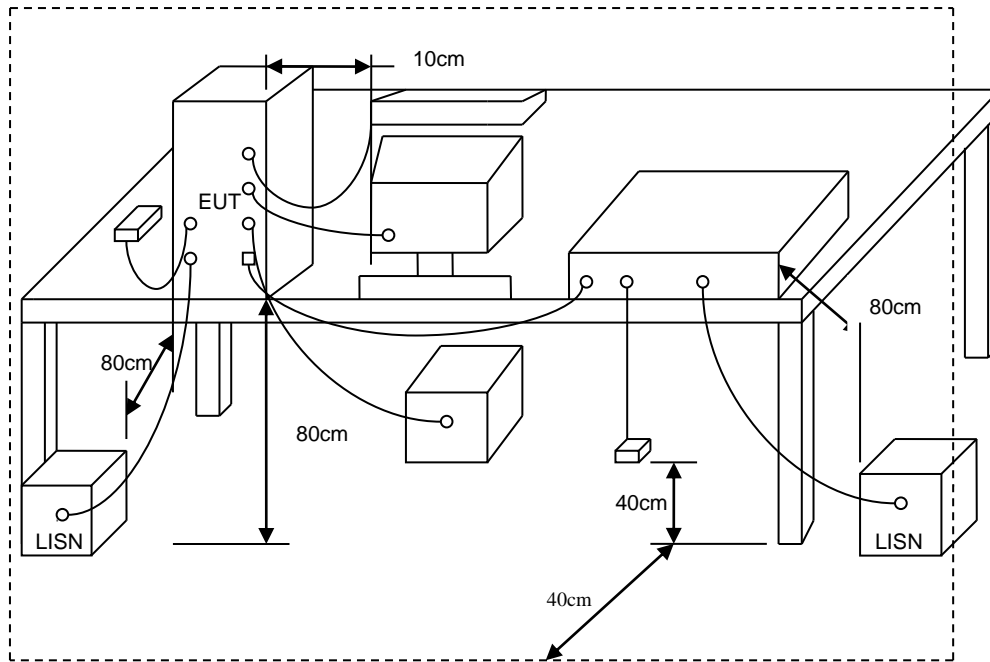



5.4. Test Result and Data

Power	: AC 120V / 60Hz	Pol/Phase	: LINE
Test Mode	: Mode 3, CH159		:

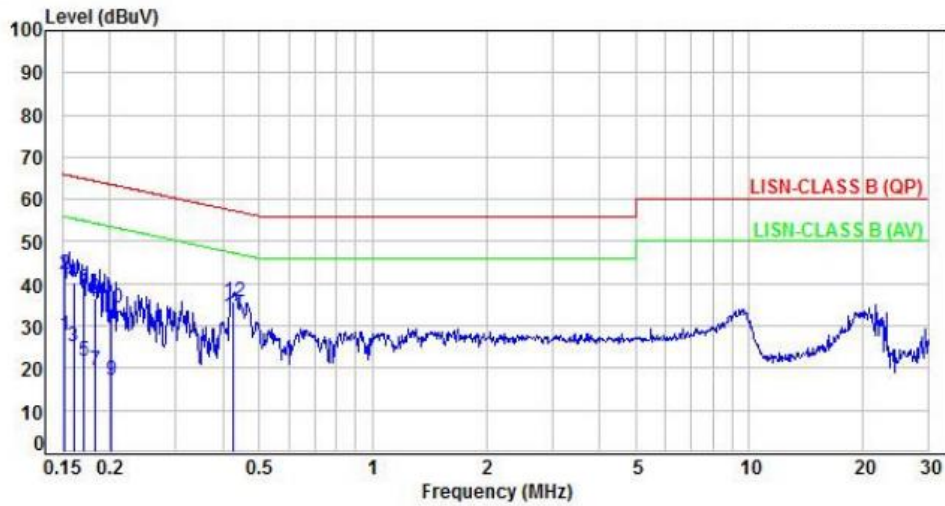

No.	Frequency (MHz)	Factor (dB)	Reading (dBuV)	Level (dBuV)	Limit (dBuV)	Margin (dB)	Detector	P/F
1	0.15	9.92	17.66	27.58	55.89	-28.31	Average	P
2	0.15	9.92	32.35	42.27	65.89	-23.62	QP	P
3	0.16	9.92	15.12	25.04	55.45	-30.41	Average	P
4	0.16	9.92	30.56	40.48	65.45	-24.97	QP	P
5	0.17	9.92	11.92	21.84	54.90	-33.06	Average	P
6	0.17	9.92	28.81	38.73	64.90	-26.17	QP	P
7	0.18	9.92	9.45	19.37	54.34	-34.97	Average	P
8	0.18	9.92	26.54	36.46	64.34	-27.88	QP	P
9	0.20	9.92	7.36	17.28	53.56	-36.28	Average	P
10	0.20	9.92	24.37	34.29	63.56	-29.27	QP	P
11	0.43	9.94	22.33	32.27	47.34	-15.07	Average	P
12	0.43	9.94	25.87	35.81	57.34	-21.53	QP	P

Note: Level=Reading+Factor
Margin=Level-Limit
Factor=(LISN or ISN or Current Probe)Factor + Cable Loss



Power	: AC 120V / 60Hz	Pol/Phase	: NEUTRAL
Test Mode	: Mode 3, CH159		:

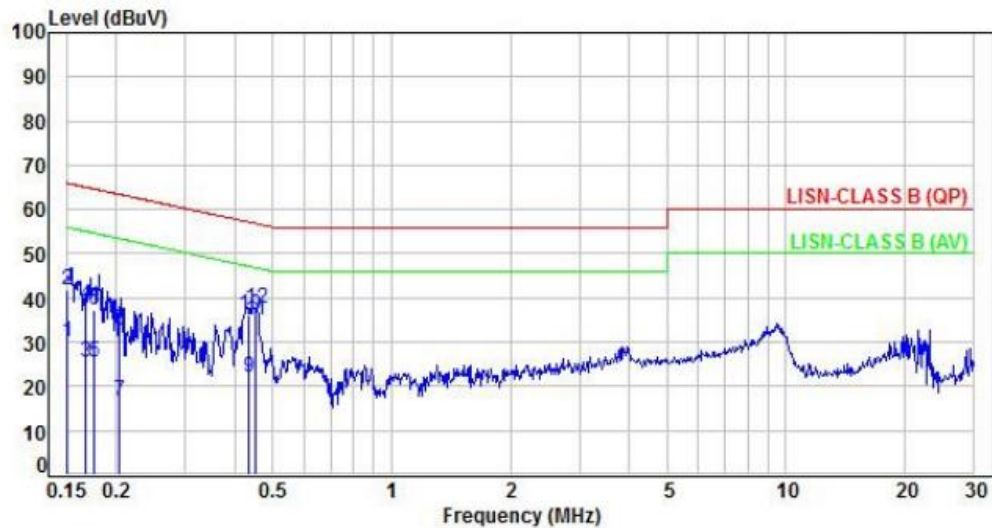

No.	Frequency (MHz)	Factor (dB)	Reading (dBuV)	Level (dBuV)	Limit (dBuV)	Margin (dB)	Detector	P/F
1	0.15	9.95	20.04	29.99	55.95	-25.96	Average	P
2	0.15	9.95	31.92	41.87	65.95	-24.08	QP	P
3	0.17	9.95	15.68	25.63	55.06	-29.43	Average	P
4	0.17	9.95	28.32	38.27	65.06	-26.79	QP	P
5	0.18	9.95	15.47	25.42	54.66	-29.24	Average	P
6	0.18	9.95	27.18	37.13	64.66	-27.53	QP	P
7	0.20	9.95	6.85	16.80	53.47	-36.67	Average	P
8	0.20	9.95	22.90	32.85	63.47	-30.62	QP	P
9	0.44	9.96	12.15	22.11	47.13	-25.02	Average	P
10	0.44	9.96	25.99	35.95	57.13	-21.18	QP	P
11	0.45	9.96	25.16	35.12	46.86	-11.74	Average	P
12	0.45	9.96	27.78	37.74	56.86	-19.12	QP	P

Note: Level=Reading+Factor
 Margin=Level-Limit
 Factor=(LISN or ISN or Current Probe)Factor + Cable Loss



Power	: AC 120V / 60Hz	Pol/Phase	: LINE
Test Mode	: Mode 7, CH159		:

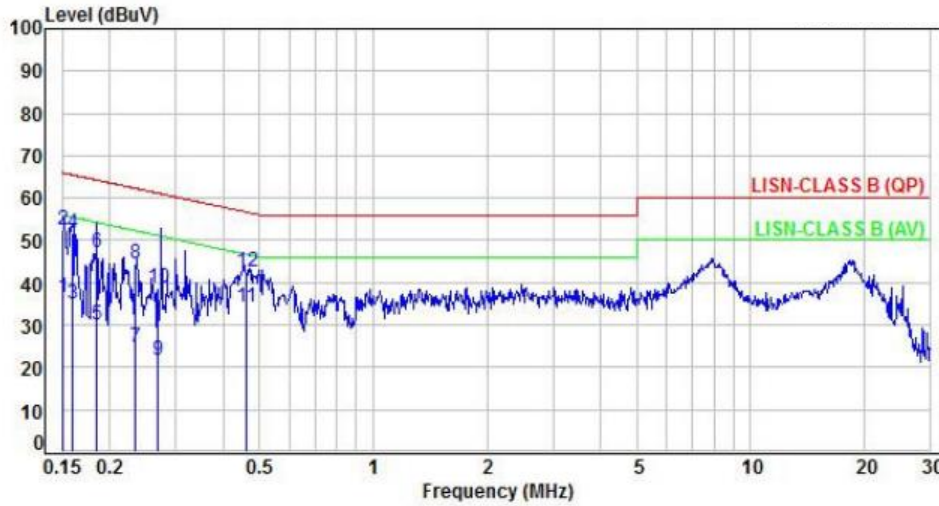

No.	Frequency (MHz)	Factor (dB)	Reading (dBuV)	Level (dBuV)	Limit (dBuV)	Margin (dB)	Detector	P/F
1	0.15	9.92	26.72	36.64	55.98	-19.34	Average	P
2	0.15	9.92	42.58	52.50	65.98	-13.48	QP	P
3	0.16	9.92	24.92	34.84	55.50	-20.66	Average	P
4	0.16	9.92	41.90	51.82	65.50	-13.68	QP	P
5	0.18	9.92	20.02	29.94	54.29	-24.35	Average	P
6	0.18	9.92	37.28	47.20	64.29	-17.09	QP	P
7	0.23	9.92	14.81	24.73	52.30	-27.57	Average	P
8	0.23	9.92	34.54	44.46	62.30	-17.84	QP	P
9	0.27	9.92	11.85	21.77	51.18	-29.41	Average	P
10	0.27	9.92	29.05	38.97	61.18	-22.21	QP	P
11	0.46	9.94	24.22	34.16	46.69	-12.53	Average	P
12	0.46	9.94	32.62	42.56	56.69	-14.13	QP	P

Note: Level=Reading+Factor
 Margin=Level-Limit
 Factor=(LISN or ISN or Current Probe)Factor + Cable Loss



Power	: AC 120V / 60Hz	Pol/Phase	: NEUTRAL
Test Mode	: Mode 7, CH159		:

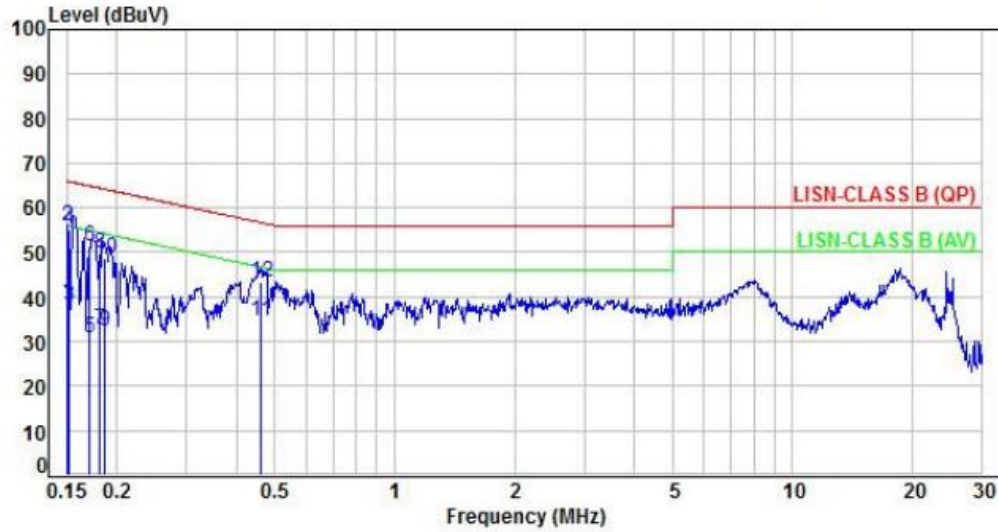

No.	Frequency (MHz)	Factor (dB)	Reading (dBUV)	Level (dBUV)	Limit (dBUV)	Margin (dB)	Detector	P/F
1	0.15	9.95	28.73	38.68	55.96	-17.28	Average	P
2	0.15	9.95	45.82	55.77	65.96	-10.19	QP	P
3	0.15	9.95	28.12	38.07	55.88	-17.81	Average	P
4	0.15	9.95	45.22	55.17	65.88	-10.71	QP	P
5	0.17	9.95	20.95	30.90	54.95	-24.05	Average	P
6	0.17	9.95	41.37	51.32	64.95	-13.63	QP	P
7	0.18	9.95	22.88	32.83	54.42	-21.59	Average	P
8	0.18	9.95	39.94	49.89	64.42	-14.53	QP	P
9	0.19	9.95	22.20	32.15	54.18	-22.03	Average	P
10	0.19	9.95	38.67	48.62	64.18	-15.56	QP	P
11	0.46	9.96	24.56	34.52	46.67	-12.15	Average	P
12	0.46	9.96	33.34	43.30	56.67	-13.37	QP	P

Note: Level=Reading+Factor
 Margin=Level-Limit
 Factor=(LISM or ISN or Current Probe)Factor + Cable Loss



6. Test of Spurious Emission (Radiated)

6.1. Test Limit

Undesirable emission limits. Except as shown in paragraph (b)(7) of this section, the maximum emissions outside of the frequency bands of operation shall be attenuated in accordance with the following limits:

- (1) For transmitters operating in the 5.15-5.25 GHz band: All emissions outside of the 5.15-5.35 GHz band shall not exceed an e.i.r.p. of -27 dBm/MHz.
- (2) For transmitters operating in the 5.25-5.35 GHz band: All emissions outside of the 5.15-5.35 GHz band shall not exceed an e.i.r.p. of -27 dBm/MHz.
- (3) For transmitters operating in the 5.47-5.725 GHz band: All emissions outside of the 5.47-5.725 GHz band shall not exceed an e.i.r.p. of -27 dBm/MHz.
- (4) For transmitters operating in the 5.725-5.85 GHz band:
All emissions shall be limited to a level of -27 dBm/MHz at 75 MHz or more above or below the band edge increasing linearly to 10 dBm/MHz at 25 MHz above or below the band edge, and from 25MHz above or below the band edge increasing linearly to a level of 15.6 dBm/MHz at 5 MHz above or below the band edge, and from 5 MHz above or below the band edge increasing linearly to a level of 27dBm/MHz at the band edge.
- (5) The emission measurements shall be performed using a minimum resolution bandwidth of 1 MHz. A lower resolution bandwidth may be employed near the band edge, when necessary, provided the measured energy is integrated to show the total power over 1 MHz.
- (6) Unwanted emissions below 1 GHz must comply with the general field strength limits set forth in §15.209. Further, any U-NII devices using an AC power line are required to comply also with the conducted limits set forth in §15.207.
- (7) The provisions of §15.205 apply to intentional radiators operating under this section.
- (8) When measuring the emission limits, the nominal carrier frequency shall be adjusted as close to the upper and lower frequency band edges as the design of the equipment permits.



6.2. Test Procedures

- a. The EUT was placed on a rotatable table top 0.8 meter above ground.
- b. The EUT was set 3 meters from the interference receiving antenna which was mounted on the top of a variable height antenna tower.
- c. The table was rotated 360 degrees to determine the position of the highest radiation.
- d. The antenna is a broadband antenna and its height is varied between one meter and four meters above ground to find the maximum value of the field strength both horizontal polarization and vertical polarization of the antenna are set to make the measurement.
- e. For each suspected emission the EUT was arranged to its worst case and then tune the antenna tower (from 1 M to 4 M) and turn table (from 0 degree to 360 degrees) to find the maximum reading.
- f. Set the test-receiver system to Peak or CISPR quasi-peak Detect Function and specified bandwidth with Maximum Hold Mode.
- g. If the emission level of the EUT in peak mode was 3 dB lower than the limit specified, then testing will be stopped and peak values of EUT will be reported, otherwise, the emissions which do not have 3 dB margin will be repeated one by one using the quasi-peak method and reported.
- h. For testing above 1GHz, the emission level of the EUT in peak mode was 20dB lower than average limit (that means the emission level in peak mode also complies with the limit in average mode), then testing will be stopped and peak values of EUT will be reported, otherwise, the emissions will be measured in average mode again and reported.
- i. "Cone of radiation" has been considered to be 3dB bandwidth of the measurement antenna.



6.3. Typical Test Setup

Below 30MHz test setup

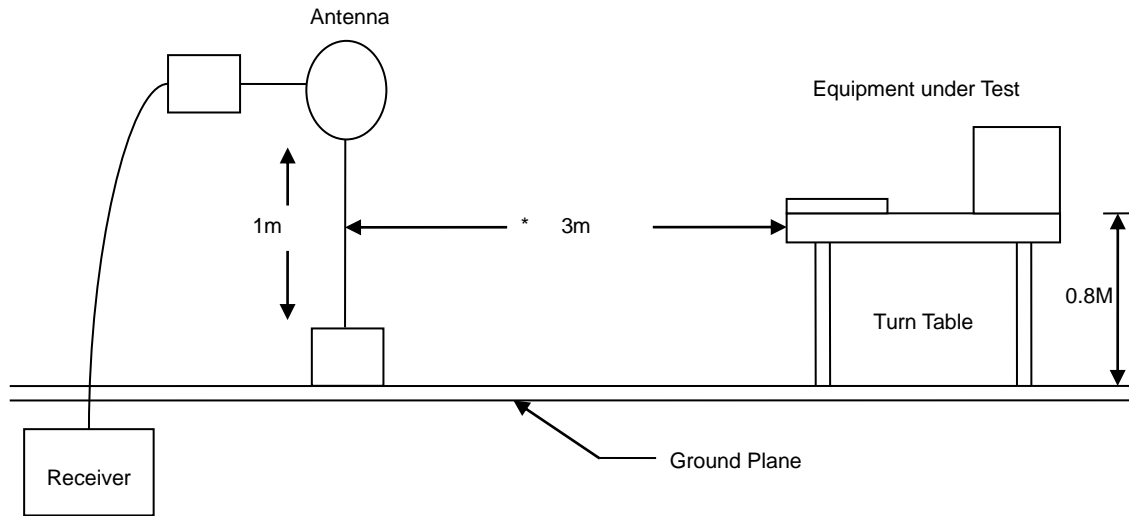

30MHz- 1GHz Test Setup

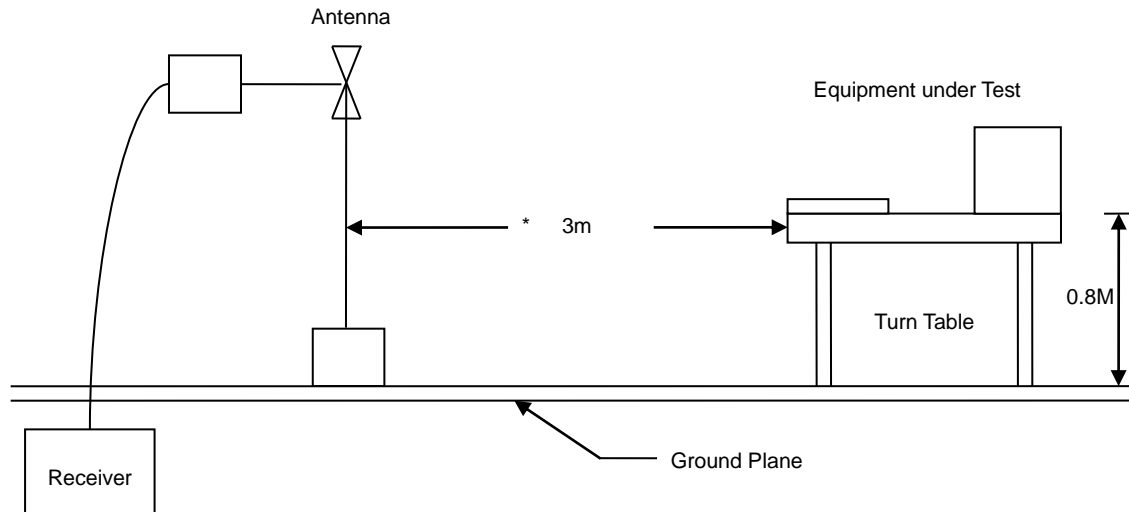

Above 1GHz Test Setup

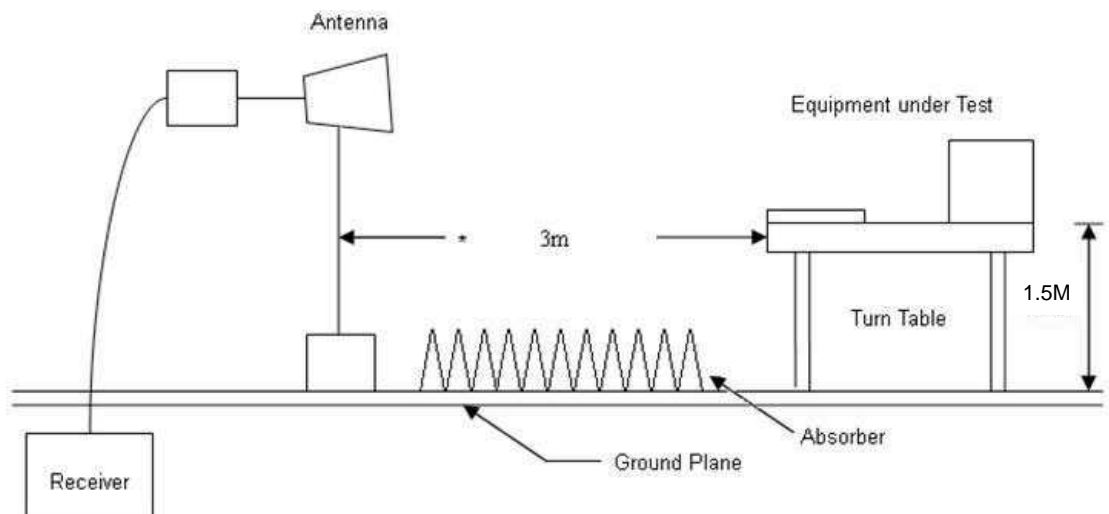



6.4. Test Result and Data (9kHz ~ 30MHz)

The 9kHz - 30MHz spurious emission is under limit 20dB more.

6.5. Test Result and Data (30MHz ~ 1GHz)

Power	: AC 120V / 60Hz	Pol/Phase	: VERTICAL
Test Mode	: Mode 3, CH159		:

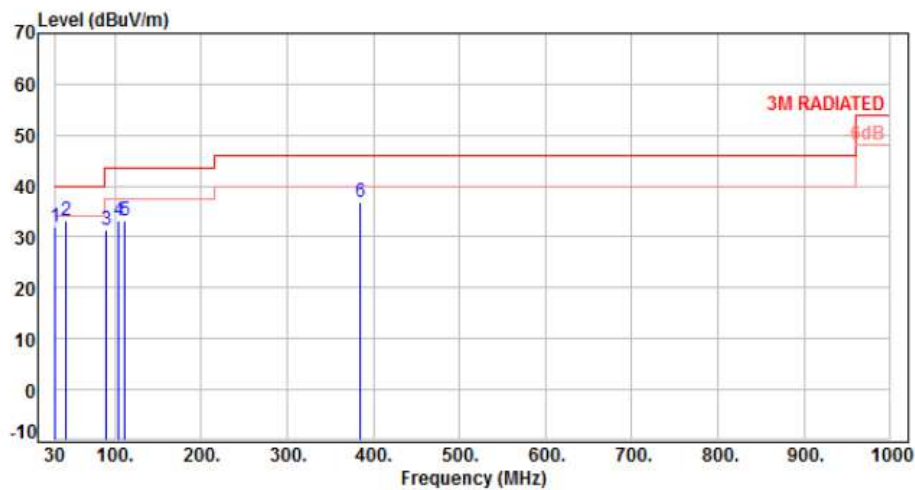

No.	Frequency (MHz)	Factor (dB)	Reading (dBuV)	Level (dBuV/m)	Limit (dBuV/m)	Margin (dB)	Detector	Height (cm)	Azimuth (deg)	P/F
1	30.00	-10.17	42.01	31.84	40.00	-8.16	Peak	100	0	P
2	43.58	-9.37	42.69	33.32	40.00	-6.68	Peak	100	0	P
3	90.14	-15.60	47.07	31.47	43.50	-12.03	Peak	100	0	P
4	104.69	-13.37	46.43	33.06	43.50	-10.44	Peak	100	0	P
5	111.48	-12.39	45.48	33.09	43.50	-10.41	Peak	100	0	P
6	384.05	-6.10	42.80	36.70	46.00	-9.30	Peak	100	0	P

Note: Level=Reading+Factor
 Margin=Level-Limit
 Factor=Antenna Factor + cable loss - Amplifier Factor



Power	: AC 120V / 60Hz	Pol/Phase	: HORIZONTAL
Test Mode	: Mode 3, CH159		:

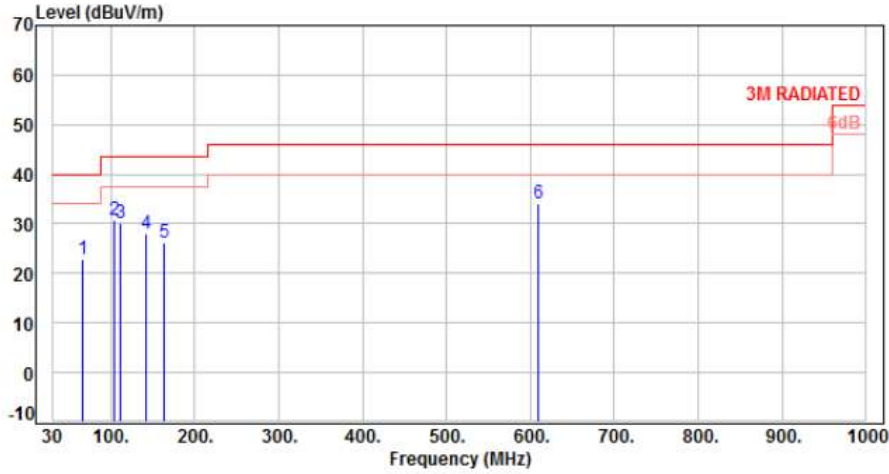

No.	Frequency (MHz)	Factor (dB)	Reading (dBuV)	Level (dBuV/m)	Limit (dBuV/m)	Margin (dB)	Detector	Height (cm)	Azimuth (deg)	P/F
1	65.89	-10.97	33.81	22.84	40.00	-17.16	Peak	150	0	P
2	104.69	-13.37	44.02	30.65	43.50	-12.85	Peak	150	0	P
3	111.48	-12.39	42.45	30.06	43.50	-13.44	Peak	150	0	P
4	142.52	-9.67	37.66	27.99	43.50	-15.51	Peak	150	0	P
5	163.86	-9.50	35.68	26.18	43.50	-17.32	Peak	150	0	P
6	610.06	-0.87	34.95	34.08	46.00	-11.92	Peak	150	0	P

Note: Level=Reading+Factor
Margin=Level-Limit
Factor=Antenna Factor + cable loss - Amplifier Factor



Power	: AC 120V / 60Hz	Pol/Phase	: HORIZONTAL
Test Mode	: Mode 7, CH159		:

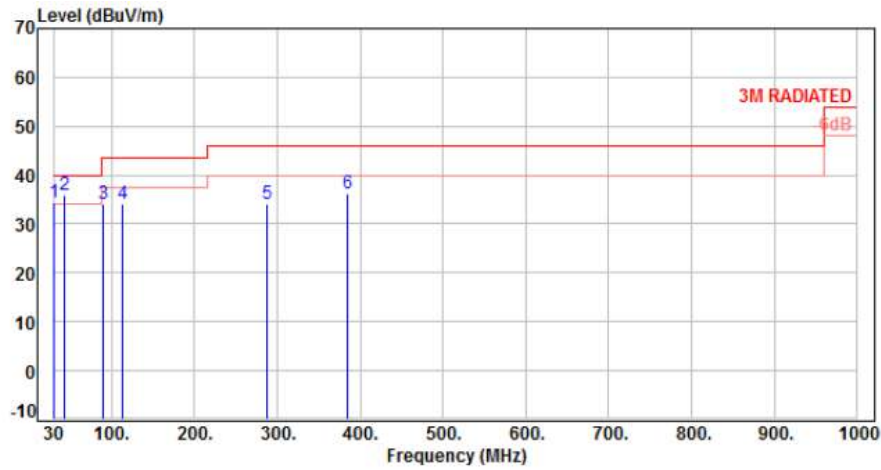

No.	Frequency (MHz)	Factor (dB)	Reading (dBUV)	Level (dBUV/m)	Limit (dBUV/m)	Margin (dB)	Detector	Height (cm)	Azimuth (deg)	P/F
1	30.00	-10.17	44.54	34.37	40.00	-5.63	Peak	100	0	P
2	43.58	-9.37	45.29	35.92	40.00	-4.08	Peak	100	0	P
3	90.14	-15.60	49.63	34.03	43.50	-9.47	Peak	100	0	P
4	112.45	-12.30	46.44	34.14	43.50	-9.36	Peak	100	0	P
5	288.02	-8.86	43.03	34.17	46.00	-11.83	Peak	100	0	P
6	384.05	-6.10	42.34	36.24	46.00	-9.76	Peak	100	0	P

Note: Level=Reading+Factor
Margin=Level-Limit
Factor=Antenna Factor + cable loss - Amplifier Factor



Power	: AC 120V / 60Hz	Pol/Phase	: HORIZONTAL
Test Mode	: Mode 7, CH159		:

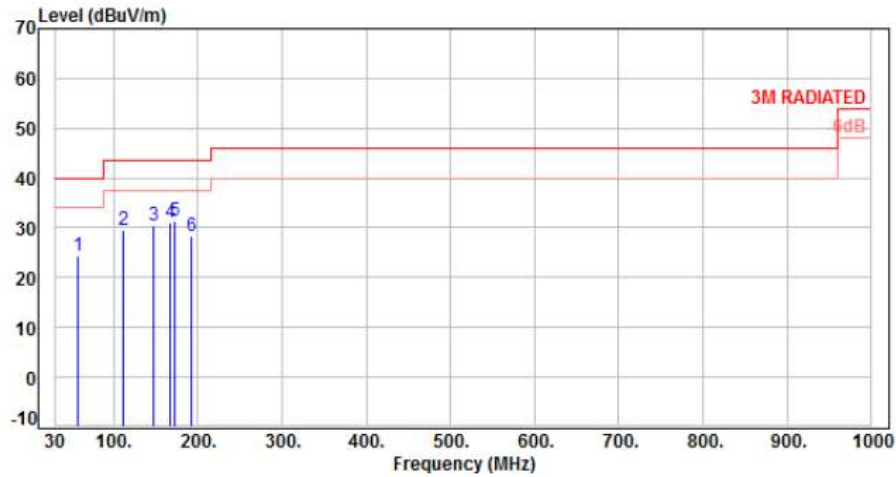

No.	Frequency (MHz)	Factor (dB)	Reading (dBuV)	Level (dBuV/m)	Limit (dBuV/m)	Margin (dB)	Detector	Height (cm)	Azimuth (deg)	P/F
1	58.13	-9.81	34.33	24.52	40.00	-15.48	Peak	150	0	P
2	110.51	-12.44	42.06	29.62	43.50	-13.88	Peak	150	0	P
3	147.37	-9.51	40.11	30.60	43.50	-12.90	Peak	150	0	P
4	167.74	-9.64	40.84	31.20	43.50	-12.30	Peak	150	0	P
5	172.59	-10.00	41.42	31.42	43.50	-12.08	Peak	150	0	P
6	191.99	-11.74	40.07	28.33	43.50	-15.17	Peak	150	0	P

Note: Level=Reading+Factor
 Margin=Level-Limit
 Factor=Antenna Factor + cable loss - Amplifier Factor



6.6. Test Result and Data (1GHz ~ 40GHz)

Power	: AC 120V / 60Hz	Pol/Phase	: VERTICAL
Test Mode	: Mode 1, Band 1, CH36		:

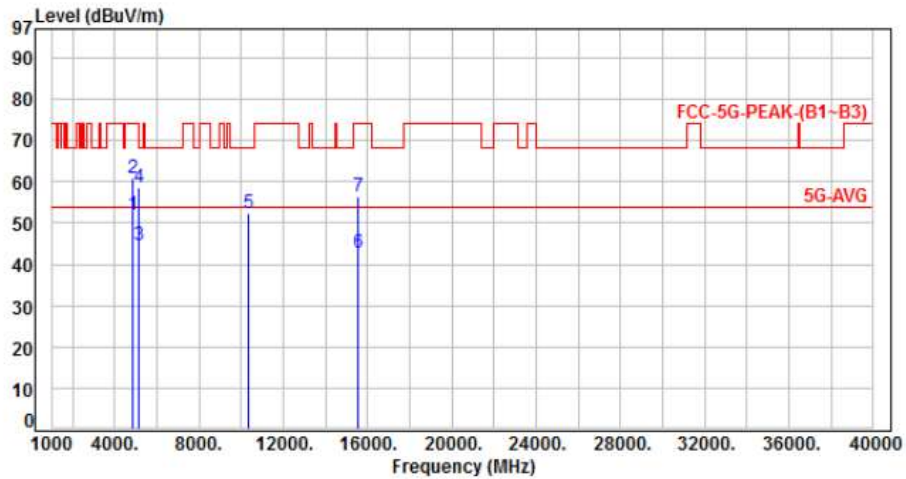

No.	Frequency (MHz)	Factor (dB)	Reading (dBuV)	Level (dBuV/m)	Limit (dBuV/m)	Margin (dB)	Detector	Height (cm)	Azimuth (deg)	P/F
1	4860.00	3.91	48.22	52.13	54.00	-1.87	Average	400	345	P
2	4860.00	3.91	57.10	61.01	74.00	-12.99	Peak	400	345	P
3	5150.00	4.73	39.81	44.54	54.00	-9.46	Average	190	300	P
4	5150.00	4.73	53.91	58.64	74.00	-15.36	Peak	190	300	P
5	10360.00	11.43	40.82	52.25	68.20	-15.95	Peak	100	82	P
6	15540.00	14.27	28.51	42.78	54.00	-11.22	Average	100	150	P
7	15540.00	14.27	42.02	56.29	74.00	-17.71	Peak	100	150	P

Note: Level=Reading+Factor
Margin=Level-Limit
Factor=Antenna Factor + cable loss - Amplifier Factor



Power	: AC 120V / 60Hz	Pol/Phase	: HORIZONTAL
Test Mode	: Mode 1, Band 1, CH36		:

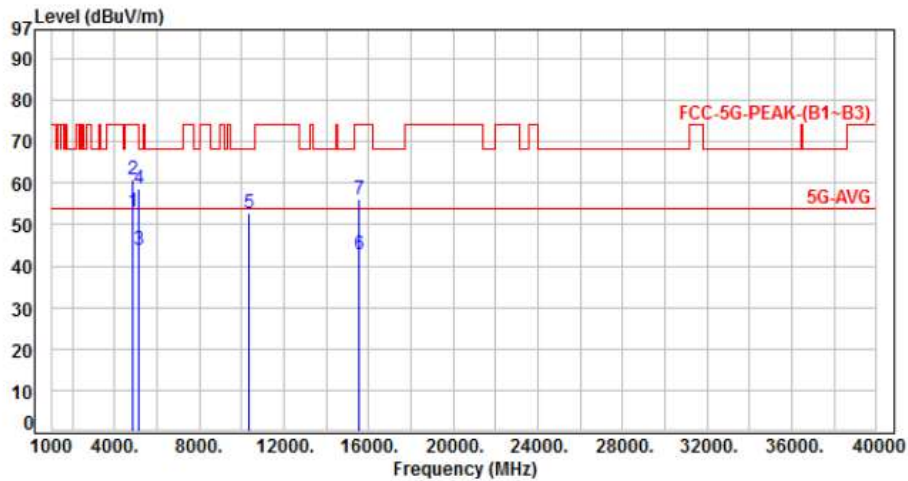

No.	Frequency (MHz)	Factor (dB)	Reading (dBuV)	Level (dBuV/m)	Limit (dBuV/m)	Margin (dB)	Detector	Height (cm)	Azimuth (deg)	P/F
1	4860.00	3.91	49.08	52.99	54.00	-1.01	Average	115	310	P
2	4860.00	3.91	56.90	60.81	74.00	-13.19	Peak	115	310	P
3	5150.00	4.73	39.25	43.98	54.00	-10.02	Average	145	310	P
4	5150.00	4.73	53.84	58.57	74.00	-15.43	Peak	145	310	P
5	10360.00	11.43	41.22	52.65	68.20	-15.55	Peak	100	222	P
6	15540.00	14.27	28.53	42.80	54.00	-11.20	Average	100	152	P
7	15540.00	14.27	41.79	56.06	74.00	-17.94	Peak	100	152	P

Note: Level=Reading+Factor
Margin=Level-Limit
Factor=Antenna Factor + cable loss - Amplifier Factor



Power	: AC 120V / 60Hz	Pol/Phase	: VERTICAL
Test Mode	: Mode 1, Band 1, CH40		:

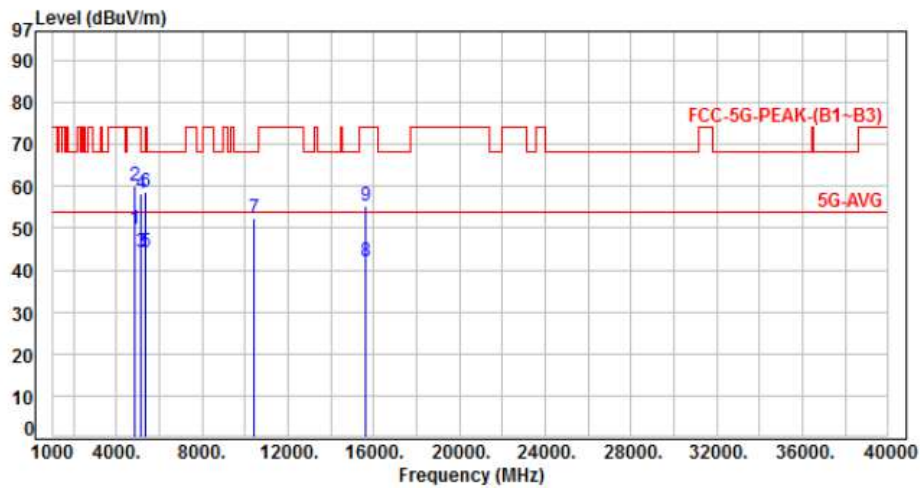

No.	Frequency (MHz)	Factor (dB)	Reading (dBuV)	Level (dBuV/m)	Limit (dBuV/m)	Margin (dB)	Detector	Height (cm)	Azimuth (deg)	P/F
1	4880.00	3.97	45.97	49.94	54.00	-4.06	Average	400	335	P
2	4880.00	3.97	56.19	60.16	74.00	-13.84	Peak	400	335	P
3	5150.00	4.73	39.66	44.39	54.00	-9.61	Average	100	166	P
4	5150.00	4.73	53.48	58.21	74.00	-15.79	Peak	100	166	P
5	5350.00	5.07	39.13	44.20	54.00	-9.80	Average	100	166	P
6	5350.00	5.07	53.56	58.63	74.00	-15.37	Peak	100	166	P
7	10400.00	11.45	40.76	52.21	68.20	-15.99	Peak	100	76	P
8	15600.00	13.88	28.05	41.93	54.00	-12.07	Average	100	254	P
9	15600.00	13.88	41.54	55.42	74.00	-18.58	Peak	100	254	P

Note: Level=Reading+Factor
 Margin=Level-Limit
 Factor=Antenna Factor + cable loss - Amplifier Factor



Power	: AC 120V / 60Hz	Pol/Phase	: HORIZONTAL
Test Mode	: Mode 1, Band 1, CH40		:

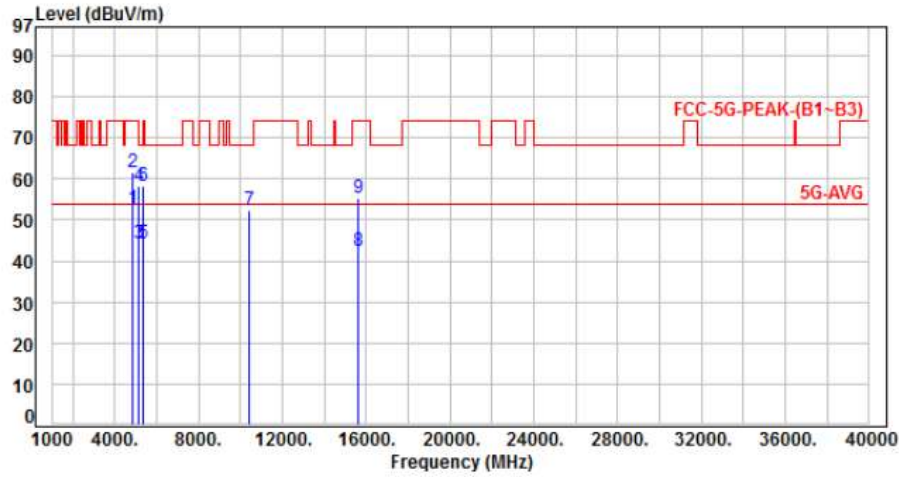

No.	Frequency (MHz)	Factor (dB)	Reading (dBuV)	Level (dBuV/m)	Limit (dBuV/m)	Margin (dB)	Detector	Height (cm)	Azimuth (deg)	P/F
1	4880.00	3.97	48.75	52.72	54.00	-1.28	Average	145	310	P
2	4880.00	3.97	57.71	61.68	74.00	-12.32	Peak	145	310	P
3	5150.00	4.73	39.41	44.14	54.00	-9.86	Average	100	212	P
4	5150.00	4.73	53.46	58.19	74.00	-15.81	Peak	100	212	P
5	5350.00	5.07	39.29	44.36	54.00	-9.64	Average	100	212	P
6	5350.00	5.07	53.38	58.45	74.00	-15.55	Peak	100	212	P
7	10400.00	11.45	40.86	52.31	68.20	-15.89	Peak	100	178	P
8	15600.00	13.88	28.38	42.26	54.00	-11.74	Average	100	138	P
9	15600.00	13.88	41.57	55.45	74.00	-18.55	Peak	100	138	P

Note: Level=Reading+Factor
 Margin=Level-Limit
 Factor=Antenna Factor + cable loss - Amplifier Factor



Power	: AC 120V / 60Hz	Pol/Phase	: VERTICAL
Test Mode	: Mode 1, Band 1, CH48		:

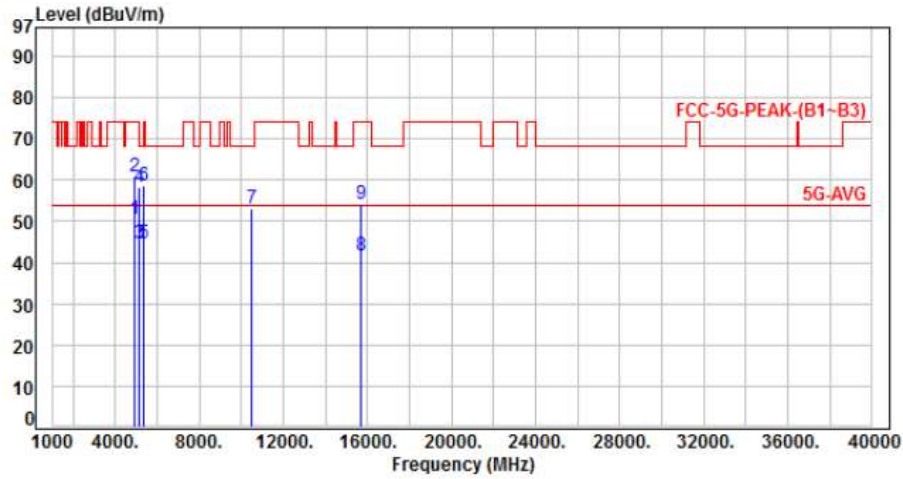

No.	Frequency (MHz)	Factor (dB)	Reading (dBuV)	Level (dBuV/m)	Limit (dBuV/m)	Margin (dB)	Detector	Height (cm)	Azimuth (deg)	P/F
1	4920.00	4.09	46.37	50.46	54.00	-3.54	Average	400	345	P
2	4920.00	4.09	56.74	60.83	74.00	-13.17	Peak	400	345	P
3	5150.00	4.73	39.79	44.52	54.00	-9.48	Average	100	279	P
4	5150.00	4.73	53.48	58.21	74.00	-15.79	Peak	100	279	P
5	5350.00	5.07	39.72	44.79	54.00	-9.21	Average	100	279	P
6	5350.00	5.07	53.61	58.68	74.00	-15.32	Peak	100	279	P
7	10480.00	11.65	41.29	52.94	68.20	-15.26	Peak	100	229	P
8	15720.00	13.60	28.22	41.82	54.00	-12.18	Average	100	122	P
9	15720.00	13.60	40.77	54.37	74.00	-19.63	Peak	100	122	P

Note: Level=Reading+Factor
 Margin=Level-Limit
 Factor=Antenna Factor + cable loss - Amplifier Factor



Power	: AC 120V / 60Hz	Pol/Phase	: HORIZONTAL
Test Mode	: Mode 1, Band 1, CH48		:

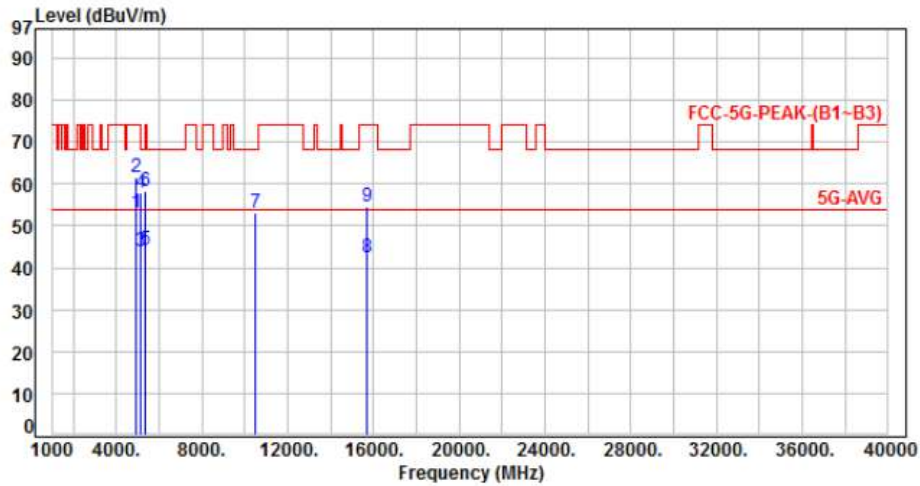

No.	Frequency (MHz)	Factor (dB)	Reading (dBuV)	Level (dBuV/m)	Limit (dBuV/m)	Margin (dB)	Detector	Height (cm)	Azimuth (deg)	P/F
1	4920.00	4.09	48.90	52.99	54.00	-1.01	Average	127	310	P
2	4920.00	4.09	57.54	61.63	74.00	-12.37	Peak	127	310	P
3	5150.00	4.73	39.34	44.07	54.00	-9.93	Average	100	234	P
4	5150.00	4.73	53.26	57.99	74.00	-16.01	Peak	100	234	P
5	5350.00	5.07	39.29	44.36	54.00	-9.64	Average	100	234	P
6	5350.00	5.07	53.05	58.12	74.00	-15.88	Peak	100	234	P
7	10480.00	11.65	41.42	53.07	68.20	-15.13	Peak	100	142	P
8	15720.00	13.60	28.84	42.44	54.00	-11.56	Average	115	112	P
9	15720.00	13.60	41.12	54.72	74.00	-19.28	Peak	115	112	P

Note: Level=Reading+Factor
 Margin=Level-Limit
 Factor=Antenna Factor + cable loss - Amplifier Factor



Power	: AC 120V / 60Hz	Pol/Phase	: VERTICAL
Test Mode	: Mode 2, Band 1, CH36		:

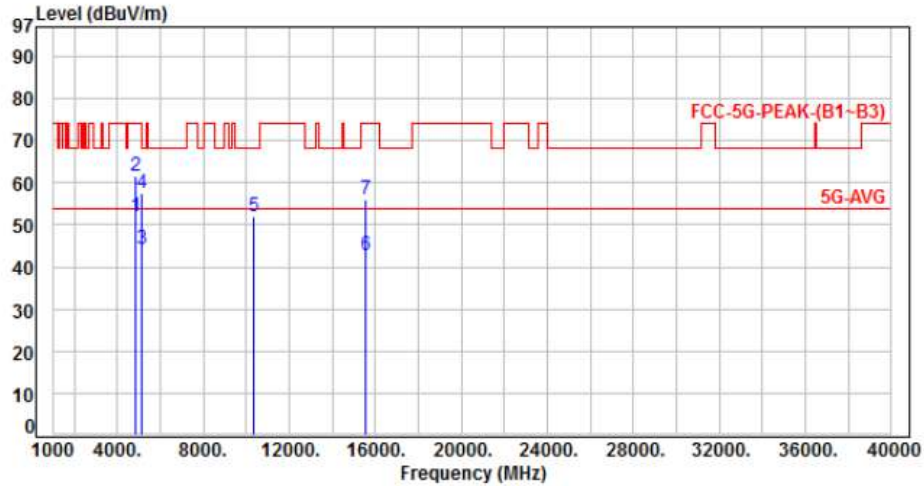

No.	Frequency (MHz)	Factor (dB)	Reading (dBuV)	Level (dBuV/m)	Limit (dBuV/m)	Margin (dB)	Detector	Height (cm)	Azimuth (deg)	P/F
1	4860.00	3.91	47.92	51.83	54.00	-2.17	Average	400	350	P
2	4860.00	3.91	57.70	61.61	74.00	-12.39	Peak	400	350	P
3	5150.00	4.73	39.53	44.26	54.00	-9.74	Average	400	350	P
4	5150.00	4.73	52.87	57.60	74.00	-16.40	Peak	400	350	P
5	10360.00	11.43	40.65	52.08	68.20	-16.12	Peak	100	165	P
6	15540.00	14.27	28.37	42.64	54.00	-11.36	Average	100	189	P
7	15540.00	14.27	41.90	56.17	74.00	-17.83	Peak	100	189	P

Note: Level=Reading+Factor
 Margin=Level-Limit
 Factor=Antenna Factor + cable loss - Amplifier Factor



Power	: AC 120V / 60Hz	Pol/Phase	: HORIZONTAL
Test Mode	: Mode 2, Band 1, CH36		:

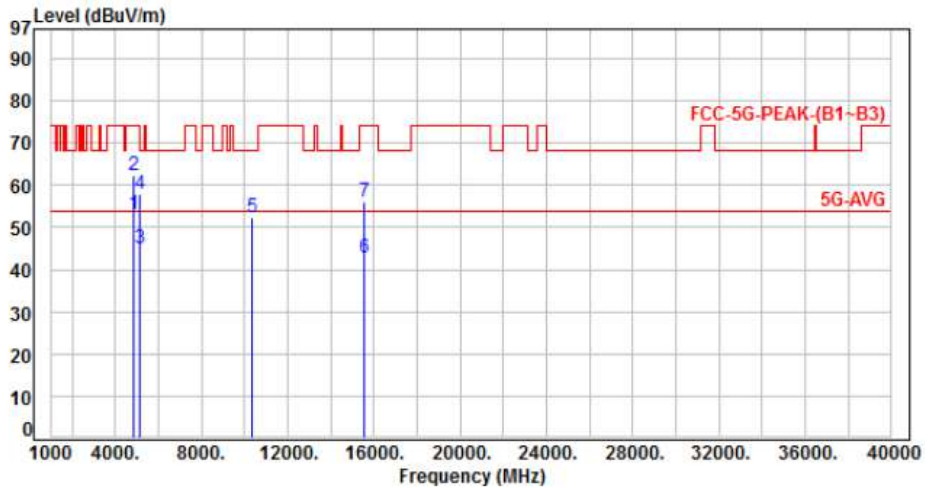

No.	Frequency (MHz)	Factor (dB)	Reading (dBuV)	Level (dBuV/m)	Limit (dBuV/m)	Margin (dB)	Detector	Height (cm)	Azimuth (deg)	P/F
1	4860.00	3.91	49.05	52.96	54.00	-1.04	Average	110	310	P
2	4860.00	3.91	58.30	62.21	74.00	-11.79	Peak	110	310	P
3	5150.00	4.73	40.19	44.92	54.00	-9.08	Average	110	310	P
4	5150.00	4.73	53.09	57.82	74.00	-16.18	Peak	110	310	P
5	10360.00	11.43	40.92	52.35	68.20	-15.85	Peak	100	192	P
6	15540.00	14.27	28.43	42.70	54.00	-11.30	Average	100	142	P
7	15540.00	14.27	41.68	55.95	74.00	-18.05	Peak	100	142	P

Note: Level=Reading+Factor
 Margin=Level-Limit
 Factor=Antenna Factor + cable loss - Amplifier Factor



Power	: AC 120V / 60Hz	Pol/Phase	: VERTICAL
Test Mode	: Mode 2, Band 1, CH40		

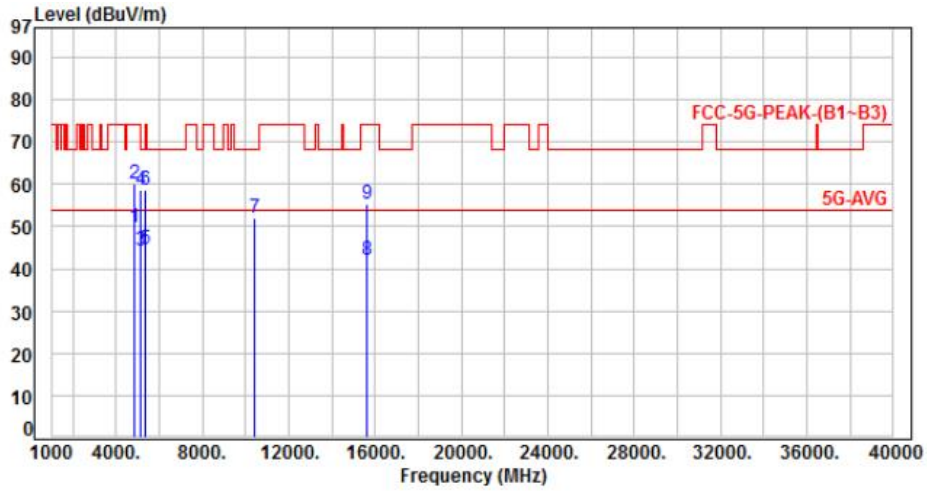

No.	Frequency (MHz)	Factor (dB)	Reading (dBuV)	Level (dBuV/m)	Limit (dBuV/m)	Margin (dB)	Detector	Height (cm)	Azimuth (deg)	P/F
1	4880.00	3.97	45.92	49.89	54.00	-4.11	Average	400	345	P
2	4880.00	3.97	55.98	59.95	74.00	-14.05	Peak	400	345	P
3	5150.00	4.73	39.63	44.36	54.00	-9.64	Average	400	350	P
4	5150.00	4.73	53.77	58.50	74.00	-15.50	Peak	400	350	P
5	5350.00	5.07	39.55	44.62	54.00	-9.38	Average	400	350	P
6	5350.00	5.07	53.62	58.69	74.00	-15.31	Peak	400	350	P
7	10400.00	11.45	40.65	52.10	68.20	-16.10	Peak	100	165	P
8	15600.00	13.88	28.32	42.20	54.00	-11.80	Average	100	132	P
9	15600.00	13.88	41.36	55.24	74.00	-18.76	Peak	100	132	P

Note: Level=Reading+Factor
 Margin=Level-Limit
 Factor=Antenna Factor + cable loss - Amplifier Factor



Power	: AC 120V / 60Hz	Pol/Phase	: HORIZONTAL
Test Mode	: Mode 2, Band 1, CH40		:

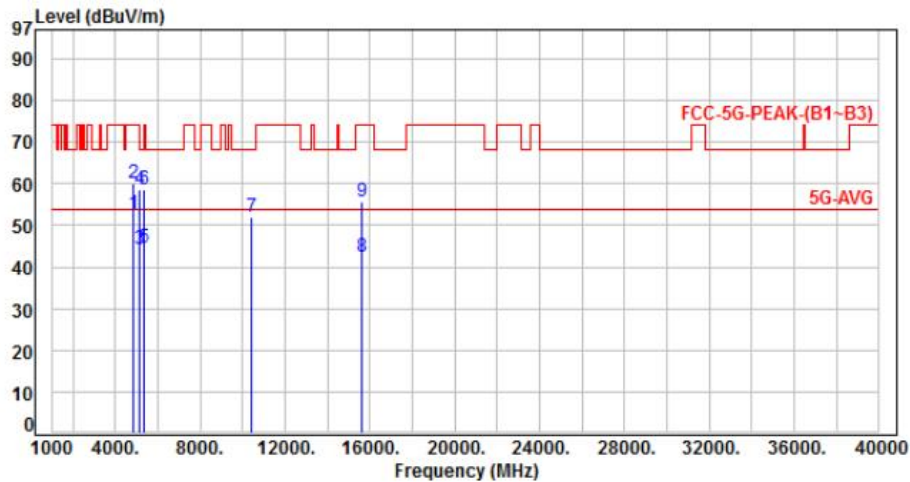

No.	Frequency (MHz)	Factor (dB)	Reading (dBuV)	Level (dBuV/m)	Limit (dBuV/m)	Margin (dB)	Detector	Height (cm)	Azimuth (deg)	P/F
1	4880.00	3.97	48.81	52.78	54.00	-1.22	Average	140	315	P
2	4880.00	3.97	56.18	60.15	74.00	-13.85	Peak	140	315	P
3	5150.00	4.73	39.61	44.34	54.00	-9.66	Average	100	310	P
4	5150.00	4.73	53.91	58.64	74.00	-15.36	Peak	100	310	P
5	5350.00	5.07	39.52	44.59	54.00	-9.41	Average	100	310	P
6	5350.00	5.07	53.47	58.54	74.00	-15.46	Peak	100	310	P
7	10400.00	11.45	40.71	52.16	68.20	-16.04	Peak	100	171	P
8	15600.00	13.88	28.44	42.32	54.00	-11.68	Average	100	281	P
9	15600.00	13.88	41.81	55.69	74.00	-18.31	Peak	100	281	P

Note: Level=Reading+Factor
 Margin=Level-Limit
 Factor=Antenna Factor + cable loss - Amplifier Factor



Power	: AC 120V / 60Hz	Pol/Phase	: VERTICAL
Test Mode	: Mode 2, Band 1, CH48		:

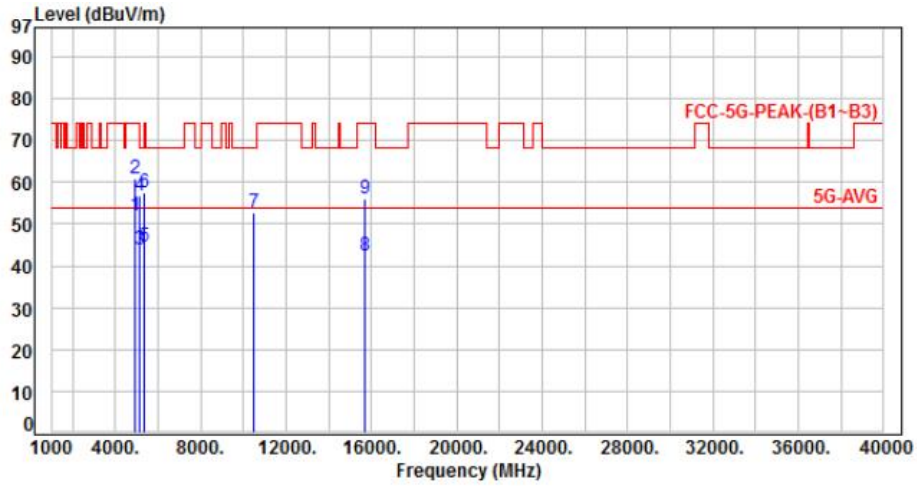

No.	Frequency (MHz)	Factor (dB)	Reading (dBuV)	Level (dBuV/m)	Limit (dBuV/m)	Margin (dB)	Detector	Height (cm)	Azimuth (deg)	P/F
1	4920.00	4.09	48.00	52.09	54.00	-1.91	Average	370	345	P
2	4920.00	4.09	56.70	60.79	74.00	-13.21	Peak	370	345	P
3	5150.00	4.73	39.29	44.02	54.00	-9.98	Average	400	333	P
4	5150.00	4.73	52.22	56.95	74.00	-17.05	Peak	400	333	P
5	5350.00	5.07	39.38	44.45	54.00	-9.55	Average	400	333	P
6	5350.00	5.07	52.44	57.51	74.00	-16.49	Peak	400	333	P
7	10480.00	11.65	41.13	52.78	68.20	-15.42	Peak	100	113	P
8	15720.00	13.60	28.63	42.23	54.00	-11.77	Average	100	113	P
9	15720.00	13.60	42.32	55.92	74.00	-18.08	Peak	100	113	P

Note: Level=Reading+Factor
 Margin=Level-Limit
 Factor=Antenna Factor + cable loss - Amplifier Factor



Power	: AC 120V / 60Hz	Pol/Phase	: HORIZONTAL
Test Mode	: Mode 2, Band 1, CH48		

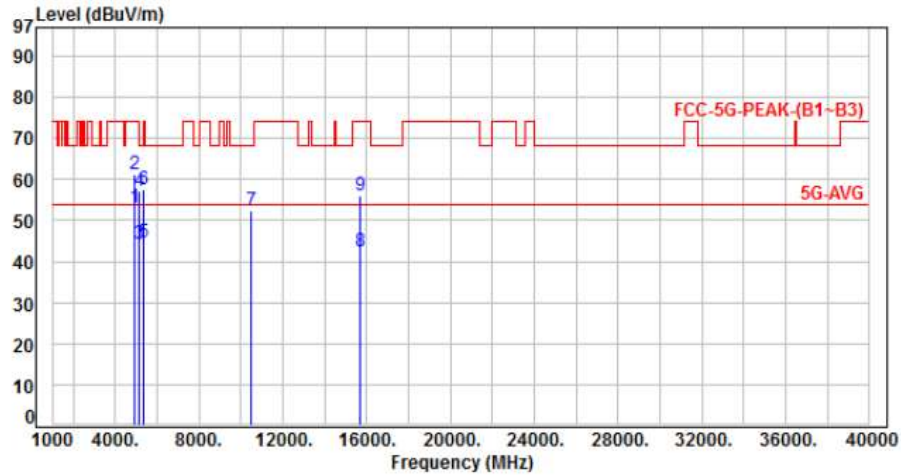

No.	Frequency (MHz)	Factor (dB)	Reading (dBUV)	Level (dBUV/m)	Limit (dBUV/m)	Margin (dB)	Detector	Height (cm)	Azimuth (deg)	P/F
1	4920.00	4.09	48.86	52.95	54.00	-1.05	Average	115	310	P
2	4920.00	4.09	57.10	61.19	74.00	-12.81	Peak	115	310	P
3	5150.00	4.73	39.35	44.08	54.00	-9.92	Average	105	345	P
4	5150.00	4.73	52.60	57.33	74.00	-16.67	Peak	105	345	P
5	5350.00	5.07	39.42	44.49	54.00	-9.51	Average	105	345	P
6	5350.00	5.07	52.51	57.58	74.00	-16.42	Peak	105	345	P
7	10480.00	11.65	40.78	52.43	68.20	-15.77	Peak	100	178	P
8	15720.00	13.60	28.76	42.36	54.00	-11.64	Average	100	176	P
9	15720.00	13.60	42.35	55.95	74.00	-18.05	Peak	100	135	P

Note: Level=Reading+Factor
 Margin=Level-Limit
 Factor=Antenna Factor + cable loss - Amplifier Factor



Power	: AC 120V / 60Hz	Pol/Phase	: VERTICAL
Test Mode	: Mode 3, Band 1, CH38		:

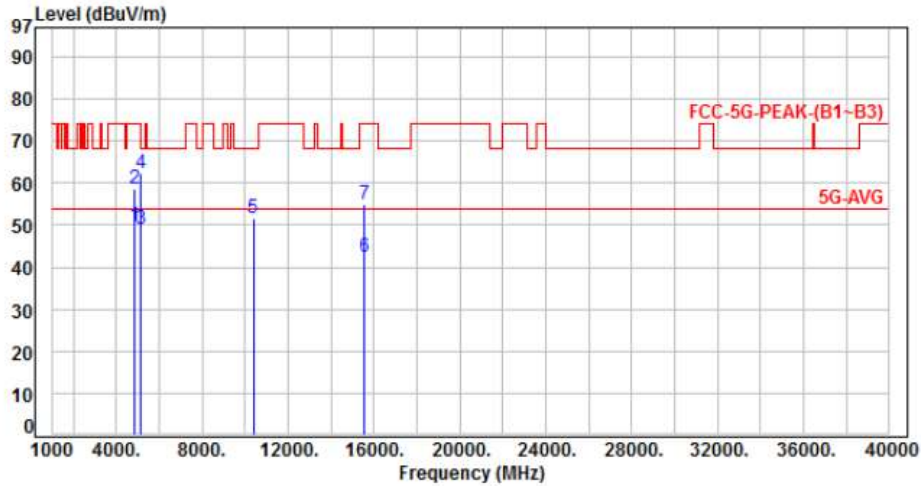

No.	Frequency (MHz)	Factor (dB)	Reading (dBuV)	Level (dBuV/m)	Limit (dBuV/m)	Margin (dB)	Detector	Height (cm)	Azimuth (deg)	P/F
1	4870.00	3.94	45.87	49.81	54.00	-4.19	Average	400	345	P
2	4870.00	3.94	54.86	58.80	74.00	-15.20	Peak	400	345	P
3	5150.00	4.73	44.50	49.23	54.00	-4.77	Average	385	345	P
4	5150.00	4.73	57.74	62.47	74.00	-11.53	Peak	385	345	P
5	10380.00	11.44	40.23	51.67	68.20	-16.53	Peak	100	123	P
6	15570.00	14.07	28.31	42.38	54.00	-11.62	Average	100	103	P
7	15570.00	14.07	41.04	55.11	74.00	-18.89	Peak	100	103	P

Note: Level=Reading+Factor
 Margin=Level-Limit
 Factor=Antenna Factor + cable loss - Amplifier Factor



Power	: AC 120V / 60Hz	Pol/Phase	: HORIZONTAL
Test Mode	: Mode 3, Band 1, CH38		:

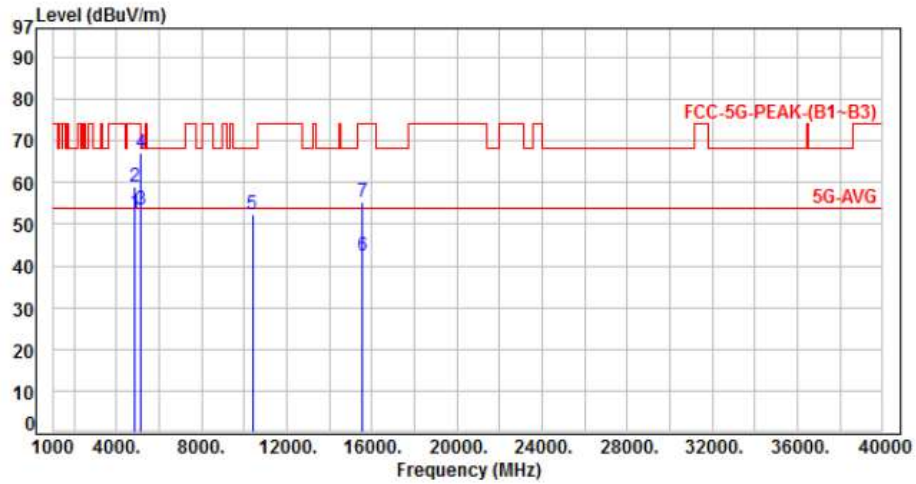

No.	Frequency (MHz)	Factor (dB)	Reading (dBuV)	Level (dBuV/m)	Limit (dBuV/m)	Margin (dB)	Detector	Height (cm)	Azimuth (deg)	P/F
1	4870.00	3.94	48.92	52.86	54.00	-1.14	Average	165	315	P
2	4870.00	3.94	55.09	59.03	74.00	-14.97	Peak	165	315	P
3	5150.00	4.73	48.57	53.30	54.00	-0.70	Average	168	310	P
4	5150.00	4.73	62.46	67.19	74.00	-6.81	Peak	168	310	P
5	10380.00	11.44	40.83	52.27	68.20	-15.93	Peak	100	183	P
6	15570.00	14.07	28.36	42.43	54.00	-11.57	Average	100	135	P
7	15570.00	14.07	41.32	55.39	74.00	-18.61	Peak	100	135	P

Note: Level=Reading+Factor
 Margin=Level-Limit
 Factor=Antenna Factor + cable loss - Amplifier Factor



Power	: AC 120V / 60Hz	Pol/Phase	: VERTICAL
Test Mode	: Mode 3, Band 1, CH46		

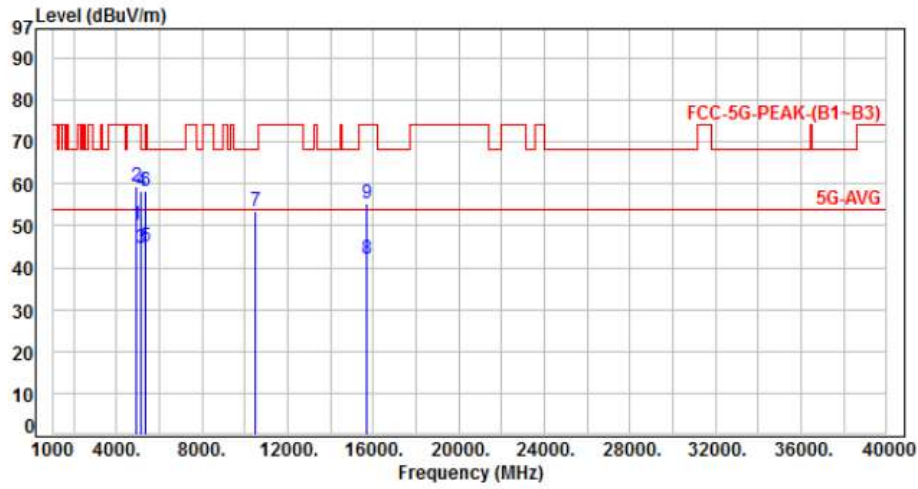

No.	Frequency (MHz)	Factor (dB)	Reading (dBuV)	Level (dBuV/m)	Limit (dBuV/m)	Margin (dB)	Detector	Height (cm)	Azimuth (deg)	P/F
1	4910.00	4.06	46.07	50.13	54.00	-3.87	Average	395	340	P
2	4910.00	4.06	55.42	59.48	74.00	-14.52	Peak	395	340	P
3	5150.00	4.73	40.07	44.80	54.00	-9.20	Average	395	340	P
4	5150.00	4.73	53.41	58.14	74.00	-15.86	Peak	395	340	P
5	5350.00	5.07	40.01	45.08	54.00	-8.92	Average	395	340	P
6	5350.00	5.07	53.18	58.25	74.00	-15.75	Peak	395	340	P
7	10460.00	11.60	42.02	53.62	68.20	-14.58	Peak	100	102	P
8	15690.00	13.64	28.53	42.17	54.00	-11.83	Average	100	156	P
9	15690.00	13.64	41.56	55.20	74.00	-18.80	Peak	100	156	P

Note: Level=Reading+Factor
 Margin=Level-Limit
 Factor=Antenna Factor + cable loss - Amplifier Factor



Power	: AC 120V / 60Hz	Pol/Phase	: HORIZONTAL
Test Mode	: Mode 3, Band 1, CH46		:

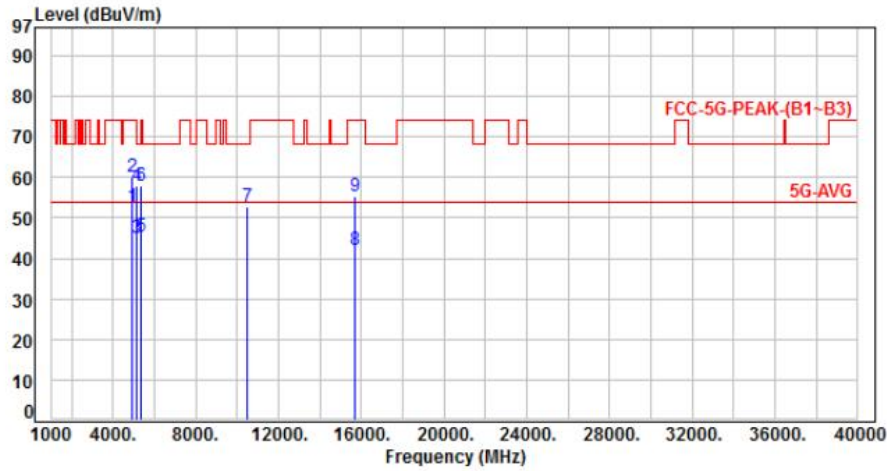

No.	Frequency (MHz)	Factor (dB)	Reading (dBuV)	Level (dBuV/m)	Limit (dBuV/m)	Margin (dB)	Detector	Height (cm)	Azimuth (deg)	P/F
1	4910.00	4.06	48.60	52.66	54.00	-1.34	Average	130	315	P
2	4910.00	4.06	55.96	60.02	74.00	-13.98	Peak	130	315	P
3	5150.00	4.73	40.10	44.83	54.00	-9.17	Average	100	110	P
4	5150.00	4.73	53.10	57.83	74.00	-16.17	Peak	100	110	P
5	5350.00	5.07	40.16	45.23	54.00	-8.77	Average	100	110	P
6	5350.00	5.07	52.94	58.01	74.00	-15.99	Peak	100	110	P
7	10460.00	11.60	41.09	52.69	68.20	-15.51	Peak	100	109	P
8	15690.00	13.64	28.54	42.18	54.00	-11.82	Average	100	54	P
9	15690.00	13.64	41.51	55.15	74.00	-18.85	Peak	100	54	P

Note: Level=Reading+Factor
 Margin=Level-Limit
 Factor=Antenna Factor + cable loss - Amplifier Factor



Power	: AC 120V / 60Hz	Pol/Phase	: VERTICAL
Test Mode	: Mode 4, Band 1, CH42		:

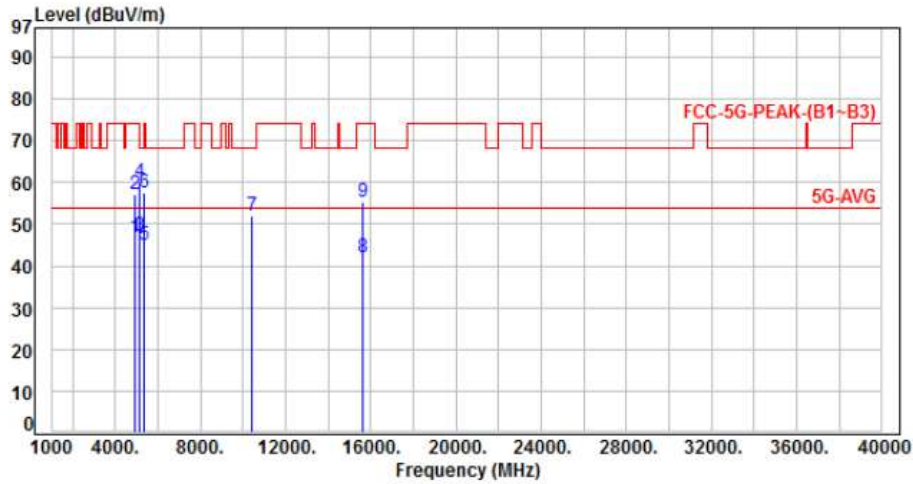

No.	Frequency (MHz)	Factor (dB)	Reading (dBuV)	Level (dBuV/m)	Limit (dBuV/m)	Margin (dB)	Detector	Height (cm)	Azimuth (deg)	P/F
1	4890.00	4.00	42.99	46.99	54.00	-7.01	Average	400	345	P
2	4890.00	4.00	53.30	57.30	74.00	-16.70	Peak	400	345	P
3	5150.00	4.73	42.65	47.38	54.00	-6.62	Average	100	265	P
4	5150.00	4.73	55.53	60.26	74.00	-13.74	Peak	100	265	P
5	5350.00	5.07	39.79	44.86	54.00	-9.14	Average	100	265	P
6	5350.00	5.07	52.52	57.59	74.00	-16.41	Peak	100	265	P
7	10420.00	11.49	40.56	52.05	68.20	-16.15	Peak	100	255	P
8	15630.00	13.80	28.30	42.10	54.00	-11.90	Average	100	130	P
9	15630.00	13.80	41.66	55.46	74.00	-18.54	Peak	100	130	P

Note: Level=Reading+Factor
 Margin=Level-Limit
 Factor=Antenna Factor + cable loss - Amplifier Factor



Power	: AC 120V / 60Hz	Pol/Phase	: HORIZONTAL
Test Mode	: Mode 4, Band 1, CH42		:

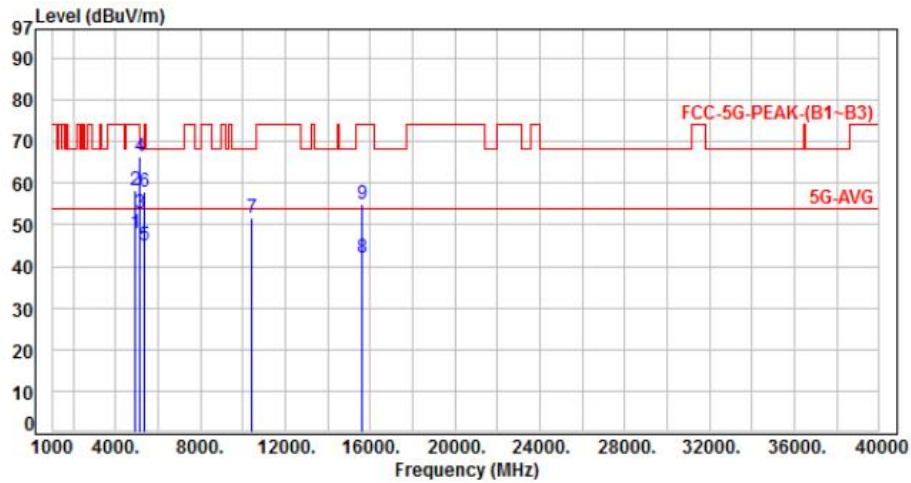

No.	Frequency (MHz)	Factor (dB)	Reading (dBuV)	Level (dBuV/m)	Limit (dBuV/m)	Margin (dB)	Detector	Height (cm)	Azimuth (deg)	P/F
1	4890.00	4.00	43.77	47.77	54.00	-6.23	Average	140	310	P
2	4890.00	4.00	54.09	58.09	74.00	-15.91	Peak	140	310	P
3	5150.00	4.73	48.14	52.87	54.00	-1.13	Average	155	305	P
4	5150.00	4.73	61.75	66.48	74.00	-7.52	Peak	155	305	P
5	5350.00	5.07	39.87	44.94	54.00	-9.06	Average	155	305	P
6	5350.00	5.07	52.66	57.73	74.00	-16.27	Peak	155	305	P
7	10420.00	11.49	40.25	51.74	68.20	-16.46	Peak	100	124	P
8	15630.00	13.80	28.32	42.12	54.00	-11.88	Average	100	124	P
9	15630.00	13.80	41.17	54.97	74.00	-19.03	Peak	100	124	P

Note: Level=Reading+Factor
 Margin=Level-Limit
 Factor=Antenna Factor + cable loss - Amplifier Factor



Power	: AC 120V / 60Hz	Pol/Phase	: VERTICAL
Test Mode	: Mode 1, Band 4, CH149		:

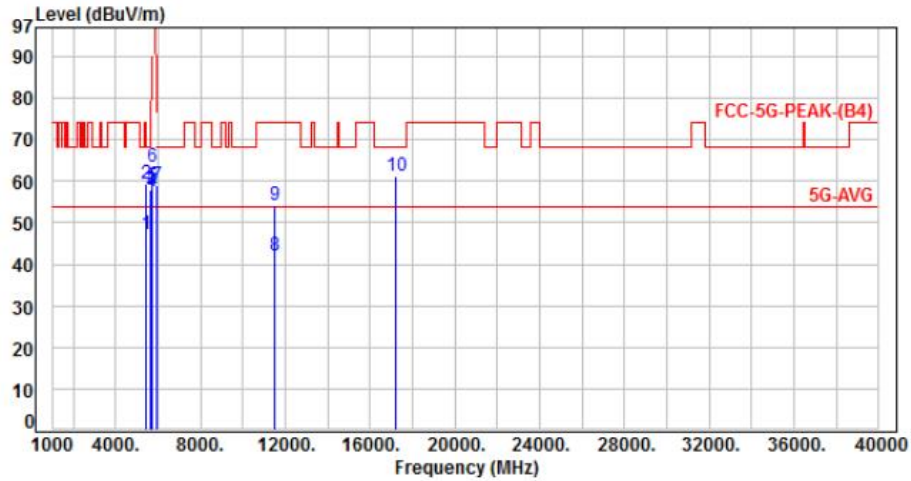

No.	Frequency (MHz)	Factor (dB)	Reading (dBuV)	Level (dBuV/m)	Limit (dBuV/m)	Margin (dB)	Detector	Height (cm)	Azimuth (deg)	P/F
1	5425.00	5.22	42.00	47.22	54.00	-6.78	Average	390	355	P
2	5425.00	5.22	54.15	59.37	74.00	-14.63	Peak	390	355	P
3	5650.00	5.25	52.50	57.75	68.20	-10.45	Peak	390	355	P
4	5700.00	5.18	52.23	57.41	105.20	-47.79	Peak	390	355	P
5	5720.00	5.19	53.38	58.57	110.80	-52.23	Peak	390	355	P
6	5725.00	5.19	58.17	63.36	122.20	-58.84	Peak	390	355	P
7	5925.00	5.60	53.27	58.87	68.20	-9.33	Peak	390	355	P
8	11490.00	13.16	28.71	41.87	54.00	-12.13	Average	100	103	P
9	11490.00	13.16	41.23	54.39	74.00	-19.61	Peak	100	103	P
10	17235.00	19.21	41.83	61.04	68.20	-7.16	Peak	100	218	P

Note: Level=Reading+Factor
 Margin=Level-Limit
 Factor=Antenna Factor + cable loss - Amplifier Factor



Power	: AC 120V / 60Hz	Pol/Phase	: HORIZONTAL
Test Mode	: Mode 1, Band 4, CH149		:

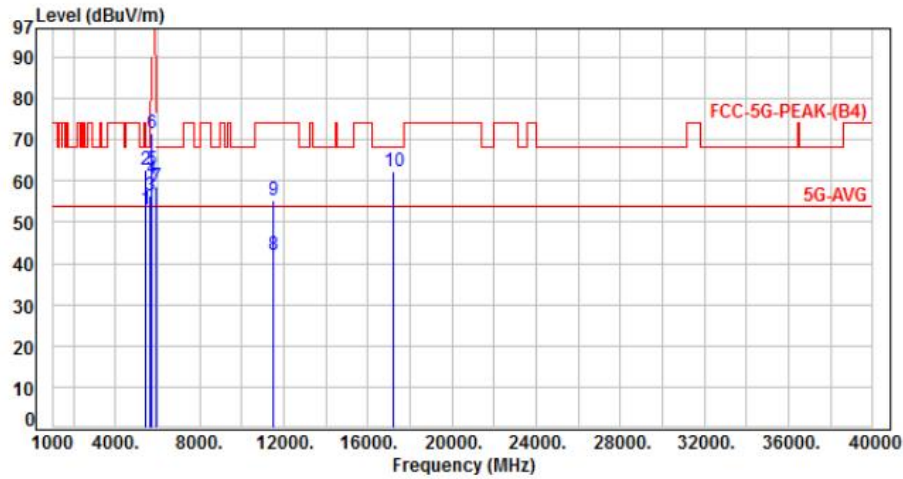

No.	Frequency (MHz)	Factor (dB)	Reading (dBuV)	Level (dBuV/m)	Limit (dBuV/m)	Margin (dB)	Detector	Height (cm)	Azimuth (deg)	P/F
1	5425.00	5.22	47.77	52.99	54.00	-1.01	Average	190	318	P
2	5425.00	5.22	57.42	62.64	74.00	-11.36	Peak	190	318	P
3	5650.00	5.25	51.29	56.54	68.20	-11.66	Peak	190	318	P
4	5700.00	5.18	55.36	60.54	105.20	-44.66	Peak	190	318	P
5	5720.00	5.19	57.50	62.69	110.80	-48.11	Peak	190	318	P
6	5725.00	5.19	66.50	71.69	122.20	-50.51	Peak	190	318	P
7	5925.00	5.60	53.12	58.72	68.20	-9.48	Peak	190	318	P
8	11490.00	13.16	28.75	41.91	54.00	-12.09	Average	100	46	P
9	11490.00	13.16	42.15	55.31	74.00	-18.69	Peak	100	46	P
10	17235.00	19.21	42.97	62.18	68.20	-6.02	Peak	100	316	P

Note: Level=Reading+Factor
 Margin=Level-Limit
 Factor=Antenna Factor + cable loss - Amplifier Factor



Power	: AC 120V / 60Hz	Pol/Phase	: VERTICAL
Test Mode	: Mode 1, Band 4, CH157		:

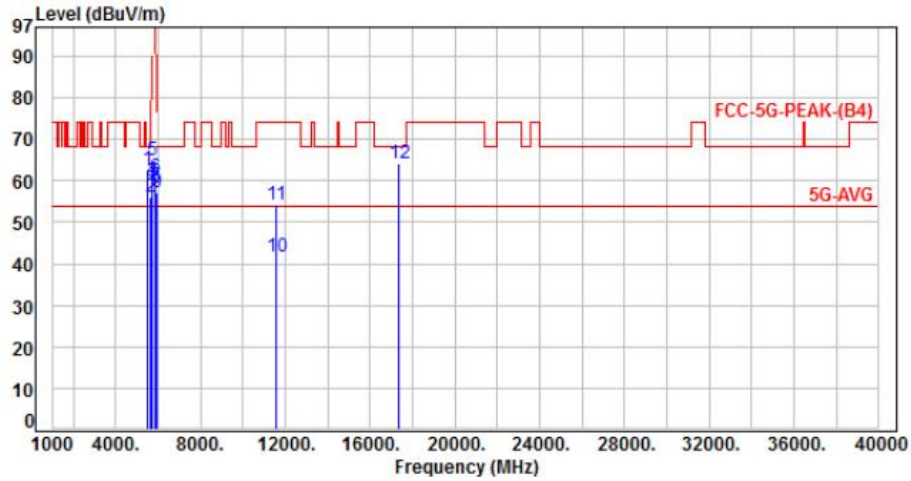

No.	Frequency (MHz)	Factor (dB)	Reading (dBuV)	Level (dBuV/m)	Limit (dBuV/m)	Margin (dB)	Detector	Height (cm)	Azimuth (deg)	P/F
1	5465.00	5.32	57.56	62.88	68.20	-5.32	Peak	393	337	P
2	5650.00	5.25	50.89	56.14	68.20	-12.06	Peak	393	337	P
3	5700.00	5.18	54.62	59.80	105.20	-45.40	Peak	393	337	P
4	5720.00	5.19	54.96	60.15	110.80	-50.65	Peak	393	337	P
5	5725.00	5.19	59.65	64.84	122.20	-57.36	Peak	393	337	P
6	5850.00	5.37	55.39	60.76	122.20	-61.44	Peak	393	337	P
7	5855.00	5.39	53.29	58.68	110.80	-52.12	Peak	393	337	P
8	5875.00	5.47	53.12	58.59	105.20	-46.61	Peak	393	337	P
9	5925.00	5.60	51.64	57.24	68.20	-10.96	Peak	393	337	P
10	11570.00	13.44	28.26	41.70	54.00	-12.30	Average	100	112	P
11	11570.00	13.44	40.65	54.09	74.00	-19.91	Peak	100	112	P
12	17355.00	19.83	44.31	64.14	68.20	-4.06	Peak	100	222	P

Note: Level=Reading+Factor
 Margin=Level-Limit
 Factor=Antenna Factor + cable loss - Amplifier Factor



Power	: AC 120V / 60Hz	Pol/Phase	: HORIZONTAL
Test Mode	: Mode 1, Band 4, CH157		:

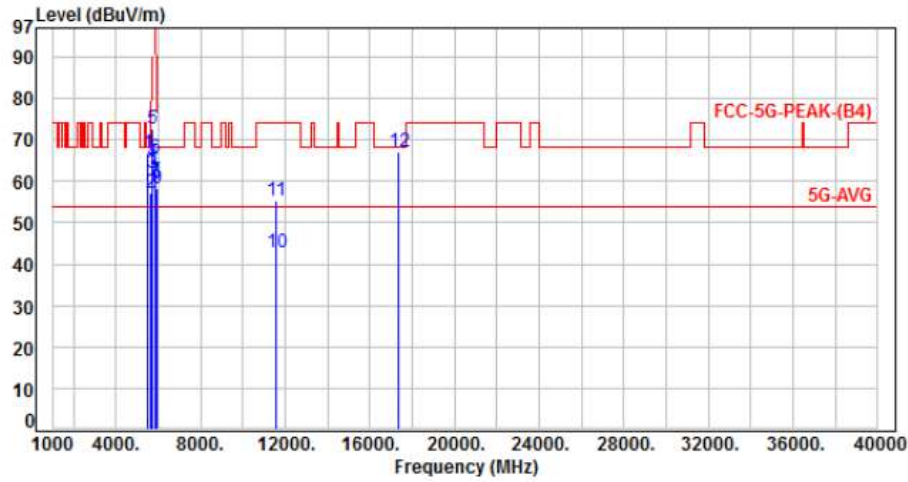

No.	Frequency (MHz)	Factor (dB)	Reading (dBuV)	Level (dBuV/m)	Limit (dBuV/m)	Margin (dB)	Detector	Height (cm)	Azimuth (deg)	P/F
1	5465.00	5.32	61.60	66.92	68.20	-1.28	Peak	160	315	P
2	5650.00	5.25	52.01	57.26	68.20	-10.94	Peak	160	315	P
3	5700.00	5.18	56.71	61.89	105.20	-43.31	Peak	160	315	P
4	5720.00	5.19	59.26	64.45	110.80	-46.35	Peak	160	315	P
5	5725.00	5.19	67.65	72.84	122.20	-49.36	Peak	160	315	P
6	5850.00	5.37	60.43	65.80	122.20	-56.40	Peak	160	315	P
7	5855.00	5.39	54.71	60.10	110.80	-50.70	Peak	160	315	P
8	5875.00	5.47	54.40	59.87	105.20	-45.33	Peak	160	315	P
9	5925.00	5.60	52.61	58.21	68.20	-9.99	Peak	160	315	P
10	11570.00	13.44	29.39	42.83	54.00	-11.17	Average	100	49	P
11	11570.00	13.44	41.78	55.22	74.00	-18.78	Peak	100	49	P
12	17355.00	19.83	47.26	67.09	68.20	-1.11	Peak	220	218	P

Note: Level=Reading+Factor
 Margin=Level-Limit
 Factor=Antenna Factor + cable loss - Amplifier Factor



Power	: AC 120V / 60Hz	Pol/Phase	: VERTICAL
Test Mode	: Mode 1, Band 4, CH165		:

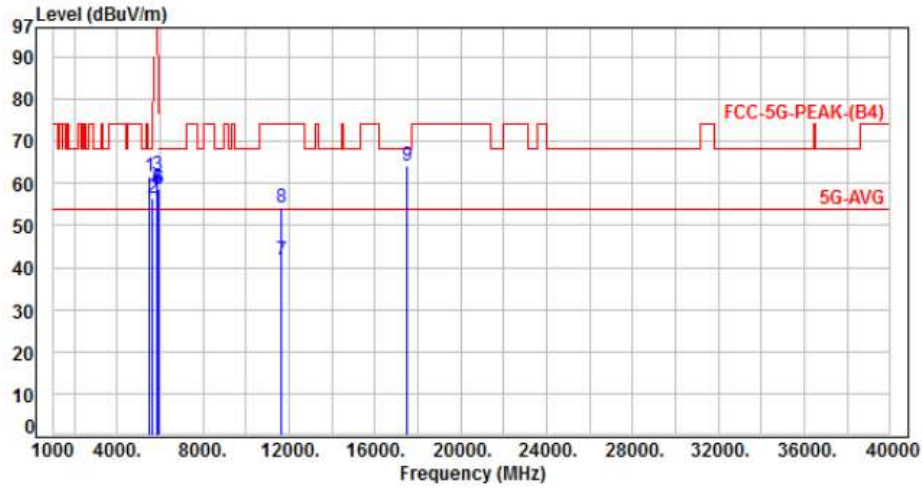

No.	Frequency (MHz)	Factor (dB)	Reading (dBuV)	Level (dBuV/m)	Limit (dBuV/m)	Margin (dB)	Detector	Height (cm)	Azimuth (deg)	P/F
1	5505.00	5.27	56.40	61.67	68.20	-6.53	Peak	392	336	P
2	5650.00	5.25	51.36	56.61	68.20	-11.59	Peak	392	336	P
3	5850.00	5.37	56.75	62.12	122.20	-60.08	Peak	392	336	P
4	5855.00	5.39	53.56	58.95	110.80	-51.85	Peak	392	336	P
5	5875.00	5.47	53.22	58.69	105.20	-46.51	Peak	392	336	P
6	5925.00	5.60	53.01	58.61	68.20	-9.59	Peak	392	336	P
7	11650.00	13.60	28.16	41.76	54.00	-12.24	Average	100	102	P
8	11650.00	13.60	40.59	54.19	74.00	-19.81	Peak	100	102	P
9	17475.00	20.67	43.57	64.24	68.20	-3.96	Peak	100	214	P

Note: Level=Reading+Factor
 Margin=Level-Limit
 Factor=Antenna Factor + cable loss - Amplifier Factor



Power	: AC 120V / 60Hz	Pol/Phase	: HORIZONTAL
Test Mode	: Mode 1, Band 4, CH165		:

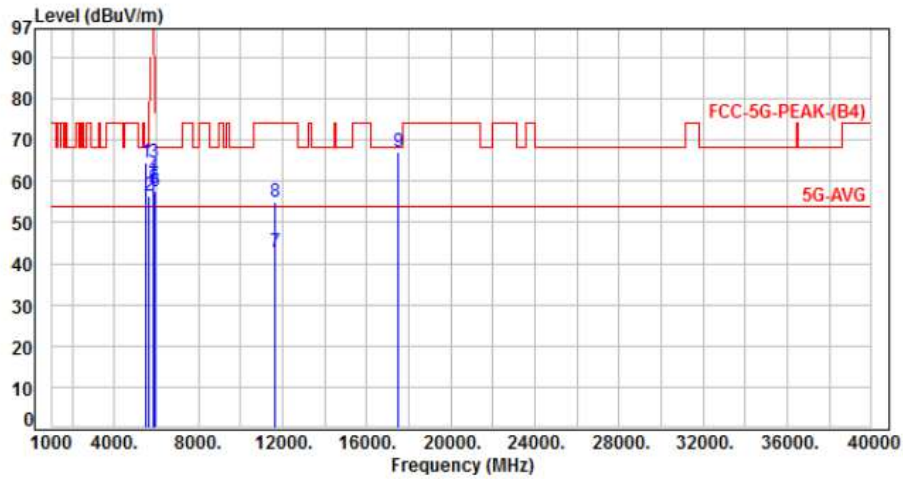

No.	Frequency (MHz)	Factor (dB)	Reading (dBuV)	Level (dBuV/m)	Limit (dBuV/m)	Margin (dB)	Detector	Height (cm)	Azimuth (deg)	P/F
1	5505.00	5.27	59.40	64.67	68.20	-3.53	Peak	133	325	P
2	5650.00	5.25	51.06	56.31	68.20	-11.89	Peak	133	325	P
3	5850.00	5.37	59.08	64.45	122.20	-57.75	Peak	133	325	P
4	5855.00	5.39	55.83	61.22	110.80	-49.58	Peak	133	325	P
5	5875.00	5.47	52.91	58.38	105.20	-46.82	Peak	133	325	P
6	5925.00	5.60	51.79	57.39	68.20	-10.81	Peak	133	325	P
7	11650.00	13.60	29.26	42.86	54.00	-11.14	Average	100	45	P
8	11650.00	13.60	41.53	55.13	74.00	-18.87	Peak	100	45	P
9	17475.00	20.67	46.40	67.07	68.20	-1.13	Peak	217	213	P

Note: Level=Reading+Factor
 Margin=Level-Limit
 Factor=Antenna Factor + cable loss - Amplifier Factor



Power	: AC 120V / 60Hz	Pol/Phase	: VERTICAL
Test Mode	: Mode 2, Band 4, CH149		:

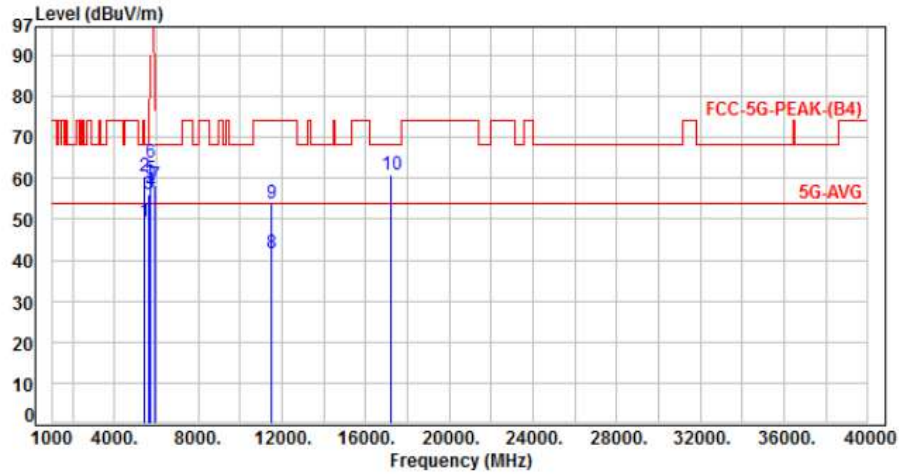

No.	Frequency (MHz)	Factor (dB)	Reading (dBUV)	Level (dBUV/m)	Limit (dBUV/m)	Margin (dB)	Detector	Height (cm)	Azimuth (deg)	P/F
1	5425.00	5.22	44.30	49.52	54.00	-4.48	Average	397	334	P
2	5425.00	5.22	55.31	60.53	74.00	-13.47	Peak	397	334	P
3	5650.00	5.25	50.98	56.23	68.20	-11.97	Peak	397	334	P
4	5700.00	5.18	51.52	56.70	105.20	-48.50	Peak	397	334	P
5	5720.00	5.19	54.42	59.61	110.80	-51.19	Peak	397	334	P
6	5725.00	5.19	58.63	63.82	122.20	-58.38	Peak	397	334	P
7	5925.00	5.60	52.86	58.46	68.20	-9.74	Peak	397	334	P
8	11490.00	13.16	28.36	41.52	54.00	-12.48	Average	100	100	P
9	11490.00	13.16	40.81	53.97	74.00	-20.03	Peak	100	100	P
10	17235.00	19.21	41.63	60.84	68.20	-7.36	Peak	100	215	P

Note: Level=Reading+Factor
 Margin=Level-Limit
 Factor=Antenna Factor + cable loss - Amplifier Factor



Power	: AC 120V / 60Hz	Pol/Phase	: HORIZONTAL
Test Mode	: Mode 2, Band 4, CH149		:

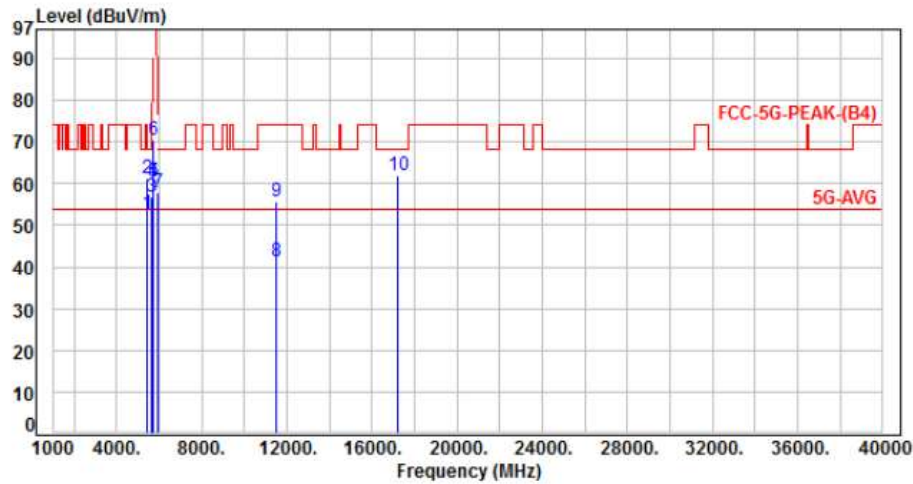

No.	Frequency (MHz)	Factor (dB)	Reading (dBuV)	Level (dBuV/m)	Limit (dBuV/m)	Margin (dB)	Detector	Height (cm)	Azimuth (deg)	P/F
1	5425.00	5.22	47.60	52.82	54.00	-1.18	Average	135	309	P
2	5425.00	5.22	55.99	61.21	74.00	-12.79	Peak	135	309	P
3	5650.00	5.25	51.60	56.85	68.20	-11.35	Peak	135	309	P
4	5700.00	5.18	55.40	60.58	105.20	-44.62	Peak	135	309	P
5	5720.00	5.19	55.42	60.61	110.80	-50.19	Peak	135	309	P
6	5725.00	5.19	65.08	70.27	122.20	-51.93	Peak	135	309	P
7	5925.00	5.60	52.14	57.74	68.20	-10.46	Peak	135	309	P
8	11490.00	13.16	28.25	41.41	54.00	-12.59	Average	100	43	P
9	11490.00	13.16	42.35	55.51	74.00	-18.49	Peak	100	43	P
10	17235.00	19.21	42.66	61.87	68.20	-6.33	Peak	100	322	P

Note: Level=Reading+Factor
 Margin=Level-Limit
 Factor=Antenna Factor + cable loss - Amplifier Factor



Power	: AC 120V / 60Hz	Pol/Phase	: VERTICAL
Test Mode	: Mode 2, Band 4, CH157		:

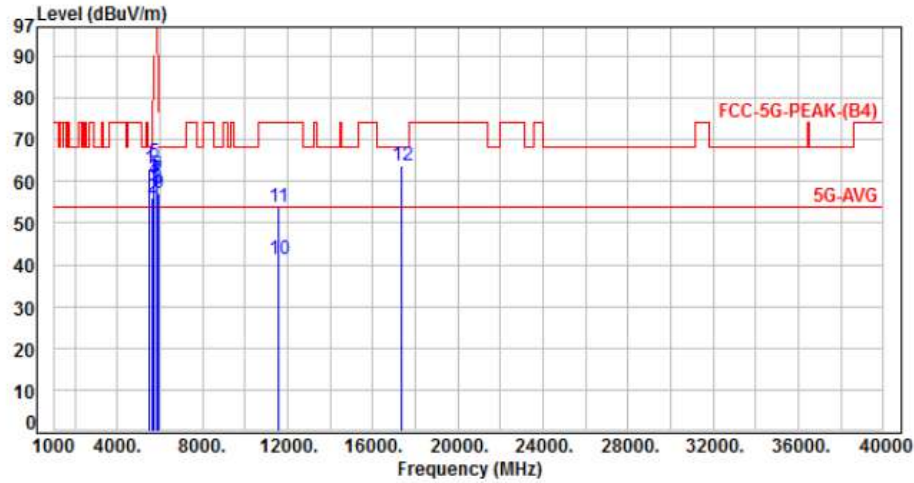

No.	Frequency (MHz)	Factor (dB)	Reading (dBuV)	Level (dBuV/m)	Limit (dBuV/m)	Margin (dB)	Detector	Height (cm)	Azimuth (deg)	P/F
1	5465.00	5.32	57.81	63.13	68.20	-5.07	Peak	395	331	P
2	5650.00	5.25	50.92	56.17	68.20	-12.03	Peak	395	331	P
3	5700.00	5.18	55.52	60.70	105.20	-44.50	Peak	395	331	P
4	5720.00	5.19	55.39	60.58	110.80	-50.22	Peak	395	331	P
5	5725.00	5.19	59.42	64.61	122.20	-57.59	Peak	395	331	P
6	5850.00	5.37	56.09	61.46	122.20	-60.74	Peak	395	331	P
7	5855.00	5.39	55.16	60.55	110.80	-50.25	Peak	395	331	P
8	5875.00	5.47	52.94	58.41	105.20	-46.79	Peak	395	331	P
9	5925.00	5.60	51.45	57.05	68.20	-11.15	Peak	395	331	P
10	11570.00	13.44	27.76	41.20	54.00	-12.80	Average	100	106	P
11	11570.00	13.44	40.52	53.96	74.00	-20.04	Peak	100	106	P
12	17355.00	19.83	43.83	63.66	68.20	-4.54	Peak	100	218	P

Note: Level=Reading+Factor
 Margin=Level-Limit
 Factor=Antenna Factor + cable loss - Amplifier Factor



Power	: AC 120V / 60Hz	Pol/Phase	: HORIZONTAL
Test Mode	: Mode 2, Band 4, CH157		:

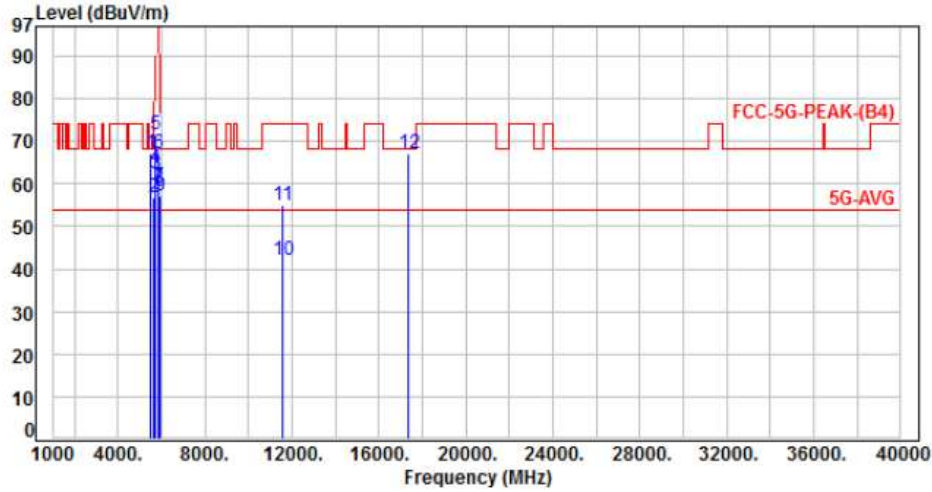

No.	Frequency (MHz)	Factor (dB)	Reading (dBUV)	Level (dBUV/m)	Limit (dBUV/m)	Margin (dB)	Detector	Height (cm)	Azimuth (deg)	P/F
1	5465.00	5.32	61.83	67.15	68.20	-1.05	Peak	152	313	P
2	5650.00	5.25	51.72	56.97	68.20	-11.23	Peak	152	313	P
3	5700.00	5.18	57.33	62.51	105.20	-42.69	Peak	152	313	P
4	5720.00	5.19	58.75	63.94	110.80	-46.86	Peak	152	313	P
5	5725.00	5.19	66.20	71.39	122.20	-50.81	Peak	152	313	P
6	5850.00	5.37	61.70	67.07	122.20	-55.13	Peak	152	313	P
7	5855.00	5.39	53.92	59.31	110.80	-51.49	Peak	152	313	P
8	5875.00	5.47	53.62	59.09	105.20	-46.11	Peak	152	313	P
9	5925.00	5.60	51.73	57.33	68.20	-10.87	Peak	152	313	P
10	11570.00	13.44	28.43	41.87	54.00	-12.13	Average	100	52	P
11	11570.00	13.44	41.69	55.13	74.00	-18.87	Peak	100	52	P
12	17355.00	19.83	47.24	67.07	68.20	-1.13	Peak	236	220	P

Note: Level=Reading+Factor
 Margin=Level-Limit
 Factor=Antenna Factor + cable loss - Amplifier Factor



Power	: AC 120V / 60Hz	Pol/Phase	: VERTICAL
Test Mode	: Mode 2, Band 4, CH165		:

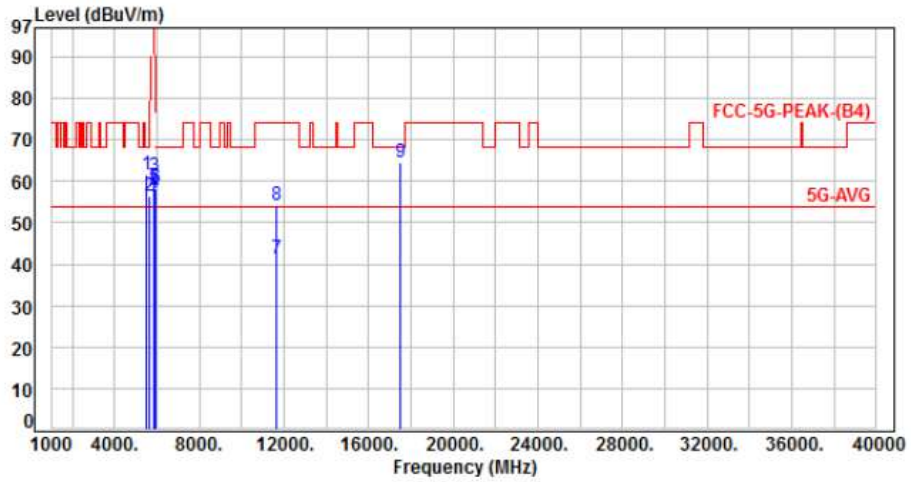

No.	Frequency (MHz)	Factor (dB)	Reading (dBUV)	Level (dBUV/m)	Limit (dBUV/m)	Margin (dB)	Detector	Height (cm)	Azimuth (deg)	P/F
1	5505.00	5.27	56.31	61.58	68.20	-6.62	Peak	395	335	P
2	5650.00	5.25	51.12	56.37	68.20	-11.83	Peak	395	335	P
3	5850.00	5.37	55.81	61.18	122.20	-61.02	Peak	395	335	P
4	5855.00	5.39	51.92	57.31	110.80	-53.49	Peak	395	335	P
5	5875.00	5.47	53.07	58.54	105.20	-46.66	Peak	395	335	P
6	5925.00	5.60	52.65	58.25	68.20	-9.95	Peak	395	335	P
7	11650.00	13.60	27.61	41.21	54.00	-12.79	Average	100	112	P
8	11650.00	13.60	40.49	54.09	74.00	-19.91	Peak	100	112	P
9	17475.00	20.67	43.76	64.43	68.20	-3.77	Peak	100	218	P

Note: Level=Reading+Factor
 Margin=Level-Limit
 Factor=Antenna Factor + cable loss - Amplifier Factor



Power	: AC 120V / 60Hz	Pol/Phase	: HORIZONTAL
Test Mode	: Mode 2, Band 4, CH165		:

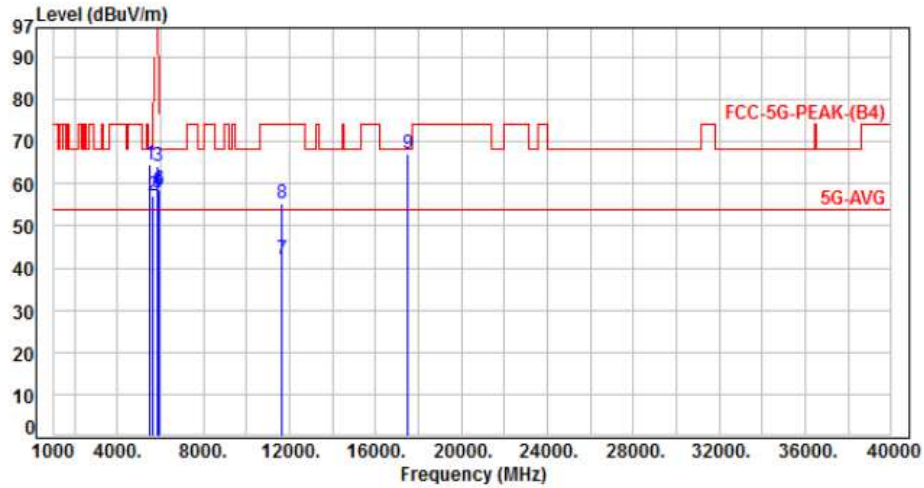

No.	Frequency (MHz)	Factor (dB)	Reading (dBuV)	Level (dBuV/m)	Limit (dBuV/m)	Margin (dB)	Detector	Height (cm)	Azimuth (deg)	P/F
1	5505.00	5.27	59.17	64.44	68.20	-3.76	Peak	145	306	P
2	5650.00	5.25	51.76	57.01	68.20	-11.19	Peak	145	306	P
3	5850.00	5.37	58.72	64.09	122.20	-58.11	Peak	145	306	P
4	5855.00	5.39	52.71	58.10	110.80	-52.70	Peak	145	306	P
5	5875.00	5.47	52.49	57.96	105.20	-47.24	Peak	145	306	P
6	5925.00	5.60	52.93	58.53	68.20	-9.67	Peak	145	306	P
7	11650.00	13.60	28.35	41.95	54.00	-12.05	Average	100	44	P
8	11650.00	13.60	41.75	55.35	74.00	-18.65	Peak	100	44	P
9	17475.00	20.67	46.53	67.20	68.20	-1.00	Peak	235	215	P

Note: Level=Reading+Factor
 Margin=Level-Limit
 Factor=Antenna Factor + cable loss - Amplifier Factor



Power	: AC 120V / 60Hz	Pol/Phase	: VERTICAL
Test Mode	: Mode 3, Band 4, CH151		:

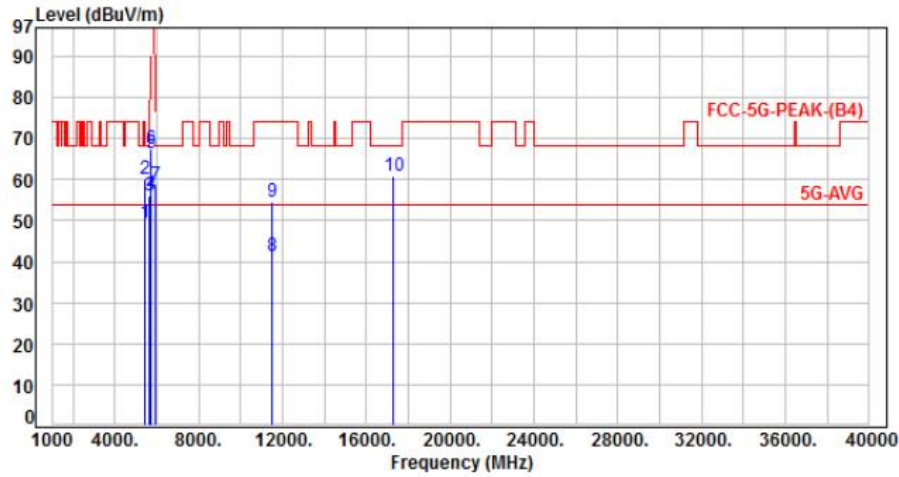

No.	Frequency (MHz)	Factor (dB)	Reading (dBuV)	Level (dBuV/m)	Limit (dBuV/m)	Margin (dB)	Detector	Height (cm)	Azimuth (deg)	P/F
1	5435.00	5.27	44.13	49.40	54.00	-4.60	Average	378	338	P
2	5435.00	5.27	54.70	59.97	74.00	-14.03	Peak	378	338	P
3	5650.00	5.25	50.78	56.03	68.20	-12.17	Peak	378	338	P
4	5700.00	5.18	51.36	56.54	105.20	-48.66	Peak	378	338	P
5	5720.00	5.19	61.30	66.49	110.80	-44.31	Peak	378	338	P
6	5725.00	5.19	62.39	67.58	122.20	-54.62	Peak	378	338	P
7	5925.00	5.60	53.12	58.72	68.20	-9.48	Peak	378	338	P
8	11510.00	13.20	28.14	41.34	54.00	-12.66	Average	100	111	P
9	11510.00	13.20	41.27	54.47	74.00	-19.53	Peak	100	111	P
10	17265.00	19.34	41.42	60.76	68.20	-7.44	Peak	100	209	P

Note: Level=Reading+Factor
 Margin=Level-Limit
 Factor=Antenna Factor + cable loss - Amplifier Factor



Power	: AC 120V / 60Hz	Pol/Phase	: HORIZONTAL
Test Mode	: Mode 3, Band 4, CH151		:

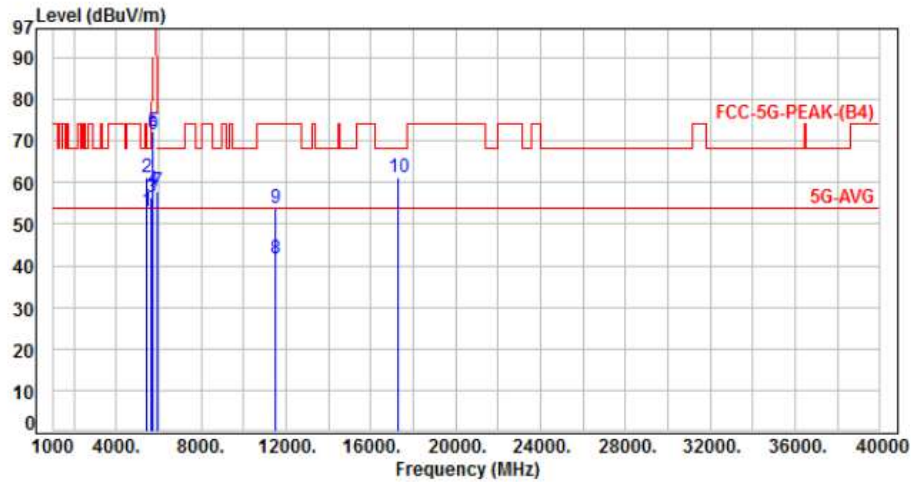

No.	Frequency (MHz)	Factor (dB)	Reading (dBuV)	Level (dBuV/m)	Limit (dBuV/m)	Margin (dB)	Detector	Height (cm)	Azimuth (deg)	P/F
1	5435.00	5.27	47.72	52.99	54.00	-1.01	Average	140	311	P
2	5435.00	5.27	56.07	61.34	74.00	-12.66	Peak	140	311	P
3	5650.00	5.25	51.30	56.55	68.20	-11.65	Peak	140	311	P
4	5700.00	5.18	53.05	58.23	105.20	-46.97	Peak	140	311	P
5	5720.00	5.19	66.93	72.12	110.80	-38.68	Peak	140	311	P
6	5725.00	5.19	66.41	71.60	122.20	-50.60	Peak	140	311	P
7	5925.00	5.60	52.28	57.88	68.20	-10.32	Peak	140	311	P
8	11510.00	13.20	28.30	41.50	54.00	-12.50	Average	100	51	P
9	11510.00	13.20	40.68	53.88	74.00	-20.12	Peak	100	51	P
10	17265.00	19.34	41.76	61.10	68.20	-7.10	Peak	100	314	P

Note: Level=Reading+Factor
 Margin=Level-Limit
 Factor=Antenna Factor + cable loss - Amplifier Factor



Power	: AC 120V / 60Hz	Pol/Phase	: VERTICAL
Test Mode	: Mode 3, Band 4, CH159		

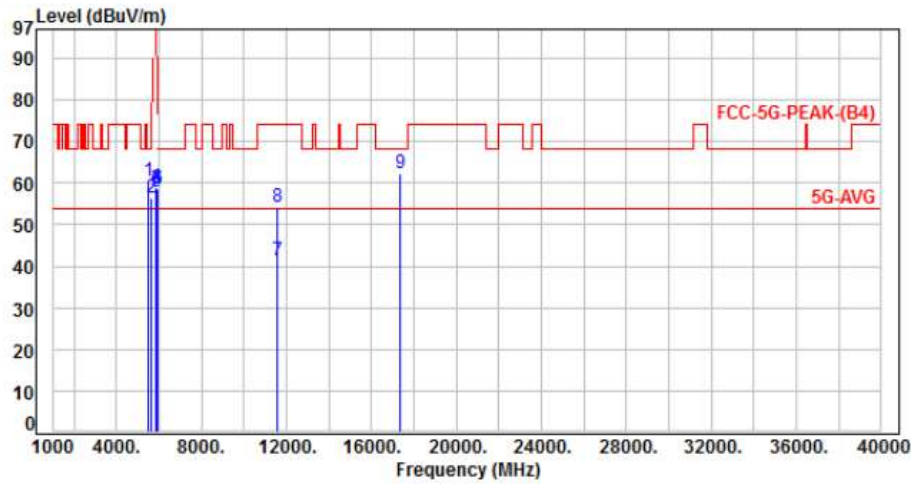

No.	Frequency (MHz)	Factor (dB)	Reading (dBuV)	Level (dBuV/m)	Limit (dBuV/m)	Margin (dB)	Detector	Height (cm)	Azimuth (deg)	P/F
1	5475.00	5.30	55.19	60.49	68.20	-7.71	Peak	396	333	P
2	5650.00	5.25	51.32	56.57	68.20	-11.63	Peak	396	333	P
3	5850.00	5.37	53.46	58.83	122.20	-63.37	Peak	396	333	P
4	5855.00	5.39	53.69	59.08	110.80	-51.72	Peak	396	333	P
5	5875.00	5.47	52.49	57.96	105.20	-47.24	Peak	396	333	P
6	5925.00	5.60	52.87	58.47	68.20	-9.73	Peak	396	333	P
7	11590.00	13.52	27.81	41.33	54.00	-12.67	Average	100	110	P
8	11590.00	13.52	40.59	54.11	74.00	-19.89	Peak	100	110	P
9	17385.00	20.03	42.46	62.49	68.20	-5.71	Peak	100	215	P

Note: Level=Reading+Factor
 Margin=Level-Limit
 Factor=Antenna Factor + cable loss - Amplifier Factor



Power	: AC 120V / 60Hz	Pol/Phase	: HORIZONTAL
Test Mode	: Mode 3, Band 4, CH159		:

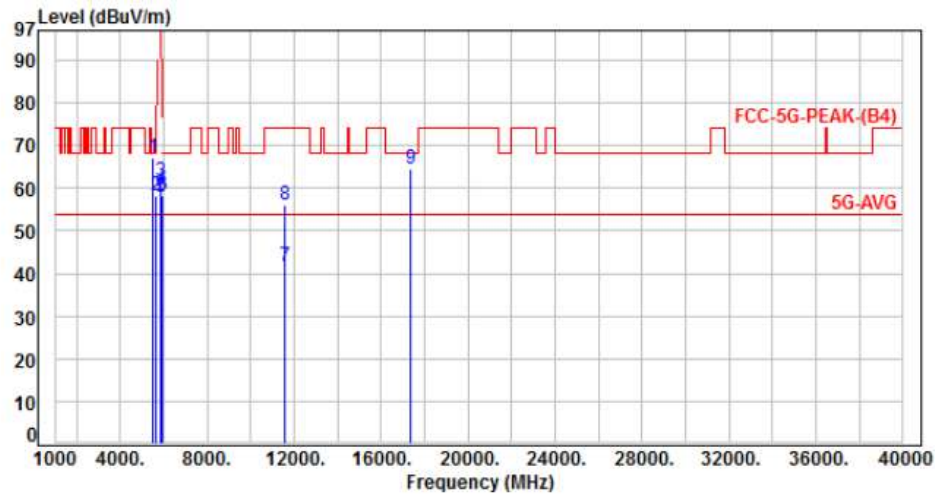

No.	Frequency (MHz)	Factor (dB)	Reading (dBuV)	Level (dBuV/m)	Limit (dBuV/m)	Margin (dB)	Detector	Height (cm)	Azimuth (deg)	P/F
1	5475.00	5.30	61.65	66.95	68.20	-1.25	Peak	162	310	P
2	5650.00	5.25	53.15	58.40	68.20	-9.80	Peak	162	310	P
3	5850.00	5.37	56.31	61.68	122.20	-60.52	Peak	162	310	P
4	5855.00	5.39	54.48	59.87	110.80	-50.93	Peak	162	310	P
5	5875.00	5.47	52.27	57.74	105.20	-47.46	Peak	162	310	P
6	5925.00	5.60	52.59	58.19	68.20	-10.01	Peak	162	310	P
7	11590.00	13.52	28.29	41.81	54.00	-12.19	Average	100	53	P
8	11590.00	13.52	42.46	55.98	74.00	-18.02	Peak	100	53	P
9	17385.00	20.03	44.62	64.65	68.20	-3.55	Peak	220	213	P

Note: Level=Reading+Factor
 Margin=Level-Limit
 Factor=Antenna Factor + cable loss - Amplifier Factor



Power	: AC 120V / 60Hz	Pol/Phase	: VERTICAL
Test Mode	: Mode 4, Band 4, CH155		:

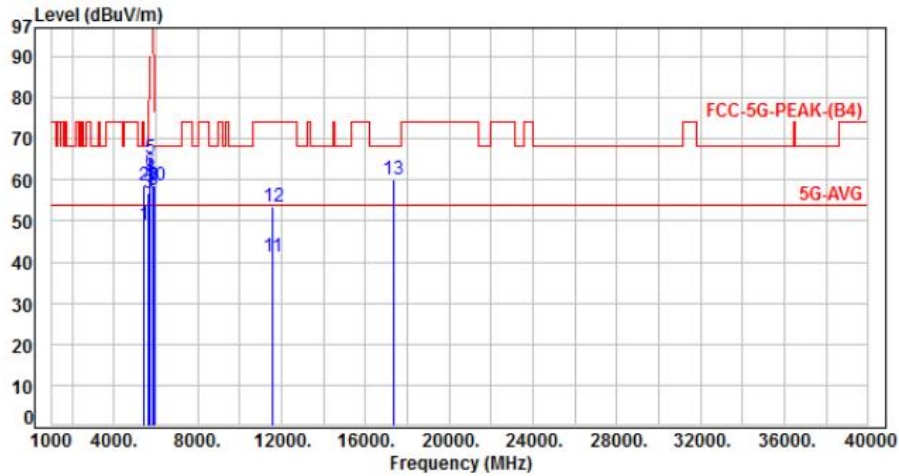

No.	Frequency (MHz)	Factor (dB)	Reading (dBuV)	Level (dBuV/m)	Limit (dBuV/m)	Margin (dB)	Detector	Height (cm)	Azimuth (deg)	P/F
1	5455.00	5.33	43.72	49.05	54.00	-4.95	Average	398	334	P
2	5455.00	5.33	53.48	58.81	74.00	-15.19	Peak	398	334	P
3	5650.00	5.25	51.50	56.75	68.20	-11.45	Peak	398	334	P
4	5700.00	5.18	55.40	60.58	105.20	-44.62	Peak	398	334	P
5	5720.00	5.19	60.22	65.41	110.80	-45.39	Peak	398	334	P
6	5725.00	5.19	56.86	62.05	122.20	-60.15	Peak	398	334	P
7	5850.00	5.37	52.80	58.17	122.20	-64.03	Peak	398	334	P
8	5855.00	5.39	52.11	57.50	110.80	-53.30	Peak	398	334	P
9	5875.00	5.47	53.17	58.64	105.20	-46.56	Peak	398	334	P
10	5925.00	5.60	52.97	58.57	68.20	-9.63	Peak	398	334	P
11	11550.00	13.36	27.86	41.22	54.00	-12.78	Average	100	106	P
12	11550.00	13.36	40.24	53.60	74.00	-20.40	Peak	100	106	P
13	17325.00	19.64	40.52	60.16	68.20	-8.04	Peak	100	212	P

Note: Level=Reading+Factor
 Margin=Level-Limit
 Factor=Antenna Factor + cable loss - Amplifier Factor



Power	: AC 120V / 60Hz	Pol/Phase	: HORIZONTAL
Test Mode	: Mode 4, Band 4, CH155		:

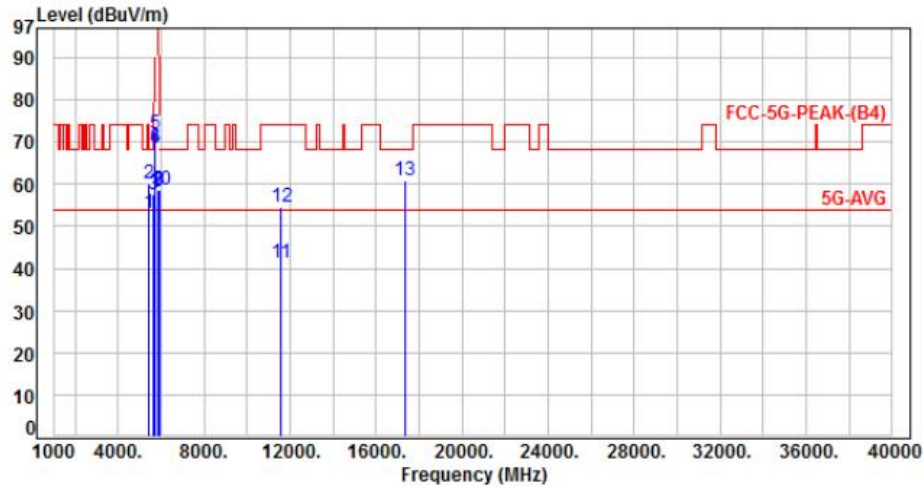

No.	Frequency (MHz)	Factor (dB)	Reading (dBuV)	Level (dBuV/m)	Limit (dBuV/m)	Margin (dB)	Detector	Height (cm)	Azimuth (deg)	P/F
1	5455.00	5.33	47.67	53.00	54.00	-1.00	Average	146	315	P
2	5455.00	5.33	54.85	60.18	74.00	-13.82	Peak	146	315	P
3	5650.00	5.25	52.12	57.37	68.20	-10.83	Peak	146	315	P
4	5700.00	5.18	63.48	68.66	105.20	-36.54	Peak	146	315	P
5	5720.00	5.19	66.80	71.99	110.80	-38.81	Peak	146	315	P
6	5725.00	5.19	63.55	68.74	122.20	-53.46	Peak	146	315	P
7	5850.00	5.37	53.08	58.45	122.20	-63.75	Peak	146	315	P
8	5855.00	5.39	52.92	58.31	110.80	-52.49	Peak	146	315	P
9	5875.00	5.47	53.26	58.73	105.20	-46.47	Peak	146	315	P
10	5925.00	5.60	52.91	58.51	68.20	-9.69	Peak	146	315	P
11	11550.00	13.36	27.88	41.24	54.00	-12.76	Average	100	55	P
12	11550.00	13.36	41.38	54.74	74.00	-19.26	Peak	100	55	P
13	17325.00	19.64	41.37	61.01	68.20	-7.19	Peak	100	320	P

Note: Level=Reading+Factor
 Margin=Level-Limit
 Factor=Antenna Factor + cable loss - Amplifier Factor



6.7. Restricted Bands of Operation

Only spurious emissions are permitted in any of the frequency bands listed below:

MHz	MHz	MHz	GHz
0.09000 – 0.11000	16.42000 – 16.42300	399.9 – 410.0	4.500 – 5.150
0.49500 – 0.505**	16.69475 – 16.69525	608.0 – 614.0	5.350 – 5.460
2.17350 – 2.19050	16.80425 – 16.80475	960.0 – 1240.0	7.250 – 7.750
4.12500 – 4.12800	25.50000 – 25.67000	1300.0 – 1427.0	8.025 – 8.500
4.17725 – 4.17775	37.50000 – 38.25000	1435.0 – 1626.5	9.000 – 9.200
4.20725 – 4.20775	73.00000 – 74.60000	1645.5 – 1646.5	9.300 – 9.500
6.21500 – 6.21800	74.80000 – 75.20000	1660.0 – 1710.0	10.600 – 12.700
6.26775 – 6.26825	108.00000 – 121.94000	1718.8 – 1722.2	13.250 – 13.400
6.31175 – 6.31225	123.00000 – 138.00000	2200.0 – 2300.0	14.470 – 14.500
8.29100 – 8.29400	149.90000 – 150.05000	2310.0 – 2390.0	15.350 – 16.200
8.36200 – 8.36600	156.52475 – 156.52525	2483.5 – 2500.0	17.700 – 21.400
8.37625 – 8.38675	156.70000 – 156.90000	2655.0 – 2900.0	22.010 – 23.120
8.41425 – 8.41475	162.01250 – 167.17000	3260.0 – 3267.0	23.600 – 24.000
12.29000 – 12.29300	167.72000 – 173.20000	3332.0 – 3339.0	31.200 – 31.800
12.51975 – 12.52025	240.00000 – 285.00000	3345.8 – 3358.0	36.430 – 36.500
12.57675 – 12.57725	322.00000 – 335.40000	3600.0 – 4400.0	Above 38.6
13.36000 – 13.41000			

** : Until February 1, 1999, this restricted band shall be 0.490-0.510 MHz



7. On Time, Duty Cycle and Measurement methods

7.1. Test Limit

None; for reporting purposes only.

7.2. Test Procedure

KDB 789033 Zero-Span Spectrum Analyzer Method.

7.3. Test Setup Layout

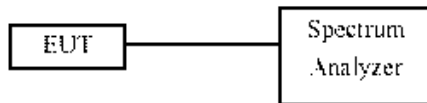

7.4. Test Result and Data

Modulation Type	On Time (ms)	Period Time (ms)	Duty Cycle (%)
802.11a,6M	2.07	2.13	97.43%
802.11ac VHT20	5.04	5.08	99.31%
802.11ac VHT40	2.47	2.53	97.60%
802.11ac VHT80	1.16	1.22	95.12%

7.5. Measurement Methods

26 dB and 6dB Emission BW	KDB 789033 D02 v02r01, Section C
99% Occupied BW	KDB 789033 D02 v02r01, Section D
Conducted Output Power	KDB 789033 D02 v02r01, Section E.2.d and E.3.b (Method PM-G)
Power Spectral Density	KDB 789033 D02 v02r01, Section F
Unwanted emissions in restricted bands	KDB 789033 D02 v02r01, Sections G and H
Unwanted emissions in non-restricted bands	KDB 789033 D02 v02r01, Sections G and H



Modulation Type: 802.11a (6Mbps)

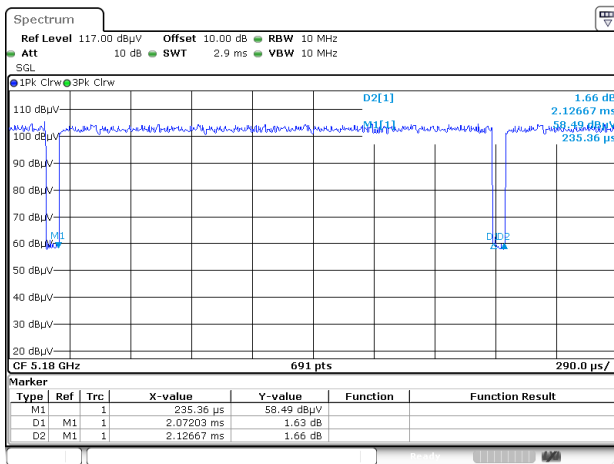

Modulation Type: 802.11ac VHT20 (6.5Mbps)

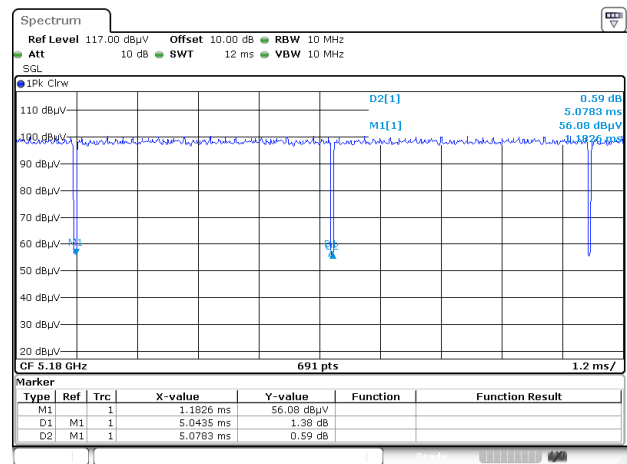

Modulation Type: 802.11ac VHT40 (13.5Mbps)

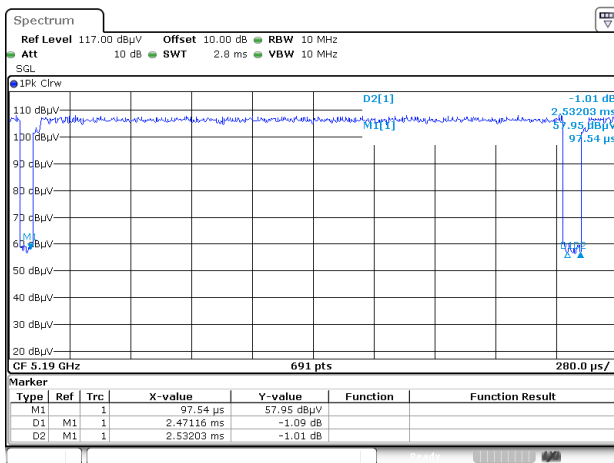

Modulation Type: 802.11ac VHT80 (29.3Mbps)

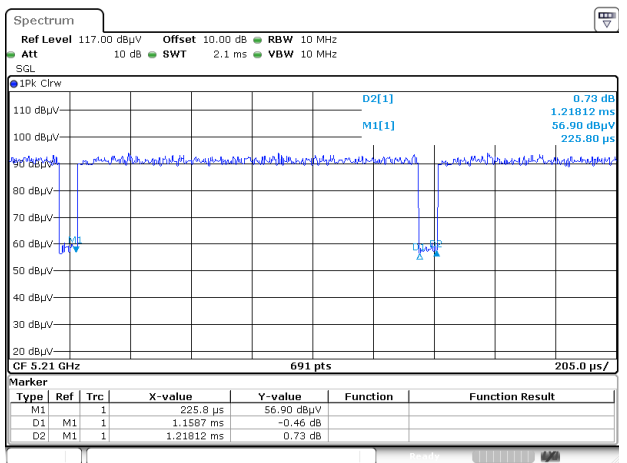



8. 6dB Bandwidth & 99% Occupied Bandwidth

8.1. Test Limit

FCC §15.407

The minimum 6 dB bandwidth shall be at least 500 kHz.

8.2. Test Procedure

Reference to 789033 D02 General UNII Test Procedures New Rules v01: The transmitter output is connected to a spectrum analyzer with the RBW set to 100KHz, the VBW >= 3 x RBW, peak detector and max hold.

8.3. Test Setup Layout

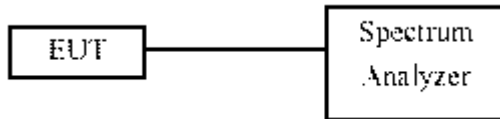

8.4. Test Result and Data (6dB Bandwidth)

In the 5.8G Band

Modulation Type	Channel	Frequency (MHz)	6dB Bandwidth(MHz)		Minimum Limit (MHz)
			ANT A	ANT B	
11a	149	5745	16.25	16.35	0.50
11a	157	5785	16.30	16.30	0.50
11a	165	5825	16.35	16.30	0.50
11ac VHT20	149	5745	17.30	17.25	0.50
11ac VHT20	157	5785	16.75	17.20	0.50
11ac VHT20	165	5825	17.30	17.15	0.50
11ac VHT40	151	5755	33.40	35.00	0.50
11ac VHT40	159	5795	34.90	34.10	0.50
11ac VHT80	155	5775	75.36	75.36	0.50



8.5. Test Result and Data (99% Occupied Bandwidth)

In the 5.8G Band

Modulation Type	Channel	Frequency (MHz)	99% Bandwidth(MHz)	
			ANT A	ANT B
11a	149	5745	16.55	16.50
11a	157	5785	16.55	16.55
11a	165	5825	16.55	16.55
11ac VHT20	149	5745	17.70	17.70
11ac VHT20	157	5785	17.70	17.70
11ac VHT20	165	5825	17.70	17.75
11ac VHT40	151	5755	36.20	36.30
11ac VHT40	159	5795	36.30	36.30
11ac VHT80	155	5775	75.84	75.84



6dB Bandwidth
ANT A
Modulation Type: 802.11a (6Mbps)
CH149

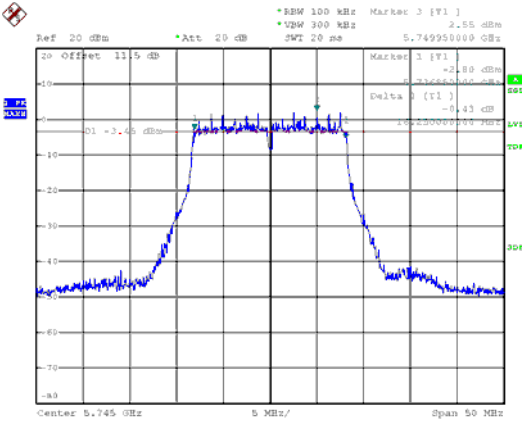

Modulation Type: 802.11ac, VHT20 (6.5Mbps)
CH149

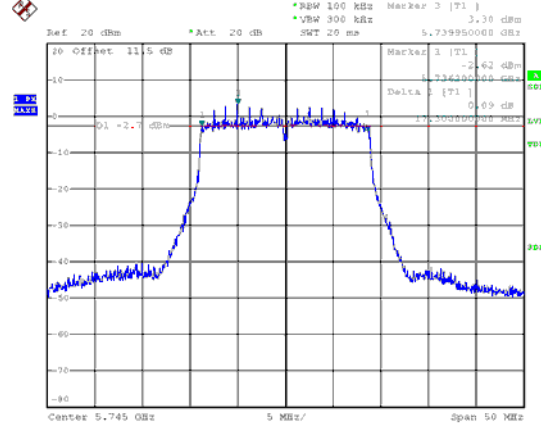

CH157

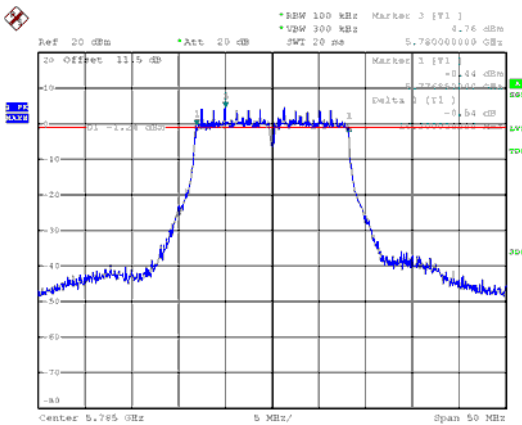

CH157

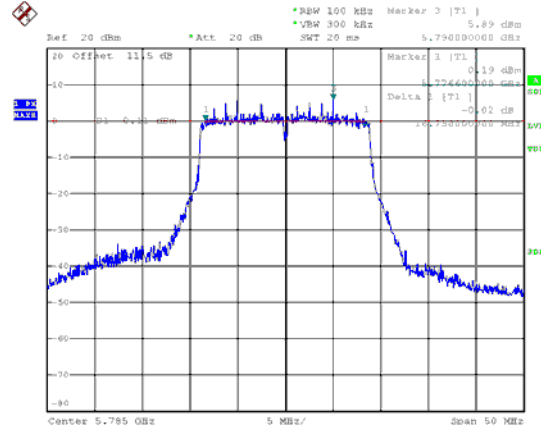

CH165

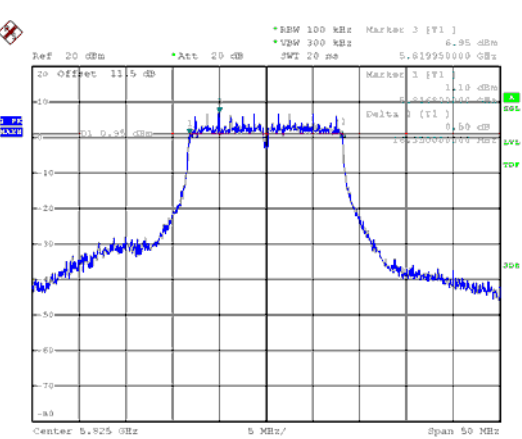

CH165

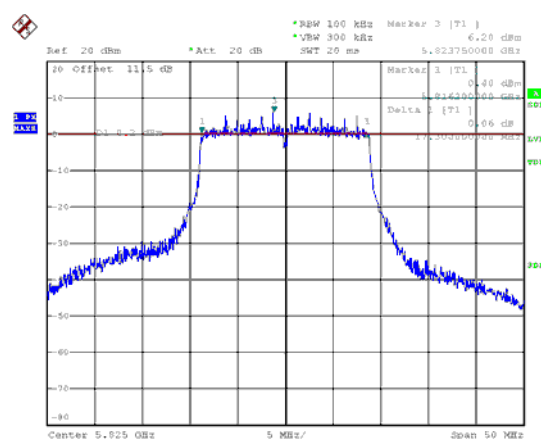



Modulation Type: 802.11ac, VHT40 (13.5Mbps)
CH151

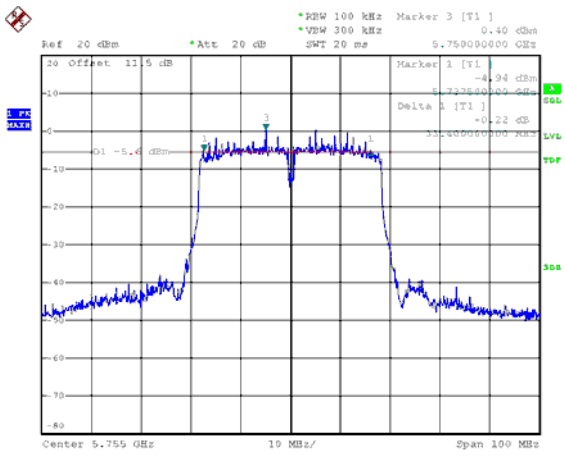

Modulation Type: 802.11ac, VHT80 (29.3Mbps)
CH155

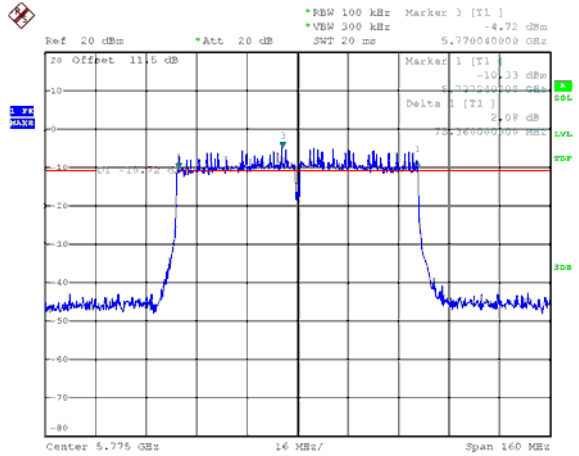

CH159

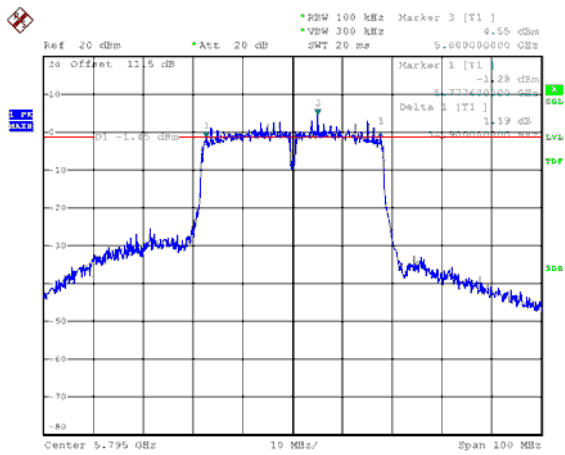



ANT B
Modulation Type: 802.11a (6Mbps)
CH149

Modulation Type: 802.11ac, VHT20 (6.5Mbps)
CH149

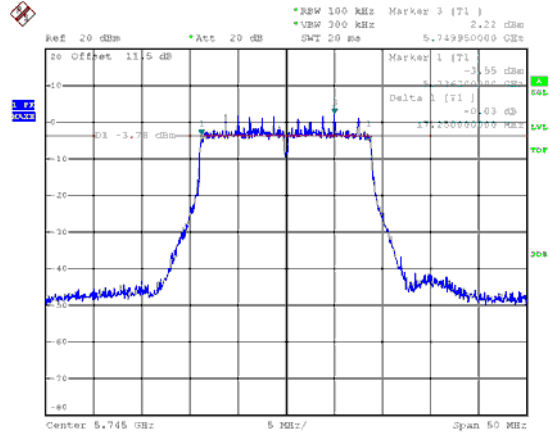
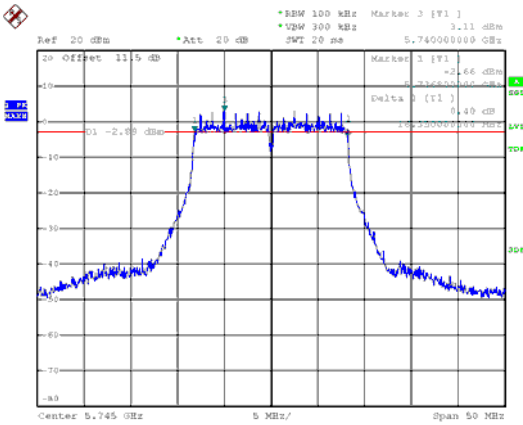

CH157

CH157

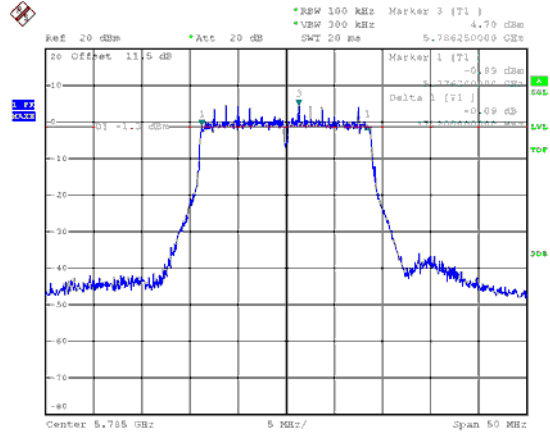
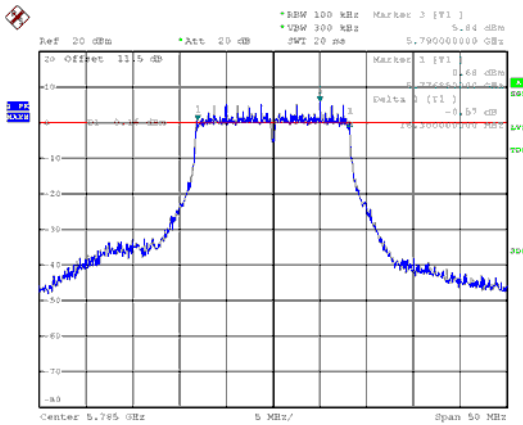

CH165

CH165

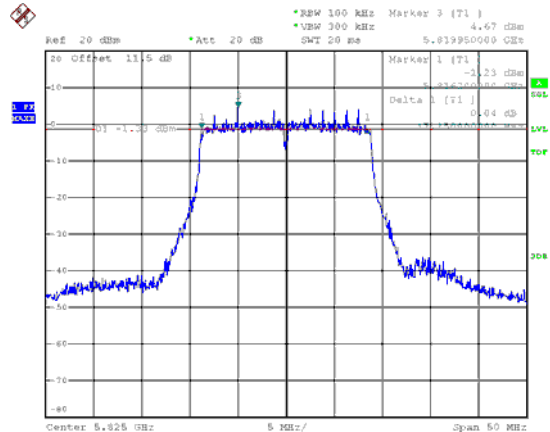
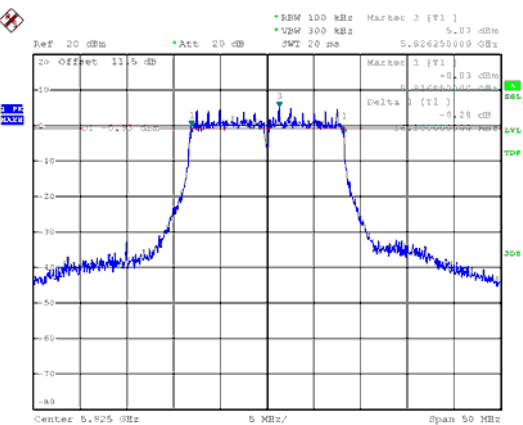



Modulation Type: 802.11ac, VHT40 (13.5Mbps)
CH151

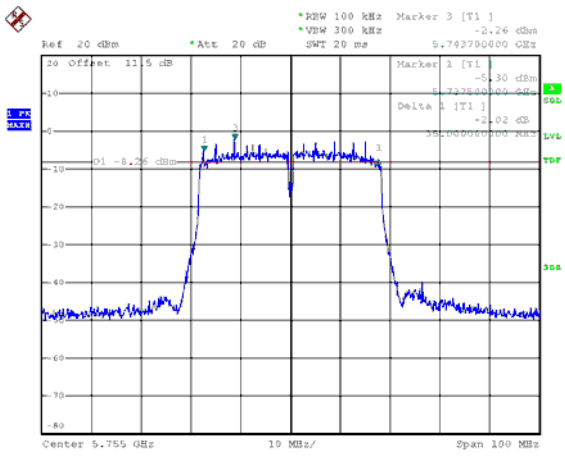

Modulation Type: 802.11ac, VHT80 (29.3Mbps)
CH155

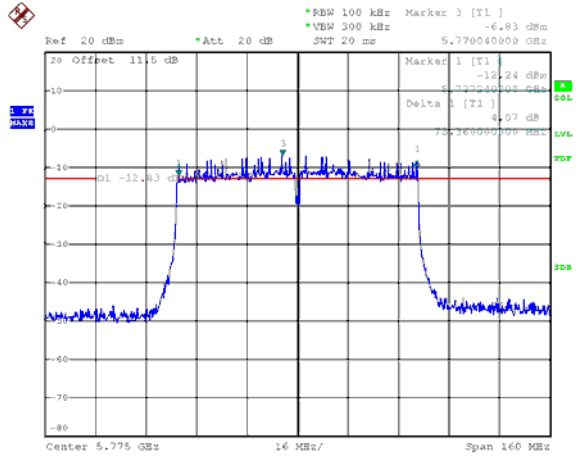

CH159

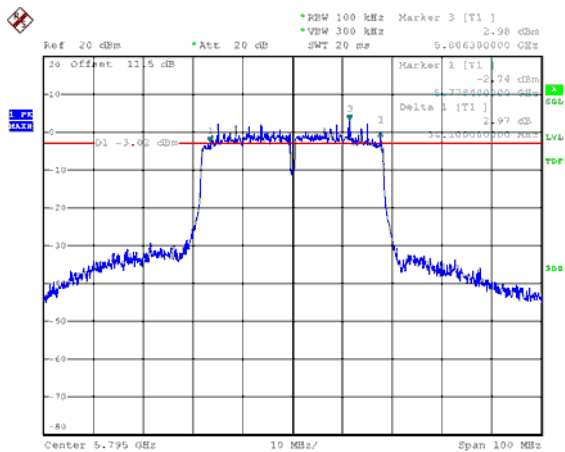



99% Occupied Bandwidth
ANT A
Modulation Type: 802.11a (6Mbps)
CH149

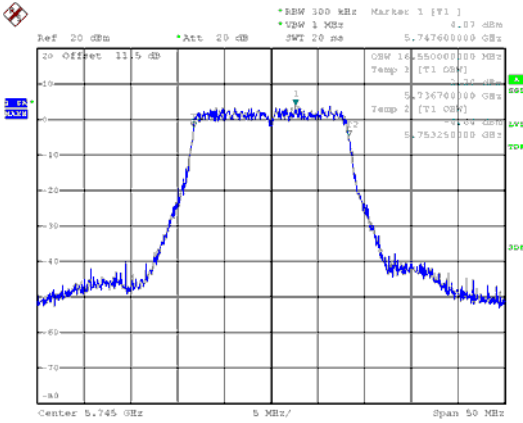

Modulation Type: 802.11ac, VHT20 (6.5Mbps)
CH149

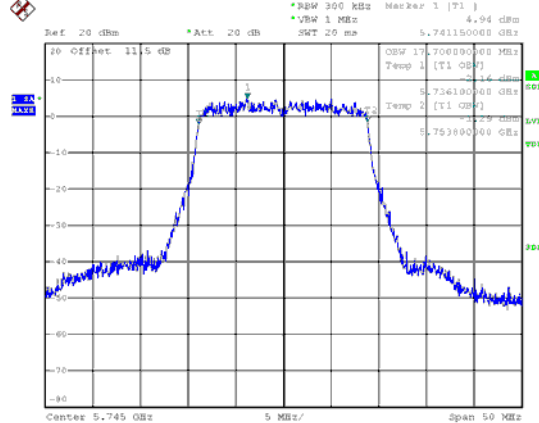

CH157

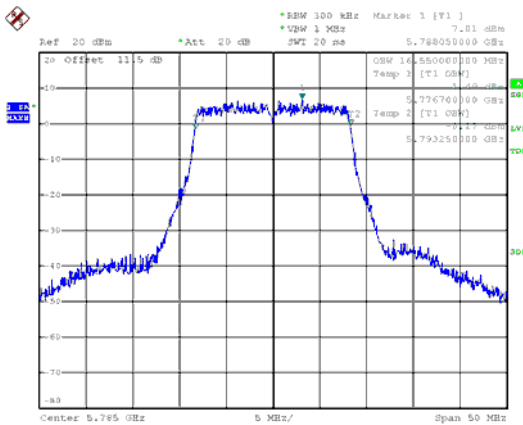

CH157

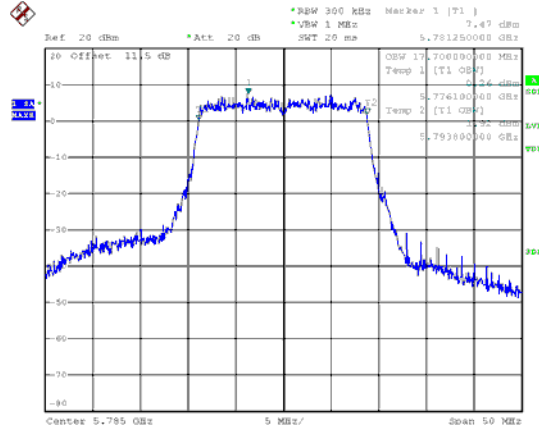

CH165

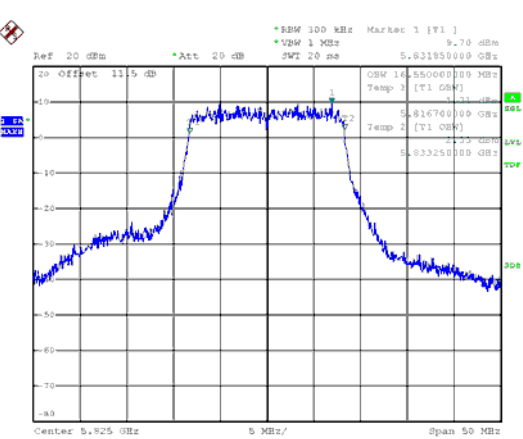

CH165

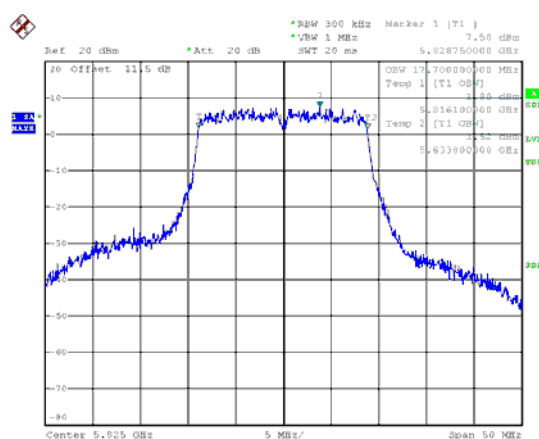



Modulation Type: 802.11ac, VHT40 (13.5Mbps)
CH151

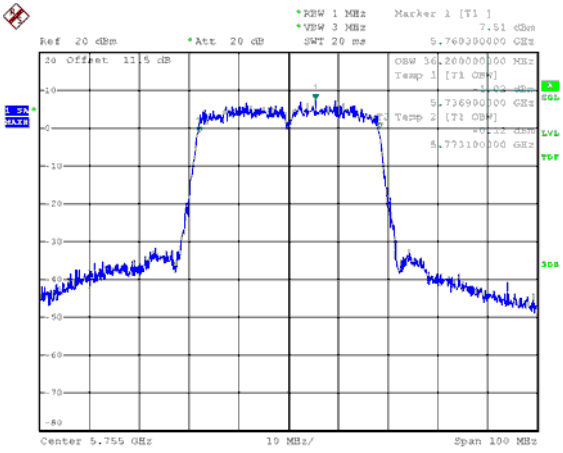

Modulation Type: 802.11ac, VHT80 (29.3Mbps)
CH155

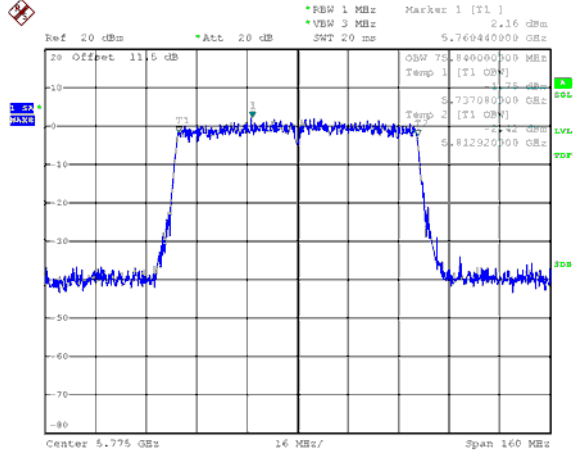

CH159

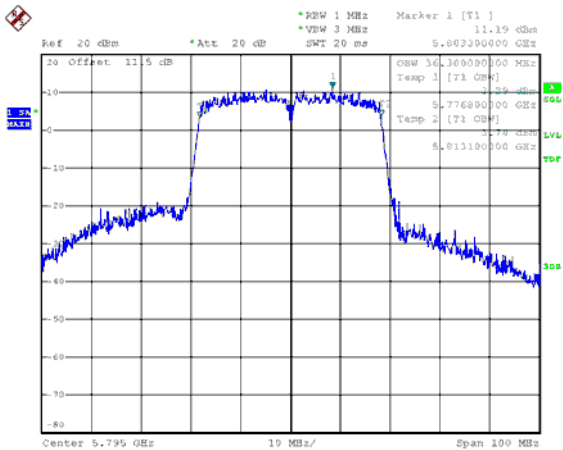



ANT B
Modulation Type: 802.11a (6Mbps)
CH149

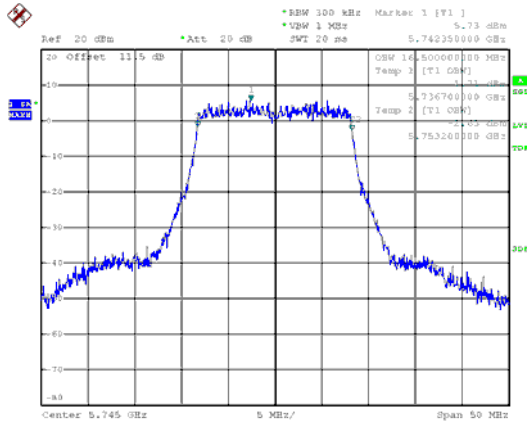

Modulation Type: 802.11ac, VHT20 (6.5Mbps)
CH149

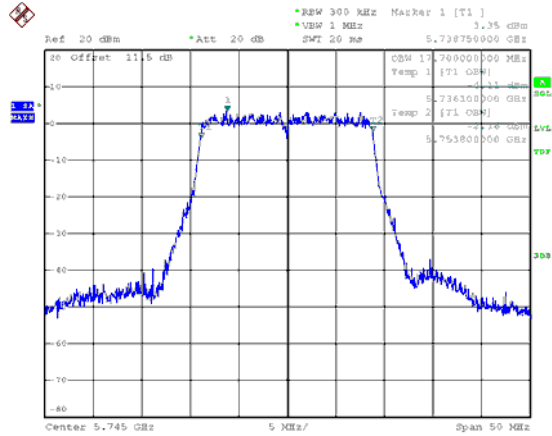

CH157

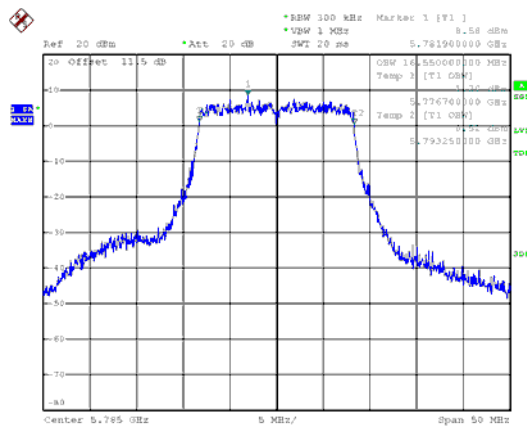

CH157

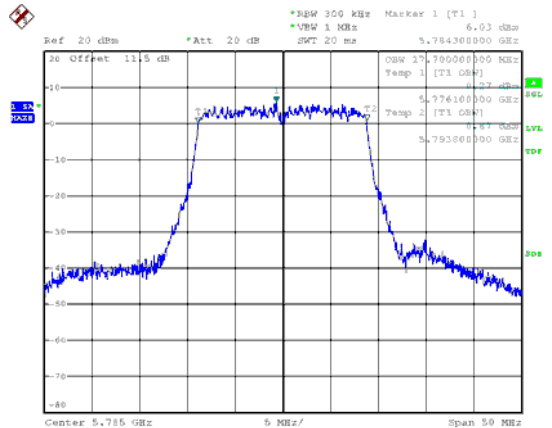

CH165

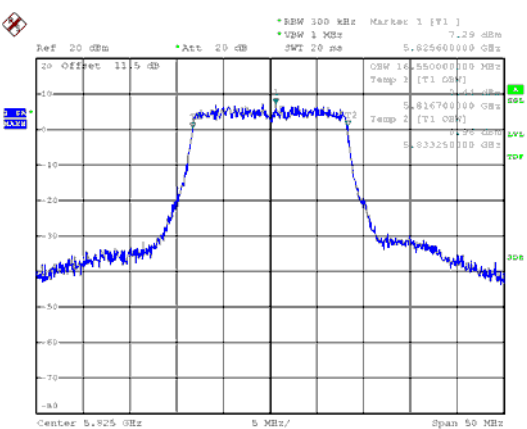

CH165

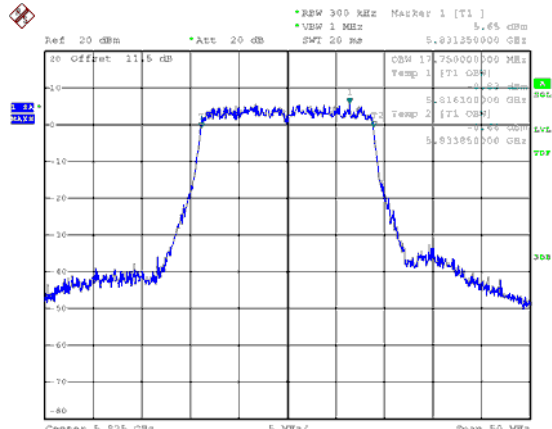



Modulation Type: 802.11ac, VHT40 (13.5Mbps)
CH151

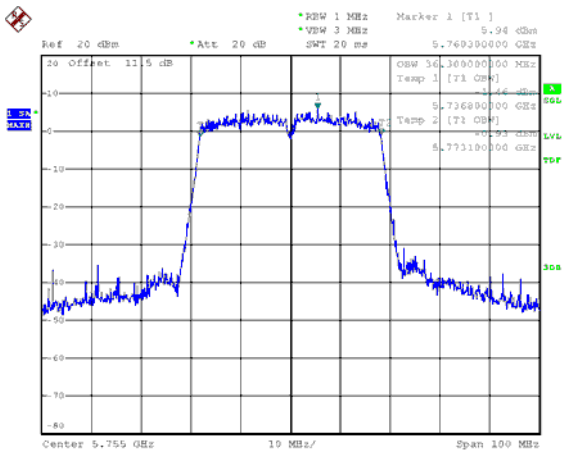

Modulation Type: 802.11ac, VHT80 (29.3Mbps)
CH155

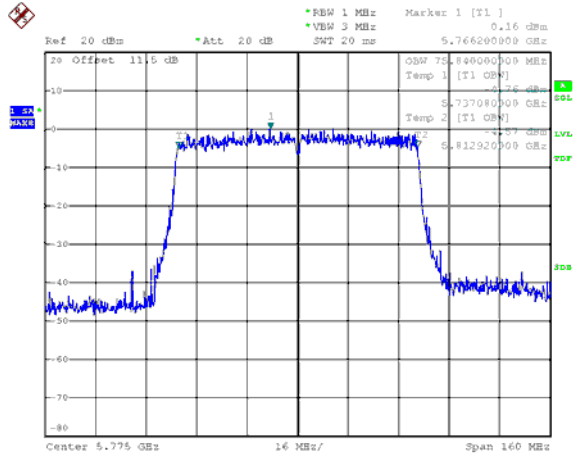

CH159

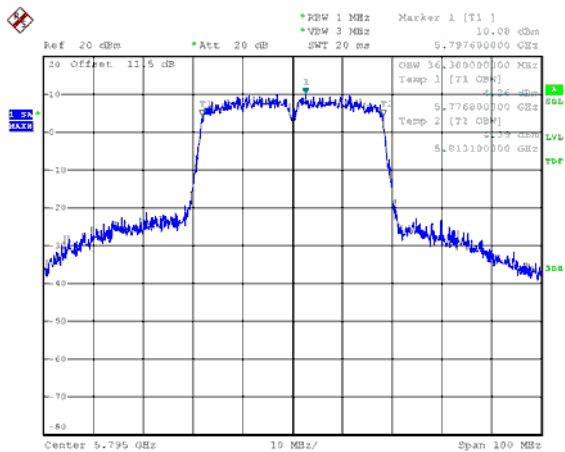



9. 26dB Bandwidth & 99% Occupied Bandwidth

9.1. Test Limit

None; for reporting purposes only.

9.2. Test Procedure

Reference to 789033 D02 General UNII Test Procedures New Rules v01: The transmitter output is connected to a spectrum analyzer with the RBW = approximately 1% of the emission bandwidth, the VBW >= 3 x RBW, peak detector and max hold.

9.3. Test Setup Layout

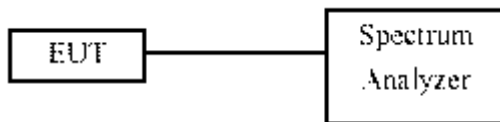

9.4. Test Result and Data (26dB Bandwidth)

In the 5.2G Band

Mode	Channel	Frequency (MHz)	26dB Bandwidth(MHz)	
			ANT A	ANT B
11a	36	5180	20.00	19.80
11a	40	5200	20.00	19.90
11a	48	5240	19.80	19.35
11ac VHT20	36	5180	20.85	20.70
11ac VHT20	40	5200	20.75	20.45
11ac VHT20	48	5240	20.70	20.45
11ac VHT40	38	5190	40.80	41.00
11ac VHT40	46	5230	41.00	40.80
11ac VHT80	42	5210	83.52	83.84



9.5. Test Result and Data (99% Occupied Bandwidth)

In the 5.2G Band

Modulation Type	Channel	Frequency (MHz)	99% Bandwidth(MHz)	
			ANT A	ANT B
11a	36	5180	16.50	16.50
11a	40	5200	16.55	16.55
11a	48	5240	16.50	16.50
11ac VHT20	36	5180	17.70	17.70
11ac VHT20	40	5200	17.70	17.70
11ac VHT20	48	5240	17.70	17.70
11ac VHT40	38	5190	36.20	36.30
11ac VHT40	46	5230	36.20	36.20
11ac VHT80	42	5210	75.84	75.84



26dB Bandwidth
ANT A
Modulation Type: 802.11a (6Mbps)
CH36

802.11ac VHT20 (6.5Mbps)
CH36

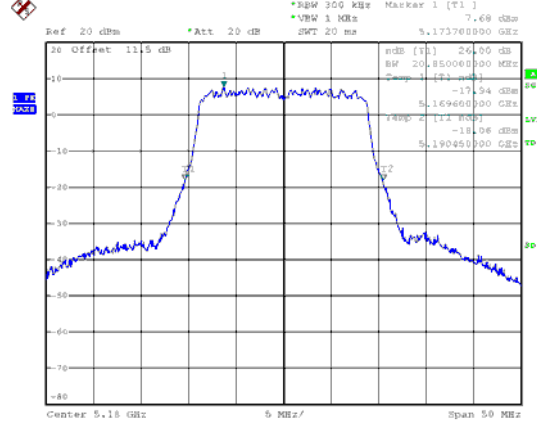
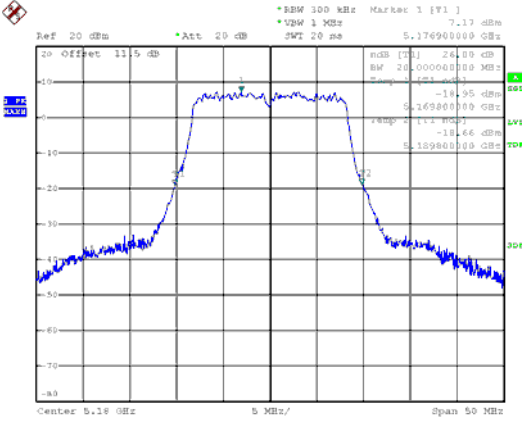

CH40

CH40

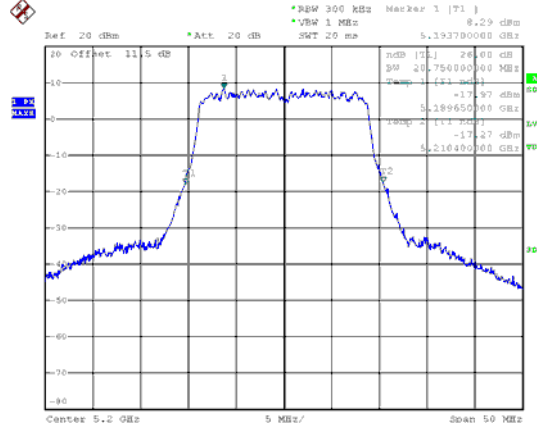
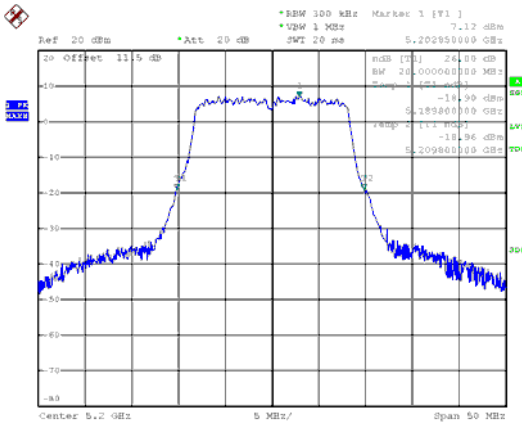

CH48

CH48

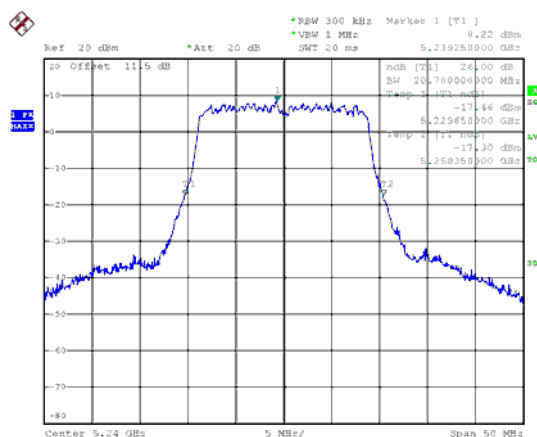
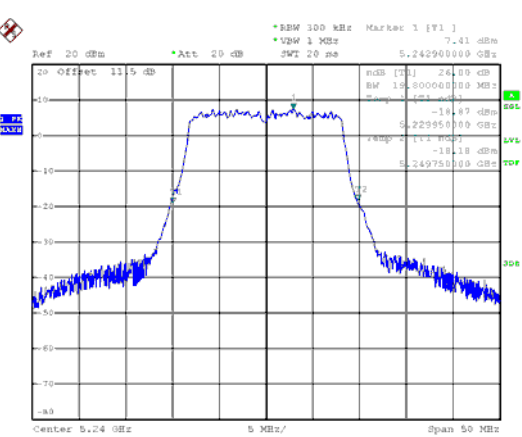



Modulation Type: 802.11ac VHT40 (13.5Mbps)
CH38

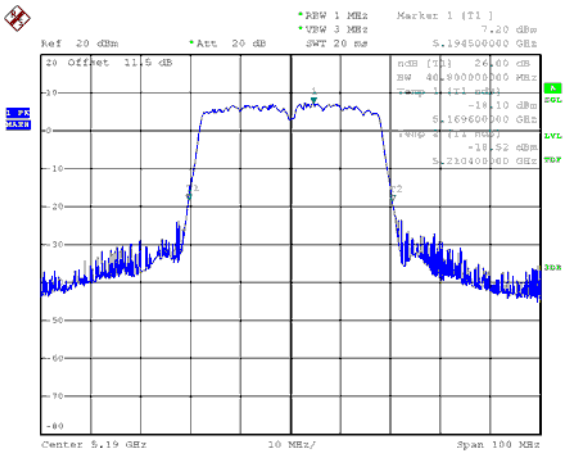

Modulation Type: 802.11ac VHT80 (29.3Mbps)
CH42

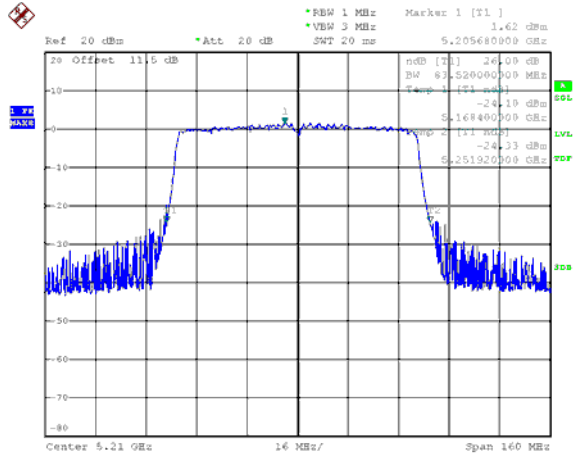

CH46

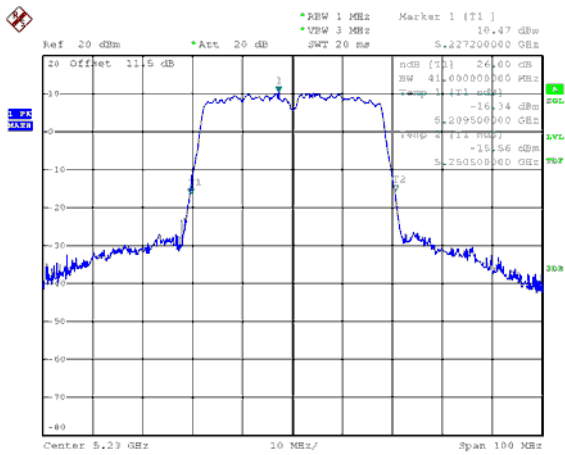



ANT B

Modulation Type: 802.11a (6Mbps)
CH36

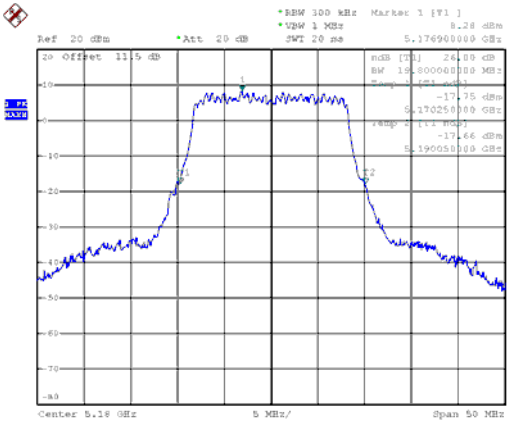

802.11ac VHT20 (6.5Mbps)
CH36

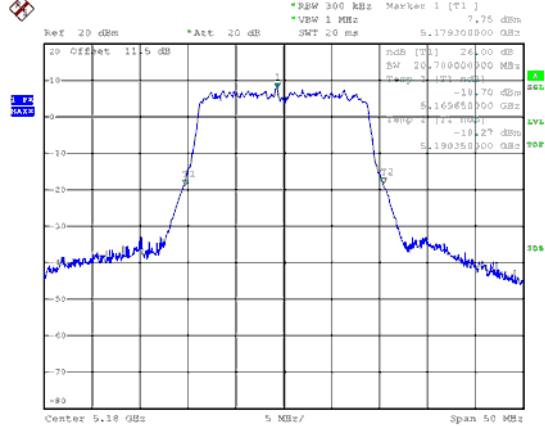

CH40

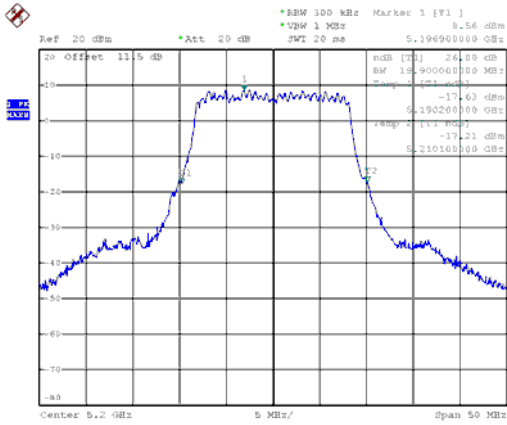

CH40

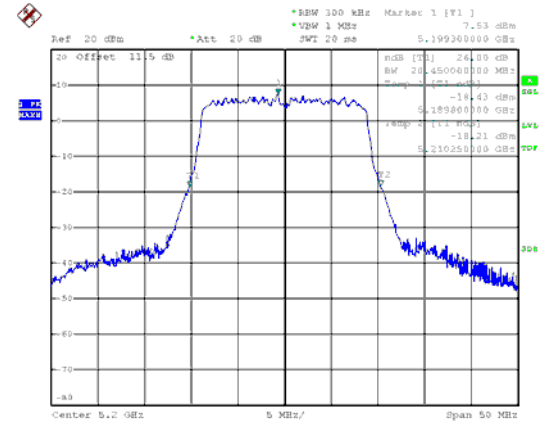

CH48

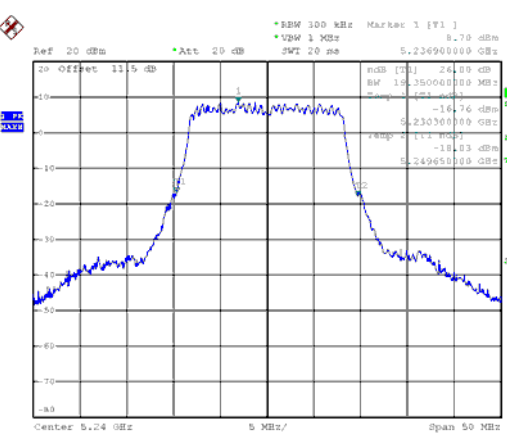

CH48

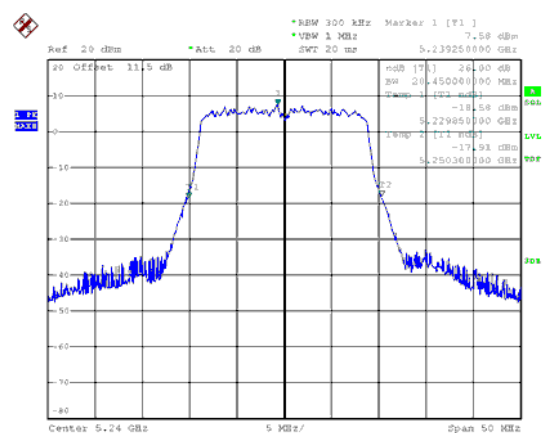



Modulation Type: 802.11ac VHT40 (13.5Mbps)
CH38

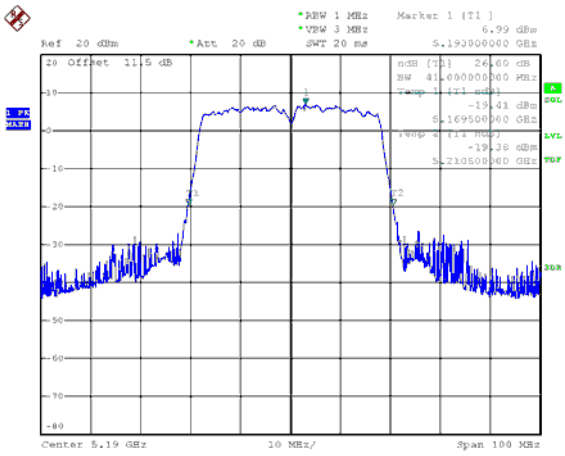

Modulation Type: 802.11ac VHT80 (29.3Mbps)
CH42

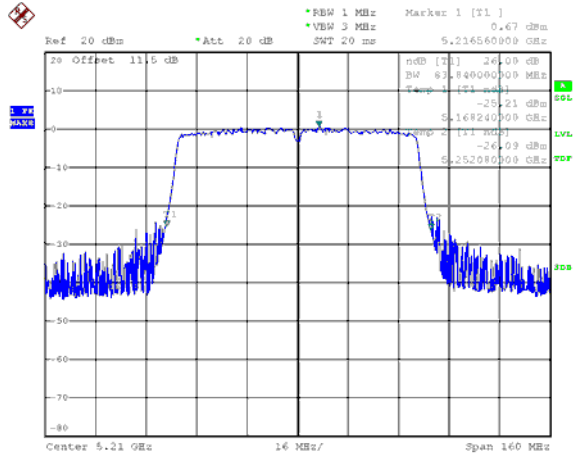

CH46

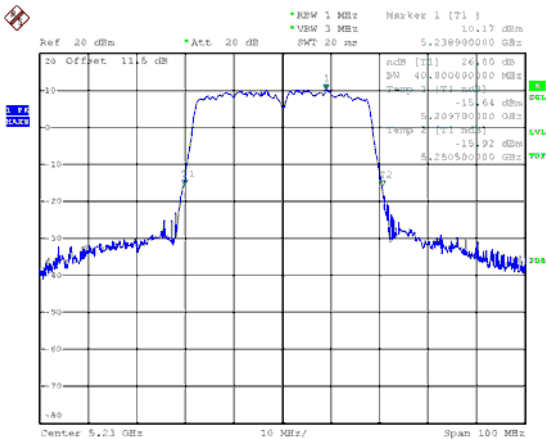



99% Occupied Bandwidth
ANT A
Modulation Type: 802.11a (6Mbps)
CH36

802.11ac VHT20 (6.5Mbps)
CH36

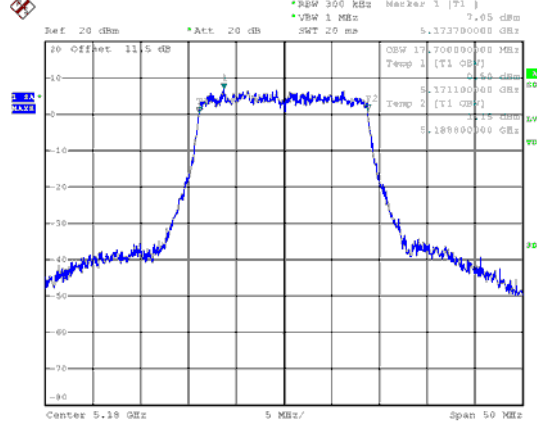
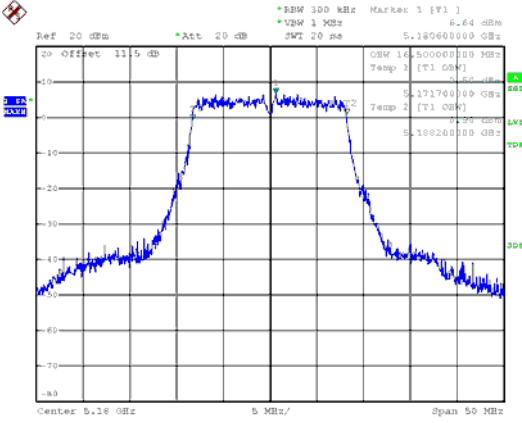

CH40

CH40

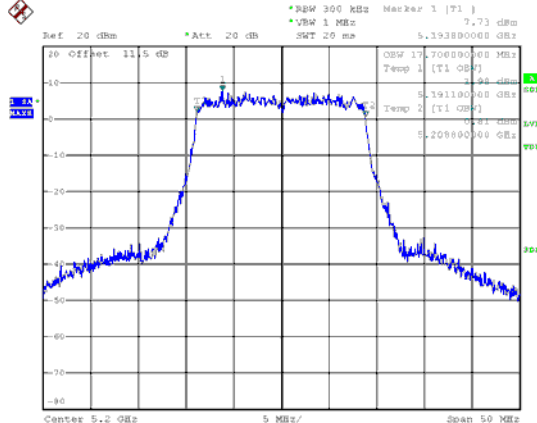
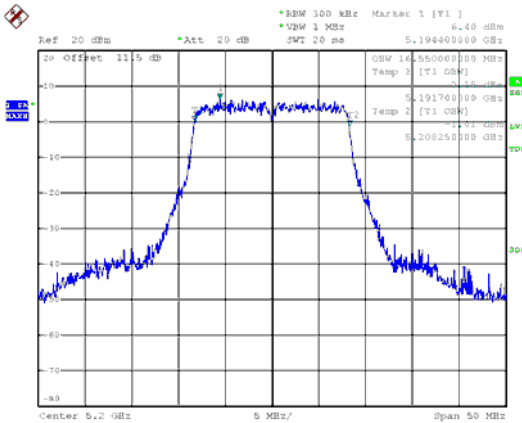

CH48

CH48

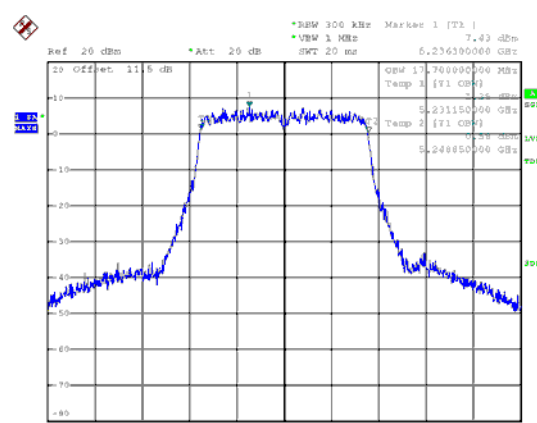
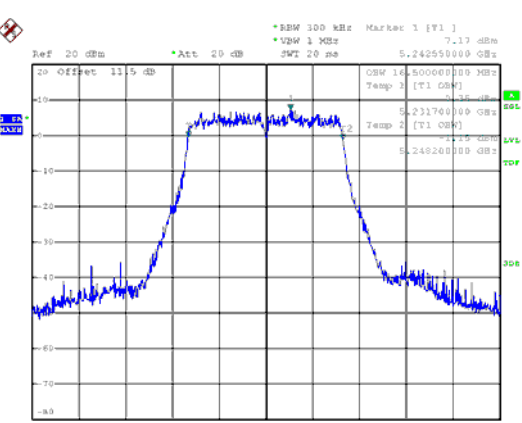



Modulation Type: 802.11ac VHT40 (13.5Mbps) CH38

Modulation Type: 802.11ac VHT80 (29.3Mbps) CH42

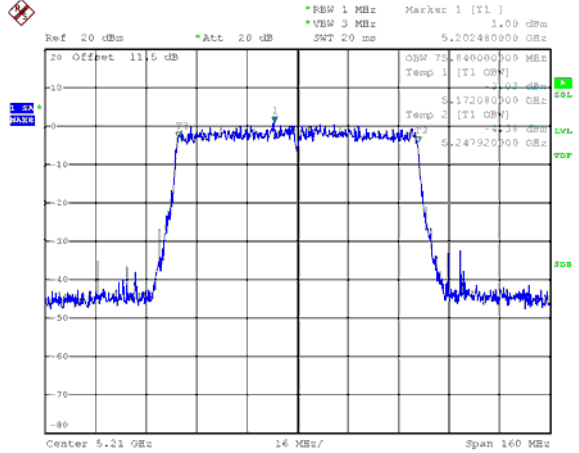
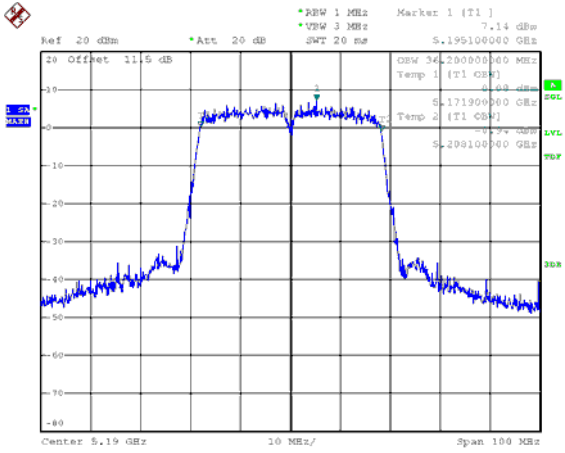

CH46

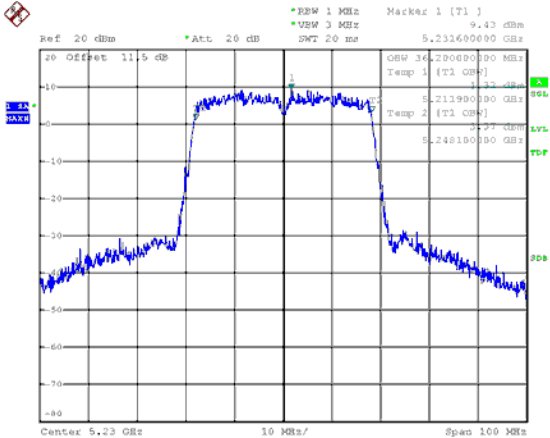



ANT B

Modulation Type: 802.11a (6Mbps)
CH36

802.11ac VHT20 (6.5Mbps)
CH36

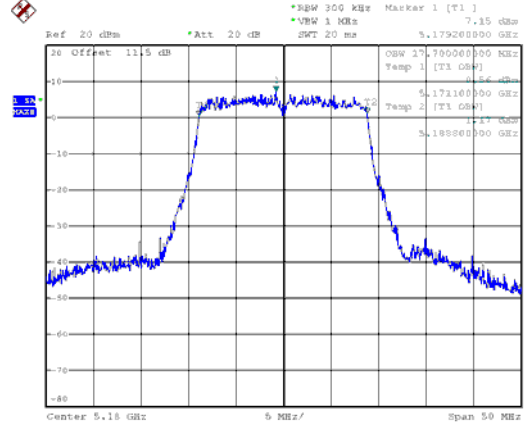
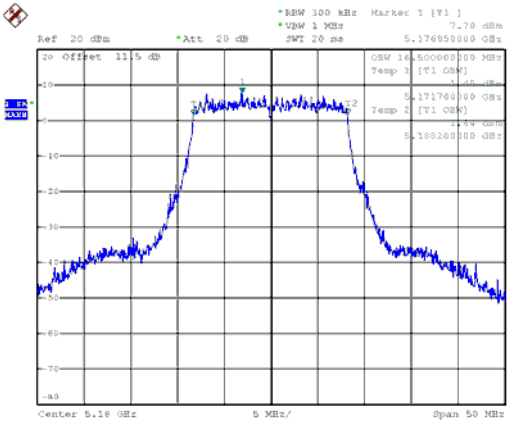

CH40

CH40

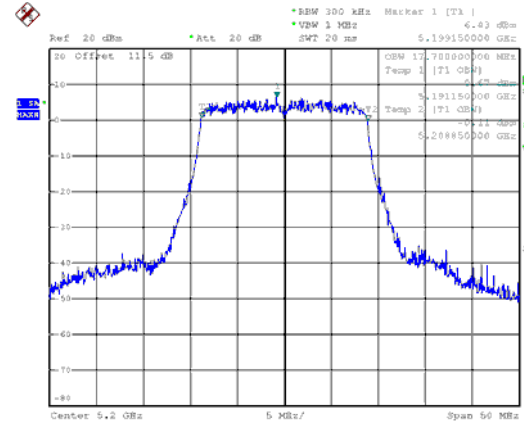
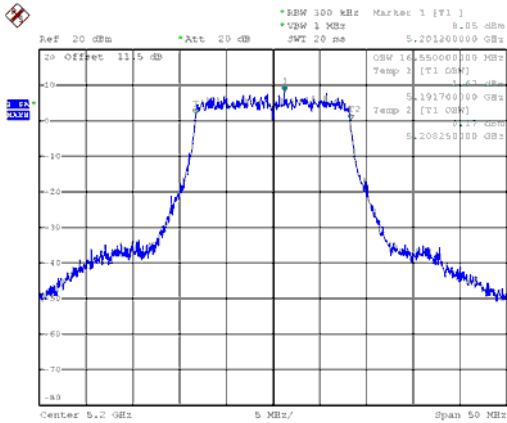

CH48

CH48

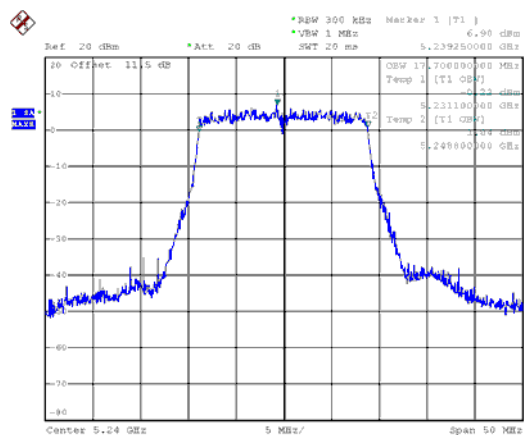
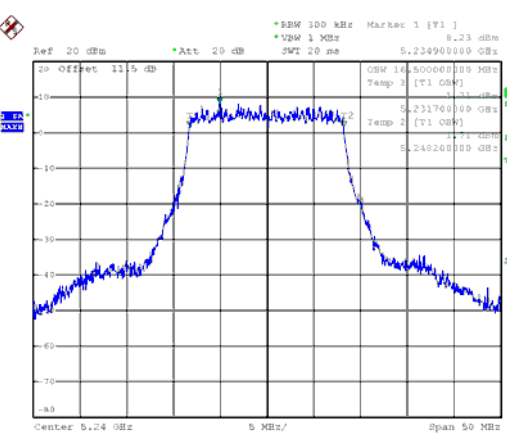



10. Average Power

10.1. Test Limit

Output Power:

Frequency Band	Limit
<input checked="" type="checkbox"/> 5.15~5.25GHz	
Operating Mode	
<input type="checkbox"/> Outdoor access point	The maximum conducted output power over the frequency band of operation shall not exceed 1 W (30dBm) provided the maximum antenna gain does not exceed 6 dBi. If transmitting antennas of directional gain greater than 6 dBi are used, both the maximum conducted output power and the maximum power spectral density shall be reduced by the amount in dB that the directional gain of the antenna exceeds 6 dBi. The maximum e.i.r.p. at any elevation angle above 30degrees as measured from the horizon must not exceed 125 mW (21 dBm).
<input checked="" type="checkbox"/> Indoor access point	The maximum conducted output power over the frequency band of operation shall not exceed 1 W (30dBm) provided the maximum antenna gain does not exceed 6 dBi. If transmitting antennas of directional gain greater than 6 dBi are used, both the maximum conducted output power and the maximum power spectral density shall be reduced by the amount in dB that the directional gain of the antenna exceeds 6 dBi.
<input type="checkbox"/> Fixed point-to-point access points	The maximum conducted output power over the frequency band of operation shall not exceed 1 W (30dBm). Fixed point-to-point U-NII devices may employ antennas with directional gain up to 23 dBi without any corresponding reduction in the maximum conducted output power or maximum power spectral density. For fixed point-to-point transmitters that employ a directional antenna gain greater than 23 dBi, a 1 dB reduction in maximum conducted output power and maximum power spectral density is required for each 1 dB of antenna gain in excess of 23 dBi.
<input type="checkbox"/> client devices	The maximum conducted output power over the frequency band of operation shall not exceed 250 mW (24dBm) provided the maximum antenna gain does not exceed 6 dBi. If transmitting antennas of directional gain greater than 6 dBi are used, both the maximum conducted output power and the maximum power spectral density shall be reduced by the amount in dB that the directional gain of the antenna exceeds 6 dBi.



Frequency Band		Limit
<input type="checkbox"/>	5.25-5.35 GHz	The maximum conducted output power over the frequency bands of operation shall not exceed the lesser of 250 mW (24dBm) or 11 dBm 10 log B, where B is the 26 dB emission bandwidth in megahertz. If transmitting antennas of directional gain greater than 6 dBi are used, both the maximum conducted output power and the maximum power spectral density shall be reduced by the amount in dB that the directional gain of the antenna exceeds 6 dBi.
<input type="checkbox"/>	5.470-5.725 GHz	
<input checked="" type="checkbox"/>	5.725~5.85 GHz	

10.2. Test Procedure

The transmitter output is connected to a power meter.
The cable assembly insertion loss of 11.5 dB (including 10 dB pad and 1.5 dB cable) was entered as an offset in the power meter to allow for direct reading of power.

10.3. Test Setup Layout

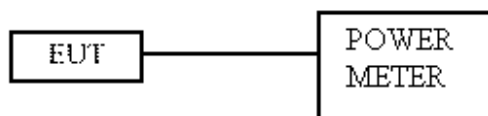

**10.4. Test Result and Data****In the 5.2G Band**

Modulation Type	Data Rate	Setting	Channel	Frequency (MHz)	Measured value of each antenna port (dBm)		Total power (dBm)	Total power (mW)	FCC Limit (dBm)
					ANT A	ANT B			
11a	6 Mbps	16	36	5180	16.01	16.51	19.28	84.674	30.00
11a	6 Mbps	16	40	5200	16.04	16.89	19.50	89.044	30.00
11a	6 Mbps	16	48	5240	15.99	16.78	19.41	87.362	30.00
11n HT20	MCS 0	16	36	5180	15.83	16.27	19.07	80.647	30.00
11n HT20	MCS 0	16	40	5200	15.91	16.68	19.32	85.553	30.00
11n HT20	MCS 0	16	48	5240	15.65	16.59	19.16	82.332	30.00
11n HT40	MCS 0	13	38	5190	13.44	13.86	16.67	46.402	30.00
11n HT40	MCS 0	16	46	5230	15.63	16.53	19.11	81.537	30.00
11ac VHT20	NSS1-MCS0	16	36	5180	15.88	16.33	19.12	81.679	30.00
11ac VHT20	NSS1-MCS0	16	40	5200	15.96	16.71	19.36	86.327	30.00
11ac VHT20	NSS1-MCS0	16	48	5240	15.68	16.63	19.19	83.008	30.00
11ac VHT40	NSS1-MCS0	13	38	5190	13.51	13.92	16.73	47.099	30.00
11ac VHT40	NSS1-MCS0	16	46	5230	15.69	16.61	19.18	82.882	30.00
11ac VHT80	NSS1-MCS0	11	42	5210	11.25	11.67	14.48	28.024	30.00



In the 5.8G Band

Modulation Type	Data Rate	Setting	Channel	Frequency (MHz)	Measured value of each antenna port (dBm)		Total power (dBm)	Total power (mW)	FCC Limit (dBm)
					ANT A	ANT B			
11a	6 Mbps	13	149	5745	13.51	14.65	17.13	51.613	30.00
11a	6 Mbps	15.5	157	5785	15.59	16.71	19.20	83.106	30.00
11a	6 Mbps	15.5	165	5825	15.41	17.24	19.43	87.720	30.00
11n HT20	MCS 0	13	149	5745	13.37	14.45	16.95	49.588	30.00
11n HT20	MCS 0	15.5	157	5785	15.41	16.51	19.01	79.525	30.00
11n HT20	MCS 0	15.5	165	5825	15.25	17.04	19.25	84.079	30.00
11n HT40	MCS 0	13	151	5755	12.92	14.08	16.55	45.174	30.00
11n HT40	MCS 0	16.5	159	5795	16.27	17.81	20.12	102.759	30.00
11ac VHT20	NSS1-MCS0	13	149	5745	13.42	14.51	17.01	50.227	30.00
11ac VHT20	NSS1-MCS0	15.5	157	5785	15.46	16.54	19.04	80.238	30.00
11ac VHT20	NSS1-MCS0	15.5	165	5825	15.28	17.08	19.28	84.779	30.00
11ac VHT40	NSS1-MCS0	13	151	5755	12.99	14.14	16.61	45.849	30.00
11ac VHT40	NSS1-MCS0	16.5	159	5795	16.33	17.89	20.19	104.471	30.00
11ac VHT80	NSS1-MCS0	11	155	5775	11.18	12.42	14.85	30.580	30.00



11. Power Spectral Density

11.1. Test Limit

PSD:

Frequency Band		Limit
<input checked="" type="checkbox"/>	5.15~5.25GHz	
	Operating Mode	
<input type="checkbox"/>	Outdoor access point	17 dBm/MHz
<input checked="" type="checkbox"/>	Indoor access point	17 dBm/MHz
<input type="checkbox"/>	Fixed point-to-point access points	17 dBm/MHz
<input type="checkbox"/>	Mobile and portable client devices	11 dBm/MHz
<input type="checkbox"/>	5.725~5.85 GHz	11 dBm/MHz
<input type="checkbox"/>	5.470-5.725 GHz	11 dBm/MHz
<input checked="" type="checkbox"/>	5.725~5.85 GHz	30 dBm/500kHz

11.2. Test Procedure

Reference to KDB789033 D02 General UNII Test Procedures New Rules v02r01

11.3. Test Setup Layout

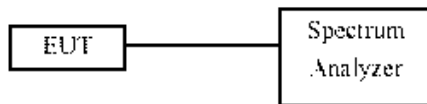

**11.4. Test Result and Data****In the 5.2G Band**

Modulation Type	Channel	Frequency (MHz)	Meas PSD (dBm/MHz)		Sum chain (dBm)	Duty Cycle CF(dB)	Total Corr'd PSD (dBm/MHz)	PSD Limit (dBm/MHz)
			ANT A	ANT B				
11a	36	5180	3.50	3.73	6.63	0.11	6.74	15.39
11a	40	5200	3.54	4.29	6.94	0.11	7.05	15.39
11a	48	5240	3.71	4.17	6.96	0.11	7.07	15.39
11ac VHT20	36	5180	3.88	3.82	6.86	0.00	6.86	15.39
11ac VHT20	40	5200	4.36	3.42	6.93	0.00	6.93	15.39
11ac VHT20	48	5240	4.26	3.41	6.87	0.00	6.87	15.39
11ac VHT40	38	5190	-2.08	-2.40	0.77	0.11	0.88	15.39
11ac VHT40	46	5230	0.74	0.88	3.82	0.11	3.93	15.39
11ac VHT80	42	5210	-7.79	-8.59	-5.16	0.22	-4.94	15.39

In the 5.8G Band

Modulation Type	Channel (MHz)	Frequency (MHz)	Meas PSD (dBm/MHz)		Sum chain (dBm)	Duty Cycle CF(dB)	10log(500KHz/RBW) CF (dB)	Total Corr'd PSD (dBm/500kHz)	PSD Limit (dBm/500kHz)
			ANT A	ANT B					
11a	149	5745	0.97	1.99	4.52	0.11	-3.01	1.62	28.39
11a	157	5785	3.68	4.29	7.01	0.11	-3.01	4.11	28.39
11a	165	5825	5.89	4.10	8.10	0.11	-3.01	5.20	28.39
11ac VHT20	149	5745	2.54	1.34	4.99	0.00	-3.01	1.98	28.39
11ac VHT20	157	5785	4.03	3.15	6.62	0.00	-3.01	3.61	28.39
11ac VHT20	165	5825	4.50	2.96	6.81	0.00	-3.01	3.80	28.39
11ac VHT40	151	5755	-1.61	-3.00	0.76	0.11	-3.01	-2.14	28.39
11ac VHT40	159	5795	2.51	1.83	5.19	0.11	-3.01	2.29	28.39
11ac VHT80	155	5775	-6.31	-8.19	-4.14	0.22	-3.01	-6.93	28.39



5.2G Band 1, ANT A
Modulation Type: 802.11a (6Mbps)
CH36

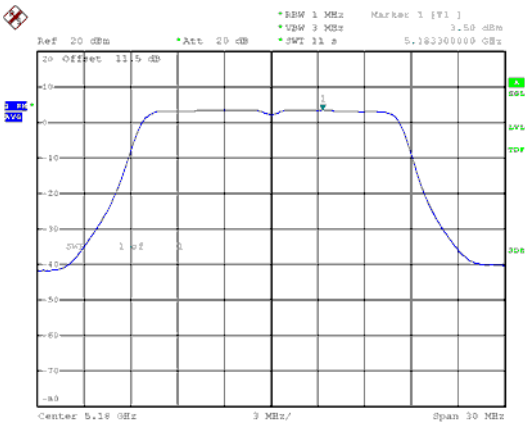

Modulation Type: 802.11ac VHT20 (6.5Mbps)
CH36

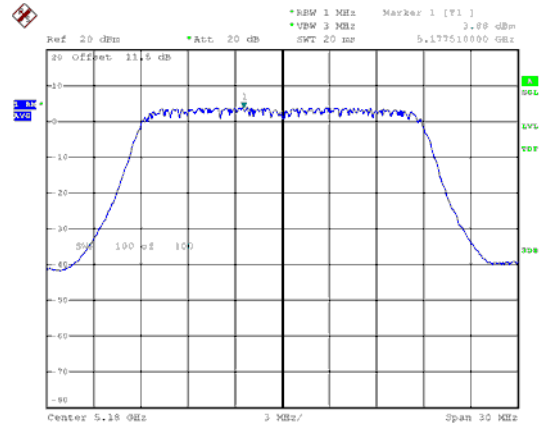

CH40

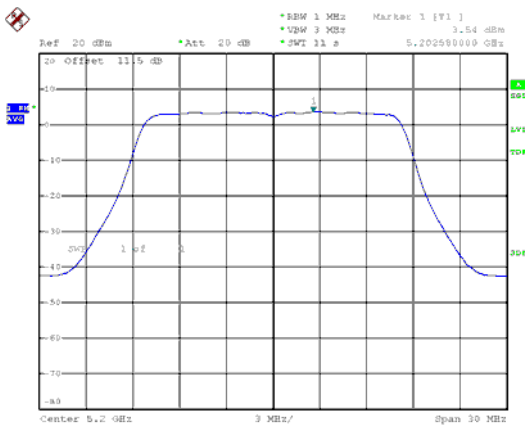

CH40

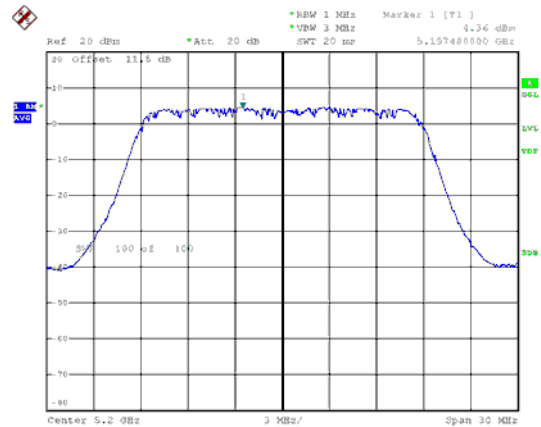

CH48

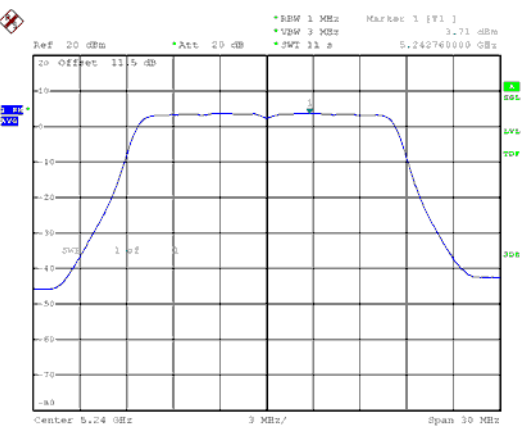

CH48

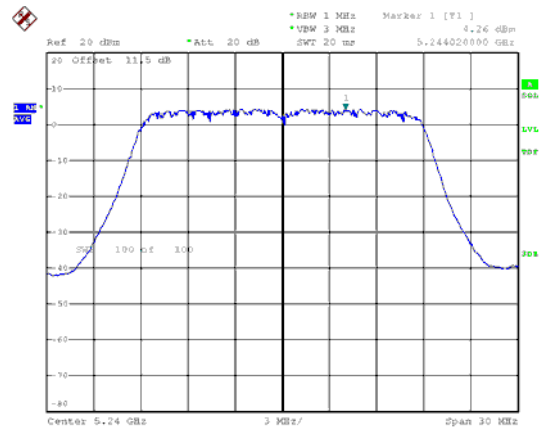



Modulation Type: 802.11ac VHT40 (13.5Mbps)
CH38

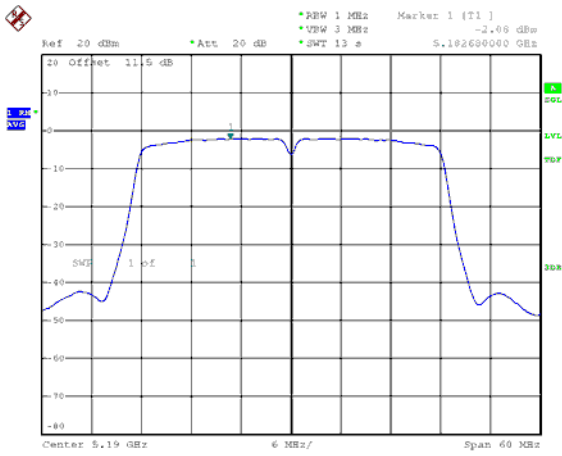

Modulation Type: 802.11ac VHT80 (29.3Mbps)
CH42

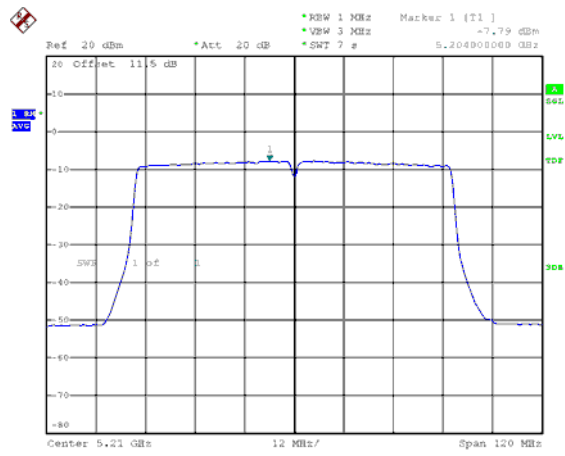

CH46

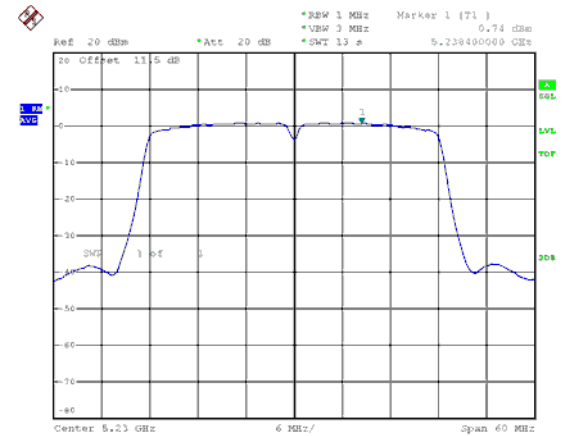



5.2G Band 1, ANT B
Modulation Type: 802.11a (6Mbps)
CH36

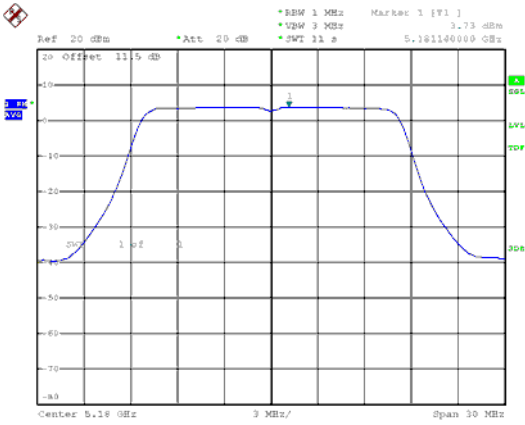

Modulation Type: 802.11ac VHT20 (6.5Mbps)
CH36

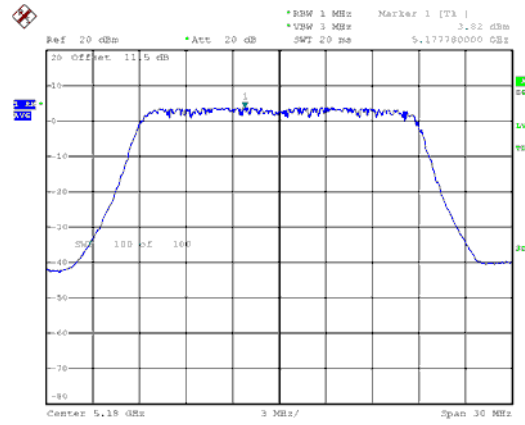

CH40

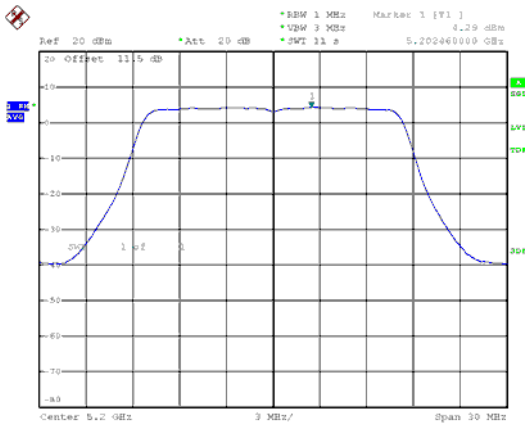

CH40

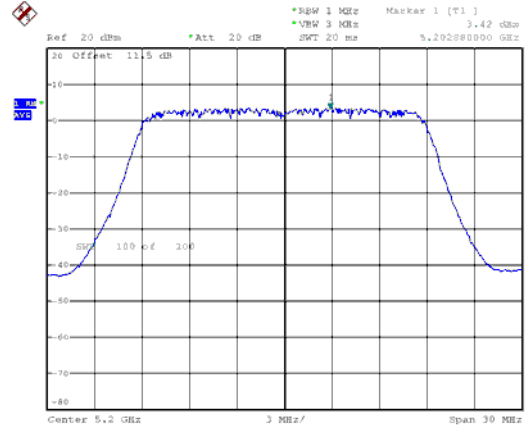

CH48

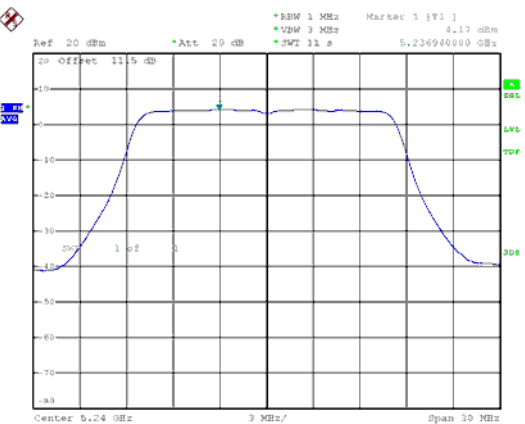

CH48

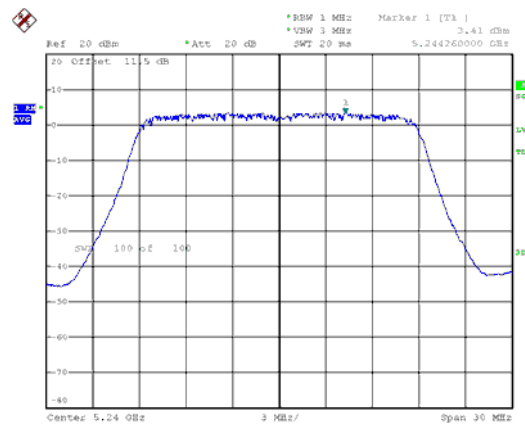



Modulation Type: 802.11ac VHT40 (13.5Mbps)
CH38

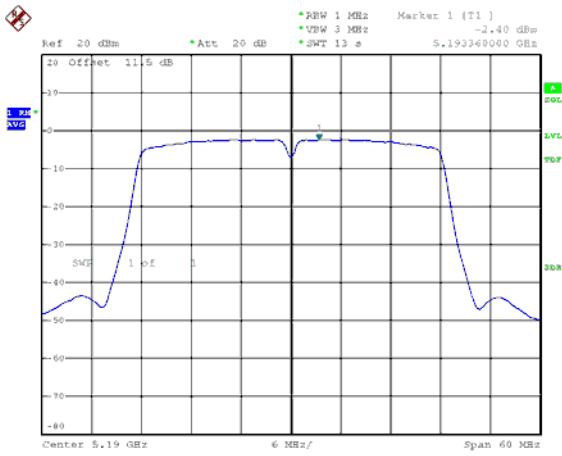

Modulation Type: 802.11ac VHT80 (29.3Mbps)
CH42

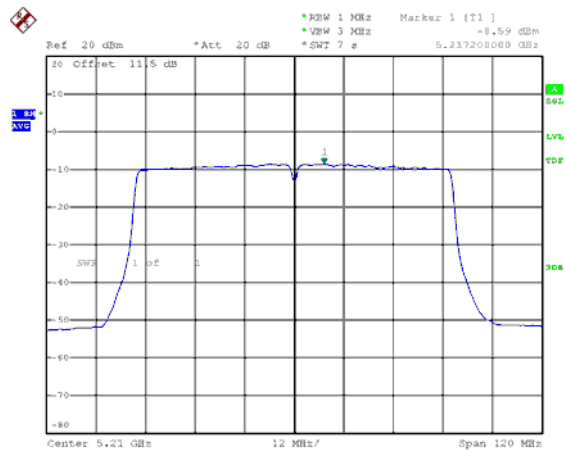

CH46

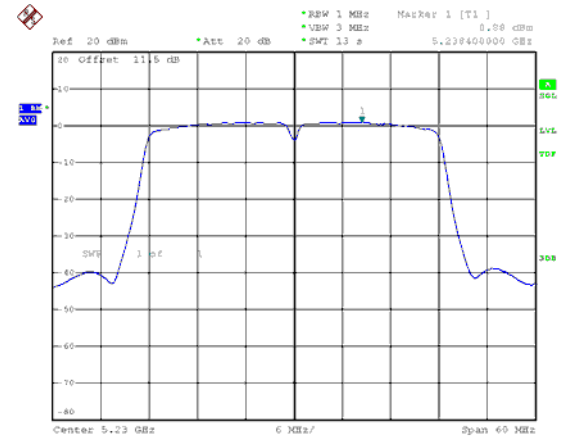



5.8G Band 4, ANT A
Modulation Type: 802.11a (6Mbps)
CH149

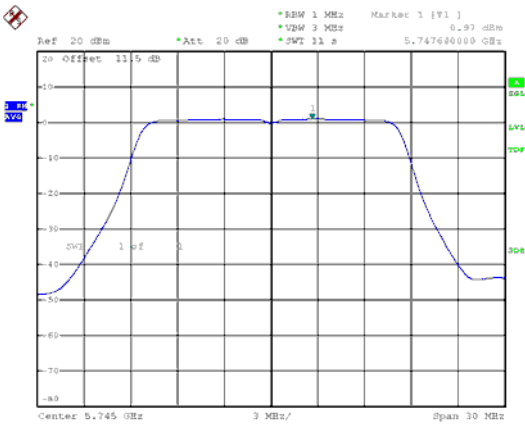

Modulation Type: 802.11ac VHT20 (6.5Mbps)
CH149

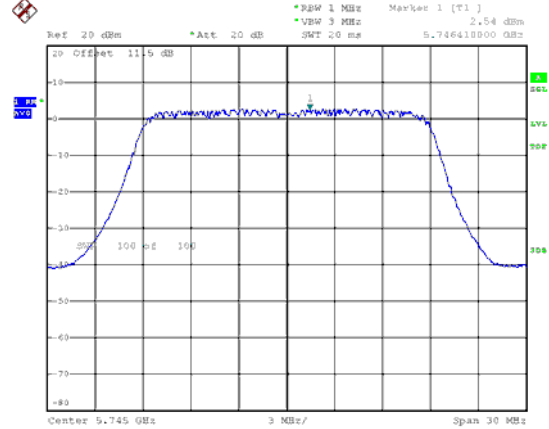

CH157

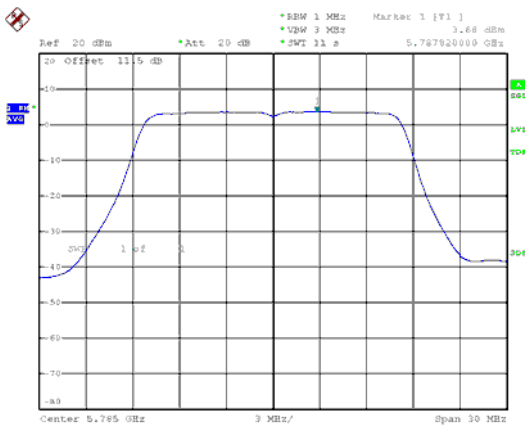

CH157

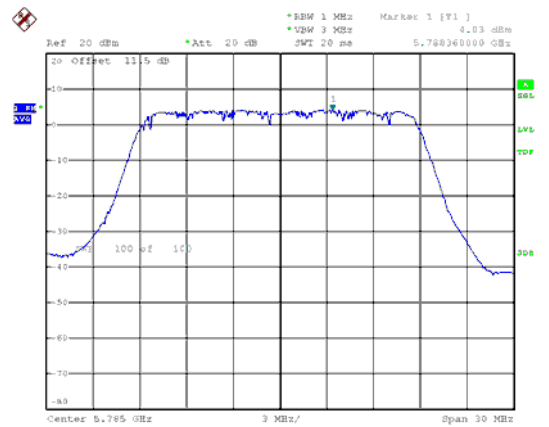

CH165

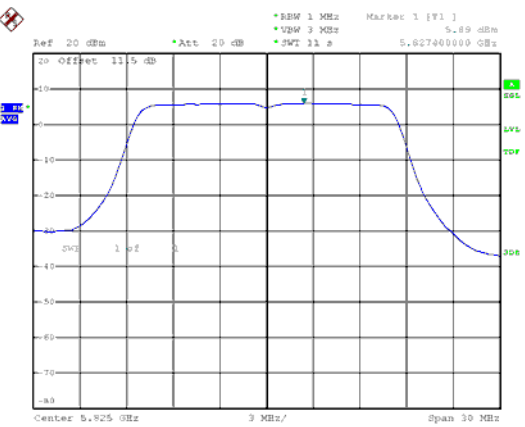

CH165

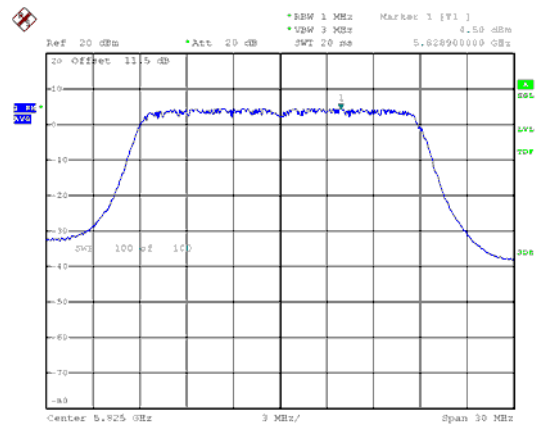



Modulation Type: 802.11ac VHT40 (13.5Mbps)
CH151

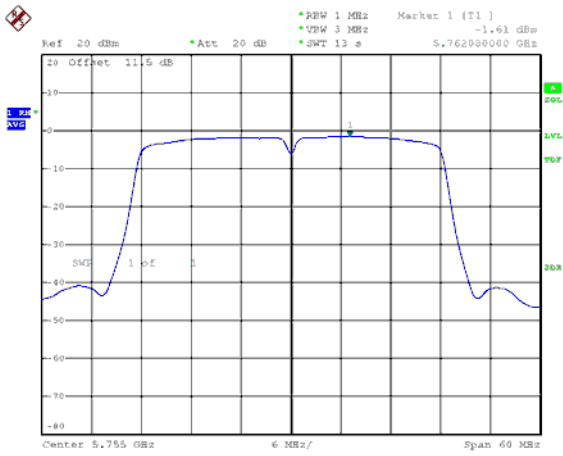

Modulation Type: 802.11ac VHT80 (29.3Mbps)
CH155

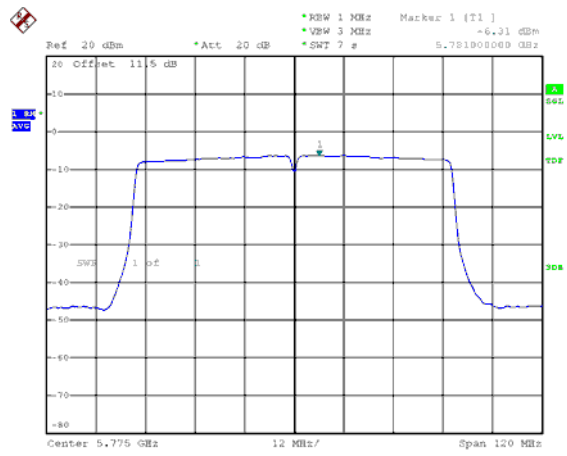

CH159

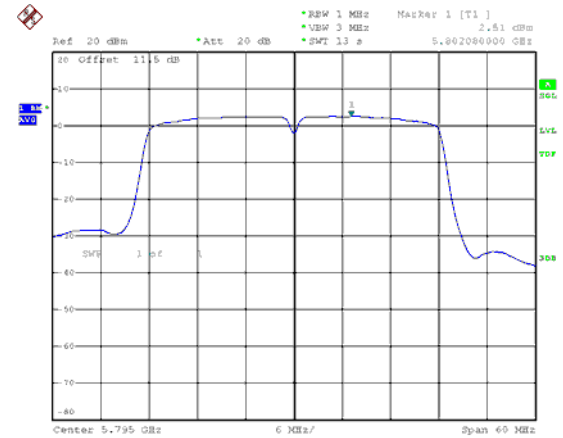



5.8G Band 4, ANT B
Modulation Type: 802.11a (6Mbps)
CH149

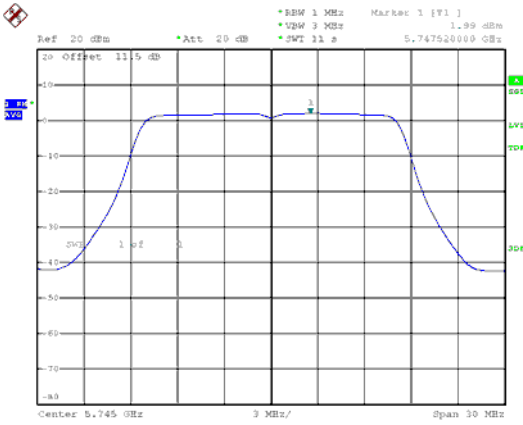

Modulation Type: 802.11ac VHT20 (6.5Mbps)
CH149

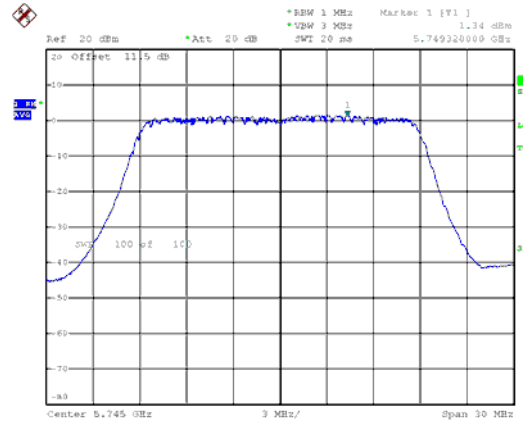

CH157

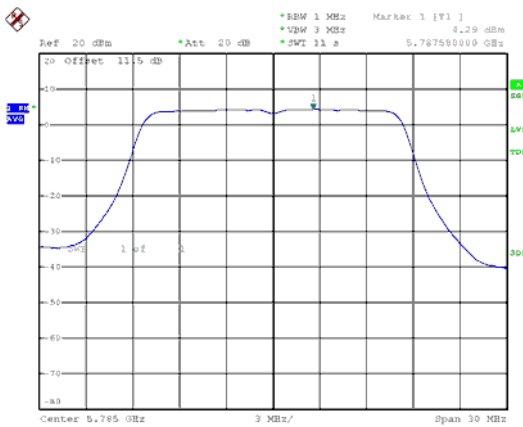

CH157

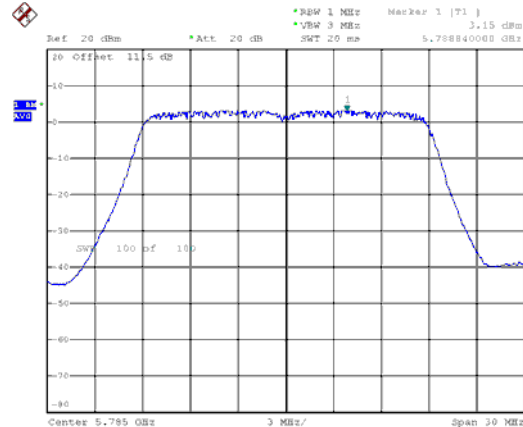

CH165

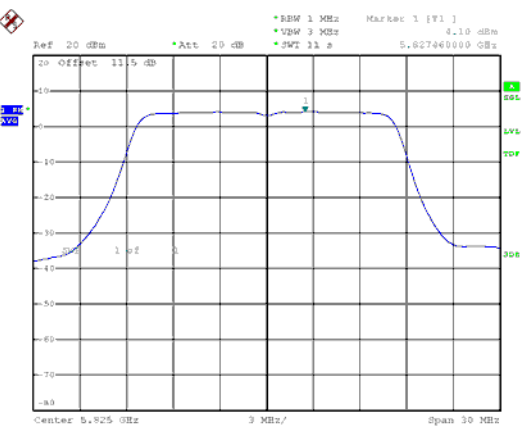

CH165

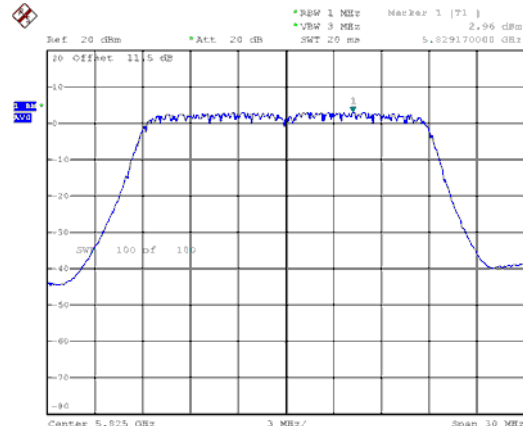



Modulation Type: 802.11ac VHT40 (13.5Mbps)
CH151

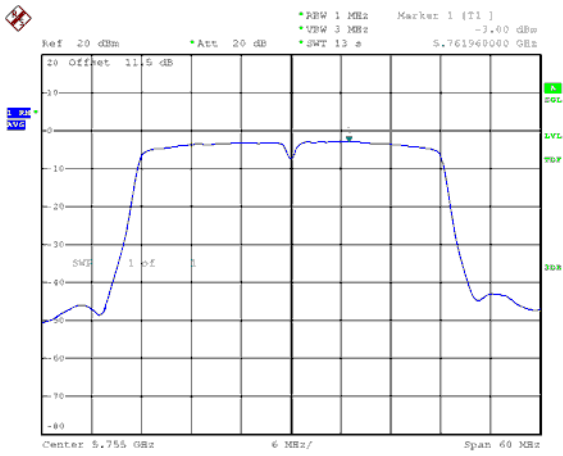

Modulation Type: 802.11ac VHT80 (29.3Mbps)
CH155

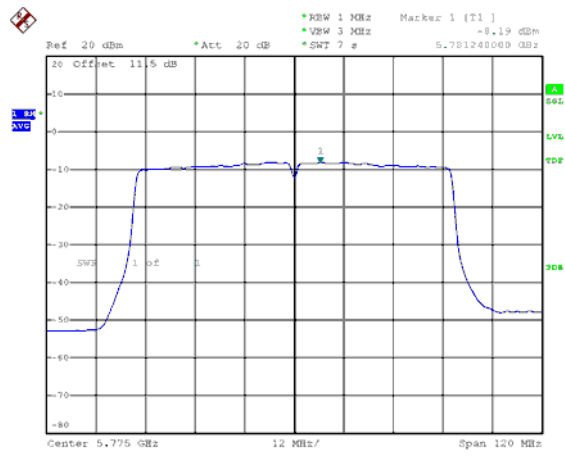

CH159

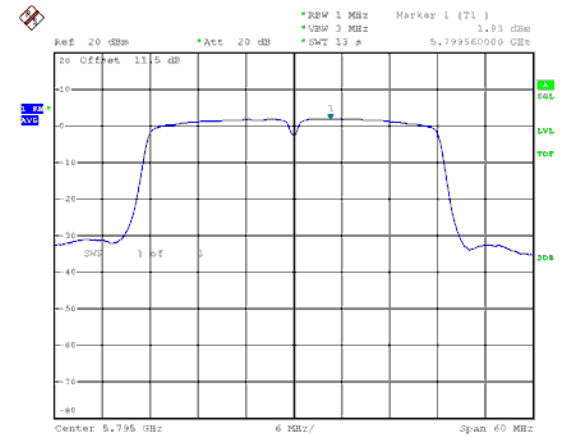



12. Frequency Stability

12.1. Test Procedure

1. The EUT was placed inside the Temperature and Humidity chamber.
2. The transmitter output was connected to spectrum analyzer.
3. Turn the EUT on and couple its output to a spectrum analyzer.
4. Turn the EUT off and set the chamber to the highest temperature specified.
5. Allow sufficient time (approximately 30 min) for the temperature of the chamber to stabilize, turn the EUT on and measure the operating frequency after 2, 5, and 10 minutes.
6. Repeat step 2 and 3 with the temperature chamber set to the lowest temperature.
7. The test chamber was allowed to stabilize at +20 degree C for a minimum of 30 minutes. The supply voltage was then adjusted on the EUT from 85% to 115% and the frequency record.

12.2. Test Setup Layout

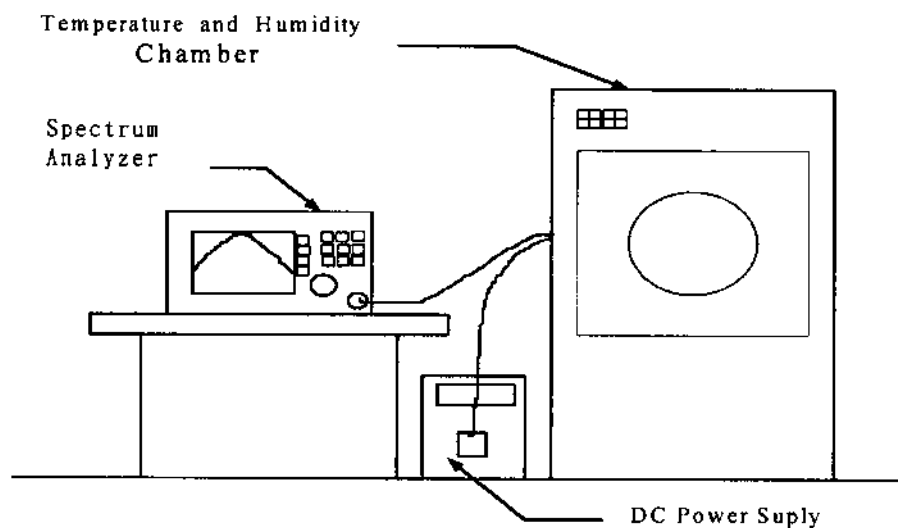

**12.3. Test Result and Data**

Operating frequency: 5180 MHz							
Temp (°C)	Power supply (V)	2 minute		5 minute		10 minute	
		(MHz)	(%)	(MHz)	(%)	(MHz)	(%)
45	102	5179.9967	-0.000064	5179.9933	-0.000129	5180.0012	0.000023
	120	5179.9984	-0.000031	5179.9916	-0.000162	5180.0002	0.000004
	138	5179.9963	-0.000071	5179.9941	-0.000114	5180.0010	0.000019
40	102	5180.0153	0.000295	5180.0124	0.000239	5180.0159	0.000307
	120	5180.0100	0.000193	5180.0112	0.000216	5180.0149	0.000288
	138	5180.0117	0.000226	5180.0126	0.000243	5180.0130	0.000251
30	102	5180.0105	0.000203	5180.0161	0.000311	5180.0126	0.000243
	120	5180.0100	0.000193	5180.0159	0.000307	5180.0146	0.000282
	138	5180.0131	0.000253	5180.0124	0.000239	5180.0143	0.000276
20	102	5179.9985	-0.000029	5179.9959	-0.000079	5179.9944	-0.000108
	120	5179.9998	-0.000004	5179.9946	-0.000104	5179.9924	-0.000147
	138	5179.9968	-0.000062	5179.9943	-0.000110	5179.9952	-0.000093
10	102	5180.0225	0.000434	5180.0232	0.000448	5180.0214	0.000413
	120	5180.0251	0.000485	5180.0205	0.000396	5180.0245	0.000473
	138	5180.0236	0.000456	5180.0240	0.000463	5180.0257	0.000496
0	102	5180.0319	0.000616	5180.0347	0.000670	5180.0311	0.000600
	120	5180.0309	0.000597	5180.0325	0.000627	5180.0306	0.000591
	138	5180.0305	0.000589	5180.0312	0.000602	5180.0345	0.000666

Limit: Manufacturers of U-NII devices are responsible for ensuring frequency stability such that an emission is maintained within the band of operation under all conditions of normal operation as specified in the users manual.