



FCC RADIO TEST REPORT

Applicant : Frontiir Pte (with Frontiir Co LTD, Myanmar)
Address : 809 Yakima Drive, Fremont, California 94539,
United States
Equipment : 802.11ac 2x2 dual-band AP
Model No. : LCA-F
Trade Name : FRONTiIR
FCC ID. : 2AQLFLCF

I HEREBY CERTIFY THAT :

The sample was received on Feb. 13, 2020 and the testing was completed on Mar. 19, 2020 at CerpPASS Technology Corp. The test result refers exclusively to the test presented test model / sample. Without written approval of CerpPASS Technology Corp., the test report shall not be reproduced except in full.

Approved by:

Laboratory Accreditation:

CerpPASS Technology Corporation Test Laboratory





Contents

- 1. **Summary of Test Procedure and Test Results**..... 5
 - 1.1 Applicable Standards 5
- 2. **Test Configuration of Equipment under Test**..... 6
 - 2.1 Feature of Equipment..... 6
 - 2.2 Carrier Frequency of Channels 7
 - 2.3 Test Mode and Test Software 8
 - 2.4 Description of Test System..... 9
 - 2.5 General Information of Test..... 10
 - 2.6 Measurement Uncertainty 10
- 3. **Test Equipment and Ancillaries Used for Tests** 11
- 4. **Antenna Requirements**..... 13
 - 4.1 Antenna Construction and Directional Gain 13
- 5. **Test of AC Power Line Conducted Emission** 14
 - 5.1 Test Limit 14
 - 5.2 Test Procedures 14
 - 5.3 Typical Test Setup 15
 - 5.4 Test Result and Data 16
 - 5.5 Test Photographs 20
- 6. **Test of Radiated Spurious Emission**..... 22
 - 6.1 Test Limit 22
 - 6.2 Test Procedures 22
 - 6.3 Typical Test Setup 23
 - 6.4 Test Result and Data (9KHz ~ 30MHz) 24
 - 6.5 Test Result and Data (30MHz ~ 1GHz)..... 24
 - 6.6 Test Result and Data (1GHz ~ 25GHz)..... 28
 - 6.7 Restricted Bands of Operation 52
 - 6.8 Test Photographs (30MHz ~ 1GHz) 53
 - 6.9 Test Photographs (1GHz ~ 25GHz) 55
- 7. **Test of Conducted Spurious Emission** 56
 - 7.1 Test Limit 56
 - 7.2 Test Procedure 56
 - 7.3 Test Setup Layout 56
 - 7.4 Test Result and Data 56
- 8. **On Time, Duty Cycle and Measurement methods** 73
 - 8.1 Test Limit 73
 - 8.2 Test Procedure 73
 - 8.3 Test Setup Layout 73
 - 8.4 Test Result and Data 73
- 9. **6dB Bandwidth Measurement Data** 75
 - 9.1 Test Limit 75
 - 9.2 Test Procedures 75
 - 9.3 Test Setup Layout 75



9.4 Test Result and Data 75

10. Maximum Peak and Average Output Power 80

10.1 Test Limit 80

10.2 Test Procedures 80

10.3 Test Setup Layout 80

10.4 Test Result and Data 81

11. Power Spectral Density 82

11.1 Test Limit 82

11.2 Test Procedures 82

11.3 Test Setup Layout 82

11.4 Test Result and Data 82

12. Radio Frequency Exposure 87

12.1 Applicable Standards 87

12.2 EUT Specification 87

12.3 Test Results 88

12.4 Calculation 88

12.5 Maximum Permissible Exposure 89



1. Summary of Test Procedure and Test Results

1.1 Applicable Standards

ANSI C63.10:2013

FCC Rules and Regulations Part 15 Subpart C §15.247

FCC Rule	Description of Test	Result
15.203	. Antenna Requirement	PASS
15.207	. AC Power Line Conducted Emission	PASS
15.209 15.205	. Radiated Spurious Emission	PASS
15.247(d)	. Conducted Spurious Emission	PASS
15.247(a)(2)	. 6dB Bandwidth	PASS
15.247(b)	. Maximum Peak and Average Output Power	PASS
15.247(e)	. Power Spectral Density	PASS
2.1091	. Radio Frequency Exposure	PASS

*The lab has lowered the uncertainty risk of test equipment, environment, and staff technicians according to ISO-IEC17025. Therefore we define test result as compliant when it complies with the standard without further evaluation of test result uncertainty.

*This EUT has been also tested and compiled with the requirement of FCC Part 15, Subpart B, recorded in a separate test report(TEFD2002059).



2. Test Configuration of Equipment under Test

2.1 Feature of Equipment

Frequency Range	802.11b/g/n: 2400-2483.5MHz 802.11a/n/ac: 5150-5250MHz, 5725-5850MHz
Modulation Type	802.11b: CCK, DQPSK, DBPSK 802.11g/n/a: BPSK, QPSK, 16QAM, 64QAM 802.11ac: BPSK, QPSK, 16QAM, 64QAM, 256QAM
Modulation Technology	DSSS, OFDM
Data Rate	WLAN: 802.11b: 1, 2, 5.5, 11Mbps 802.11g: 6, 9, 12, 18, 24, 36, 48, 54Mbps 802.11n: MCS0 – MCS15, HT20/40 802.11a: 6, 9, 12, 18, 24, 36, 48, 54Mbps 802.11ac: MCS0 – MCS9, VHT20/40/80
Antenna Type	Internal Antenna
Antenna Gain	2400-2483.5MHz: ANT A: 4.6dBi, ANT B: 5.3dBi 5150-5250MHz: ANT A: 4.5dBi, ANT B: 4.7dBi 5725-5850MHz: ANT A: 4.5dBi, ANT B: 4.7dBi

Note:

- 1.For more details, please refer to the User’s manual of the EUT.
- 2.MIMO operational in 5GHz and 2.4GHz.



2.2 Carrier Frequency of Channels

802.11b, 802.11g, 802.11n HT20 (2412MHz~2462MHz)

Channel	Frequency(MHz)	Channel	Frequency(MHz)
*01	2412	07	2442
02	2417	08	2447
03	2422	09	2452
04	2427	10	2457
05	2432	*11	2462
*06	2437	---	---

802.11n HT40 (2422MHz~2452MHz)

Channel	Frequency(MHz)	Channel	Frequency(MHz)
---	---	07	2442
---	---	08	2447
*03	2422	*09	2452
04	2427	---	---
05	2432	---	---
*06	2437	---	---

Note: Channels remarked * are selected to perform test.



2.3 Test Mode and Test Software

- a. During testing, the interface cables and equipment positions were varied according to ANSI C63.10.
- b. The complete test system included Remote workstation and EUT for RF test. The Remote workstation included Notebook.
- c. An executive program, "ART2-GUI ver.2.3" under Windows OS system was executed to transmit and receive data via WLAN.
- d. The following test modes were performed for the test:

Conducted Emissions from the AC mains power ports	
Test Mode	Operating Description
1	802.11b (1Mbps) , Power from Adapter
2	802.11g (6Mbps) , Power from Adapter
3	802.11nHT20 (6.5Mbps) , Power from Adapter
4	802.11nHT40 (13.5Mbps) , Power from Adapter
5	802.11b (1Mbps) , Power from PoE
6	802.11g (6Mbps) , Power from PoE
7	802.11nHT20 (6.5Mbps) , Power from PoE
8	802.11nHT40 (13.5Mbps) , Power from PoE
caused "Test Mode 2, 6" generated the worst case, it was reported as the final data.	
Radiation Emissions (30MHz ~ 1GHz)	
Test Mode	Operating Description
1	802.11b (1Mbps) , Power from Adapter
2	802.11g (6Mbps) , Power from Adapter
3	802.11nHT20 (6.5Mbps) , Power from Adapter
4	802.11nHT40 (13.5Mbps) , Power from Adapter
5	802.11b (1Mbps) , Power from PoE
6	802.11g (6Mbps) , Power from PoE
7	802.11nHT20 (6.5Mbps) , Power from PoE
8	802.11nHT40 (13.5Mbps) , Power from PoE
caused "Test Mode 2, 6" generated the worst case, it was reported as the final data.	
Radiation Emissions (1GHz ~ 25GHz)	
Test Mode	Operating Description
1	802.11b (1Mbps)
2	802.11g (6Mbps)
3	802.11nHT20 (6.5Mbps)
4	802.11nHT40 (13.5Mbps)
caused "Test Mode 1~4" generated the worst case, they were reported as the final data.	



2.4 Description of Test System

RF Conducted				
Equipment	Brand	Model	Length/Type	Power cord/Length/Type
Notebook	DELL	Vostro 3560	N/A	Adapter / 1.8m / NS
Adapter	APD	WA-36A12R	1.5m / NS	N/A
RJ45 Cable	N/A	N/A	1.2m / NS	N/A
Radiated Emissions				
Equipment	Brand	Model	Length/Type	Power cord/Length/Type
Notebook	ASUS	P2430U	N/A	Adapter / 1.8m / NS
Adapter	APD	WA-36A12R	1.5m / NS	N/A
POE	Gospower	G0720-240-100	N/A	N/A
RJ45 Cable	N/A	N/A	1.2m / NS	N/A
AC Power Line Conducted Emission				
Equipment	Brand	Model	Length/Type	Power cord/Length/Type
Notebook	ASUS	P2430U	N/A	Adapter / 1.8m / NS
Adapter	APD	WA-36A12R	1.5m / NS	N/A
POE	Gospower	G0720-240-100	N/A	N/A
RJ45 Cable	N/A	N/A	1.2m / NS	N/A
RJ45 Cable	N/A	N/A	1.2m / NS	N/A



2.5 General Information of Test

Test Site	CerpPASS Technology Corporation Test Laboratory Address: No.10, Ln. 2, Lianfu St., Luzhu Dist., Taoyuan City 33848, Taiwan (R.O.C.) Tel:+886-3-3226-888 Fax:+886-3-3226-881	
	FCC	TW1079, TW1439
	IC	4934E-1, 4934E-2
	VCCI	T-2205 for Telecommunication test C-4663 for Conducted emission test R-4218 for Radiated emission test G-10812, G-10813 for radiated disturbance above 1GHz
Frequency Range Investigated:	Conducted: from 150kHz to 30 MHz Radiation: from 30 MHz to 25,000MHz	
Test Distance:	The test distance of radiated emission from antenna to EUT is 3 M.	

Test Item	Test Site	Finish Date	Environmental Conditions	Tested By
RF Conducted	RFCON01-NK	2020/03/17	23°C / 65%	Dian Chen
Radiated Emissions	3M02-NK	2020/03/19	22°C / 48%	Vic Yeh
AC Power Line Conducted Emission	CON01-NK	2020/02/29	22°C / 49%	Leon Huang

2.6 Measurement Uncertainty

Measurement Item	Uncertainty
AC Power Line Conduction(150K~30MHz)	±1.60dB
Radiated Spurious Emission(9KHz~30MHz)	±3.405dB
Radiated Spurious Emission(30MHz~1GHz)	±5.326dB
Radiated Spurious Emission(1GHz~25GHz)	±5.918dB
Conducted Spurious Emission	±2.156dB
6dB Bandwidth	±4.401%
20dB Bandwidth	±4.40%
Occupied Bandwidth	±4.41%
Peak Output Power(Conducted Power Meter)	±1.31dB
Dwell Time	±0.11%
Power Spectral Density	±2.146dB
Duty Cycle	±0.17%



3. Test Equipment and Ancillaries Used for Tests

Test Item	Radiated Emissions				
Test Site	Semi Anechoic Room(3M02-NK)				
Instrument	Manufacturer	Model No	Serial No	Calibration Date	Valid Date
Bilog Antenna	Schwarzbeck	VULB9168	275	2019/09/24	2020/09/23
Bilog Antenna	Schwarzbeck	VULB9168	369	2019/03/29	2020/03/28
Active Loop Antenna	EMCO	6507	40855	2019/05/24	2020/05/23
Horn Antenna	EMCO	3115	31589	2019/04/01	2020/03/31
Horn Antenna	EMCO	3116	31974	2019/09/17	2020/09/16
EMI Receiver	ROHDE & SCHWARZ	ESCI	101423	2019/05/14	2020/05/13
Spectrum Analyzer	ROHDE & SCHWARZ	FSP 40	100219	2019/07/22	2020/07/21
Spectrum Analyzer	ROHDE & SCHWARZ	FSV 40-N	102151	2019/08/02	2020/08/01
Preamplifier	EM Electronics corp.	EM330	60660	2020/03/16	2021/03/15
Preamplifier	EMC INSTRUMENTS	EMC051845SE	980333	2019/09/20	2020/09/19
Preamplifier	Agilent	8449B	3008A01954	2020/03/16	2021/03/15
Preamplifier	EMC INSTRUMENTS	EMC184045	980065	2019/11/07	2020/11/06
Bluetooth Tester	ROHDE & SCHWARZ	CBT	101133	2019/04/07	2020/04/06
Cable-3in1(30M-1G)	HARBOUR INDUSTRIES	LL142	CCE1315	2019/04/09	2020/04/08
Cable-3in1(30M-1G)	HARBOUR INDUSTRIES	LL142	CCE1316	2019/09/20	2020/09/19
Cable-0.5m(1G-40G)	HUBER SUHNER	SUCOFLEX 100	805443/4	2019/05/20	2020/05/19
Cable-3m(1G-40G)	HUBER SUHNER	SUCOFLEX 100	805796/4	2019/05/20	2020/05/19
Cable-8m(1G-40G)	HUBER SUHNER	SUCOFLEX 100	805795/4	2019/05/20	2020/05/19
E3	AUDIX	v8.2014-8-6	RK-000529	NA	NA

Test Item	RF Conducted				
Test Site	RFCON01-NK				
Instrument	Manufacturer	Model No	Serial No	Calibration Date	Valid Date
Spectrum Analyzer	ROHDE & SCHWARZ	FSP 40	100219	2019/07/22	2020/07/21
Spectrum Analyzer	ROHDE & SCHWARZ	FSV 40-N	102151	2019/08/02	2020/08/01
Bluetooth Tester	ROHDE & SCHWARZ	CBT	101133	2019/04/07	2020/04/06
CAX Signal Analyzer	KEYSIGHT	N9000B	MY57100339	2019/11/25	2020/11/24
Attenuator	KEYSIGHT	8491B	MY39250703	2019/09/12	2020/09/11
TEMP & HUMI CHAMBER	T-MACHINE	TMJ-9712	T-12-040111	2019/08/28	2020/08/27
Power Meter	Anritsu	ML2495A	1224005	2019/04/11	2020/04/10
Power Sensor	Anritsu	MA2411B	1207295	2019/04/09	2020/04/08



Test Item	AC Power Line Conducted Emission				
Test Site	CON01-NK				
Instrument	Manufacturer	Model No	Serial No	Calibration Date	Valid Date
EMI Receiver	ROHDE & SCHWARZ	ESCI	100821	2019/09/16	2020/09/15
Line Impedance Stabilization Network	Schwarzbeck	NSLK 8127	8127-568	2019/03/15	2020/03/14
Pulse Limiter	ROHDE & SCHWARZ	ESH3-Z2	101934	2019/03/12	2020/03/11
Cable-6m(9k~300M)	NA	EMC5D-BM-BM-6	130606	2019/03/14	2020/03/13
E3	AUDIX	v8.2014-8-6	RK-000531	NA	NA



4. Antenna Requirements

4.1 Antenna Construction and Directional Gain

Antenna Type	Internal Antenna
Antenna Gain	2.4GHz: ANT A: 4.6 dBi ; ANT B: 5.3 dBi 5150MHz-5250MHz: ANT A: 4.5 dBi ; ANT B: 4.7 dBi 5725MHz-5850MHz: ANT A: 4.5 dBi ; ANT B: 4.7 dBi

2412-2462MHz
For Power directional gain= $G_{ant}= 5.30$ dBi For PSD directional gain = $10 \log[(10^{G1/20} + 10^{G2/20})^2 / N_{ANT}]$ = 7.97 (dBi)
5150MHz -5250MHz
For Power directional gain= $G_{ant}= 4.70$ dBi For PSD directional gain = $10 \log[(10^{G1/20} + 10^{G2/20})^2 / N_{ANT}]$ = 7.61 (dBi)
5725MHz -5850MHz
For Power directional gain= $G_{ant}= 4.70$ dBi For PSD directional gain = $10 \log[(10^{G1/20} + 10^{G2/20})^2 / N_{ANT}]$ = 7.61 (dBi)



5. Test of AC Power Line Conducted Emission

5.1 Test Limit

Conducted Emissions were measured from 150 kHz to 30 MHz with a bandwidth of 9 KHz, according to the methods defined in ANSI C63.4-2014. The EUT was placed on a nonmetallic stand in a shielded room 0.8 meters above the ground plane. The interface cables and equipment positioning were varied within limits of reasonable applications to determine the position produced maximum conducted emissions.

Frequency (MHz)	Quasi Peak (dB μ V)	Average (dB μ V)
0.15 – 0.5	66-56*	56-46*
0.5 – 5.0	56	46
5.0 – 30.0	60	50

*Decreases with the logarithm of the frequency.

5.2 Test Procedures

- a. The EUT was placed 0.4 meter from the conducting wall of the shielding room was kept at least 80 centimeters from any other grounded conducting surface.
- b. Connect EUT to the power mains through a line impedance stabilization network (LISN).
- c. All the support units are connecting to the other LISN.
- d. The LISN provides 50 ohm coupling impedance for the measuring instrument.
- e. The FCC states that a 50 ohm, 50 micro-Henry LISN should be used.
- f. Both sides of AC line were checked for maximum conducted interference.
- g. The frequency range from 150 kHz to 30 MHz was searched.
- h. Set the test-receiver system to Peak Detect Function and Specified Bandwidth with Maximum Hold Mode.



5.3 Typical Test Setup

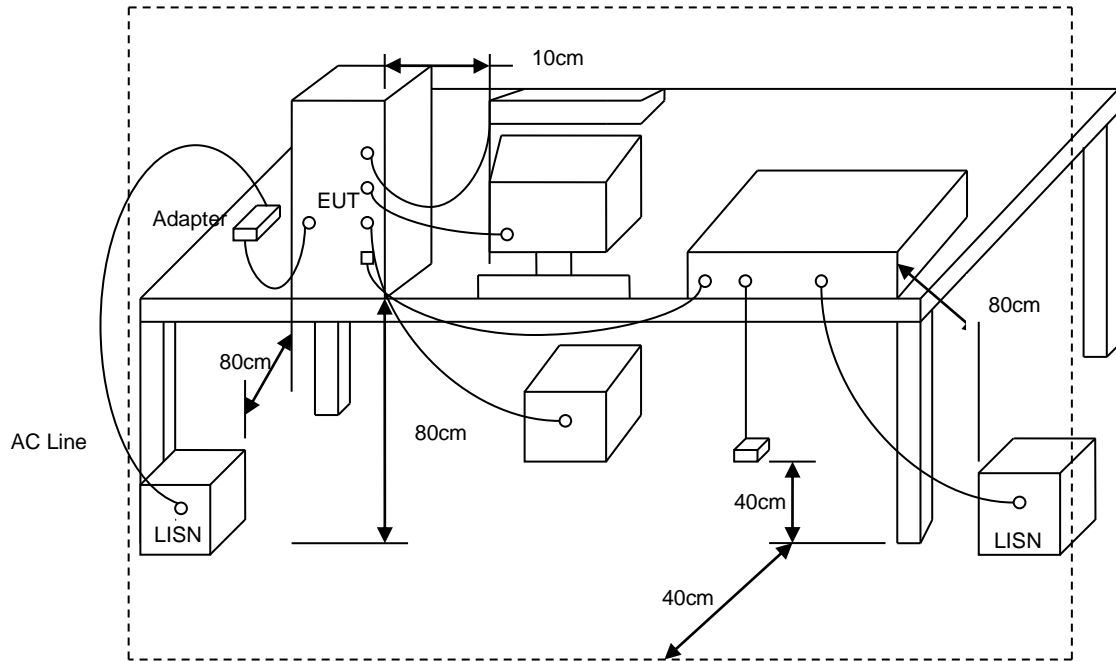



5.4 Test Result and Data

Power	: AC 120V / 60Hz	Pol/Phase	: LINE
Test Mode	: Mode 2, CH06		:

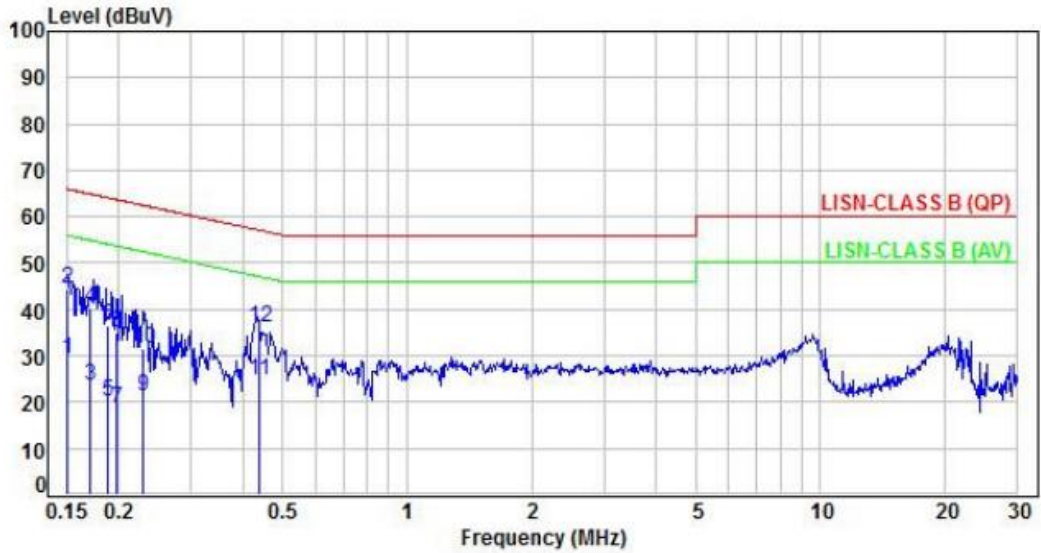

No.	Frequency (MHz)	Factor (dB)	Reading (dBuV)	Level (dBuV)	Limit (dBuV)	Margin (dB)	Detector	P/F
1	0.15	9.92	19.18	29.10	55.98	-26.88	Average	P
2	0.15	9.92	34.47	44.39	65.98	-21.59	QP	P
3	0.17	9.92	13.49	23.41	54.91	-31.50	Average	P
4	0.17	9.92	30.53	40.45	64.91	-24.46	QP	P
5	0.19	9.92	10.32	20.24	54.10	-33.86	Average	P
6	0.19	9.92	26.50	36.42	64.10	-27.68	QP	P
7	0.20	9.92	8.56	18.48	53.72	-35.24	Average	P
8	0.20	9.92	25.25	35.17	63.72	-28.55	QP	P
9	0.23	9.92	11.45	21.37	52.50	-31.13	Average	P
10	0.23	9.92	21.65	31.57	62.50	-30.93	QP	P
11	0.44	9.94	14.72	24.66	47.12	-22.46	Average	P
12	0.44	9.94	26.36	36.30	57.12	-20.82	QP	P

Note: Level=Reading+Factor
 Margin=Level-Limit
 Factor=(LISN or ISN or Current Probe)Factor + Cable Loss



Power	: AC 120V / 60Hz	Pol/Phase	: NEUTRAL
Test Mode	: Mode 2, CH06		:

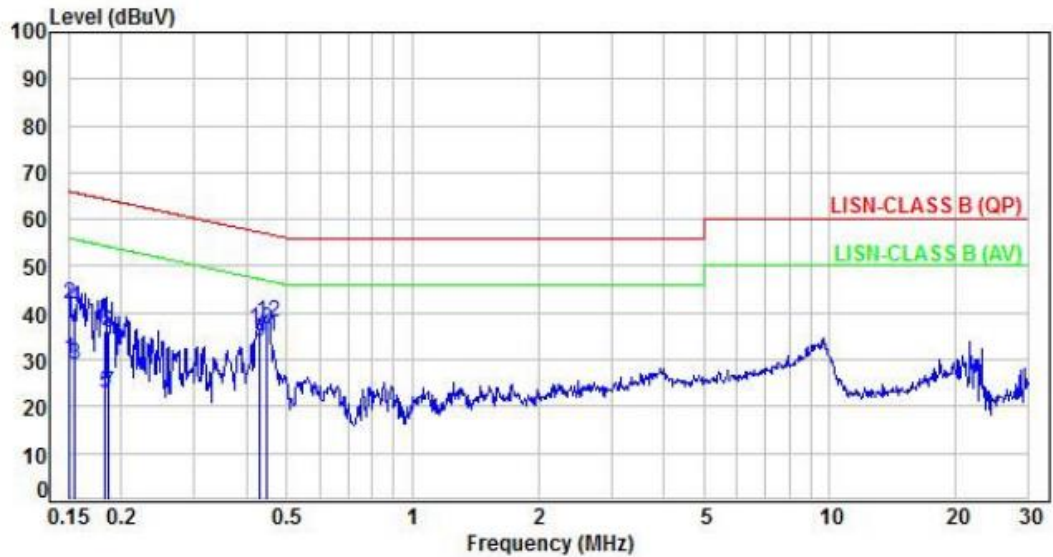

No.	Frequency (MHz)	Factor (dB)	Reading (dBuV)	Level (dBuV)	Limit (dBuV)	Margin (dB)	Detector	P/F
1	0.15	9.95	20.00	29.95	55.97	-26.02	Average	P
2	0.15	9.95	32.03	41.98	65.97	-23.99	QP	P
3	0.16	9.95	19.09	29.04	55.71	-26.67	Average	P
4	0.16	9.95	31.02	40.97	65.71	-24.74	QP	P
5	0.18	9.95	12.99	22.94	54.36	-31.42	Average	P
6	0.18	9.95	26.28	36.23	64.36	-28.13	QP	P
7	0.19	9.95	12.79	22.74	54.22	-31.48	Average	P
8	0.19	9.95	25.63	35.58	64.22	-28.64	QP	P
9	0.43	9.96	23.92	33.88	47.28	-13.40	Average	P
10	0.43	9.96	26.43	36.39	57.28	-20.89	QP	P
11	0.45	9.96	25.01	34.97	46.94	-11.97	Average	P
12	0.45	9.96	27.98	37.94	56.94	-19.00	QP	P

Note: Level=Reading+Factor
 Margin=Level-Limit
 Factor=(LISN or ISN or Current Probe)Factor + Cable Loss



Power	: AC 120V / 60Hz	Pol/Phase	: LINE
Test Mode	: Mode 6, CH06		:

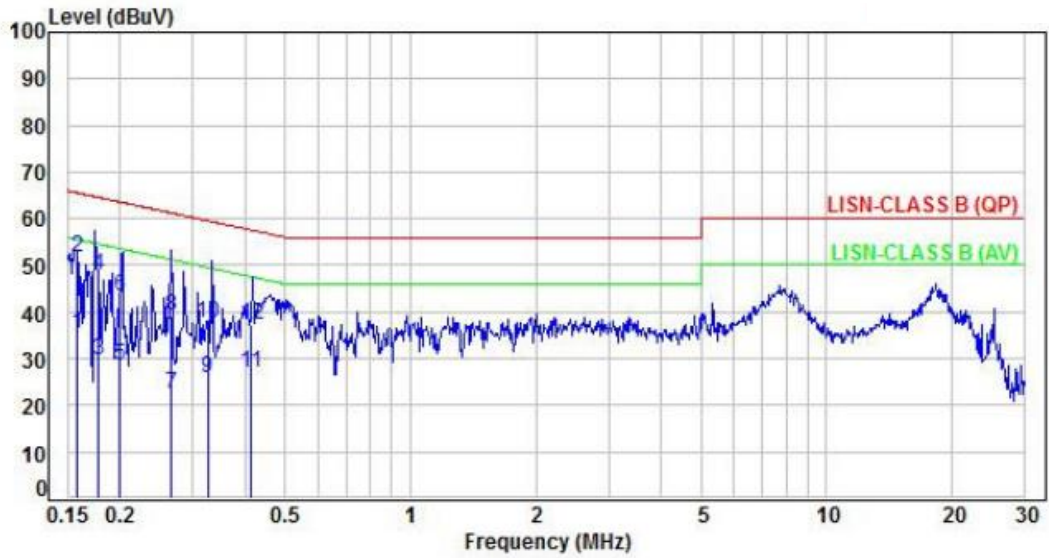

No.	Frequency (MHz)	Factor (dB)	Reading (dBuV)	Level (dBuV)	Limit (dBuV)	Margin (dB)	Detector	P/F
1	0.16	9.92	25.36	35.28	55.54	-20.26	Average	P
2	0.16	9.92	41.91	51.83	65.54	-13.71	QP	P
3	0.18	9.92	19.68	29.60	54.57	-24.97	Average	P
4	0.18	9.92	38.04	47.96	64.57	-16.61	QP	P
5	0.20	9.92	18.44	28.36	53.58	-25.22	Average	P
6	0.20	9.92	33.34	43.26	63.58	-20.32	QP	P
7	0.26	9.92	12.64	22.56	51.28	-28.72	Average	P
8	0.26	9.92	29.24	39.16	61.28	-22.12	QP	P
9	0.33	9.94	16.06	26.00	49.58	-23.58	Average	P
10	0.33	9.94	27.68	37.62	59.58	-21.96	QP	P
11	0.41	9.94	17.19	27.13	47.57	-20.44	Average	P
12	0.41	9.94	27.29	37.23	57.57	-20.34	QP	P

Note: Level=Reading+Factor
 Margin=Level-Limit
 Factor=(LISN or ISN or Current Probe)Factor + Cable Loss



Power	: AC 120V / 60Hz	Pol/Phase	: NEUTRAL
Test Mode	: Mode 6, CH06		:

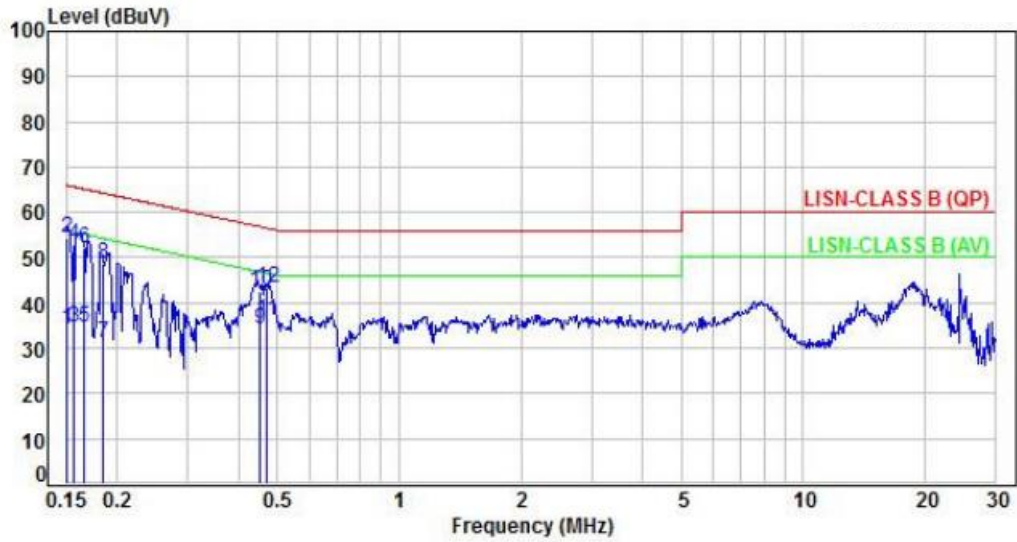

No.	Frequency (MHz)	Factor (dB)	Reading (dBUV)	Level (dBUV)	Limit (dBUV)	Margin (dB)	Detector	P/F
1	0.15	9.95	24.28	34.23	55.98	-21.75	Average	P
2	0.15	9.95	44.41	54.36	65.98	-11.62	QP	P
3	0.16	9.95	24.81	34.76	55.68	-20.92	Average	P
4	0.16	9.95	43.03	52.98	65.68	-12.70	QP	P
5	0.17	9.95	24.71	34.66	55.18	-20.52	Average	P
6	0.17	9.95	42.22	52.17	65.18	-13.01	QP	P
7	0.18	9.95	21.22	31.17	54.26	-23.09	Average	P
8	0.18	9.95	38.60	48.55	64.26	-15.71	QP	P
9	0.45	9.96	24.23	34.19	46.87	-12.68	Average	P
10	0.45	9.96	32.55	42.51	56.87	-14.36	QP	P
11	0.47	9.96	26.10	36.06	46.52	-10.46	Average	P
12	0.47	9.96	33.31	43.27	56.52	-13.25	QP	P

Note: Level=Reading+Factor
 Margin=Level-Limit
 Factor=(LISN or ISN or Current Probe)Factor + Cable Loss



6. Test of Radiated Spurious Emission

6.1 Test Limit

In any 100kHz bandwidth outside the frequency band in which the spread spectrum or digitally modulated intentional radiator is operating, the radio frequency power that is produced by the intentional radiator shall be at least 20dB below that in the 100kHz bandwidth within the band that contains the highest level of the desired power, based on either an RF conducted or a radiated measurement. If the transmitter measurement is based on the maximum conducted output power, the attenuation required under this paragraph shall be 30dB instead of 20dB. In addition, radiated emissions which fall in section 15.205(a) the restricted bands must also comply with the radiated emission limit specified in section 15.209(a).

Frequency (MHz)	Field Strength (microvolt/meter)	Measurement Distance (meters)
0.009 ~ 0.490	2400/F(kHz)	300
0.490 ~ 1.705	24000/F(kHz)	30
1.705 ~ 30.0	30	30
30 ~ 88	100	3
88 ~ 216	150	3
216 ~ 960	200	3
Above 960	500	3

6.2 Test Procedures

- The EUT was placed on a rotatable table top 0.8 meter above ground.
- The EUT was set 3 meters from the interference receiving antenna which was mounted on the top of a variable height antenna tower.
- The table was rotated 360 degrees to determine the position of the highest radiation.
- The antenna is a broadband antenna and its height is varied between one meter and four meters above ground to find the maximum value of the field strength both horizontal polarization and vertical polarization of the antenna are set to make the measurement.
- For each suspected emission the EUT was arranged to its worst case and then tune the antenna tower (from 1 M to 4 M) and turn table (from 0 degree to 360 degrees) to find the maximum reading.
- Set the test-receiver system to Peak or CISPR quasi-peak Detect Function and specified bandwidth with Maximum Hold Mode.
- If the emission level of the EUT in peak mode was 3 dB lower than the limit specified, then testing will be stopped and peak values of EUT will be reported, otherwise, the emissions which do not have 3 dB margin will be repeated one by one using the quasi-peak method and reported.
- For testing above 1GHz, the emission level of the EUT in peak mode was 20dB lower than average limit (that means the emission level in peak mode also complies with the limit in average mode), then testing will be stopped and peak values of EUT will be reported, otherwise, the emissions will be measured in average mode again and reported.
- "Cone of radiation" has been considered to be 3dB bandwidth of the measurement antenna.



6.3 Typical Test Setup

Below 30MHz test setup

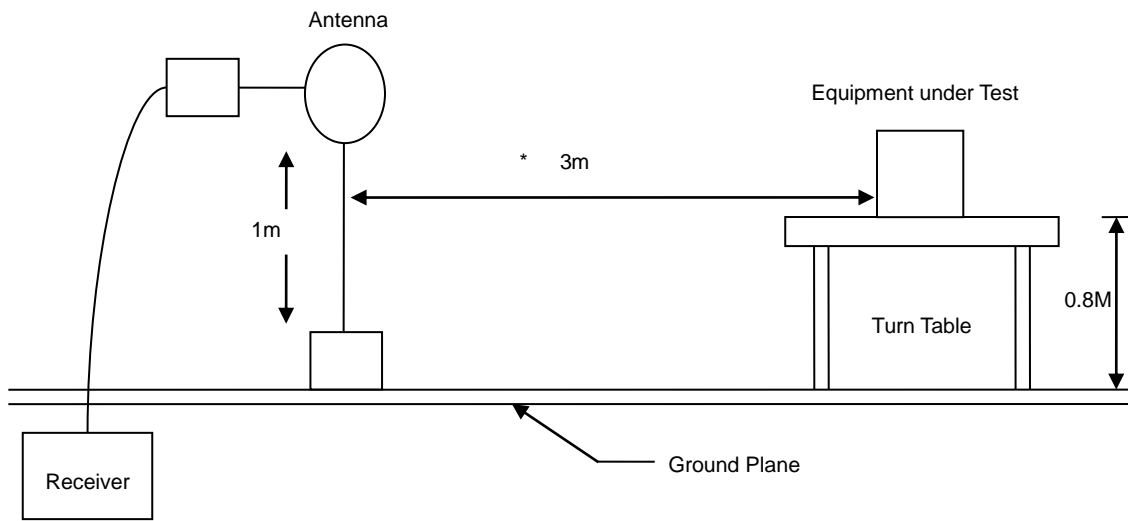

30MHz- 1GHz Test Setup

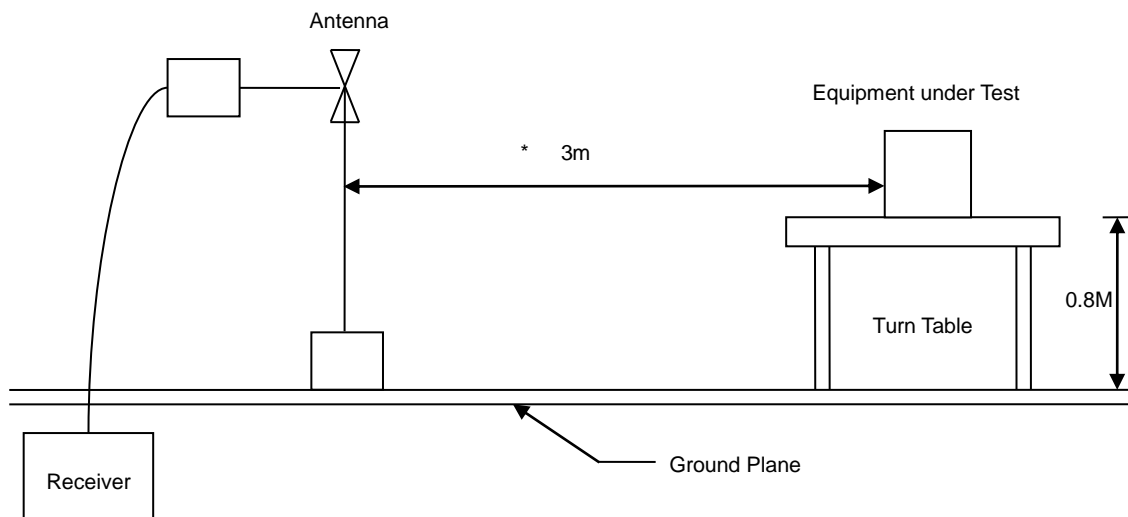

Above 1GHz Test Setup

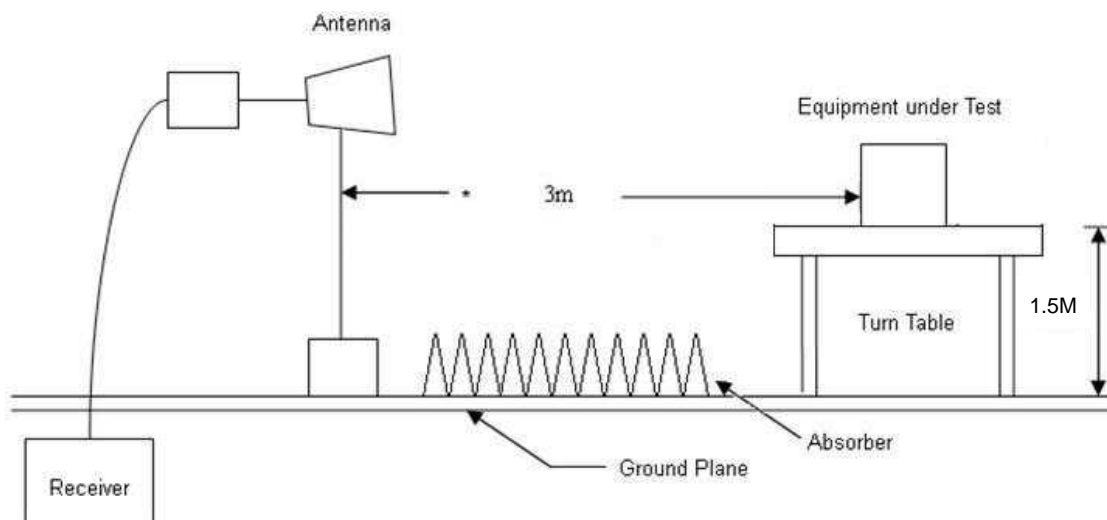



6.4 Test Result and Data (9KHz ~ 30MHz)

The 9kHz - 30MHz spurious emission is under limit 20dB more.

6.5 Test Result and Data (30MHz ~ 1GHz)

Power	: AC 120V / 60Hz	Pol/Phase	: VERTICAL
Test Mode	: Mode 2, CH06		:

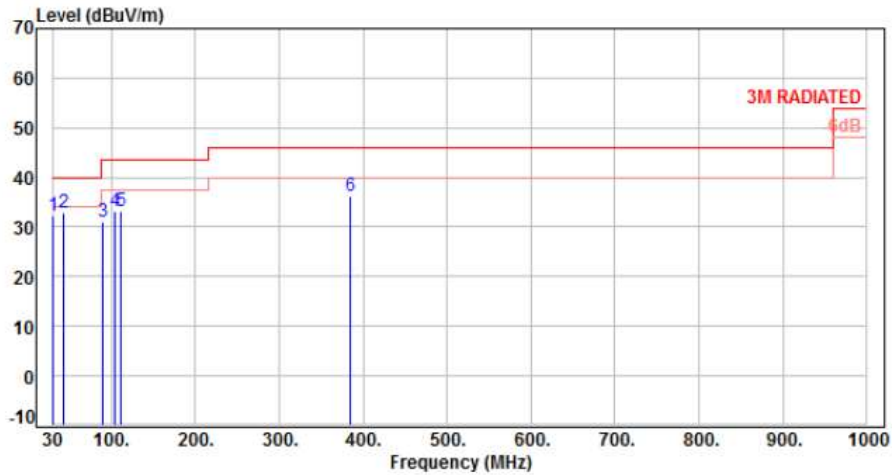

No.	Frequency (MHz)	Factor (dB)	Reading (dBuV)	Level (dBuV/m)	Limit (dBuV/m)	Margin (dB)	Detector	Height (cm)	Azimuth (deg)	P/F
1	30.00	-10.17	42.46	32.29	40.00	-7.71	Peak	100	0	P
2	43.58	-9.37	42.31	32.94	40.00	-7.06	Peak	100	0	P
3	90.14	-15.60	46.76	31.16	43.50	-12.34	Peak	100	0	P
4	104.69	-13.37	46.51	33.14	43.50	-10.36	Peak	100	0	P
5	110.51	-12.44	45.75	33.31	43.50	-10.19	Peak	100	0	P
6	384.05	-6.10	42.31	36.21	46.00	-9.79	Peak	100	0	P

Note: Level=Reading+Factor
Margin=Level-Limit
Factor=Antenna Factor + cable loss - Amplifier Factor



Power	: AC 120V / 60Hz	Pol/Phase	: HORIZONTAL
Test Mode	: Mode 2, CH06		:

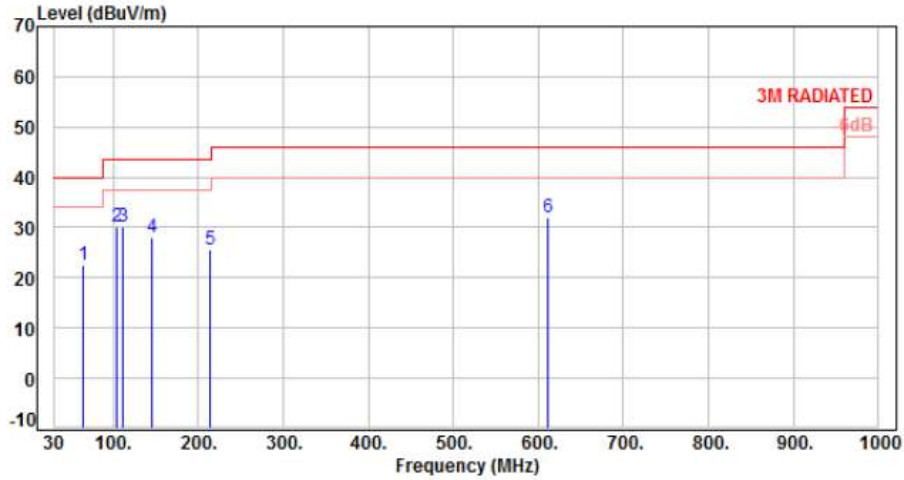

No.	Frequency (MHz)	Factor (dB)	Reading (dBuV)	Level (dBuV/m)	Limit (dBuV/m)	Margin (dB)	Detector	Height (cm)	Azimuth (deg)	P/F
1	63.95	-10.59	33.06	22.47	40.00	-17.53	Peak	150	0	P
2	104.69	-13.37	43.65	30.28	43.50	-13.22	Peak	150	0	P
3	111.48	-12.39	42.61	30.22	43.50	-13.28	Peak	150	0	P
4	145.43	-9.57	37.47	27.90	43.50	-15.60	Peak	150	0	P
5	214.30	-11.99	37.59	25.60	43.50	-17.90	Peak	150	0	P
6	611.03	-0.87	32.90	32.03	46.00	-13.97	Peak	150	0	P

Note: Level=Reading+Factor
 Margin=Level-Limit
 Factor=Antenna Factor + cable loss - Amplifier Factor



Power	: AC 120V / 60Hz	Pol/Phase	: VERTICAL
Test Mode	: Mode 6, CH06		:

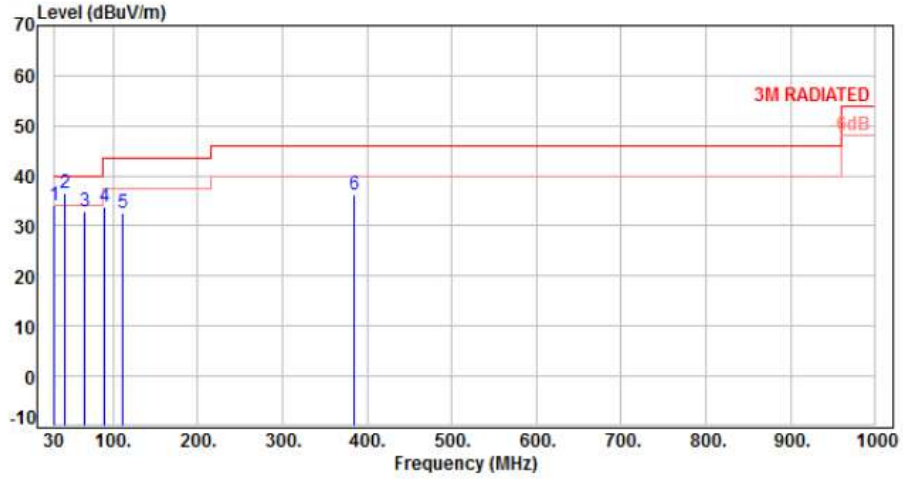

No.	Frequency (MHz)	Factor (dB)	Reading (dBuV)	Level (dBuV/m)	Limit (dBuV/m)	Margin (dB)	Detector	Height (cm)	Azimuth (deg)	P/F
1	30.00	-10.17	44.23	34.06	40.00	-5.94	Peak	100	0	P
2	43.58	-9.37	46.03	36.66	40.00	-3.34	Peak	100	0	P
3	65.89	-10.97	43.84	32.87	40.00	-7.13	Peak	100	0	P
4	89.17	-15.53	49.45	33.92	43.50	-9.58	Peak	100	0	P
5	111.48	-12.39	44.94	32.55	43.50	-10.95	Peak	100	0	P
6	384.05	-6.10	42.33	36.23	46.00	-9.77	Peak	100	0	P

Note: Level=Reading+Factor
Margin=Level-Limit
Factor=Antenna Factor + cable loss - Amplifier Factor



Power	: AC 120V / 60Hz	Pol/Phase	: HORIZONTAL
Test Mode	: Mode 6, CH06		:

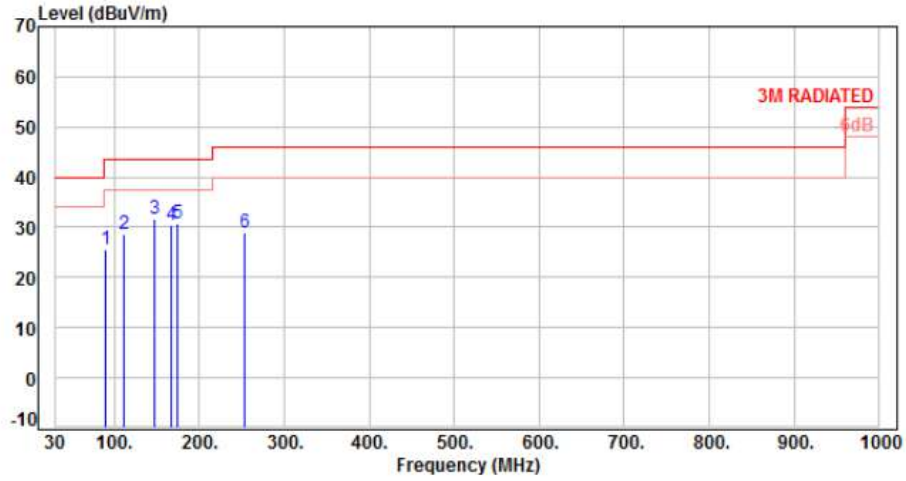

No.	Frequency (MHz)	Factor (dB)	Reading (dBuV)	Level (dBuV/m)	Limit (dBuV/m)	Margin (dB)	Detector	Height (cm)	Azimuth (deg)	P/F
1	90.14	-15.60	41.10	25.50	43.50	-18.00	Peak	150	0	P
2	111.48	-12.39	40.98	28.59	43.50	-14.91	Peak	150	0	P
3	147.37	-9.51	41.08	31.57	43.50	-11.93	Peak	150	0	P
4	166.77	-9.58	40.17	30.59	43.50	-12.91	Peak	150	0	P
5	174.53	-10.19	41.10	30.91	43.50	-12.59	Peak	150	0	P
6	253.10	-10.22	39.21	28.99	46.00	-17.01	Peak	150	0	P

Note: Level=Reading+Factor
 Margin=Level-Limit
 Factor=Antenna Factor + cable loss - Amplifier Factor



6.6 Test Result and Data (1GHz ~ 25GHz)

Power	: AC 120V / 60Hz	Pol/Phase	: VERTICAL
Test Mode	: Mode 1, CH01		:

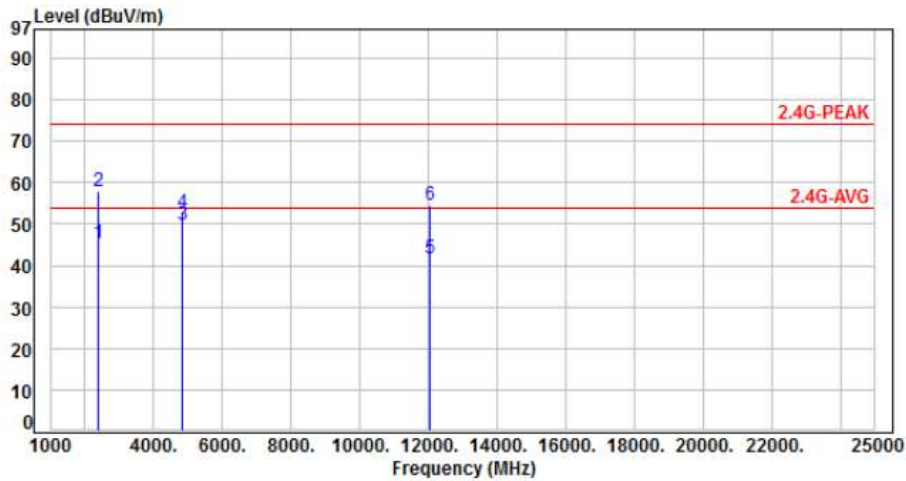

No.	Frequency (MHz)	Factor (dB)	Reading (dBuV)	Level (dBuV/m)	Limit (dBuV/m)	Margin (dB)	Detector	Height (cm)	Azimuth (deg)	P/F
1	2390.00	-3.64	49.10	45.46	54.00	-8.54	Average	368	295	P
2	2390.00	-3.64	61.67	58.03	74.00	-15.97	Peak	368	295	P
3	4824.00	3.76	46.02	49.78	54.00	-4.22	Average	127	54	P
4	4824.00	3.76	49.11	52.87	74.00	-21.13	Peak	127	54	P
5	12060.00	13.45	28.39	41.84	54.00	-12.16	Average	100	102	P
6	12060.00	13.45	41.20	54.65	74.00	-19.35	Peak	100	102	P

Note: Level=Reading+Factor
 Margin=Level-Limit
 Factor=Antenna Factor + cable loss - Amplifier Factor



Power	: AC 120V / 60Hz	Pol/Phase	: HORIZONTAL
Test Mode	: Mode 1, CH01		:

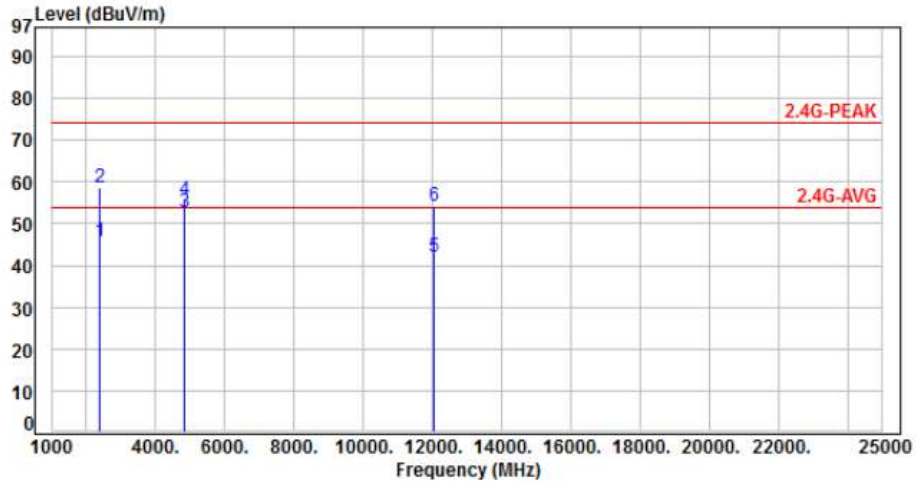

No.	Frequency (MHz)	Factor (dB)	Reading (dBuV)	Level (dBuV/m)	Limit (dBuV/m)	Margin (dB)	Detector	Height (cm)	Azimuth (deg)	P/F
1	2390.00	-3.64	49.30	45.66	54.00	-8.34	Average	100	311	P
2	2390.00	-3.64	62.38	58.74	74.00	-15.26	Peak	100	311	P
3	4824.00	3.76	49.14	52.90	54.00	-1.10	Average	122	340	P
4	4824.00	3.76	51.77	55.53	74.00	-18.47	Peak	122	340	P
5	12060.00	13.45	28.43	41.88	54.00	-12.12	Average	100	168	P
6	12060.00	13.45	40.90	54.35	74.00	-19.65	Peak	100	168	P

Note: Level=Reading+Factor
Margin=Level-Limit
Factor=Antenna Factor + cable loss - Amplifier Factor



Power	: AC 120V / 60Hz	Pol/Phase	: VERTICAL
Test Mode	: Mode 1, CH06		:

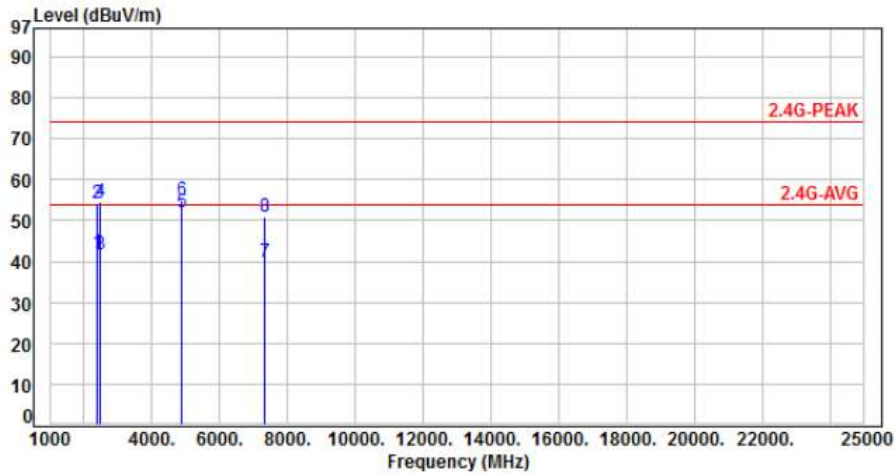

No.	Frequency (MHz)	Factor (dB)	Reading (dBuV)	Level (dBuV/m)	Limit (dBuV/m)	Margin (dB)	Detector	Height (cm)	Azimuth (deg)	P/F
1	2390.00	-3.64	45.80	42.16	54.00	-11.84	Average	394	345	P
2	2390.00	-3.64	57.90	54.26	74.00	-19.74	Peak	394	345	P
3	2483.50	-3.30	45.07	41.77	54.00	-12.23	Average	394	345	P
4	2483.50	-3.30	57.85	54.55	74.00	-19.45	Peak	394	345	P
5	4874.00	3.95	48.12	52.07	54.00	-1.93	Average	100	45	P
6	4874.00	3.95	50.98	54.93	74.00	-19.07	Peak	100	45	P
7	7311.00	8.84	30.87	39.71	54.00	-14.29	Average	100	333	P
8	7311.00	8.84	42.13	50.97	74.00	-23.03	Peak	100	333	P

Note: Level=Reading+Factor
 Margin=Level-Limit
 Factor=Antenna Factor + cable loss - Amplifier Factor



Power	: AC 120V / 60Hz	Pol/Phase	: HORIZONTAL
Test Mode	: Mode 1, CH06		:

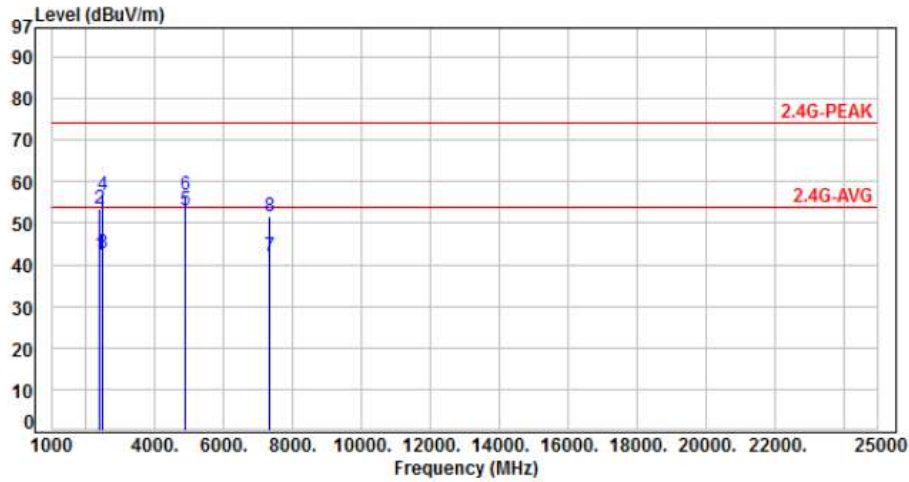

No.	Frequency (MHz)	Factor (dB)	Reading (dBuV)	Level (dBuV/m)	Limit (dBuV/m)	Margin (dB)	Detector	Height (cm)	Azimuth (deg)	P/F
1	2390.00	-3.64	46.08	42.44	54.00	-11.56	Average	100	316	P
2	2390.00	-3.64	57.26	53.62	74.00	-20.38	Peak	100	316	P
3	2483.50	-3.30	46.05	42.75	54.00	-11.25	Average	100	316	P
4	2483.50	-3.30	60.24	56.94	74.00	-17.06	Peak	100	316	P
5	4874.00	3.95	49.04	52.99	54.00	-1.01	Average	122	335	P
6	4874.00	3.95	52.90	56.85	74.00	-17.15	Peak	122	335	P
7	7311.00	8.84	33.04	41.88	54.00	-12.12	Average	264	233	P
8	7311.00	8.84	42.92	51.76	74.00	-22.24	Peak	264	233	P

Note: Level=Reading+Factor
 Margin=Level-Limit
 Factor=Antenna Factor + cable loss - Amplifier Factor



Power	: AC 120V / 60Hz	Pol/Phase	: VERTICAL
Test Mode	: Mode 1, CH11		:

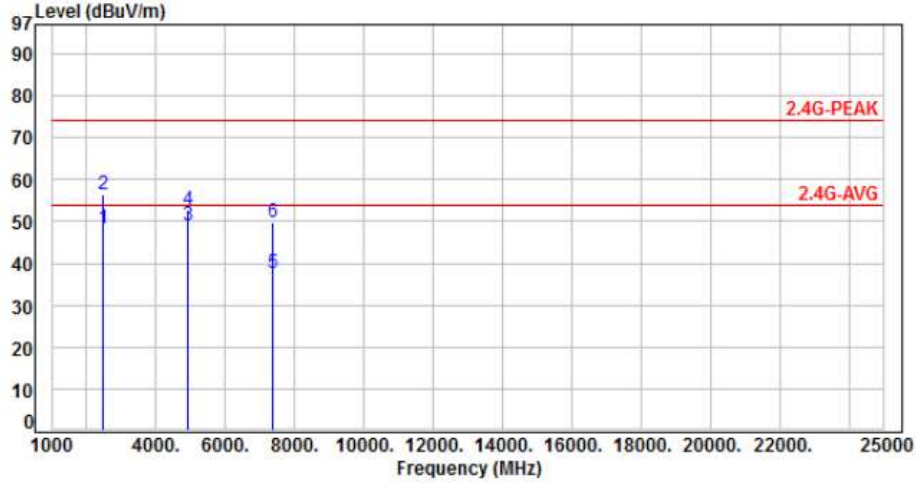

No.	Frequency (MHz)	Factor (dB)	Reading (dBUV)	Level (dBUV/m)	Limit (dBUV/m)	Margin (dB)	Detector	Height (cm)	Azimuth (deg)	P/F
1	2483.50	-3.30	51.68	48.38	54.00	-5.62	Average	388	272	P
2	2483.50	-3.30	59.71	56.41	74.00	-17.59	Peak	388	272	P
3	4924.00	4.10	45.10	49.20	54.00	-4.80	Average	100	51	P
4	4924.00	4.10	48.77	52.87	74.00	-21.13	Peak	100	51	P
5	7386.00	8.94	28.65	37.59	54.00	-16.41	Average	100	355	P
6	7386.00	8.94	40.98	49.92	74.00	-24.08	Peak	100	355	P

Note: Level=Reading+Factor
 Margin=Level-Limit
 Factor=Antenna Factor + cable loss - Amplifier Factor



Power	: AC 120V / 60Hz	Pol/Phase	: HORIZONTAL
Test Mode	: Mode 1, CH11		:

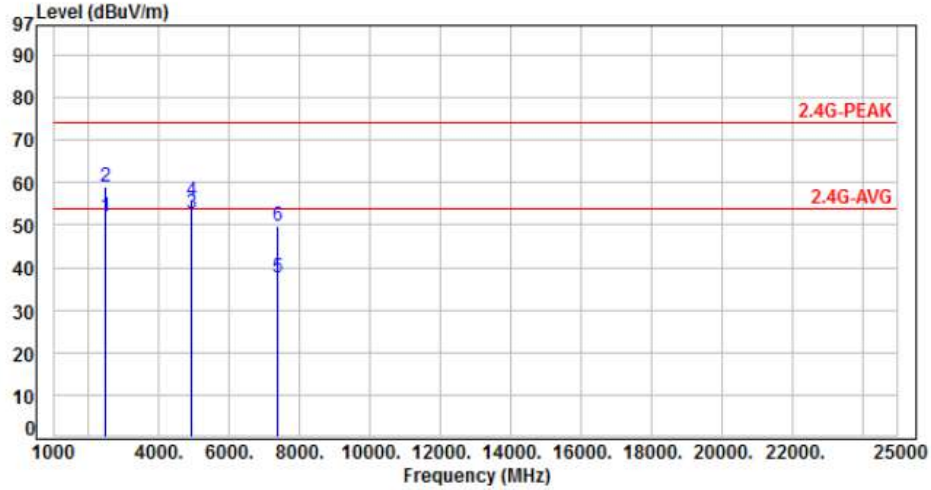

No.	Frequency (MHz)	Factor (dB)	Reading (dBuV)	Level (dBuV/m)	Limit (dBuV/m)	Margin (dB)	Detector	Height (cm)	Azimuth (deg)	P/F
1	2483.50	-3.30	55.19	51.89	54.00	-2.11	Average	163	313	P
2	2483.50	-3.30	62.15	58.85	74.00	-15.15	Peak	163	313	P
3	4924.00	4.10	48.78	52.88	54.00	-1.12	Average	122	331	P
4	4924.00	4.10	51.45	55.55	74.00	-18.45	Peak	122	331	P
5	7386.00	8.94	28.60	37.54	54.00	-16.46	Average	247	238	P
6	7386.00	8.94	40.95	49.89	74.00	-24.11	Peak	247	238	P

Note: Level=Reading+Factor
 Margin=Level-Limit
 Factor=Antenna Factor + cable loss - Amplifier Factor



Power	: AC 120V / 60Hz	Pol/Phase	: VERTICAL
Test Mode	: Mode 2, CH01		:

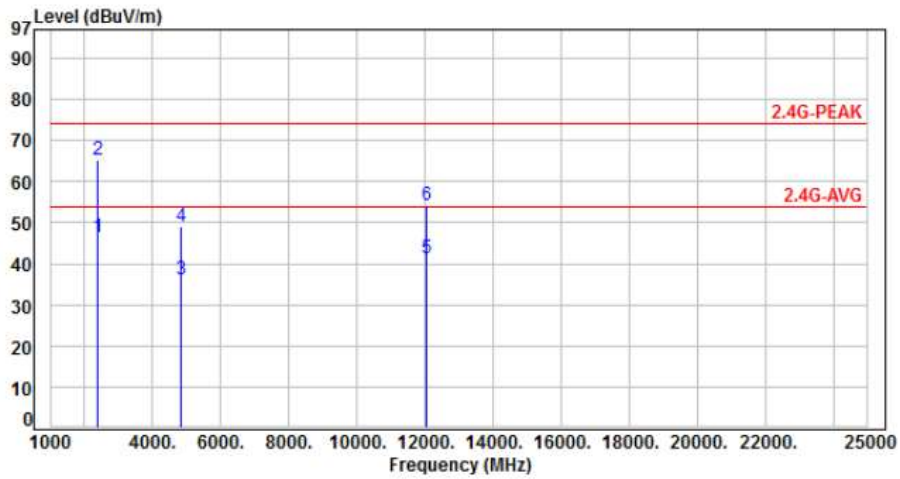

No.	Frequency (MHz)	Factor (dB)	Reading (dBuV)	Level (dBuV/m)	Limit (dBuV/m)	Margin (dB)	Detector	Height (cm)	Azimuth (deg)	P/F
1	2390.00	-3.64	50.17	46.53	54.00	-7.47	Average	336	146	P
2	2390.00	-3.64	68.82	65.18	74.00	-8.82	Peak	336	146	P
3	4824.00	3.76	32.35	36.11	54.00	-17.89	Average	203	37	P
4	4824.00	3.76	45.22	48.98	74.00	-25.02	Peak	203	37	P
5	12060.00	13.45	27.95	41.40	54.00	-12.60	Average	100	255	P
6	12060.00	13.45	40.62	54.07	74.00	-19.93	Peak	100	255	P

Note: Level=Reading+Factor
 Margin=Level-Limit
 Factor=Antenna Factor + cable loss - Amplifier Factor



Power	: AC 120V / 60Hz	Pol/Phase	: HORIZONTAL
Test Mode	: Mode 2, CH01		:

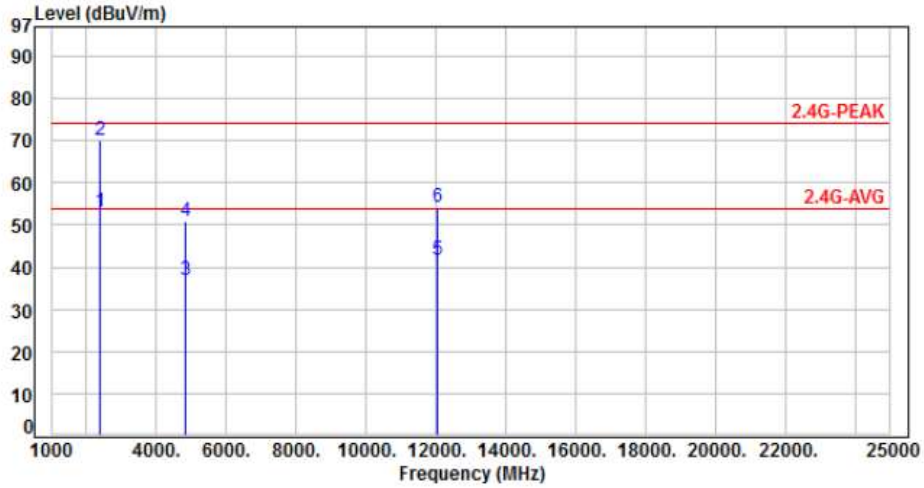

No.	Frequency (MHz)	Factor (dB)	Reading (dBuV)	Level (dBuV/m)	Limit (dBuV/m)	Margin (dB)	Detector	Height (cm)	Azimuth (deg)	P/F
1	2390.00	-3.64	56.63	52.99	54.00	-1.01	Average	232	318	P
2	2390.00	-3.64	73.56	69.92	74.00	-4.08	Peak	232	318	P
3	4824.00	3.76	33.14	36.90	54.00	-17.10	Average	100	334	P
4	4824.00	3.76	47.32	51.08	74.00	-22.92	Peak	100	334	P
5	12060.00	13.45	28.13	41.58	54.00	-12.42	Average	100	214	P
6	12060.00	13.45	40.88	54.33	74.00	-19.67	Peak	100	214	P

Note: Level=Reading+Factor
 Margin=Level-Limit
 Factor=Antenna Factor + cable loss - Amplifier Factor



Power	: AC 120V / 60Hz	Pol/Phase	: VERTICAL
Test Mode	: Mode 2, CH06		:

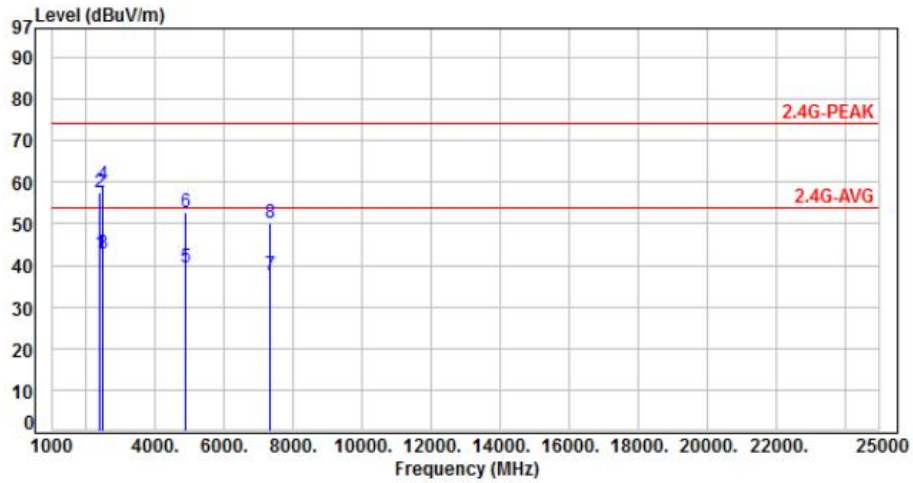

No.	Frequency (MHz)	Factor (dB)	Reading (dBuV)	Level (dBuV/m)	Limit (dBuV/m)	Margin (dB)	Detector	Height (cm)	Azimuth (deg)	P/F
1	2390.00	-3.64	46.40	42.76	54.00	-11.24	Average	338	141	P
2	2390.00	-3.64	61.19	57.55	74.00	-16.45	Peak	338	141	P
3	2483.50	-3.30	46.19	42.89	54.00	-11.11	Average	338	300	P
4	2483.50	-3.30	62.74	59.44	74.00	-14.56	Peak	338	300	P
5	4874.00	3.95	35.52	39.47	54.00	-14.53	Average	198	39	P
6	4874.00	3.95	48.72	52.67	74.00	-21.33	Peak	198	39	P
7	7311.00	8.84	28.79	37.63	54.00	-16.37	Average	100	325	P
8	7311.00	8.84	41.41	50.25	74.00	-23.75	Peak	100	325	P

Note: Level=Reading+Factor
 Margin=Level-Limit
 Factor=Antenna Factor + cable loss - Amplifier Factor



Power	: AC 120V / 60Hz	Pol/Phase	: HORIZONTAL
Test Mode	: Mode 2, CH06		:

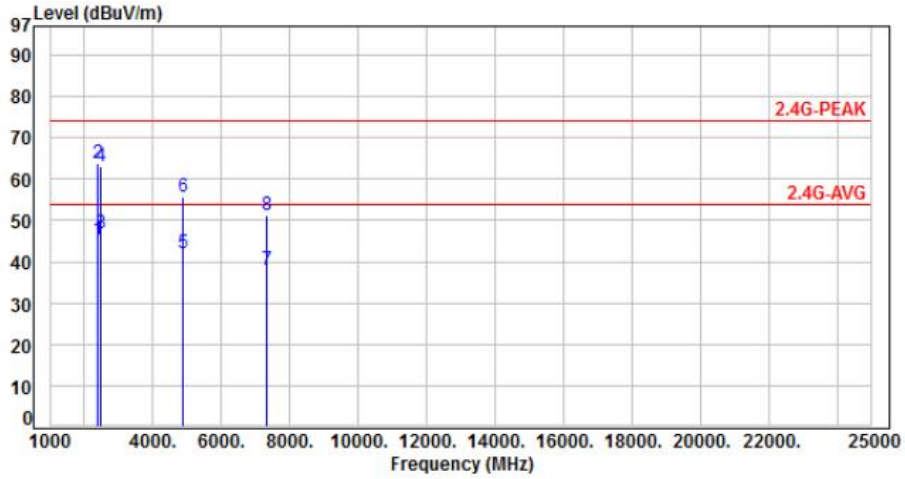

No.	Frequency (MHz)	Factor (dB)	Reading (dBUV)	Level (dBUV/m)	Limit (dBUV/m)	Margin (dB)	Detector	Height (cm)	Azimuth (deg)	P/F
1	2390.00	-3.64	49.08	45.44	54.00	-8.56	Average	236	312	P
2	2390.00	-3.64	67.35	63.71	74.00	-10.29	Peak	236	312	P
3	2483.50	-3.30	49.98	46.68	54.00	-7.32	Average	236	312	P
4	2483.50	-3.30	66.21	62.91	74.00	-11.09	Peak	236	312	P
5	4874.00	3.95	38.23	42.18	54.00	-11.82	Average	100	335	P
6	4874.00	3.95	51.78	55.73	74.00	-18.27	Peak	100	335	P
7	7311.00	8.84	29.03	37.87	54.00	-16.13	Average	100	55	P
8	7311.00	8.84	42.50	51.34	74.00	-22.66	Peak	100	55	P

Note: Level=Reading+Factor
 Margin=Level-Limit
 Factor=Antenna Factor + cable loss - Amplifier Factor



Power	: AC 120V / 60Hz	Pol/Phase	: VERTICAL
Test Mode	: Mode 2, CH11		:

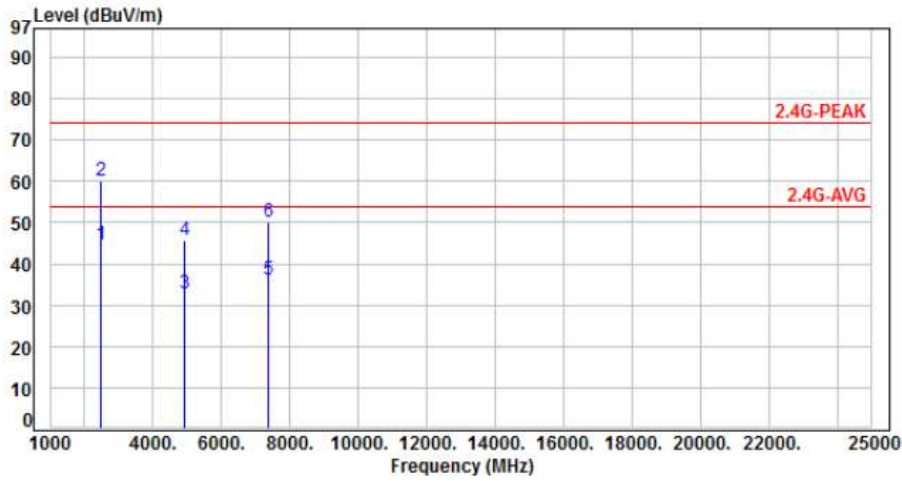

No.	Frequency (MHz)	Factor (dB)	Reading (dBuV)	Level (dBuV/m)	Limit (dBuV/m)	Margin (dB)	Detector	Height (cm)	Azimuth (deg)	P/F
1	2483.50	-3.30	47.82	44.52	54.00	-9.48	Average	340	151	P
2	2483.50	-3.30	63.29	59.99	74.00	-14.01	Peak	340	151	P
3	4924.00	4.10	28.88	32.98	54.00	-21.02	Average	192	39	P
4	4924.00	4.10	41.46	45.56	74.00	-28.44	Peak	192	39	P
5	7386.00	8.94	27.32	36.26	54.00	-17.74	Average	100	311	P
6	7386.00	8.94	41.36	50.30	74.00	-23.70	Peak	100	311	P

Note: Level=Reading+Factor
 Margin=Level-Limit
 Factor=Antenna Factor + cable loss - Amplifier Factor



Power	: AC 120V / 60Hz	Pol/Phase	: HORIZONTAL
Test Mode	: Mode 2, CH11		:

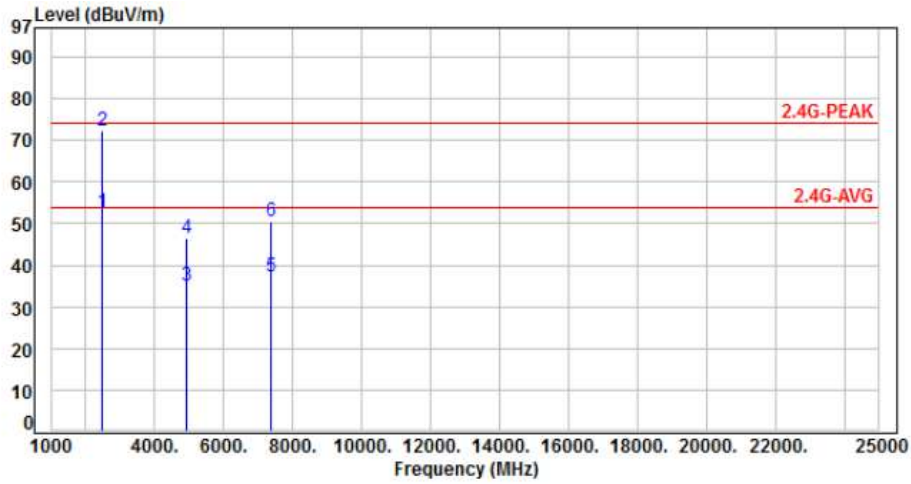

No.	Frequency (MHz)	Factor (dB)	Reading (dBuV)	Level (dBuV/m)	Limit (dBuV/m)	Margin (dB)	Detector	Height (cm)	Azimuth (deg)	P/F
1	2483.50	-3.30	56.11	52.81	54.00	-1.19	Average	242	318	P
2	2483.50	-3.30	75.59	72.29	74.00	-1.71	Peak	242	318	P
3	4924.00	4.10	30.82	34.92	54.00	-19.08	Average	100	320	P
4	4924.00	4.10	42.38	46.48	74.00	-27.52	Peak	100	320	P
5	7386.00	8.94	28.19	37.13	54.00	-16.87	Average	100	63	P
6	7386.00	8.94	41.62	50.56	74.00	-23.44	Peak	100	63	P

Note: Level=Reading+Factor
 Margin=Level-Limit
 Factor=Antenna Factor + cable loss - Amplifier Factor



Power	: AC 120V / 60Hz	Pol/Phase	: VERTICAL
Test Mode	: Mode 3, CH01		:

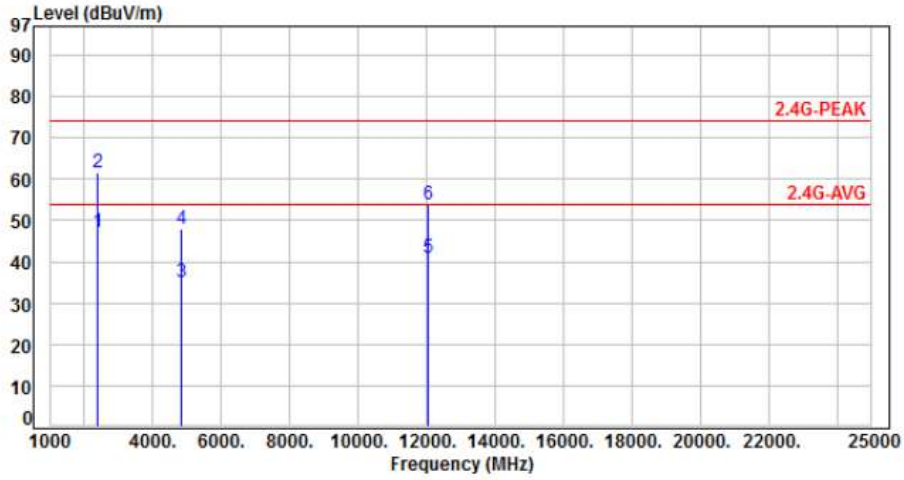

No.	Frequency (MHz)	Factor (dB)	Reading (dBuV)	Level (dBuV/m)	Limit (dBuV/m)	Margin (dB)	Detector	Height (cm)	Azimuth (deg)	P/F
1	2390.00	-3.64	50.94	47.30	54.00	-6.70	Average	395	350	P
2	2390.00	-3.64	65.05	61.41	74.00	-12.59	Peak	395	350	P
3	4824.00	3.76	31.15	34.91	54.00	-19.09	Average	205	34	P
4	4824.00	3.76	44.22	47.98	74.00	-26.02	Peak	205	34	P
5	12060.00	13.45	27.62	41.07	54.00	-12.93	Average	205	34	P
6	12060.00	13.45	40.51	53.96	74.00	-20.04	Peak	205	34	P

Note: Level=Reading+Factor
 Margin=Level-Limit
 Factor=Antenna Factor + cable loss - Amplifier Factor



Power	: AC 120V / 60Hz	Pol/Phase	: HORIZONTAL
Test Mode	: Mode 3, CH01		:

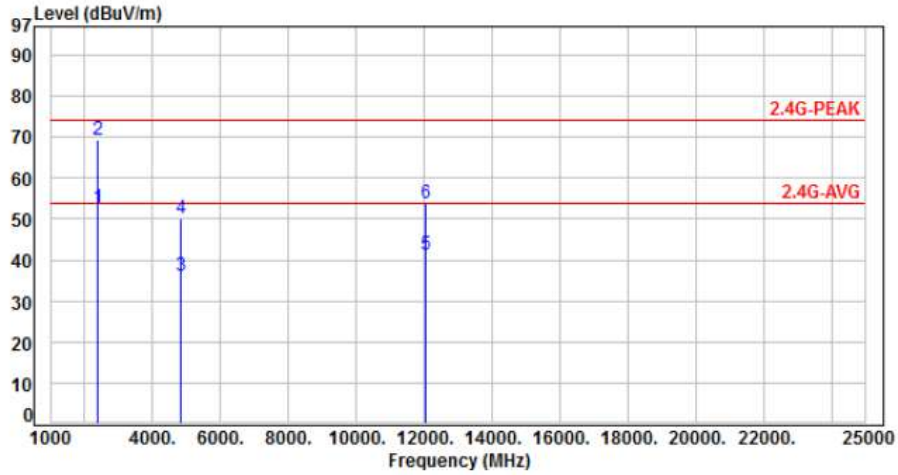

No.	Frequency (MHz)	Factor (dB)	Reading (dBuV)	Level (dBuV/m)	Limit (dBuV/m)	Margin (dB)	Detector	Height (cm)	Azimuth (deg)	P/F
1	2390.00	-3.64	56.38	52.74	54.00	-1.26	Average	232	313	P
2	2390.00	-3.64	72.90	69.26	74.00	-4.74	Peak	232	313	P
3	4824.00	3.76	32.45	36.21	54.00	-17.79	Average	100	337	P
4	4824.00	3.76	46.39	50.15	74.00	-23.85	Peak	100	337	P
5	12060.00	13.45	27.92	41.37	54.00	-12.63	Average	100	219	P
6	12060.00	13.45	40.56	54.01	74.00	-19.99	Peak	100	219	P

Note: Level=Reading+Factor
 Margin=Level-Limit
 Factor=Antenna Factor + cable loss - Amplifier Factor



Power	: AC 120V / 60Hz	Pol/Phase	: VERTICAL
Test Mode	: Mode 3, CH06		:

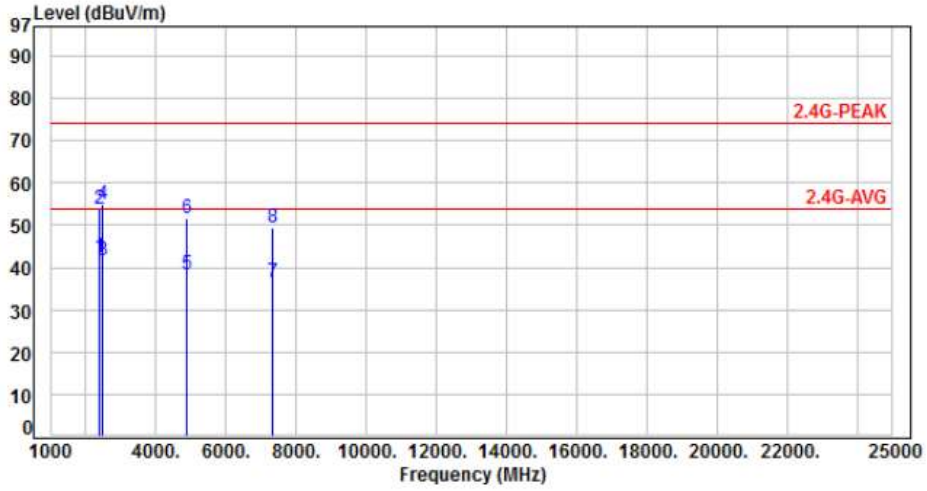

No.	Frequency (MHz)	Factor (dB)	Reading (dBuV)	Level (dBuV/m)	Limit (dBuV/m)	Margin (dB)	Detector	Height (cm)	Azimuth (deg)	P/F
1	2390.00	-3.64	46.00	42.36	54.00	-11.64	Average	395	346	P
2	2390.00	-3.64	57.64	54.00	74.00	-20.00	Peak	395	346	P
3	2483.50	-3.30	45.12	41.82	54.00	-12.18	Average	395	346	P
4	2483.50	-3.30	58.35	55.05	74.00	-18.95	Peak	395	346	P
5	4874.00	3.95	34.23	38.18	54.00	-15.82	Average	200	37	P
6	4874.00	3.95	47.64	51.59	74.00	-22.41	Peak	200	37	P
7	7311.00	8.84	27.65	36.49	54.00	-17.51	Average	100	328	P
8	7311.00	8.84	40.57	49.41	74.00	-24.59	Peak	100	328	P

Note: Level=Reading+Factor
 Margin=Level-Limit
 Factor=Antenna Factor + cable loss - Amplifier Factor



Power	: AC 120V / 60Hz	Pol/Phase	: HORIZONTAL
Test Mode	: Mode 3, CH06		:

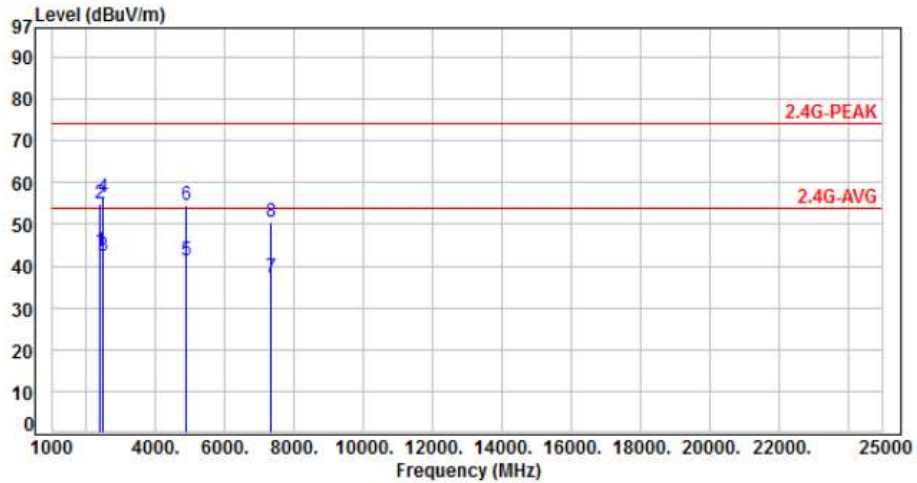

No.	Frequency (MHz)	Factor (dB)	Reading (dBuV)	Level (dBuV/m)	Limit (dBuV/m)	Margin (dB)	Detector	Height (cm)	Azimuth (deg)	P/F
1	2390.00	-3.64	47.12	43.48	54.00	-10.52	Average	221	313	P
2	2390.00	-3.64	58.75	55.11	74.00	-18.89	Peak	221	313	P
3	2483.50	-3.30	45.87	42.57	54.00	-11.43	Average	221	313	P
4	2483.50	-3.30	59.57	56.27	74.00	-17.73	Peak	221	313	P
5	4874.00	3.95	37.22	41.17	54.00	-12.83	Average	100	333	P
6	4874.00	3.95	50.62	54.57	74.00	-19.43	Peak	100	333	P
7	7311.00	8.84	28.23	37.07	54.00	-16.93	Average	100	57	P
8	7311.00	8.84	41.54	50.38	74.00	-23.62	Peak	100	57	P

Note: Level=Reading+Factor
 Margin=Level-Limit
 Factor=Antenna Factor + cable loss - Amplifier Factor



Power	: AC 120V / 60Hz	Pol/Phase	: VERTICAL
Test Mode	: Mode 3, CH11		:

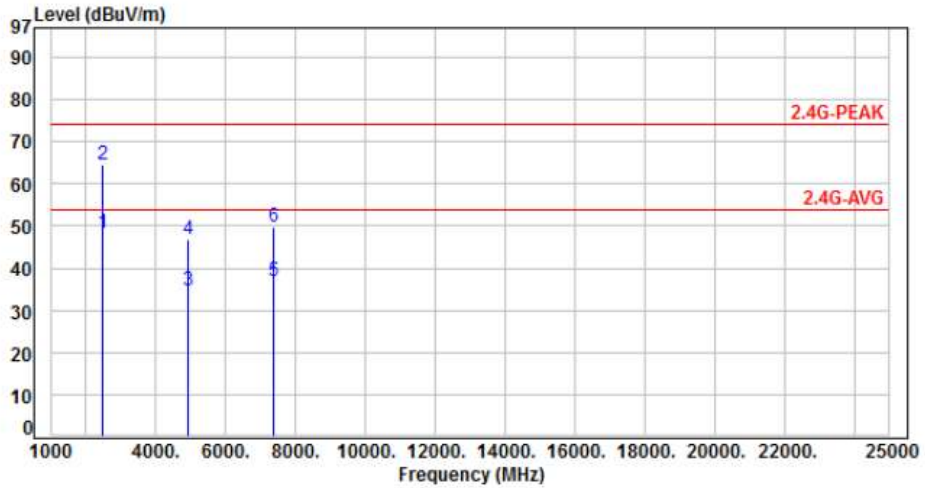

No.	Frequency (MHz)	Factor (dB)	Reading (dBuV)	Level (dBuV/m)	Limit (dBuV/m)	Margin (dB)	Detector	Height (cm)	Azimuth (deg)	P/F
1	2483.50	-3.30	51.45	48.15	54.00	-5.85	Average	382	286	P
2	2483.50	-3.30	67.67	64.37	74.00	-9.63	Peak	382	286	P
3	4924.00	4.10	30.64	34.74	54.00	-19.26	Average	202	31	P
4	4924.00	4.10	42.92	47.02	74.00	-26.98	Peak	202	31	P
5	7386.00	8.94	28.06	37.00	54.00	-17.00	Average	100	318	P
6	7386.00	8.94	40.81	49.75	74.00	-24.25	Peak	100	318	P

Note: Level=Reading+Factor
 Margin=Level-Limit
 Factor=Antenna Factor + cable loss - Amplifier Factor



Power	: AC 120V / 60Hz	Pol/Phase	: HORIZONTAL
Test Mode	: Mode 3, CH11		:

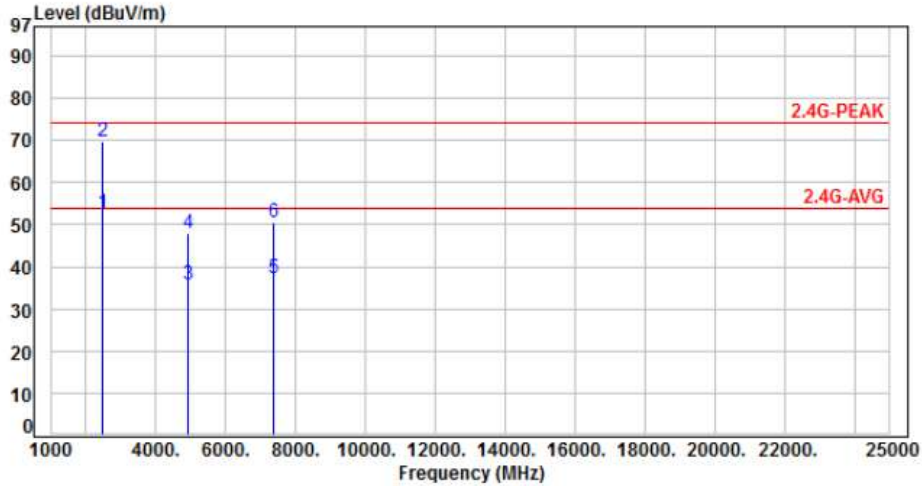

No.	Frequency (MHz)	Factor (dB)	Reading (dBuV)	Level (dBuV/m)	Limit (dBuV/m)	Margin (dB)	Detector	Height (cm)	Azimuth (deg)	P/F
1	2483.50	-3.30	56.07	52.77	54.00	-1.23	Average	160	318	P
2	2483.50	-3.30	72.84	69.54	74.00	-4.46	Peak	160	318	P
3	4924.00	4.10	31.85	35.95	54.00	-18.05	Average	100	335	P
4	4924.00	4.10	43.88	47.98	74.00	-26.02	Peak	100	335	P
5	7386.00	8.94	28.46	37.40	54.00	-16.60	Average	100	61	P
6	7386.00	8.94	41.76	50.70	74.00	-23.30	Peak	100	61	P

Note: Level=Reading+Factor
 Margin=Level-Limit
 Factor=Antenna Factor + cable loss - Amplifier Factor



Power	: AC 120V / 60Hz	Pol/Phase	: VERTICAL
Test Mode	: Mode 4, CH03		:

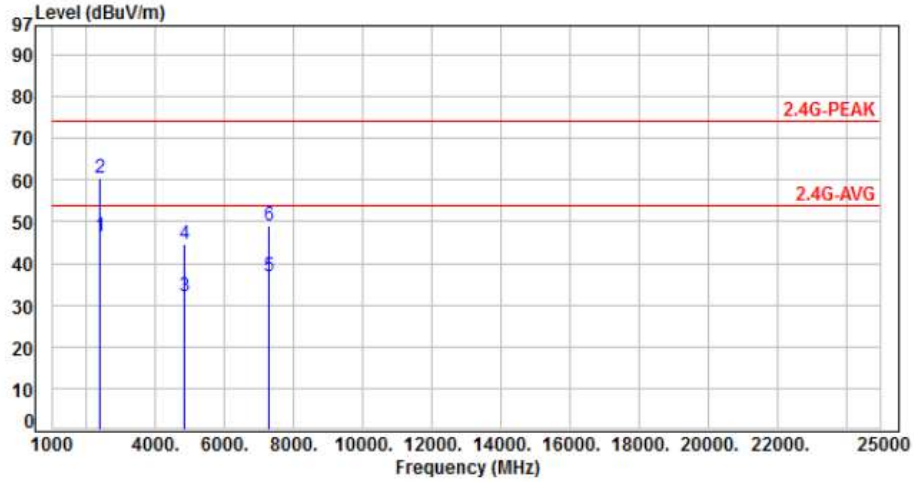

No.	Frequency (MHz)	Factor (dB)	Reading (dBuV)	Level (dBuV/m)	Limit (dBuV/m)	Margin (dB)	Detector	Height (cm)	Azimuth (deg)	P/F
1	2390.00	-3.64	50.22	46.58	54.00	-7.42	Average	393	342	P
2	2390.00	-3.64	64.02	60.38	74.00	-13.62	Peak	393	342	P
3	4844.00	3.85	28.34	32.19	54.00	-21.81	Average	192	46	P
4	4844.00	3.85	40.63	44.48	74.00	-29.52	Peak	192	46	P
5	7266.00	8.62	28.38	37.00	54.00	-17.00	Average	100	313	P
6	7266.00	8.62	40.57	49.19	74.00	-24.81	Peak	100	313	P

Note: Level=Reading+Factor
 Margin=Level-Limit
 Factor=Antenna Factor + cable loss - Amplifier Factor



Power	: AC 120V / 60Hz	Pol/Phase	: HORIZONTAL
Test Mode	: Mode 4, CH03		:

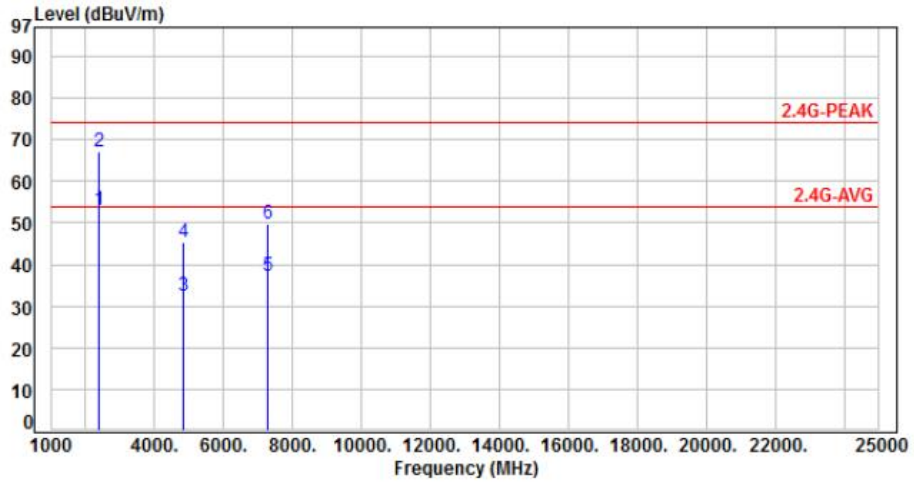

No.	Frequency (MHz)	Factor (dB)	Reading (dBuV)	Level (dBuV/m)	Limit (dBuV/m)	Margin (dB)	Detector	Height (cm)	Azimuth (deg)	P/F
1	2390.00	-3.64	56.62	52.98	54.00	-1.02	Average	237	308	P
2	2390.00	-3.64	70.90	67.26	74.00	-6.74	Peak	237	308	P
3	4844.00	3.85	28.75	32.60	54.00	-21.40	Average	100	332	P
4	4844.00	3.85	41.69	45.54	74.00	-28.46	Peak	100	332	P
5	7266.00	8.62	28.52	37.14	54.00	-16.86	Average	100	63	P
6	7266.00	8.62	41.34	49.96	74.00	-24.04	Peak	100	63	P

Note: Level=Reading+Factor
 Margin=Level-Limit
 Factor=Antenna Factor + cable loss - Amplifier Factor



Power	: AC 120V / 60Hz	Pol/Phase	: VERTICAL
Test Mode	: Mode 4, CH06		:

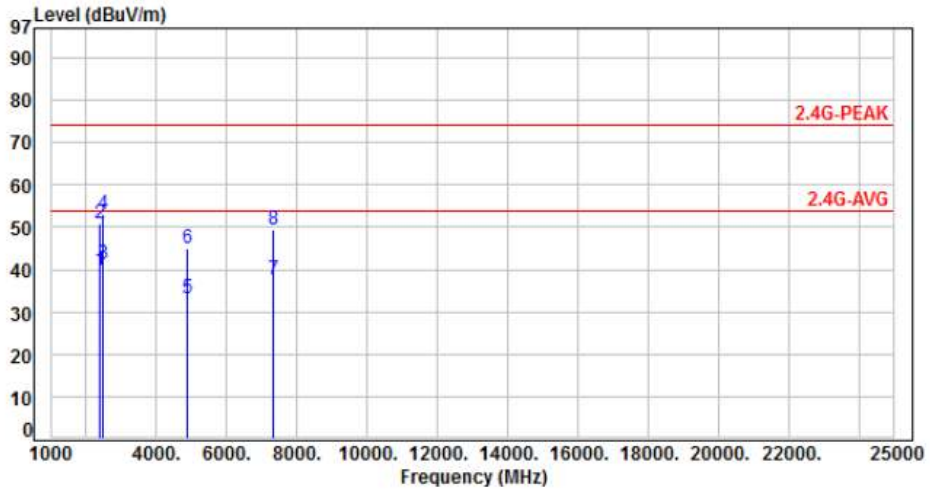

No.	Frequency (MHz)	Factor (dB)	Reading (dBuV)	Level (dBuV/m)	Limit (dBuV/m)	Margin (dB)	Detector	Height (cm)	Azimuth (deg)	P/F
1	2390.00	-3.64	43.45	39.81	54.00	-14.19	Average	378	320	P
2	2390.00	-3.64	54.40	50.76	74.00	-23.24	Peak	378	320	P
3	2483.50	-3.30	44.59	41.29	54.00	-12.71	Average	378	320	P
4	2483.50	-3.30	56.44	53.14	74.00	-20.86	Peak	378	320	P
5	4874.00	3.95	29.13	33.08	54.00	-20.92	Average	185	42	P
6	4874.00	3.95	40.88	44.83	74.00	-29.17	Peak	185	42	P
7	7311.00	8.84	28.69	37.53	54.00	-16.47	Average	100	316	P
8	7311.00	8.84	40.44	49.28	74.00	-24.72	Peak	100	316	P

Note: Level=Reading+Factor
 Margin=Level-Limit
 Factor=Antenna Factor + cable loss - Amplifier Factor



Power	: AC 120V / 60Hz	Pol/Phase	: HORIZONTAL
Test Mode	: Mode 4, CH06		:

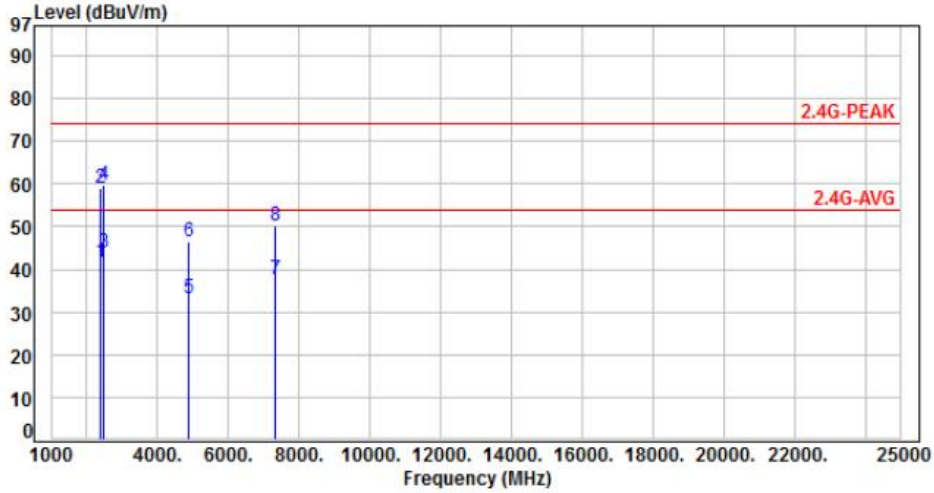

No.	Frequency (MHz)	Factor (dB)	Reading (dBUV)	Level (dBUV/m)	Limit (dBUV/m)	Margin (dB)	Detector	Height (cm)	Azimuth (deg)	P/F
1	2390.00	-3.64	45.36	41.72	54.00	-12.28	Average	237	307	P
2	2390.00	-3.64	62.50	58.86	74.00	-15.14	Peak	237	307	P
3	2483.50	-3.30	47.06	43.76	54.00	-10.24	Average	237	307	P
4	2483.50	-3.30	62.95	59.65	74.00	-14.35	Peak	237	307	P
5	4874.00	3.95	29.25	33.20	54.00	-20.80	Average	100	331	P
6	4874.00	3.95	42.52	46.47	74.00	-27.53	Peak	100	331	P
7	7311.00	8.84	28.91	37.75	54.00	-16.25	Average	100	65	P
8	7311.00	8.84	41.22	50.06	74.00	-23.94	Peak	100	65	P

Note: Level=Reading+Factor
 Margin=Level-Limit
 Factor=Antenna Factor + cable loss - Amplifier Factor



Power	: AC 120V / 60Hz	Pol/Phase	: VERTICAL
Test Mode	: Mode 4, CH09		:

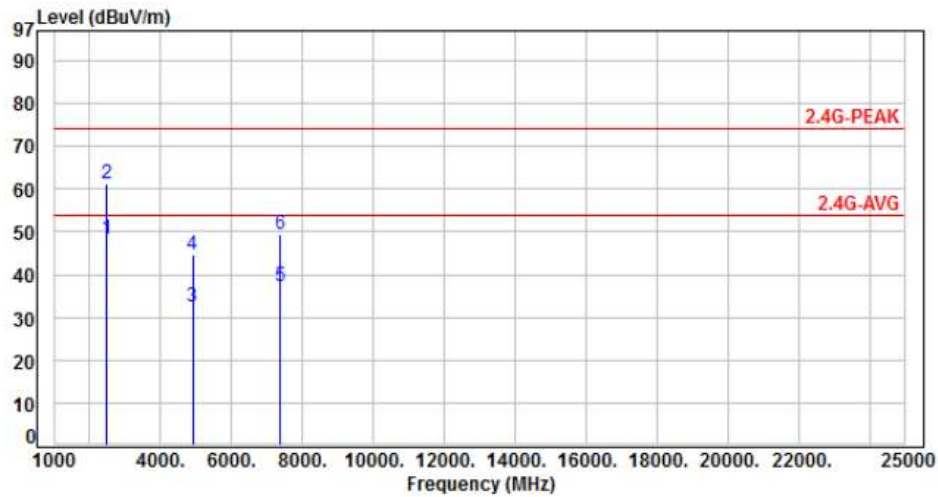

No.	Frequency (MHz)	Factor (dB)	Reading (dBuV)	Level (dBuV/m)	Limit (dBuV/m)	Margin (dB)	Detector	Height (cm)	Azimuth (deg)	P/F
1	2483.50	-3.30	51.51	48.21	54.00	-5.79	Average	387	278	P
2	2483.50	-3.30	64.46	61.16	74.00	-12.84	Peak	387	278	P
3	4904.00	4.05	28.45	32.50	54.00	-21.50	Average	191	48	P
4	4904.00	4.05	40.58	44.63	74.00	-29.37	Peak	191	48	P
5	7356.00	8.86	28.37	37.23	54.00	-16.77	Average	100	315	P
6	7356.00	8.86	40.58	49.44	74.00	-24.56	Peak	100	315	P

Note: Level=Reading+Factor
 Margin=Level-Limit
 Factor=Antenna Factor + cable loss - Amplifier Factor



Power	: AC 120V / 60Hz	Pol/Phase	: HORIZONTAL
Test Mode	: Mode 4, CH09		:

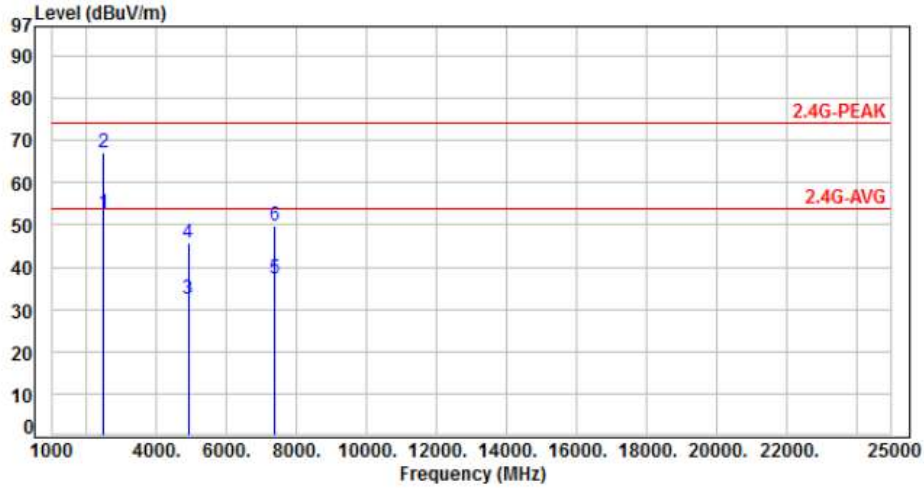

No.	Frequency (MHz)	Factor (dB)	Reading (dBuV)	Level (dBuV/m)	Limit (dBuV/m)	Margin (dB)	Detector	Height (cm)	Azimuth (deg)	P/F
1	2483.50	-3.30	56.08	52.78	54.00	-1.22	Average	162	320	P
2	2483.50	-3.30	70.47	67.17	74.00	-6.83	Peak	162	320	P
3	4904.00	4.05	28.51	32.56	54.00	-21.44	Average	100	331	P
4	4904.00	4.05	41.64	45.69	74.00	-28.31	Peak	100	331	P
5	7356.00	8.86	28.41	37.27	54.00	-16.73	Average	100	71	P
6	7356.00	8.86	40.98	49.84	74.00	-24.16	Peak	100	71	P

Note: Level=Reading+Factor
 Margin=Level-Limit
 Factor=Antenna Factor + cable loss - Amplifier Factor



6.7 Restricted Bands of Operation

Only spurious emissions are permitted in any of the frequency bands listed below:

MHz	MHz	MHz	GHz
0.09000 – 0.11000	16.42000 – 16.42300	399.9 – 410.0	4.500 – 5.250
0.49500 – 0.505**	16.69475 – 16.69525	608.0 – 614.0	5.350 – 5.460
2.17350 – 2.19050	16.80425 – 16.80475	960.0 – 1240.0	7.250 – 7.750
4.12500 – 4.12800	25.50000 – 25.67000	1300.0 – 1427.0	8.025 – 8.500
4.17725 – 4.17775	37.50000 – 38.25000	1435.0 – 1626.5	9.000 – 9.200
4.20725 – 4.20775	73.00000 – 74.60000	1645.5 – 1646.5	9.300 – 9.500
6.21500 – 6.21800	74.80000 – 75.20000	1660.0 – 1710.0	10.600 – 12.700
6.26775 – 6.26825	108.00000 – 121.94000	1718.8 – 1722.2	13.250 – 13.400
6.31175 – 6.31225	123.00000 – 138.00000	2200.0 – 2300.0	14.470 – 14.500
8.29100 – 8.29400	149.90000 – 150.05000	2310.0 – 2390.0	15.350 – 16.200
8.36200 – 8.36600	156.52475 – 156.52525	2483.5 – 2500.0	17.700 – 21.400
8.37625 – 8.38675	156.70000 – 156.90000	2655.0 – 2900.0	22.010 – 23.120
8.41425 – 8.41475	162.01250 – 167.17000	3260.0 – 3267.0	23.600 – 24.000
12.29000 – 12.29300	167.72000 – 173.20000	3332.0 – 3339.0	31.200 – 31.800
12.51975 – 12.52025	240.00000 – 285.00000	3345.8 – 3358.0	36.430 – 36.500
12.57675 – 12.57725	322.00000 – 335.40000	3600.0 – 4400.0	Above 38.6
13.36000 – 13.41000			

** : Until February 1, 1999, this restricted band shall be 0.490-0.510 MHz



7. Test of Conducted Spurious Emission

7.1 Test Limit

Below -20dB of the highest emission level of operating band (In 100 kHz Resolution Bandwidth)

7.2 Test Procedure

- a. The transmitter output was connected to the spectrum analyzer via a low loss cable.
- b. Set RBW of spectrum analyzer to 100 KHz and VBW of spectrum analyzer to 300 KHz with convenient frequency span including 100 KHz bandwidth from band edge.
- c. Peak conducted output power measured within any 100 kHz outside the authorized frequency band shall be attenuated by at least 20dB relative to the maximum measured in-band peak PSD level.
- d. The band edges was measured and recorded.

7.3 Test Setup Layout

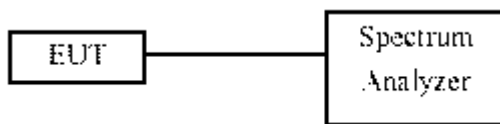

7.4 Test Result and Data

Note: Test plots refers to the following pages.



ANT A

Modulation Type: 802.11b, CH 01

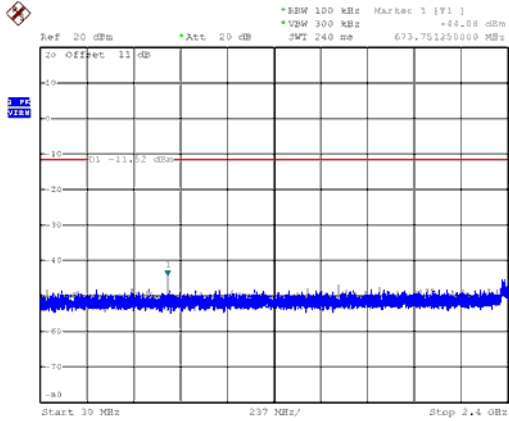

Modulation Type: 802.11b, CH 06

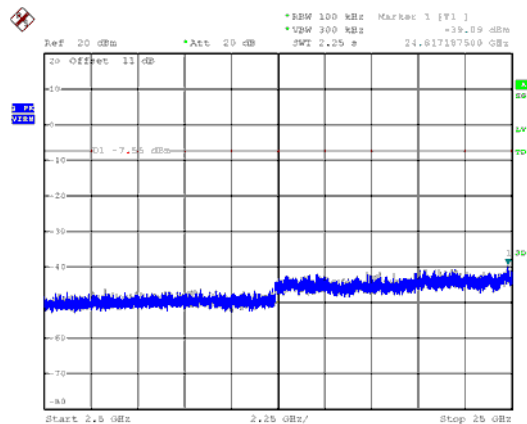
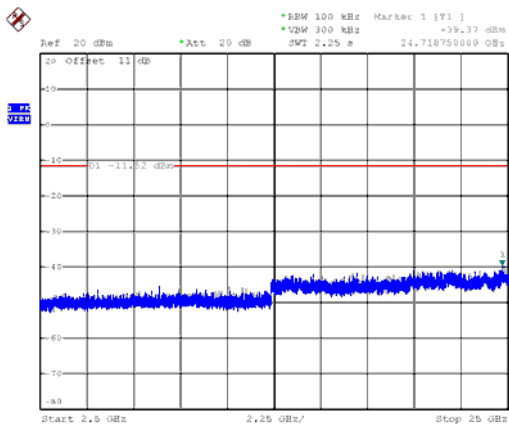
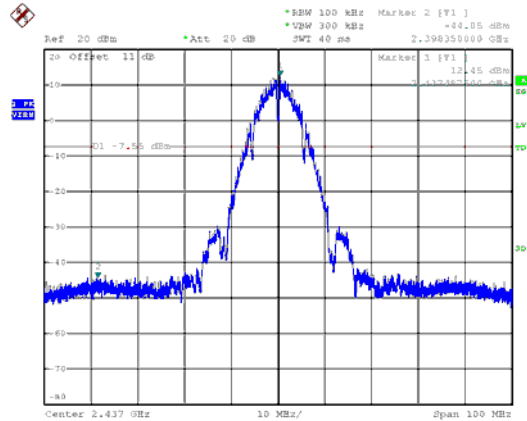
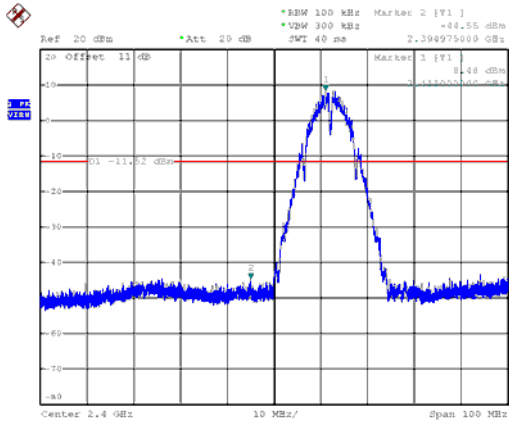
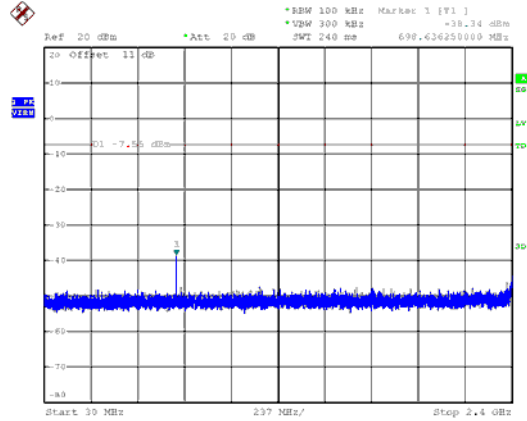



ANT A

Modulation Type: 802.11b, CH 11

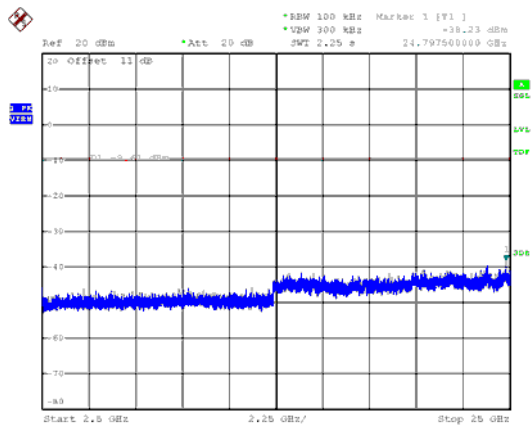
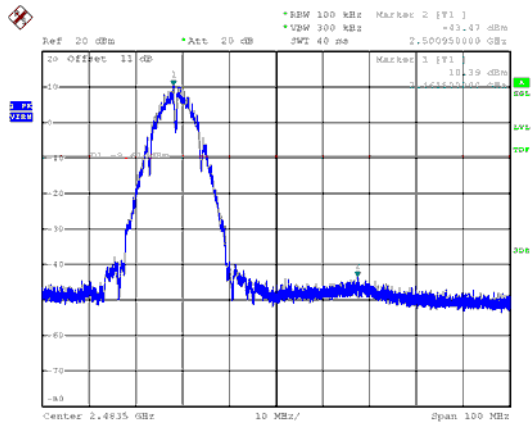
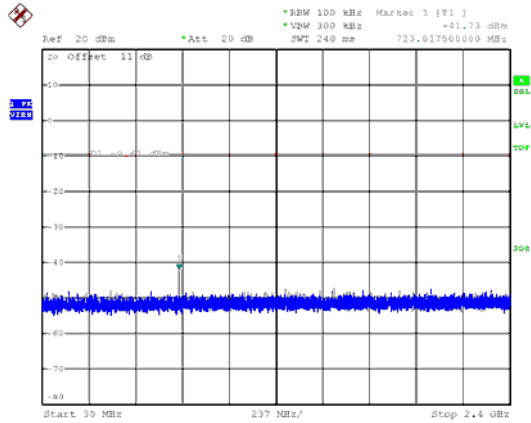



ANT A

Modulation Type: 802.11g, CH 01

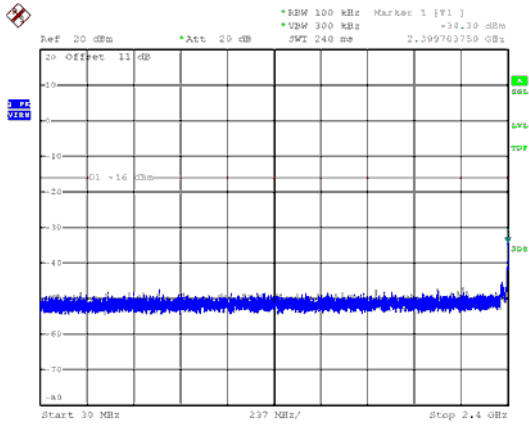

Modulation Type: 802.11g, CH 06

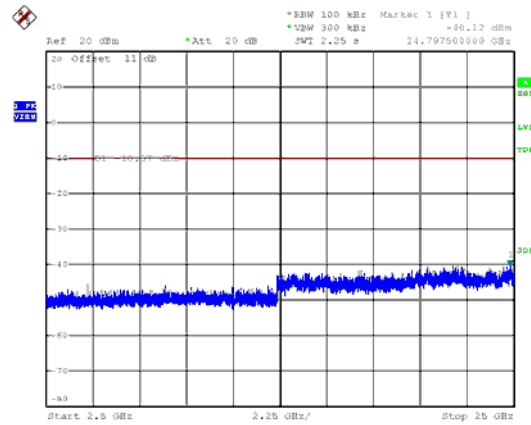
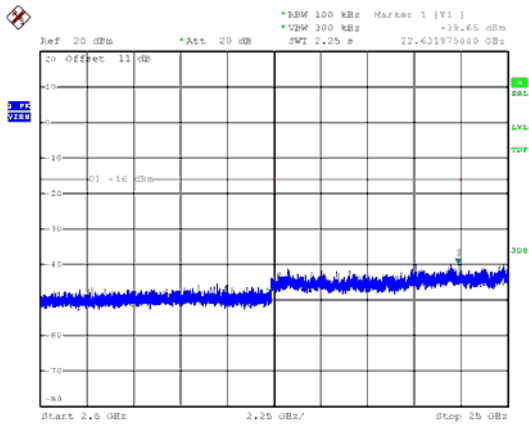
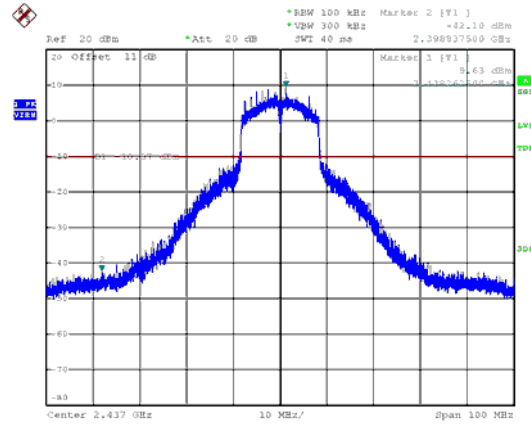
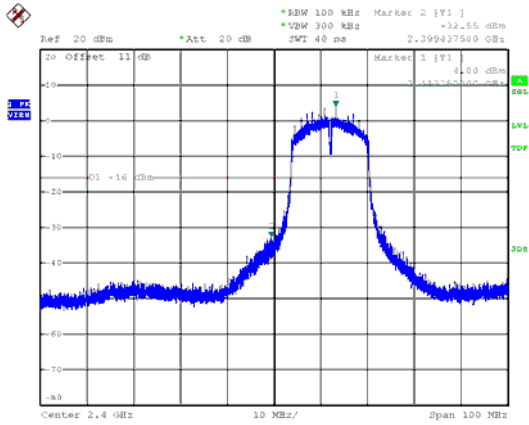
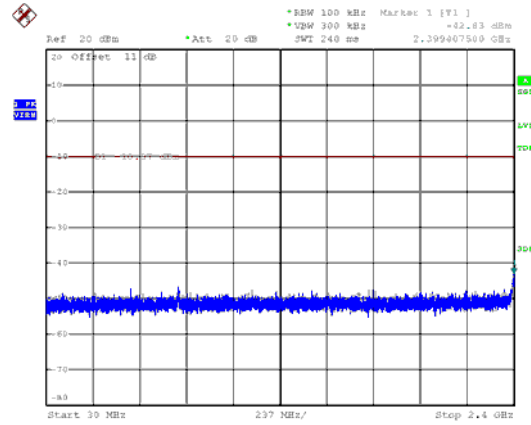



ANT A

Modulation Type: 802.11g, CH 11

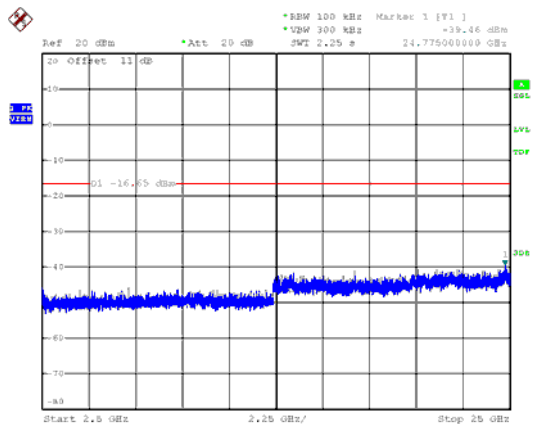
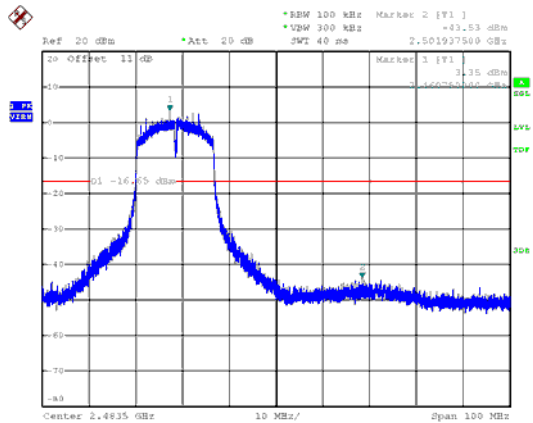
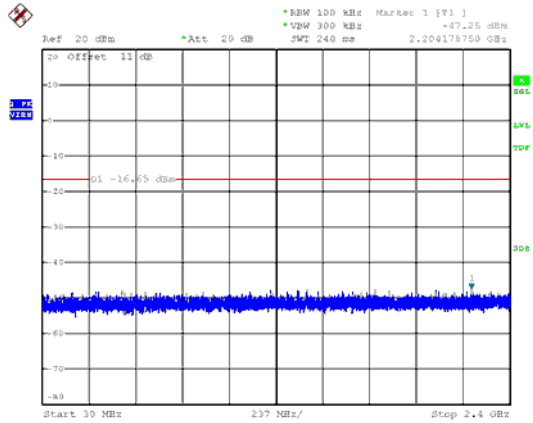



ANT A

Modulation Type: 802.11n HT20, CH01

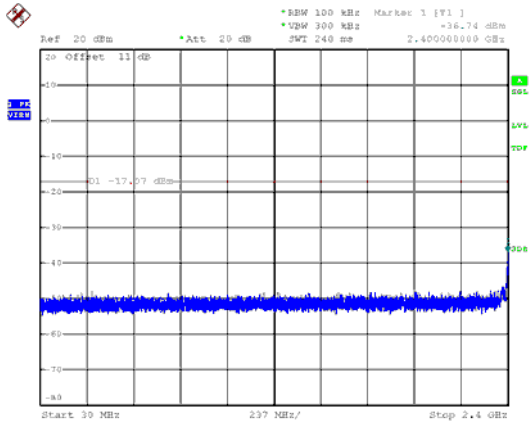

Modulation Type: 802.11n HT20, CH06

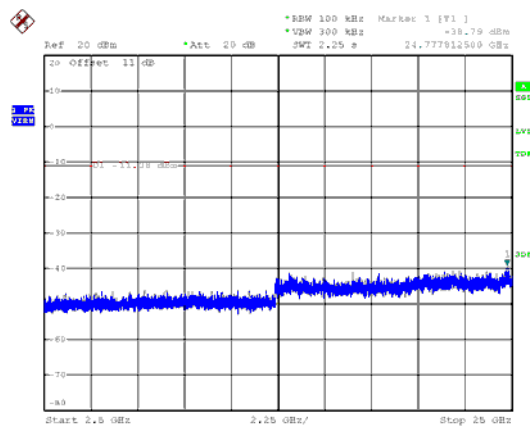
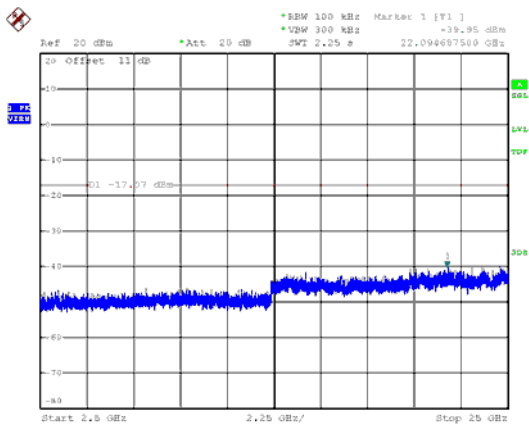
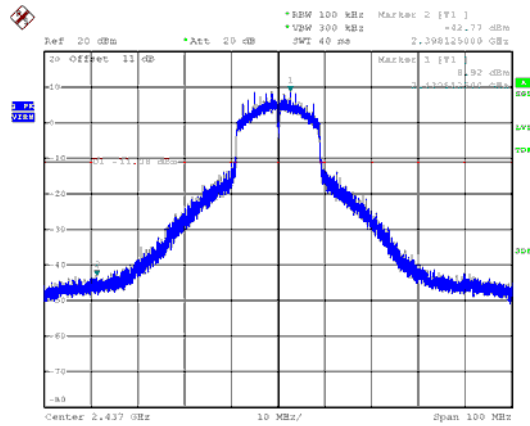
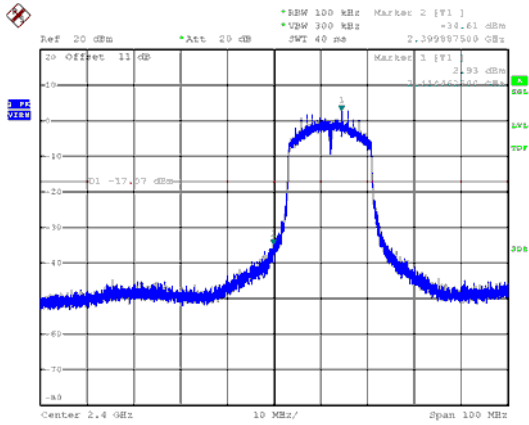
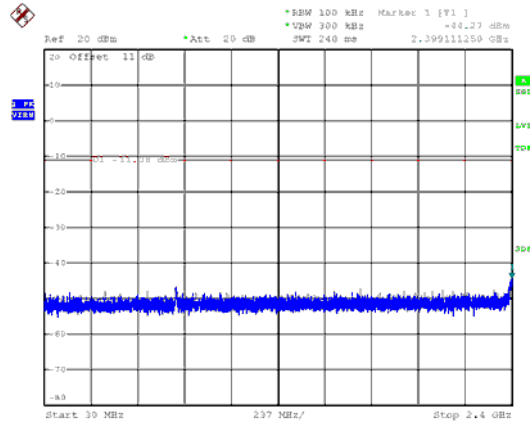



ANT A

Modulation Type: 802.11n HT20, CH11

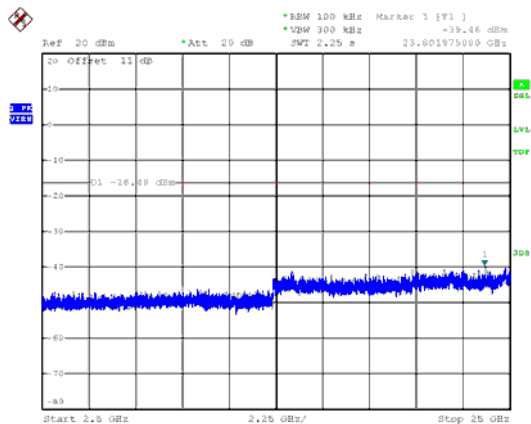
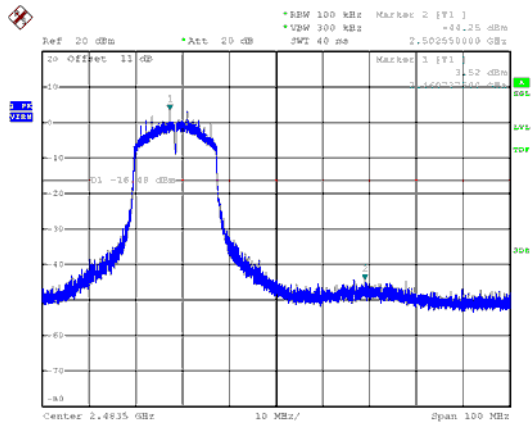
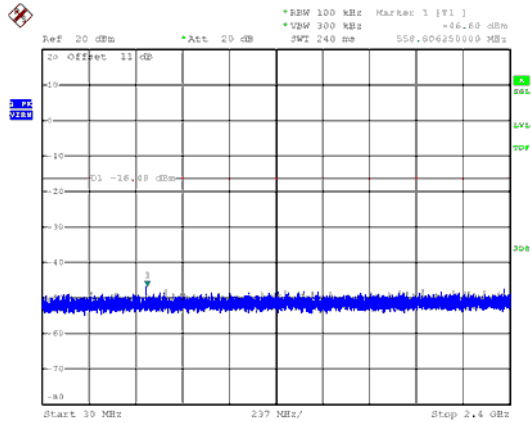



ANT A

Modulation Type: 802.11n HT40, CH03

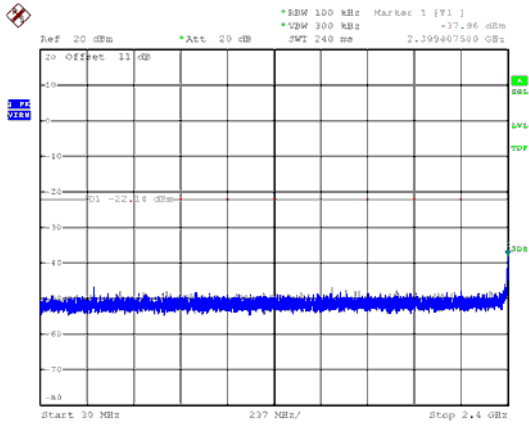

Modulation Type: 802.11n HT40, CH06

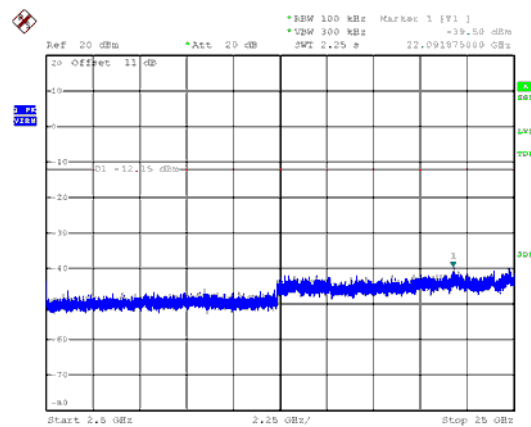
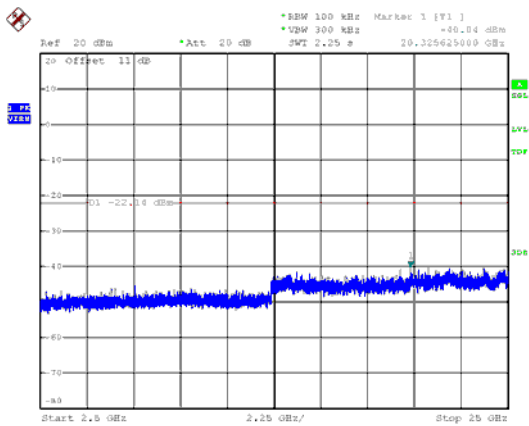
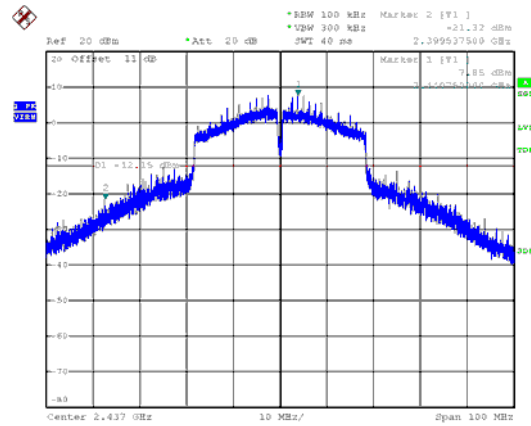
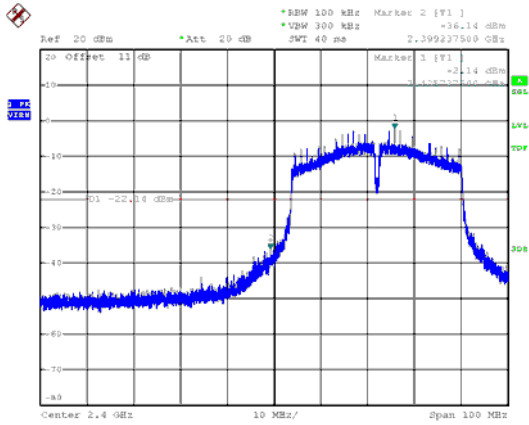
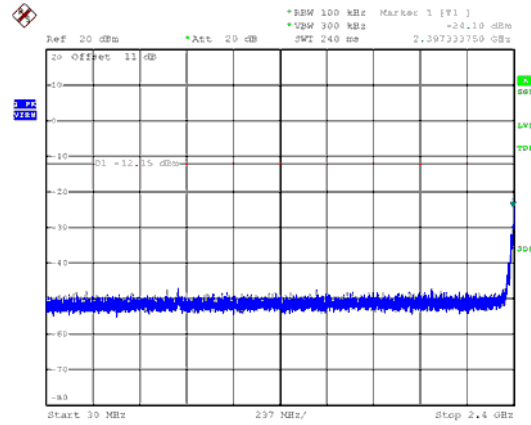



ANT A

Modulation Type: 802.11n HT40, CH09

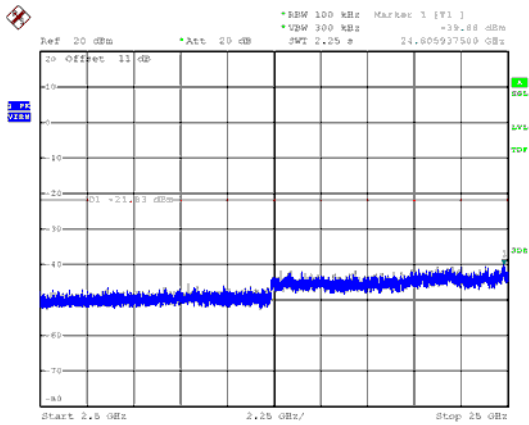
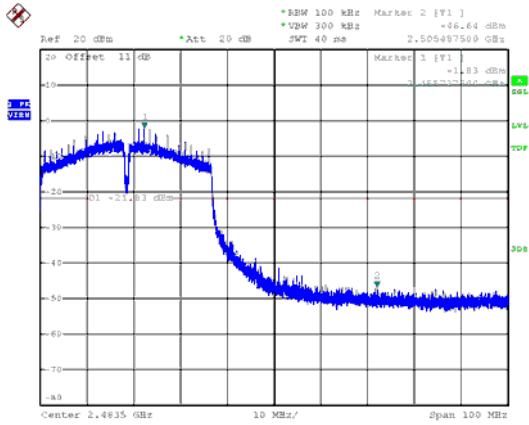
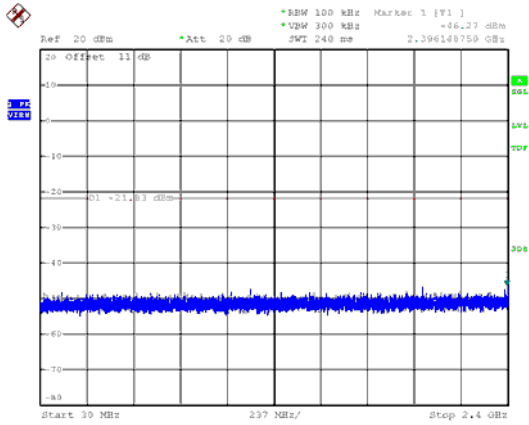



ANT B

Modulation Type: 802.11b, CH 01

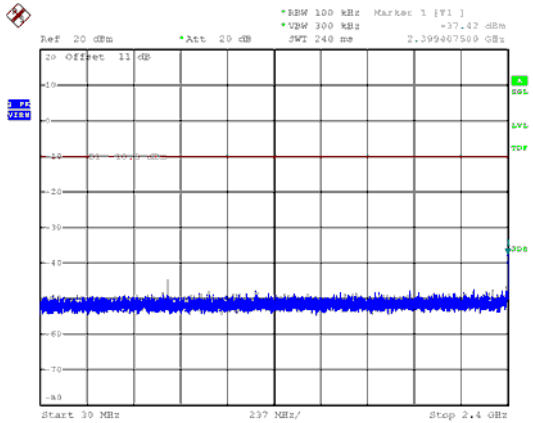

Modulation Type: 802.11b, CH 06

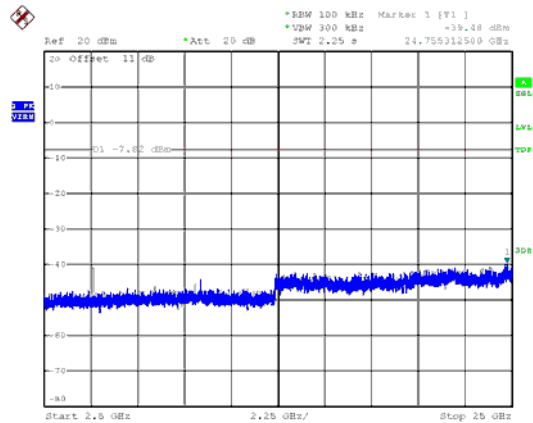
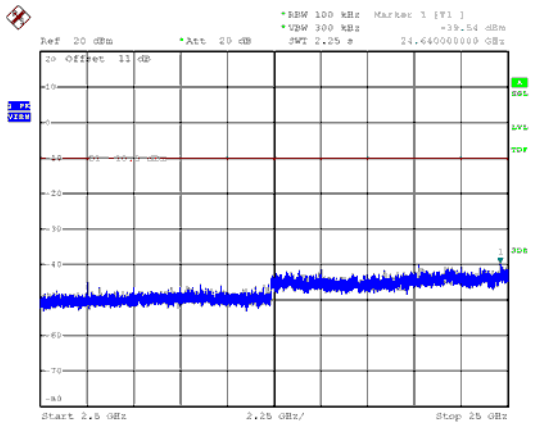
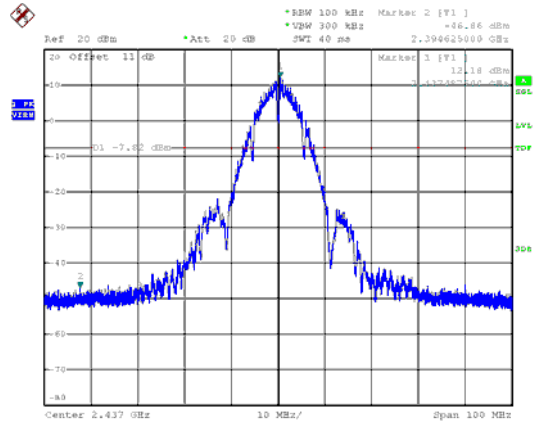
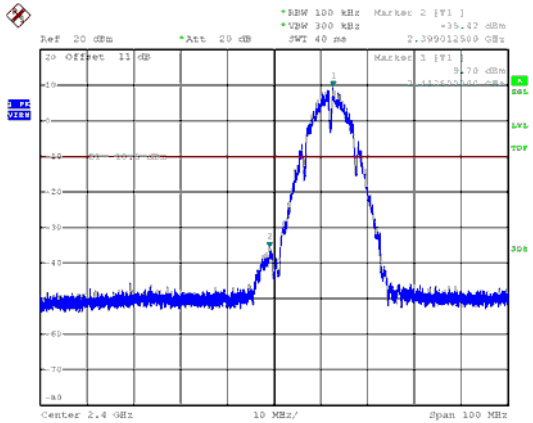
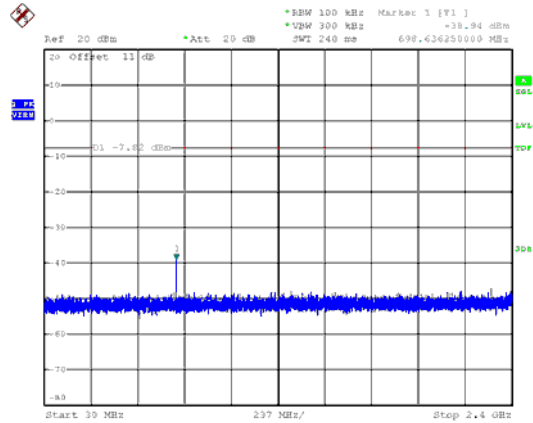



ANT B

Modulation Type: 802.11b, CH 11

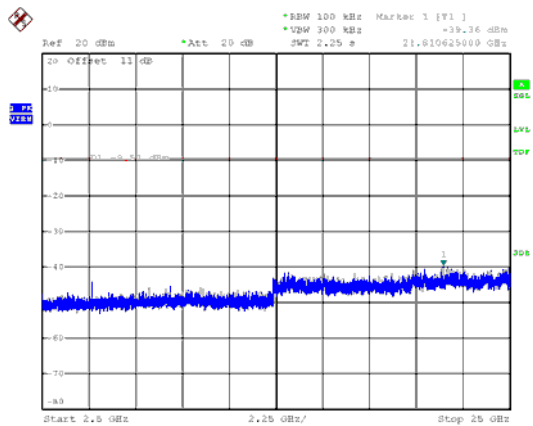
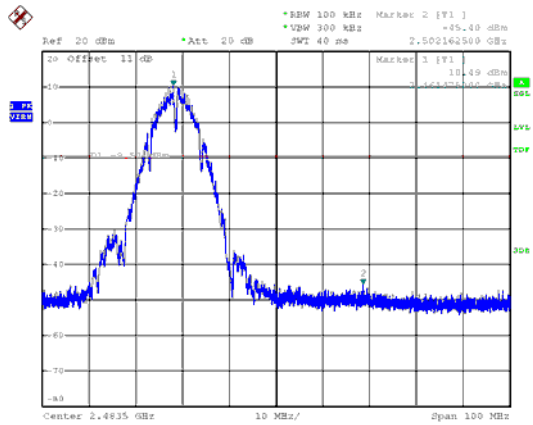
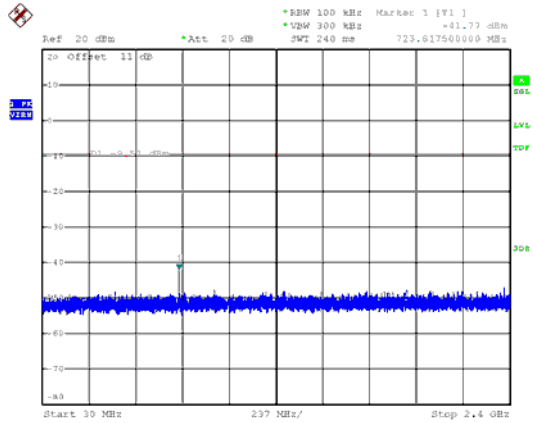



ANT B

Modulation Type: 802.11g, CH 01

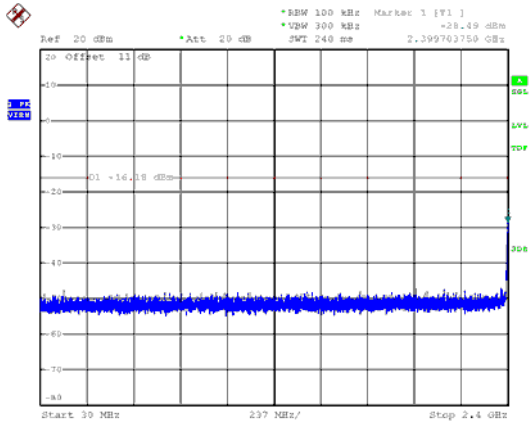

Modulation Type: 802.11g, CH 06

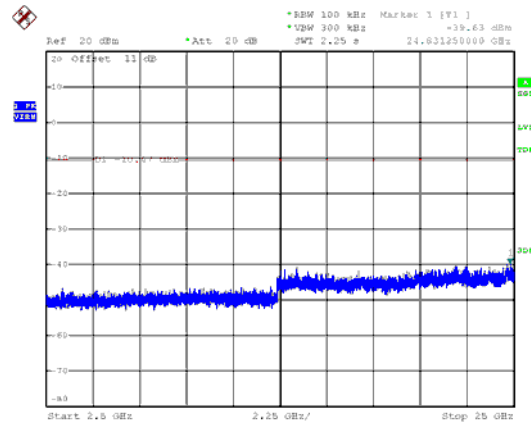
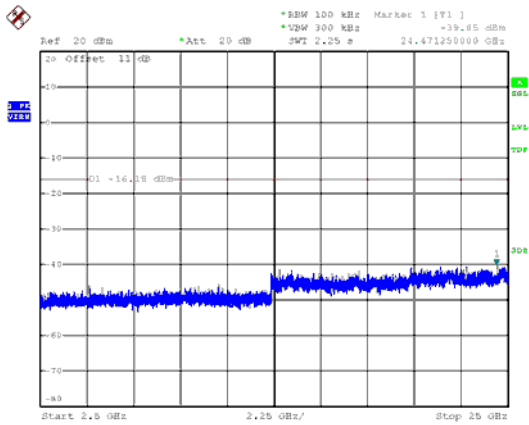
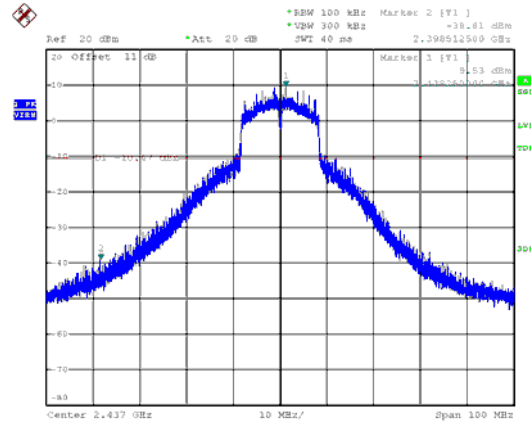
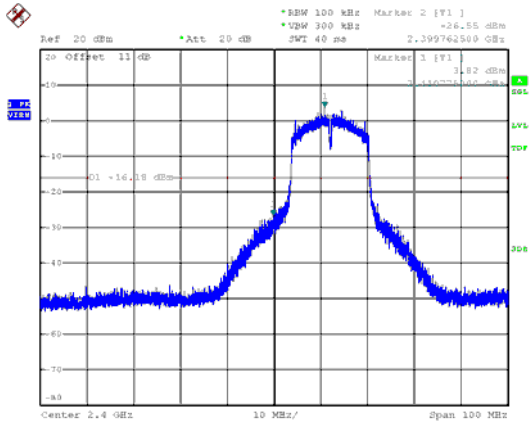
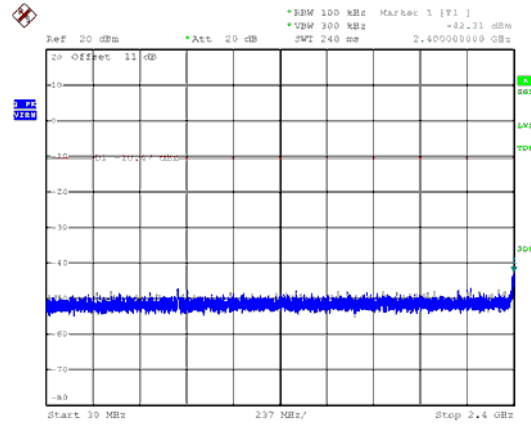



ANT B

Modulation Type: 802.11g, CH 11

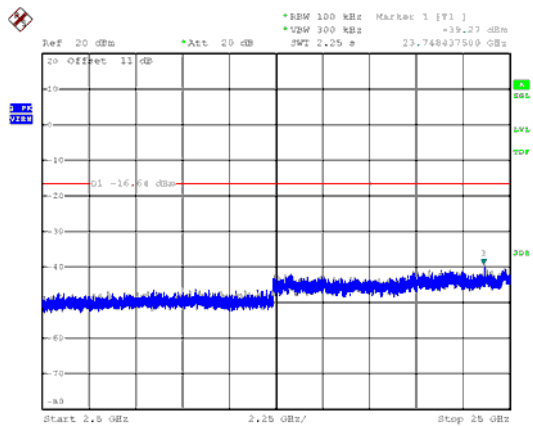
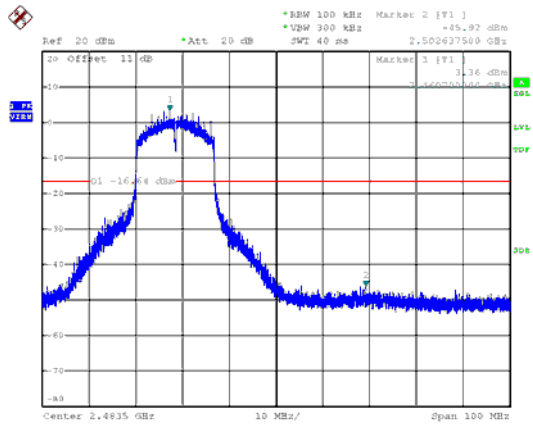
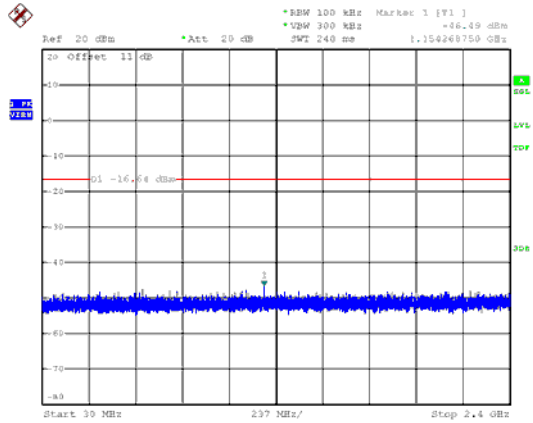



ANT B

Modulation Type: 802.11n HT20, CH01

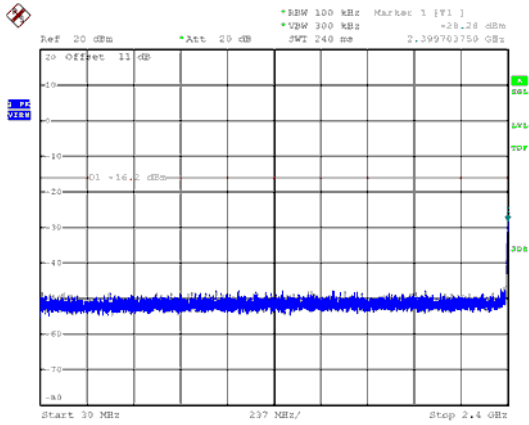

Modulation Type: 802.11n HT20, CH06

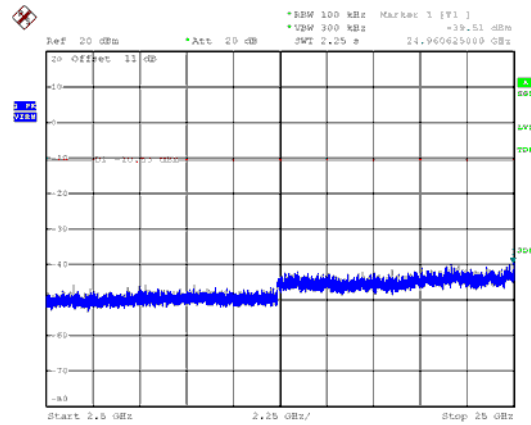
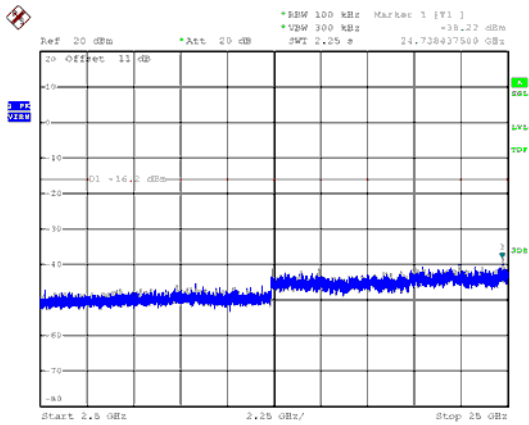
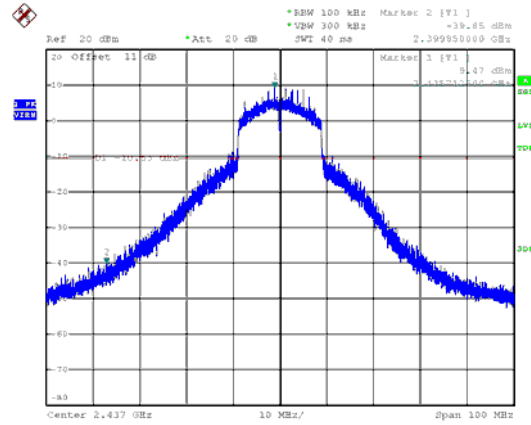
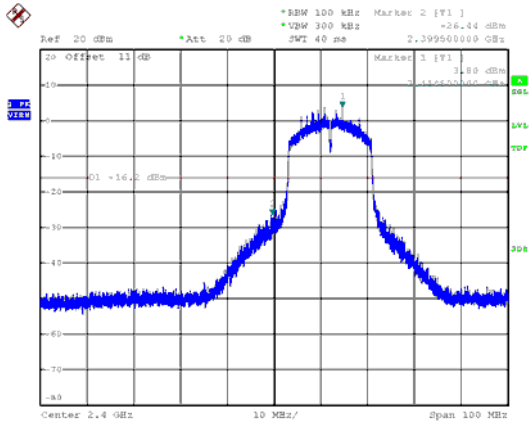
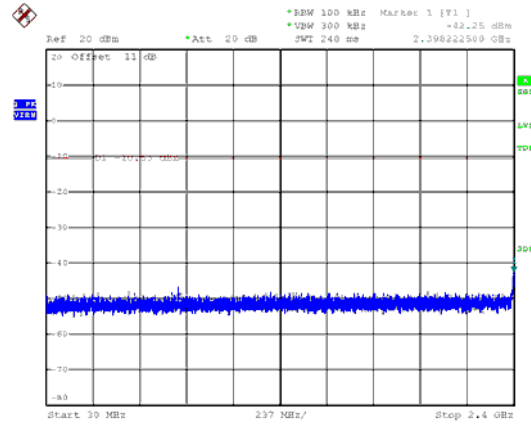



ANT B

Modulation Type: 802.11n HT20, CH11

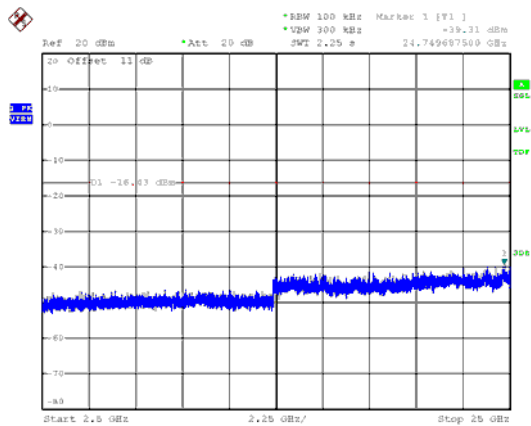
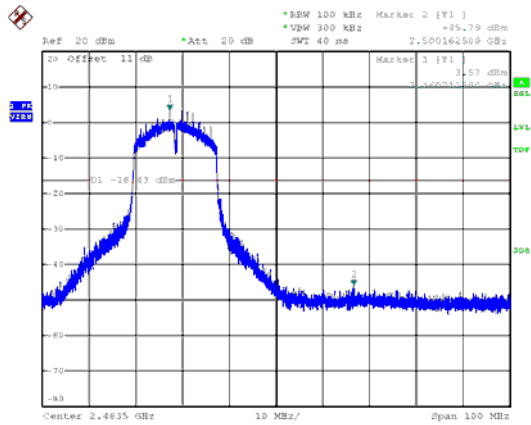
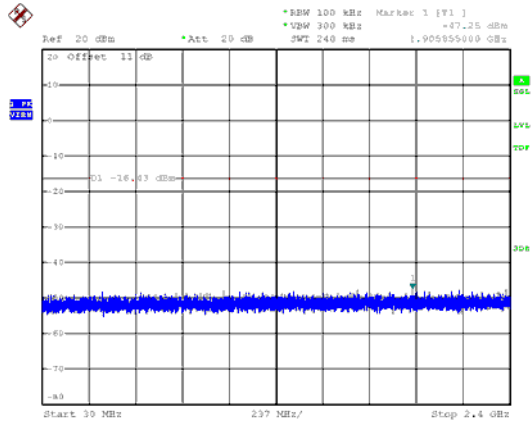



ANT B

Modulation Type: 802.11n HT40, CH03

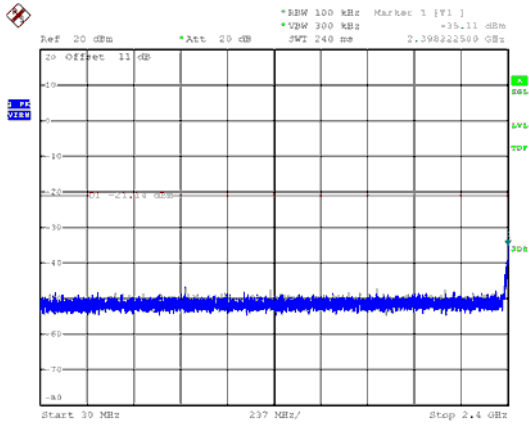

Modulation Type: 802.11n HT40, CH06

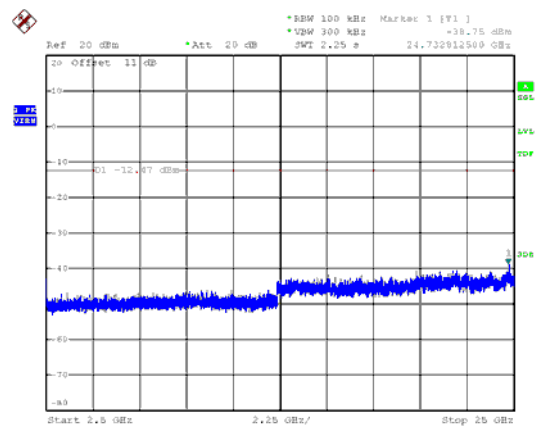
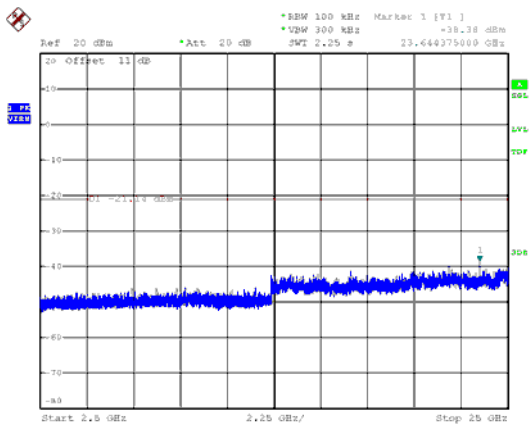
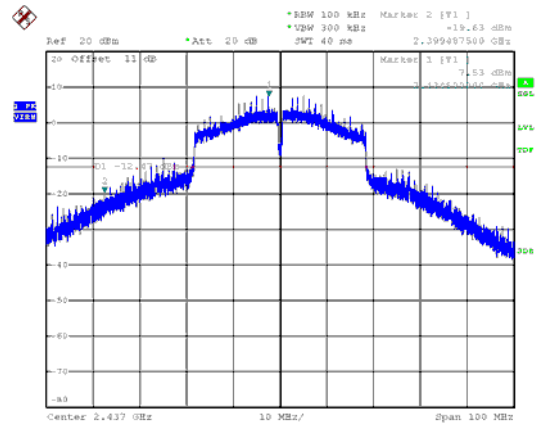
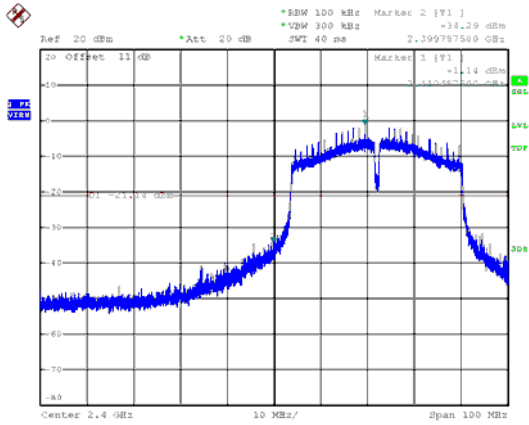
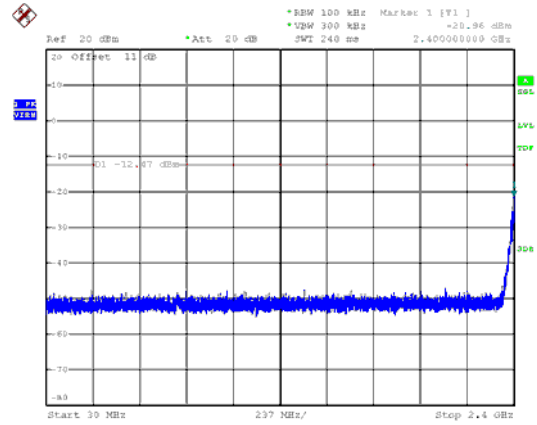



ANT B

Modulation Type: 802.11n HT40, CH09

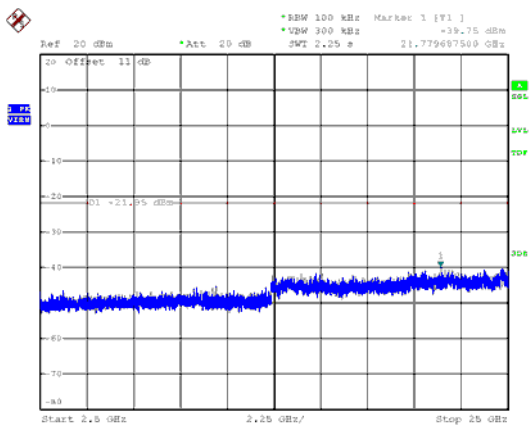
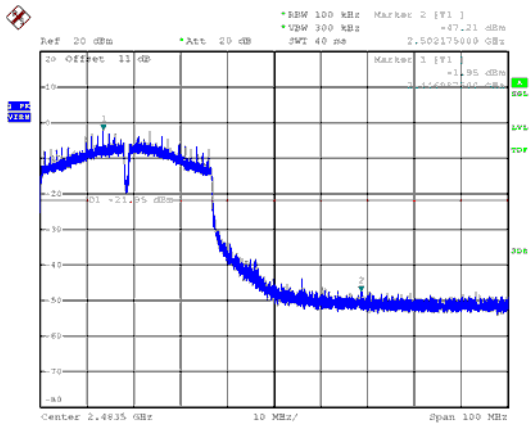
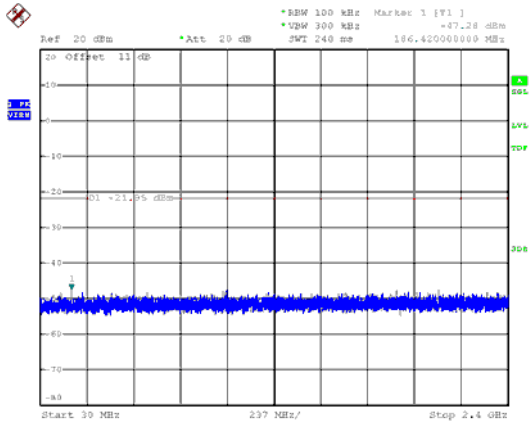



8. On Time, Duty Cycle and Measurement methods

8.1 Test Limit

None; for reporting purposes only.

8.2 Test Procedure

Zero-Span Spectrum Analyzer Method.

8.3 Test Setup Layout

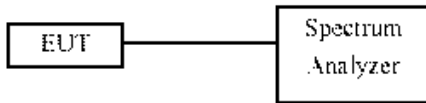

8.4 Test Result and Data

Modulation Type	On Time (ms)	Period Time (ms)	Duty Cycle (%)
11b,1M	100.00	100.00	100.00%
11g,6M	2.04	2.08	98.33%
11n HT20	1.90	1.94	98.21%
11n HT40	0.93	0.97	96.85%



Modulation Type: 802.11b (1Mbps)

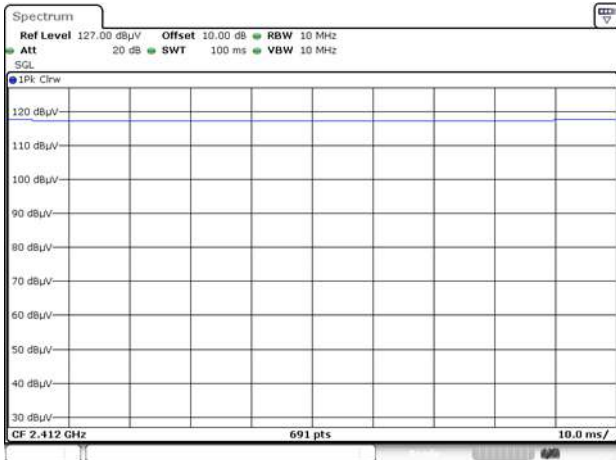

Modulation Type: 802.11g (6Mbps)

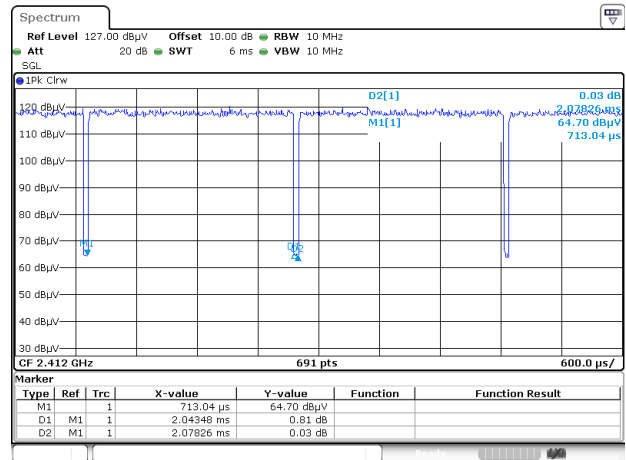

Modulation Type: 802.11n HT20 (6.5Mbps)

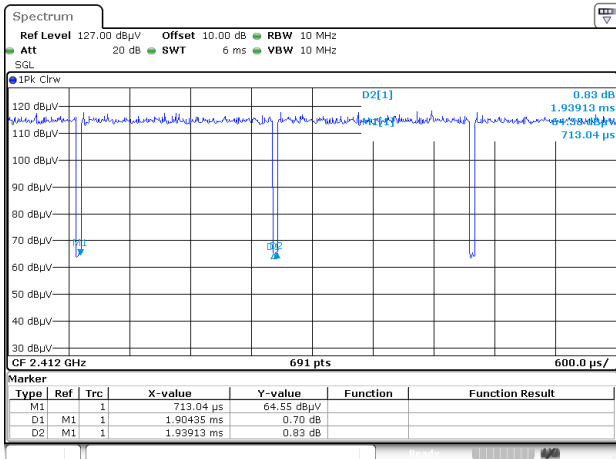

Modulation Type: 802.11n HT40 (13.5Mbps)

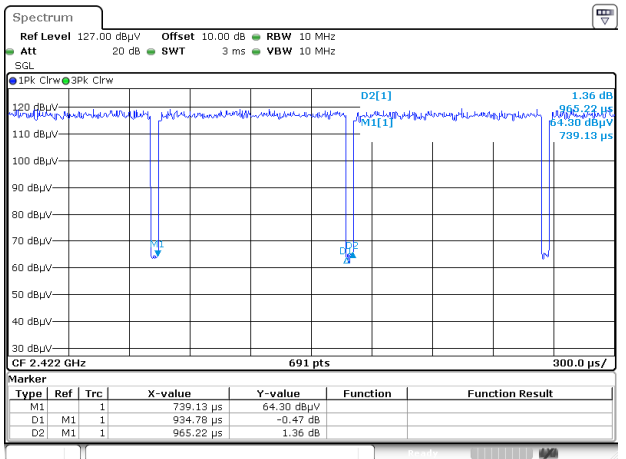



9. 6dB Bandwidth Measurement Data

9.1 Test Limit

The minimum of 6dB Bandwidth Measurement is 0.5 MHz.

9.2 Test Procedures

- a. The transmitter output was connected to the spectrum analyzer.
- b. Set RBW of spectrum analyzer to 100 KHz and VBW to 300 KHz.
- c. The 6 dB bandwidth is defined as the total spectrum the power of which is higher than peak power minus 6 dB.
- d. The 6dB Bandwidth was measured and recorded.

9.3 Test Setup Layout

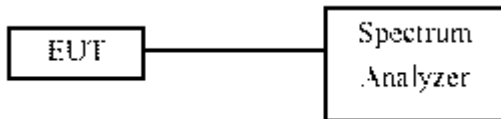

9.4 Test Result and Data

Modulation Type	Channel	Frequency (MHz)	6dB Bandwidth (MHz)		Limit (MHz)
			ANT A	ANT B	
11b	1	2412	7.00	7.10	0.5
	6	2437	7.05	7.05	0.5
	11	2462	6.55	7.00	0.5
11g	1	2412	15.06	13.80	0.5
	6	2437	15.10	15.05	0.5
	11	2462	15.10	14.40	0.5
11n HT20	1	2412	14.10	15.00	0.5
	6	2437	15.10	13.90	0.5
	11	2462	15.05	13.90	0.5
11n HT40	3	2422	35.10	35.00	0.5
	6	2437	30.00	25.10	0.5
	9	2452	33.80	32.50	0.5



ANT A

Modulation Type: 802.11b
CH01

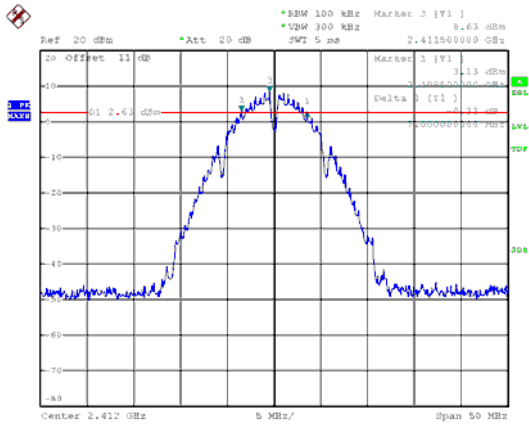

Modulation Type: 802.11g
CH01

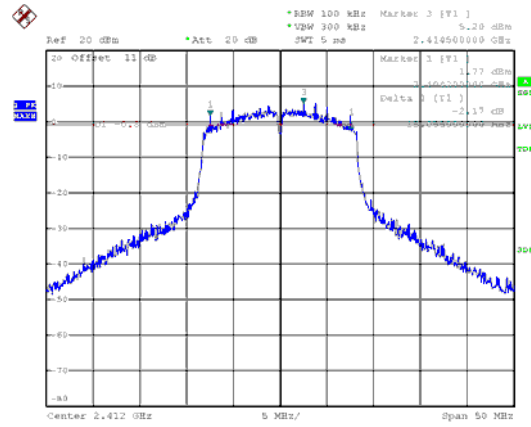

CH06

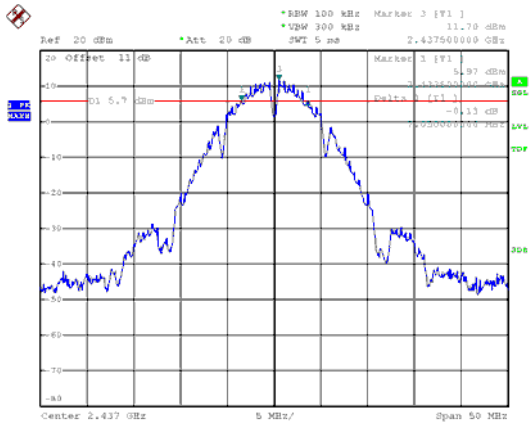

CH06

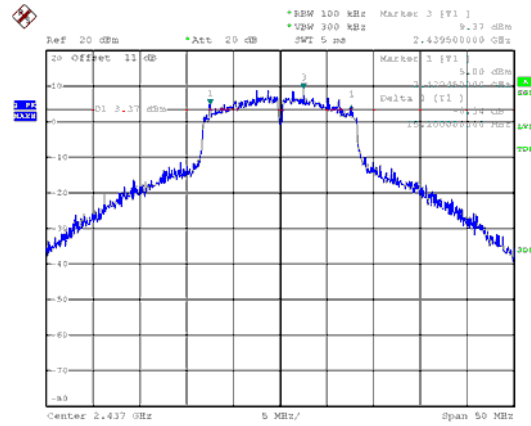

CH11

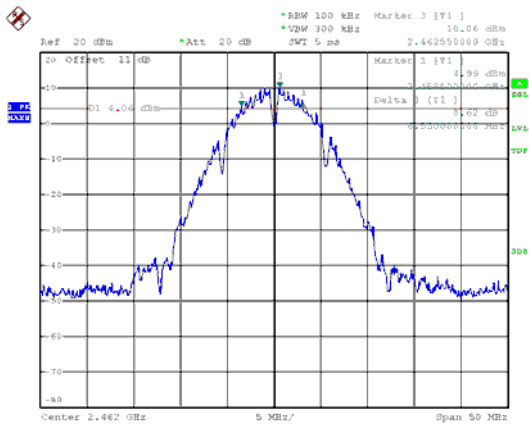

CH11

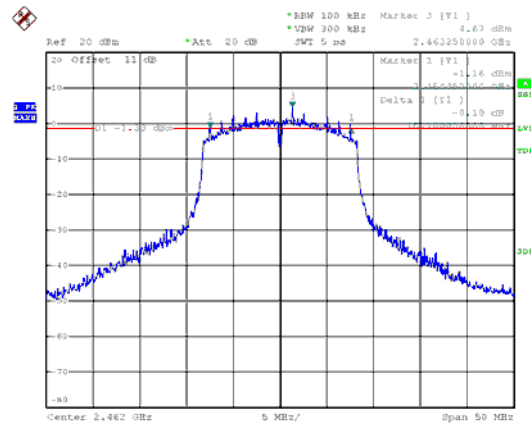



ANT A

Modulation Type: 802.11n HT20
CH01

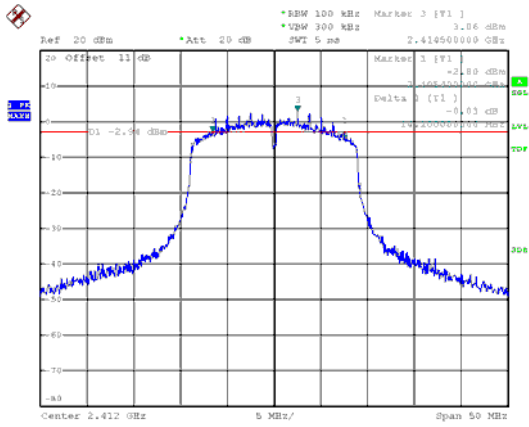

Modulation Type: 802.11n HT40
CH03

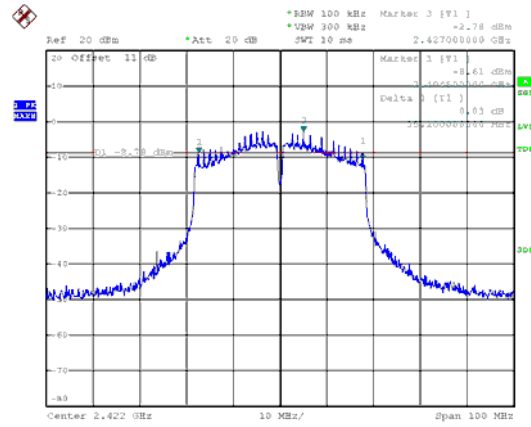

CH06

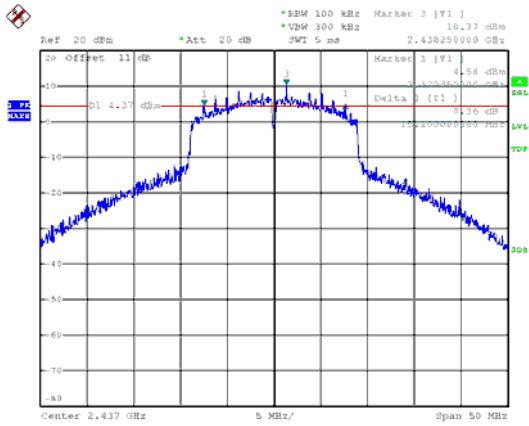

CH06

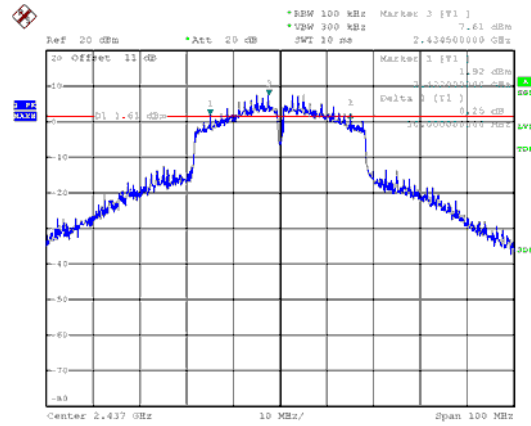

CH11

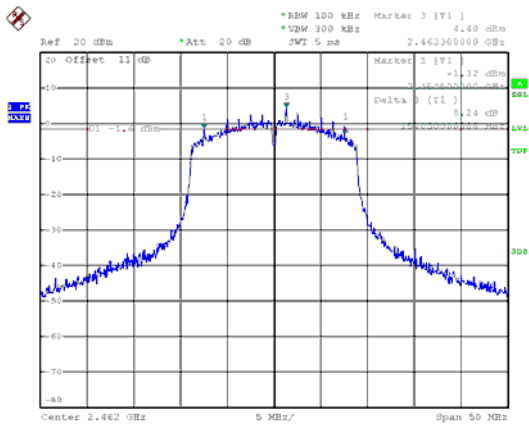

CH09

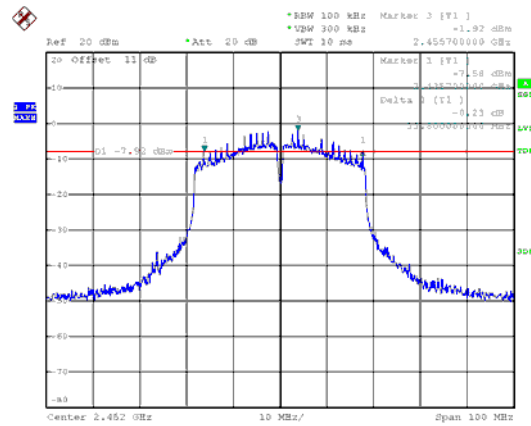



ANT B
Modulation Type: 802.11b
CH01

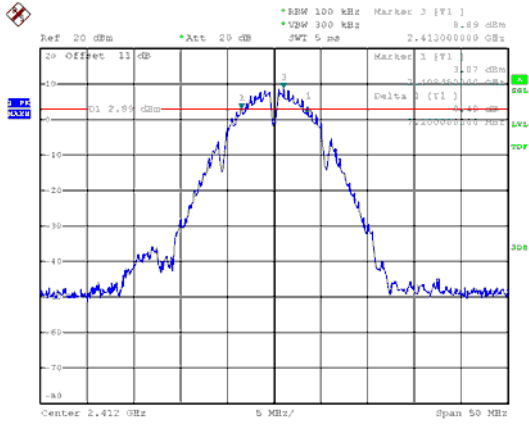

Modulation Type: 802.11g
CH01

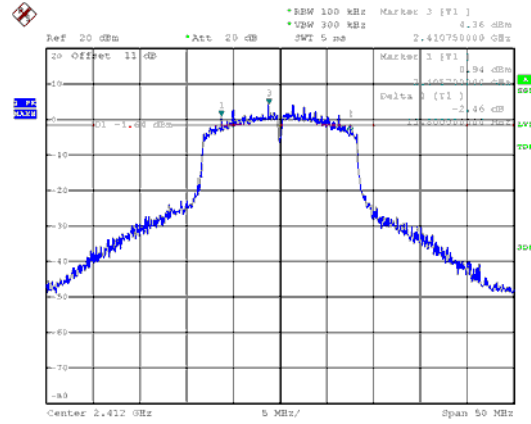

CH06

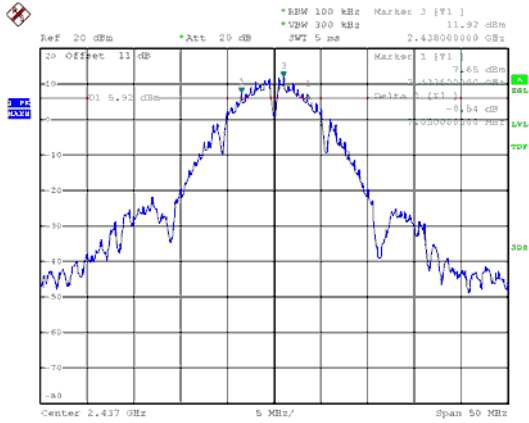

CH06

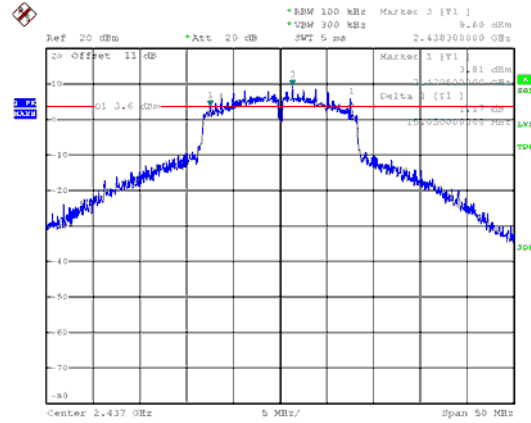

CH11

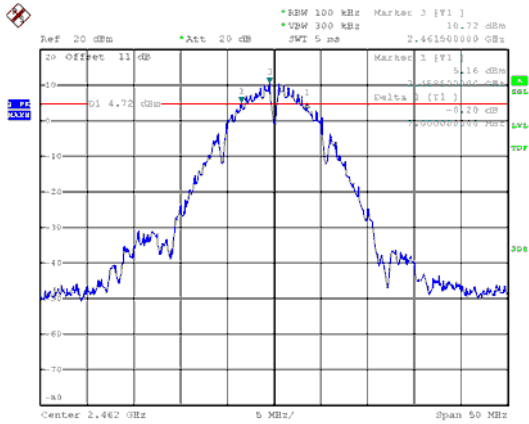

CH11

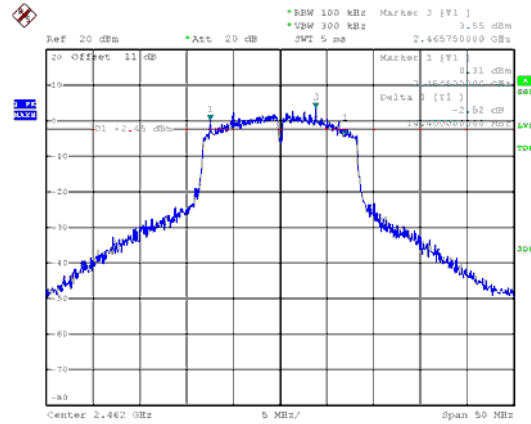



ANT B

Modulation Type: 802.11n HT20
CH01

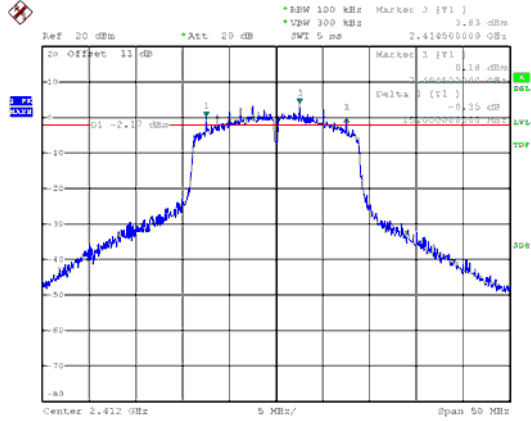

Modulation Type: 802.11n HT40
CH03

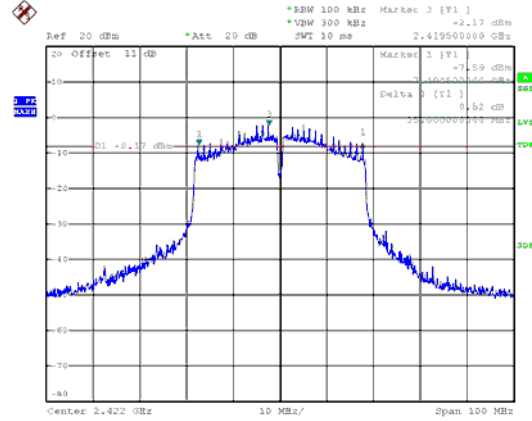

CH06

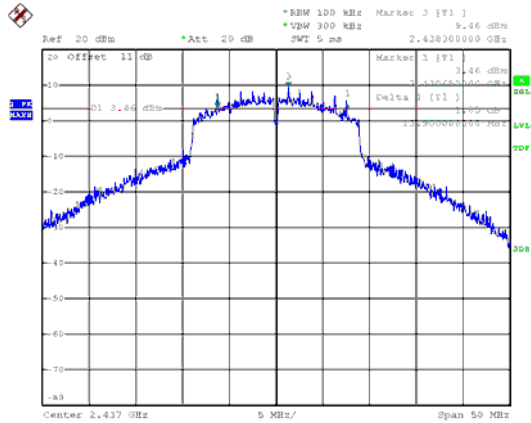

CH06

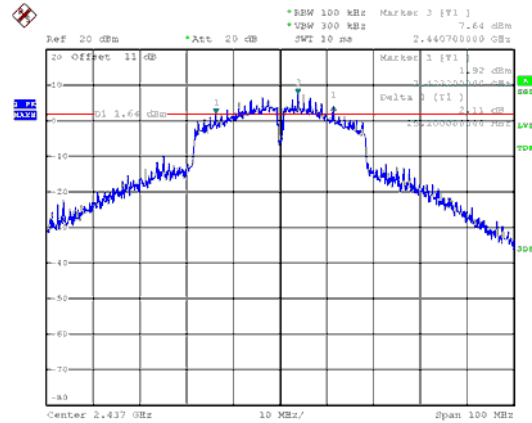

CH11

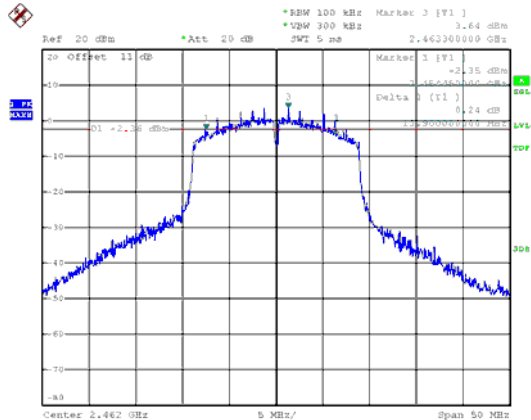

CH09

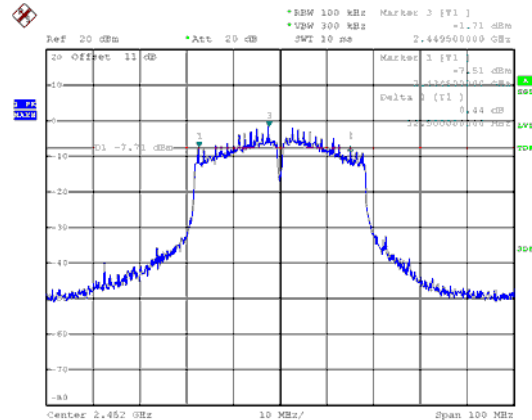



10. Maximum Peak and Average Output Power

10.1 Test Limit

The Maximum Peak Output Power Measurement is 30dBm.

If transmitting antennas of directional gain greater than 6 dBi are used, the peak output power shall be reduced by the amount in dB that the directional gain of the antenna exceeds 6 dBi

10.2 Test Procedures

The antenna port (RF output) of the EUT was connected to the input (RF input) of a power meter. Power was read directly from the meter and cable loss connection was added to the reading to obtain power at the EUT antenna terminal. The EUT Output Power was set to maximum to produce the worse case test result.

10.3 Test Setup Layout

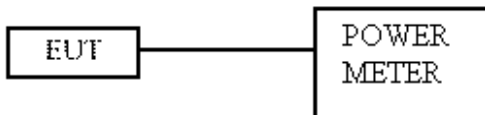



10.4 Test Result and Data

Setting	Modulation Mode	Channel	Frequency (MHz)	Conducted(peak) output power (dBm)		Total PK power (dBm)	Total PK power (mW)	Power Limit (dBm)
				ANT A	ANT B			
15.5	11b	1	2412	19.48	20.09	22.81	190.810	30.00
20		6	2437	22.81	22.49	25.66	368.404	30.00
17.5		11	2462	21.36	21.32	24.35	272.292	30.00
13.5	11g	1	2412	21.69	22.16	24.94	312.008	30.00
20		6	2437	24.75	24.21	27.50	562.171	30.00
13.5		11	2462	21.98	22.09	25.05	319.569	30.00
13	11n HT20	1	2412	20.99	21.36	24.19	262.376	30.00
20		6	2437	24.79	24.14	27.49	560.719	30.00
13		11	2462	21.65	21.38	24.53	283.622	30.00
9	11n HT40	3	2422	17.05	17.98	20.55	113.505	30.00
20		6	2437	24.70	24.10	27.42	552.161	30.00
9		9	2452	17.18	17.86	20.54	113.334	30.00

Power Set	Modulation Mode	Channel	Frequency (MHz)	Conducted(average) output power (dBm)		Total AV power (dBm)	Total AV power (mW)	Power Limit (dBm)
				ANT A	ANT B			
15.5	11b	1	2412	15.94	16.73	19.36	86.362	NA
20		6	2437	20.15	19.93	23.05	201.915	NA
17.5		11	2462	18.41	18.53	21.48	140.628	NA
13.5	11g	1	2412	14.14	15.15	17.68	58.676	NA
20		6	2437	19.88	19.99	22.95	197.045	NA
13.5		11	2462	14.46	14.78	17.63	57.986	NA
13	11n HT20	1	2412	13.33	14.21	16.80	47.891	NA
20		6	2437	19.67	19.83	22.76	188.844	NA
13		11	2462	13.81	14.23	17.04	50.529	NA
9	11n HT40	3	2422	9.89	10.98	13.48	22.281	NA
20		6	2437	20.08	20.03	23.07	202.552	NA
9		9	2452	10.12	10.87	13.52	22.498	NA

Note: Average power is for reference only.



11. Power Spectral Density

11.1 Test Limit

The Maximum of Power Spectral Density Measurement is 8dBm.

If transmitting antennas of directional gain greater than 6 dBi are used, the power spectral density shall be reduced by the amount in dB that the directional gain of the antenna exceeds 6 dBi

11.2 Test Procedures

- a. The transmitter output was connected to spectrum analyzer.
- b. The spectrum analyzer’s resolution bandwidth were set at 3kHz RBW and 10KHz VBW as that of the fundamental frequency. Set the sweep time=auto couple.
- c. The power spectral density was measured and recorded.

11.3 Test Setup Layout

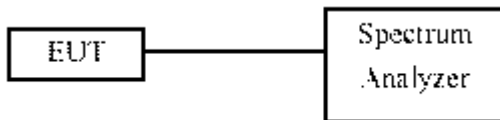

11.4 Test Result and Data

Modulation Type	Channel	Frequency (MHz)	Maximum Power Density of 3KHz Bandwidth(dBm)		Sum chain (dBm)	Duty Cycle CF(dB)	Total PSD (dBm)	Limit (dBm)
			ANT A	ANT B				
11b	1	2412	-6.11	-5.03	-2.53	0.00	-2.53	6.03
	6	2437	-3.00	-2.53	0.25	0.00	0.25	6.03
	11	2462	-3.78	-3.67	-0.71	0.00	-0.71	6.03
11g	1	2412	-9.99	-9.43	-6.69	0.00	-6.69	6.03
	6	2437	-4.92	-4.94	-1.92	0.00	-1.92	6.03
	11	2462	-9.55	-8.92	-6.21	0.00	-6.21	6.03
11n HT20	1	2412	-10.61	-10.54	-7.56	0.00	-7.56	6.03
	6	2437	-5.50	-5.13	-2.30	0.00	-2.30	6.03
	11	2462	-11.21	-10.73	-7.95	0.00	-7.95	6.03
11n HT40	3	2422	-17.71	-16.93	-14.29	0.00	-14.29	6.03
	6	2437	-7.92	-8.01	-4.95	0.00	-4.95	6.03
	9	2452	-17.01	-17.24	-14.11	0.00	-14.11	6.03



ANT A
Modulation Type: 802.11b
CH01

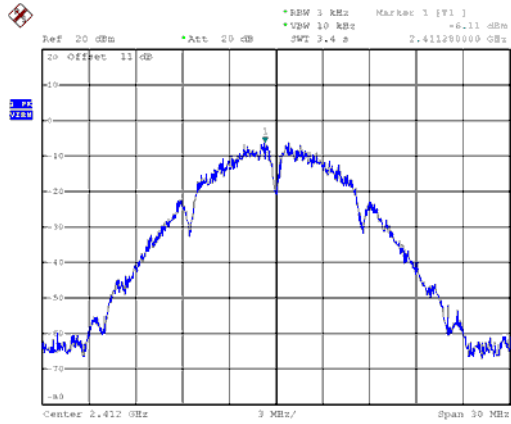

Modulation Type: 802.11g
CH01

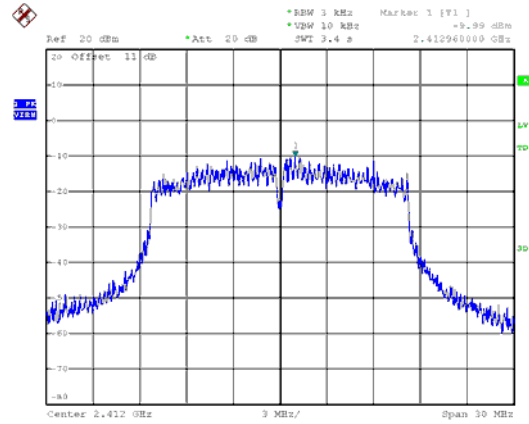

CH06

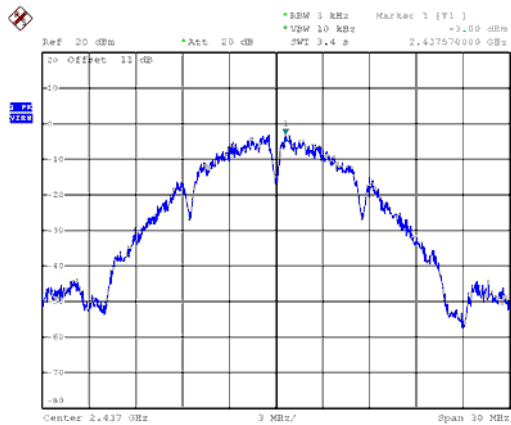

CH06

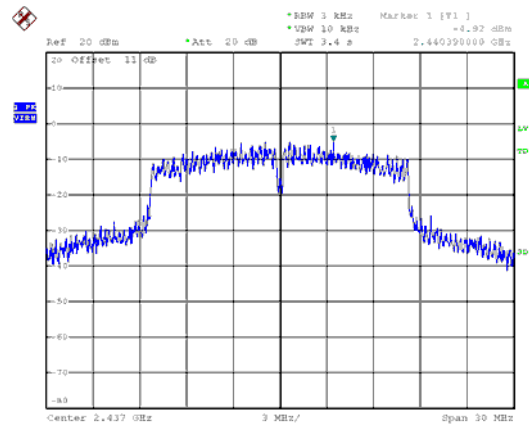

CH11

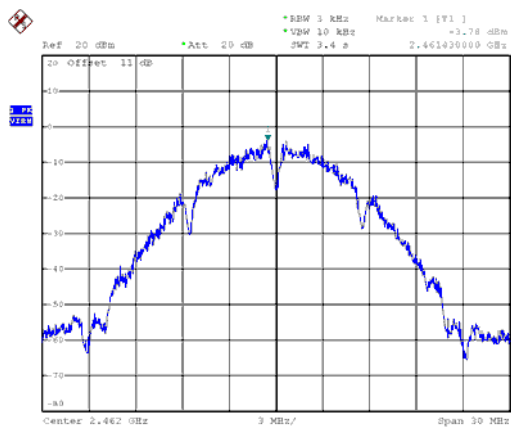

CH11

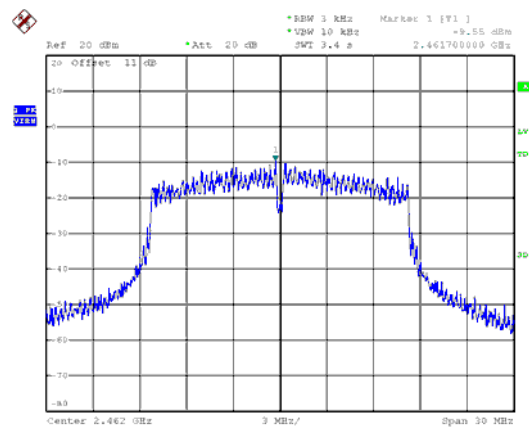



ANT A
Modulation Type: 802.11n HT20
CH01

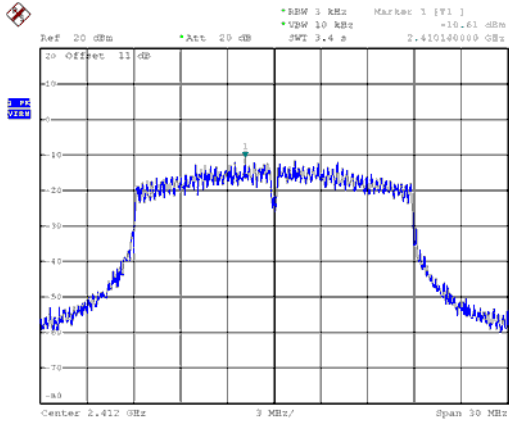

Modulation Type: 802.11n HT40
CH03

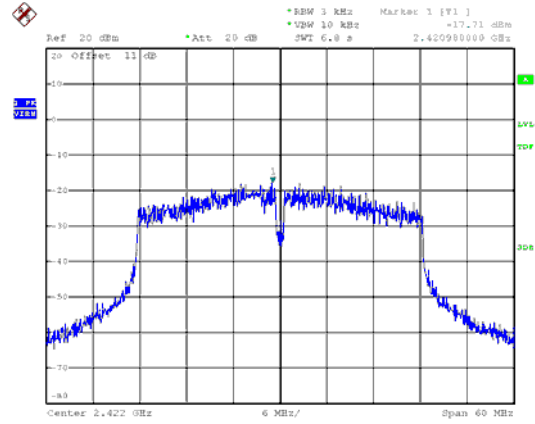

CH06

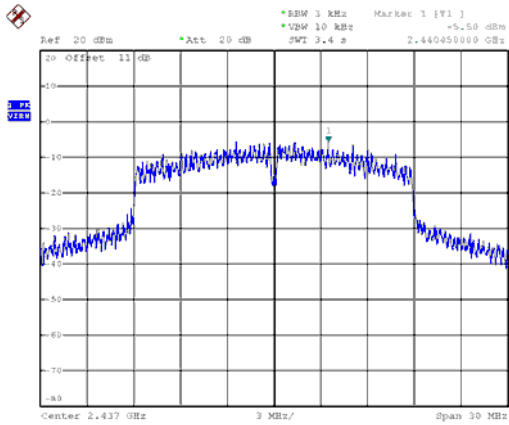

CH06

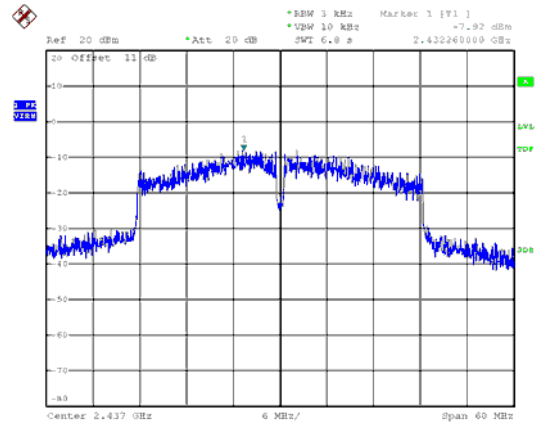

CH11

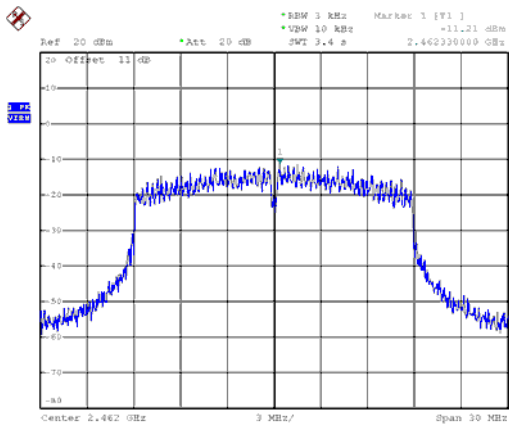

CH09

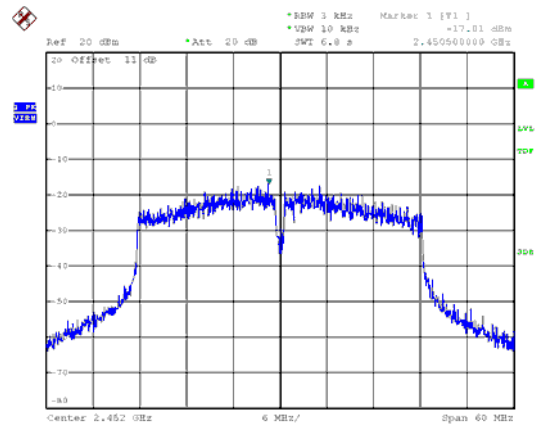



ANT B
Modulation Type: 802.11b
CH01

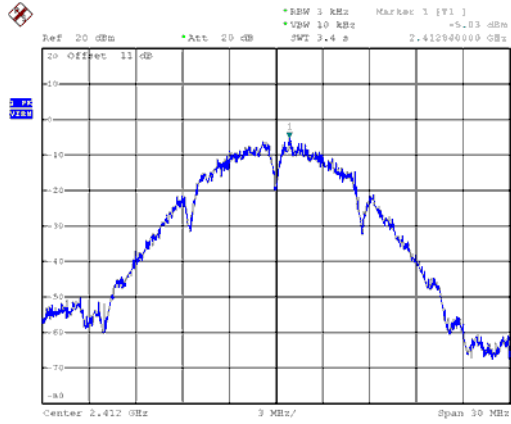

Modulation Type: 802.11g
CH01

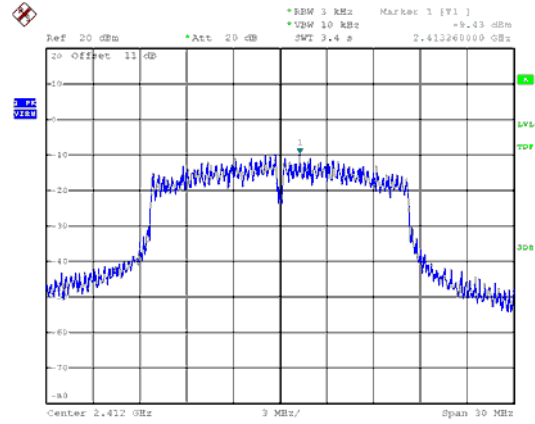

CH06

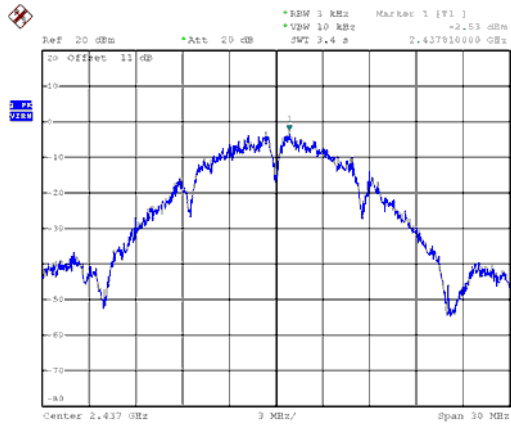

CH06

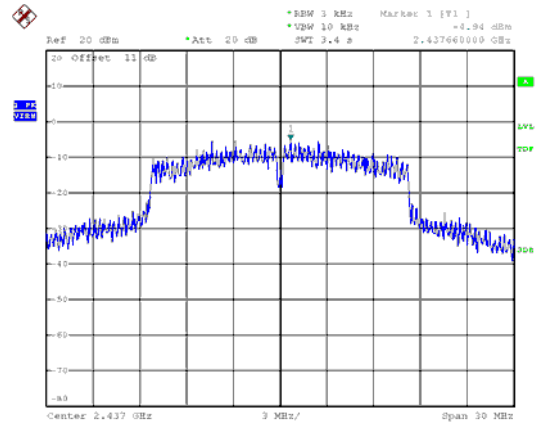

CH11

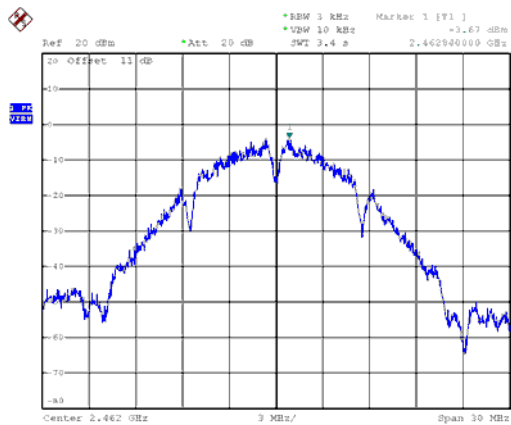

CH11

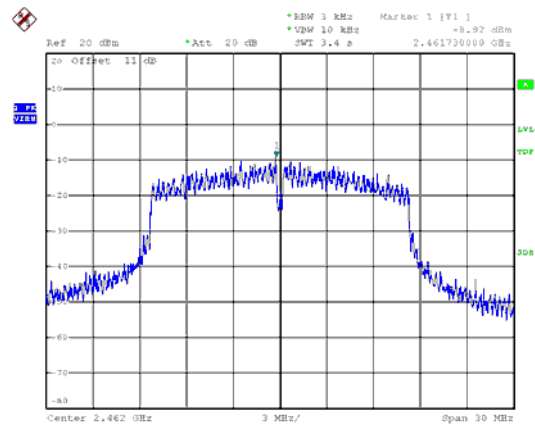



ANT B
Modulation Type: 802.11n HT20
CH01

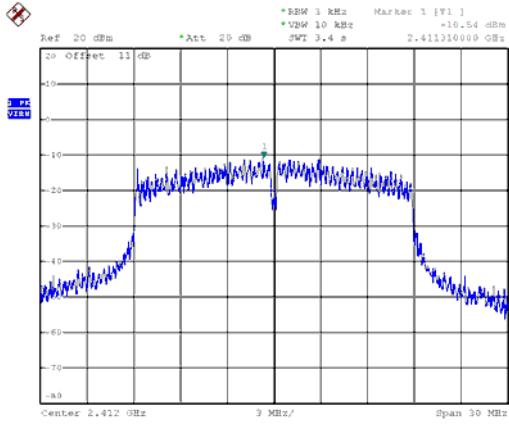

Modulation Type: 802.11n HT40
CH03

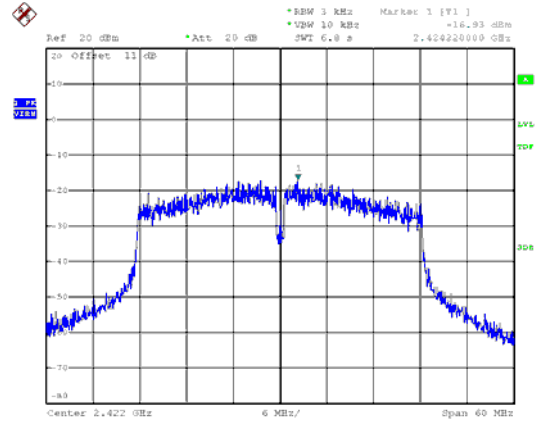

CH06

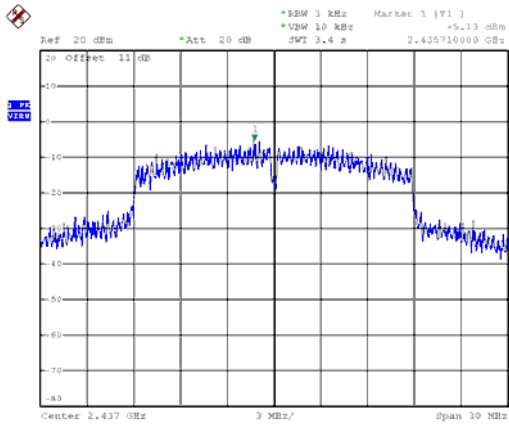

CH06

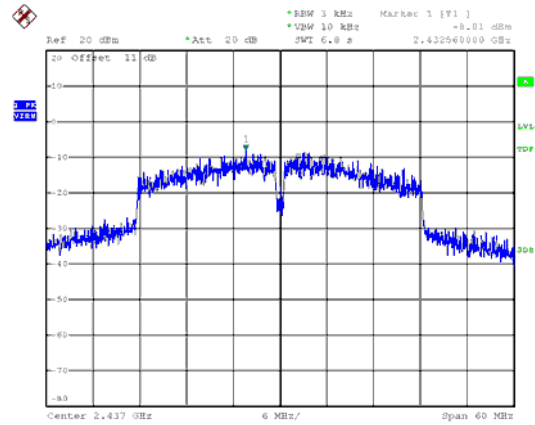

CH11

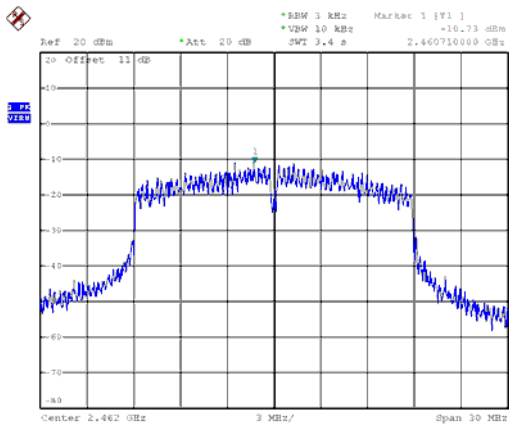

CH09

