



FCC Part 15C Test Report

FCC ID: 2AQLB-FB01

Product Name:	Football Bluetooth Speaker
Trademark:	OEM
Model Name :	FB01
Prepared For :	Foshan Platinum Audio Technology Co., Ltd
Address :	F2A05, 2nd Building Phase 2, Huiquan Technology Park, No.88 Taoyuan East Road, Nanhai District, Foshan City, Guang Dong Province, China
Prepared By :	Shenzhen BCTC Testing Co., Ltd.
Address :	BCTC Building & 1-2F, East of B Building, Pengzhou Industrial, Fuyuan 1st Road, Qiaotou Community, Fuyong Street, Bao'an District, Shenzhen, China
Test Date:	Jul. 17 – Jul.31, 2018
Date of Report :	Jul. 31, 2018
Report No.:	BCTC-FY180703763E



VERIFICATION OF COMPLIANCE

Applicant's name..... : Foshan Platinum Audio Technology Co., Ltd
Address..... : F2A05, 2nd Building Phase 2, Huiquan Technology Park, No.88
 Taoyuan East Road, Nanhai District, Foshan City, Guang Dong
 Province, China
Manufacture's Name..... : Foshan Platinum Audio Technology Co., Ltd
Address..... : F2A05, 2nd Building Phase 2, Huiquan Technology Park, No.88
 Taoyuan East Road, Nanhai District, Foshan City, Guang Dong
 Province, China

Product description

Product name.....: Football Bluetooth Speaker
Trademark: OEM
Model Name: FB01
 FCC Part15.249
Test Standards: ANSI C63.10-2013

This device described above has been tested by BCTC, and the test results show that the equipment under test (EUT) is in compliance with the FCC requirements. And it is applicable only to the tested sample identified in the report.

This report shall not be reproduced except in full, without the written approval of BCTC, this document may be altered or revised by BCTC, personal only, and shall be noted in the revision of the document.

Test Result..... : **Pass**

Prepared by(Engineer): Eric Yang

Eric Yang

Reviewer(Supervisor): Rita Xiao

Rita Xiao

Approved(Manager): Carson Zhang

Carson Zhang





Table of Contents	Page
1 . SUMMARY OF TEST RESULTS	5
1.1 TEST FACILITY	5
1.2 MEASUREMENT UNCERTAINTY	5
2 . GENERAL INFORMATION	6
2.1 GENERAL DESCRIPTION OF EUT	6
2.2 DESCRIPTION OF TEST MODES	8
2.3 TABLE OF PARAMETERS OF TEXT SOFTWARE SETTING	8
2.4 BLOCK DIGRAM SHOWING THE CONFIGURATION OF SYSTEM TESTED	8
2.5 DESCRIPTION OF SUPPORT UNITS(CONDUCTED MODE)	9
2.6 EQUIPMENTS LIST FOR ALL TEST ITEMS	10
3 . EMC EMISSION TEST	11
3.1 CONDUCTED EMISSION MEASUREMENT	11
3.1.1 POWER LINE CONDUCTED EMISSION LIMITS	11
3.1.2 TEST PROCEDURE	12
3.1.3 DEVIATION FROM TEST STANDARD	12
3.1.4 TEST SETUP	12
3.1.5 EUT OPERATING CONDITIONS	12
3.1.6 TEST RESULTS	13
3.2 RADIATED EMISSION MEASUREMENT	15
3.2.1 RADIATED EMISSION LIMITS	15
3.2.2 TEST PROCEDURE	16
3.2.3 DEVIATION FROM TEST STANDARD	16
3.2.4 TEST SETUP	17
3.2.5 EUT OPERATING CONDITIONS	18
3.2.6 TEST RESULTS	19
4 . BANDWIDTH TEST	26
4.1 APPLIED PROCEDURES / LIMIT	26
4.1.1 TEST PROCEDURE	26
4.1.2 DEVIATION FROM STANDARD	26
4.1.3 TEST SETUP	26
4.1.4 EUT OPERATION CONDITIONS	26
4.1.5 TEST RESULTS	27
5 . 100 KHZ BANDWIDTH OF FREQUENCY BAND EDGE	30
5.1 DEVIATION FROM STANDARD	30
5.2 TEST SETUP	30



Table of Contents	Page
5.3 EUT OPERATION CONDITIONS	30
5.4 TEST RESULTS	31
6 . ANTENNA REQUIREMENT	36
6.1 STANDARD REQUIREMENT	36
6.2 EUT ANTENNA	36
7 . EUT TEST PHOTO	37
8 . EUT PHOTO	39



1. SUMMARY OF TEST RESULTS

Test procedures according to the technical standards:

FCC Part15 (15.249) , Subpart C			
Standard Section	Test Item	Judgment	Remark
15.207	Conducted Emission	PASS	
15.249	Fundamental & Radiated Spurious Emission Measurement	PASS	
15.249	Bandwidth	PASS	
15.205	Band Edge Emission	PASS	
15.203	Antenna Requirement	PASS	

NOTE:

(1) "N/A" denotes test is not applicable in this Test Report

1.1 TEST FACILITY

Shenzhen BCTC Testing Co., Ltd.

Add.: BCTC Building & 1-2F, East of B Building, Pengzhou Industrial, Fuyuan 1st Road, Qiaotou Community, Fuyong Street, Bao'an District, Shenzhen, China

Test Firm Registration Number: 712850

1.2 MEASUREMENT UNCERTAINTY

The reported uncertainty of measurement $y \pm U$, where expanded uncertainty U is based on a standard uncertainty multiplied by a coverage factor of $k=2$, providing a level of confidence of approximately 95 %.

No.	Item	Uncertainty
1	Conducted Emission Test	$\pm 1.38\text{dB}$
2	RF power, conducted	$\pm 0.16\text{dB}$
3	Spurious emissions, conducted	$\pm 0.21\text{dB}$
4	All emissions, radiated (<1G)	$\pm 4.68\text{dB}$
5	All emissions, radiated (>1G)	$\pm 4.89\text{dB}$
6	Temperature	$\pm 0.5^\circ\text{C}$
7	Humidity	$\pm 2\%$



2. GENERAL INFORMATION

2.1 GENERAL DESCRIPTION OF EUT

Equipment	Football Bluetooth Speaker
Trade Name	OEM
Model Name	FB01
Serial Model	N/A
Model Difference	N/A
Product Description	Operation Frequency: 2402~2480 MHz
	Modulation Type: GFSK,PI/4 DPSK
	Bit Rate of Transmitter 1M/2Mbps
	Number Of Channel 79 CH
	Antenna Designation: Please see Note 3.
	Based on the application, features, or specification exhibited in User's Manual, the EUT is considered as an ITE/Computing Device. More details of EUT technical specification, please refer to the User's Manual.
Channel List	Please refer to the Note 2.
Power Source	DC 5V (from Adapter) DC 7.4V (from battery)
Connecting I/O Port(s)	Please refer to the User's Manual

Note:

1. For a more detailed features description, please refer to the manufacturer's specifications or the User's Manual.



2.

Channel List					
Channel	Frequency (MHz)	Channel	Frequency (MHz)	Channel	Frequency (MHz)
00	2402	27	2429	54	2456
01	2403	28	2430	55	2457
02	2404	29	2431	56	2458
03	2405	30	2432	57	2459
04	2406	31	2433	58	2460
05	2407	32	2434	59	2461
06	2408	33	2435	60	2462
07	2409	34	2436	61	2463
08	2410	35	2437	62	2464
09	2411	36	2438	63	2465
10	2412	37	2439	64	2466
11	2413	38	2440	65	2467
12	2414	39	2441	66	2468
13	2415	40	2442	67	2469
14	2416	41	2443	68	2470
15	2417	42	2444	69	2471
16	2418	43	2445	70	2472
17	2419	44	2446	71	2473
18	2420	45	2447	72	2474
19	2421	46	2448	73	2475
20	2422	47	2449	74	2476
21	2423	48	2450	75	2477
22	2424	49	2451	76	2478
23	2425	50	2452	77	2479
24	2426	51	2453	78	2480
25	2427	52	2454		
26	2428	53	2455		

3.

Table for Filed Antenna

Ant.	Brand	Model Name	Antenna Type	Gain (dBi)	NOTE
1	N/A	N/A	PCB Antenna	0	



2.2 DESCRIPTION OF TEST MODES

To investigate the maximum EMI emission characteristics generated from EUT, the test system was pre-scanning tested based on the consideration of following EUT operation mode or test configuration mode which possibly have effect on EMI emission level. Each of these EUT operation mode(s) or test configuration mode(s) mentioned above was evaluated respectively.

For All Mode	Description	Modulation Type
Mode 1	CH00	GFSK,PI/4 DPSK
Mode 2	CH39	
Mode 3	CH78	
Mode 4	Link mode(conducted emission and Radiated emission)	

Note:

- (1) The measurements are performed at the highest, middle, lowest available channels.
- (2) Fully-charged battery is used during the test

2.3 TABLE OF PARAMETERS OF TEST SOFTWARE SETTING

During testing channel & power controlling software provided by the customer was used to control the operating channel as well as the output power level. The RF output power selection is for the setting of RF output power expected by the customer and is going to be fixed on the firmware of the final end product power parameters of FHSS

Frequency	2402 MHz	2441 MHz	2480 MHz
Channel	Low	Middle	High

2.4 BLOCK DIAGRAM SHOWING THE CONFIGURATION OF SYSTEM TESTED

Conducted Emission Test

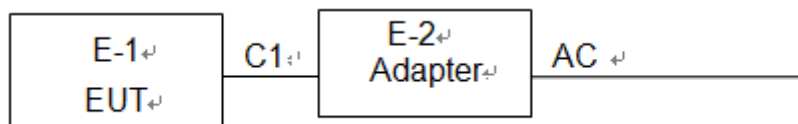

Radiated Spurious Emission

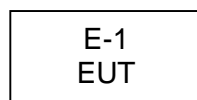



2.5 DESCRIPTION OF SUPPORT UNITS(CONDUCTED MODE)

The EUT has been tested as an independent unit together with other necessary accessories or support units. The following support units or accessories were used to form a representative test configuration during the tests.

Item	Equipment	Mfr/Brand	Model/Type No.	Series No.	Note
E-1	Football Bluetooth Speaker	OEM	FB01	N/A	EUT
E-2	Adapter	N/A	BCTC001	N/A	Lab.Provide

Item	Shielded Type	Ferrite Core	Length	Note
C1	NO	NO	0.8M	USB cable unshielded

Note:

- (1) The support equipment was authorized by Declaration of Confirmation.
- (2) For detachable type I/O cable should be specified the length in cm in 『Length』 column.
- (3) “YES” is means “shielded” “with core”; “NO” is means “unshielded” “without core”.



2.6 EQUIPMENTS LIST FOR ALL TEST ITEMS

Radiation Test equipment

Item	Equipment	Manufacturer	Type No.	Serial No.	Last calibration	Calibrated until
1	Spectrum Analyzer (9kHz-26.5GHz)	Agilent	E4407B	MY45108040	2017.08.27	2018.08.26
2	Test Receiver (9kHz-7GHz)	R&S	ESPI	101318	2017.08.27	2018.08.26
3	Bilog Antenna (30MHz-1GHz)	R&S	VULB 9168	VULB91 68-438	2017.08.27	2018.08.26
4	Horn Antenna (1GHz-18GHz)	SCHWARZBECK	BBHA9120D	1201	2017.09.03	2018.09.02
5	Horn Antenna (14GHz-40GHz)	SCHWARZBECK	BBHA 9170	9170-181	2017.09.03	2018.09.02
6	Amplifier (9KHz-6GHz)	SCHWARZBECK	BBV9744	9744-0037	2017.08.27	2018.08.26
7	Amplifier (1GHz-18GHz)	SCHWARZBECK	BBV9718	9718-309	2017.08.27	2018.08.26
8	Amplifier (18GHz-40GHz)	SCHWARZBECK	BBV 9721	9721-205	2017.08.27	2018.08.26
9	Loop Antenna (9KHz-30MHz)	SCHWARZBECK	FMZB1519B	00014	2017.09.03	2018.09.02
10	RF cables1 (9kHz-1GHz)	R&S	R203	R20X	2017.08.27	2018.08.26
11	RF cables2 (1GHz-40GHz)	R&S	R204	R21X	2017.08.27	2018.08.26
12	Antenna connector	Florida RF Labs	N/A	RF 01#	2017.08.27	2018.08.26
13	Power Metter	ANRITSU	ML2487A	6K00001568	2017.08.27	2018.08.26
14	Power Sensor (AV)	ANRITSU	ML2491A	030989	2017.08.27	2018.08.26
15	Signal Analyzer 9kHz-26.5GHz	Agilent	N9010A	MY48030494	2017.08.27	2018.08.26
16	Test Receiver 20kHz-40GHz	R&S	ESU 40	100376	2017.08.27	2018.08.26
17	D.C. Power Supply	LongWei	PS-305D	010964729	2017.08.27	2018.08.26

Conduction Test equipment

Item	Equipment	Manufacturer	Type No.	Serial No.	Last calibration	Calibrated until
1	Test Receiver	R&S	ESCI	1166.5950K03-1011 65-ha	2017.08.27	2018.08.26
2	LISN	SCHWARZBECK	NSLK8127	8127739	2017.08.27	2018.08.26
3	LISN	R&S	NSLK8126	8126487	2017.08.27	2018.08.26
4	RF cables	R&S	R204	R20X	2017.08.27	2018.08.26
5	Attenuator	R&S	ESH3-Z2	143206	2017.08.27	2018.08.26



3. EMC EMISSION TEST

3.1 CONDUCTED EMISSION MEASUREMENT

3.1.1 POWER LINE CONDUCTED EMISSION Limits (Frequency Range 150KHz-30MHz)

FREQUENCY (MHz)	Limit (dBuV)		Standard
	Quas -peak	Average	
0.15 -0.5	66 - 56 *	56 - 46 *	FCC
0.50 -5.0	56.00	46.00	FCC
5.0 -30.0	60.00	50.00	FCC

Note:

- (1) The tighter limit applies at the band edges.
- (2) The limit of " * " marked band means the limitation decreases linearly with the logarithm of the frequency in the range.

The following table is the setting of the receiver

Receiver Parameters	Setting
Attenuation	10 dB
Start Frequency	0.15 MHz
Stop Frequency	30 MHz
IF Bandwidth	9 kHz

3.1.2 TEST PROCEDURE

- The EUT was placed 0.8 meters from the horizontal ground plane with EUT being connected to the power mains through a line impedance stabilization network (LISN). All other support equipments powered from additional LISN(s). The LISN provide 50 Ohm/ 50uH of coupling impedance for the measuring instrument.
- Interconnecting cables that hang closer than 40 cm to the ground plane shall be folded back and forth in the center forming a bundle 30 to 40 cm long.
- I/O cables that are not connected to a peripheral shall be bundled in the center. The end of the cable may be terminated, if required, using the correct terminating impedance. The overall length shall not exceed 1 m.
- LISN at least 80 cm from nearest part of EUT chassis.
- For the actual test configuration, please refer to the related Item –EUT Test Photos.

3.1.3 DEVIATION FROM TEST STANDARD

No deviation

3.1.4 TEST SETUP

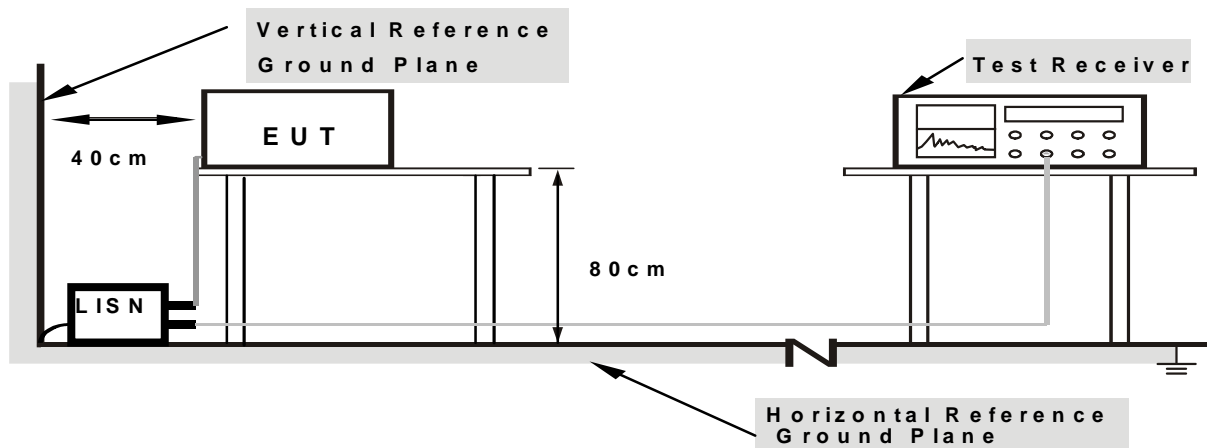

Note: 1.Support units were connected to second LISN.

2.Both of LISNs (AMN) are 80 cm from EUT and at least 80 from other units and other metal planes

3.1.5 EUT OPERATING CONDITIONS

The EUT was configured for testing in a typical fashion (as a customer would normally use it). The EUT has been programmed to continuously transmit during test. This operating condition was tested and used to collect the included data.

We pretest AC 120V and AC 240V, the worst voltage was AC 120V and the data recording in the report.



3.1.6 TEST RESULTS

Temperature :	25 °C	Relative Humidity :	54%
Pressure :	1010hPa	Phase :	L
Test Voltage :	AC120V/60Hz	Test Mode :	Mode 4

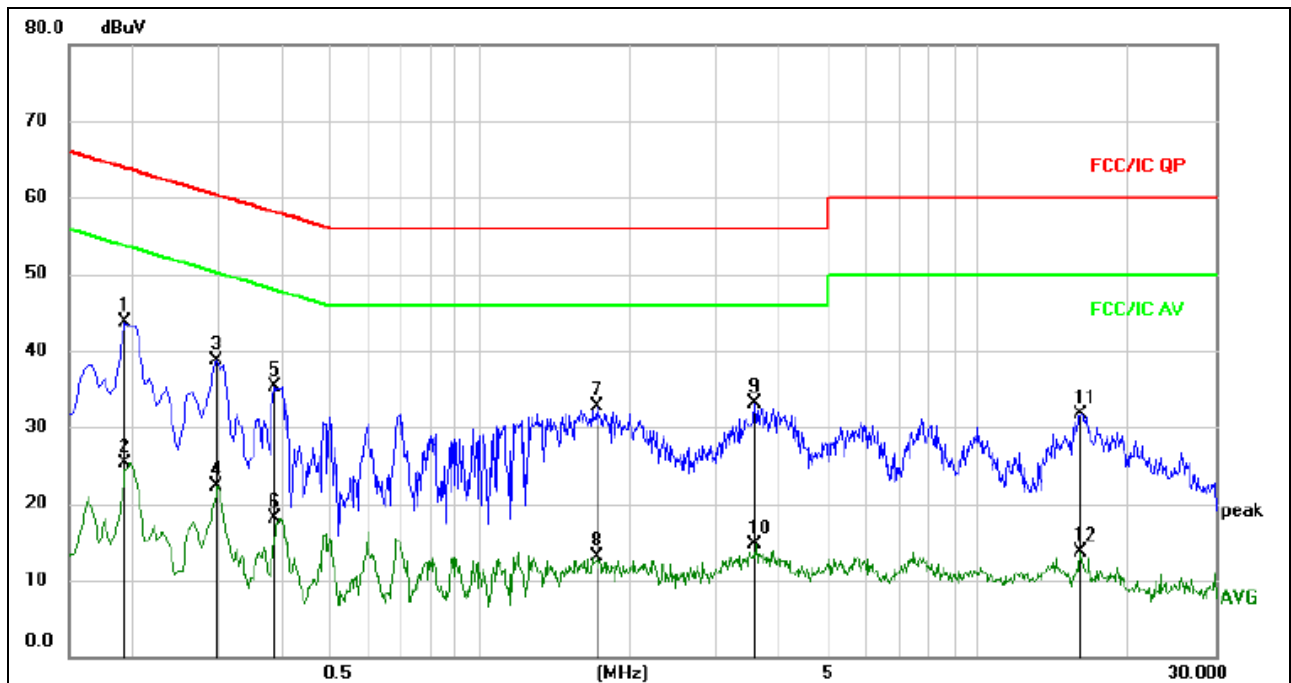

Remark:

1. All readings are Quasi-Peak and Average values.
2. Factor = Insertion Loss + Cable Loss.

No.	Mk.	Freq. MHz	Reading Level dBuV	Correct Factor dB	Measure- ment dBuV	Limit dBuV	Over dB	Detector	Comment
1	*	0.1949	33.97	9.76	43.73	63.83	-20.10	QP	
2		0.1949	15.64	9.76	25.40	53.83	-28.43	AVG	
3		0.2985	28.88	9.78	38.66	60.28	-21.62	QP	
4		0.2985	12.53	9.78	22.31	50.28	-27.97	AVG	
5		0.3885	25.56	9.71	35.27	58.10	-22.83	QP	
6		0.3885	8.33	9.71	18.04	48.10	-30.06	AVG	
7		1.7340	22.92	9.78	32.70	56.00	-23.30	QP	
8		1.7340	3.33	9.78	13.11	46.00	-32.89	AVG	
9		3.5835	23.16	9.85	33.01	56.00	-22.99	QP	
10		3.5835	4.82	9.85	14.67	46.00	-31.33	AVG	
11		16.1160	21.76	10.02	31.78	60.00	-28.22	QP	
12		16.1160	3.59	10.02	13.61	50.00	-36.39	AVG	



Temperature :	25 °C	Relative Humidity :	54%
Pressure :	1010hPa	Phase :	N
Test Voltage :	AC120V/60Hz	Test Mode :	Mode 4

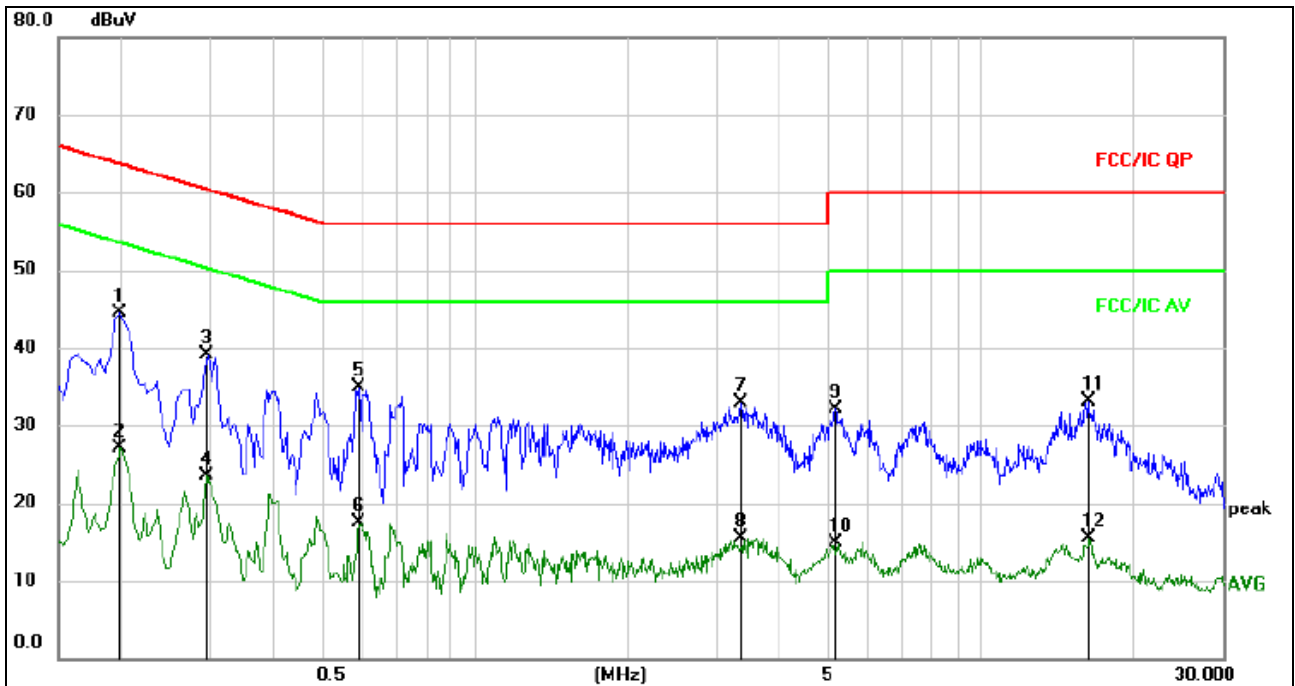

Remark:

1. All readings are Quasi-Peak and Average values.
2. Factor = Insertion Loss + Cable Loss.

No.	Mk.	Freq. MHz	Reading Level dBuV	Correct Factor dB	Measure- ment dBuV	Limit dBuV	Over dB	Detector	Comment
1	*	0.1995	34.65	9.76	44.41	63.63	-19.22	QP	
2		0.1995	17.33	9.76	27.09	53.63	-26.54	AVG	
3		0.2940	29.25	9.78	39.03	60.41	-21.38	QP	
4		0.2940	13.74	9.78	23.52	50.41	-26.89	AVG	
5		0.5910	24.81	10.16	34.97	56.00	-21.03	QP	
6		0.5910	7.41	10.16	17.57	46.00	-28.43	AVG	
7		3.3630	23.00	9.84	32.84	56.00	-23.16	QP	
8		3.3630	5.63	9.84	15.47	46.00	-30.53	AVG	
9		5.1585	22.17	9.90	32.07	60.00	-27.93	QP	
10		5.1585	5.05	9.90	14.95	50.00	-35.05	AVG	
11		16.2690	23.00	10.02	33.02	60.00	-26.98	QP	
12		16.2690	5.46	10.02	15.48	50.00	-34.52	AVG	



3.2 RADIATED EMISSION MEASUREMENT

3.2.1 RADIATED EMISSION LIMITS (Frequency Range 9kHz-1000MHz)

20dBc in any 100 kHz bandwidth outside the operating frequency band. In case the emission fall within the restricted band specified on 15.205(a), then the 15.209(a) limit in the table below has to be followed.

Frequencies (MHz)	Field Strength (micorvolts/meter)	Measurement Distance (meters)
0.009~0.490	2400/F(KHz)	300
0.490~1.705	24000/F(KHz)	30
1.705~30.0	30	30
30~88	100	3
88~216	150	3
216~960	200	3
Above 960	500	3

LIMITS OF RADIATED EMISSION MEASUREMENT (Above 1000MHz)

FREQUENCY (MHz)	Limit (dBuV/m) (at 3M)	
	PEAK	AVERAGE
Above 1000	74	54

Notes:

- (1) The limit for radiated test was performed according to FCC PART 15C.
- (2) The tighter limit applies at the band edges.
- (3) Emission level (dBuV/m)=20log Emission level (uV/m).

FREQUENCY RANGE OF RADIATED MEASUREMENT (For unintentional radiators)

Highest frequency generated or Upper frequency of measurement used in the device or on which the device operates or tunes (MHz)	Range (MHz)
Below 1.705	30
1.705 – 108	1000
108 – 500	2000
500 – 1000	5000
Above 1000	5 th harmonic of the highest frequency or 40 GHz, whichever is lower



Spectrum Parameter	Setting
Attenuation	Auto
Start Frequency	1000 MHz
Stop Frequency	10th carrier harmonic
RB / VB (emission in restricted band)	1 MHz / 1 MHz for Peak, 1 MHz / 10Hz for Average

Receiver Parameter	Setting
Attenuation	Auto
Start ~ Stop Frequency	9kHz~150kHz / RB 200Hz for QP
Start ~ Stop Frequency	150kHz~30MHz / RB 9kHz for QP
Start ~ Stop Frequency	30MHz~1000MHz / RB 120kHz for QP

3.2.2 TEST PROCEDURE

- a. The measuring distance of at 3 m shall be used for measurements at frequency up to 25GHz. For frequencies above 1GHz, any suitable measuring distance may be used.
- b. The EUT was placed on the top of a rotating table 0.8 and 1.5 meters above the ground at a 3 meter semi-chamber test. The table was rotated 360 degrees to determine the position of the highest radiation.
- c. The height of the equipment or of the substitution antenna shall be 0.8 m; above 1GHz, the height was 1.5m, the height of the test antenna shall vary between 1 m to 4 m. Both horizontal and vertical polarizations of the antenna are set to make the measurement.
- d. The initial step in collecting conducted emission data is a spectrum analyzer peak detector mode pre-scanning the measurement frequency range. Significant peaks are then marked and then Quasi Peak detector mode re-measured.
- e. If the Peak Mode measured value compliance with and lower than Quasi Peak Mode Limit, the EUT shall be deemed to meet QP Limits and then no additional QP Mode measurement performed.
- f. For the actual test configuration, please refer to the related Item –EUT Test Photos.
- g. For the radiated emission test above 1GHz:
Place the measurement antenna away from each area of the EUT determined to be a source of emissions at the specified measurement distance, while keeping the measurement antenna aimed at the source of emissions at each frequency of significant emissions, with polarization oriented for maximum response.
The measurement antenna may have to be higher or lower than the EUT, depending on the radiation pattern of the emission and staying aimed at the emission source for receiving the maximum signal. The final measurement antenna elevation shall be that which maximizes the emissions. The measurement antenna elevation for maximum emissions shall be restricted to a range of heights of from 1 m to 4 m above the ground or reference ground plane.

Note:

Both horizontal and vertical antenna polarities were tested and performed pretest to three orthogonal axis. The worst case emissions were reported

3.2.3 DEVIATION FROM TEST STANDARD

No deviation

3.2.4 TEST SETUP

(A) Radiated Emission Test-Up Frequency Below 30MHz

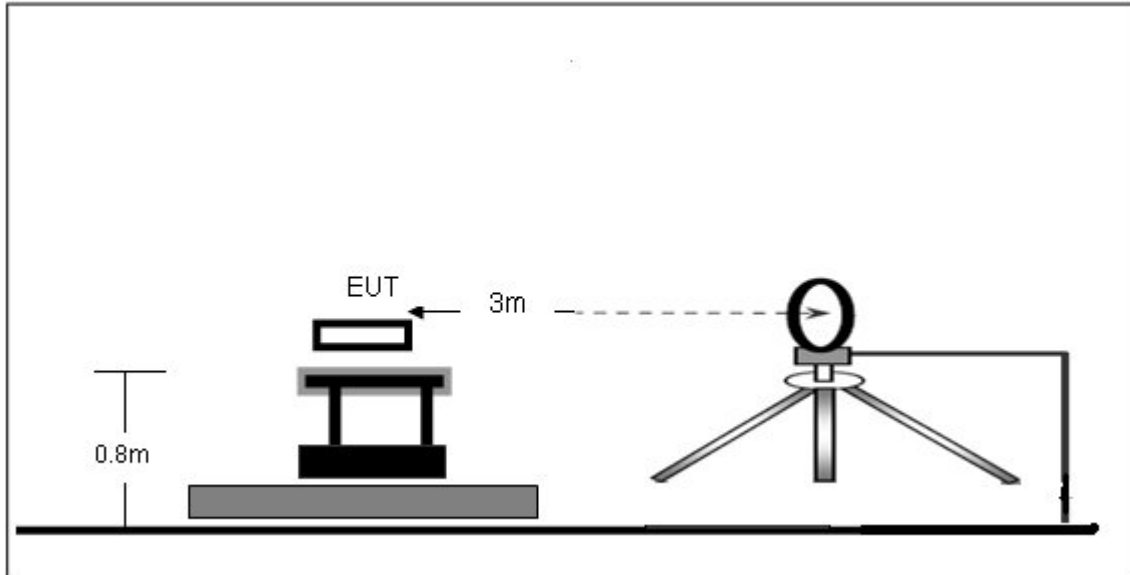

(B) Radiated Emission Test-Up Frequency 30MHz~1GHz

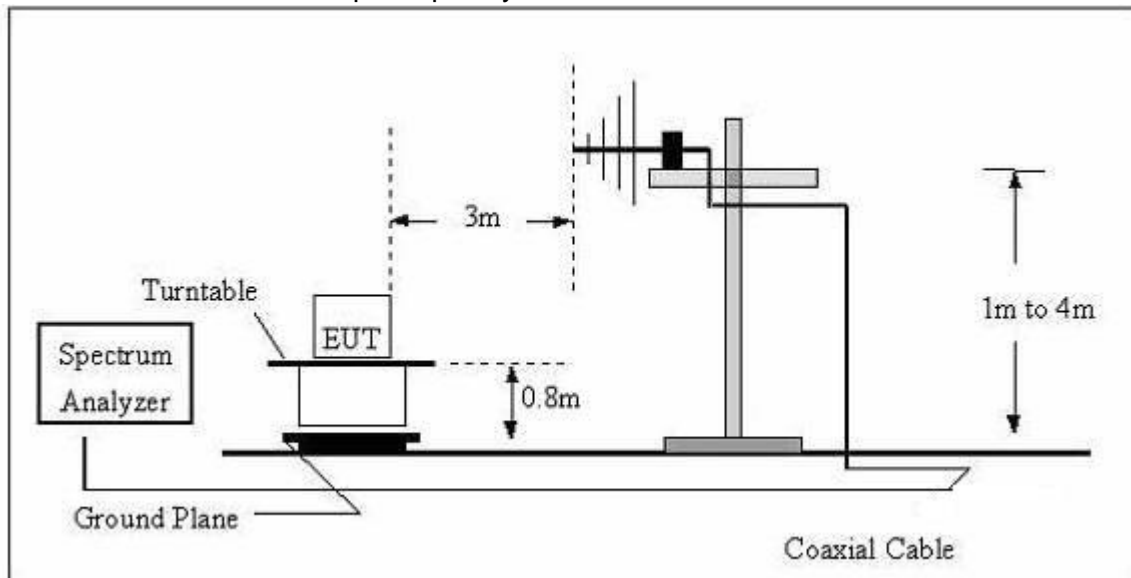

(C) Radiated Emission Test-Up Frequency Above 1GHz

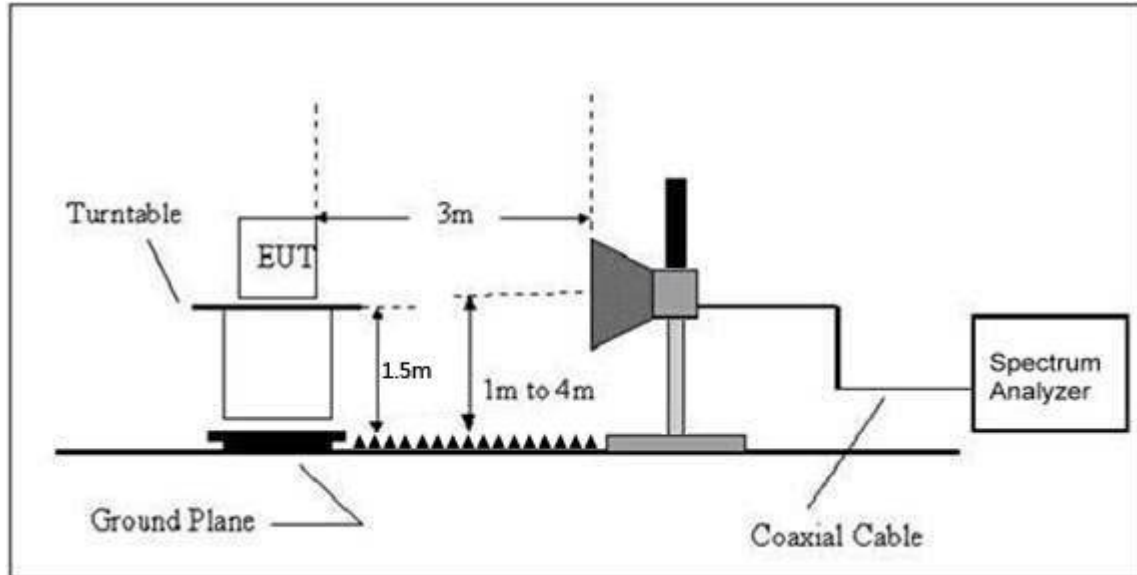

3.2.5 EUT OPERATING CONDITIONS

The EUT tested system was configured as the statements of 2.4 Unless otherwise a special operating condition is specified in the follows during the testing.



3.2.6 TEST RESULTS

Radiated Spurious Emission (Below 30MHz)

Temperature :	25 °C	Relative Humidity :	55%
Pressure :	1010 hPa	Polarization :	---
Test Voltage :	DC 7.4V		
Test Mode :	Mode 4		

Freq.	Reading	Limit	Margin	State
(MHz)	(dBuV/m)	(dBuV/m)	(dB)	P/F
--	--	--	--	PASS
--	--	--	--	PASS

NOTE:

The amplitude of spurious emissions which are attenuated by more than 20dB below the permissible value has no need to be reported.

Distance extrapolation factor = $40 \log(\text{specific distance}/\text{test distance})$ (dB);

Limit line = specific limits(dBuv) + distance extrapolation factor.



Radiated Spurious Emission (Between 30MHz – 1GHz)

Temperature :	26 °C	Relative Humidity :	54%
Pressure :	1010 hPa	Polarization :	Horizontal
Test Voltage :	DC 7.4V		
Test Mode : (Worst)	Mode 4		

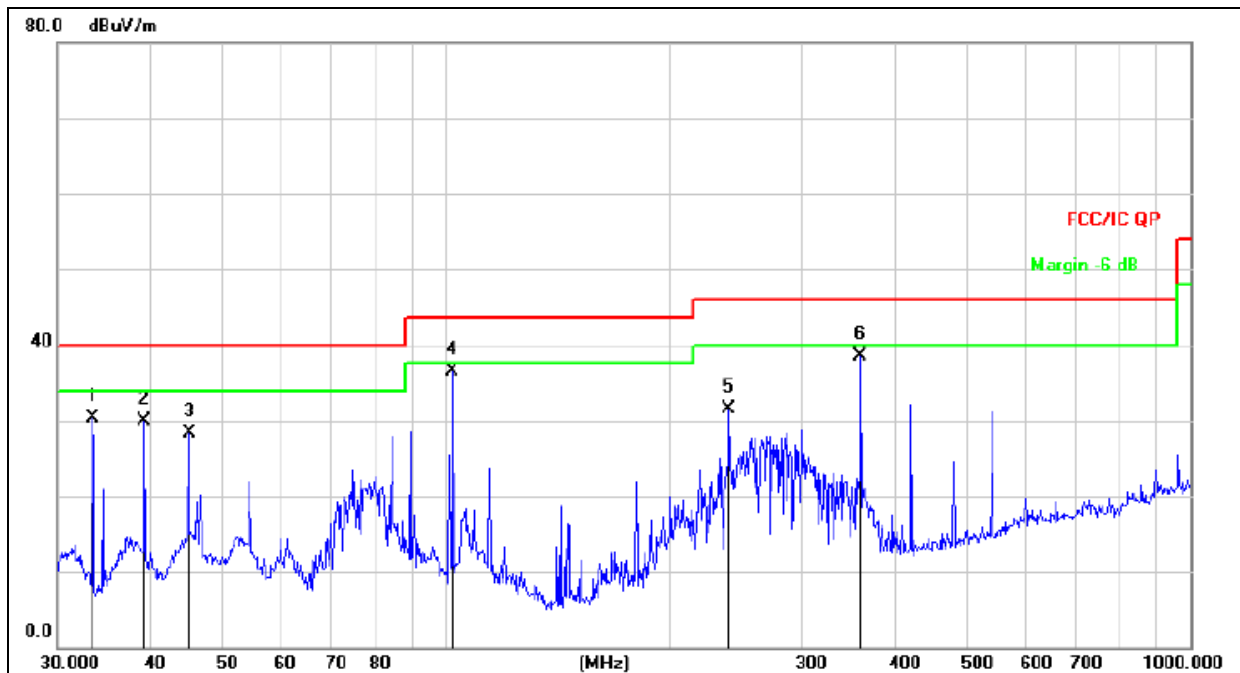

Remark:
Factor = Antenna Factor + Cable Loss – Pre-amplifier.

No.	Mk.	Freq. MHz	Reading Level dBuV	Correct Factor dB	Measure- ment dBuV/m	Limit dB/m	Over dB	Detector
1		33.4449	46.81	-16.59	30.22	40.00	-9.78	peak
2		39.2991	44.85	-14.97	29.88	40.00	-10.12	peak
3		45.0583	42.33	-14.04	28.29	40.00	-11.71	peak
4	*	102.0014	52.08	-15.58	36.50	43.50	-7.00	peak
5		239.9874	47.02	-15.52	31.50	46.00	-14.50	peak
6		360.4476	50.76	-12.18	38.58	46.00	-7.42	peak



Temperature :	26 °C	Relative Humidity :	54%
Pressure :	1010 hPa	Polarization :	Vertical
Test Voltage :	DC 7.4V		
Test Mode : (Worst)	Mode 4		

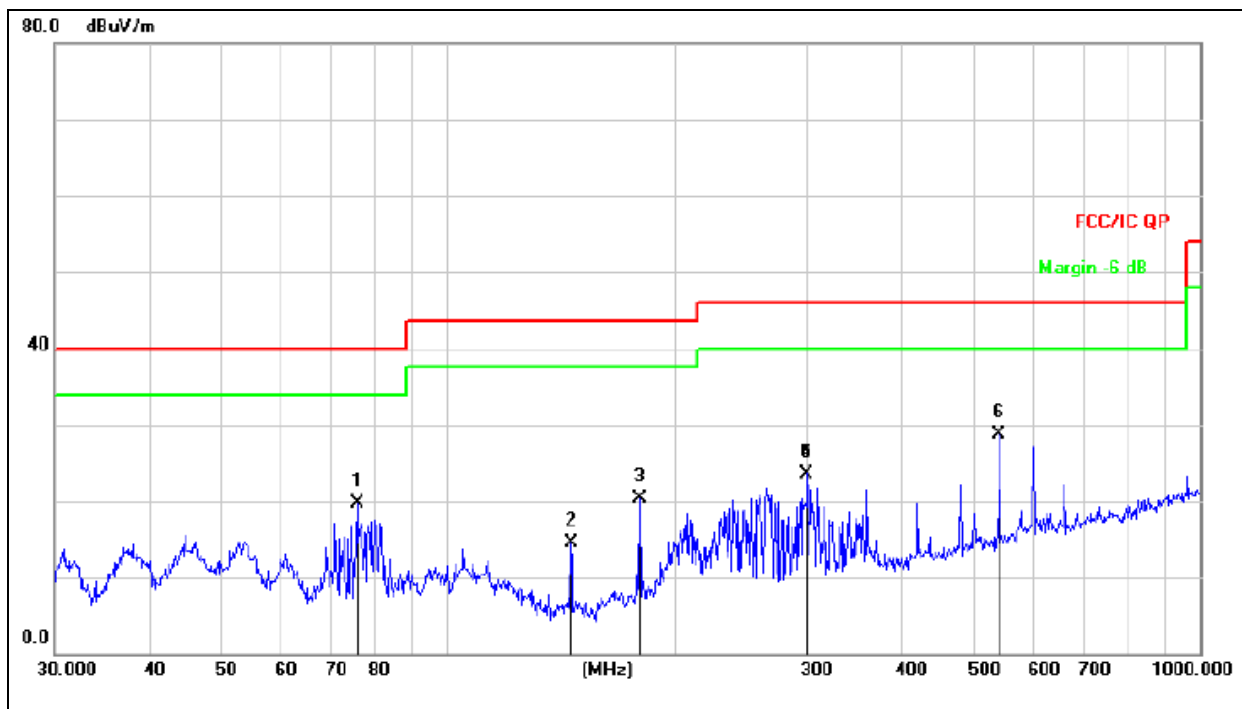

Remark:
Factor = Antenna Factor + Cable Loss – Pre-amplifier.

No.	Mk.	Freq. MHz	Reading Level dBuV	Correct Factor dB	Measure- ment dBuV/m	Limit dB/m	Over dB	Detector
1		75.7114	38.46	-18.75	19.71	40.00	-20.29	QP
2		145.8611	33.69	-19.18	14.51	43.50	-28.99	QP
3		180.0165	38.41	-18.08	20.33	43.50	-23.17	QP
4		300.3672	37.05	-13.45	23.60	46.00	-22.40	QP
5		300.3672	37.05	-13.45	23.60	46.00	-22.40	QP
6	*	541.3725	37.26	-8.61	28.65	46.00	-17.35	QP



Radiated Spurious Emission (1GHz to 10th harmonics)

GFSK

Polar (H/V)	Frequency (MHz)	Meter Reading (dBuV)	Pre-amplifier (dB)	Cable Loss (dB)	Antenna Factor (dB/m)	Emission Level (dBuV/m)	Limits (dBuV/m)	Margin (dB)	Detector Type
Low Channel 2402MHz									
V	2402.00	103.41	38.06	7.42	20.15	92.92	114.00	-21.08	PK
V	2402.00	90.58	38.06	7.42	20.15	80.09	94.00	-13.91	AV
V	4804.00	55.16	38.53	7.78	23.25	47.66	74.00	-26.34	PK
V	4804.00	43.21	38.53	7.78	23.25	35.71	54.00	-18.29	AV
V	16132.00	45.69	38.75	10.36	26.57	43.87	74.00	-30.13	PK
H	2402.00	110.69	38.06	7.42	20.15	100.20	114.00	-13.80	PK
H	2402.00	87.14	38.06	7.42	20.15	76.65	94.00	-17.35	AV
H	4804.00	52.67	38.53	7.78	23.25	45.17	74.00	-28.83	PK
H	4804.00	41.38	38.53	7.78	23.25	33.88	54.00	-20.12	AV
H	16132.00	55.26	38.75	10.36	26.57	53.44	74.00	-20.56	PK
Middle Channel 2441MHz									
V	2441.00	104.56	38.11	7.44	20.36	94.25	114.00	-19.75	PK
V	2441.00	91.23	38.11	7.44	20.36	80.92	94.00	-13.08	AV
V	4882.00	51.25	38.65	7.8	23.61	44.01	74.00	-29.99	PK
V	4882.00	42.17	38.65	7.8	23.61	34.93	54.00	-19.07	AV
V	16132.00	44.06	38.75	10.36	26.57	42.24	74.00	-31.76	PK
H	2441.00	104.36	38.11	7.44	20.36	94.05	114.00	-19.95	PK
H	2441.00	89.24	38.11	7.44	20.36	78.93	94.00	-15.07	AV
H	4882.00	50.84	38.65	7.8	23.61	43.60	74.00	-30.40	PK
H	4882.00	45.06	38.65	7.8	23.61	37.82	54.00	-16.18	AV
H	16132.00	43.07	38.75	10.36	26.57	41.25	74.00	-32.75	PK
High Channel 2480MHz									
V	2480.00	102.56	38.17	7.47	20.51	92.37	114.00	-21.63	PK
V	2480.00	90.36	38.17	7.47	20.51	80.17	94.00	-13.83	AV
V	4960.00	57.45	38.69	7.83	23.83	50.42	74.00	-23.58	PK
V	4960.00	41.28	38.69	7.83	23.83	34.25	54.00	-19.75	AV
V	16132.00	49.41	38.75	10.36	26.57	47.59	74.00	-26.41	PK
H	2480.00	116.36	38.17	7.47	20.51	106.17	114.00	-7.83	PK
H	2480.00	89.45	38.17	7.47	20.51	79.26	94.00	-14.74	AV
H	4960.00	54.03	38.69	7.83	23.83	47.00	74.00	-27.00	PK
H	4960.00	42.11	38.69	7.83	23.83	35.08	54.00	-18.92	AV
H	16132.00	49.26	38.75	10.36	26.57	47.44	74.00	-26.56	PK

Remark:

1. Emission Level = Meter Reading + Antenna Factor + Cable Loss – Pre-amplifier,
Margin= Emission Level - Limit
2. If peak below the average limit, the average emission was no test.
3. The amplitude of spurious emissions which are attenuated by more than 20dB below the permissible value has no need to be reported.



PI/4 DPSK

Polar (H/V)	Frequency (MHz)	Meter Reading (dBuV)	Pre-amplifier (dB)	Cable Loss (dB)	Antenna Factor (dB/m)	Emission Level (dBuV/m)	Limits (dBuV/m)	Margin (dB)	Detector Type
Low Channel 2402MHz									
V	2402.00	101.38	38.06	7.42	20.15	90.89	114.00	-23.11	PK
V	2402.00	95.39	38.06	7.42	20.15	84.90	94.00	-9.10	AV
V	4804.00	52.14	38.53	7.78	23.25	44.64	74.00	-29.36	PK
V	4804.00	45.39	38.53	7.78	23.25	37.89	54.00	-16.11	AV
V	16132.00	47.14	38.75	10.36	26.57	45.32	74.00	-28.68	PK
H	2402.00	101.39	38.06	7.42	20.15	90.90	114.00	-23.10	PK
H	2402.00	88.38	38.06	7.42	20.15	77.89	94.00	-16.11	AV
H	4804.00	52.21	38.53	7.78	23.25	44.71	74.00	-29.29	PK
H	4804.00	41.39	38.53	7.78	23.25	33.89	54.00	-20.11	AV
H	16132.00	43.56	38.75	10.36	26.57	41.74	74.00	-32.26	PK
Middle Channel 2441MHz									
V	2441.00	106.23	38.11	7.44	20.36	95.92	114.00	-18.08	PK
V	2441.00	88.19	38.11	7.44	20.36	77.88	94.00	-16.12	AV
V	4882.00	55.13	38.65	7.8	23.61	47.89	74.00	-26.11	PK
V	4882.00	44.17	38.65	7.8	23.61	36.93	54.00	-17.07	AV
V	16132.00	41.23	38.75	10.36	26.57	39.41	74.00	-34.59	PK
H	2441.00	101.25	38.11	7.44	20.36	90.94	114.00	-23.06	PK
H	2441.00	81.69	38.11	7.44	20.36	71.38	94.00	-22.62	AV
H	4882.00	53.78	38.65	7.8	23.61	46.54	74.00	-27.46	PK
H	4882.00	40.46	38.65	7.8	23.61	33.22	54.00	-20.78	AV
H	16132.00	46.39	38.75	10.36	26.57	44.57	74.00	-29.43	PK
High Channel 2480MHz									
V	2480.00	103.15	38.17	7.47	20.51	92.96	114.00	-21.04	PK
V	2480.00	87.04	38.17	7.47	20.51	76.85	94.00	-17.15	AV
V	4960.00	56.47	38.69	7.83	23.83	49.44	74.00	-24.56	PK
V	4960.00	45.22	38.69	7.83	23.83	38.19	54.00	-15.81	AV
V	16132.00	49.36	38.75	10.36	26.57	47.54	74.00	-26.46	PK
H	2480.00	105.28	38.17	7.47	20.51	95.09	114.00	-18.91	PK
H	2480.00	89.29	38.17	7.47	20.51	79.10	94.00	-14.90	AV
H	4960.00	56.32	38.69	7.83	23.83	49.29	74.00	-24.71	PK
H	4960.00	41.24	38.69	7.83	23.83	34.21	54.00	-19.79	AV
H	16132.00	50.02	38.75	10.36	26.57	48.20	74.00	-25.80	PK

Remark:

1. Emission Level = Meter Reading + Antenna Factor + Cable Loss – Pre-amplifier,
Margin= Emission Level - Limit
2. If peak below the average limit, the average emission was no test.
3. The amplitude of spurious emissions which are attenuated by more than 20dB below the permissible value has no need to be reported.



CONDUCTED EMISSION MEASUREMENT

GFSK

Low Channel 2402MHz

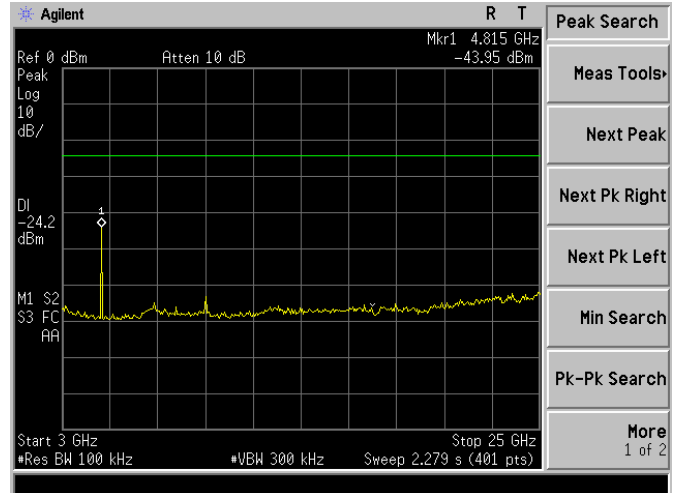
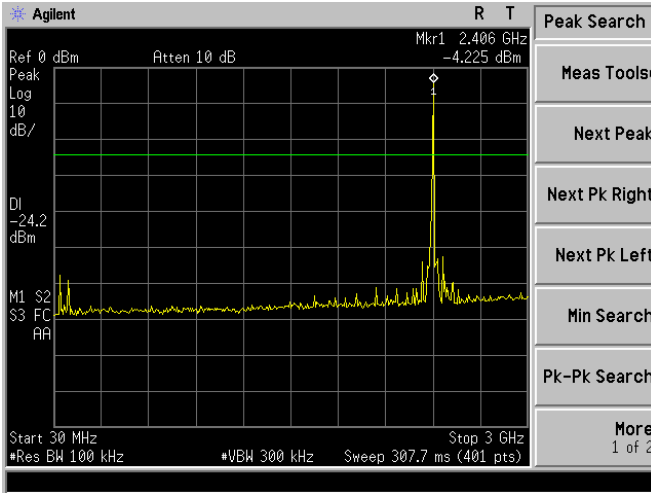

Middle Channel 2441MHz

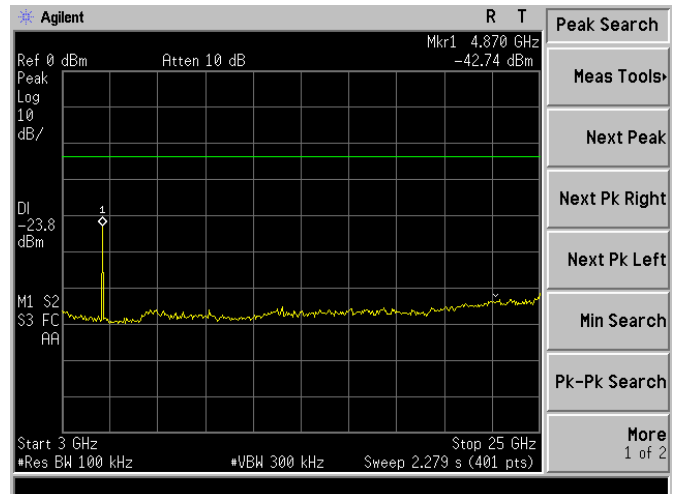
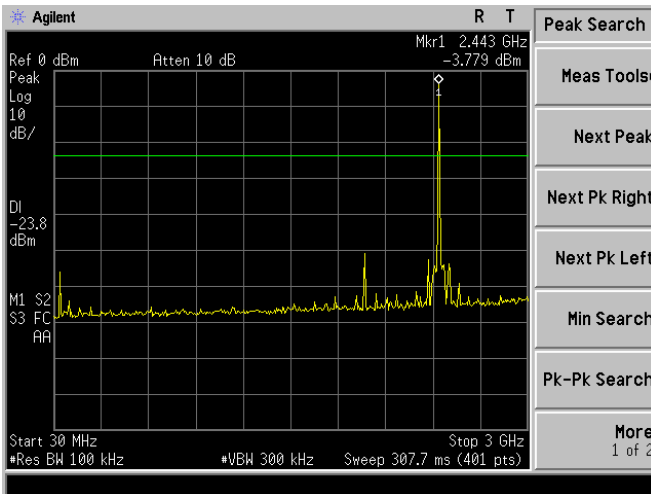

High Channel 2480MHz

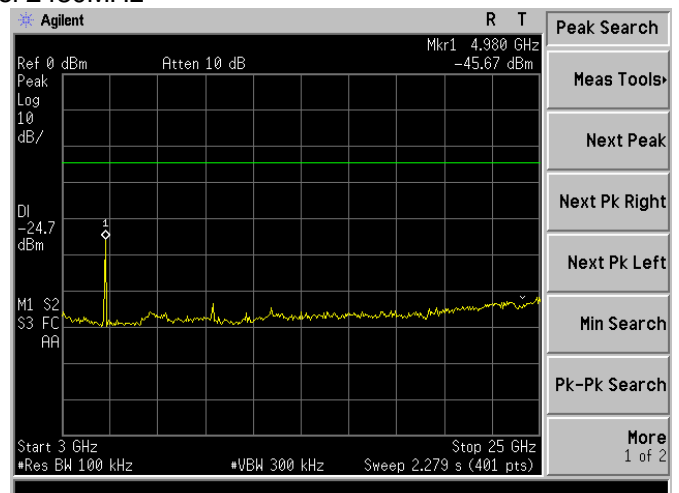
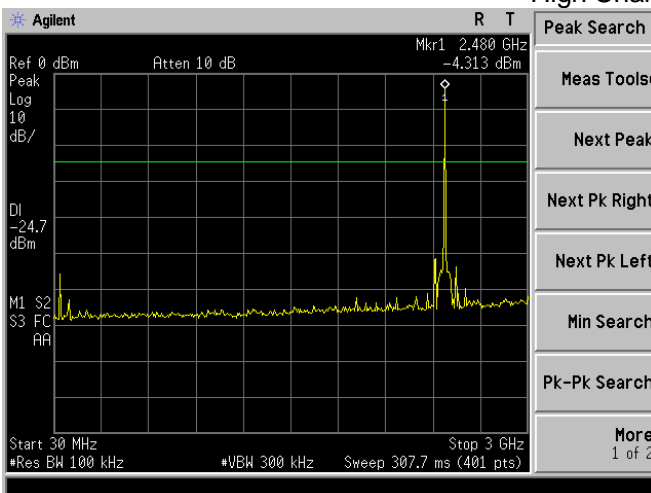



PI/4 DPSK

Low Channel 2402MHz

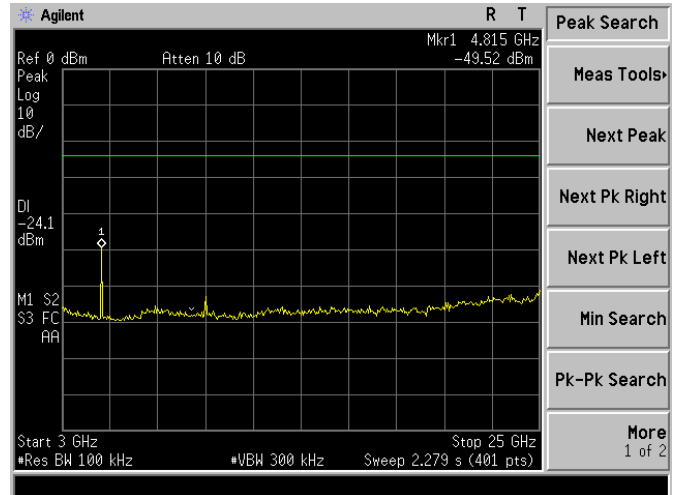
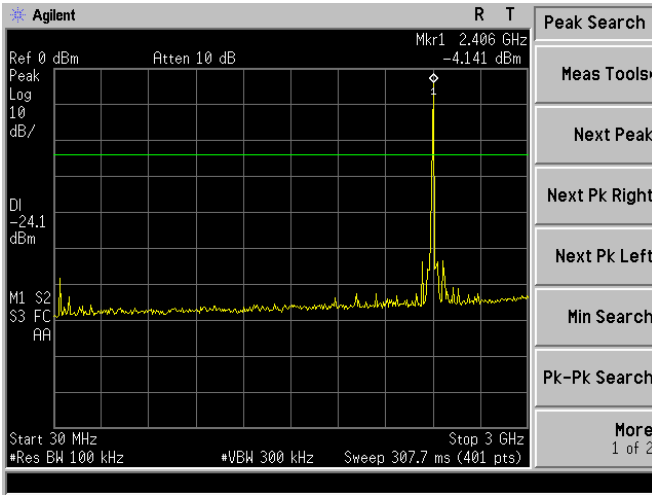

Middle Channel 2441MHz

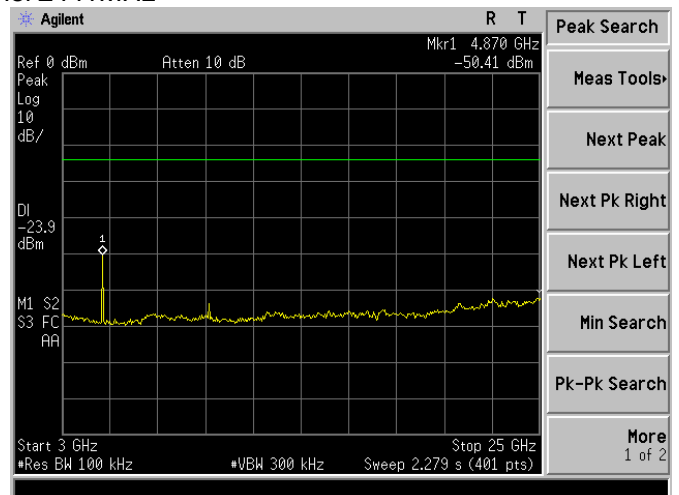
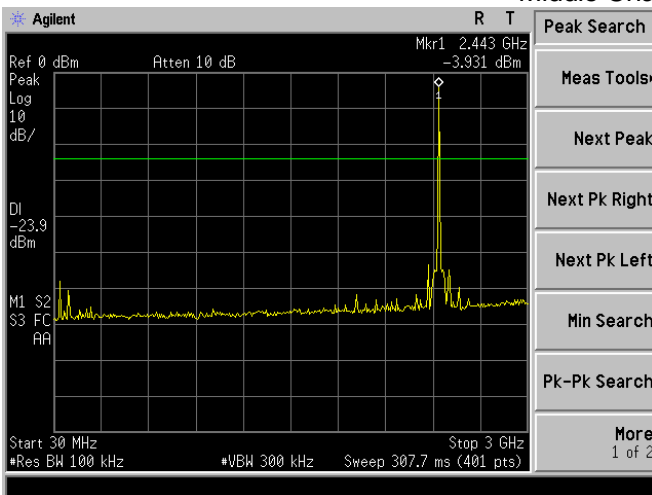

High Channel 2480MHz

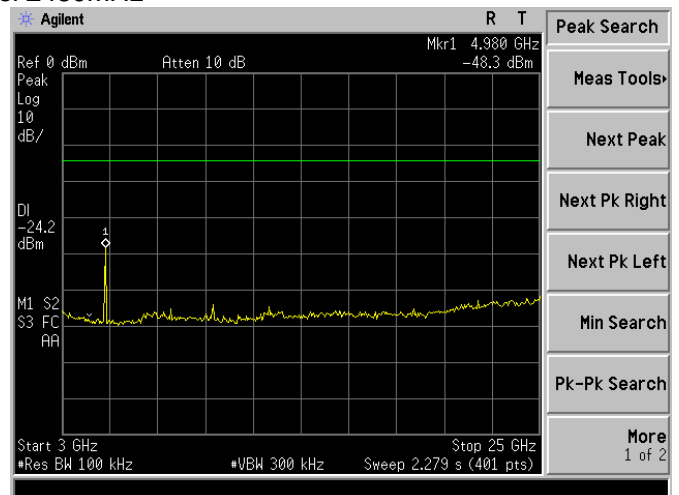
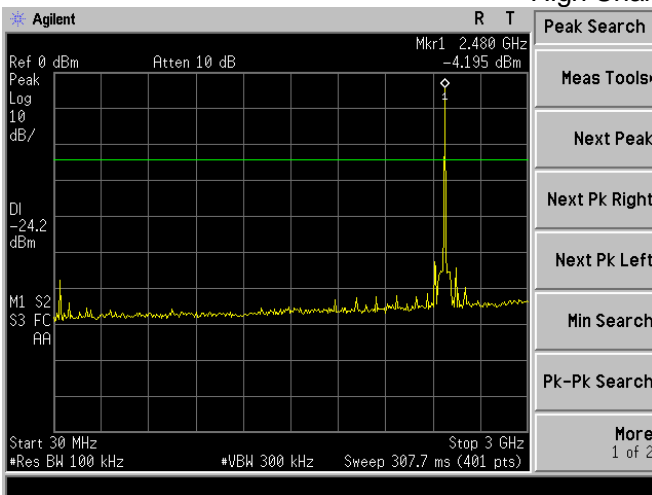



4. BANDWIDTH TEST

4.1 APPLIED PROCEDURES / LIMIT

FCC Part15 (15.249) , Subpart C				
Section	Test Item	Limit	Frequency Range (MHz)	Result
15.249	Bandwidth	(20dB bandwidth)	2400-2483.5	PASS

Spectrum Parameter	Setting
Attenuation	Auto
Span Frequency	> Measurement Bandwidth or Channel Separation
RB	100KHz
VB	≥RBW
Detector	Peak
Trace	Max Hold
Sweep Time	Auto

4.1.1 TEST PROCEDURE

- a. The EUT was directly connected to the spectrum analyzer and antenna output port as show in the block diagram below,
- b. Spectrum Setting : RBW= 100KHz, VBW≥ RBW, Sweep time = Auto.

4.1.2 DEVIATION FROM STANDARD

No deviation.

4.1.3 TEST SETUP



4.1.4 EUT OPERATION CONDITIONS

The EUT tested system was configured as the statements of 2.4 Unless otherwise a special operating condition is specified in the follows during the testing.



4.1.5 TEST RESULTS

Temperature :	25 °C	Relative Humidity :	55%
Pressure :	1012 hPa	Test Voltage :	DC 7.4V
Test Mode :	CH00/CH39/C78		

	Frequency	20dB Bandwidth (kHz)	Result
GFSK	2402 MHz	1107	PASS
	2441 MHz	1099	PASS
	2480 MHz	1104	PASS
PI/4 DPSK	2402 MHz	1386	PASS
	2441 MHz	1385	PASS
	2480 MHz	1384	PASS



GFSK

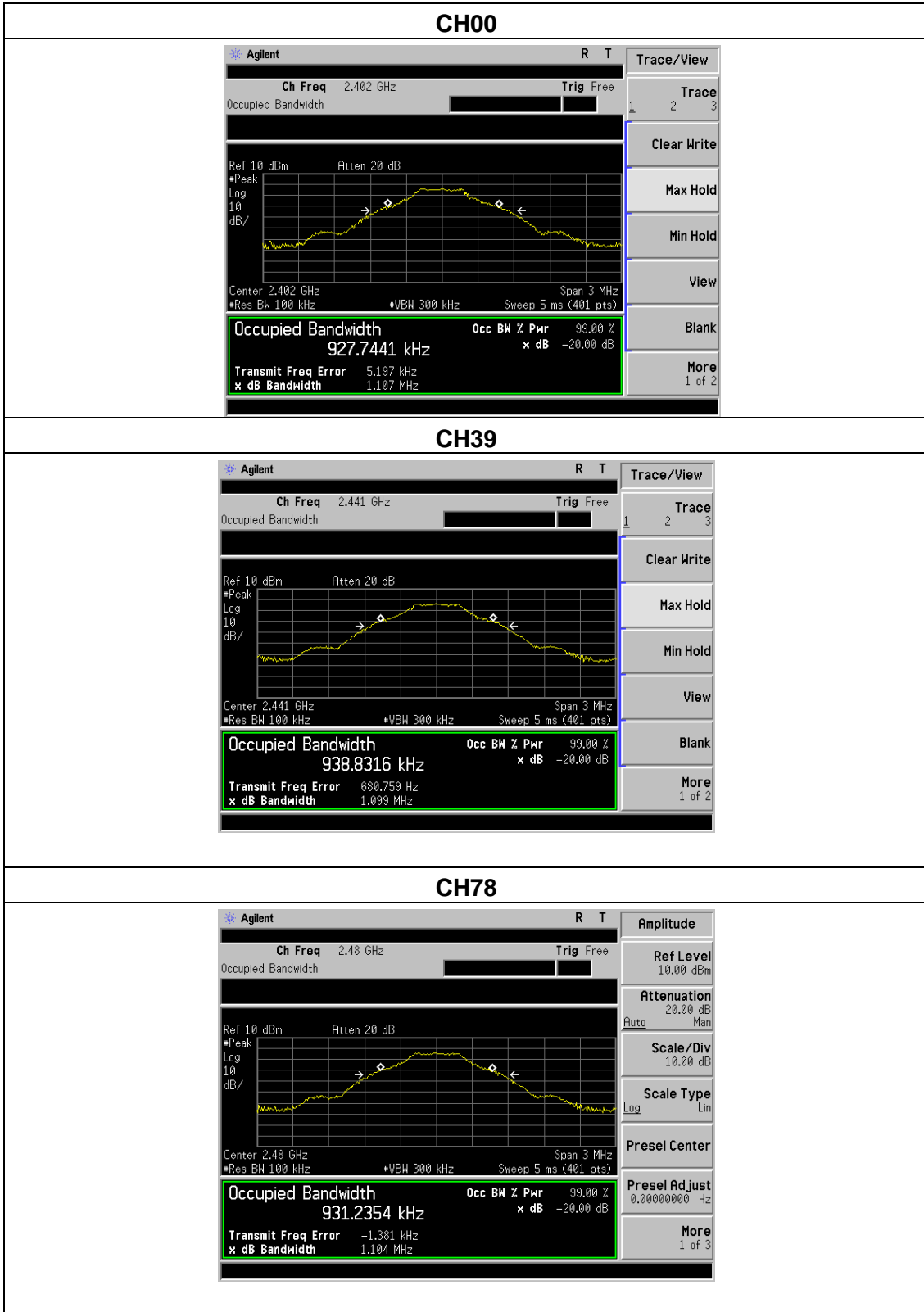



PI/4 DPSK

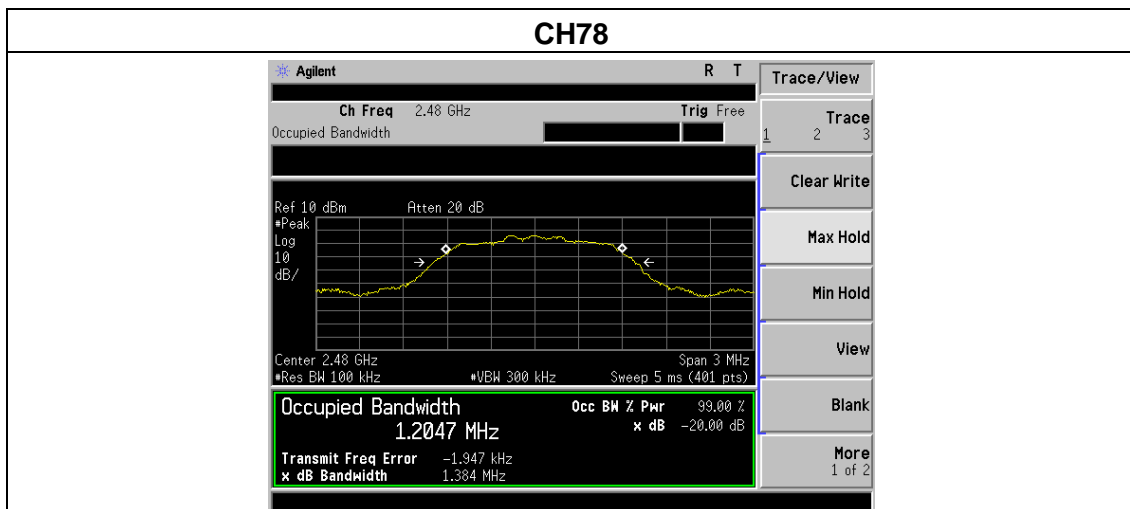
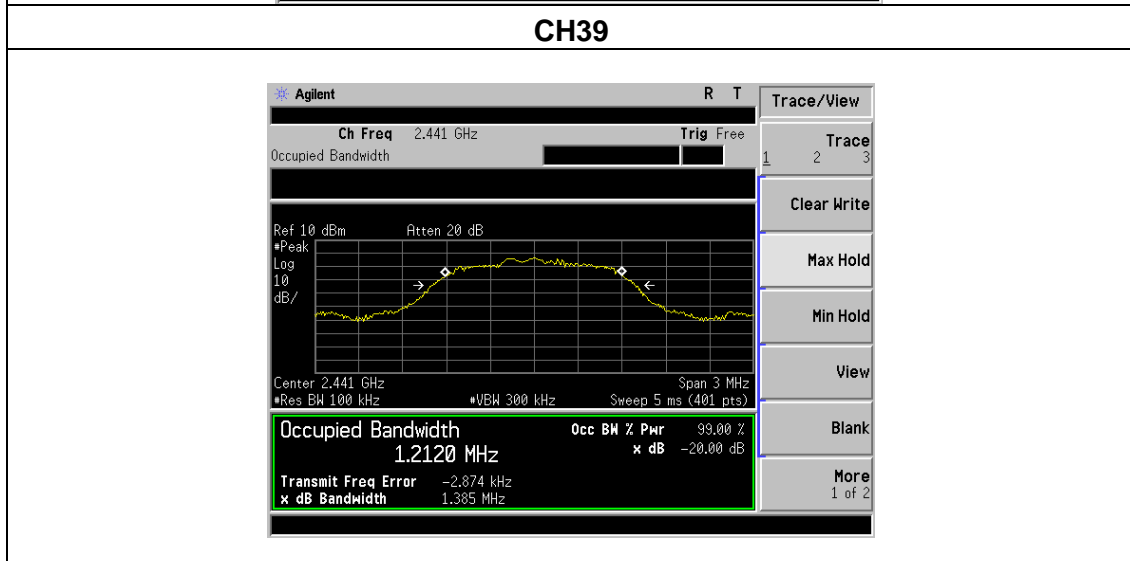
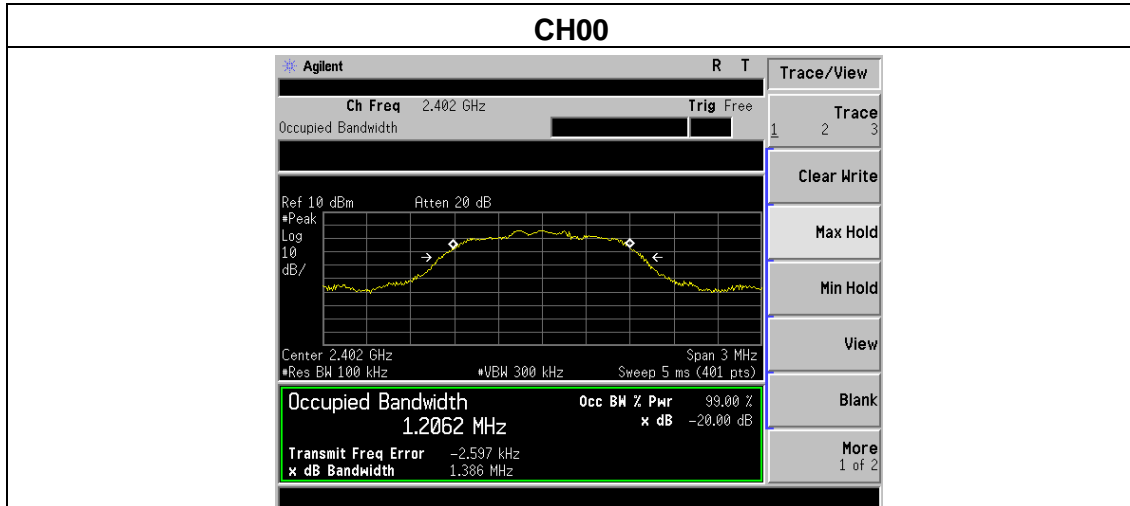



5. 100 KHZ BANDWIDTH OF FREQUENCY BAND EDGE APPLICABLE STANDARD

Emissions radiated outside of the specified frequency bands, except for harmonics, shall be attenuated by at least 50 dB below the level of the fundamental or to the general radiated emission limits in § 15.209, whichever is the lesser attenuation

TEST PROCEDURE

- a) Check the calibration of the measuring instrument using either an internal calibrator or a known signal from an external generator.
- b) Position the EUT without connection to measurement instrument. Turn on the EUT and connect its antenna terminal to measurement instrument via a low loss cable. Then set it to any one measured frequency within its operating range, and make sure the instrument is operated in its linear range.
- c) i) VBW for Peak, Quasi-peak, or Average Detector Function: $3 \times \text{RBW}$
- d) Repeat above procedures until all measured frequencies were complete.

Note:

Both horizontal and vertical antenna polarities were tested and performed pretest to three orthogonal axis. The worst case emissions were reported

5.1 DEVIATION FROM STANDARD

No deviation.

5.2 TEST SETUP

5.3 EUT OPERATION CONDITIONS

The EUT tested system was configured as the statements of 2.4 Unless otherwise a special operating condition is specified in the follows during the testing.



5.4 TEST RESULTS

Temperature :	25 °C	Relative Humidity :	54%
Pressure :	1012 hPa	Test Voltage :	DC 7.4V
Test Mode :	CH00/CH78		

	Polar (H/V)	Frequency (MHz)	Meter Reading (dBuV)	Pre-amplifier (dB)	Cable Loss (dB)	Antenna Factor (dB/m)	Emission level (dBuV/m)	Limits (dBuV/m)		Result
							PK	PK	AV	
GFSK	Low Channel 2402MHz									
	H	2390.00	58.46	38.06	7.42	20.15	47.97	74.00	54.00	PASS
	H	2400.00	59.47	38.06	7.42	20.15	48.98	74.00	54.00	PASS
	V	2390.00	58.37	38.06	7.42	20.15	47.88	74.00	54.00	PASS
	V	2400.00	59.12	38.06	7.42	20.15	48.63	74.00	54.00	PASS
	High Channel 2480MHz									
	H	2483.50	59.78	38.17	7.45	20.54	49.60	74.00	54.00	PASS
	H	2485.50	58.07	38.17	7.45	20.54	47.89	74.00	54.00	PASS
PI/4 DPSK	Low Channel 2402MHz									
	H	2390.00	58.64	38.06	7.42	20.15	48.15	74.00	54.00	PASS
	H	2400.00	57.26	38.06	7.42	20.15	46.77	74.00	54.00	PASS
	V	2390.00	57.80	38.06	7.42	20.15	47.31	74.00	54.00	PASS
	V	2400.00	59.15	38.06	7.42	20.15	48.66	74.00	54.00	PASS
	High Channel 2480MHz									
	H	2483.50	59.71	38.17	7.45	20.54	49.53	74.00	54.00	PASS
	H	2485.50	59.77	38.17	7.45	20.54	49.59	74.00	54.00	PASS
V	2483.50	56.64	38.2	7.45	20.54	46.43	74.00	54.00	PASS	
V	2485.50	56.49	38.2	7.45	20.54	46.28	74.00	54.00	PASS	

Remark:

1. Emission Level = Meter Reading + Antenna Factor + Cable Loss – Pre-amplifier, Margin= Emission Level - Limit
2. If the PK measured levels comply with average limit, then the average level were deemed to comply with average limit.



GFSK

2402MHz Horizontal

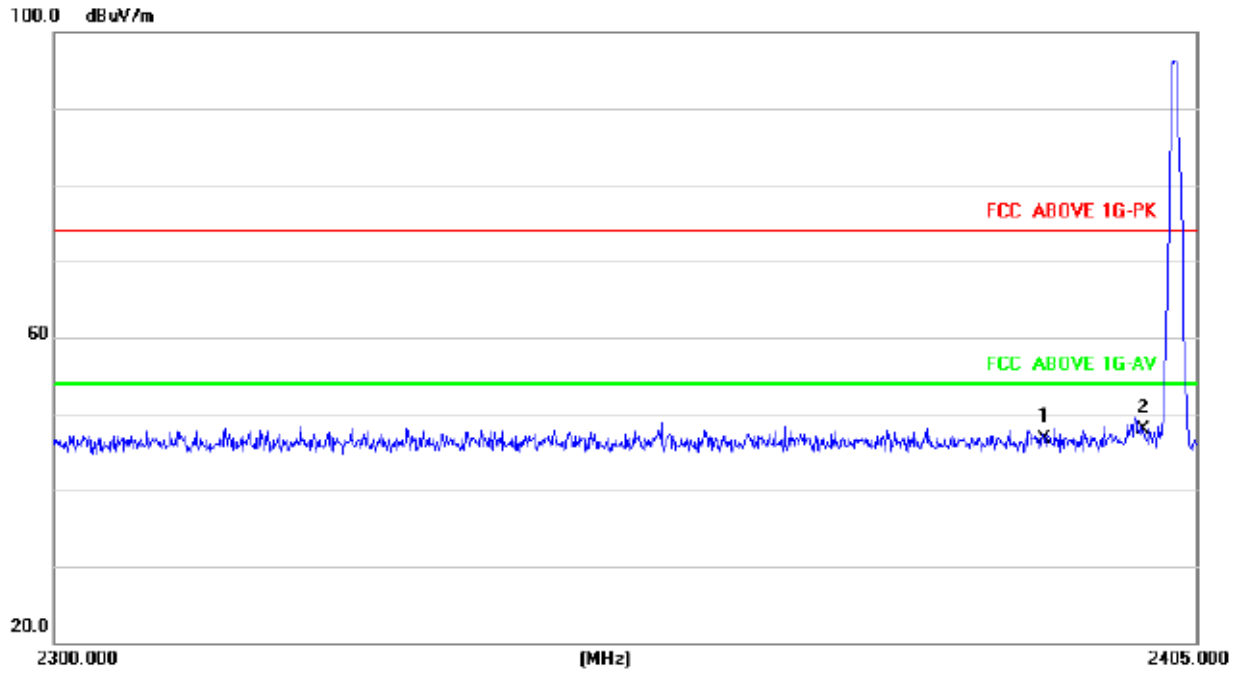

2402MHz Vertical

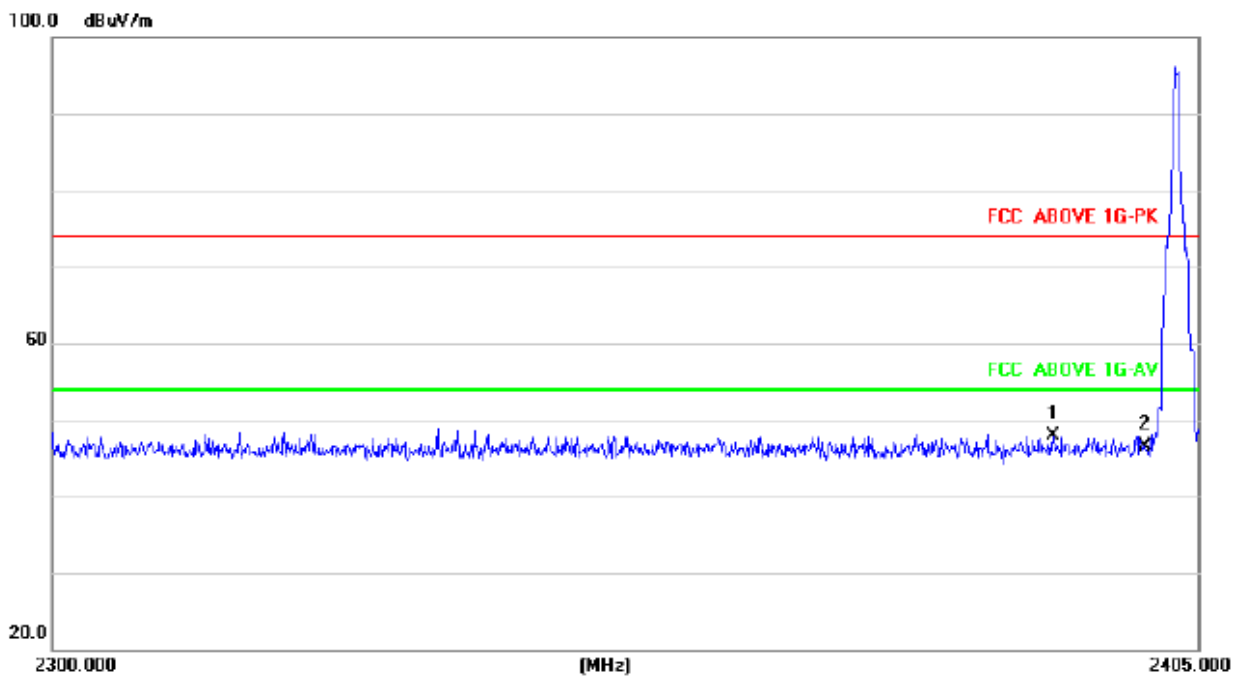



2480MHz Horizontal

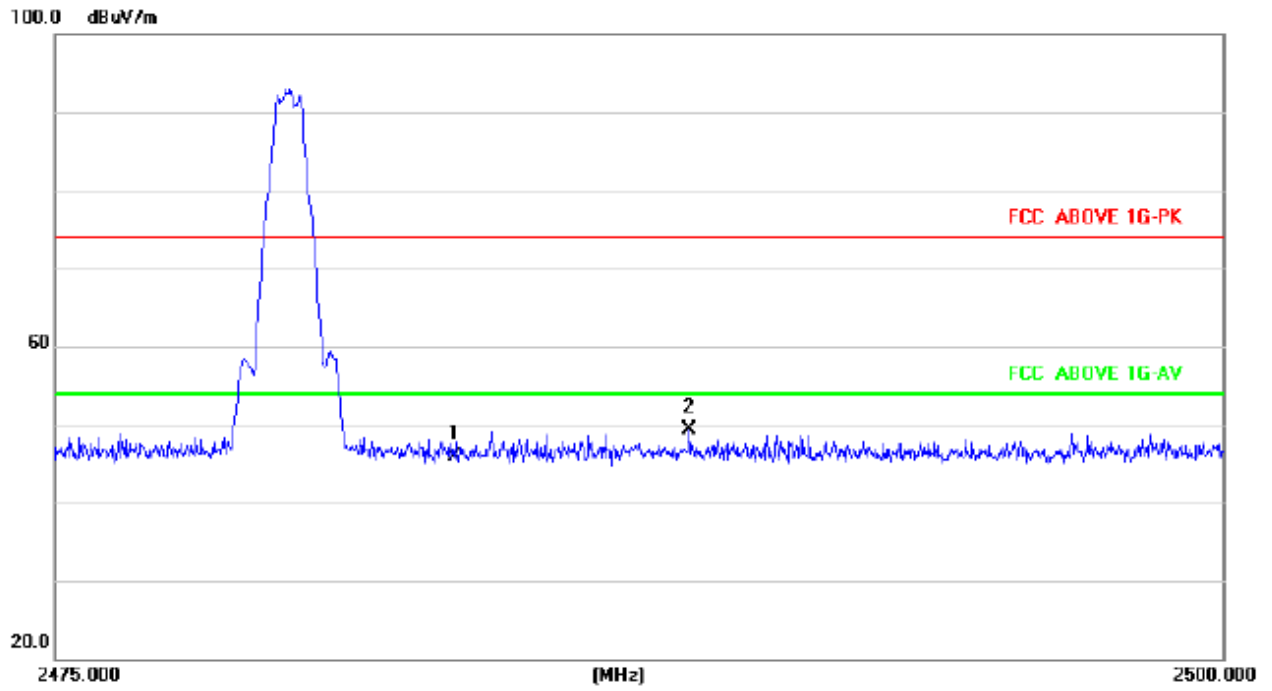

2480MHz Vertical

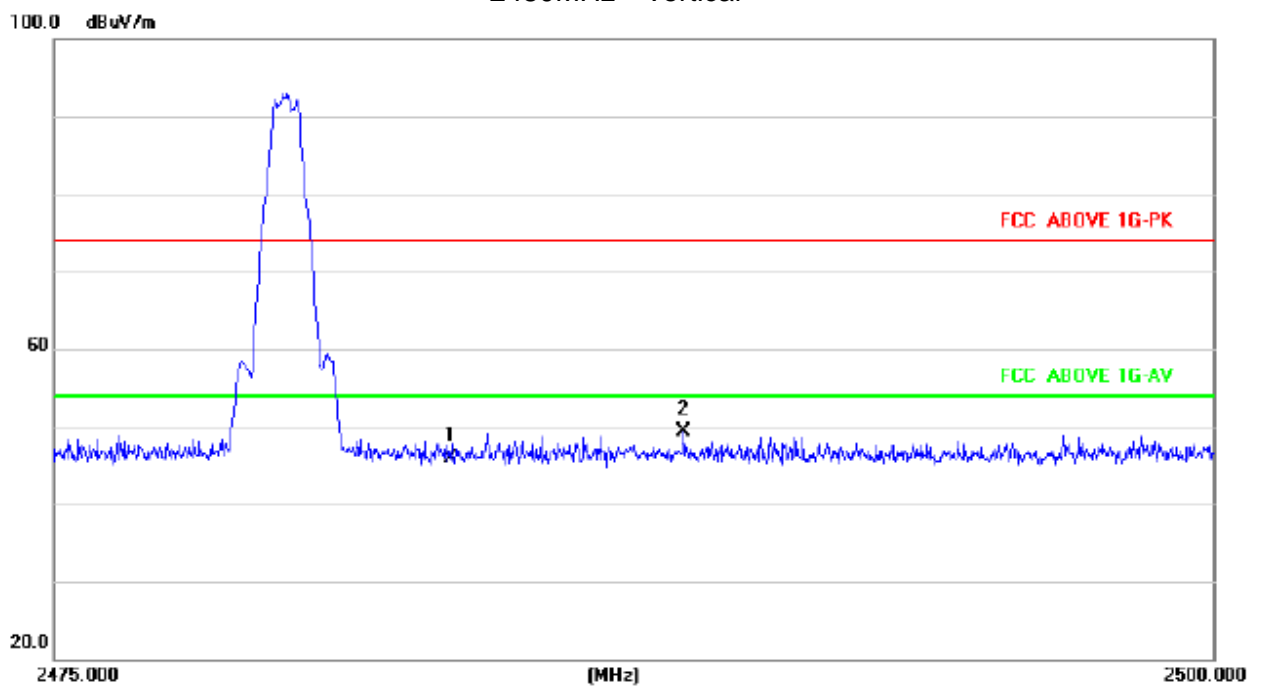



PI/4 DPSK

2402MHz Horizontal

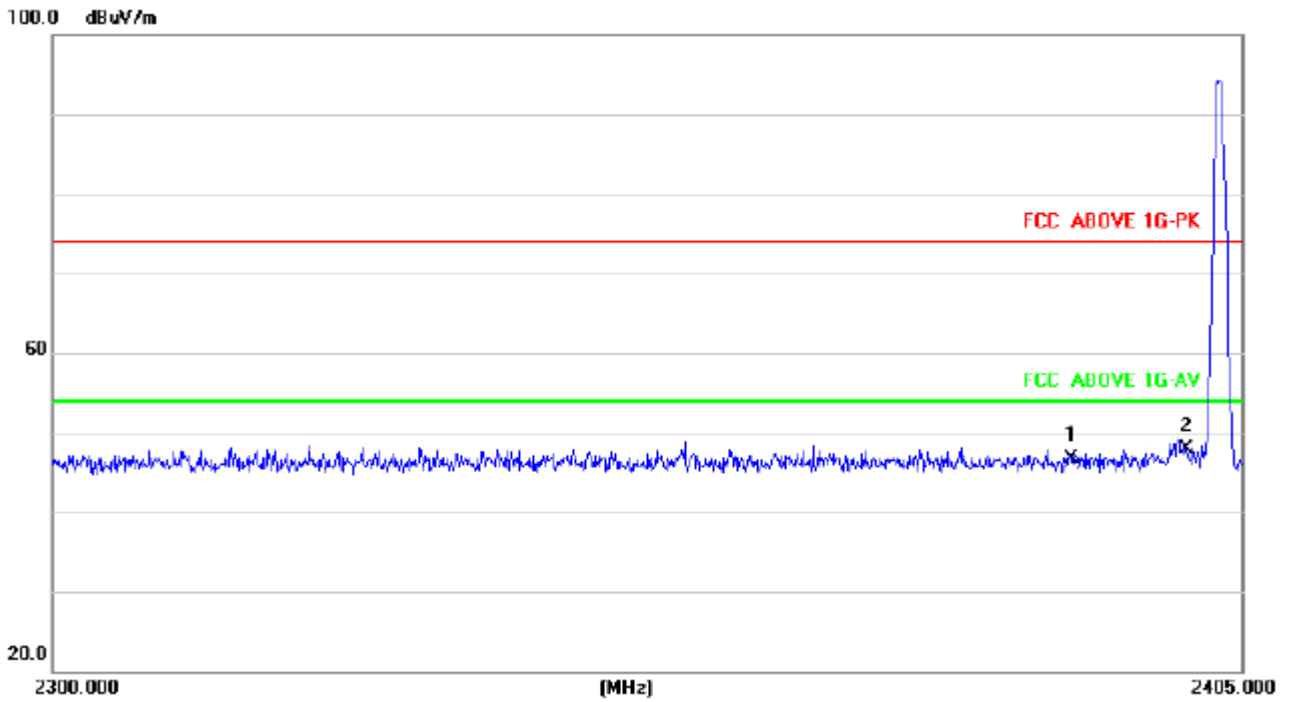

2402MHz Vertical

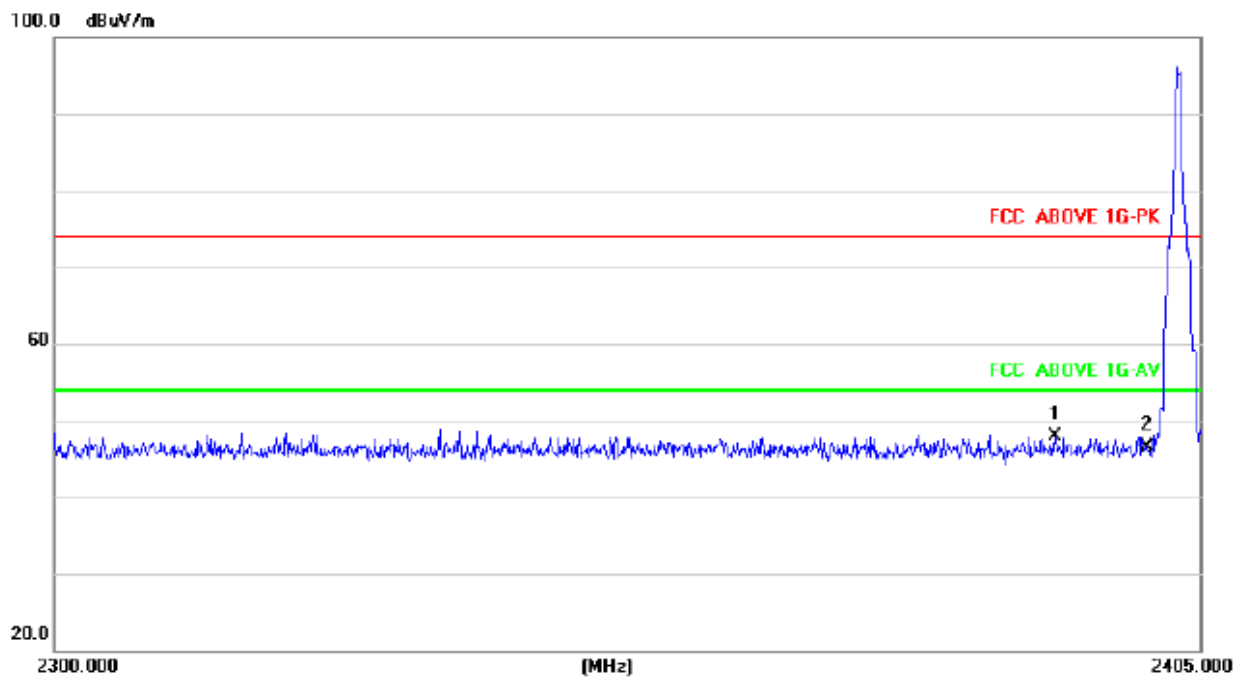



2480MHz Horizontal

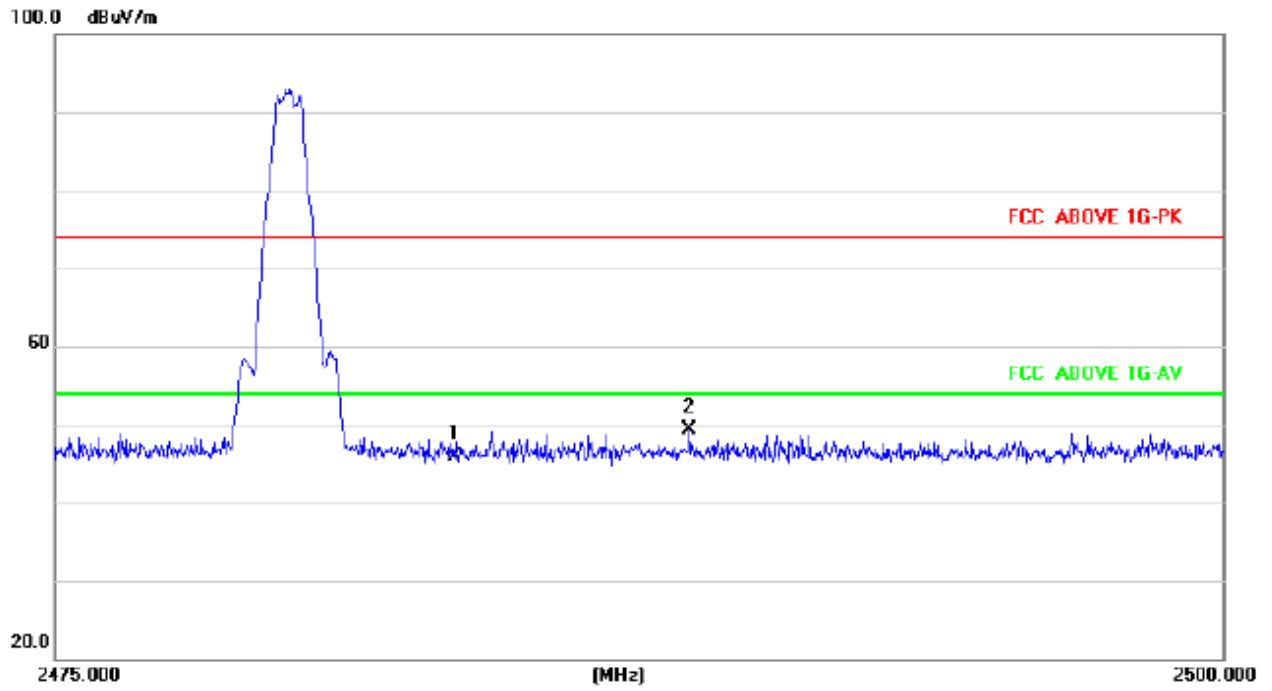

2480MHz Vertical

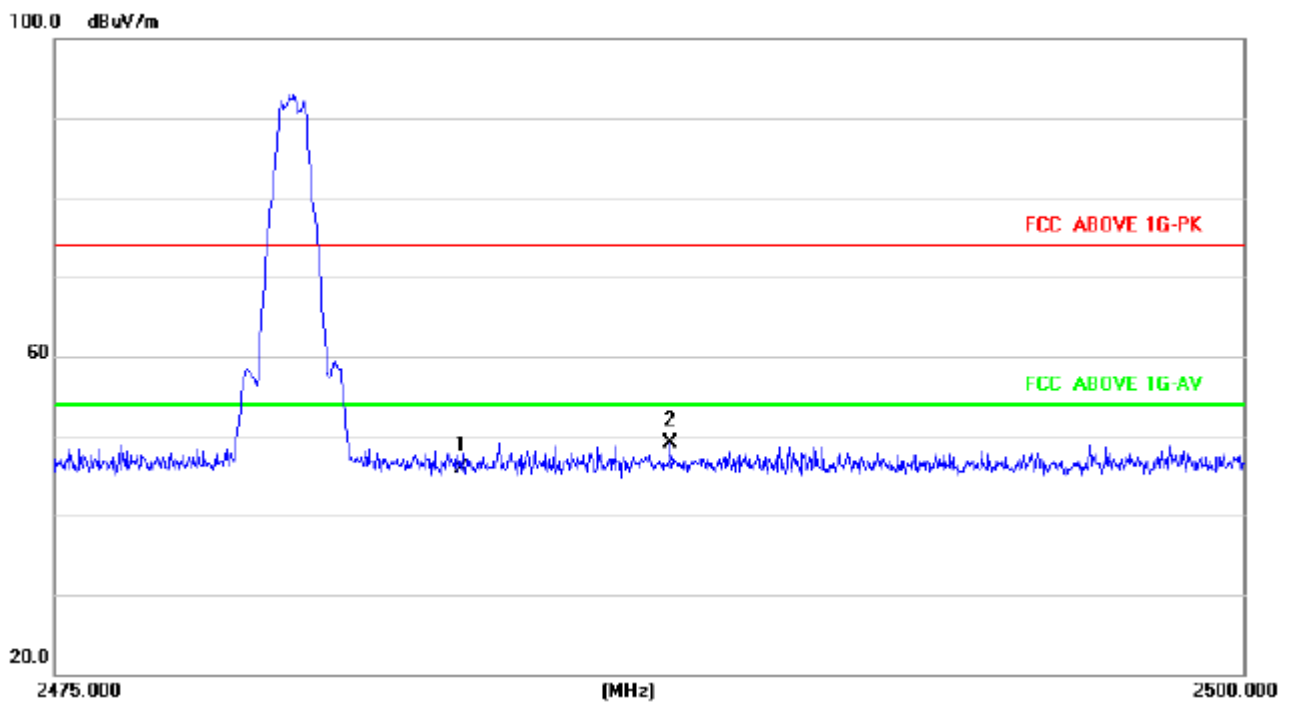



6. ANTENNA REQUIREMENT

6.1 STANDARD REQUIREMENT

15.203 requirement: For intentional device, according to 15.203: an intentional radiator shall be designed to ensure that no antenna other than that furnished by the responsible party shall be used with the device.

6.2 EUT ANTENNA

The EUT antenna is PCB Antenna, It complies with the standard requirement.

7. EUT TEST PHOTO

Conducted Emission



Radiated Measurement Photos

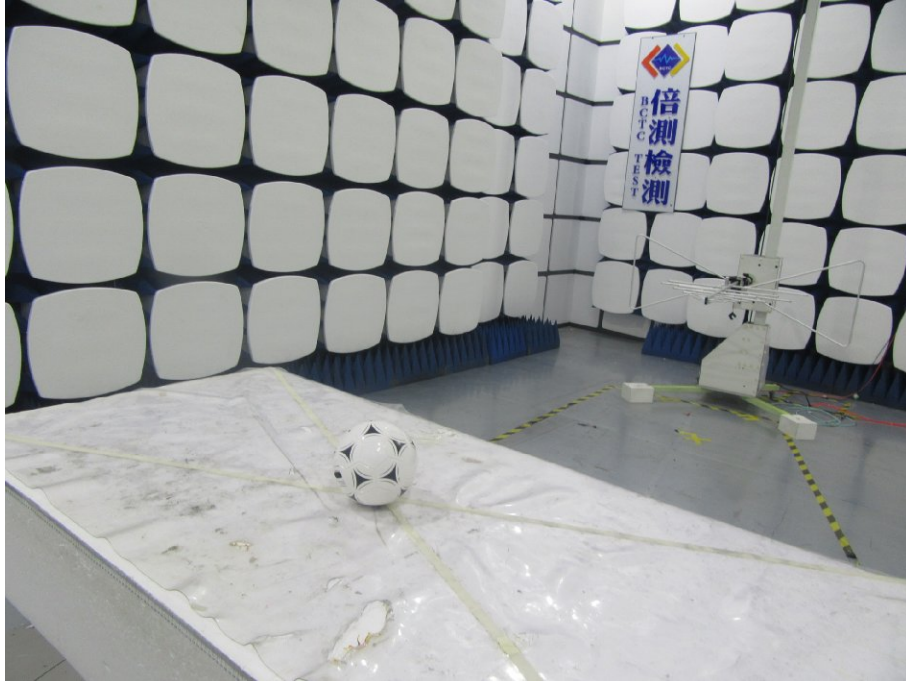

8. EUT PHOTO



***** END OF REPORT *****