



FCC RADIO TEST REPORT

FCC ID : 2AQQ-6247
Equipment : HDMI Digital Media Receiver
Model Name : E9L29Y
Applicant : MX Processing LLC
309 Fellowship Road
East Gate Center, Suite 200
Mount Laurel, New Jersey 08054
Standard : FCC Part 15 Subpart C §15.247

The test was completed on Jul. 12, 2018. We, SPORTON INTERNATIONAL INC., would like to declare that the tested sample has been evaluated in accordance with the test procedures and has been in compliance with the applicable technical standards.

The report must not be used by the client to claim product certification, approval, or endorsement by TAF or any agency of government.

The test results in this report apply exclusively to the tested model / sample. Without written approval of SPORTON INTERNATIONAL INC. EMC & Wireless Communications Laboratory, the test report shall not be reproduced except in full.

Reviewed by: Jones Tsai

SPORTON INTERNATIONAL INC. EMC & Wireless Communications Laboratory
No. 52, Huaya 1st Rd., Guishan Dist., Taoyuan City, Taiwan (R.O.C.)



Table of Contents

| | |
|---|-----------|
| History of this test report..... | 3 |
| Summary of Test Result..... | 4 |
| 1 General Description..... | 5 |
| 1.1 Product Feature of Equipment Under Test..... | 5 |
| 1.2 Product Specification of Equipment Under Test..... | 5 |
| 1.3 Modification of EUT | 5 |
| 1.4 Testing Location | 6 |
| 1.5 Applicable Standards..... | 6 |
| 2 Test Configuration of Equipment Under Test..... | 7 |
| 2.1 Carrier Frequency Channel | 7 |
| 2.2 Test Mode..... | 8 |
| 2.3 Connection Diagram of Test System..... | 9 |
| 2.4 Support Unit used in test configuration and system | 10 |
| 2.5 EUT Operation Test Setup | 10 |
| 2.6 Measurement Results Explanation Example..... | 10 |
| 3 Test Result..... | 11 |
| 3.1 Number of Channel Measurement | 11 |
| 3.2 Hopping Channel Separation Measurement | 13 |
| 3.3 Dwell Time Measurement..... | 19 |
| 3.4 20dB and 99% Bandwidth Measurement | 21 |
| 3.5 Output Power Measurement..... | 32 |
| 3.6 Conducted Band Edges Measurement..... | 33 |
| 3.7 Conducted Spurious Emission Measurement | 40 |
| 3.8 Radiated Band Edges and Spurious Emission Measurement | 50 |
| 3.9 AC Conducted Emission Measurement..... | 54 |
| 3.10 Antenna Requirements..... | 56 |
| 4 List of Measuring Equipment | 57 |
| 5 Uncertainty of Evaluation..... | 59 |
| Appendix A. Conducted Test Results | |
| Appendix B. AC Conducted Emission Test Result | |
| Appendix C. Radiated Spurious Emission | |
| Appendix D. Radiated Spurious Emission Plots | |
| Appendix E. Duty Cycle Plots | |



History of this test report

| Report No. | Version | Description | Issued Date |
|--------------|---------|-------------------------|---------------|
| FR832126-02A | 01 | Initial issue of report | Aug. 02, 2018 |
| | | | |
| | | | |
| | | | |
| | | | |
| | | | |
| | | | |
| | | | |
| | | | |
| | | | |
| | | | |
| | | | |
| | | | |
| | | | |
| | | | |
| | | | |
| | | | |
| | | | |
| | | | |
| | | | |



Summary of Test Result

| Report Clause | Ref Std. Clause | Test Items | Result (PASS/FAIL) |
|---------------|--------------------|--|--------------------|
| 3.1 | 15.247(a)(1) | Number of Channels | Pass |
| 3.2 | 15.247(a)(1) | Hopping Channel Separation | Pass |
| 3.3 | 15.247(a)(1) | Dwell Time of Each Channel | Pass |
| 3.4 | 15.247(a)(1) | 20dB Bandwidth | Pass |
| 3.4 | 2.1049 | 99% Occupied Bandwidth | Reporting only |
| 3.5 | 15.247(b)(1) | Peak Output Power | Pass |
| 3.6 | 15.247(d) | Conducted Band Edges | Pass |
| 3.7 | 15.247(d) | Conducted Spurious Emission | Pass |
| 3.8 | 15.247(d) | Radiated Band Edges and Radiated Spurious Emission | Pass |
| 3.9 | 15.207 | AC Conducted Emission | Pass |
| 3.10 | 15.203 & 15.247(b) | Antenna Requirement | Pass |

Reviewed by: Joseph Lin

Report Producer: Nancy Yang



1 General Description

1.1 Product Feature of Equipment Under Test

| Product Feature | |
|---------------------------------|---|
| Equipment | HDMI Digital Media Receiver |
| Model Name | E9L29Y |
| FCC ID | 2AQIQ-6247 |
| EUT supports Radios application | WLAN 11b/g/n HT20 WLAN 11a/n HT20/HT40 WLAN 11ac VHT20/VHT40/VHT80 Bluetooth BR/EDR/LE |

1.2 Product Specification of Equipment Under Test

| Standards-related Product Specification | |
|---|--|
| Tx/Rx Frequency Range | 2402 MHz ~ 2480 MHz |
| Number of Channels | 79 |
| Carrier Frequency of Each Channel | 2402+n*1 MHz; n=0~78 |
| Maximum Output Power to Antenna | Bluetooth BR(1Mbps) : 6.02 dBm (0.004 W) Bluetooth EDR (2Mbps) : 6.03 dBm (0.004 W) Bluetooth EDR (3Mbps) : 6.00 dBm (0.004 W) |
| 99% Occupied Bandwidth | Bluetooth BR(1Mbps) : 0.832MHz Bluetooth EDR (2Mbps) : 1.136MHz Bluetooth EDR (3Mbps) : 1.128MHz |
| Antenna Type / Gain | Fixed Internal Antenna type with gain 1.1 dBi |
| Type of Modulation | Bluetooth BR (1Mbps) : GFSK Bluetooth EDR (2Mbps) : $\pi/4$ -DQPSK Bluetooth EDR (3Mbps) : 8-DPSK |

1.3 Modification of EUT

No modifications are made to the EUT during all test items.



1.4 Testing Location

Sporton Lab is accredited to ISO 17025 by Taiwan Accreditation Foundation (TAF code : 1190) and the FCC designation No. TW1190 and TW0007 under the FCC 2.948(e) by Mutual Recognition Agreement (MRA) in FCC Test.

| | | |
|---------------------------|---|---------|
| Test Site | SPORTON INTERNATIONAL INC. | |
| Test Site Location | No.52, Huaya 1st Rd., Guishan Dist., Taoyuan City, Taiwan (R.O.C.) TEL: +886-3-327-3456 FAX: +886-3-328-4978 | |
| Test Site No. | Sporton Site No. | |
| | TH05-HY | CO05-HY |

Note: The test site complies with ANSI C63.4 2014 requirement.

| | | |
|---------------------------|---|--|
| Test Site | SPORTON INTERNATIONAL INC. | |
| Test Site Location | No.58, Aly. 75, Ln. 564, Wenhua 3rd, Rd., Guishan Dist., Taoyuan City, Taiwan (R.O.C.) TEL: +886-3-327-0868 FAX: +886-3-327-0855 | |
| Test Site No. | Sporton Site No. | |
| | 03CH12-HY | |

Note: The test site complies with ANSI C63.4 2014 requirement.

1.5 Applicable Standards

According to the specifications of the manufacturer, the EUT must comply with the requirements of the following standards:

- ♦ FCC Part 15 Subpart C §15.247
- ♦ ANSI C63.10-2013

Remark: All test items were verified and recorded according to the standards and without any deviation during the test.



2 Test Configuration of Equipment Under Test

2.1 Carrier Frequency Channel

| Frequency Band | Channel | Freq. (MHz) | Channel | Freq. (MHz) | Channel | Freq. (MHz) |
|-----------------|---------|-------------|---------|-------------|---------|-------------|
| 2400-2483.5 MHz | 0 | 2402 | 27 | 2429 | 54 | 2456 |
| | 1 | 2403 | 28 | 2430 | 55 | 2457 |
| | 2 | 2404 | 29 | 2431 | 56 | 2458 |
| | 3 | 2405 | 30 | 2432 | 57 | 2459 |
| | 4 | 2406 | 31 | 2433 | 58 | 2460 |
| | 5 | 2407 | 32 | 2434 | 59 | 2461 |
| | 6 | 2408 | 33 | 2435 | 60 | 2462 |
| | 7 | 2409 | 34 | 2436 | 61 | 2463 |
| | 8 | 2410 | 35 | 2437 | 62 | 2464 |
| | 9 | 2411 | 36 | 2438 | 63 | 2465 |
| | 10 | 2412 | 37 | 2439 | 64 | 2466 |
| | 11 | 2413 | 38 | 2440 | 65 | 2467 |
| | 12 | 2414 | 39 | 2441 | 66 | 2468 |
| | 13 | 2415 | 40 | 2442 | 67 | 2469 |
| | 14 | 2416 | 41 | 2443 | 68 | 2470 |
| | 15 | 2417 | 42 | 2444 | 69 | 2471 |
| | 16 | 2418 | 43 | 2445 | 70 | 2472 |
| | 17 | 2419 | 44 | 2446 | 71 | 2473 |
| | 18 | 2420 | 45 | 2447 | 72 | 2474 |
| | 19 | 2421 | 46 | 2448 | 73 | 2475 |
| | 20 | 2422 | 47 | 2449 | 74 | 2476 |
| | 21 | 2423 | 48 | 2450 | 75 | 2477 |
| | 22 | 2424 | 49 | 2451 | 76 | 2478 |
| | 23 | 2425 | 50 | 2452 | 77 | 2479 |
| | 24 | 2426 | 51 | 2453 | 78 | 2480 |
| | 25 | 2427 | 52 | 2454 | - | - |
| | 26 | 2428 | 53 | 2455 | - | - |



2.2 Test Mode

- a. The EUT has been associated with peripherals and configuration operated in a manner tended to maximize its emission characteristics in a typical application. Frequency range investigated: conduction emission (150 kHz to 30 MHz), radiation emission (9 kHz to the 10th harmonic of the highest fundamental frequency or to 40 GHz, whichever is lower). For radiated measurement, pre-scanned in three orthogonal panels, X, Y, Z. The worst cases (Z plane) were recorded in this report, and the worst mode of radiated spurious emissions is Bluetooth 2Mbps mode, and recorded in this report.
- b. AC power line Conducted Emission was tested under maximum output power.

The following summary table is showing all test modes to demonstrate in compliance with the standard.

| Summary table of Test Cases | | | |
|--|---|---------------------------------------|-------------------------------|
| Test Item | Data Rate / Modulation | | |
| | Bluetooth BR 1Mbps GFSK | Bluetooth EDR 2Mbps $\pi/4$ -DQPSK | Bluetooth EDR 3Mbps 8-DPSK |
| Conducted Test Cases | Mode 1: CH00_2402 MHz | Mode 4: CH00_2402 MHz | Mode 7: CH00_2402 MHz |
| | Mode 2: CH39_2441 MHz | Mode 5: CH39_2441 MHz | Mode 8: CH39_2441 MHz |
| | Mode 3: CH78_2480 MHz | Mode 6: CH78_2480 MHz | Mode 9: CH78_2480 MHz |
| Radiated Test Cases | Bluetooth EDR 2Mbps $\pi/4$ -DQPSK | | |
| | Mode 1: CH00_2402 MHz | | |
| | Mode 2: CH39_2441 MHz | | |
| | Mode 3: CH78_2480 MHz | | |
| Summary table of Test Cases | | | |
| AC Conducted Emission | Mode 1 :WLAN (2.4GHz) Link + Bluetooth Link + 1080p 12bit + TV: Sharp LC-50UA6800T + TV Resolution: 1080p + USB Cable (Charging from Adapter) + HDMI Extender Cable | | |
| Remark: | | | |
| 1. For radiated test cases, the worst mode data rate 2Mbps was reported only since the highest RF output power in the preliminary tests. The conducted spurious emissions and conducted band edge measurement for other data rates were not worse than 2Mbps, and no other significantly frequencies found in conducted spurious emission. | | | |
| 2. HDMI Extender Cable means media application transferred mode between EUT and external display. | | | |

2.3 Connection Diagram of Test System

<Bluetooth Tx Mode>

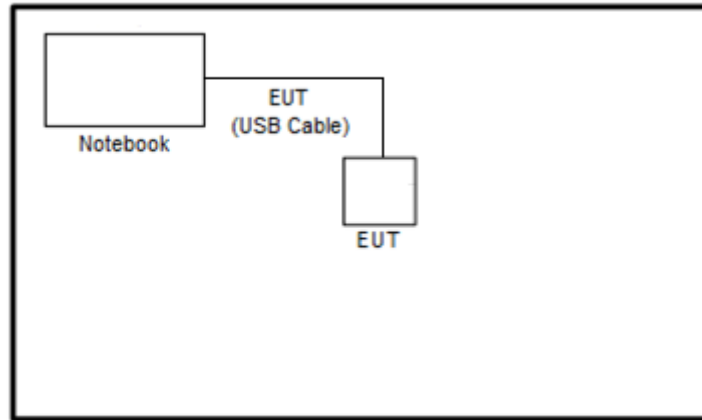

<AC Conducted Emission Mode>

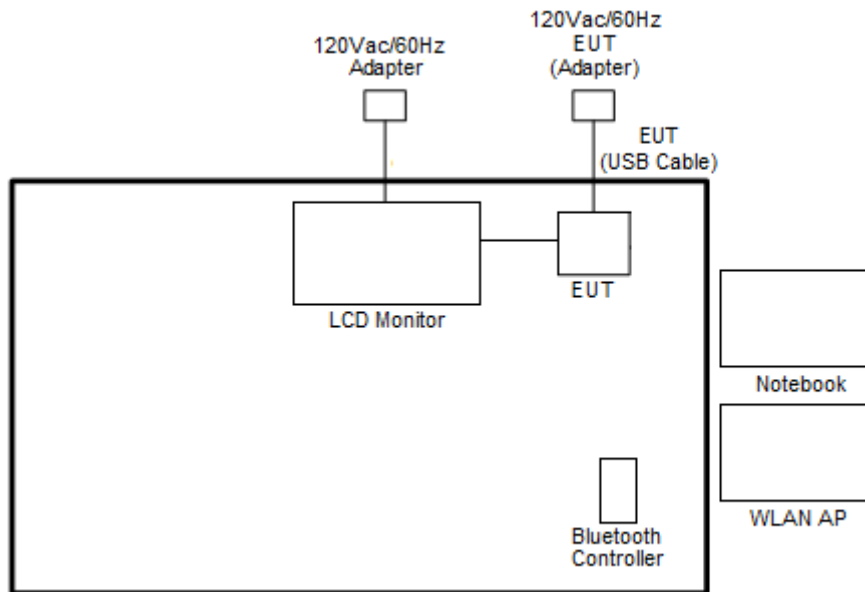



2.4 Support Unit used in test configuration and system

| Item | Equipment | Trade Name | Model Name | FCC ID | Data Cable | Power Cord |
|------|-------------|------------|----------------|--|-----------------|--|
| 1. | WLAN AP | ASUS | RT-AC66U | MSQ-RTAC66U | N/A | Unshielded, 1.8 m |
| 2. | Notebook | DELL | Latitude E6320 | FCC DoC/ Contains FCC ID: QDS-BRCM1054 | N/A | AC I/P: Unshielded, 1.2 m DC O/P: Shielded, 1.8 m |
| 3. | Notebook | Lenovo | E335 | N/A | N/A | AC I/P: Unshielded, 1.2 m DC O/P: Shielded, 1.8 m |
| 4. | LCD Monitor | Sharp | LC-50UA6800T | FCC DoC | Shielded, 1.6 m | Unshielded, 1.8 m |

2.5 EUT Operation Test Setup

The RF test items, utility "Compliance.exe" was installed in Notebook which was programmed in order to make the EUT get into the engineering modes to provide channel selection, power level, data rate and the application type and for continuous transmitting signals.

2.6 Measurement Results Explanation Example

For all conducted test items:

The offset level is set in the spectrum analyzer to compensate the RF cable loss and attenuator factor between EUT conducted output port and spectrum analyzer. With the offset compensation, the spectrum analyzer reading level is exactly the EUT RF output level.

Example:

The spectrum analyzer offset is derived from RF cable loss and attenuator factor.

Offset = RF cable loss + attenuator factor.

Following shows an offset computation example with cable loss 4.2 dB and 10dB attenuator.

$$\begin{aligned} \text{Offset(dB)} &= \text{RF cable loss(dB)} + \text{attenuator factor(dB)}. \\ &= 4.2 + 10 = 14.2 \text{ (dB)} \end{aligned}$$

3 Test Result

3.1 Number of Channel Measurement

3.1.1 Limits of Number of Hopping Frequency

Frequency hopping systems in the 2400-2483.5 MHz band shall use at least 15 channels.

3.1.2 Measuring Instruments

See list of measuring equipment of this test report.

3.1.3 Test Procedure

1. The testing follows ANSI C63.10-2013 clause 7.8.3.
2. The RF output of EUT was connected to the spectrum analyzer by RF cable and attenuator. The path loss was compensated to the results for each measurement.
3. Set to the maximum power setting and enable the EUT transmit continuously.
4. Enable the EUT hopping function.
5. Use the following spectrum analyzer settings: Span = the frequency band of operation; RBW = 300kHz; VBW \geq RBW; Sweep = auto; Detector function = peak; Trace = max hold.
6. The number of hopping frequency used is defined as the number of total channel.
7. Record the measurement data derived from spectrum analyzer.

3.1.4 Test Setup





3.1.5 Test Result of Number of Hopping Frequency

Please refer to Appendix A.

Number of Hopping Channel Plot on Channel 00 - 78

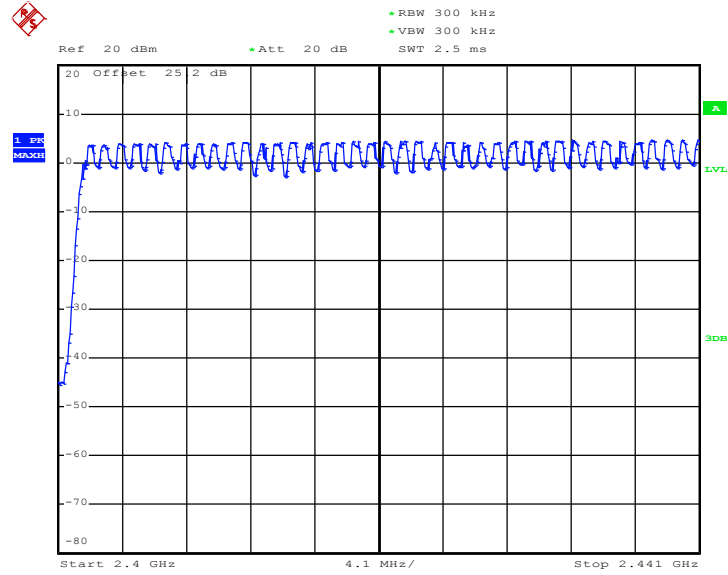

Date: 10.JUL.2018 10:37:59

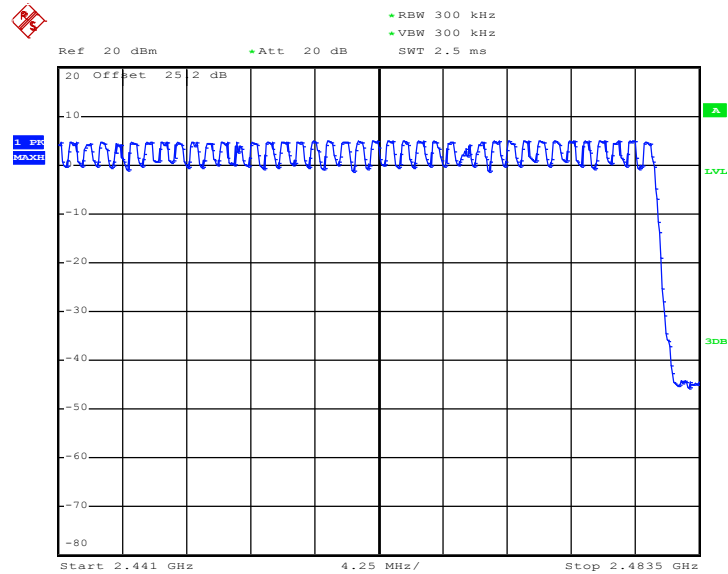

Date: 10.JUL.2018 10:40:10

3.2 Hopping Channel Separation Measurement

3.2.1 Limit of Hopping Channel Separation

Frequency hopping systems operating in the 2400-2483.5 MHz band may have hopping channel carrier frequencies that are separated by 25 kHz or two-thirds of the 20 dB bandwidth of the hopping channel, whichever is greater.

3.2.2 Measuring Instruments

See list of measuring equipment of this test report.

3.2.3 Test Procedures

1. The testing follows ANSI C63.10-2013 clause 7.8.2.
2. The RF output of EUT was connected to the spectrum analyzer by RF cable and attenuator. The path loss was compensated to the results for each measurement.
3. Set to the maximum power setting and enable the EUT transmit continuously.
4. Enable the EUT hopping function.
5. Use the following spectrum analyzer settings:
Span = wide enough to capture the peaks of two adjacent channels;
RBW = 300kHz; VBW \geq RBW; Sweep = auto; Detector function = peak; Trace = max hold.
6. Measure and record the results in the test report.

3.2.4 Test Setup



3.2.5 Test Result of Hopping Channel Separation

Please refer to Appendix A.



<1Mbps>

Channel Separation Plot on Channel 00 - 01

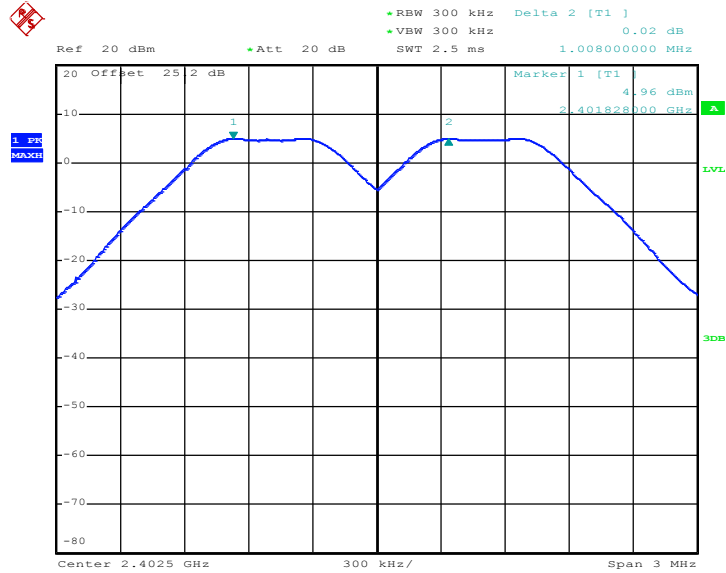

Date: 7.JUL.2018 02:56:25

Channel Separation Plot on Channel 39 - 40

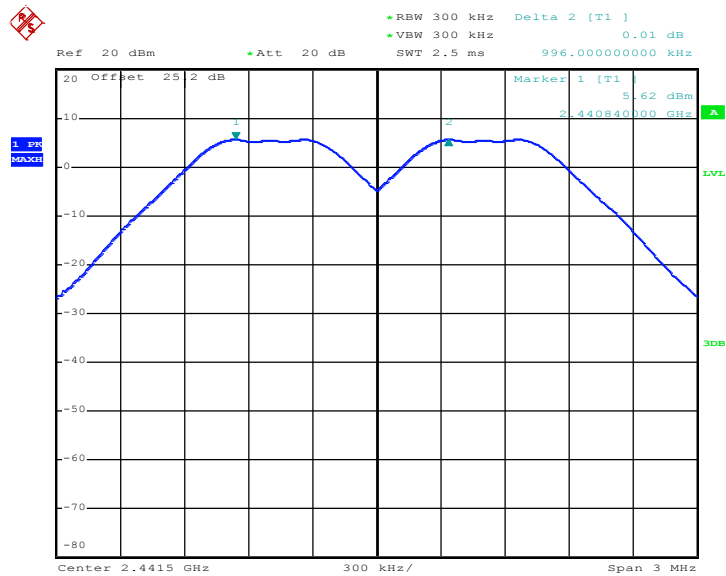

Date: 7.JUL.2018 03:08:59



Channel Separation Plot on Channel 77 - 78

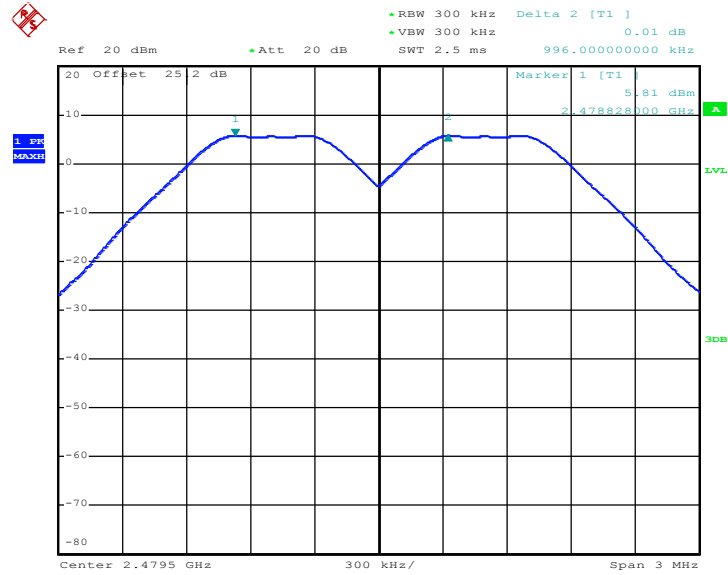

Date: 7.JUL.2018 03:14:16

<2Mbps>

Channel Separation Plot on Channel 00 - 01

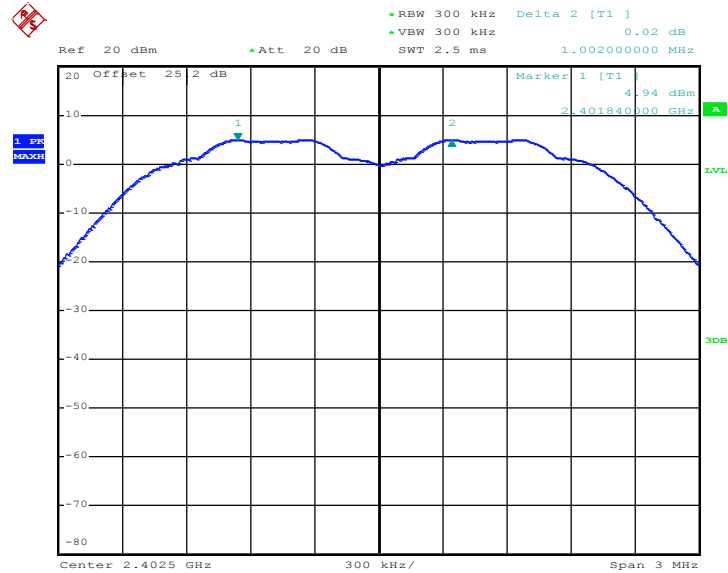

Date: 7.JUL.2018 03:21:06



Channel Separation Plot on Channel 39 - 40

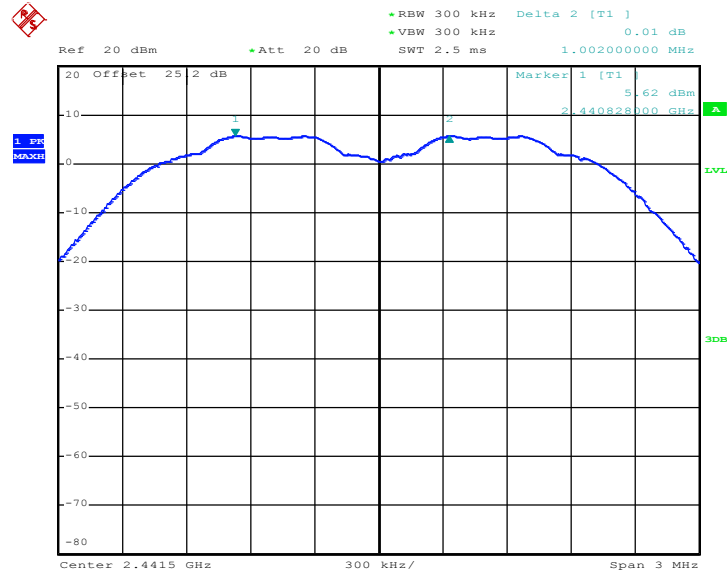

Date: 7.JUL.2018 03:28:31

Channel Separation Plot on Channel 77 - 78

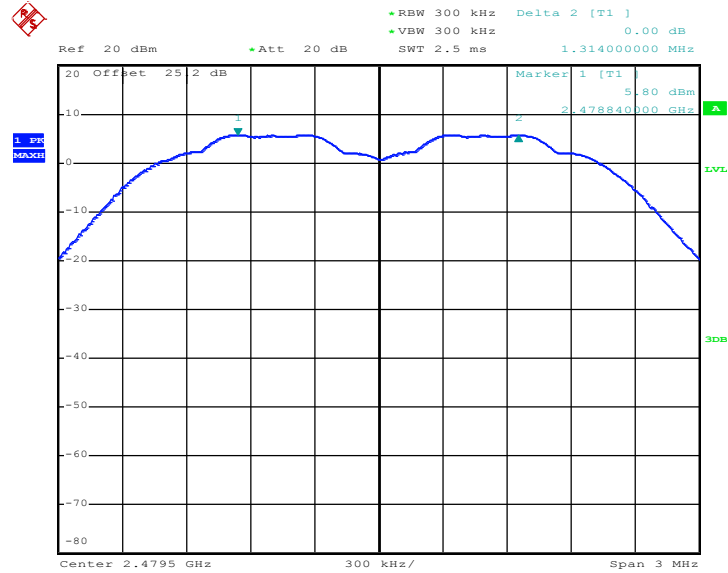

Date: 7.JUL.2018 03:44:57



<3Mbps>

Channel Separation Plot on Channel 00 - 01

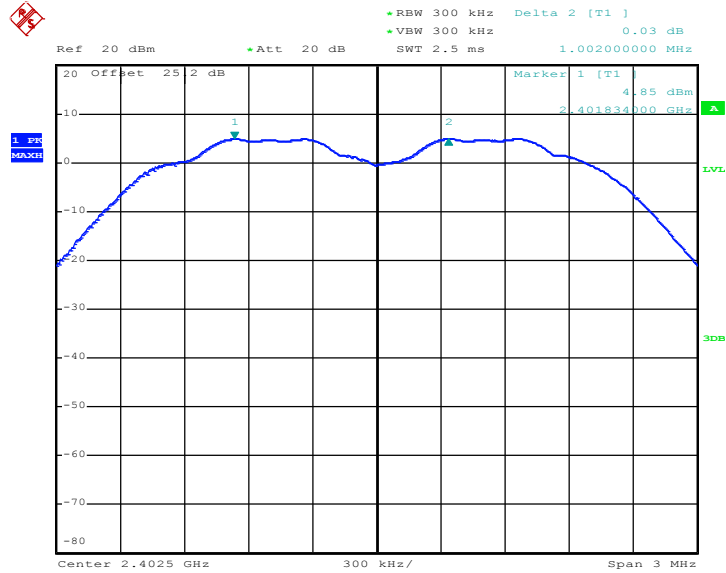

Date: 7.JUL.2018 03:58:42

Channel Separation Plot on Channel 39 - 40

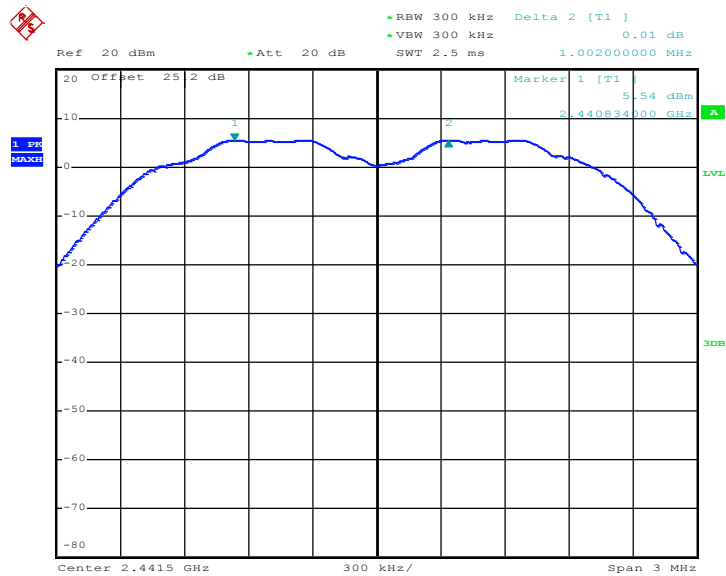

Date: 7.JUL.2018 04:20:13



Channel Separation Plot on Channel 77 - 78

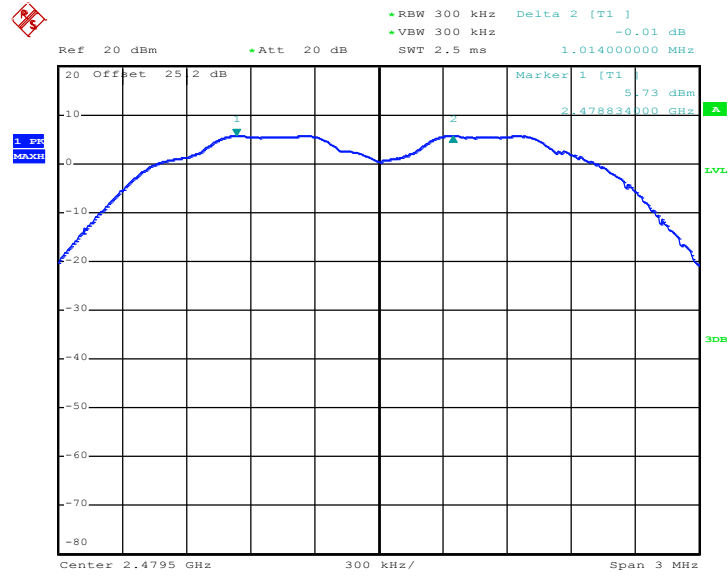

Date: 7.JUL.2018 04:31:54

3.3 Dwell Time Measurement

3.3.1 Limit of Dwell Time

The average time of occupancy on any channel shall not be greater than 0.4 seconds within a period of 0.4 seconds multiplied by the number of hopping channels employed.

3.3.2 Measuring Instruments

See list of measuring equipment of this test report.

3.3.3 Test Procedures

1. The testing follows ANSI C63.10-2013 clause 7.8.4.
2. The RF output of EUT was connected to the spectrum analyzer by RF cable and attenuator. The path loss was compensated to the results for each measurement.
3. Set to the maximum power setting and enable the EUT transmit continuously.
4. Enable the EUT hopping function.
5. Use the following spectrum analyzer settings: Span = zero span, centered on a hopping channel; RBW = 1 MHz; VBW \geq RBW; Sweep = as necessary to capture the entire dwell time per hopping channel; Detector function = peak; Trace = max hold.
6. Measure and record the results in the test report.

3.3.4 Test Setup



3.3.5 Test Result of Dwell Time

Please refer to Appendix A.



Package Transfer Time Plot

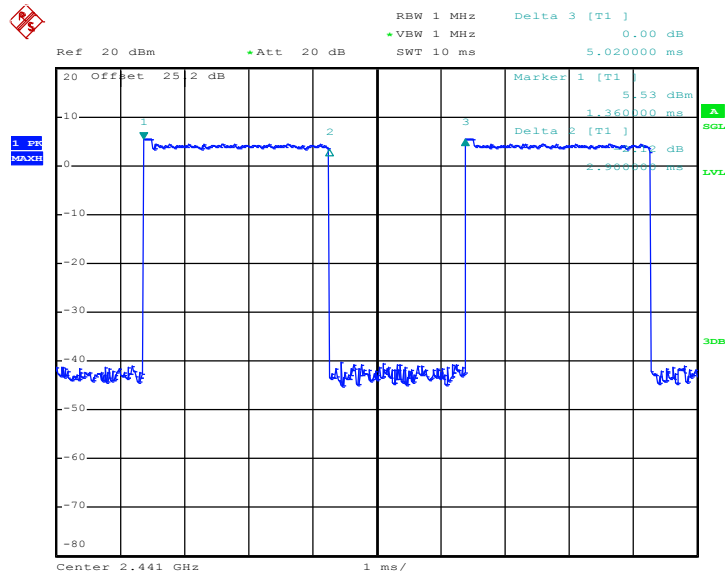

Date: 25.JUN.2018 21:47:44

Remark:

1. In normal mode, hopping rate is 1600 hops/s with 6 slots in 79 hopping channels. With channel hopping rate (1600 / 6 / 79) in Occupancy Time Limit (0.4 x 79) (s), Hops Over Occupancy Time comes to (1600 / 6 / 79) x (0.4 x 79) = 106.67 hops.
2. In AFH mode, hopping rate is 800 hops/s with 6 slots in 20 hopping channels. With channel hopping rate (800 / 6 / 20) in Occupancy Time Limit (0.4 x 20) (s), Hops Over Occupancy Time comes to (800 / 6 / 20) x (0.4 x 20) = 53.33 hops.
3. Dwell Time(s) = Hops Over Occupancy Time (hops) x Package Transfer Time

3.4 20dB and 99% Bandwidth Measurement

3.4.1 Limit of 20dB and 99% Bandwidth

Reporting only

3.4.2 Measuring Instruments

See list of measuring equipment of this test report.

3.4.3 Test Procedures

1. The testing follows ANSI C63.10-2013 clause 6.9.2 and 6.9.3.
2. The RF output of EUT was connected to the spectrum analyzer by RF cable and attenuator. The path loss was compensated to the results for each measurement.
3. Set to the maximum power setting and enable the EUT transmit continuously.
4. Use the following spectrum analyzer settings for 20dB Bandwidth measurement.
Span = approximately 2 to 5 times the 20 dB bandwidth, centered on a hopping channel;
RBW \geq 1% of the 20 dB bandwidth; VBW \geq RBW; Sweep = auto; Detector function = peak;
Trace = max hold.
5. Use the following spectrum analyzer settings for 99 % Bandwidth measurement.
Span = approximately 1.5 to 5 times the 99% bandwidth, centered on a hopping channel;
RBW \geq 1-5% of the 99% bandwidth; VBW \geq 3 * RBW; Sweep = auto; Detector function = peak;
Trace = max hold.
6. Measure and record the results in the test report.

3.4.4 Test Setup



3.4.5 Test Result of 20dB Bandwidth

Please refer to Appendix A.



<1Mbps>

20 dB Bandwidth Plot on Channel 00

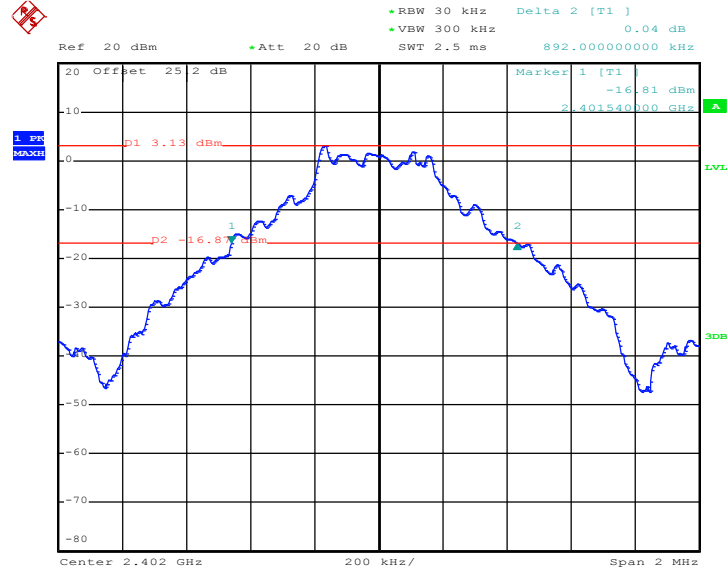

Date: 7.JUL.2018 02:58:49

20 dB Bandwidth Plot on Channel 39

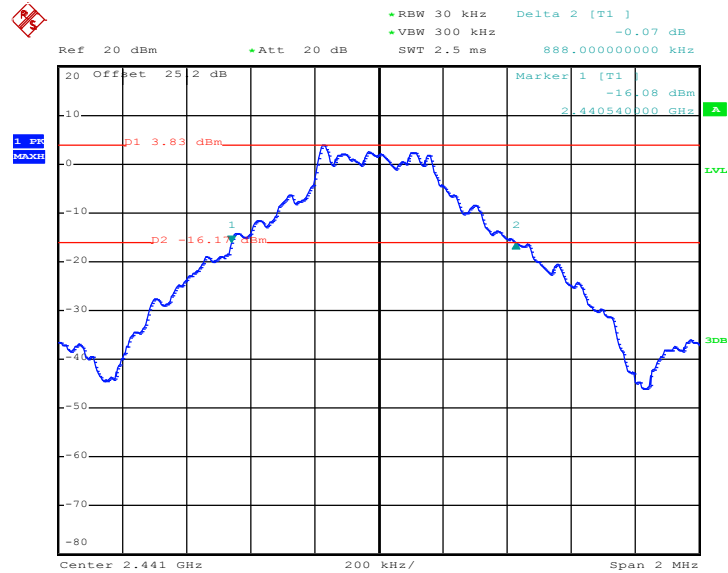

Date: 7.JUL.2018 03:10:10



20 dB Bandwidth Plot on Channel 78

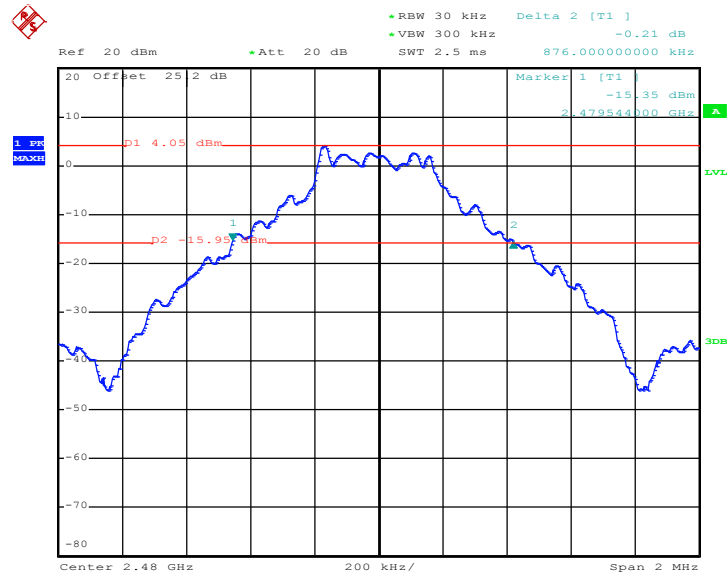

Date: 7.JUL.2018 03:15:29

<2Mbps>

20 dB Bandwidth Plot on Channel 00

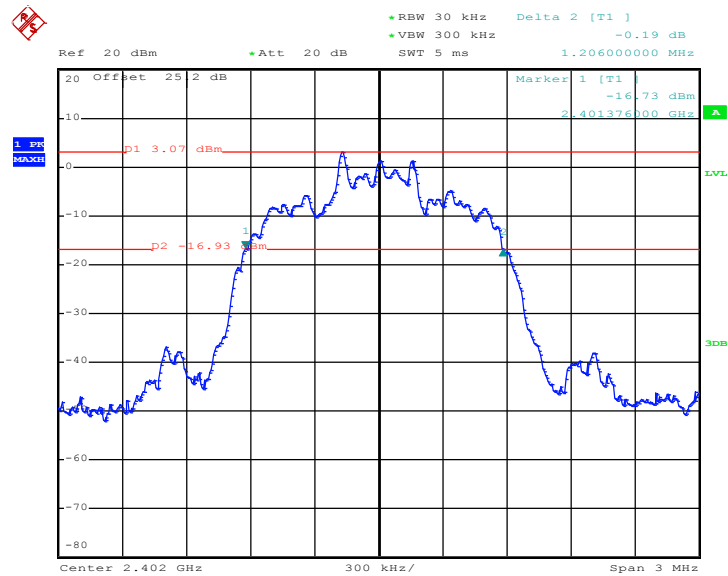

Date: 7.JUL.2018 03:22:17



20 dB Bandwidth Plot on Channel 39

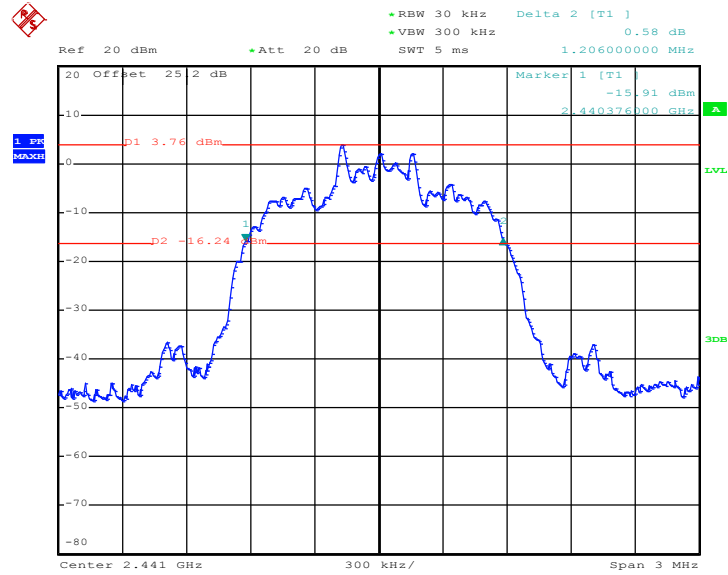

Date: 7.JUL.2018 03:30:50

20 dB Bandwidth Plot on Channel 78

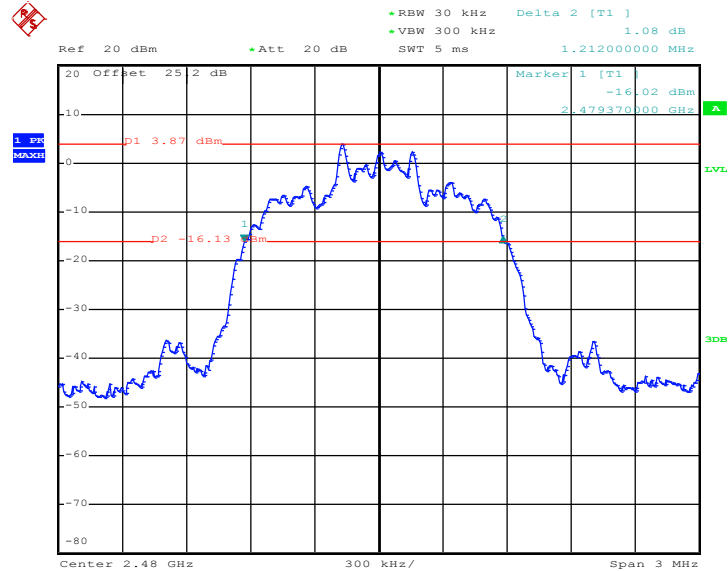

Date: 7.JUL.2018 03:46:01



<3Mbps>

20 dB Bandwidth Plot on Channel 00

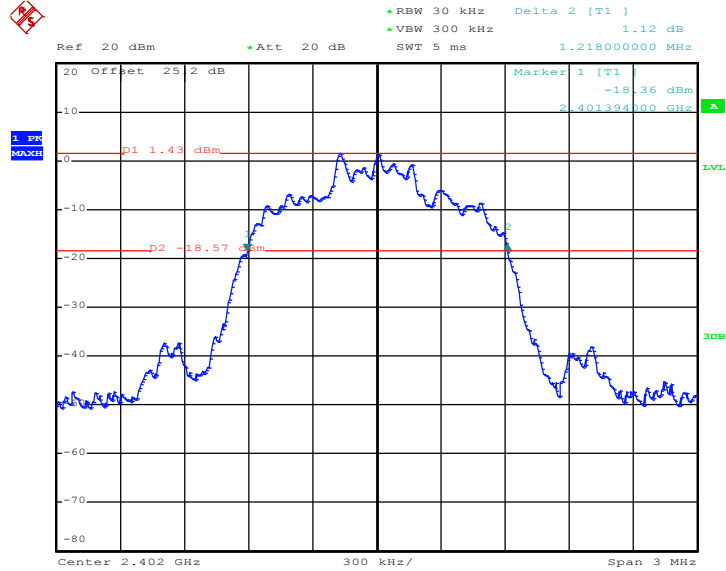

Date: 7.JUL.2018 03:59:41

20 dB Bandwidth Plot on Channel 39

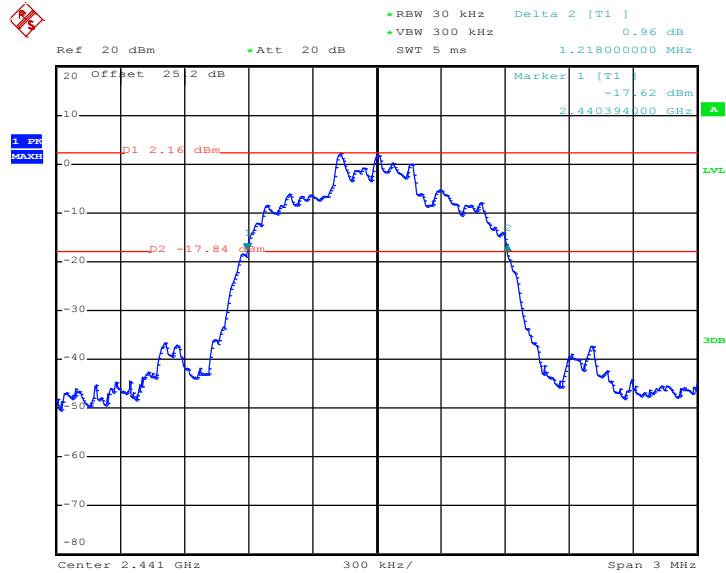

Date: 7.JUL.2018 04:21:01



20 dB Bandwidth Plot on Channel 78

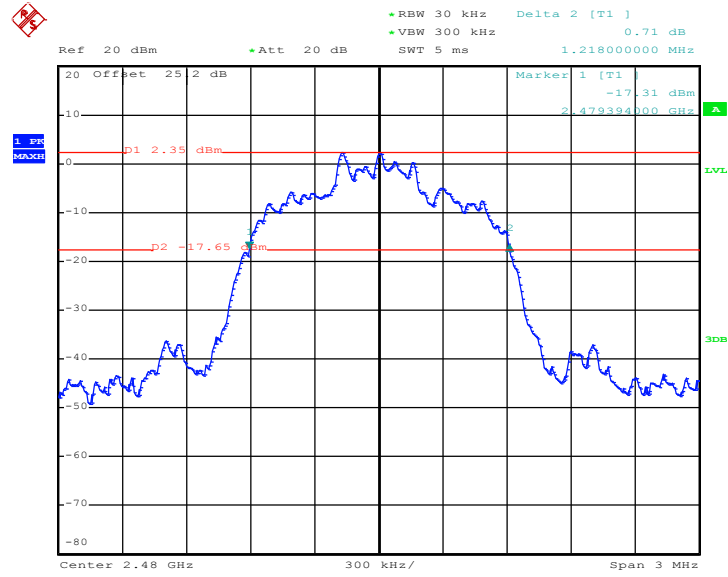

Date: 7.JUL.2018 04:35:07



3.4.6 Test Result of 99% Occupied Bandwidth

Please refer to Appendix A.

<1Mbps>

99% Occupied Bandwidth Plot on Channel 00

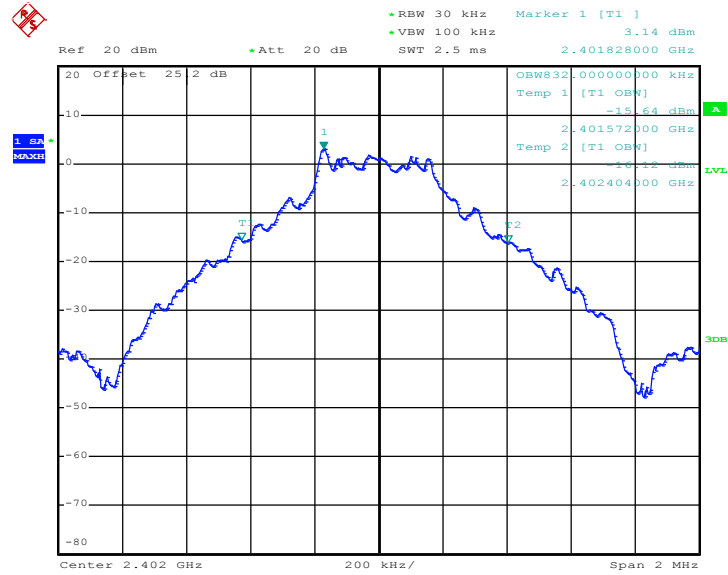

Date: 7.JUL.2018 03:01:06



99% Occupied Bandwidth Plot on Channel 39

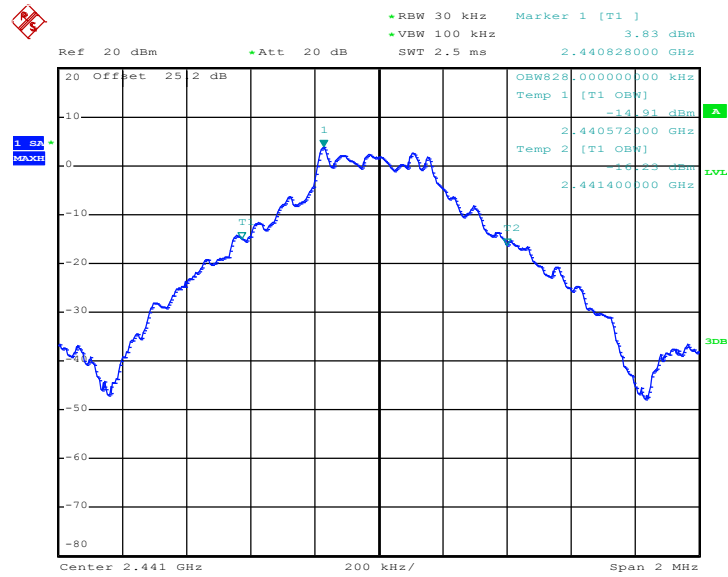

Date: 7.JUL.2018 03:11:01

99% Occupied Bandwidth Plot on Channel 78

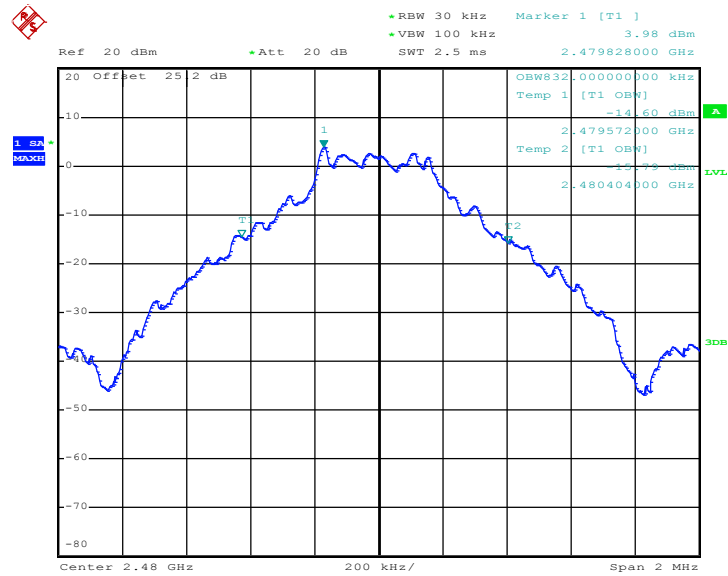

Date: 7.JUL.2018 03:17:30



<2Mbps>

99% Occupied Bandwidth Plot on Channel 00

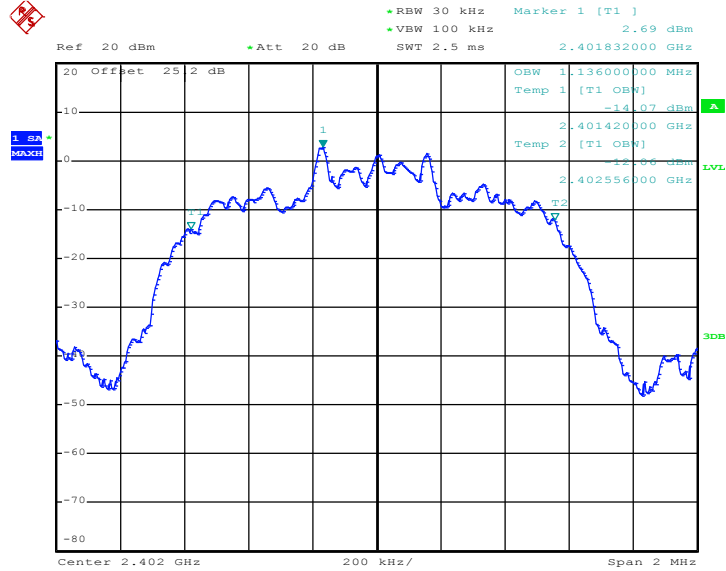

Date: 7.JUL.2018 03:23:31

99% Occupied Bandwidth Plot on Channel 39

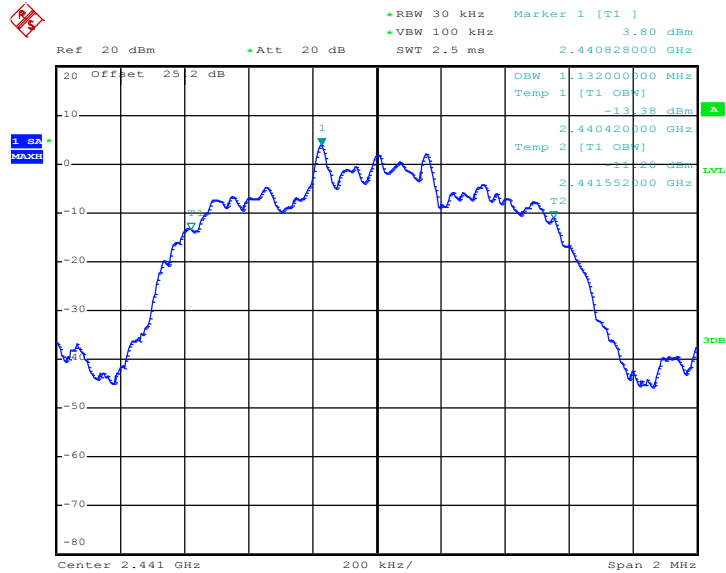

Date: 7.JUL.2018 03:31:59



99% Occupied Bandwidth Plot on Channel 78

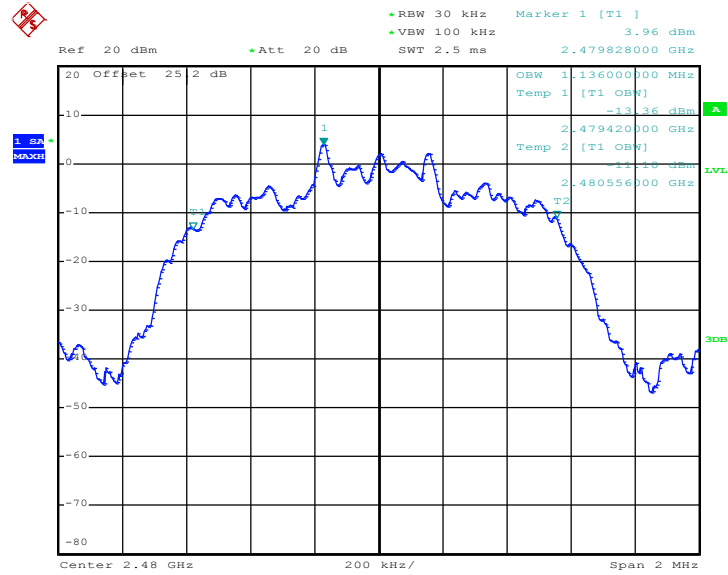

Date: 7.JUL.2018 03:48:08

<3Mbps>

99% Occupied Bandwidth Plot on Channel 00

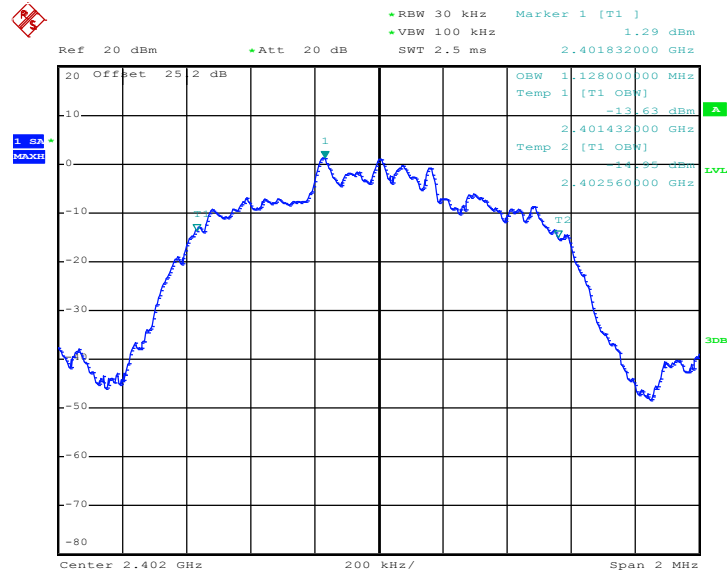

Date: 7.JUL.2018 04:01:36



99% Occupied Bandwidth Plot on Channel 39

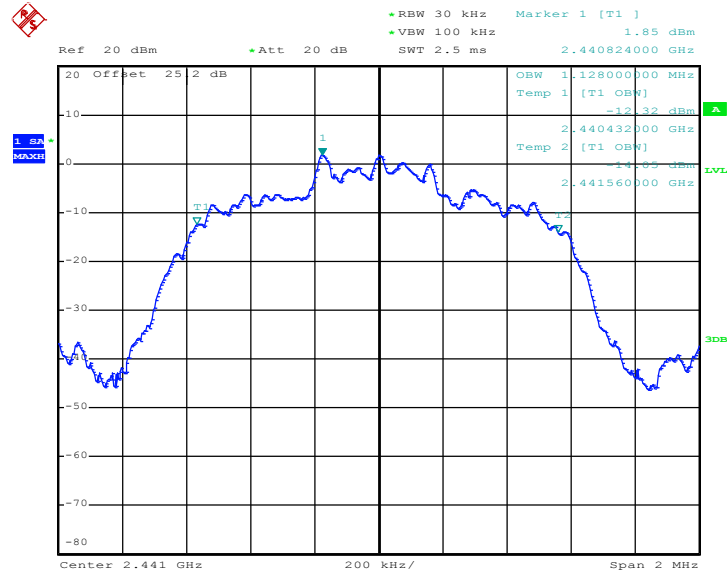

Date: 7.JUL.2018 04:21:54

99% Occupied Bandwidth Plot on Channel 78

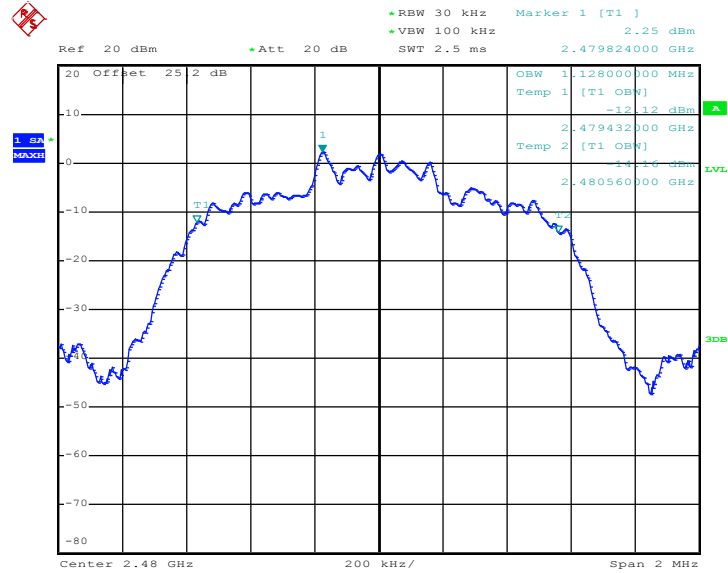

Date: 7.JUL.2018 04:36:53

Note: The occupied channel bandwidth is maintained within the band of operation for all of the modulations.

3.5 Output Power Measurement

3.5.1 Limit of Output Power

The maximum peak conducted output power of the intentional radiator shall not exceed the following:

(1) For frequency hopping systems operating in the 2400-2483.5 MHz band employing at least 75 non-overlapping hopping channels, and all frequency hopping systems in the 5725-5850 MHz band: 1 watt. For all other frequency hopping systems in the 2400-2483.5 MHz band 0.125 watts. The power limit for 1Mbps, 2Mbps, 3Mbps and AFH modes are 0.125 watts.

3.5.2 Measuring Instruments

See list of measuring equipment of this test report.

3.5.3 Test Procedures

1. The testing follows ANSI C63.10-2013 clause 7.8.5.
2. The RF output of EUT was connected to the power meter by RF cable and attenuator. The path loss was compensated to the results for each measurement.
3. Set to the maximum power setting and enable the EUT transmit continuously.
4. Measure the conducted output power with cable loss and record the results in the test report.
5. Measure and record the results in the test report.

3.5.4 Test Setup

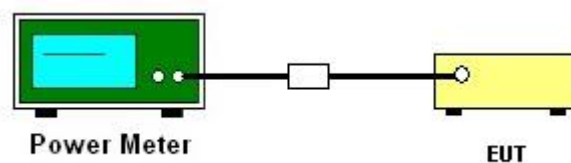

3.5.5 Test Result of Peak Output Power

Please refer to Appendix A.

3.5.6 Test Result of Average Output Power (Reporting Only)

Please refer to Appendix A.

3.6 Conducted Band Edges Measurement

3.6.1 Limit of Band Edges

In any 100 kHz bandwidth outside the intentional radiation frequency band, the radio frequency power shall be at least 20 dB below the highest level of the radiated power. In addition, radiated emissions which fall in the restricted bands must also comply with the radiated emission limits.

3.6.2 Measuring Instruments

See list of measuring equipment of this test report.

3.6.3 Test Procedures

1. The testing follows ANSI C63.10-2013 clause 7.8.6.
2. Set to the maximum power setting and enable the EUT transmit continuously.
3. Set RBW = 100kHz, VBW = 300kHz. Band edge emissions must be at least 20 dB down from the highest emission level within the authorized band as measured with a 100kHz RBW. The attenuation shall be 30 dB instead of 20 dB when RMS conducted output power procedure is used.
4. Enable hopping function of the EUT and then repeat step 2. and 3.
5. Measure and record the results in the test report.

3.6.4 Test Setup





3.6.5 Test Result of Conducted Band Edges

<1Mbps>

Low Band Edge Plot on Channel 00

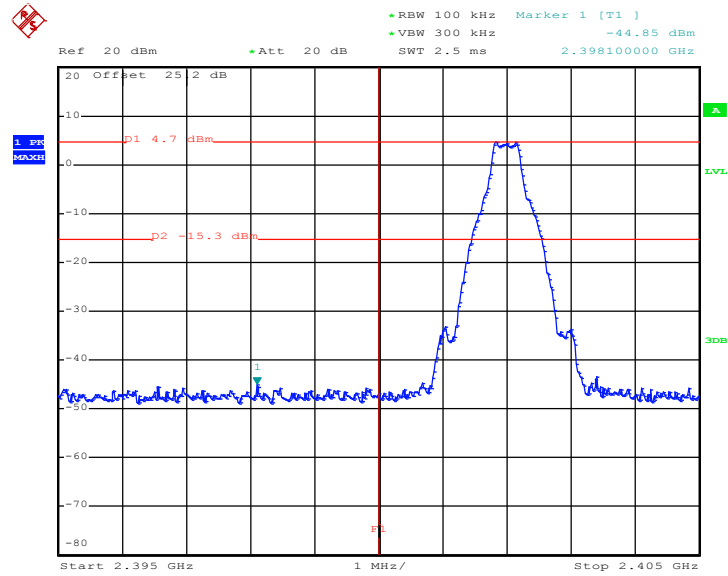

Date: 7.JUL.2018 03:00:04

High Band Edge Plot on Channel 78

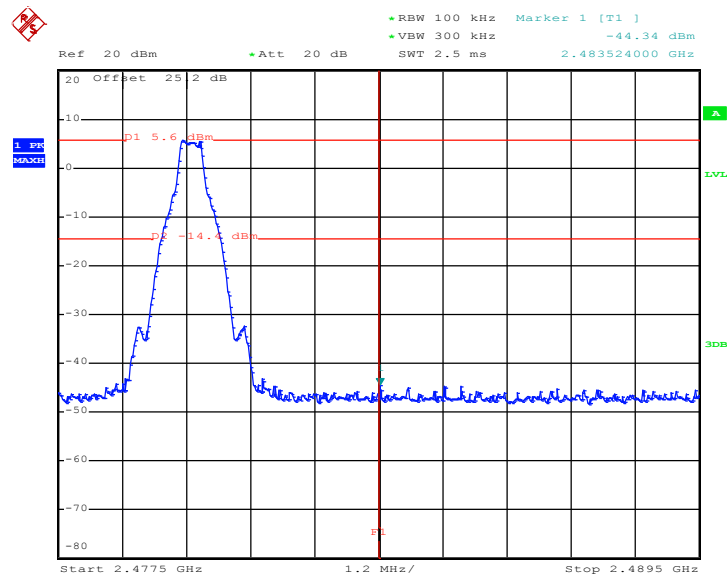

Date: 7.JUL.2018 03:16:38



<2Mbps>

Low Band Edge Plot on Channel 00

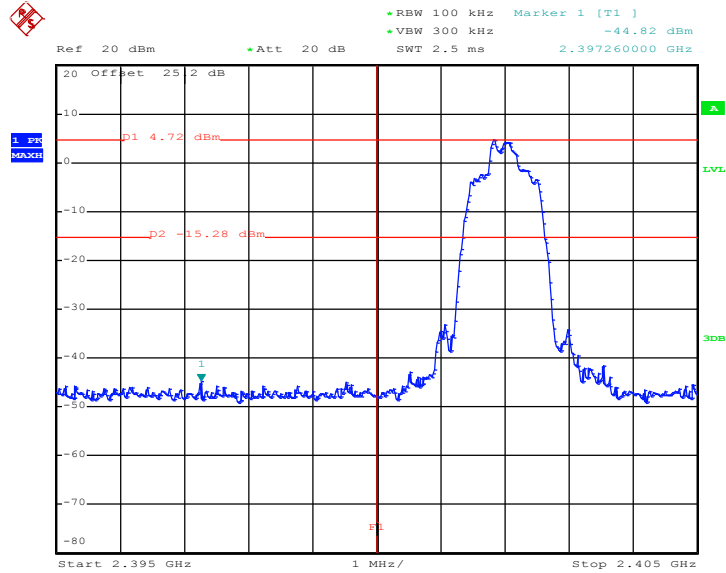

Date: 7.JUL.2018 03:22:55

High Band Edge Plot on Channel 78

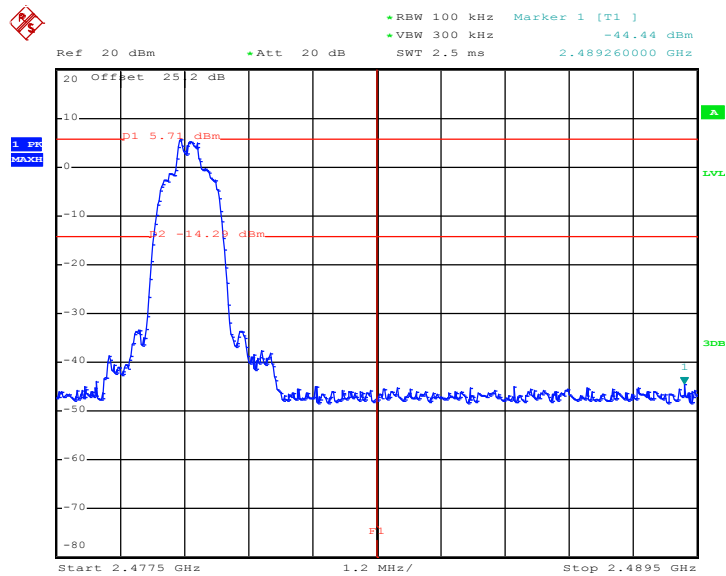

Date: 7.JUL.2018 03:47:13



<3Mbps>

Low Band Edge Plot on Channel 00

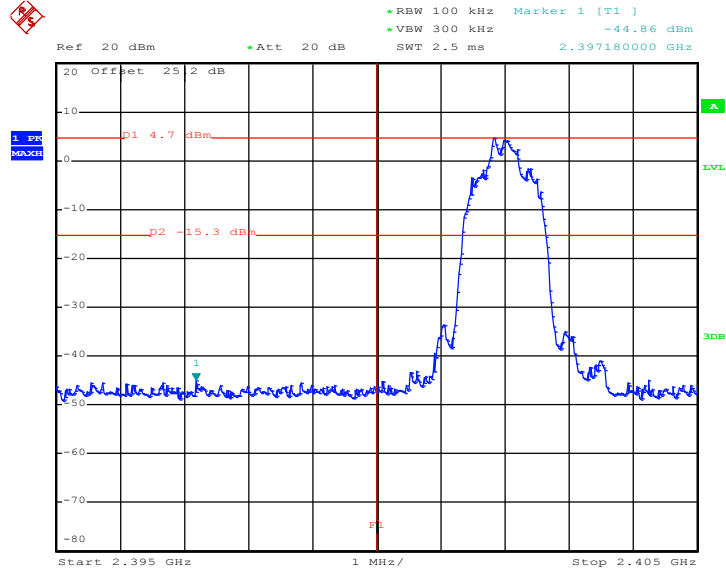

Date: 7.JUL.2018 04:00:52

High Band Edge Plot on Channel 78

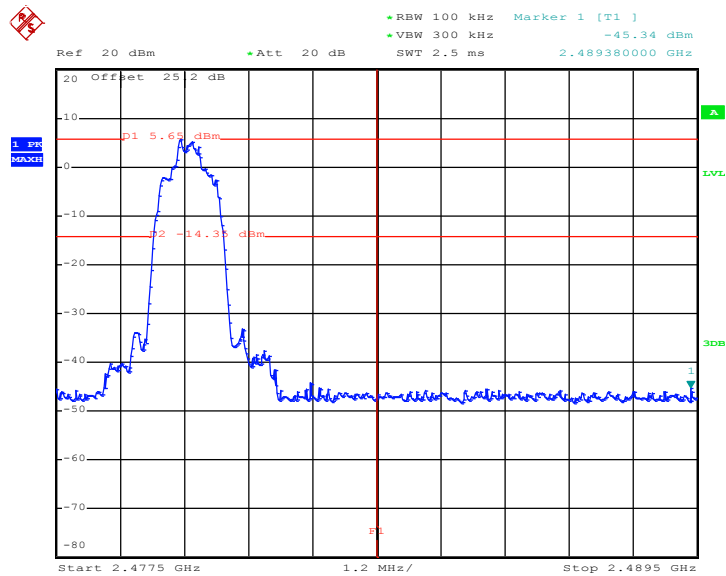

Date: 7.JUL.2018 04:35:55



3.6.6 Test Result of Conducted Hopping Mode Band Edges

<1Mbps>

Hopping Mode Low Band Edge Plot

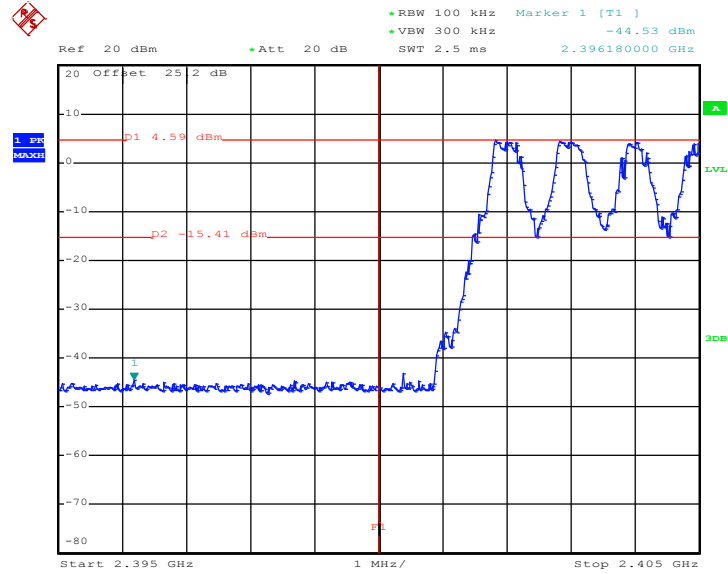

Date: 7.JUL.2018 02:41:21

Hopping Mode High Band Edge Plot

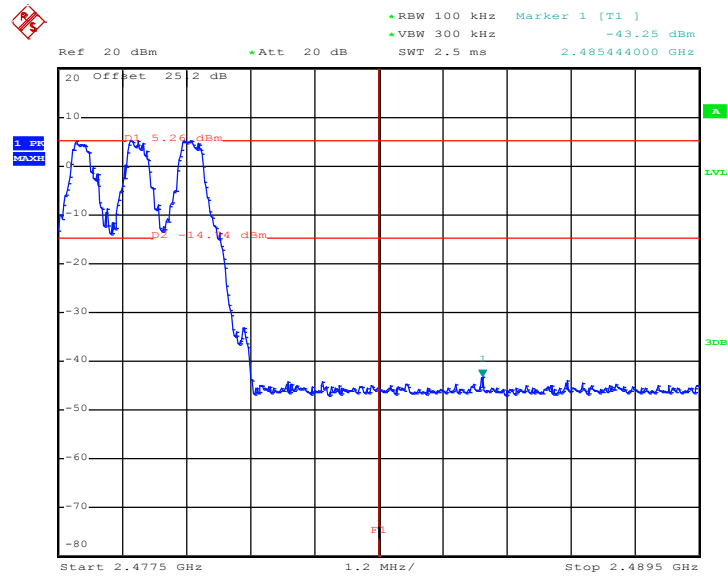

Date: 7.JUL.2018 02:43:31



<2Mbps>

Hopping Mode Low Band Edge Plot

720510

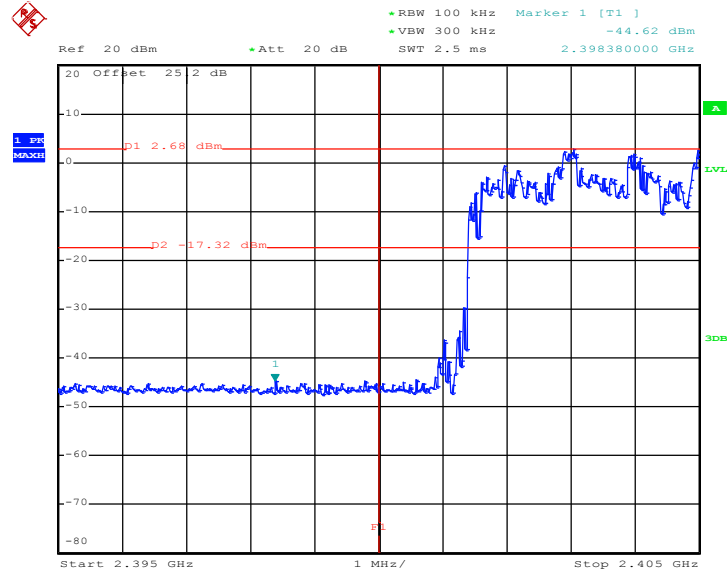

Date: 7.JUL.2018 02:46:52

Hopping Mode High Band Edge Plot

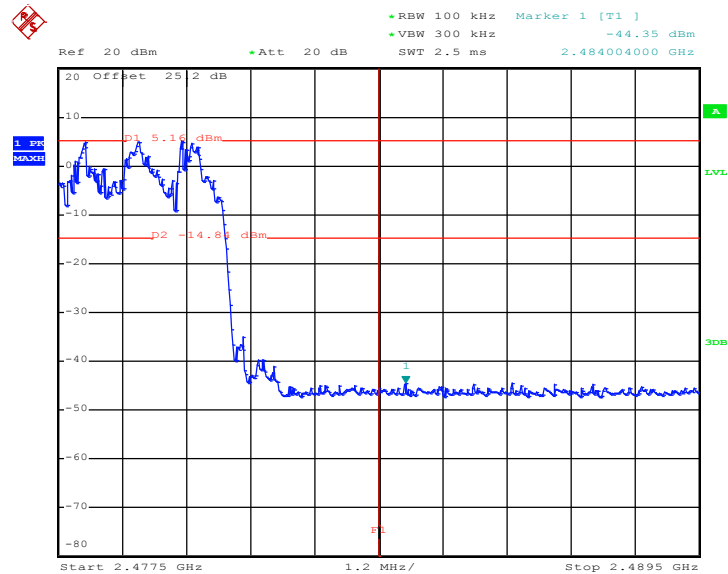

Date: 7.JUL.2018 02:48:03



<3Mbps>

Hopping Mode Low Band Edge Plot

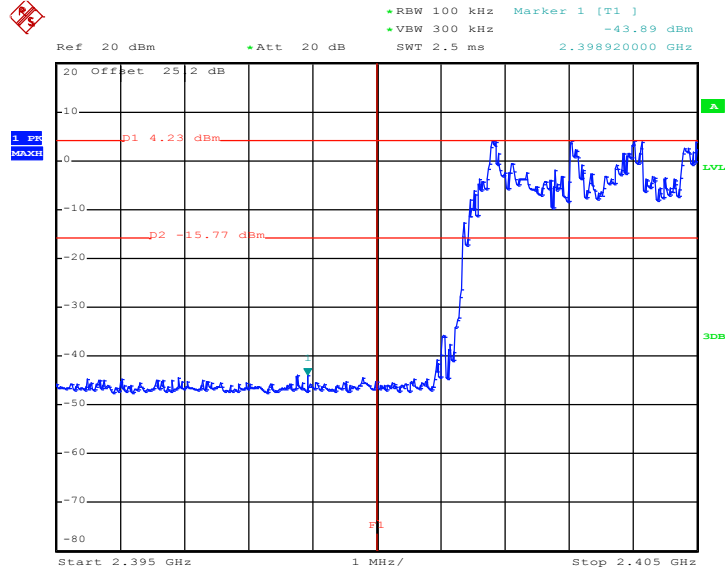

Date: 7.JUL.2018 02:52:02

Hopping Mode High Band Edge Plot

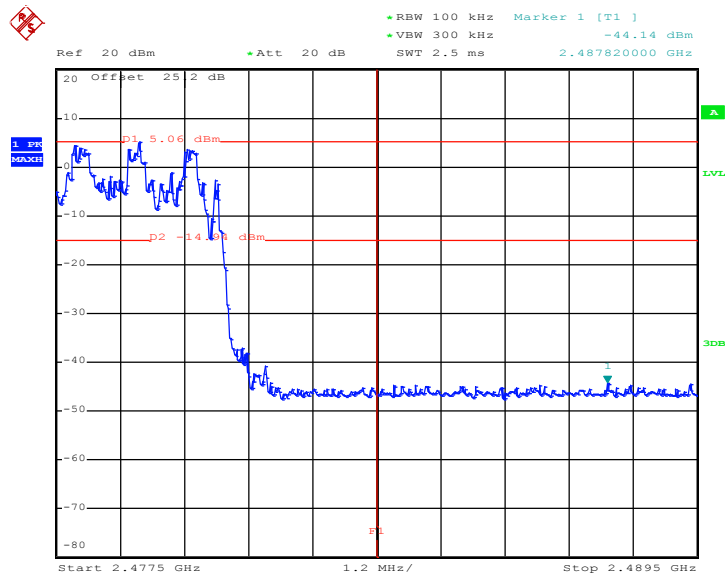

Date: 7.JUL.2018 02:53:12

3.7 Conducted Spurious Emission Measurement

3.7.1 Limit of Spurious Emission Measurement

In any 100 kHz bandwidth outside the intentional radiation frequency band, the radio frequency power shall be at least 20 dB below the highest level of the radiated power. In addition, radiated emissions which fall in the restricted bands must also comply with the radiated emission limits.

3.7.2 Measuring Instruments

See list of measuring equipment of this test report.

3.7.3 Test Procedure

1. The testing follows ANSI C63.10-2013 clause 7.8.8.
2. The RF output of EUT was connected to the spectrum analyzer by RF cable and attenuator. The path loss was compensated to the results for each measurement.
3. Set to the maximum power setting and enable the EUT transmit continuously.
4. Set RBW = 100 kHz, VBW = 300kHz, scan up through 10th harmonic. All harmonics / spurs must be at least 20 dB down from the highest emission level within the authorized band as measured with a 100 kHz RBW.
5. Measure and record the results in the test report.
6. The RF fundamental frequency should be excluded against the limit line in the operating frequency band.

3.7.4 Test Setup

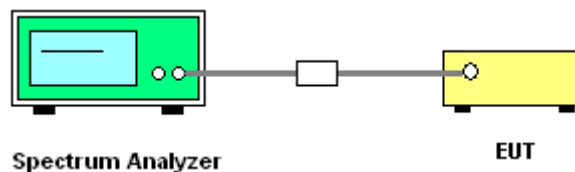



3.7.5 Test Result of Conducted Spurious Emission

<1Mbps>

CSE Plot on Ch 00 between 30MHz ~ 3 GHz

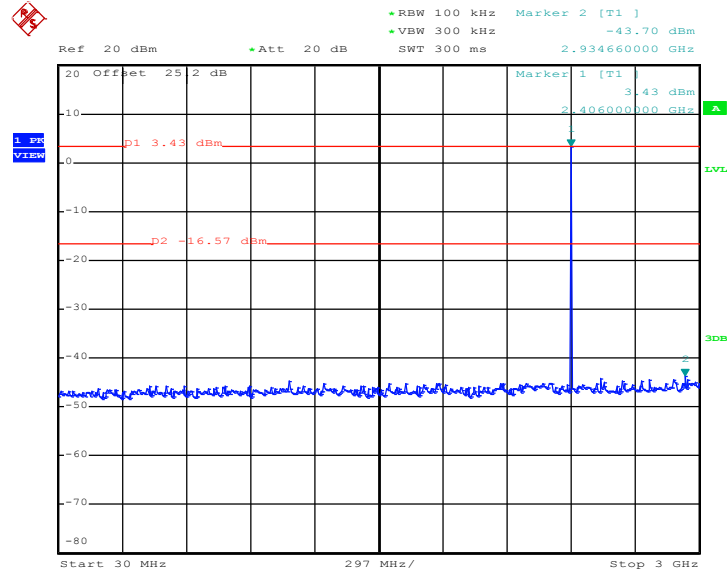

Date: 7.JUL.2018 03:03:47

1Mbps CSE Plot on Ch 00 between 2 GHz ~ 25 GHz

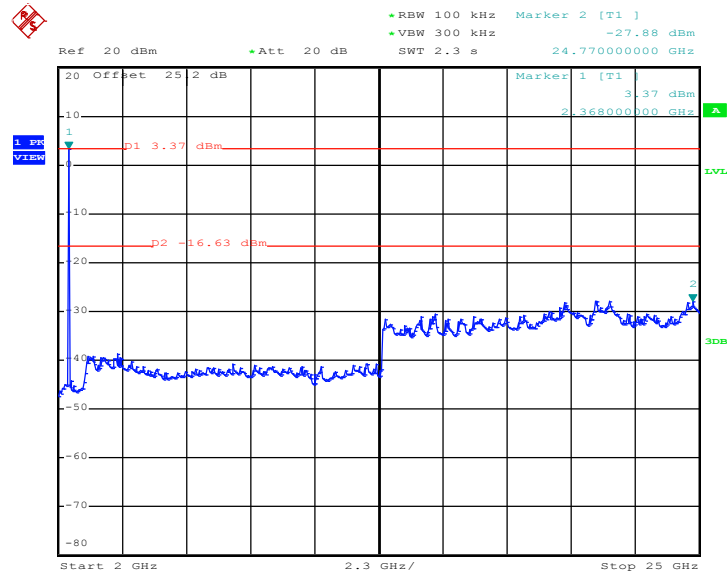

Date: 7.JUL.2018 03:04:26



CSE Plot on Ch 39 between 30MHz ~ 3 GHz

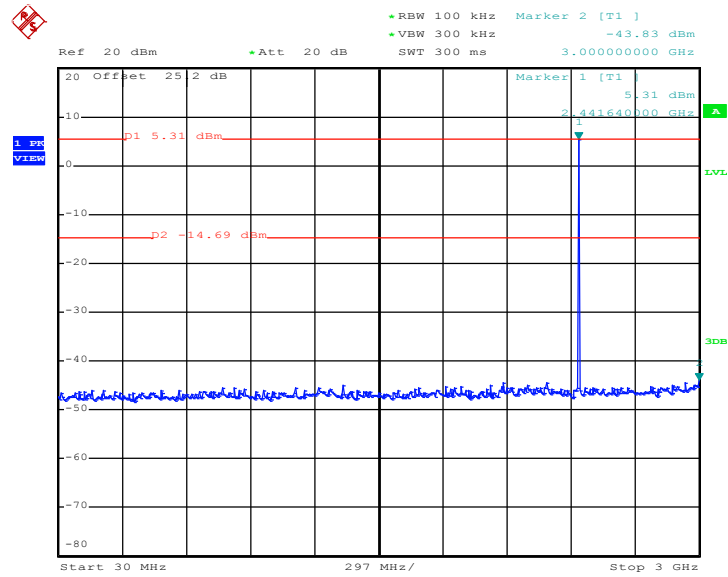

Date: 7.JUL.2018 03:12:22

CSE Plot on Ch 39 between 2 GHz ~ 25 GHz

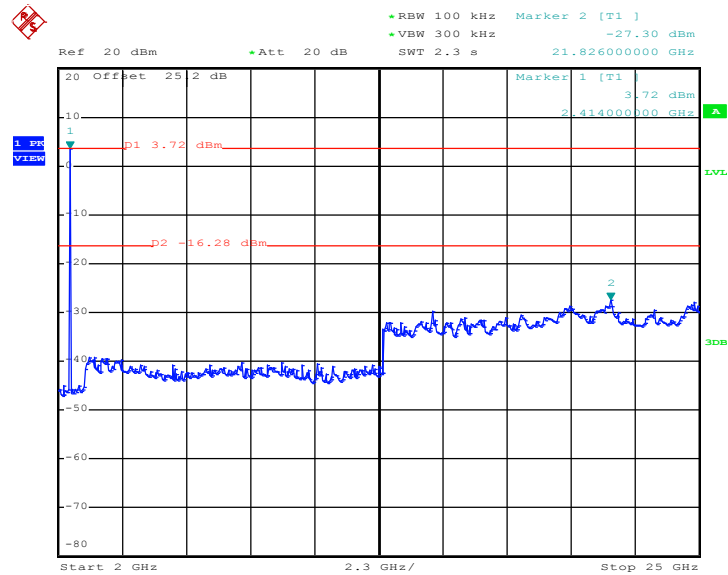

Date: 7.JUL.2018 03:12:51



CSE Plot on Ch 78 between 30MHz ~ 3 GHz

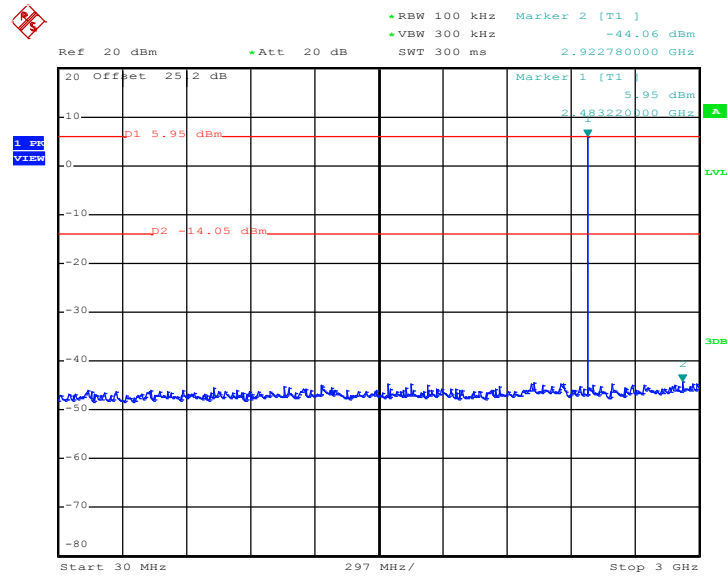

Date: 7.JUL.2018 03:18:55

CSE Plot on Ch 78 between 2 GHz ~ 25 GHz

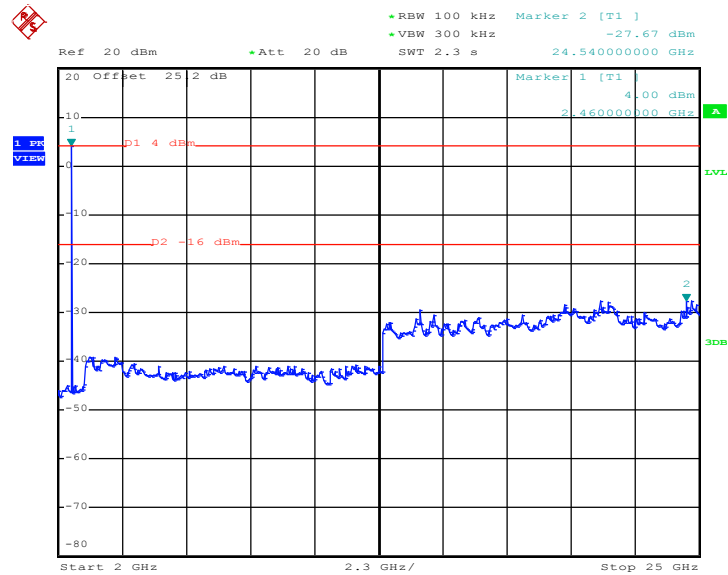

Date: 7.JUL.2018 03:19:34



<2Mbps>

CSE Plot on Ch 00 between 30MHz ~ 3 GHz

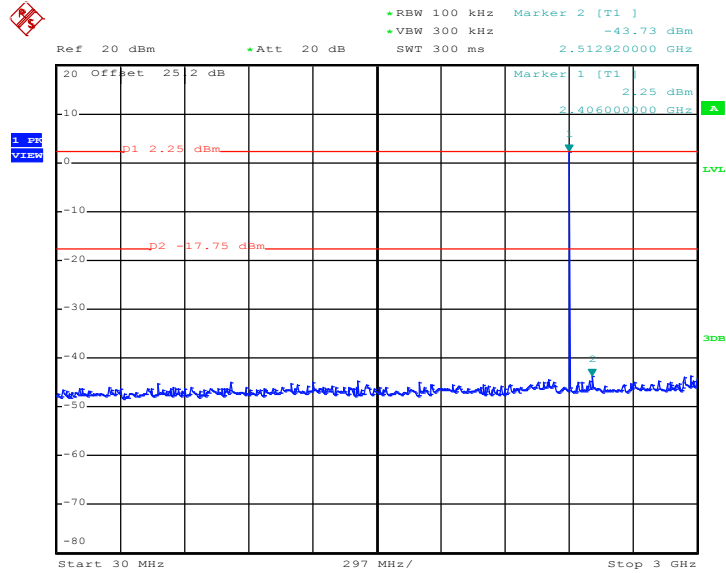

Date: 7.JUL.2018 03:26:48

CSE Plot on Ch 00 between 2 GHz ~ 25 GHz

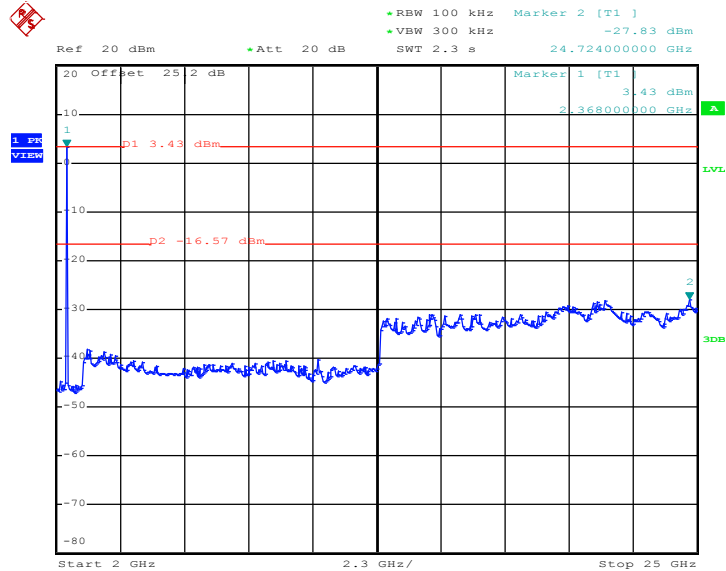

Date: 7.JUL.2018 03:27:15



CSE Plot on Ch 39 between 30MHz ~ 3 GHz

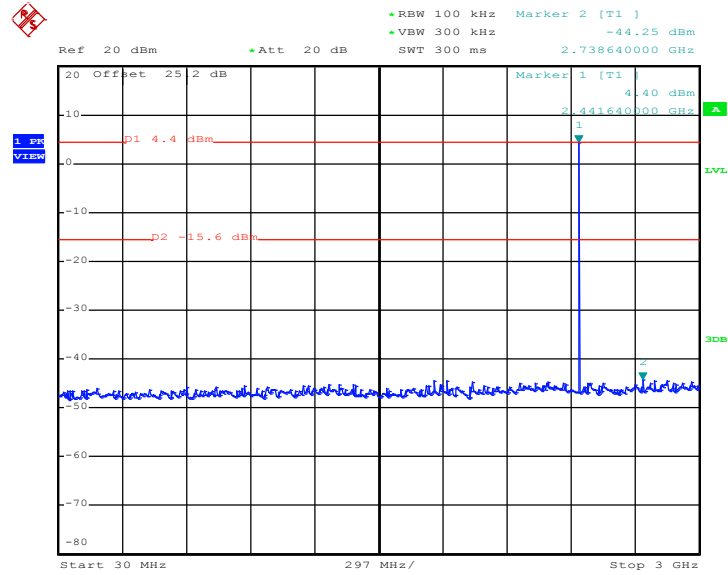

Date: 7.JUL.2018 03:41:28

CSE Plot on Ch 39 between 2 GHz ~ 25 GHz

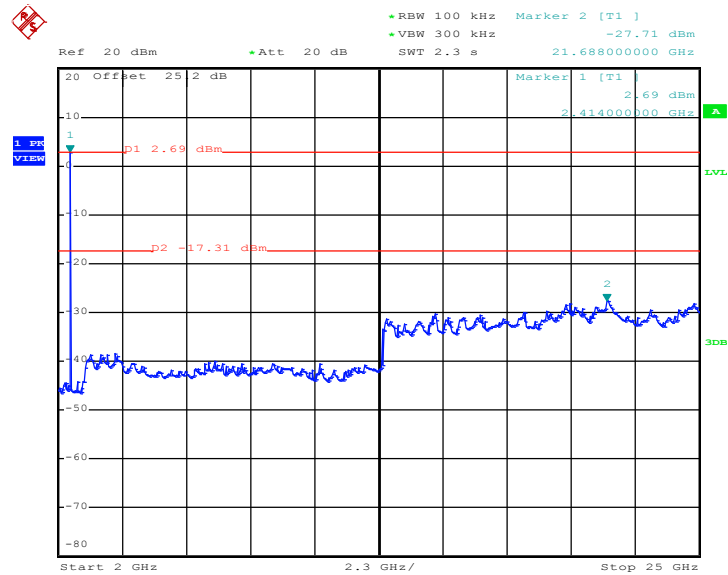

Date: 7.JUL.2018 03:43:30



CSE Plot on Ch 78 between 30MHz ~ 3 GHz

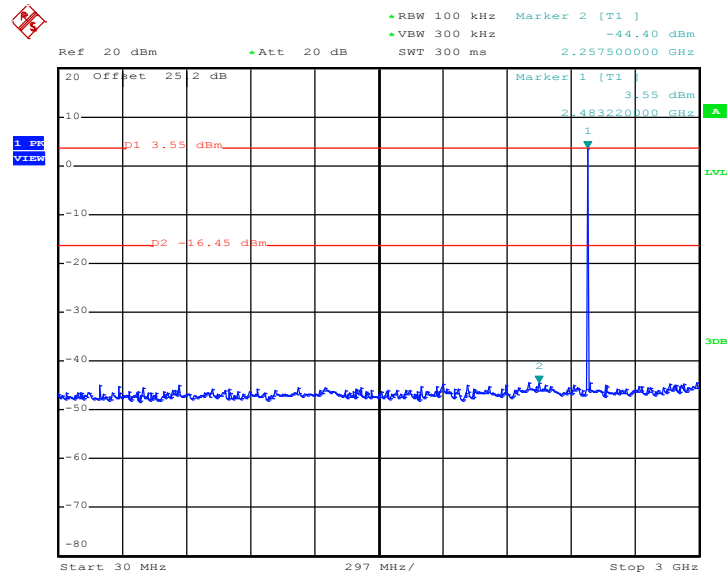

Date: 7.JUL.2018 03:55:59

CSE Plot on Ch 78 between 2 GHz ~ 25 GHz

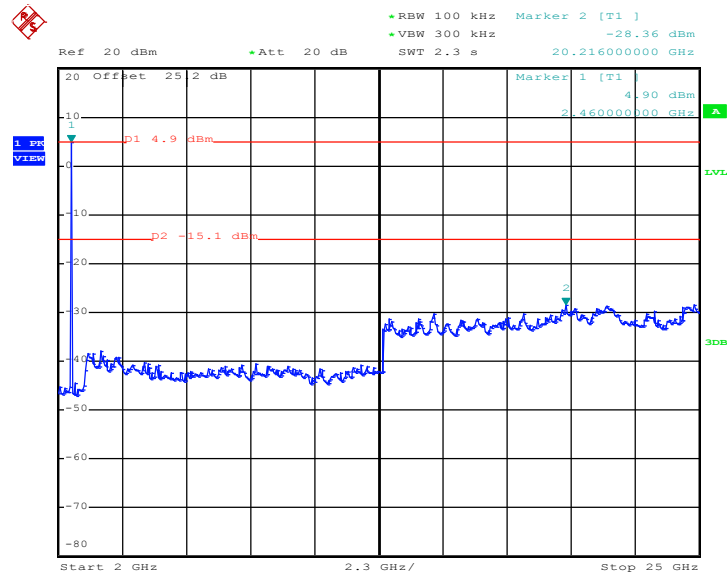

Date: 7.JUL.2018 03:56:39



<3Mbps>

CSE Plot on Ch 00 between 30MHz ~ 3 GHz

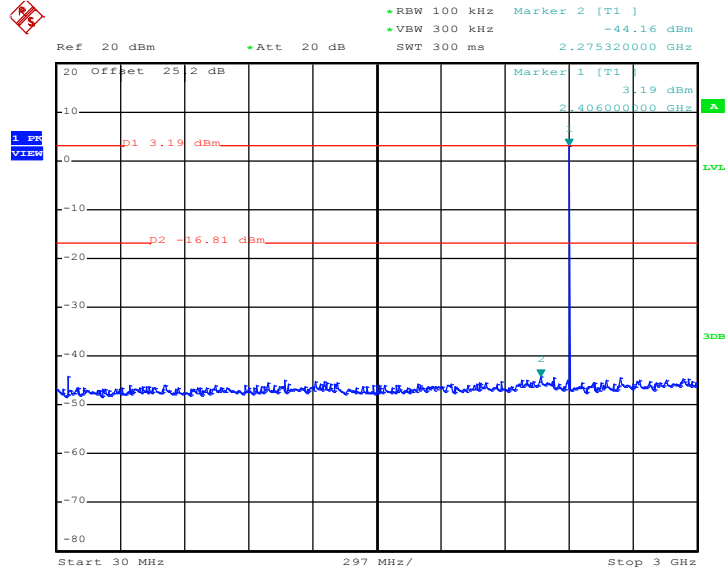

Date: 7.JUL.2018 04:17:41

CSE Plot on Ch 00 between 2 GHz ~ 25 GHz

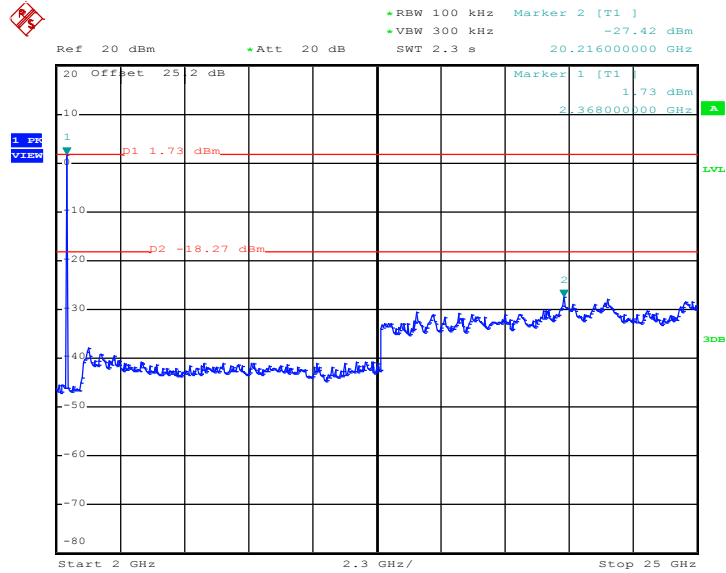

Date: 7.JUL.2018 04:18:13



CSE Plot on Ch 39 between 30MHz ~ 3 GHz

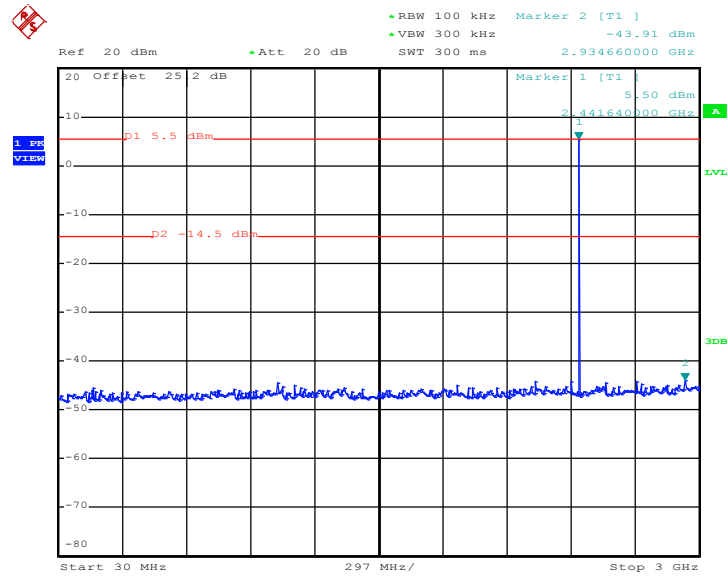

Date: 7.JUL.2018 04:25:54

CSE Plot on Ch 39 between 2 GHz ~ 25 GHz

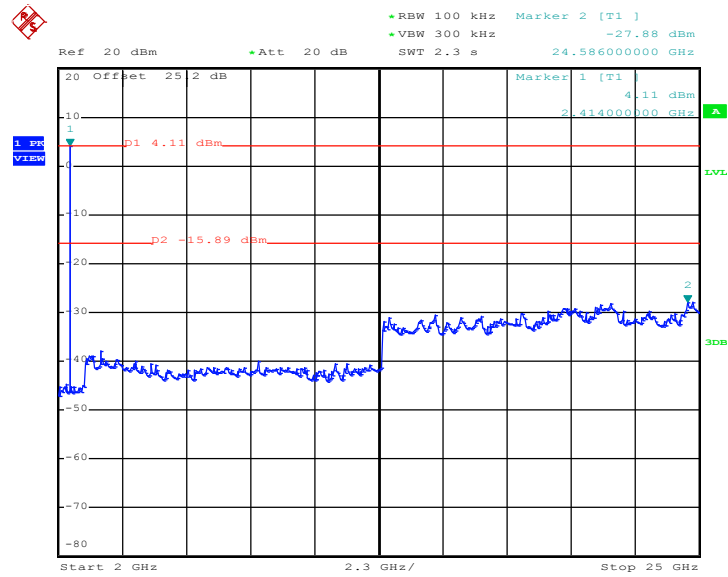

Date: 7.JUL.2018 04:28:00



CSE Plot on Ch 78 between 30MHz ~ 3 GHz

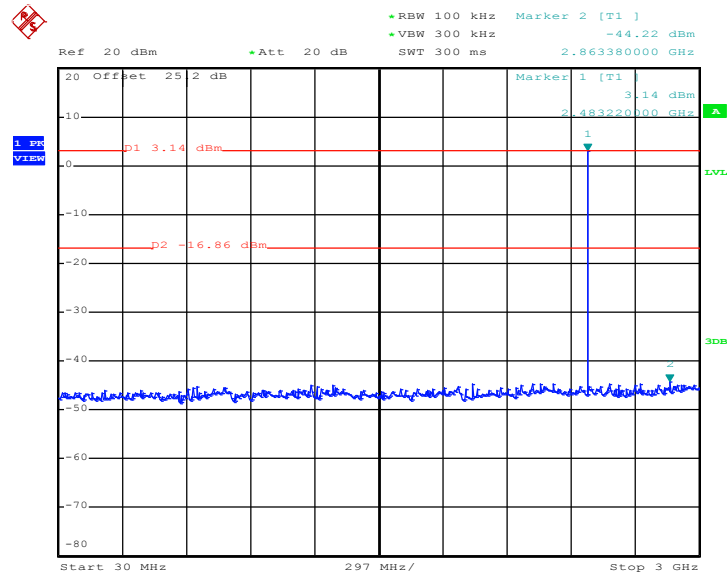

Date: 7.JUL.2018 04:39:37

CSE Plot on Ch 78 between 2 GHz ~ 25 GHz

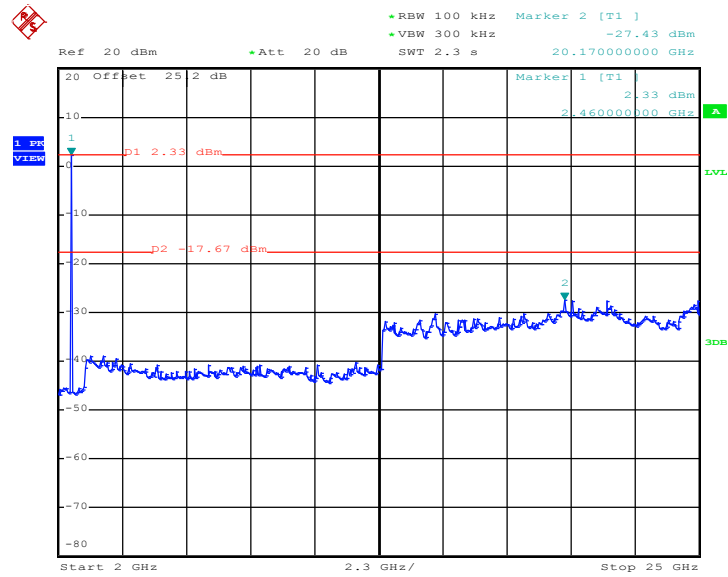

Date: 7.JUL.2018 04:40:28



3.8 Radiated Band Edges and Spurious Emission Measurement

3.8.1 Limit of Radiated Band Edges and Spurious Emission

In any 100 kHz bandwidth outside the intentional radiator frequency band, all harmonics/spurious must be at least 20 dB below the highest emission level within the authorized band. In addition, radiated emissions which fall in the restricted bands must also comply with the limits as below.

| Frequency (MHz) | Field Strength (microvolts/meter) | Measurement Distance (meters) |
|-----------------|-----------------------------------|-------------------------------|
| 0.009 – 0.490 | 2400/F(kHz) | 300 |
| 0.490 – 1.705 | 24000/F(kHz) | 30 |
| 1.705 – 30.0 | 30 | 30 |
| 30 – 88 | 100 | 3 |
| 88 – 216 | 150 | 3 |
| 216 - 960 | 200 | 3 |
| Above 960 | 500 | 3 |

3.8.2 Measuring Instruments

See list of measuring equipment of this test report.



3.8.3 Test Procedures

1. The EUT was placed on a turntable with 0.8 meter for frequency below 1GHz and 1.5 meter for frequency above 1GHz respectively above ground.
2. The EUT was set 3 meters from the interference receiving antenna, which was mounted on the top of a variable height antenna tower.
3. For each suspected emission, the EUT was arranged to its worst case and then tune the Antenna tower (from 1 m to 4 m) and turntable (from 0 degree to 360 degrees) to find the maximum reading. A pre-amp and a high pass filter are used for the test in order to get better signal level to comply with the guidelines.
4. Set to the maximum power setting and enable the EUT transmit continuously.
5. Use the following spectrum analyzer settings:
 - (1) Span shall wide enough to fully capture the emission being measured;
 - (2) Set RBW=100 kHz for $f < 1$ GHz, RBW=1MHz for $f > 1$ GHz ; VBW \geq RBW; Sweep = auto; Detector function = peak; Trace = max hold for peak
 - (3) For average measurement: use duty cycle correction factor method per 15.35(c).
Duty cycle = On time/100 milliseconds
On time = $N_1 * L_1 + N_2 * L_2 + \dots + N_{n-1} * L_{n-1} + N_n * L_n$
Where N_1 is number of type 1 pulses, L_1 is length of type 1 pulses, etc.
Average Emission Level = Peak Emission Level + $20 * \log(\text{Duty cycle})$
6. Corrected Reading: Antenna Factor + Cable Loss + Read Level - Preamp Factor = Level
7. For testing below 1GHz, if the emission level of the EUT in peak mode was 3 dB lower than the limit specified, then peak values of EUT will be reported, otherwise, the emissions will be repeated one by one using the CISPR quasi-peak method and reported.
8. For testing above 1GHz, the emission level of the EUT in peak mode was 20dB lower than average limit (that means the emission level in average mode also complies with the limit in average mode), then peak values of EUT will be reported, otherwise, the emissions will be measured in average mode again and reported.

Note: The average levels were calculated from the peak level corrected with duty cycle correction factor (-24.78dB) derived from $20 \log(\text{dwell time}/100\text{ms})$. This correction is only for signals that hop with the fundamental signal, such as band-edge and harmonic. Other spurious signals that are independent of the hopping signal would not use this correction.

3.8.4 Test Setup

For radiated emissions below 30MHz

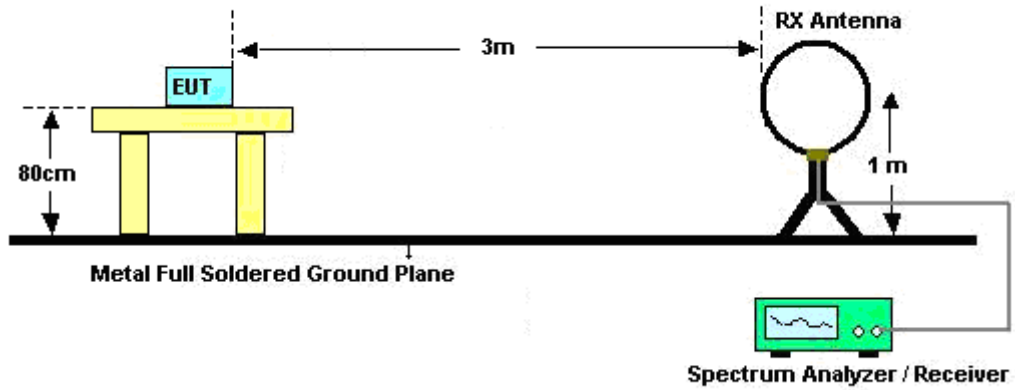

For radiated emissions from 30MHz to 1GHz

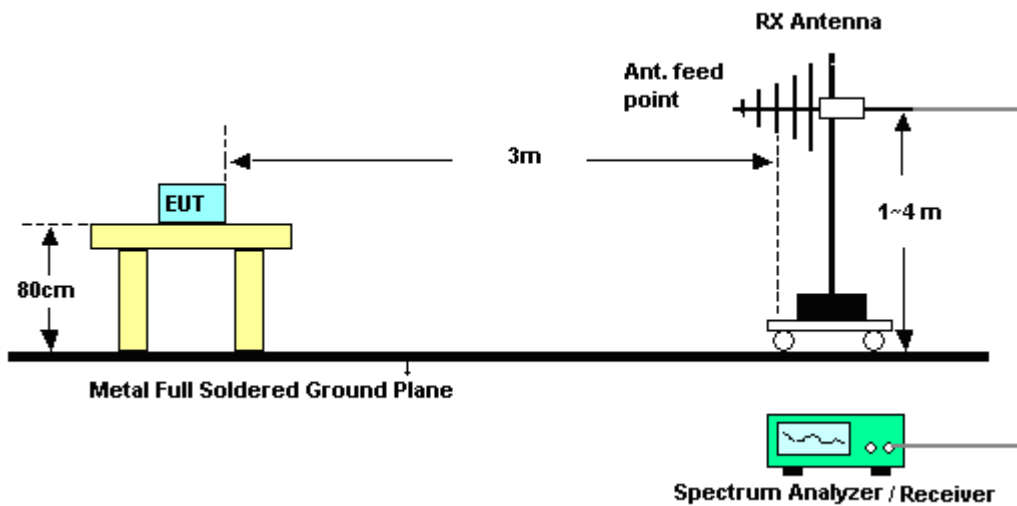

For radiated emissions above 1GHz

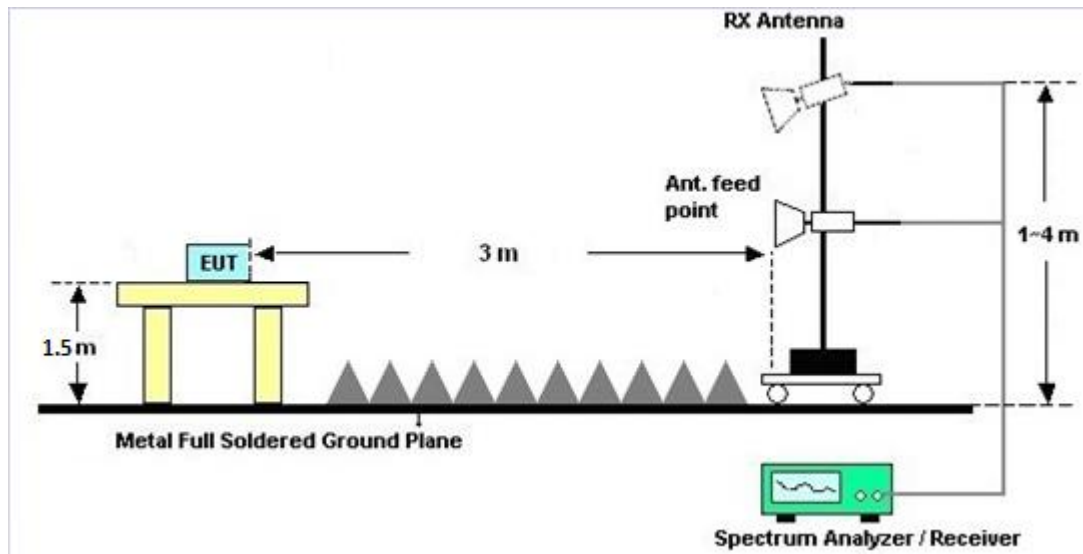

3.8.5 Test Results of Radiated Spurious Emissions (9 kHz ~ 30 MHz)

The low frequency, which started from 9 kHz to 30MHz, was pre-scanned and the result which was 20dB lower than the limit line was not reported.

There is a comparison data of both open-field test site and semi-Anechoic chamber, and the result came out very similar.

3.8.6 Test Result of Radiated Spurious at Band Edges

Please refer to Appendix C and D.

3.8.7 Duty Cycle

Please refer to Appendix E.

3.8.8 Test Result of Radiated Spurious Emission (30MHz ~ 10th Harmonic)

Please refer to Appendix C and D.



3.9 AC Conducted Emission Measurement

3.9.1 Limit of AC Conducted Emission

For equipment that is designed to be connected to the public utility (AC) power line, the radio frequency voltage that is conducted back onto the AC power line on any frequency or frequencies within the band 150 kHz to 30 MHz shall not exceed the limits in the following table.

| Frequency of emission (MHz) | Conducted limit (dBµV) | |
|-----------------------------|------------------------|-----------|
| | Quasi-peak | Average |
| 0.15-0.5 | 66 to 56* | 56 to 46* |
| 0.5-5 | 56 | 46 |
| 5-30 | 60 | 50 |

*Decreases with the logarithm of the frequency.

3.9.2 Measuring Instruments

See list of measuring equipment of this test report.

3.9.3 Test Procedures

1. The EUT was placed 0.4 meter from the conducting wall of the shielding room was kept at least 80 centimeters from any other grounded conducting surface.
2. Connect EUT to the power mains through a line impedance stabilization network (LISN).
3. All the support units are connecting to the other LISN.
4. The LISN provides 50 ohm coupling impedance for the measuring instrument.
5. The FCC states that a 50 ohm, 50 microhenry LISN should be used.
6. Both sides of AC line were checked for maximum conducted interference.
7. The frequency range from 150 kHz to 30 MHz was searched.
8. Set the test-receiver system to Peak Detect Function and specified bandwidth (IF Bandwidth = 9kHz) with Maximum Hold Mode. Then measurement is also conducted by Average Detector and Quasi-Peak Detector Function respectively.

3.9.4 Test Setup

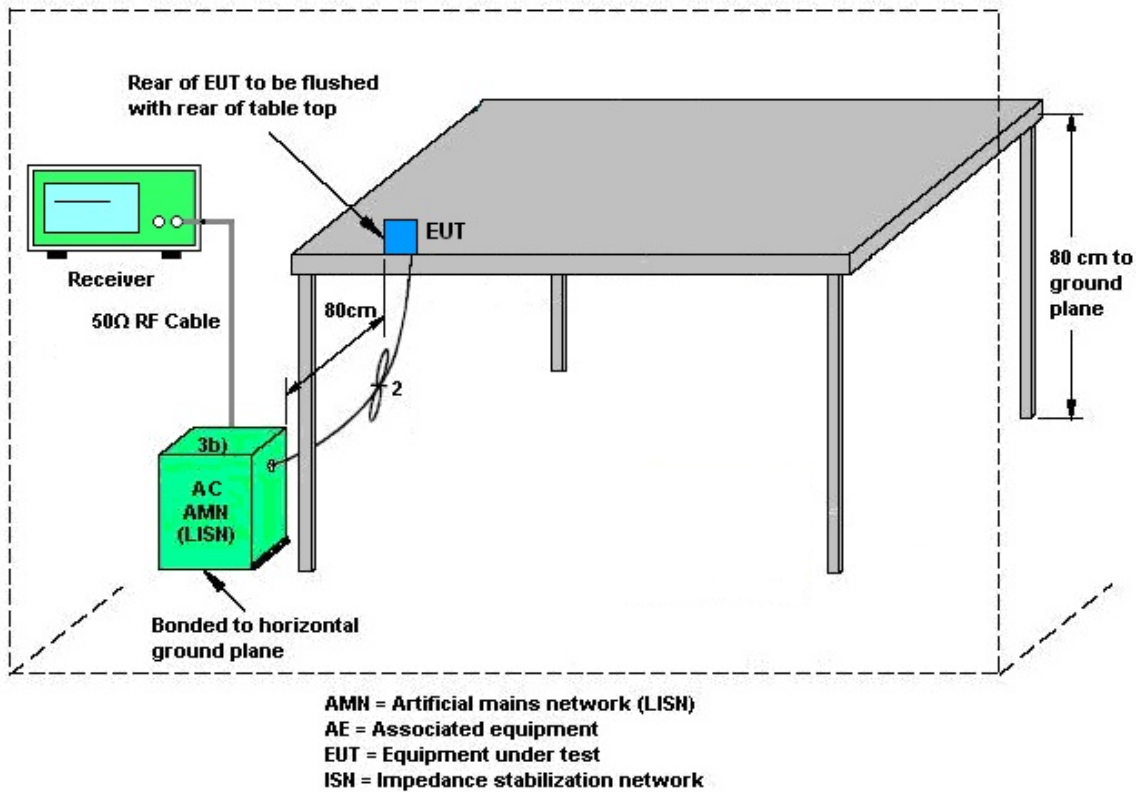

3.9.5 Test Result of AC Conducted Emission

Please refer to Appendix B.



3.10 Antenna Requirements

3.10.1 Standard Applicable

If directional gain of transmitting antennas is greater than 6dBi, the power shall be reduced by the same level in dB comparing to gain minus 6dBi. The use of a permanently attached antenna or of an antenna that uses a unique coupling to the intentional radiator shall be considered sufficient to comply with the rule.

3.10.2 Antenna Anti-Replacement Construction

An embedded-in antenna design is used.

3.10.3 Antenna Gain

The antenna peak gain of EUT is less than 6 dBi. Therefore, it is not necessary to reduce maximum peak output power limit.



4 List of Measuring Equipment

| Instrument | Manufacturer | Model No. | Serial No. | Characteristics | Calibration Date | Test Date | Due Date | Remark |
|-----------------------|-----------------|-------------------------------------|-------------|-------------------------------------|------------------|---------------------------------|---------------|--------------------------|
| Power Meter | Agilent | E4416A | GB41292344 | N/A | Dec. 20, 2017 | Jun. 25, 2018~ Jul. 10, 2018 | Dec. 19, 2018 | Conducted (TH05-HY) |
| Power Sensor | Agilent | E9327A | US40441548 | 50MHz~18GHz | Dec. 20, 2017 | Jun. 25, 2018~ Jul. 10, 2018 | Dec. 19, 2018 | Conducted (TH05-HY) |
| Spectrum Analyzer | Rohde & Schwarz | FSP30 | 101067 | 9kHz ~ 30GHz | Nov. 13, 2017 | Jun. 25, 2018~ Jul. 10, 2018 | Nov. 12, 2018 | Conducted (TH05-HY) |
| Switch Box & RF Cable | Burgeon | ETF-058 | EC1300484 | N/A | Mar. 01, 2018 | Jun. 25, 2018~ Jul. 10, 2018 | Feb. 28, 2019 | Conducted (TH05-HY) |
| AC Power Source | ChainTek | APC-1000W | N/A | N/A | N/A | Jul. 09, 2018 | N/A | Conduction (CO05-HY) |
| EMI Test Receiver | Rohde & Schwarz | ESR3 | 102388 | 3.6GHz | Dec. 08, 2017 | Jul. 09, 2018 | Dec. 07, 2018 | Conduction (CO05-HY) |
| LISN | Rohde & Schwarz | ENV216 | 100080 | 9kHz~30MHz | Nov. 30, 2017 | Jul. 09, 2018 | Nov. 29, 2018 | Conduction (CO05-HY) |
| LISN | Rohde & Schwarz | ENV216 | 100081 | 9kHz~30MHz | Dec. 08, 2017 | Jul. 09, 2018 | Dec. 07, 2018 | Conduction (CO05-HY) |
| Software | Rohde & Schwarz | EMC32 V10.30 | N/A | N/A | N/A | Jul. 09, 2018 | N/A | Conduction (CO05-HY) |
| LF Cable | HUBER + SUHNER | RG-214/U | LF01 | N/A | Jan. 03, 2018 | Jul. 09, 2018 | Jan. 02, 2019 | Conduction (CO05-HY) |
| Pulse Limiter | Rohde & Schwarz | ESH3-Z2 | 100851 | N/A | Jan. 03, 2018 | Jul. 09, 2018 | Jan. 02, 2019 | Conduction (CO05-HY) |
| Loop Antenna | Rohde & Schwarz | HFH2-Z2 | 100488 | 9 kHz~30 MHz | Nov. 23, 2017 | Jun. 30, 2018~ Jul. 12, 2018 | Nov. 22, 2018 | Radiation (03CH12-HY) |
| Bilog Antenna | TESEQ | CBL 6111D&00800 N1D01N-06 | 37059&01 | 30MHz~1GHz | Oct. 14, 2017 | Jun. 30, 2018~ Jul. 12, 2018 | Oct. 13, 2018 | Radiation (03CH12-HY) |
| Horn Antenna | SCHWARZBECK | BBHA 9120D | 9120D-1328 | 1GHz ~ 18GHz | Oct. 20, 2017 | Jun. 30, 2018~ Jul. 12, 2018 | Oct. 19, 2018 | Radiation (03CH12-HY) |
| SHF-EHF Horn Antenna | SCHWARZBECK | BBHA 9170 | BBHA9170584 | 18GHz ~ 40GHz | Nov. 27, 2017 | Jun. 30, 2018~ Jul. 12, 2018 | Nov. 26, 2018 | Radiation (03CH12-HY) |
| Preamplifier | COM-POWER | PA-103 | 161075 | 10MHz~1GHz | Mar. 26, 2018 | Jun. 30, 2018~ Jul. 12, 2018 | Mar. 25, 2019 | Radiation (03CH12-HY) |
| Preamplifier | Keysight | 83017A | MY53270148 | 1GHz~26.5GHz | Jan. 15, 2018 | Jun. 30, 2018~ Jul. 12, 2018 | Jan. 14, 2019 | Radiation (03CH12-HY) |
| Preamplifier | MITEQ | AMF-7D-0010 1800-30-10P | 1590074 | 1GHz~18GHz | May 21, 2018 | Jun. 30, 2018~ Jul. 12, 2018 | May 20, 2019 | Radiation (03CH12-HY) |
| Amplifier | MITEQ | TTA1840-35- HG | 1871923 | 18GHz~40GHz, VSWR : 2.5:1 max | Jul. 18, 2017 | Jun. 30, 2018~ Jul. 12, 2018 | Jul. 17, 2018 | Radiation (03CH12-HY) |
| EMI Test Receiver | Rohde & Schwarz | ESU26 | 100390 | 20Hz~26.5GHz | Dec. 25, 2017 | Jun. 30, 2018~ Jul. 12, 2018 | Dec. 24, 2018 | Radiation (03CH12-HY) |
| Filter | Wainwright | WLKS1200-1 2SS | SN2 | 1.2G Low Pass | Jul. 17, 2017 | Jun. 30, 2018~ Jul. 12, 2018 | Jul. 16, 2018 | Radiation (03CH12-HY) |
| Filter | Wainwright | WHKX12-270 0-3000-18000 -60ST | SN2 | 3 GHz Highpass | Jul. 17, 2017 | Jun. 30, 2018~ Jul. 12, 2018 | Jul. 16, 2018 | Radiation (03CH12-HY) |



| Instrument | Manufacturer | Model No. | Serial No. | Characteristics | Calibration Date | Test Date | Due Date | Remark |
|--------------|----------------|-------------------|------------|-----------------|------------------|---------------------------------|---------------|-----------------------|
| RF Cable | HUBER + SUHNER | SUCOFLEX 126E | 0058/126E | 30M-18G | Mar. 14, 2018 | Jun. 30, 2018~ Jul. 12, 2018 | Mar. 13, 2019 | Radiation (03CH12-HY) |
| RF Cable | HUBER + SUHNER | SUCOFLEX 102 | 505134/2 | 30M~40GHz | Oct. 17, 2017 | Jun. 30, 2018~ Jul. 12, 2018 | Oct. 16, 2018 | Radiation (03CH12-HY) |
| RF Cable | HUBER + SUHNER | SUCOFLEX 102 | 800740/2 | 30M~40GHz | Oct. 17, 2017 | Jun. 30, 2018~ Jul. 12, 2018 | Oct. 16, 2018 | Radiation (03CH12-HY) |
| Antenna Mast | EMEC | AM-BS-4500-B | N/A | 1m~4m | N/A | Jun. 30, 2018~ Jul. 12, 2018 | N/A | Radiation (03CH12-HY) |
| Turn Table | EMEC | TT2000 | N/A | 0~360 Degree | N/A | Jun. 30, 2018~ Jul. 12, 2018 | N/A | Radiation (03CH12-HY) |
| Software | Audix | E3 6.2009-8-24 | RK-000989 | N/A | N/A | Jun. 30, 2018~ Jul. 12, 2018 | N/A | Radiation (03CH12-HY) |



5 Uncertainty of Evaluation

Uncertainty of Conducted Emission Measurement (150 kHz ~ 30 MHz)

| | |
|---|-----|
| Measuring Uncertainty for a Level of Confidence of 95% ($U = 2Uc(y)$) | 2.7 |
|---|-----|

Uncertainty of Radiated Emission Measurement (30 MHz ~ 1000 MHz)

| | |
|---|-----|
| Measuring Uncertainty for a Level of Confidence of 95% ($U = 2Uc(y)$) | 5.1 |
|---|-----|

Uncertainty of Radiated Emission Measurement (1000 MHz ~ 18000 MHz)

| | |
|---|-----|
| Measuring Uncertainty for a Level of Confidence of 95% ($U = 2Uc(y)$) | 5.2 |
|---|-----|

Uncertainty of Radiated Emission Measurement (18000 MHz ~ 40000 MHz)

| | |
|---|-----|
| Measuring Uncertainty for a Level of Confidence of 95% ($U = 2Uc(y)$) | 4.7 |
|---|-----|

Appendix A. Test Result of Conducted Test Items

| | | | | |
|----------------|-----------------------|--------------------|-------|----|
| Test Engineer: | Allen Lin/Shiming Liu | Temperature: | 21~25 | °C |
| Test Date: | 2018/6/25~2018/7/10 | Relative Humidity: | 51~54 | % |

| TEST RESULTS DATA | | | | | | | | | |
|---|-----------|-----|-----|-------------|---------------|---------------------|--|--|-----------|
| 20dB and 99% Occupied Bandwidth and Hopping Channel Separation | | | | | | | | | |
| Mod. | Data Rate | NTX | CH. | Freq. (MHz) | 20db BW (MHz) | 99% Bandwidth (MHz) | Hopping Channel Separation Measurement (MHz) | Hopping Channel Separation Measurement Limit (MHz) | Pass/Fail |
| DH | 1Mbps | 1 | 0 | 2402 | 0.892 | 0.832 | 1.008 | 0.5947 | Pass |
| DH | 1Mbps | 1 | 39 | 2441 | 0.888 | 0.828 | 0.996 | 0.5920 | Pass |
| DH | 1Mbps | 1 | 78 | 2480 | 0.876 | 0.832 | 0.996 | 0.5840 | Pass |
| 2DH | 2Mbps | 1 | 0 | 2402 | 1.206 | 1.136 | 1.002 | 0.8040 | Pass |
| 2DH | 2Mbps | 1 | 39 | 2441 | 1.206 | 1.132 | 1.002 | 0.8040 | Pass |
| 2DH | 2Mbps | 1 | 78 | 2480 | 1.212 | 1.136 | 1.314 | 0.8080 | Pass |
| 3DH | 3Mbps | 1 | 0 | 2402 | 1.218 | 1.128 | 1.002 | 0.8120 | Pass |
| 3DH | 3Mbps | 1 | 39 | 2441 | 1.218 | 1.128 | 1.002 | 0.8120 | Pass |
| 3DH | 3Mbps | 1 | 78 | 2480 | 1.218 | 1.128 | 1.014 | 0.8120 | Pass |

| TEST RESULTS DATA | | | | | | |
|--------------------------|-----------------------------|--------------------------------|------------------------------|------------------|--------------|-----------|
| Dwell Time | | | | | | |
| Mod. | Hopping Channel Number Rate | Hops Over Occupancy Time(hops) | Package Transfer Time (msec) | Dwell Time (sec) | Limits (sec) | Pass/Fail |
| Nomal | 79 | 106.67 | 2.90 | 0.31 | 0.4 | Pass |
| AFH | 20 | 53.33 | 2.90 | 0.15 | 0.4 | Pass |

| TEST RESULTS DATA | | | | | |
|--------------------------|-----|-----|------------------|-------------------|-------------|
| Peak Power Table | | | | | |
| DH | CH. | NTX | Peak Power (dBm) | Power Limit (dBm) | Test Result |
| DH1 | 0 | 1 | 5.12 | 20.97 | Pass |
| | 39 | 1 | 5.72 | 20.97 | Pass |
| | 78 | 1 | 6.02 | 20.97 | Pass |
| 2DH1 | 0 | 1 | 5.13 | 20.97 | Pass |
| | 39 | 1 | 5.73 | 20.97 | Pass |
| | 78 | 1 | 6.03 | 20.97 | Pass |
| 3DH1 | 0 | 1 | 5.12 | 20.97 | Pass |
| | 39 | 1 | 5.72 | 20.97 | Pass |
| | 78 | 1 | 6.00 | 20.97 | Pass |

| TEST RESULTS DATA | | | | |
|----------------------------|-----|-----|---------------------|------------------|
| Average Power Table | | | | |
| (Reporting Only) | | | | |
| DH | CH. | NTX | Average Power (dBm) | Duty Factor (dB) |
| DH1 | 0 | 1 | 4.86 | 8.32 |
| | 39 | 1 | 5.50 | 8.32 |
| | 78 | 1 | 5.81 | 8.32 |
| 2DH1 | 0 | 1 | 3.10 | 8.20 |
| | 39 | 1 | 3.85 | 8.20 |
| | 78 | 1 | 4.09 | 8.20 |
| 3DH1 | 0 | 1 | 2.99 | 8.20 |
| | 39 | 1 | 3.75 | 8.20 |
| | 78 | 1 | 3.98 | 8.20 |

| TEST RESULTS DATA | | | |
|------------------------------------|--------------------------------------|------------------|-----------|
| Number of Hopping Frequency | | | |
| Number of Hopping (Channel) | Adaptive Frequency Hopping (Channel) | Limits (Channel) | Pass/Fail |
| 79 | 20 | > 15 | Pass |



Appendix B. AC Conducted Emission Test Results

| | | | |
|-----------------|--------------|---------------------|---------|
| Test Engineer : | Kai-Chun Chu | Temperature : | 24~26°C |
| | | Relative Humidity : | 51~55% |

EUT Information

Report NO : 832126-02
 Test Mode : Mode 1
 Test Voltage : 120Vac/60Hz
 Phase : Line

Full Spectrum

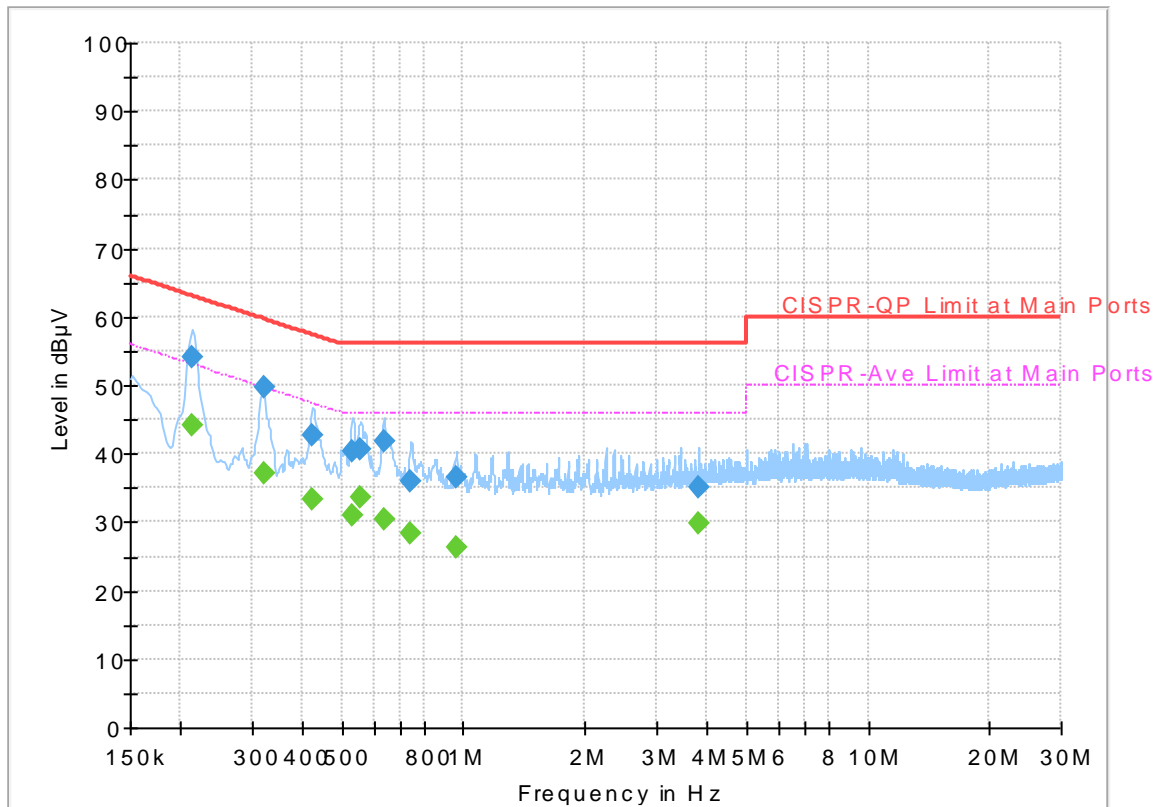

Final_Result

| Frequency (MHz) | QuasiPeak (dBµV) | CAverage (dBµV) | Limit (dBµV) | Margin (dB) | Line | Filter | Corr. (dB) |
|-----------------|------------------|-----------------|--------------|-------------|------|--------|------------|
| 0.213000 | --- | 44.07 | 53.09 | 9.02 | L1 | OFF | 19.5 |
| 0.213000 | 54.11 | --- | 63.09 | 8.98 | L1 | OFF | 19.5 |
| 0.321000 | --- | 37.03 | 49.68 | 12.65 | L1 | OFF | 19.5 |
| 0.321000 | 49.72 | --- | 59.68 | 9.96 | L1 | OFF | 19.5 |
| 0.422250 | --- | 33.39 | 47.40 | 14.01 | L1 | OFF | 19.5 |
| 0.422250 | 42.79 | --- | 57.40 | 14.61 | L1 | OFF | 19.5 |
| 0.530250 | --- | 31.14 | 46.00 | 14.86 | L1 | OFF | 19.5 |
| 0.530250 | 40.36 | --- | 56.00 | 15.64 | L1 | OFF | 19.5 |
| 0.555000 | --- | 33.51 | 46.00 | 12.49 | L1 | OFF | 19.5 |
| 0.555000 | 40.55 | --- | 56.00 | 15.45 | L1 | OFF | 19.5 |
| 0.638250 | --- | 30.52 | 46.00 | 15.48 | L1 | OFF | 19.6 |
| 0.638250 | 41.75 | --- | 56.00 | 14.25 | L1 | OFF | 19.6 |
| 0.741750 | --- | 28.39 | 46.00 | 17.61 | L1 | OFF | 19.6 |
| 0.741750 | 36.01 | --- | 56.00 | 19.99 | L1 | OFF | 19.6 |
| 0.957750 | --- | 26.42 | 46.00 | 19.58 | L1 | OFF | 19.6 |
| 0.957750 | 36.47 | --- | 56.00 | 19.53 | L1 | OFF | 19.6 |
| 3.822000 | --- | 29.70 | 46.00 | 16.30 | L1 | OFF | 19.7 |
| 3.822000 | 35.03 | --- | 56.00 | 20.97 | L1 | OFF | 19.7 |

EUT Information

Report NO : 832126-02
 Test Mode : Mode 1
 Test Voltage : 120Vac/60Hz
 Phase : Neutral

Full Spectrum

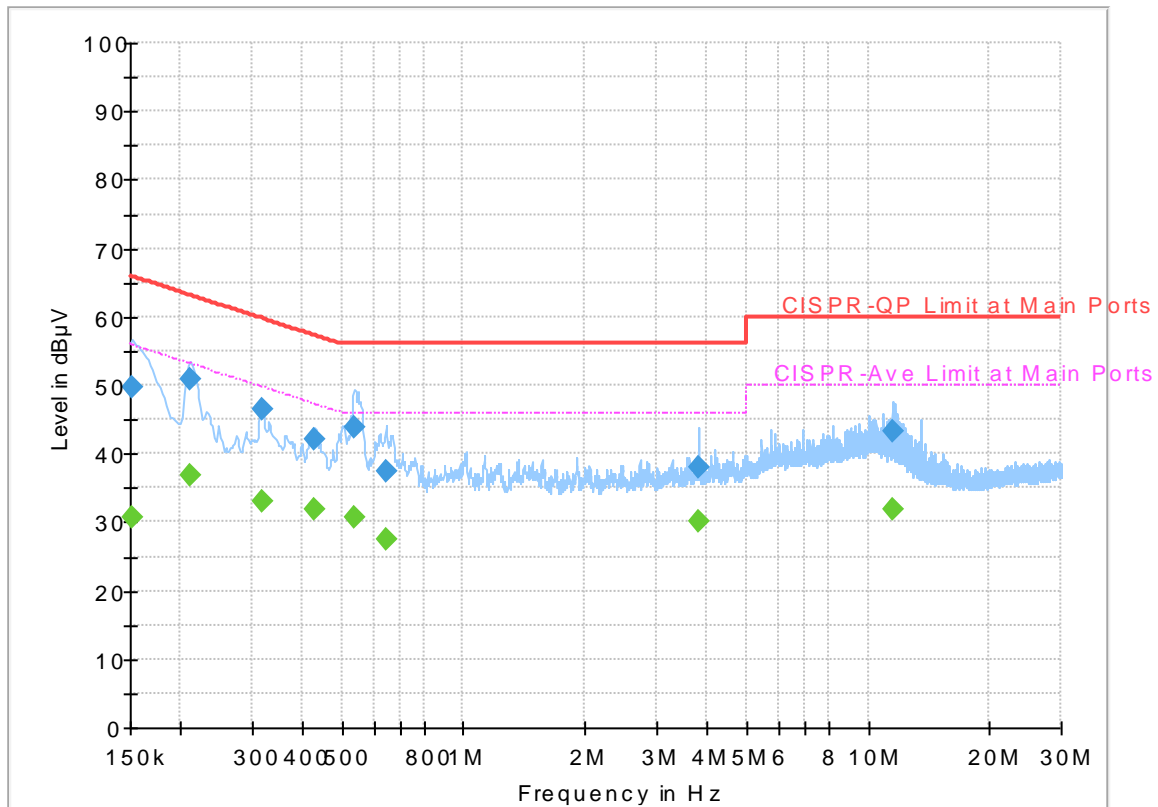

Final_Result

| Frequency (MHz) | QuasiPeak (dBµV) | CAverage (dBµV) | Limit (dBµV) | Margin (dB) | Line | Filter | Corr. (dB) |
|-----------------|------------------|-----------------|--------------|-------------|------|--------|------------|
| 0.152250 | --- | 30.76 | 55.88 | 25.12 | N | OFF | 19.5 |
| 0.152250 | 49.85 | --- | 65.88 | 16.03 | N | OFF | 19.5 |
| 0.210750 | --- | 36.91 | 53.18 | 16.27 | N | OFF | 19.5 |
| 0.210750 | 50.90 | --- | 63.18 | 12.28 | N | OFF | 19.5 |
| 0.318750 | --- | 33.02 | 49.74 | 16.72 | N | OFF | 19.5 |
| 0.318750 | 46.41 | --- | 59.74 | 13.33 | N | OFF | 19.5 |
| 0.429000 | --- | 31.77 | 47.27 | 15.50 | N | OFF | 19.5 |
| 0.429000 | 42.14 | --- | 57.27 | 15.13 | N | OFF | 19.5 |
| 0.539250 | --- | 30.60 | 46.00 | 15.40 | N | OFF | 19.5 |
| 0.539250 | 43.93 | --- | 56.00 | 12.07 | N | OFF | 19.5 |
| 0.645000 | --- | 27.35 | 46.00 | 18.65 | N | OFF | 19.6 |
| 0.645000 | 37.50 | --- | 56.00 | 18.50 | N | OFF | 19.6 |
| 3.817500 | --- | 30.17 | 46.00 | 15.83 | N | OFF | 19.7 |
| 3.817500 | 38.03 | --- | 56.00 | 17.97 | N | OFF | 19.7 |
| 11.458500 | --- | 31.87 | 50.00 | 18.13 | N | OFF | 20.0 |
| 11.458500 | 43.20 | --- | 60.00 | 16.80 | N | OFF | 20.0 |



Appendix C. Radiated Spurious Emission

| | | | |
|-----------------|---------------------------|---------------------|---------|
| Test Engineer : | Jacky Hung and Peter Liao | Temperature : | 22~25°C |
| | | Relative Humidity : | 58~65% |

2.4GHz 2400~2483.5MHz

BT (Band Edge @ 3m)

| BT | Note | Frequency | Level | Over Limit | Limit Line | Read Level | Antenna Factor | Path Loss | Preamp Factor | Ant Pos | Table Pos | Peak Avg. | Pol. |
|------------------------|------|-----------|------------|------------|------------|------------|----------------|-----------|---------------|---------|-----------|-----------|---------|
| | | (MHz) | (dBμV/m) | (dB) | (dBμV/m) | (dBμV) | (dB/m) | (dB) | (dB) | (cm) | (deg) | (P/A) | (H/V) |
| BT CH00 2402MHz | | 2384.97 | 46.09 | -27.91 | 74 | 43.91 | 27.11 | 6.65 | 31.58 | 297 | 216 | P | H |
| | | 2384.97 | 21.31 | -32.69 | 54 | - | - | - | - | - | - | A | H |
| | * | 2402 | 98.25 | - | - | 96 | 27.15 | 6.67 | 31.57 | 297 | 216 | P | H |
| | * | 2402 | 73.47 | - | - | - | - | - | - | - | - | A | H |
| | | 2364.915 | 45.76 | -28.24 | 74 | 43.65 | 27.07 | 6.62 | 31.58 | 367 | 192 | P | V |
| | | 2364.915 | 20.98 | -33.02 | 54 | - | - | - | - | - | - | A | V |
| | * | 2402 | 102.8 | - | - | 100.55 | 27.15 | 6.67 | 31.57 | 367 | 192 | P | V |
| | * | 2402 | 78.02 | - | - | - | - | - | - | - | - | A | V |
| BT CH 39 2441MHz | | 2378.6 | 45.77 | -28.23 | 74 | 43.6 | 27.11 | 6.64 | 31.58 | 116 | 190 | P | H |
| | | 2378.6 | 20.99 | -33.01 | 54 | - | - | - | - | - | - | A | H |
| | * | 2441 | 99.34 | - | - | 96.89 | 27.28 | 6.73 | 31.56 | 116 | 190 | P | H |
| | * | 2441 | 74.56 | - | - | - | - | - | - | - | - | A | H |
| | | 2483.83 | 47.02 | -26.98 | 74 | 44.43 | 27.36 | 6.79 | 31.56 | 116 | 190 | P | H |
| | | 2483.83 | 22.24 | -31.76 | 54 | - | - | - | - | - | - | A | H |
| | | 2361.8 | 46.1 | -27.9 | 74 | 44 | 27.07 | 6.61 | 31.58 | 355 | 194 | P | V |
| | | 2361.8 | 21.32 | -32.68 | 54 | - | - | - | - | - | - | A | V |
| | * | 2441 | 100.79 | - | - | 98.34 | 27.28 | 6.73 | 31.56 | 355 | 194 | P | V |
| | * | 2441 | 76.01 | - | - | - | - | - | - | - | - | A | V |
| | | 2490.13 | 45.71 | -28.29 | 74 | 43.07 | 27.4 | 6.8 | 31.56 | 355 | 194 | P | V |
| | | 2490.13 | 20.93 | -33.07 | 54 | - | - | - | - | - | - | A | V |



| | | | | | | | | | | | | | |
|---------------------------------|---|---------|--------|--------|----|-------|-------|------|-------|-----|-----|---|---|
| BT CH 78 2480MHz | * | 2480 | 102.38 | - | - | 99.79 | 27.36 | 6.79 | 31.56 | 106 | 152 | P | H |
| | * | 2480 | 77.6 | - | - | - | - | - | - | - | - | A | H |
| | | 2483.52 | 48.98 | -25.02 | 74 | 46.39 | 27.36 | 6.79 | 31.56 | 106 | 152 | P | H |
| | | 2483.52 | 24.2 | -29.8 | 54 | - | - | - | - | - | - | A | H |
| | * | 2480 | 98.29 | - | - | 95.7 | 27.36 | 6.79 | 31.56 | 303 | 43 | P | V |
| | * | 2480 | 73.51 | - | - | - | - | - | - | - | - | A | V |
| | | 2488.12 | 46.39 | -27.61 | 74 | 43.75 | 27.4 | 6.8 | 31.56 | 303 | 43 | P | V |
| | | 2488.12 | 21.61 | -32.39 | 54 | - | - | - | - | - | - | A | V |
| Remark | 1. No other spurious found. 2. All results are PASS against Peak and Average limit line. | | | | | | | | | | | | |



2.4GHz 2400~2483.5MHz

BT (Harmonic @ 3m)

| BT | Note | Frequency (MHz) | Level (dBμV/m) | Over Limit (dB) | Limit Line (dBμV/m) | Read Level (dBμV) | Antenna Factor (dB/m) | Path Loss (dB) | Preamp Factor (dB) | Ant Pos (cm) | Table Pos (deg) | Peak Avg. (P/A) | Pol. (H/V) |
|------------------------|---|----------------------|---------------------|-------------------------|-----------------------------|---------------------------|-------------------------------|------------------------|----------------------------|----------------------|-------------------------|-------------------------|-----------------|
| BT CH 00 2402MHz | | 4804 | 39.65 | -34.35 | 74 | 55.5 | 31.32 | 10.42 | 57.59 | 100 | 0 | P | H |
| | | 4804 | 14.87 | -39.13 | 54 | - | - | - | - | - | - | A | H |
| | | 4804 | 42.94 | -31.06 | 74 | 58.79 | 31.32 | 10.42 | 57.59 | 100 | 0 | P | V |
| | | 4804 | 18.16 | -35.84 | 54 | - | - | - | - | - | - | A | V |
| BT CH 39 2441MHz | | 4882 | 40.35 | -33.65 | 74 | 55.86 | 31.46 | 10.47 | 57.44 | 100 | 0 | P | H |
| | | 4882 | 15.57 | -38.43 | 54 | - | - | - | - | - | - | A | H |
| | | 7323 | 45.87 | -28.13 | 74 | 54.23 | 36.15 | 12.78 | 57.29 | 100 | 0 | P | H |
| | | 7323 | 21.09 | -32.91 | 54 | - | - | - | - | - | - | A | H |
| | | 4882 | 40.06 | -33.94 | 74 | 55.57 | 31.46 | 10.47 | 57.44 | 100 | 0 | P | V |
| | | 4882 | 15.28 | -38.72 | 54 | - | - | - | - | - | - | A | V |
| | | 7323 | 44.96 | -29.04 | 74 | 53.32 | 36.15 | 12.78 | 57.29 | 100 | 0 | P | V |
| | | 7323 | 20.18 | -33.82 | 54 | - | - | - | - | - | - | A | V |
| BT CH 78 2480MHz | | 4960 | 40.11 | -33.89 | 74 | 55.25 | 31.63 | 10.51 | 57.28 | 100 | 0 | P | H |
| | | 4960 | 15.33 | -38.67 | 54 | - | - | - | - | - | - | A | H |
| | | 7440 | 45.11 | -28.89 | 74 | 53.27 | 36.47 | 12.8 | 57.43 | 100 | 0 | P | H |
| | | 7440 | 20.33 | -33.67 | 54 | - | - | - | - | - | - | A | H |
| | | 4960 | 40.15 | -33.85 | 74 | 55.29 | 31.63 | 10.51 | 57.28 | 100 | 0 | P | V |
| | | 4960 | 15.37 | -38.63 | 54 | - | - | - | - | - | - | A | V |
| | | 7440 | 45.51 | -28.49 | 74 | 53.67 | 36.47 | 12.8 | 57.43 | 100 | 0 | P | V |
| | | 7440 | 20.73 | -33.27 | 54 | - | - | - | - | - | - | A | V |
| Remark | 1. No other spurious found. 2. All results are PASS against Peak and Average limit line. | | | | | | | | | | | | |



Emission below 1GHz

2.4GHz BT (LF)

| BT | Note | Frequency | Level | Over | Limit | Read | Antenna | Path | Preamp | Ant | Table | Peak | Pol. |
|--------------------|--|-----------|------------|--------|------------|----------|----------|--------|--------|--------|---------|---------|---------|
| | | (MHz) | (dBμV/m) | (dB) | (dBμV/m) | (dBμV) | (dB/m) | (dB) | (dB) | (cm) | (deg) | (P/A) | (H/V) |
| 2.4GHz BT LF | | 60.78 | 30.5 | -9.5 | 40 | 48.08 | 11.77 | 1.11 | 30.46 | - | - | P | H |
| | | 136.65 | 29.36 | -14.14 | 43.5 | 40.87 | 17.23 | 1.65 | 30.39 | - | - | P | H |
| | | 231.42 | 30.2 | -15.8 | 46 | 41.93 | 16.3 | 2.23 | 30.26 | - | - | P | H |
| | | 369.3 | 30.19 | -15.81 | 46 | 36.73 | 20.78 | 2.71 | 30.03 | - | - | P | H |
| | | 897.8 | 36.82 | -9.18 | 46 | 32.81 | 28.9 | 4.25 | 29.14 | 100 | 0 | P | H |
| | | 966.4 | 33.89 | -20.11 | 54 | 27.51 | 30.88 | 4.45 | 28.95 | - | - | P | H |
| | | 34.32 | 29.75 | -10.25 | 40 | 36.76 | 22.49 | 0.76 | 30.26 | - | - | P | V |
| | | 105.33 | 23.79 | -19.71 | 43.5 | 36.3 | 16.47 | 1.44 | 30.42 | - | - | P | V |
| | | 219.27 | 22.81 | -23.19 | 46 | 35.89 | 15.05 | 2.16 | 30.29 | - | - | P | V |
| | | 576.5 | 27.55 | -18.45 | 46 | 28.17 | 25.68 | 3.37 | 29.67 | - | - | P | V |
| | | 729.1 | 36.94 | -9.06 | 46 | 35.26 | 27.36 | 3.77 | 29.45 | - | - | P | V |
| | | 897.8 | 38.66 | -7.34 | 46 | 34.65 | 28.9 | 4.25 | 29.14 | 100 | 0 | P | V |
| Remark | 1. No other spurious found. 2. All results are PASS against limit line. | | | | | | | | | | | | |



Note symbol

| | |
|-----|--|
| * | Fundamental Frequency which can be ignored. However, the level of any unwanted emissions shall not exceed the level of the fundamental frequency. |
| ! | Test result is over limit line. |
| P/A | Peak or Average |
| H/V | Horizontal or Vertical |



A calculation example for radiated spurious emission is shown as below:

| BT | Note | Frequency | Level | Over | Limit | Read | Antenna | Path | Preamp | Ant | Table | Peak | Pol. |
|---------|------|-----------|------------|--------|------------|----------|----------|--------|--------|--------|---------|---------|---------|
| | | (MHz) | (dBμV/m) | (dB) | Line | Level | Factor | Loss | Factor | Pos | Pos | Avg. | |
| | | | | | (dBμV/m) | (dBμV) | (dB/m) | (dB) | (dB) | (cm) | (deg) | (P/A) | (H/V) |
| BT | | 2390 | 55.45 | -18.55 | 74 | 54.51 | 32.22 | 4.58 | 35.86 | 103 | 308 | P | H |
| CH 00 | | 2390 | 43.54 | -10.46 | 54 | 42.6 | 32.22 | 4.58 | 35.86 | 103 | 308 | A | H |
| 2402MHz | | | | | | | | | | | | | |

1. Path Loss(dB) = Cable loss(dB) + Filter loss(dB) + Attenuator loss(dB)
2. Level(dBμV/m) =
Antenna Factor(dB/m) + Path Loss(dB) + Read Level(dBμV) - Preamp Factor(dB)
3. Over Limit(dB) = Level(dBμV/m) – Limit Line(dBμV/m)

For Peak Limit @ 2390MHz:

1. Level(dBμV/m)
= Antenna Factor(dB/m) + Path Loss(dB) + Read Level(dBμV) - Preamp Factor(dB)
= 32.22(dB/m) + 4.58(dB) + 54.51(dBμV) – 35.86 (dB)
= 55.45 (dBμV/m)
2. Over Limit(dB)
= Level(dBμV/m) – Limit Line(dBμV/m)
= 55.45(dBμV/m) – 74(dBμV/m)
= -18.55(dB)

For Average Limit @ 2390MHz:

1. Level(dBμV/m)
= Antenna Factor(dB/m) + Path Loss(dB) + Read Level(dBμV) - Preamp Factor(dB)
= 32.22(dB/m) + 4.58(dB) + 42.6(dBμV) – 35.86 (dB)
= 43.54 (dBμV/m)
2. Over Limit(dB)
= Level(dBμV/m) – Limit Line(dBμV/m)
= 43.54(dBμV/m) – 54(dBμV/m)
= -10.46(dB)

Both peak and average measured complies with the limit line, so test result is “PASS”.



Appendix D. Radiated Spurious Emission Plots

| | | | |
|-----------------|---------------------------|---------------------|---------|
| Test Engineer : | Jacky Hung and Peter Liao | Temperature : | 22~25°C |
| | | Relative Humidity : | 58~65% |

Note symbol

| | |
|----|-----------------------|
| -L | Low channel location |
| -R | High channel location |

2.4GHz 2400~2483.5MHz

BT (Band Edge @ 3m)

| BT | 2.4GHz 2400~2483.5MHz Band Edge @ 3m | |
|------|---|--|
| ANT | BT CH00 2402MHz | |
| 1 | Horizontal | Fundamental |
| Peak | <p>Site : 03CH12-HY Condition : PEAK_BE_74 3m HORN_91200_1328 HORIZONTAL Detector : Peak Project : 832126-02 Mode : 1</p> | <p>Site : 03CH12-HY Condition : PEAK_74 3m HORN_91200_1328 HORIZONTAL Detector : Peak Project : 832126-02 Mode : 1</p> |

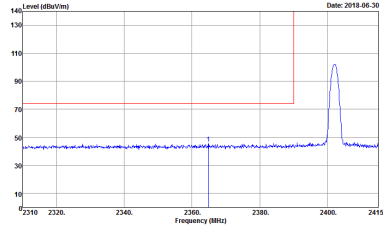
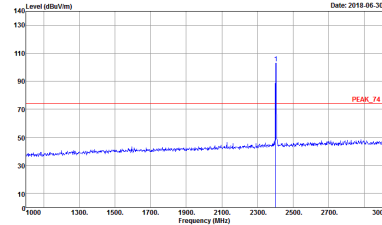

| BT | 2.4GHz 2400~2483.5MHz Band Edge @ 3m | |
|-------------|--|--|
| ANT | BT CH00 2402MHz | |
| 1 | Vertical | Fundamental |
| Peak |  <p>Site : 03CH2-1FY Condition : PEAK_9C_74 3m HORN_91200_1328 VERTICAL Detector : RBW:3000.000kHz VBW:3000.000kHz SWT:Auto Project : Peak Project : 832126-02 Mode : 1</p> |  <p>Site : 03CH2-1FY Condition : PEAK_74 3m HORN_91200_1328 VERTICAL Detector : RBW:3000.000kHz VBW:3000.000kHz SWT:Auto Project : Peak Project : 832126-02 Mode : 1</p> |

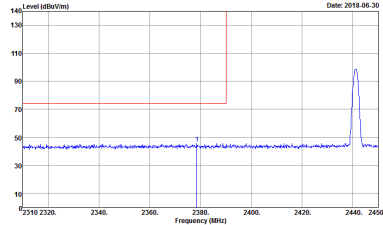
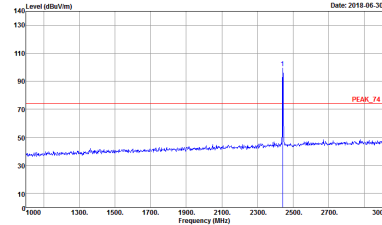
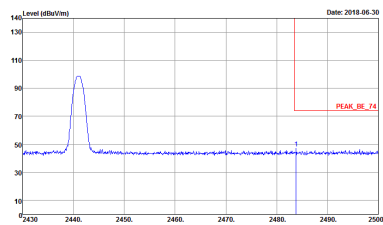

| BT | 2.4GHz 2400~2483.5MHz Band Edge @ 3m | |
|--------------------|---|---|
| ANT | BT CH39 2441MHz | |
| 1 | Horizontal | Fundamental |
| <p>Peak</p> |  <p>Site : 03CH12-HY Condition : PEAK_BE_74 3m HORN_91200_1328 HORIZONTAL RBW:3000.000kHz VBW:3000.000kHz SWT:Auto Detector : Peak Project : 832126-02 Mode : 2</p> |  <p>Site : 03CH12-HY Condition : PEAK_74 3m HORN_91200_1328 HORIZONTAL RBW:3000.000kHz VBW:3000.000kHz SWT:Auto Detector : Peak Project : 832126-02 Mode : 2</p> |
| <p>Peak</p> |  <p>Site : 03CH12-HY Condition : PEAK_BE_74 3m HORN_91200_1328 HORIZONTAL RBW:3000.000kHz VBW:3000.000kHz SWT:Auto Detector : Peak Project : 832126-02 Mode : 2</p> | <p>Left blank</p> |



| BT | 2.4GHz 2400~2483.5MHz Band Edge @ 3m | |
|--------------------|---|--|
| ANT | BT CH39 2441MHz | |
| 1 | Vertical | Fundamental |
| <p>Peak</p> | <p>Site : 03CH12-HY Condition : PEAK_BE_74 3m HORN_9120D_1328 VERTICAL RBW:3000.000kHz VBW:3000.000kHz SWT:Auto Detector : Peak Project : 832126-02 Mode : 2</p> | <p>Site : 03CH12-HY Condition : PEAK_74 3m HORN_9120D_1328 VERTICAL RBW:3000.000kHz VBW:3000.000kHz SWT:Auto Detector : Peak Project : 832126-02 Mode : 2</p> |
| <p>Peak</p> | <p>Site : 03CH12-HY Condition : PEAK_BE_74 3m HORN_9120D_1328 VERTICAL RBW:3000.000kHz VBW:3000.000kHz SWT:Auto Detector : Peak Project : 832126-02 Mode : 2</p> | <p>Left blank</p> |



| | | |
|------|--|---|
| BT | 2.4GHz 2400~2483.5MHz Band Edge @ 3m | |
| ANT | BT CH78 2480MHz | |
| 1 | Horizontal | Fundamental |
| Peak | <p>Site : 03CH12-1FY Condition : PEAK_BE_74 3m HORN_91200_1328 HORIZONTAL Detector : Peak Project : 832126-02 Mode : 3</p> | <p>Site : 03CH12-1FY Condition : PEAK_74 3m HORN_91200_1328 HORIZONTAL Detector : Peak Project : 832126-02 Mode : 3</p> |

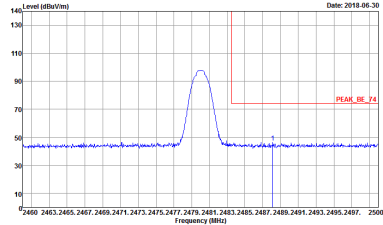
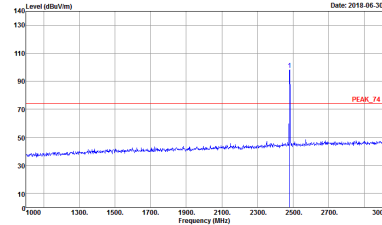

| | | |
|-------------|---|---|
| BT | 2.4GHz 2400~2483.5MHz Band Edge @ 3m | |
| ANT | BT CH78 2480MHz | |
| 1 | Vertical | Fundamental |
| Peak |  <p>Site : 03CH2-11Y Condition : PEAK_BE_74 3m HORN_91200_1328 VERTICAL RBW:3000.000KHz VBW:3000.000KHz SWT:Auto Detector : Peak Project : 832126-02 Mode : 3</p> |  <p>Site : 03CH2-11Y Condition : PEAK_74 3m HORN_91200_1328 VERTICAL RBW:3000.000KHz VBW:3000.000KHz SWT:Auto Detector : Peak Project : 832126-02 Mode : 3</p> |

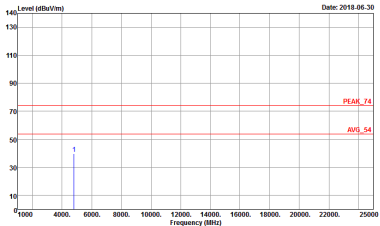
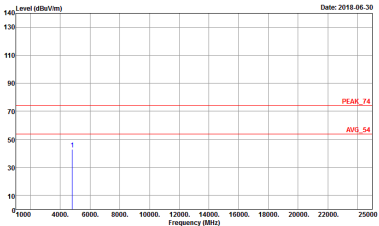

2.4GHz 2400~2483.5MHz
BT (Harmonic @ 3m)

| | | |
|----------------------|---|--|
| BT | 2.4GHz 2400~2483.5MHz Harmonic @ 3m | |
| ANT | BT CH00 2402MHz | |
| 1 | Horizontal | Vertical |
| <p>Peak Avg.</p> |  <p>Site : 03CH12-44Y Condition : PEAK_74 3m HORN_91200_1328 HORIZONTAL Detector : Peak Project : 832126-02 Mode : 1</p> |  <p>Site : 03CH12-44Y Condition : PEAK_74 3m HORN_91200_1328 VERTICAL Detector : Peak Project : 832126-02 Mode : 1</p> |



| | | |
|----------------------------|--|--|
| BT | 2.4GHz 2400~2483.5MHz Harmonic @ 3m | |
| ANT | BT CH39 2441MHz | |
| 1 | Horizontal | Vertical |
| Peak Avg. | <p>Site : 03CH2-11Y Condition : PEAK_74 3m HORN_91200_1328 HORIZONTAL Detector : Peak Project : 832126-02 Mode : 2</p> | <p>Site : 03CH2-11Y Condition : PEAK_74 3m HORN_91200_1328 VERTICAL Detector : Peak Project : 832126-02 Mode : 2</p> |

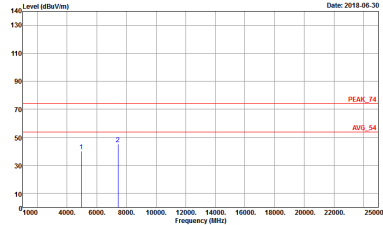
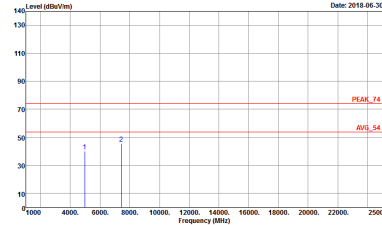

| | | |
|------------------------------------|--|---|
| BT | 2.4GHz 2400~2483.5MHz Harmonic @ 3m | |
| ANT | BT CH78 2480MHz | |
| 1 | Horizontal | Vertical |
| <p>Peak Avg.</p> |  <p>Site : 03CH12-11Y Condition : PEAK_74 3m HORN_91200_1328 HORIZONTAL Detector : Peak Project : 832126-02 Mode : -3</p> |  <p>Site : 03CH12-11Y Condition : PEAK_74 3m HORN_91200_1328 VERTICAL Detector : Peak Project : 832126-02 Mode : -3</p> |



Emission below 1GHz
2.4GHz BT (LF)

Table with 2 columns: BT (2.4GHz 2400~2483.5MHz), ANT (BT LF). Row 1: 1, Horizontal, Vertical. Each plot shows Level (dBuV/m) vs Frequency (MHz) with a red QP line and blue spectrum. Includes site/condition metadata for both plots.



Appendix E. Duty Cycle Plots

2DH5 on time (One Pulse) Plot on Channel 39

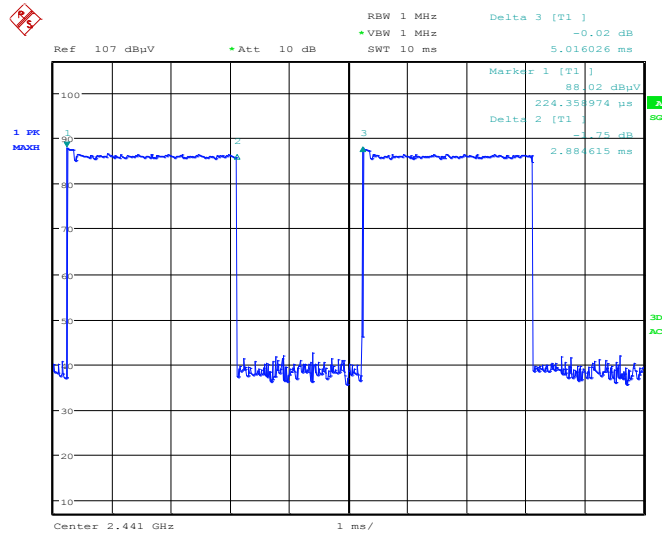

Date: 30.JUN.2018 10:36:12

on time (Count Pulses) Plot on Channel 39

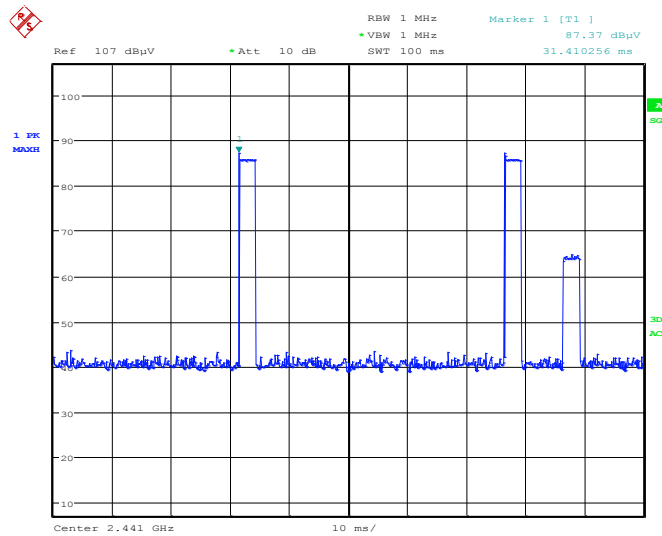

Date: 30.JUN.2018 10:42:00

Note:

1. Worst case Duty cycle = on time/100 milliseconds = $2 * 2.88 / 100 = 5.76 \%$
2. Worst case Duty cycle correction factor = $20 * \log(\text{Duty cycle}) = -24.78 \text{ dB}$
3. **2DH5** has the highest duty cycle worst case and is reported.



Duty Cycle Correction Factor Consideration for AFH mode:

Bluetooth normal hopping rate is 1600Hz and reduced to 800Hz in AFH mode; due to the reduced number of hopping frequencies, with the same packet configuration the dwell time in each channel frequency within 100msec period is longer in AFH mode than normal mode.

In AFH mode, the minimum hopping frequencies are 20, to get the longest dwell time DH5 packet is observed; the period to have DH5 packet completing one hopping sequence is

$$2.88 \text{ ms} \times 20 \text{ channels} = 57.6 \text{ ms}$$

There cannot be 2 complete hopping sequences within 100ms period, considering the random hopping behavior, maximum 2 hops can be possibly observed within the period. $[100\text{ms} / 57.6\text{ms}] = 2$ hops

Thus, the maximum possible ON time:

$$2.88 \text{ ms} \times 2 = 5.76 \text{ ms}$$

Worst case Duty Cycle Correction factor, which is derived from the maximum possible ON time,

$$20 \times \log(5.76 \text{ ms}/100\text{ms}) = -24.78 \text{ dB}$$