

TEST REPORT

Report No.: BCTC2408197638-1E

Applicant: Ugreen Group Limited

Product Name: Magnetic Wireless Power Bank

Test Model: PB764

Tested Date: 2024-08-14 to 2024-08-21

Issued Date: 2024-08-21

Shenzhen BCTC Testing Co., Ltd.



FCC ID:2AQI5-PB764

Product Name: Magnetic Wireless Power Bank

Trademark: **UGREEN**

Model/Type Reference: PB764

Prepared For: Ugreen Group Limited

Address: Ugreen Building, Longcheng Industrial Park, Longguanxi Road, Longhua, ShenZhen, China

Manufacturer: Ugreen Group Limited

Address: Ugreen Building, Longcheng Industrial Park, Longguanxi Road, Longhua, ShenZhen, China

Prepared By: Shenzhen BCTC Testing Co., Ltd.

Address: 1-2/F., Building B, Pengzhou Industrial Park, No.158, Fuyuan 1st Road, Zhancheng, Fuhai Subdistrict, Bao'an District, Shenzhen, Guangdong, China

Sample Received Date: 2024-08-14

Sample Tested Date: 2024-08-14 to 2024-08-21

Issue Date: 2024-08-21

Report No.: BCTC2408197638-1E

Test Standards: FCC Part15.209
ANSI C63.10-2013

Test Results: PASS

Tested by:

Kelsey Tan/ Project Handler

Approved by:

Zero Zhou/Reviewer

The test report is effective only with both signature and specialized stamp. This result(s) shown in this report refer only to the sample(s) tested. Without written approval of Shenzhen BCTC Testing Co., Ltd, this report can't be reproduced except in full. The tested sample(s) and the sample information are provided by the client.

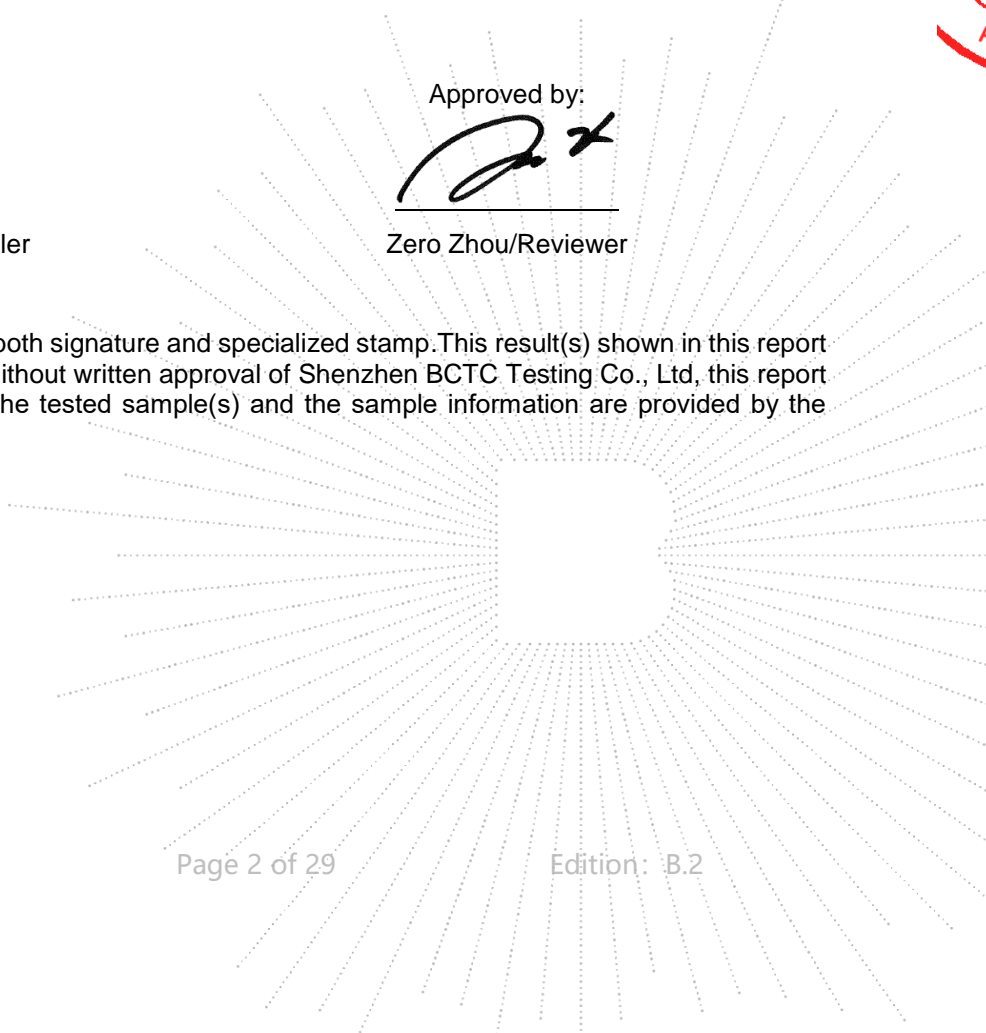

Table Of Content

	Page
Test Report Declaration	
1. Version	4
2. Test Summary	5
3. Measurement Uncertainty	6
4. Product Information And Test Setup	7
4.1 Product Information.....	7
4.2 Support Equipment	7
4.3 Test Setup Configuration	8
4.4 Test Mode	9
5. Test Facility And Test Instrument Used.....	10
5.1 Test Facility.....	10
5.2 Test Instrument Used.....	10
6. Conducted Emissions.....	12
6.1 Block Diagram Of Test Setup.....	12
6.2 Limit	12
6.3 Test procedure.....	12
6.4 EUT operating Conditions	12
6.5 Test Result.....	13
7. Radiated Emissions.....	15
7.1 Block Diagram Of Test Setup.....	15
7.2 Limit	16
7.3 Test procedure.....	16
7.4 Test Result.....	17
8. Bandwidth Test.....	23
8.1 Test Procedure	23
8.2 Test Setup.....	23
8.3 Test Result.....	24
9. Antenna Requirements.....	25
9.1 Limit	25
9.2 Test Result.....	25
10. EUT Photographs.....	26
11. EUT Test Setup Photographs.....	27

(Note: N/A Means Not Applicable)

BCTC
 BCTC
 PPR
 Report

1. Version

Report No.	Issue Date	Description	Approved
BCTC2408197638-1E	2024-08-21	Original	Valid

TEC
TC
OVB
t See

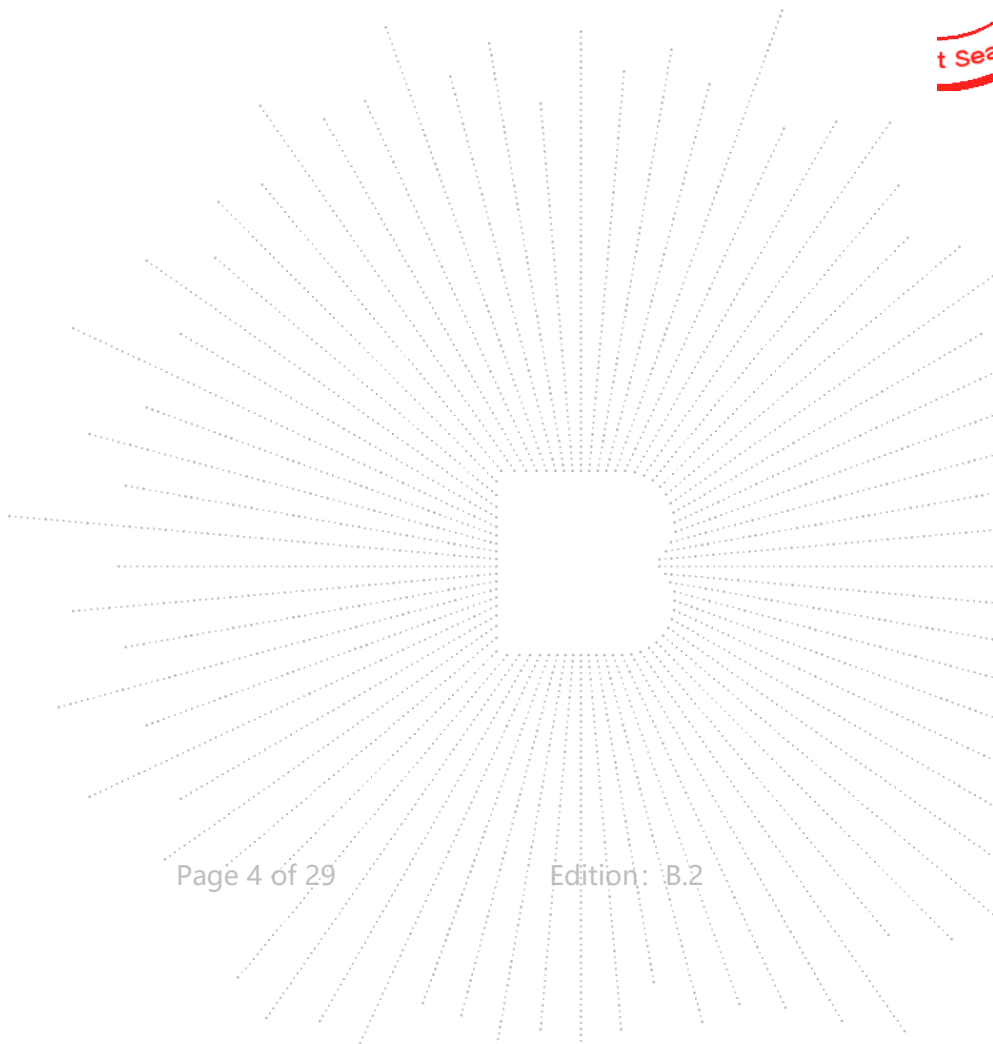

2. Test Summary

The Product has been tested according to the following specifications:

No.	Test Parameter	Clause No.	Results
1	Conducted Emission	15.207	PASS
2	Radiated Emission	15.209	PASS
3	20dB Bandwidth	15.215	PASS
4	Antenna Requirement	15.203	PASS

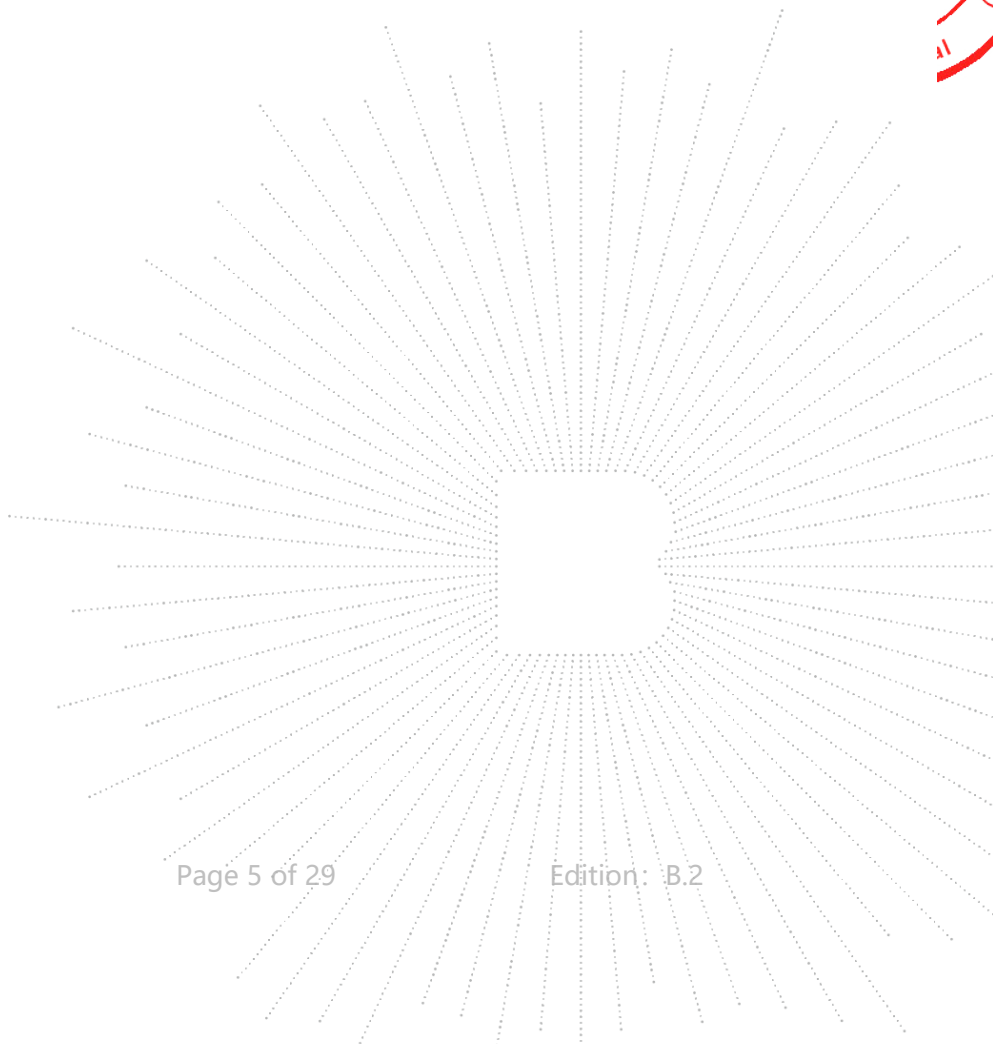

3. Measurement Uncertainty

Where relevant, the following measurement uncertainty levels have been estimated for tests performed on the Product as specified in CISPR 16-4-2. This uncertainty represents an expanded uncertainty expressed at approximately the 95% confidence level using a coverage factor of $k=2$.

No.	Item	Uncertainty
1	3m chamber Radiated spurious emission(30MHz-1GHz)	U=4.3dB
2	Conducted Emission (150kHz-30MHz)	U=3.2dB
3	humidity uncertainty	U=5.3%
4	Temperature uncertainty	U=0.59°C

CO., LTD

4. Product Information And Test Setup

4.1 Product Information

Model/Type Reference: PB764
 P/N code Differences: All the P/N code and test models are the same circuit and RF module, except for the appearance color and sales platform.
 Hardware Version: A1
 Software Version: V1
 Operation Frequency: 5W+7.5W: 112kHz-148.5kHz
 15W: 360kHz
 Modulation: FSK
 Antenna installation: loop coil antenna
 Ratings: USB-C (IN) Input:5V \leq 3A/9V \leq 2.22A
 USB-C(OUT) Output:5V \leq 2.4A/5V \leq 3A/9V \leq 2.22A/12V \leq 1.67A
 Wireless Charging Output Power:15W Max
 Cell Capacity: 10000mAh (2*5000mAh)
 Rated Capacity: 6000mAh (TYP 5V 2.4A)
 Rated Energy: 36Wh (3.6V 10000mAh)

Remark:

- P/N code in the below table, for marketing purpose, will be marked on the marking plate.

45329	45329P	45329X	45329A	45329B	45329C	45329U	45329JP	45329ZD
45337	45337P	45337X	45337A	45337B	45337C	45337U	45337JP	45337ZD

4.2 Support Equipment

No.	Device Type	Brand	Model	Series No.	Note
E-1	Magnetic Wireless Power Bank	UGREEN	PB764	N/A	EUT
E-2	Adapter	UGREEN	CD226	N/A	Auxiliary
E-3	Dummy load	N/A	DL01	N/A	Auxiliary

Notes:

- All the equipment/cables were placed in the worst-case configuration to maximize the emission during the test.
- Grounding was established in accordance with the manufacturer's requirements and conditions for the intended use.

4.3 Test Setup Configuration

See test photographs attached in *EUT TEST SETUP PHOTOGRAPHS* for the actual connections between Product and support equipment.

Conducted Emission:

Test Mode 1, 2

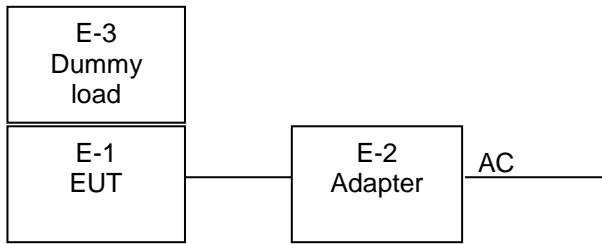

Radiated Spurious Emission:

Test Mode 1, 2

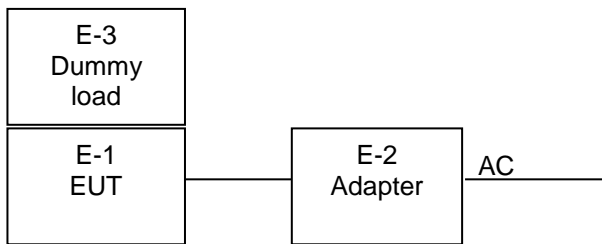

Test Mode 3,4,5

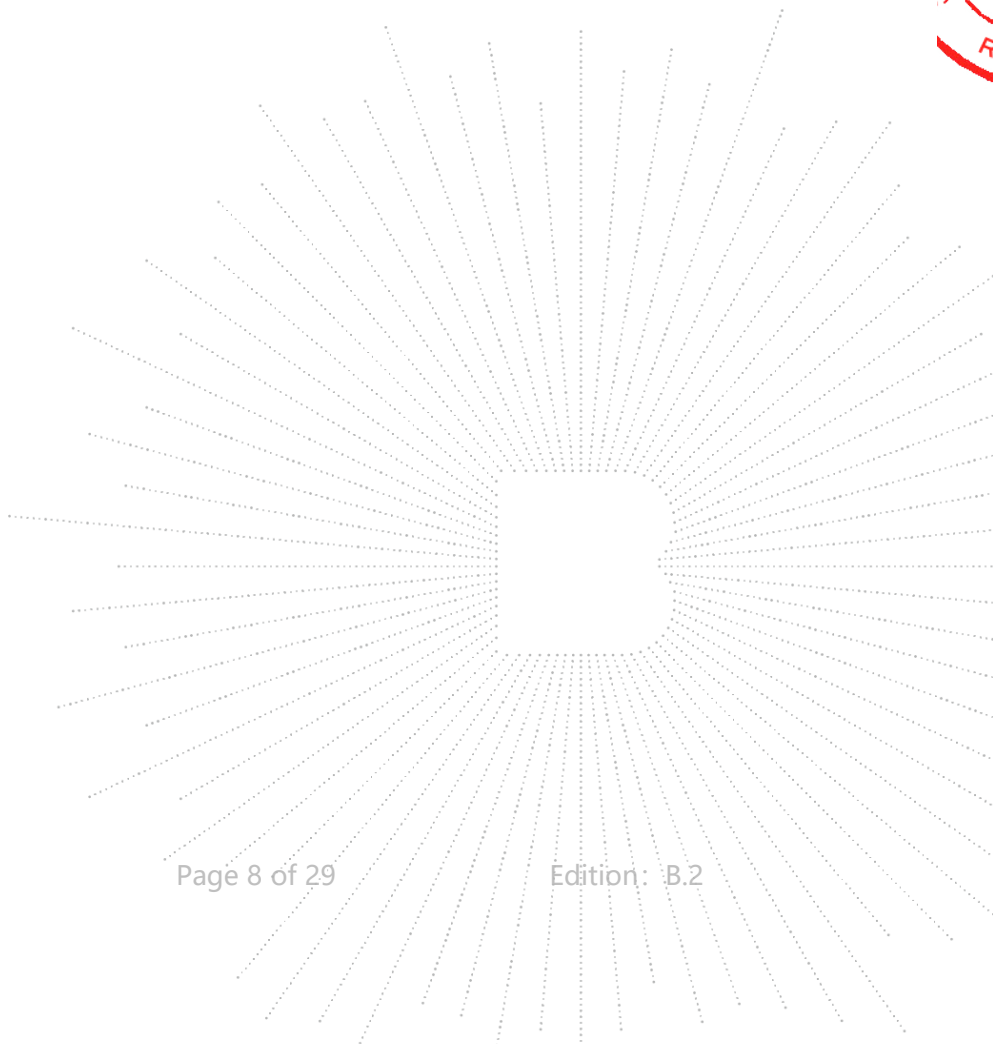
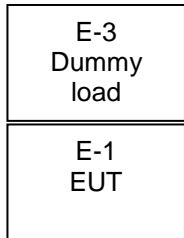

4.4 Test Mode

To investigate the maximum EMI emission characteristics generates from EUT, the test system was pre-scanning tested base on the consideration of following EUT operation mode or test configuration mode which possible have effect on EMI emission level. Each of these EUT operation mode(s) or test configuration mode(s) mentioned above was evaluated respectively.

AC Mode	Mode 1	USB-C IN 1:(5V $\overline{\text{---}}$ 3A)+ Wireless charge 5W
	Mode 2	USB-C IN 1:(9V $\overline{\text{---}}$ 2.22A)+ Wireless charge 7.5W
DC Mode	Mode 3	Wireless charge 5W
	Mode 4	Wireless charge 7.5W
	Mode 5	Wireless charge 15W

Note: All test mode were tested and passed, only shows the worst case mode which were recorded in this report.

BCTC
3C
PPR
Report

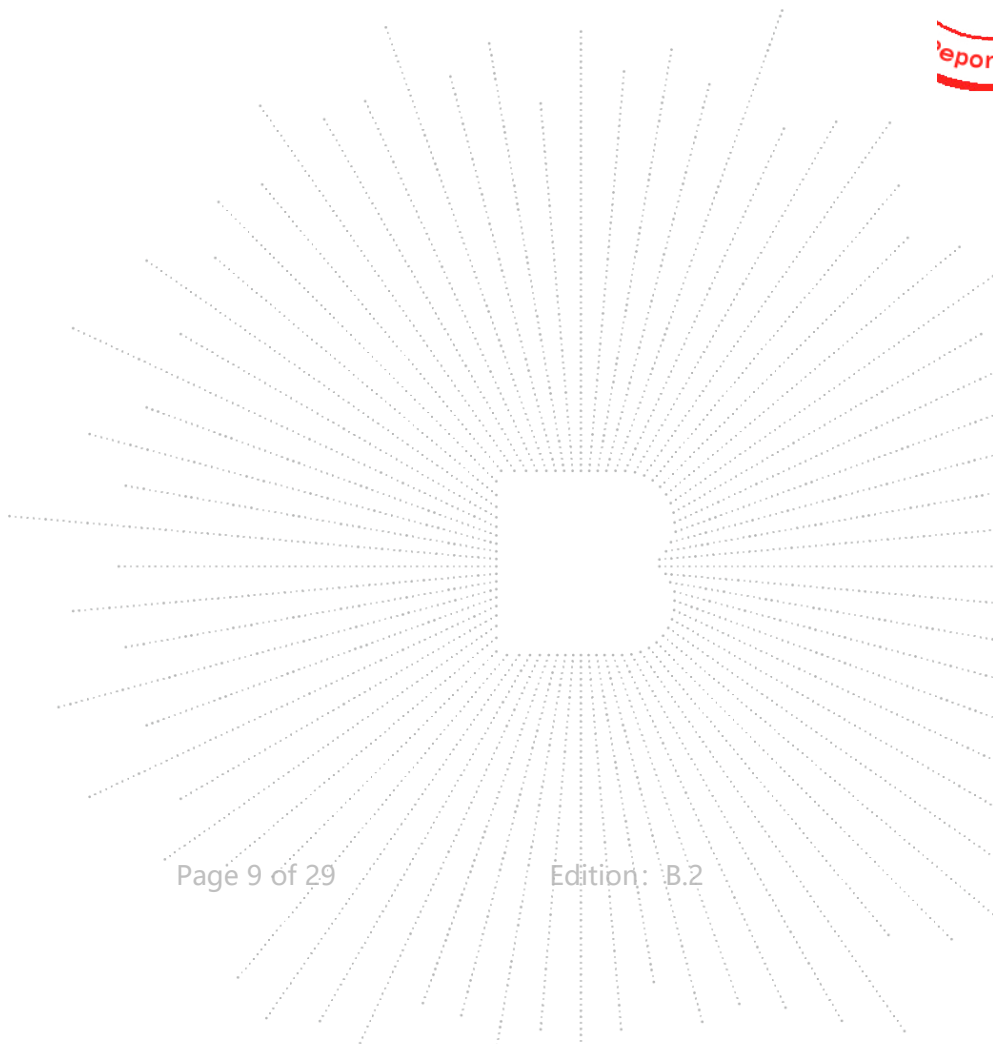

5. Test Facility And Test Instrument Used

5.1 Test Facility

All measurement facilities used to collect the measurement data are located at Shenzhen BCTC Testing Co., Ltd. Address:1-2/F., Building B, Pengzhou Industrial Park, No.158, Fuyuan 1st Road, Zhancheng, Fuhai Subdistrict, Bao'an District, Shenzhen, Guangdong, China. The site and apparatus are constructed in conformance with the requirements of ANSI C63.4 and CISPR 16-1-1 other equivalent standards.

FCC Test Firm Registration Number: 712850

A2LA certificate registration number is: CN1212

ISED Registered No.: 23583

ISED CAB identifier: CN0017

5.2 Test Instrument Used

Conducted Emissions Test					
Equipment	Manufacturer	Model#	Serial#	Last Cal.	Next Cal.
Receiver	R&S	ESR3	102075	May 16, 2024	May 15, 2025
LISN	R&S	ENV216	101375	May 16, 2024	May 15, 2025
Software	Frad	EZ-EMC	EMC-CON 3A1	\	\
Pulse limiter	Schwarzbeck	VTSD9561-F	01323	May 16, 2024	May 15, 2025

RF Conducted Test					
Equipment	Manufacturer	Model#	Serial#	Last Cal.	Next Cal.
Power Meter	Keysight	E4419	\	May 16, 2024	May 15, 2025
Power Sensor (AV)	Keysight	E9300A	\	May 16, 2024	May 15, 2025
Signal Analyzer 20kHz-26.5G Hz	Keysight	N9020A	MY49100060	May 16, 2024	May 15, 2025
Spectrum Analyzer 9kHz-40GHz	R&S	FSP 40	\	May 16, 2024	May 15, 2025

Radiated Emissions Test (966 Chamber01)					
Equipment	Manufacturer	Model#	Serial#	Last Cal.	Next Cal.
966 chamber	ChengYu	966 Room	966	May 16, 2024	May 15, 2025
Receiver	R&S	ESR3	102075	May 16, 2024	May 15, 2025
Receiver	R&S	ESRP	101154	May 16, 2024	May 15, 2025
Amplifier	Schwarzbeck	BBV9744	9744-0037	May 16, 2024	May 15, 2025
TRILOG Broadband Antenna	Schwarzbeck	VULB9163	942	May 21, 2024	May 20, 2025
Loop Antenna(9KHz -30MHz)	Schwarzbeck	FMZB1519B	00014	May 21, 2024	May 20, 2025
Amplifier	SKET	LAPA_01G18 G-45dB	SK2021040901	May 16, 2024	May 15, 2025
Horn Antenna	Schwarzbeck	BBHA9120D	1541	May 21, 2024	May 20, 2025
Amplifier(18G Hz-40GHz)	MITEQ	TTA1840-35- HG	2034381	May 16, 2024	May 15, 2025
Horn Antenna(18G Hz-40GHz)	Schwarzbeck	BBHA9170	00822	May 21, 2024	May 20, 2025
Spectrum Analyzer9kHz- 40GHz	R&S	FSP40	100363	May 16, 2024	May 15, 2025
Software	Frad	EZ-EMC	FA-03A2 RE	\	\

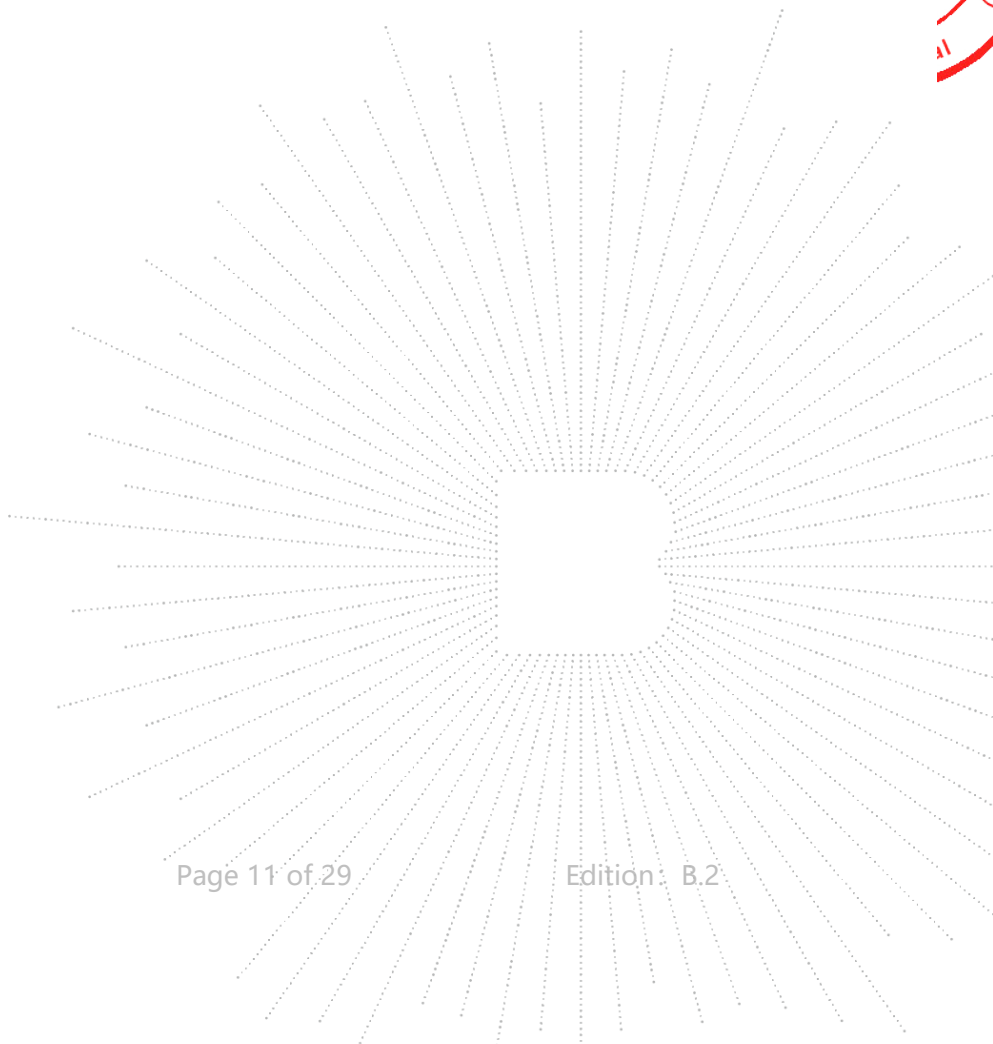

6. Conducted Emissions

6.1 Block Diagram Of Test Setup

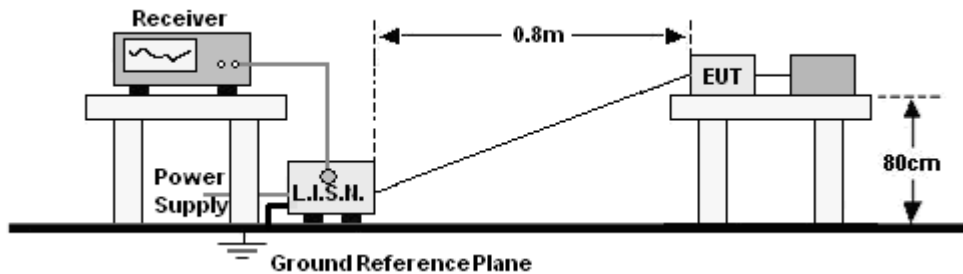

6.2 Limit

Frequency (MHz)	Limit (dBuV)	
	Quas-peak	Average
0.15 -0.5	66 - 56 *	56 - 46 *
0.50 -5.0	56.00	46.00
5.0 -30.0	60.00	50.00

Notes:
 1. *Decreasing linearly with logarithm of frequency.
 2. The lower limit shall apply at the transition frequencies.

6.3 Test procedure

Receiver Parameters	Setting
Attenuation	10 dB
Start Frequency	0.15 MHz
Stop Frequency	30 MHz
IF Bandwidth	9 kHz

- The Product was placed on a nonconductive table 0.8 m above the horizontal ground reference plane, and 0.4 m from the vertical ground reference plane, and connected to the main through Line Impedance Stability Network (L.I.S.N).
- The RBW of the receiver was set at 9 kHz in 150 kHz ~ 30MHz with Peak and AVG detector in Max Hold mode. Run the receiver's pre-scan to record the maximum disturbance generated from Product in all power lines in the full band.
- For each frequency whose maximum record was higher or close to limit, measure its QP and AVG values and record.

6.4 EUT operating Conditions

The EUT was configured for testing in a typical fashion (as a customer would normally use it). The EUT has been programmed to continuously transmit during test. This operating condition was tested and used to collect the included data.

6.5 Test Result

Temperature:	26 °C	Relative Humidity:	54%RH
Pressure:	101KPa	Phase :	L
Test Mode:	Mode 2(Worst)	Test Voltage:	AC 120V/60Hz

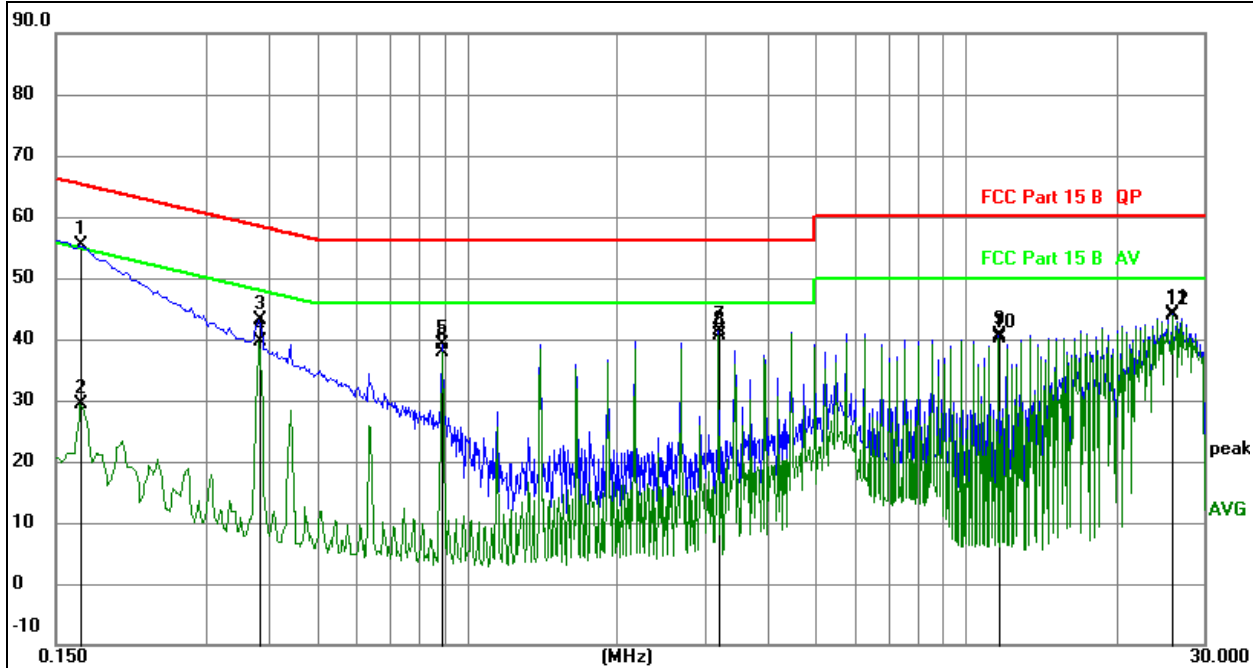

Remark:

1. All readings are Quasi-Peak and Average values.
2. Factor = Insertion Loss + Cable Loss.
3. Measurement = Reading Level + Correct Factor
4. Over = Measurement - Limit

No.	Mk.	Freq. MHz	Reading Level	Correct Factor dB	Measure- ment dBuV	Limit dBuV	Over dB	Detector
1		0.1680	35.25	20.07	55.32	65.06	-9.74	QP
2		0.1680	9.40	20.07	29.47	55.06	-25.59	AVG
3		0.3840	23.08	20.08	43.16	58.19	-15.03	QP
4		0.3840	19.53	20.08	39.61	48.19	-8.58	AVG
5		0.8924	18.94	20.09	39.03	56.00	-16.97	QP
6		0.8924	17.87	20.09	37.96	46.00	-8.04	AVG
7		3.1965	21.27	20.12	41.39	56.00	-14.61	QP
8	*	3.1965	20.49	20.12	40.61	46.00	-5.39	AVG
9		11.6340	20.39	20.22	40.61	60.00	-19.39	QP
10		11.6340	19.96	20.22	40.18	50.00	-9.82	AVG
11		25.9530	23.95	20.29	44.24	60.00	-15.76	QP
12		25.9530	23.61	20.29	43.90	50.00	-6.10	AVG

SHENZHEN

Temperature:	26 °C	Relative Humidity:	54%RH
Pressure:	101KPa	Phase :	N
Test Mode:	Mode 2(Worst)	Test Voltage:	AC 120V/60Hz

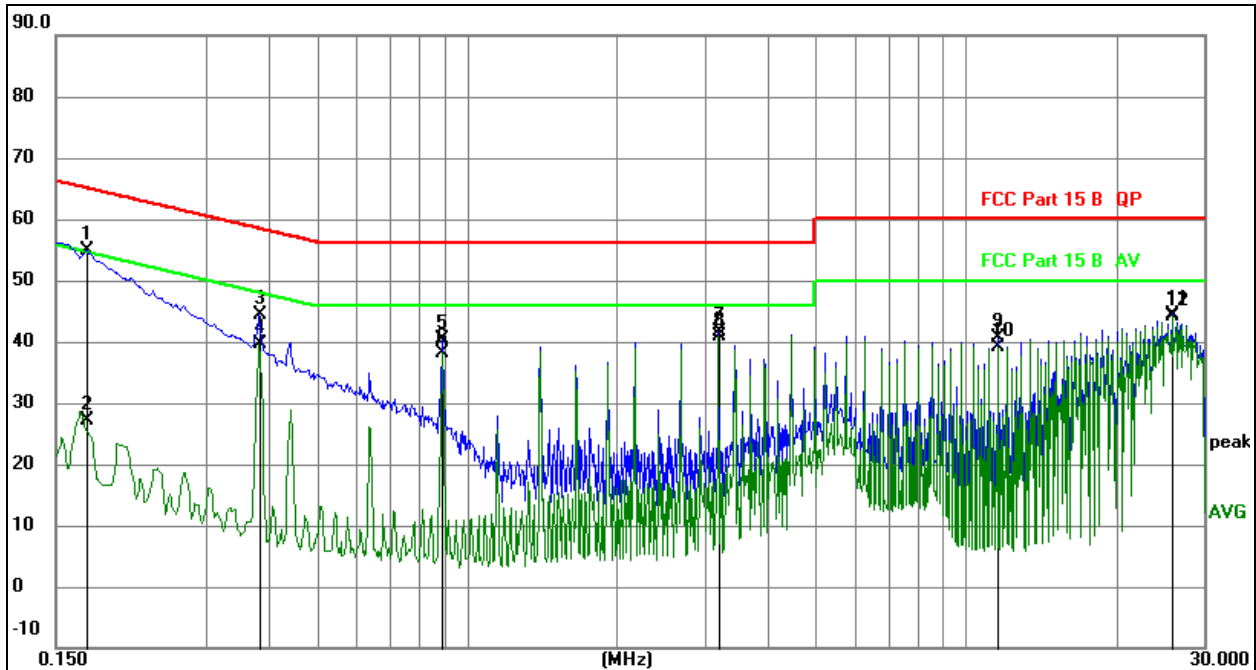
Remark:

1. All readings are Quasi-Peak and Average values.
2. Factor = Insertion Loss + Cable Loss.
3. Measurement = Reading Level + Correct Factor
4. Over = Measurement - Limit

No.	Mk.	Freq. MHz	Reading Level	Correct Factor dB	Measure- ment dBuV	Limit dBuV	Over dB	Detector
1		0.1722	34.85	20.07	54.92	64.85	-9.93	QP
2		0.1722	6.98	20.07	27.05	54.85	-27.80	AVG
3		0.3832	24.30	20.08	44.38	58.21	-13.83	QP
4		0.3832	19.54	20.08	39.62	48.21	-8.59	AVG
5		0.8897	20.22	20.09	40.31	56.00	-15.69	QP
6		0.8897	17.92	20.09	38.01	46.00	-7.99	AVG
7		3.1900	21.56	20.12	41.68	56.00	-14.32	QP
8	*	3.1900	20.69	20.12	40.81	46.00	-5.19	AVG
9		11.6208	20.33	20.22	40.55	60.00	-19.45	QP
10		11.6208	18.80	20.22	39.02	50.00	-10.98	AVG
11		25.8638	24.21	20.29	44.50	60.00	-15.50	QP
12		25.8638	23.91	20.29	44.20	50.00	-5.80	AVG

7. Radiated Emissions

7.1 Block Diagram Of Test Setup

(A) Radiated Emission Test-Up Frequency Below 30MHz

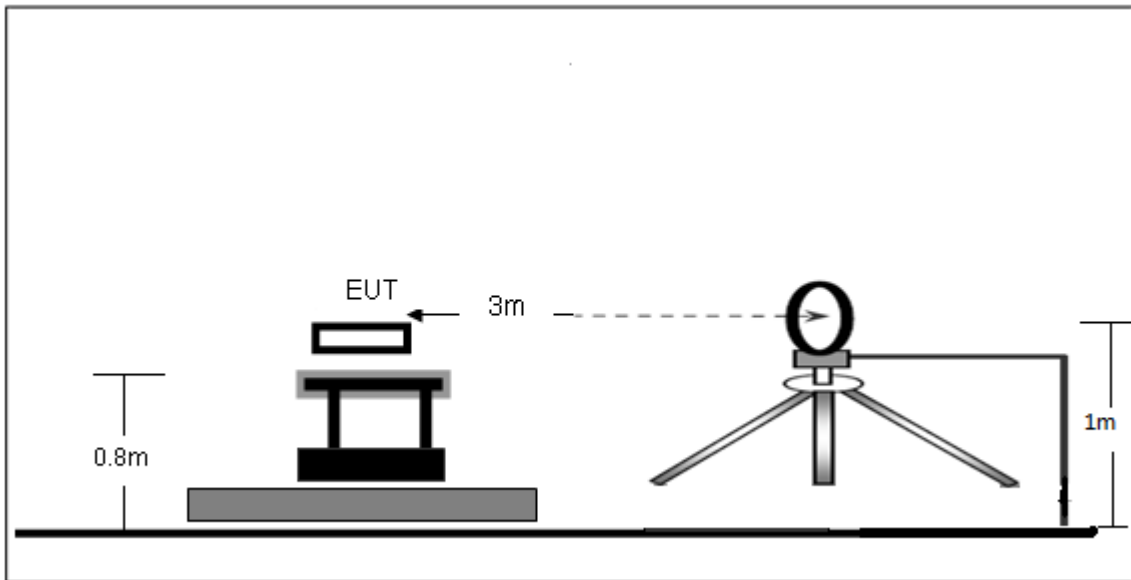

(B) Radiated Emission Test-Up Frequency 30MHz~1GHz

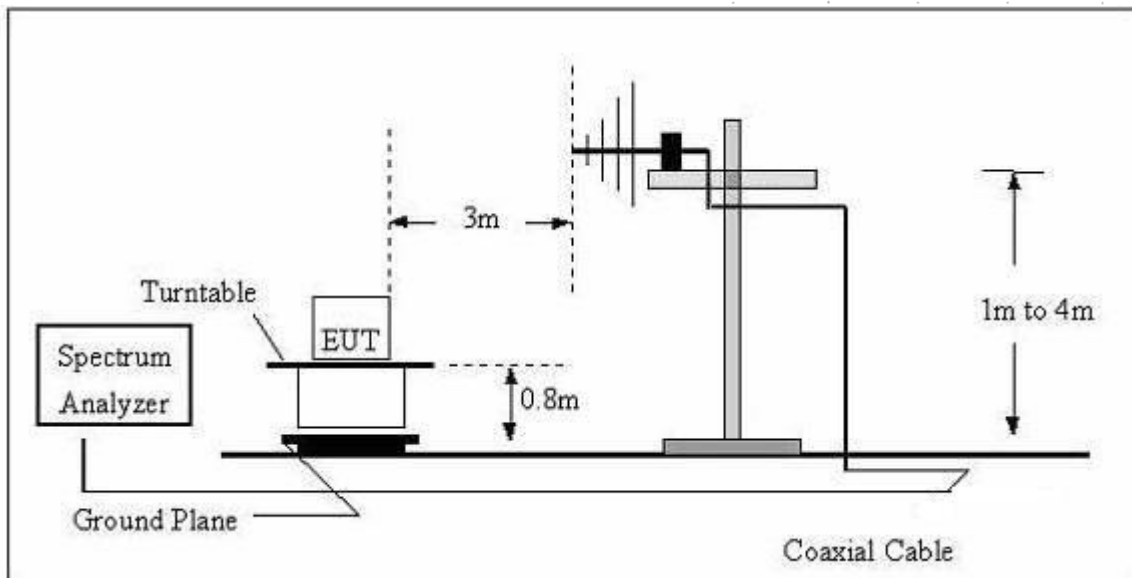

7.2 Limit

FCC §15.209; §15.205.

Test Standard	FCC Part15 C Section 15.209 and 15.205				
Test Limit	Frequency (MHz)	Field strength (microvolt/meter)	Limit (dBuV/m)	Remark	Measurement distance (m)
	0.009MHz~0.490MHz	2400/F(kHz)	-	-	300
	0.490MHz-1.705MHz	24000/F(kHz)	-	-	30
	1.705MHz-30MHz	30	-	-	30
	30MHz~88MHz	100	40.0	Quasi-peak	3
	88MHz~216MHz	150	43.5	Quasi-peak	3
	216MHz~960MHz	200	46.0	Quasi-peak	3
	960MHz~1000MHz	500	54.0	Quasi-peak	3
	Above 1000MHz	500	54.0	Average	3
-		74.0	Peak	3	

7.3 Test procedure

Receiver Parameter	Setting
Attenuation	Auto
9kHz~150kHz	RBW 200Hz for QP
150kHz~30MHz	RBW 9kHz for QP
30MHz~1000MHz	RBW 120kHz for QP

Below 1GHz test procedure as below:

- The EUT was placed on the top of a rotating table 0.8 meters above the ground at a 3 meter semi-anechoic chamber. The table was rotated 360 degrees to determine the position of the highest radiation.
- The EUT was set 3 meters away from the interference-receiving antenna, which was mounted on the top of a variable-height antenna tower.
- The antenna height is varied from one meter to four meters above the ground to determine the maximum value of the field strength. Both horizontal and vertical polarizations of the antenna are set to make the measurement.
- For each suspected emission, the EUT was arranged to its worst case and then the antenna was tuned to heights from 1 meter to 4 meters (for the test frequency of below 30MHz, the antenna was tuned to heights 1 meter) and the rotatable table was turned from 0 degrees to 360 degrees to find the maximum reading.
- The test-receiver system was set to Peak Detect Function and Specified Bandwidth with Maximum Hold Mode.
- If the emission level of the EUT in peak mode was 10dB lower than the limit specified, then testing could be stopped and the peak values of the EUT would be reported. Otherwise the emissions that did not have 10dB margin would be re-tested one by one using peak, quasi-peak or average method as specified and then reported in a data sheet.

Above 1GHz test procedure as below:

- Different between above is the test site, change from Semi- Anechoic Chamber to fully Anechoic Chamber and change form table 0.8 metre to 1.5 metre(Above 18GHz the distance is 1 meter and table is 1.5 metre).
- Test the EUT in the lowest channel ,the middle channel ,the Highest channel.

Note: Both horizontal and vertical antenna polarities were tested and performed pretest to three orthogonal axis. The worst case emissions were reported.

7.4 Test Result

9kHz-30MHz

Temperature:	26°C	Relative Humidity:	54%RH
Pressure:	101 kPa	Test Voltage:	AC120V/60Hz
Test Mode:	Mode 1 (112kHz-148.5kHz)	Polarization:	Coaxial(Worst)

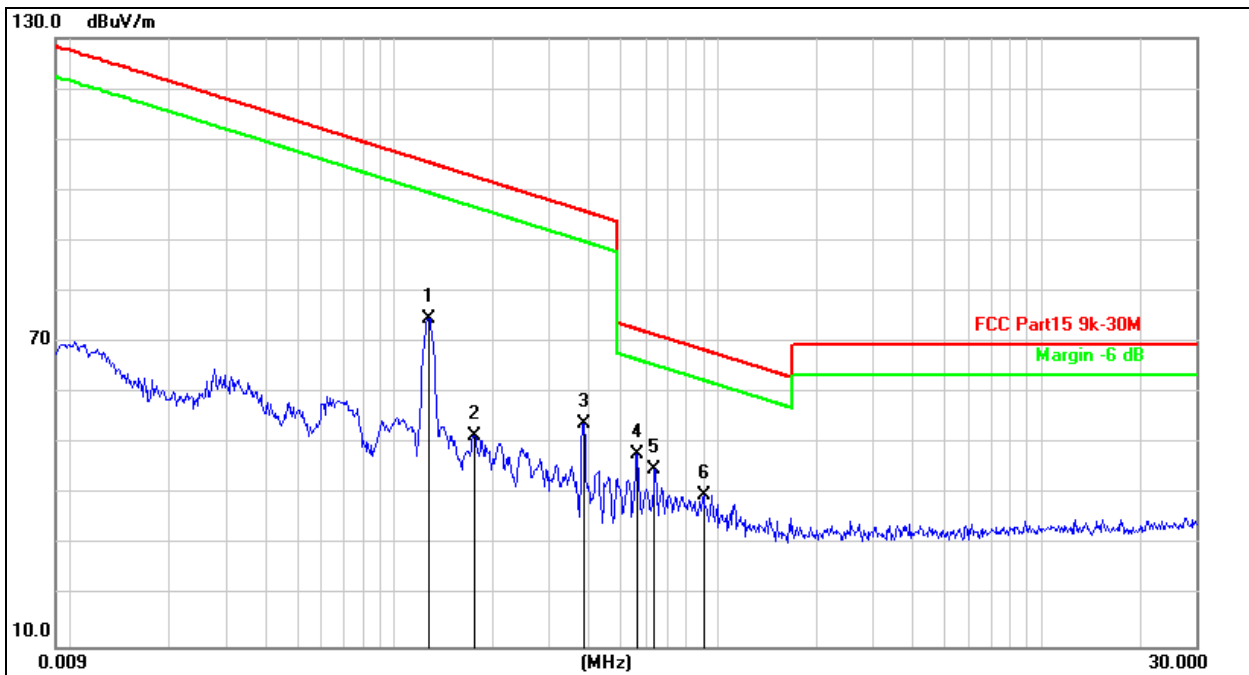

No.	Mk.	Freq. MHz	Reading Level dBuV	Correct Factor dB	Measure- ment dBuV/m	Limit dB/m	Over dB	Detector
1		0.1276	82.29	-7.54	74.75	105.4	-30.74	peak
2		0.1767	59.36	-7.69	51.67	102.6	-50.99	peak
3		0.3849	61.54	-7.65	53.89	95.90	-42.01	peak
4	*	0.5635	55.55	-7.50	48.05	72.59	-24.54	peak
5		0.6363	52.45	-7.43	45.02	71.54	-26.52	peak
6		0.9021	47.26	-7.36	39.90	68.51	-28.61	peak

Temperature:	26°C	Relative Humidity:	54%RH
Pressure:	101 kPa	Test Voltage:	AC120V/60Hz
Test Mode:	Mode 1 (112kHz-148.5kHz)	Polarization:	Coplanar(Worst)

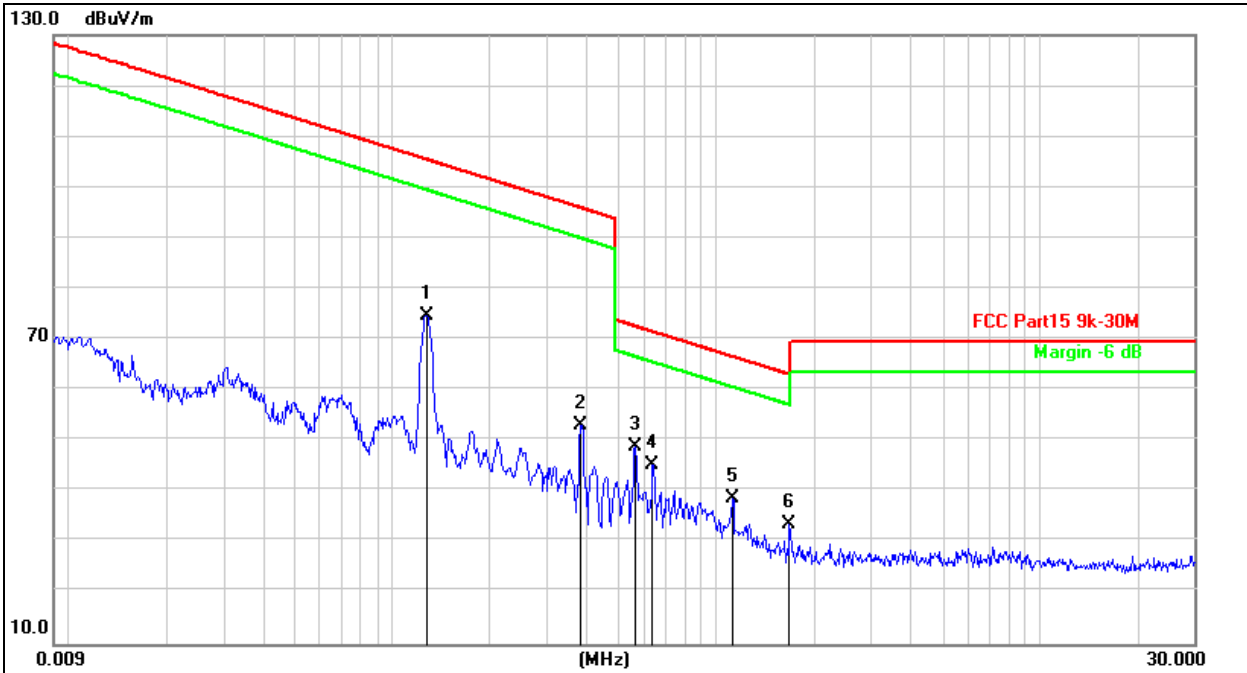

No.	Mk.	Freq. MHz	Reading Level dBuV	Correct Factor dB	Measure- ment dBuV/m	Limit dB/m	Over dB	Detector
1		0.1276	82.20	-7.54	74.66	105.4	-30.83	peak
2		0.3818	60.82	-7.65	53.17	95.97	-42.80	peak
3	*	0.5635	56.27	-7.50	48.77	72.59	-23.82	peak
4		0.6363	52.82	-7.43	45.39	71.54	-26.15	peak
5		1.1229	46.12	-7.36	38.76	66.62	-27.86	peak
6		1.6846	40.94	-7.33	33.61	63.10	-29.49	peak

9kHz-30MHz

Temperature:	26°C	Relative Humidity:	54%RH
Pressure:	101 kPa	Test Voltage:	DC 3.6V
Test Mode:	Mode 5(360kHz)	Polarization:	Coaxial(Worst)

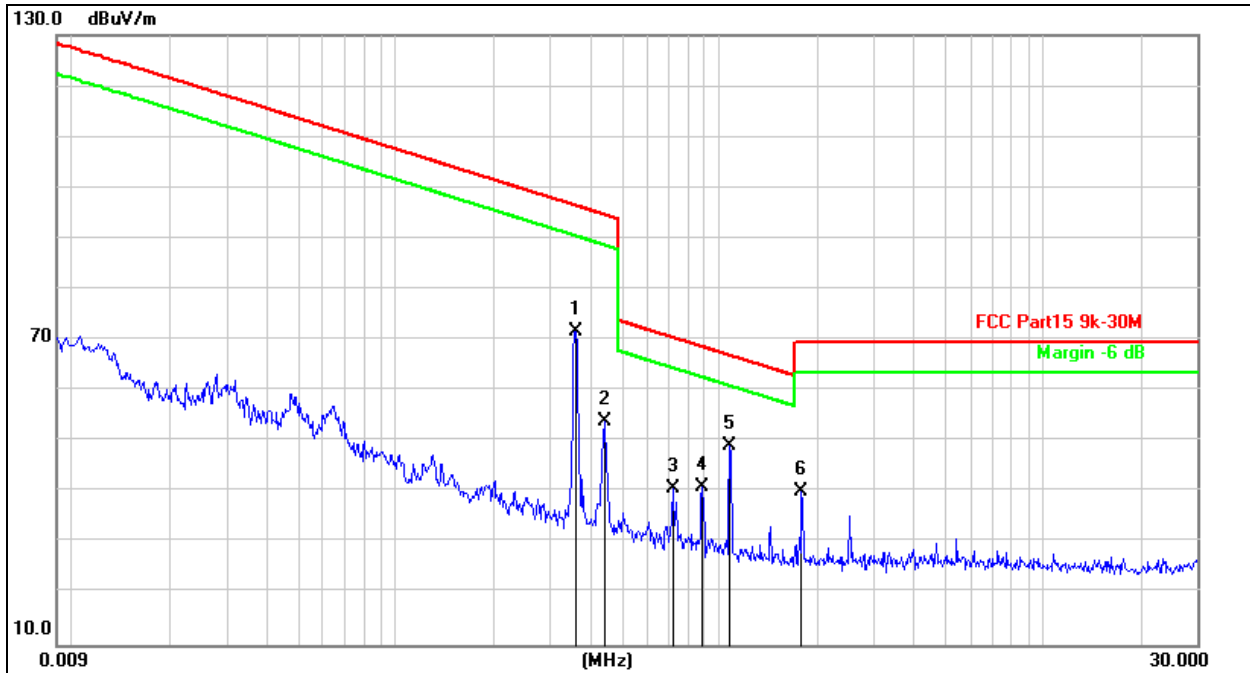

No.	Mk.	Freq. MHz	Reading Level dBuV	Correct Factor dB	Measure- ment dBuV/m	Limit dB/m	Over dB	Detector
1		0.3607	79.45	-7.67	71.78	96.46	-24.68	peak
2		0.4418	61.60	-7.61	53.99	94.70	-40.71	peak
3		0.7186	47.99	-7.36	40.63	70.48	-29.85	peak
4		0.8874	48.37	-7.36	41.01	68.66	-27.65	peak
5	*	1.0783	56.42	-7.36	49.06	66.97	-17.91	peak
6		1.7976	47.42	-7.33	40.09	69.54	-29.45	peak

SHENZHEN

9kHz-30MHz

Temperature:	26°C	Relative Humidity:	54%RH
Pressure:	101 kPa	Test Voltage:	DC 3.6V
Test Mode:	Mode 5(360kHz)	Polarization:	Coplanar(Worst)

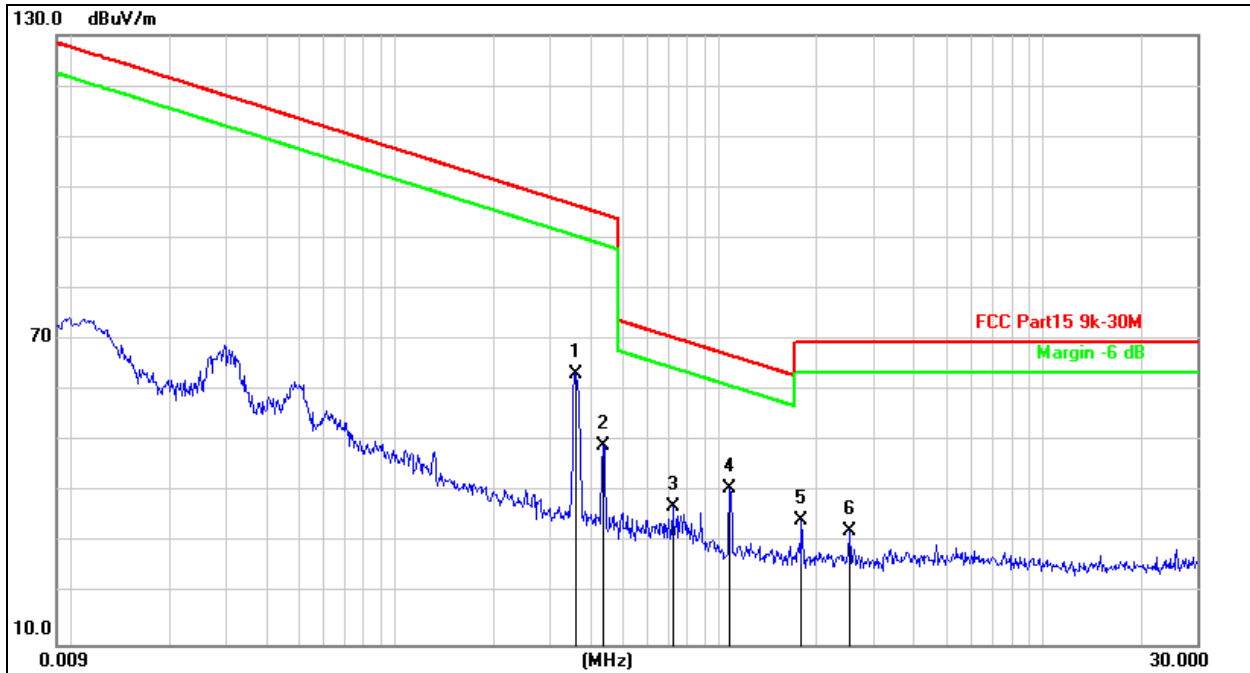

No.	Mk.	Freq. MHz	Reading Level dBuV	Correct Factor dB	Measure- ment dBuV/m	Limit dB/m	Over dB	Detector
1		0.3607	71.07	-7.67	63.40	96.46	-33.06	peak
2		0.4382	56.84	-7.61	49.23	94.77	-45.54	peak
3		0.7188	44.37	-7.36	37.01	70.48	-33.47	peak
4	*	1.0783	48.03	-7.36	40.67	66.97	-26.30	peak
5		1.7976	41.66	-7.33	34.33	69.54	-35.21	peak
6		2.5272	39.54	-7.30	32.24	69.54	-37.30	peak

Between 30MHz – 1GHz

Temperature:	26 °C	Relative Humidity:	54%RH
Pressure:	101KPa	Phase :	Horizontal
Test Mode:	Mode 3(Worst)	Test Voltage:	DC 3.6V

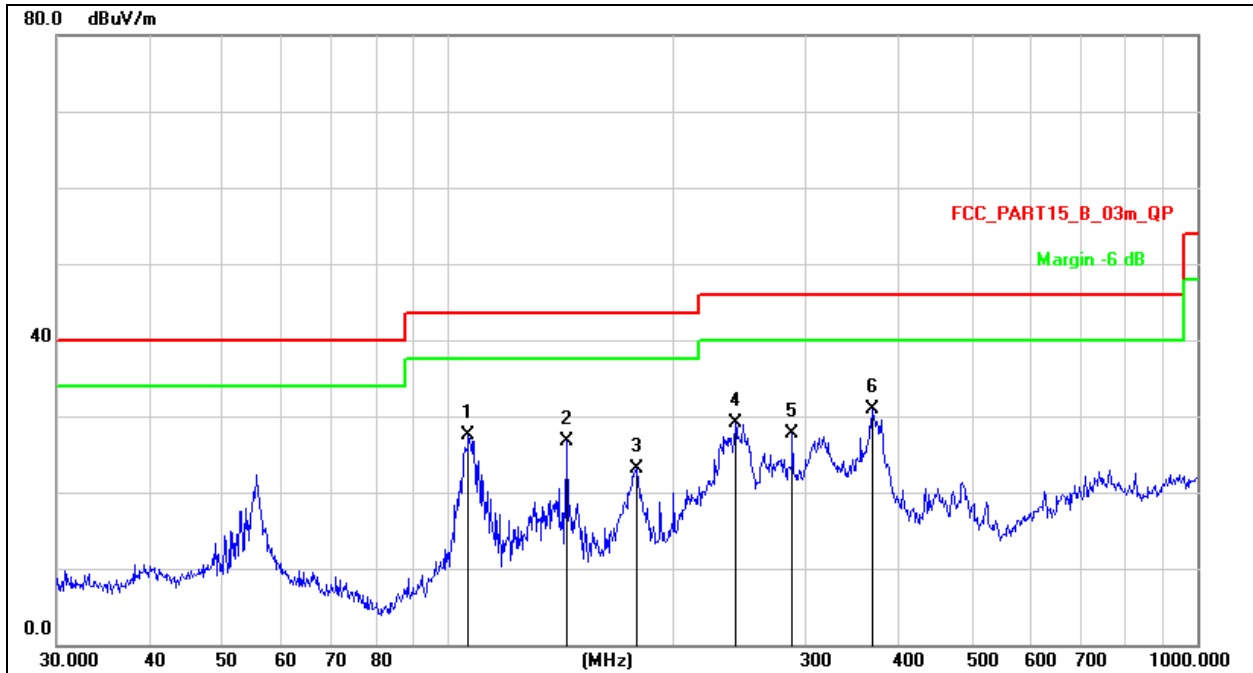

Remark:
 1. Factor = Antenna Factor + Cable Loss – Pre-amplifier.
 2. Measurement = Reading Level + Correct Factor
 3. Over = Measurement - Limit

No.	Mk.	Freq. MHz	Reading Level dBuV	Correct Factor dB	Measure- ment dBuV/m	Limit dB/m	Over dB	Detector
1		106.3850	43.80	-16.38	27.42	43.50	-16.08	QP
2		143.8295	45.74	-19.00	26.74	43.50	-16.76	QP
3		178.1327	40.37	-17.34	23.03	43.50	-20.47	QP
4		241.6763	43.58	-14.53	29.05	46.00	-16.95	QP
5		287.9904	41.13	-13.49	27.64	46.00	-18.36	QP
6	*	368.1116	42.09	-11.25	30.84	46.00	-15.16	QP

Temperature:	26 °C	Relative Humidity:	54%RH
Pressure:	101KPa	Phase :	Vertical
Test Mode:	Mode 3(Worst)	Test Voltage:	DC 3.6V

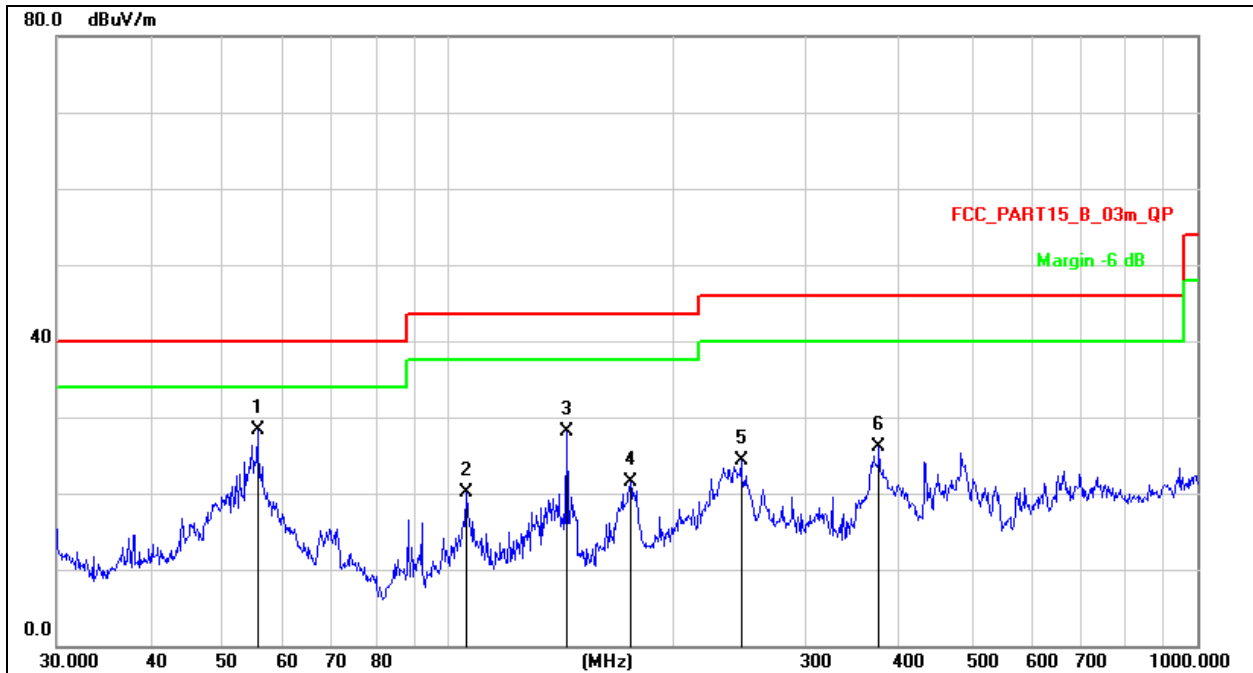
Remark:

1. Factor = Antenna Factor + Cable Loss – Pre-amplifier.
2. Measurement = Reading Level + Correct Factor
3. Over = Measurement - Limit

No.	Mk.	Freq. MHz	Reading Level dBuV	Correct Factor dB	Measure- ment dBuV/m	Limit dB/m	Over dB	Detector
1	*	55.6094	42.99	-14.66	28.33	40.00	-11.67	QP
2		105.6415	36.37	-16.32	20.05	43.50	-23.45	QP
3		143.8295	47.12	-19.00	28.12	43.50	-15.38	QP
4		175.0368	39.12	-17.57	21.55	43.50	-21.95	QP
5		245.9509	38.64	-14.41	24.23	46.00	-21.77	QP
6		375.9385	37.25	-11.15	26.10	46.00	-19.90	QP

8. Bandwidth Test

8.1 Test Procedure

1. Set RBW = 1%~5% OBW.
2. Set the video bandwidth (VBW) $\geq 3 \times$ RBW.
3. Detector = Peak.
4. Trace mode = max hold.
5. Sweep = auto couple.
6. Allow the trace to stabilize.
7. Measure the maximum width of the emission that is constrained by the frequencies associated with the two outermost amplitude points (upper and lower frequencies) that are attenuated by 20 dB relative to the maximum level measured in the fundamental emission.

8.2 Test Setup



8.3 Test Result

Frequency (kHz)	20dB bandwidth (kHz)	Result
127.8	0.002	Pass

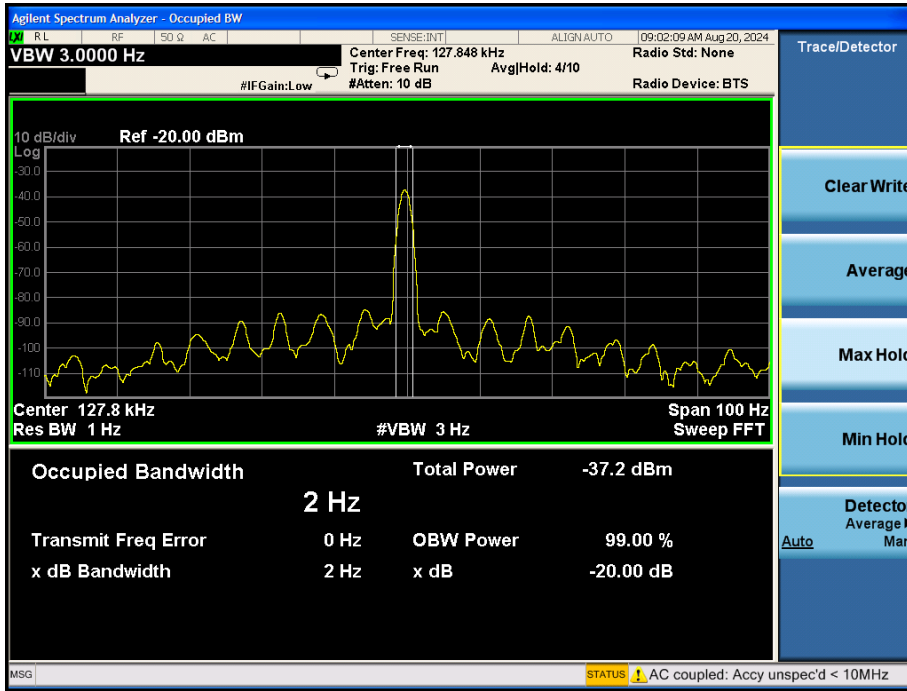

Frequency (kHz)	20dB bandwidth (kHz)	Result
360	0.006	Pass

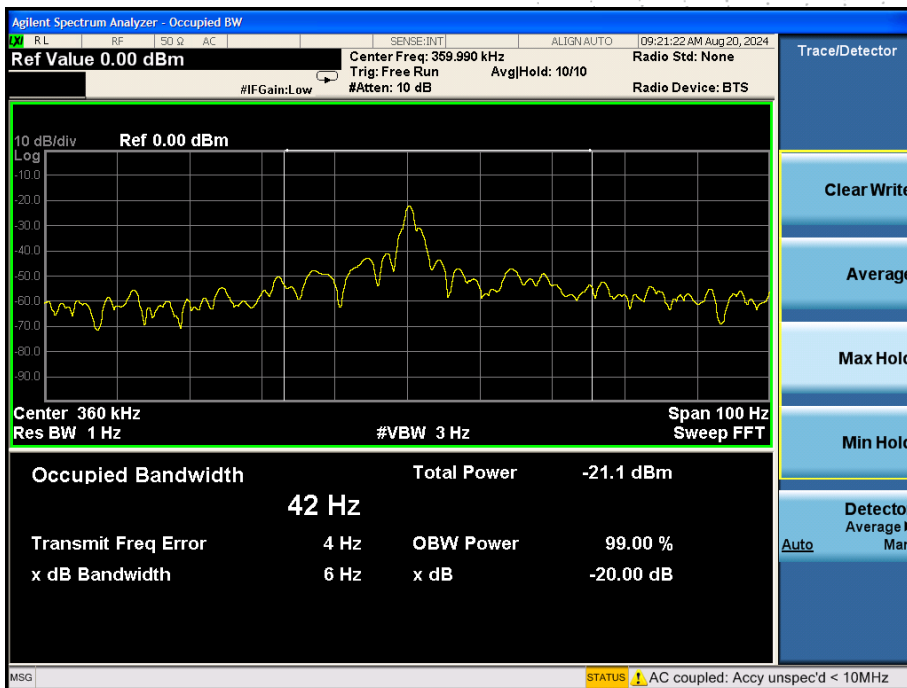

CO., LTD

9. Antenna Requirements

9.1 Limit

For intentional device, according to FCC 47 CFR Section 15.203, An intentional radiator shall be designed to ensure that no antenna other than that furnished by the responsible party shall be used with the device. The use of a permanently attached antenna or of an antenna that uses a unique coupling to the intentional radiator shall be considered sufficient to comply with the provisions of this section. The manufacturer may design the unit so that a broken antenna can be replaced by the user, but the use of a standard antenna jack or electrical connector is prohibited.

9.2 Test Result

The antenna used for this product is loop coil antenna.

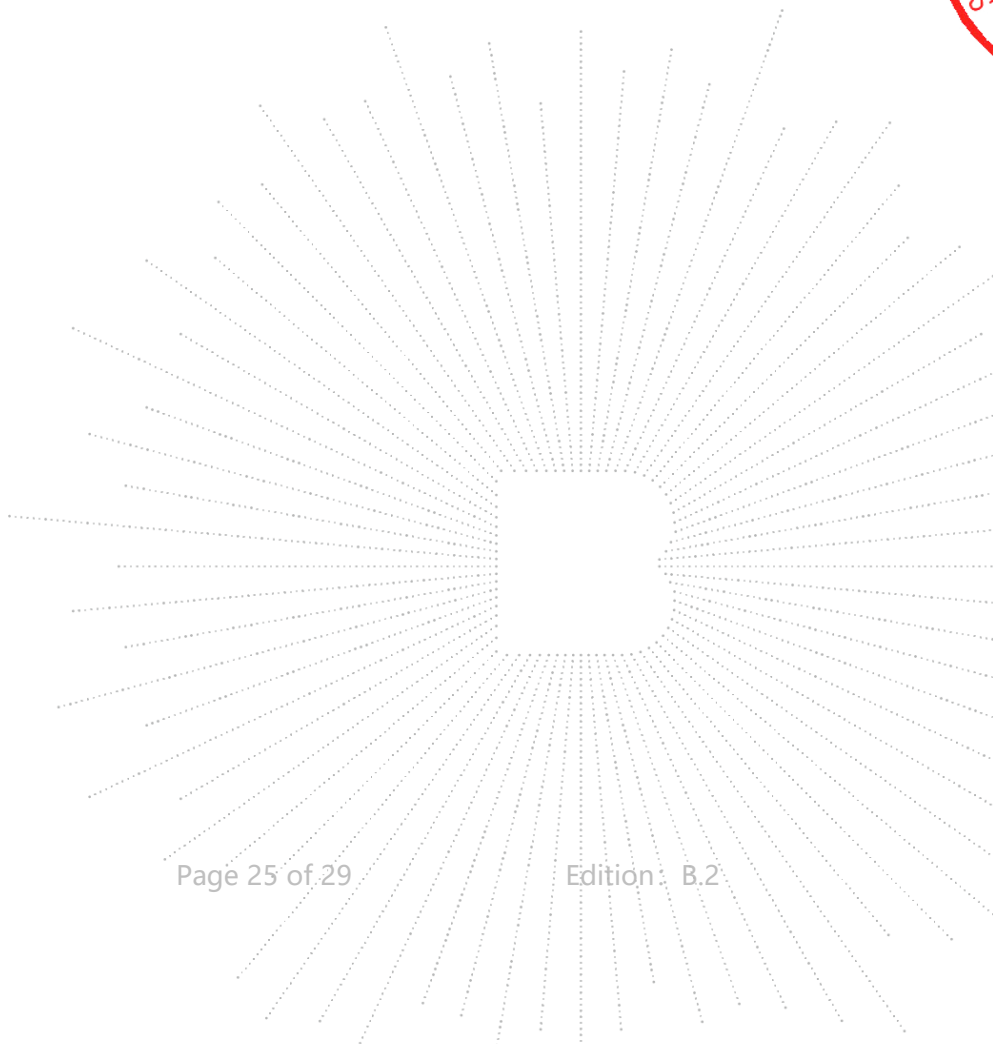

10. EUT Photographs

EUT Photo



NOTE: Appendix-Photographs Of EUT Constructional Details



11. EUT Test Setup Photographs

Conducted Emissions Photo

Mode1-2



Radiated Measurement Photos
30MHz-1GHz

Mode 1-2

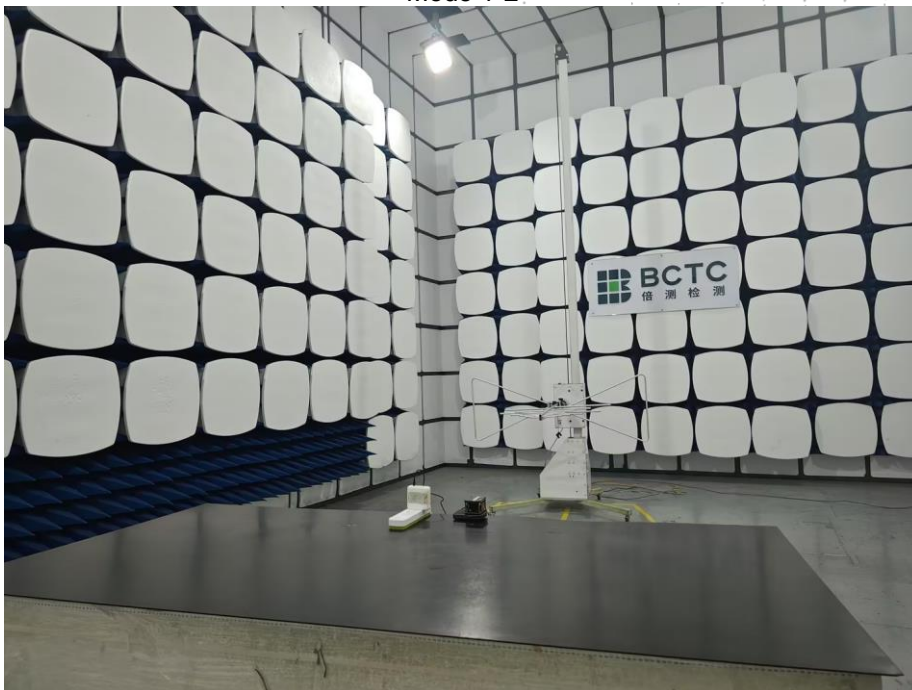

9kHz-30MHz

Mode 1-2

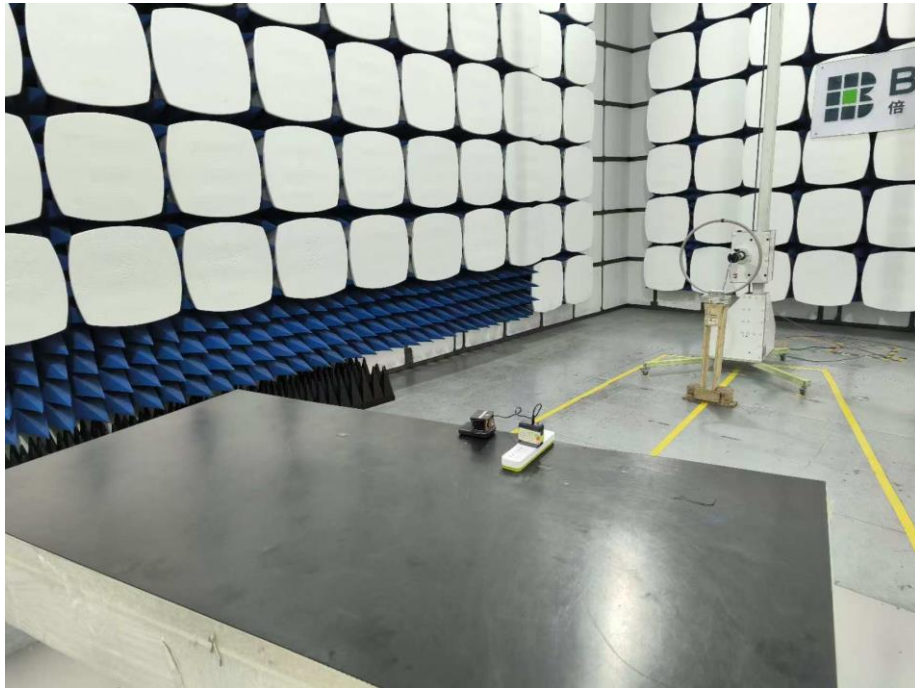

Mode 3-5



STATEMENT

1. The equipment lists are traceable to the national reference standards.
2. The test report can not be partially copied unless prior written approval is issued from our lab.
3. The test report is invalid without the "special seal for inspection and testing".
4. The test report is invalid without the signature of the approver.
5. The test process and test result is only related to the Unit Under Test.
6. Sample information is provided by the client and the laboratory is not responsible for its authenticity.
7. The quality system of our laboratory is in accordance with ISO/IEC17025.
8. If there is any objection to this test report, the client should inform issuing laboratory within 15 days from the date of receiving test report.

Address:

1-2/F., Building B, Pengzhou Industrial Park, No.158, Fuyuan 1st Road, Zhancheng, Fuhai Subdistrict, Bao'an District, Shenzhen, Guangdong, China

TEL: 400-788-9558

P.C.: 518103

FAX: 0755-33229357

Website: <http://www.chnbctc.com>

Consultation E-mail: bctc@bctc-lab.com.cn

Complaint/Advice E-mail: advice@bctc-lab.com.cn

***** END *****