

TEST REPORT

Report No.: BCTC2308481878-2E

Applicant: Ugreen Group Limited

Product Name: 10000mAh Magnetic Wireless Power Bank

Model/Type
reference: PB561

Tested Date: 2023-08-09 to 2023-08-25

Issued Date: 2023-08-25

Shenzhen BCTC Testing Co., Ltd.



FCC ID: 2AQI5-PB561

Product Name: 10000mAh Magnetic Wireless Power Bank

Trademark: **UGREEN**

Model/Type reference: PB561
25208, 25208P, 25208X, 25208A, 25208B, 25208U, 25208JP, 25208ZD

Prepared For: Ugreen Group Limited

Address: Ugreen Building, Longcheng Industrial Park, Longguanxi Road, Longhua, ShenZhen, China

Manufacturer: Ugreen Group Limited

Address: Ugreen Building, Longcheng Industrial Park, Longguanxi Road, Longhua, ShenZhen, China

Prepared By: Shenzhen BCTC Testing Co., Ltd.

Address: 1-2/F., Building B, Pengzhou Industrial Park, No.158, Fuyuan 1st Road, Zhancheng, Fuhai Subdistrict, Bao'an District, Shenzhen, Guangdong, China

Sample Received Date: 2023-08-09

Sample tested Date: 2023-08-09 to 2023-08-25

Issue Date: 2023-08-25

Report No.: BCTC2308481878-2E

Test Standards: FCC CFR 47 part1, 1.1307(b), 1.1310

Test Results: PASS

Tested by:

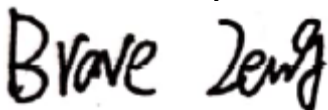

Brave Zeng/ Project Handler

Approved by:



Zero Zhou/Reviewer

The test report is effective only with both signature and specialized stamp. This result(s) shown in this report refer only to the sample(s) tested. Without written approval of Shenzhen BCTC Testing Co., Ltd, this report can't be reproduced except in full. The tested sample(s) and the sample information are provided by the client.

Table Of Content

	Page
Test Report Declaration	
1. Version	4
2. Product Information	5
2.1 Product Information	5
2.2 Support Equipment	5
2.3 Test Mode	6
3. Test Facility And Test Instrument Used	7
3.1 Test Facility	7
3.2 Test Instrument Used	7
4. Method Of Measurement	8
4.1 Applicable Standard	8
4.2 Block Diagram Of Test Setup	8
4.3 Limit	9
4.4 Test Procedure	9
4.5 Equipment Approval Considerations	10
4.6 E And H Field Strength	11
5. Photographs Of Test Set-Up	18

(Note: N/A Means Not Applicable)

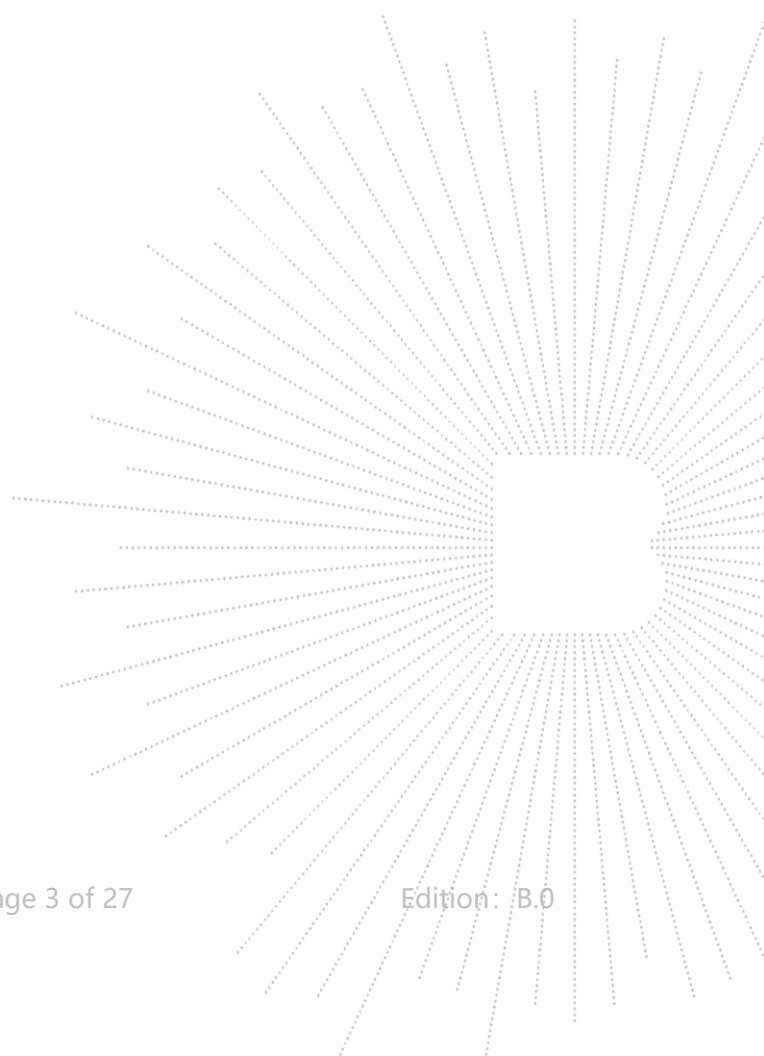

1. Version

Report No.	Issue Date	Description	Approved
BCTC2308481878-2E	2023-08-25	Original	Valid

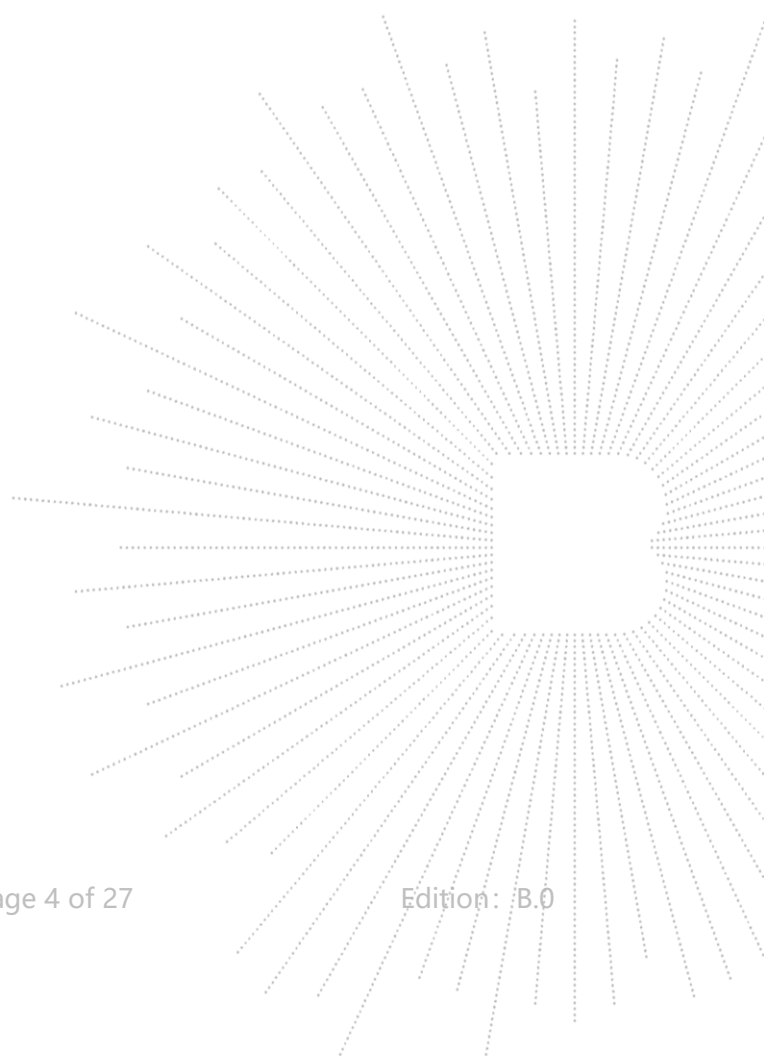

2. Product Information

2.1 Product Information

Model/Type reference:	PB561 25208, 25208P, 25208X, 25208A, 25208B, 25208U, 25208JP, 25208ZD
Model differences:	All the model are the same circuit and RF module, except model names.
Hardware Version:	SW6206+NU1708
Software Version:	A1
Product Description:	10000mAh Magnetic Wireless Power Bank
Operation Frequency:	112kHz-205kHz
Antenna installation:	loop coil antenna
Ratings:	USB-C(IN): 5V=3A, 9V=2.22A, 12V=1.67A USB-C(OUT): 5V=3A, 9V=2.22A, 12V=1.67A Wireless Output: 5W, 7.5W, 10W, 15W Total Output: DC 5V=3A Max

Cable of Product

No.	Cable Type	Quantity	Provider	Length (m)	Shielded	Note
1	--	--	Applicant	---	Yes/No	With a ferrite ring in mid Detachable
2	--	--	BCTC	--	Yes/No	--

2.2 Support Equipment

No.	Device Type	Brand	Model	Series No.	Note
1.	Adapter	UGREEN	CD122	---	auxiliary
2.	Wireless charging load	---	---	--	auxiliary

Notes:

1. All the equipment/cables were placed in the worst-case configuration to maximize the emission during the test.
2. Grounding was established in accordance with the manufacturer's requirements and conditions for the intended use.

2.3 Test Mode

Test Mode	Description	Remark
AC adapter Mode		
TM1	Wireless Charging	Fully Load
TM2	Wireless Charging	Empty Load
TM3	Wireless Charging	Half Load
Battery Mode		
TM4	Wireless Charging	Fully Load
TM5	Wireless Charging	Empty Load
TM6	Wireless Charging	Half Load

Note: Reported data only reflect the worst mode full load

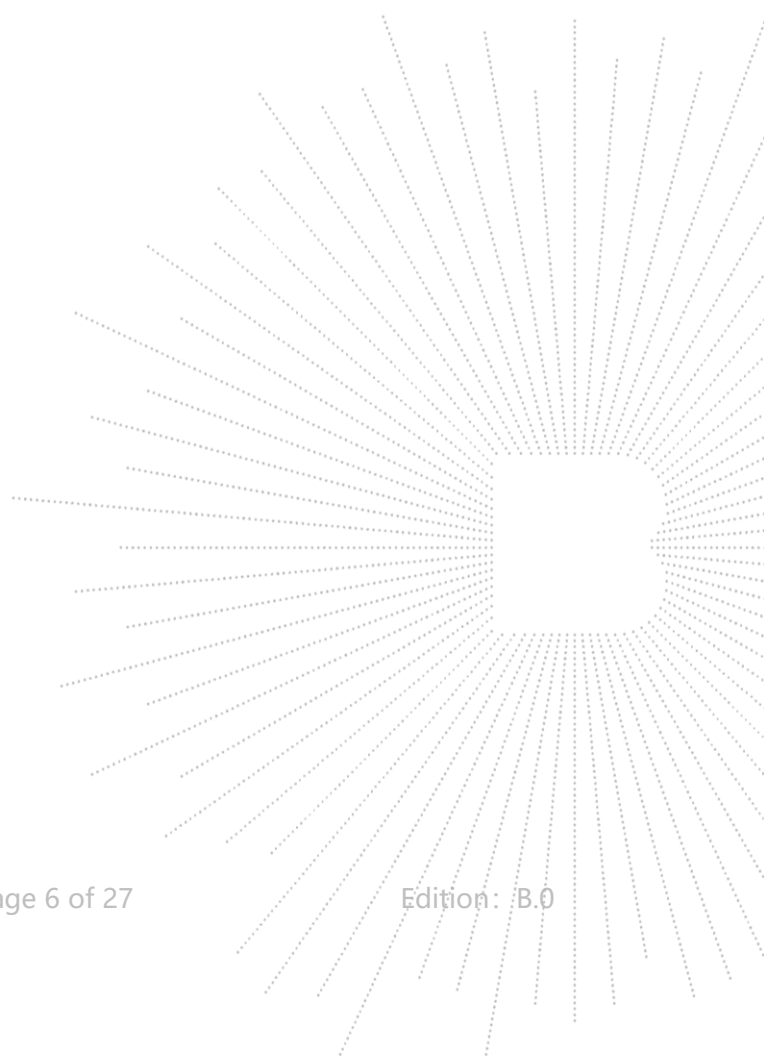

3. Test Facility And Test Instrument Used

3.1 Test Facility

All measurement facilities used to collect the measurement data are located at Shenzhen BCTC Testing Co., Ltd. Address: 1-2/F., Building B, Pengzhou Industrial Park, No.158, Fuyuan 1st Road, Zhancheng, Fuhai Subdistrict, Bao'an District, Shenzhen, Guangdong, China. The site and apparatus are constructed in conformance with the requirements of ANSI C63.4 and CISPR 16-1-1 other equivalent standards.

FCC Test Firm Registration Number: 712850
 A2LA certificate registration number is: CN1212
 ISED Registered No.: 23583
 ISED CAB identifier: CN0017

3.2 Test Instrument Used

Equipment	Manufacturer	Model No.	Serial No.	Last Cal.	Next Cal.
Electromagnet-ic radiation tester	Wavecontrol	SMP160	19SN0980	May 15, 2023	May 14, 2024
Electromagne-tic field probe	Wavecontrol	WP400-3	20WP120082	Sept. 08, 2022	Sept. 07, 2023
843 Chamber	ETS	843	84301	Aug. 27, 2020	Aug. 26, 2023
Software	Frad	EZ-EMC	EMC-CON 3A1	\	\

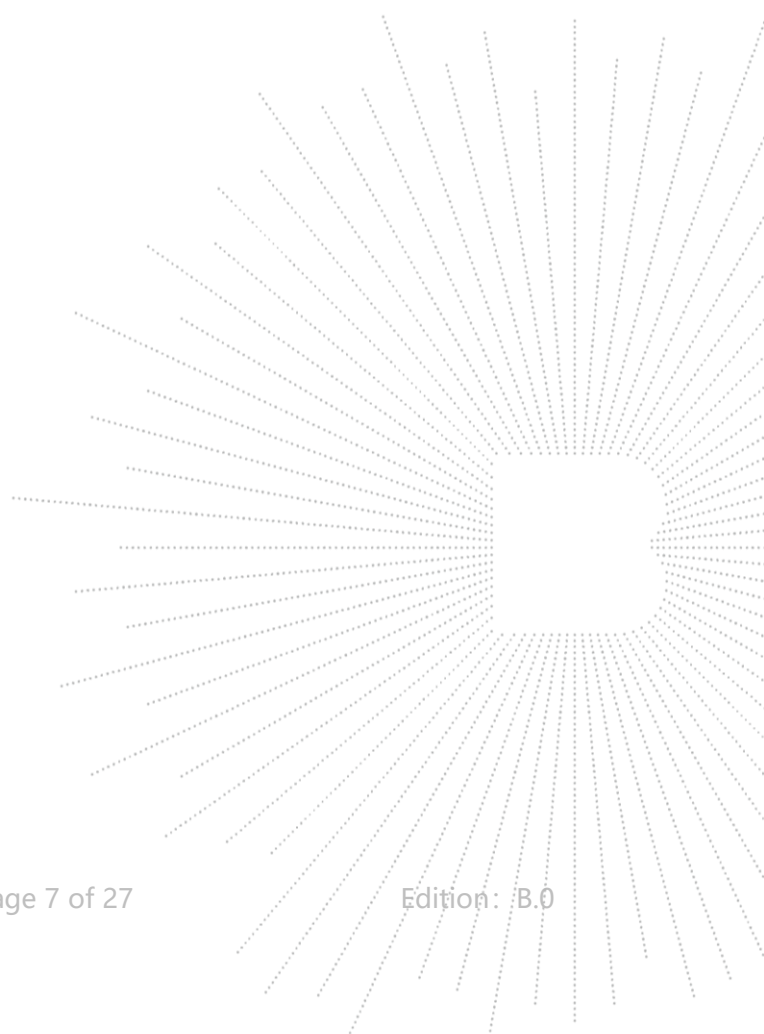

4. Method Of Measurement

4.1 Applicable Standard

According to §1.1307(b)(1), systems operating under the provisions of this section shall be operated in a manner that ensures that the public is not exposed to radio frequency energy level in excess of the Commission's guidelines. According to §1.1310 and §2.1093 RF exposure is calculated. According KDB680106 D01v03: RF Exposure Wireless Charging Apps v02.

4.2 Block Diagram Of Test Setup

A:

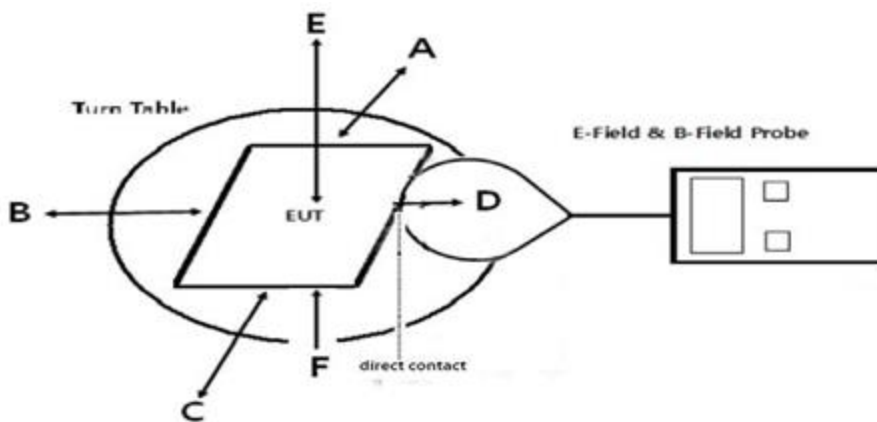

B:

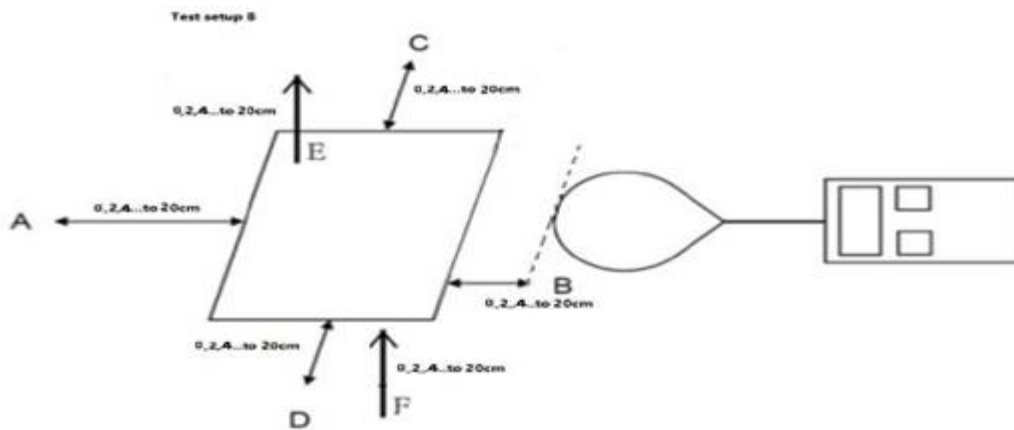

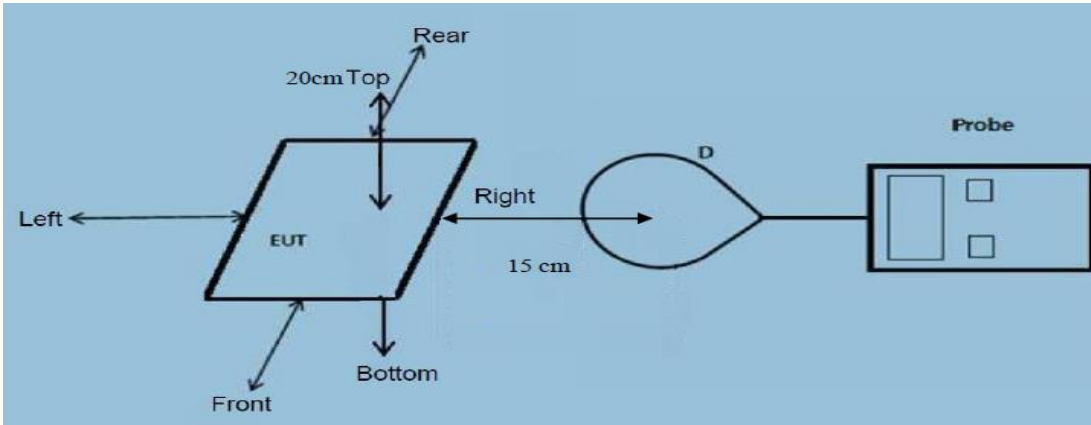

4.3 Limit

Limits for Occupational / Controlled Exposure				
Frequency Range (MHz)	Electric Field Strength (E) (V/m)	Magnetic Field Strength (H) (A/m)	Power Density (S) (mW/ cm ²)	Averaging Time E ² , H ² or S (minutes)
0.3-3.0	614	1.63	(100)*	6
3.0-30	1842 / f	4.89 / f	(900 / f)*	6
30-300	61.4	0.163	1.0	6
300-1500			F/300	6
1500-100,000			5	6

Limits for General Population / Uncontrolled Exposure				
Frequency Range (MHz)	Electric Field Strength (E) (V/m)	Magnetic Field Strength (H) (A/m)	Power Density (S) (mW/ cm ²)	Averaging Time E ² , H ² or S (minutes)
0.3-1.34	614	1.63	(100)*	30
1.34-30	824/f	2.19/f	(180 / f)*	30
30-300	27.5	0.073	0.2	30
300-1500			F/1500	30
1500-100,000			1	30

4.4 Test Procedure

- a) The RF exposure test was performed in anechoic chamber.
- b) The measurement probe was placed at 0 cm surrounding the device for test setup A; and the measurement Probe was placed from 0 cm to 20 cm, in 2 cm maximum increment measured from the edge of the device For the test setup B.

c)The highest emission level was recorded and compared with limit as soon as measurement of eachd)
The highest emission level was recorded and compared with limit as soon as measurement of each points
(A, B, C, D, E) were completed.

d)The EUT was measured according to the dictates of KDB680106
D01v03r01

f)Remark:

The EUT's test position A, B, C, D , E and F is valid for the E and H field measurements.

4.5 Equipment Approval Considerations

The EUT does comply with item 5(b) of KDB 680106 D01v03

- 1) Power transfer frequency is less than 1MHz
Yes, the device operate in the frequency range from 112-205KHz
- 2) Output power from each primary coil is less than or equal to 15 watts.
Yes, the maximum output power of the primary coil is 15W.
- 3) The transfer system includes only single primary and secondary coils. This includes charging systems that may have multiple primary coils and clients that able to detect and allow coupling onlybetween individual pair of coils.
No, the prototype has only a single coil.
- 4) Client device is inserted in or placed directly in contact with the transmitter.
Yes, client device is placed directly in contact with the transmitter.
- 5) Mobile exposure conditions only (portable exposure conditions are not covered by this exclusion).
No,The product is portable
- 6) The aggregate H-field strengths at 15 cm surrounding the device and 20 cm above the top surface from all simultaneous transmitting coils are demonstrated to be less than 50% of the MPE limit.
Yes, the EUT field strength levels are 10% x MPE limit.

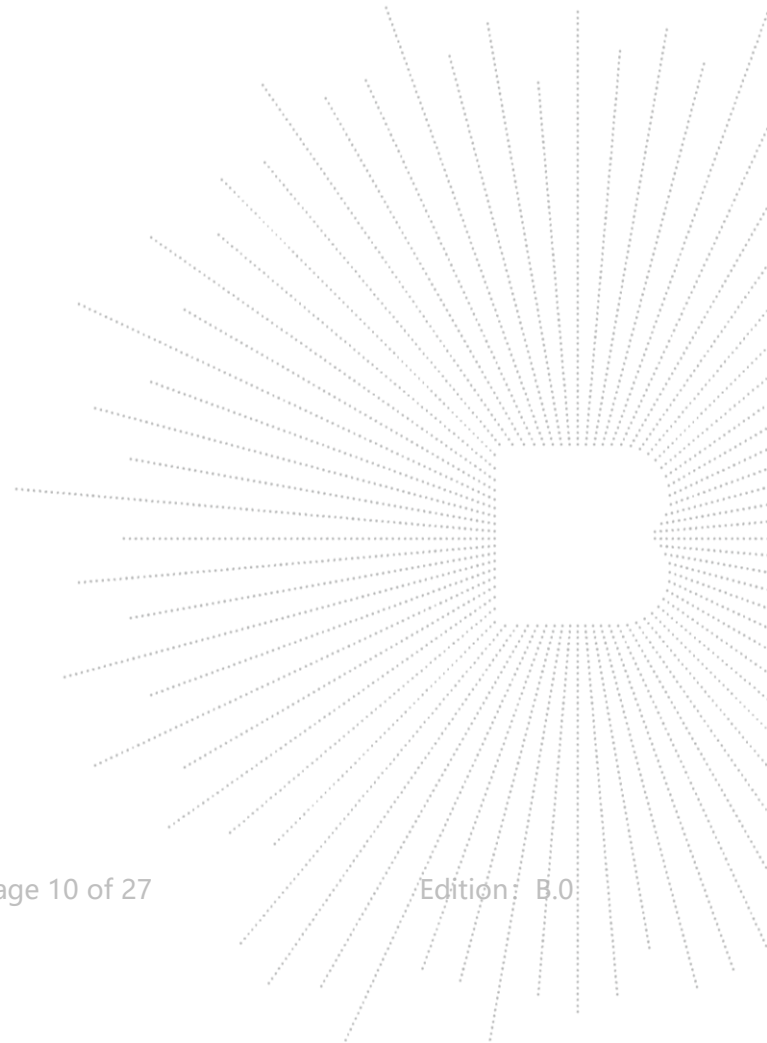

4.6 E And H Field Strength

For setup A:
Worst Case Operating Mode: Mode 4

H-Filed Strength at 0 cm from edges surrounding the EUT (A/m)

Frequency Range (KHz)	Operation condition	Test Position A (uT)	Test Position B (uT)	Test Position C (uT)	Test Position D (uT)	Test Position E (uT)	Test Position F (uT)
112kHz-205kHz	1% battery	0.077	0.108	0.094	0.118	0.055	0.097
112kHz-205kHz	50% battery	0.080	0.101	0.089	0.129	0.054	0.089
112kHz-205kHz	99% battery	0.100	0.077	0.087	0.123	0.049	0.121

Note: A/m=uT/1.25

Frequency Range (KHz)	Operation condition	Test Position A (A/m)	Test Position B (A/m)	Test Position C (A/m)	Test Position D (A/m)	Test Position E (A/m)	Test Position F (A/m)	Limits (A/m)
112kHz-205kHz	1% battery	0.061	0.087	0.075	0.094	0.044	0.078	1.63
112kHz-205kHz	50% battery	0.064	0.081	0.071	0.103	0.043	0.071	1.63
112kHz-205kHz	99% battery	0.080	0.061	0.069	0.099	0.039	0.097	1.63

E-Filed Strength at 0 cm from edges surrounding the EUT (V/m)

Frequency Range (KHz)	Operation condition	Test Position A (V/m)	Test Position B (V/m)	Test Position C (V/m)	Test Position D (V/m)	Test Position E (V/m)	Test Position F (V/m)	Limits (V/m)
112kHz-205kHz	1% battery	0.076	0.093	0.085	0.120	0.053	0.084	614
112kHz-205kHz	50% battery	0.095	0.096	0.093	0.136	0.045	0.093	614
112kHz-205kHz	99% battery	0.093	0.092	0.077	0.118	0.062	0.076	614

For setup B:
Worst Case Operating Mode: Mode 4

1% battery

H-Filed Strength at (Distance from 0cm to 20cm and with 2-cm increments) surrounding the EUT (A/m)

Test distance (cm)	Test Position A(uT)	Test Position B(uT)	Test Position C(uT)	Test Position D(uT)	Test Position E(uT)	Test Position F(uT)
2	0.100	0.080	0.123	0.114	0.043	0.108
4	0.099	0.098	0.099	0.123	0.052	0.106
6	0.089	0.101	0.092	0.121	0.054	0.078
8	0.079	0.089	0.109	0.118	0.040	0.099
10	0.091	0.091	0.108	0.119	0.042	0.093
12	0.080	0.104	0.101	0.128	0.044	0.095
14	0.095	0.077	0.109	0.134	0.055	0.091
16	0.077	0.112	0.077	0.132	0.052	0.107
18	0.091	0.078	0.082	0.132	0.045	0.105
20	0.094	0.084	0.107	0.122	0.061	0.093

Note: $A/m = uT/1.25$

Test distance (cm)	Test Position A(A/m)	Test Position B(A/m)	Test Position C(A/m)	Test Position D(A/m)	Test Position E(A/m)	Test Position F(A/m)	Limits (A/m)
2	0.080	0.064	0.099	0.091	0.034	0.086	1.63
4	0.079	0.078	0.080	0.099	0.042	0.085	1.63
6	0.072	0.081	0.073	0.097	0.043	0.062	1.63
8	0.063	0.071	0.087	0.095	0.032	0.079	1.63
10	0.073	0.073	0.087	0.095	0.034	0.074	1.63
12	0.064	0.083	0.081	0.102	0.035	0.076	1.63
14	0.076	0.062	0.087	0.107	0.044	0.073	1.63
16	0.062	0.090	0.062	0.105	0.042	0.085	1.63
18	0.073	0.063	0.066	0.106	0.036	0.084	1.63
20	0.075	0.067	0.086	0.098	0.048	0.075	1.63

E-Filed Strength at (Distance from 0cm to 20cm and with 2-cm increments) surrounding the EUT (V/m)

Test distance (cm)	Test Position A(V/m)	Test Position B(V/m)	Test Position C(V/m)	Test Position D(V/m)	Test Position E(V/m)	Test Position F(V/m)	Limits (V/m)
2	0.096	0.081	0.114	0.128	0.044	0.096	614
4	0.090	0.099	0.094	0.137	0.053	0.077	614
6	0.096	0.077	0.112	0.128	0.038	0.083	614
8	0.088	0.106	0.106	0.132	0.061	0.091	614
10	0.085	0.078	0.094	0.131	0.045	0.119	614
12	0.076	0.112	0.103	0.131	0.043	0.084	1.63
14	0.090	0.082	0.110	0.137	0.058	0.077	614
16	0.086	0.085	0.105	0.128	0.058	0.111	614
18	0.093	0.076	0.123	0.123	0.060	0.097	614
20	0.099	0.085	0.077	0.115	0.040	0.106	614

50% battery

H-Filed Strength at (Distance from 0cm to 20cm and with 2-cm increments) surrounding the EUT (A/m)

Test distance (cm)	Test Position A(uT)	Test Position B(uT)	Test Position C(uT)	Test Position D(uT)	Test Position E(uT)	Test Position F(uT)
2	0.080	0.094	0.106	0.116	0.059	0.097
4	0.086	0.085	0.107	0.127	0.041	0.094
6	0.098	0.077	0.123	0.124	0.038	0.117
8	0.082	0.109	0.097	0.117	0.040	0.117
10	0.094	0.108	0.095	0.115	0.046	0.103
12	0.094	0.108	0.105	0.127	0.047	0.118
14	0.080	0.088	0.082	0.125	0.053	0.075
16	0.093	0.078	0.092	0.117	0.041	0.124
18	0.082	0.111	0.079	0.126	0.042	0.084
20	0.092	0.098	0.111	0.128	0.039	0.075

Note: A/m=uT/1.25

Test distance (cm)	Test Position A(A/m)	Test Position B(A/m)	Test Position C(A/m)	Test Position D(A/m)	Test Position E(A/m)	Test Position F(A/m)	Limits (A/m)
2	0.064	0.075	0.085	0.093	0.048	0.078	1.63
4	0.069	0.068	0.086	0.101	0.032	0.075	1.63
6	0.078	0.062	0.099	0.099	0.030	0.093	1.63
8	0.065	0.087	0.077	0.094	0.032	0.094	1.63
10	0.075	0.086	0.076	0.092	0.037	0.082	1.63
12	0.076	0.086	0.084	0.102	0.038	0.095	1.63
14	0.064	0.070	0.065	0.100	0.042	0.060	1.63
16	0.075	0.062	0.074	0.094	0.033	0.100	1.63
18	0.066	0.089	0.064	0.101	0.034	0.067	1.63
20	0.073	0.078	0.088	0.102	0.032	0.060	1.63

E-Filed Strength at (Distance from 0cm to 20cm and with 2-cm increments) surrounding the EUT (V/m)

Test distance (cm)	Test Position A(V/m)	Test Position B(V/m)	Test Position C(V/m)	Test Position D(V/m)	Test Position E(V/m)	Test Position F(V/m)	Limits (V/m)
2	0.087	0.078	0.099	0.133	0.056	0.089	614
4	0.084	0.088	0.094	0.113	0.043	0.086	614
6	0.086	0.075	0.084	0.125	0.046	0.111	614
8	0.097	0.081	0.075	0.115	0.062	0.091	614
10	0.078	0.087	0.124	0.122	0.047	0.115	614
12	0.078	0.107	0.089	0.130	0.047	0.092	614
14	0.085	0.099	0.100	0.131	0.039	0.108	614
16	0.093	0.084	0.120	0.121	0.049	0.084	614
18	0.090	0.088	0.077	0.119	0.061	0.121	614
20	0.098	0.108	0.089	0.119	0.050	0.084	614

99% battery

H-Filed Strength at (Distance from 0cm to 20cm and with 2-cm increments) surrounding the EUT (A/m)

Test distance (cm)	Test Position A(uT)	Test Position B(uT)	Test Position C(uT)	Test Position D(uT)	Test Position E(uT)	Test Position F(uT)
2	0.079	0.081	0.106	0.120	0.045	0.096
4	0.076	0.095	0.087	0.132	0.045	0.102
6	0.096	0.079	0.101	0.115	0.053	0.107
8	0.081	0.090	0.122	0.135	0.051	0.093
10	0.077	0.100	0.121	0.118	0.046	0.095
12	0.092	0.092	0.097	0.133	0.054	0.096
14	0.092	0.086	0.091	0.137	0.051	0.080
16	0.089	0.108	0.124	0.120	0.039	0.086
18	0.079	0.105	0.123	0.127	0.061	0.122
20	0.085	0.106	0.107	0.124	0.038	0.110

 Note: $A/m = uT/1.25$

Test distance (cm)	Test Position A(A/m)	Test Position B(A/m)	Test Position C(A/m)	Test Position D(A/m)	Test Position E(A/m)	Test Position F(A/m)	Limits (A/m)
2	0.063	0.065	0.085	0.096	0.036	0.077	1.63
4	0.061	0.076	0.069	0.106	0.036	0.081	1.63
6	0.076	0.063	0.081	0.092	0.043	0.086	1.63
8	0.065	0.072	0.098	0.108	0.041	0.075	1.63
10	0.062	0.080	0.097	0.094	0.037	0.076	1.63
12	0.074	0.074	0.078	0.107	0.043	0.077	1.63
14	0.073	0.068	0.073	0.110	0.041	0.064	1.63
16	0.072	0.086	0.099	0.096	0.031	0.069	1.63
18	0.063	0.084	0.098	0.102	0.049	0.098	1.63
20	0.068	0.085	0.086	0.099	0.030	0.088	1.63

E-Filed Strength at (Distance from 0cm to 20cm and with 2-cm increments) surrounding the EUT (V/m)

Test distance (cm)	Test Position A(V/m)	Test Position B(V/m)	Test Position C(V/m)	Test Position D(V/m)	Test Position E(V/m)	Test Position F(V/m)	Limits (V/m)
2	0.061	0.068	0.089	0.099	0.033	0.096	614
4	0.069	0.069	0.079	0.092	0.034	0.097	614
6	0.072	0.076	0.097	0.104	0.035	0.063	614
8	0.070	0.078	0.063	0.095	0.050	0.078	614
10	0.064	0.068	0.081	0.097	0.034	0.076	614
12	0.078	0.075	0.071	0.102	0.043	0.068	614
14	0.065	0.082	0.093	0.091	0.040	0.086	614
16	0.065	0.075	0.089	0.092	0.038	0.078	614
18	0.076	0.065	0.087	0.107	0.049	0.074	614
20	0.061	0.084	0.070	0.099	0.041	0.078	614

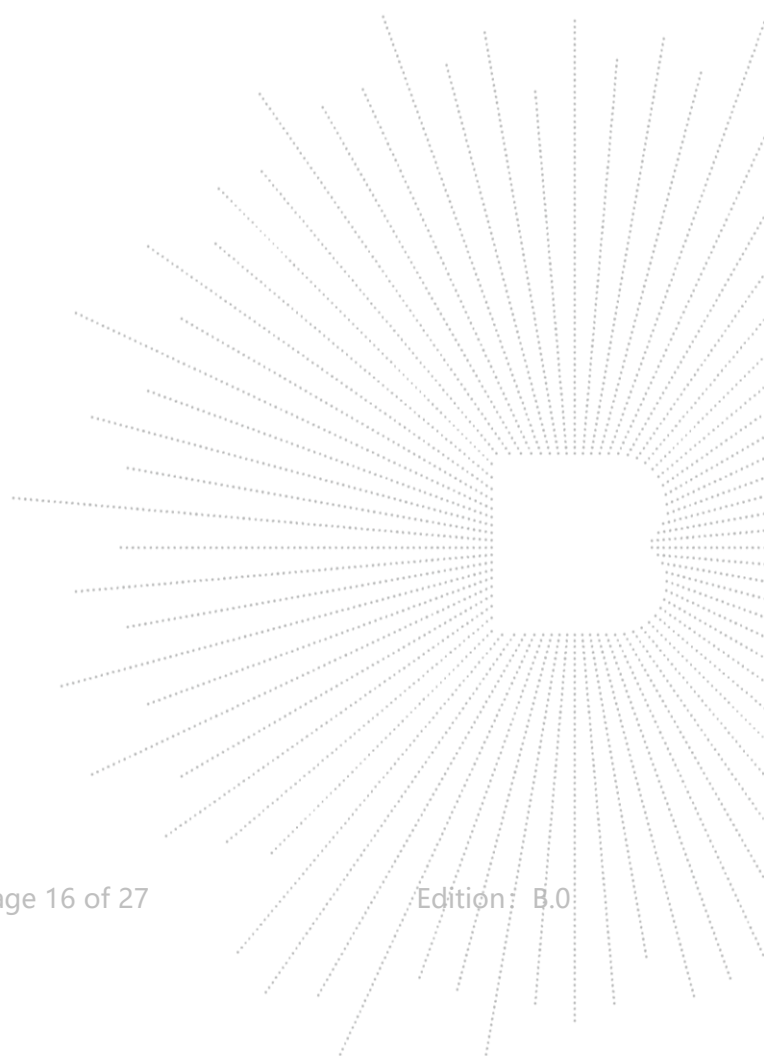

AC Mode
 Worst Case Operating Mode: Mode 1

E-Field Strength at 15 cm surrounding the EUT and 20cm above the top surface of the EUT

Battery level	Frequency Range (MHz)	Test Position A	Test Position B	Test Position C	Test Position D	Test Position E	Test Position Top	10% Limits Test (V/m)	Limits Test (V/m)
1%	0.112-0.205	0.078	0.086	0.089	0.092	0.040	0.089	61.4	614
50%	0.112-0.205	0.070	0.061	0.077	0.091	0.040	0.096	61.4	614
99%	0.112-0.205	0.076	0.077	0.068	0.105	0.043	0.061	61.4	614

H-Field Strength at 15 cm surrounding the EUT and 20cm above the top surface of the EUT

Battery level	Frequency Range (MHz)	Test Position A(uT)	Test Position B(uT)	Test Position C(uT)	Test Position D(uT)	Test Position E(uT)	Test Position Top(uT)
1%	0.112-0.205	0.084	0.097	0.096	0.114	0.056	0.096
50%	0.112-0.205	0.080	0.107	0.088	0.115	0.046	0.120
99%	0.112-0.205	0.093	0.079	0.086	0.120	0.047	0.116

Battery level	Frequency Range (MHz)	Test Position A(A/m)	Test Position B(A/m)	Test Position C(A/m)	Test Position D(A/m)	Test Position E(A/m)	Test Position Top(A/m)	10% Limits Test (A/m)	Limits Test (A/m)
1%	0.112-0.205	0.067	0.078	0.077	0.091	0.045	0.077	0.163	1.63
50%	0.112-0.205	0.064	0.086	0.071	0.092	0.037	0.096	0.163	1.63
99%	0.112-0.205	0.075	0.063	0.069	0.096	0.038	0.093	0.163	1.63

Note: A/m = uT ÷ 1.25

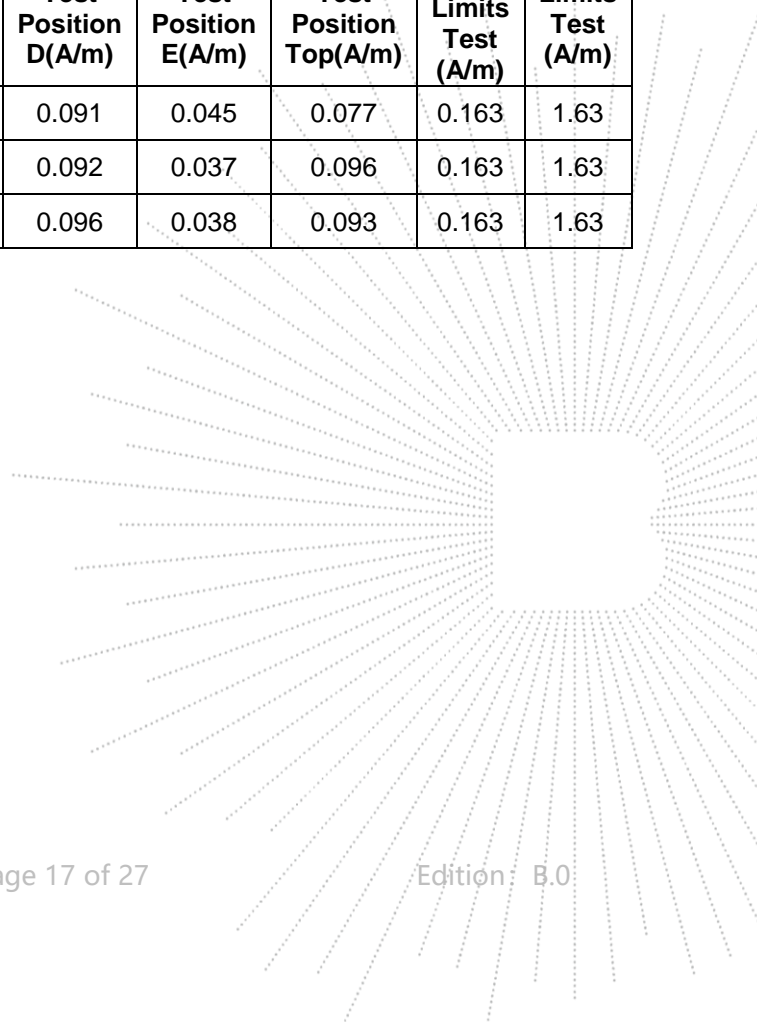

5. Photographs Of Test Set-Up

0CM





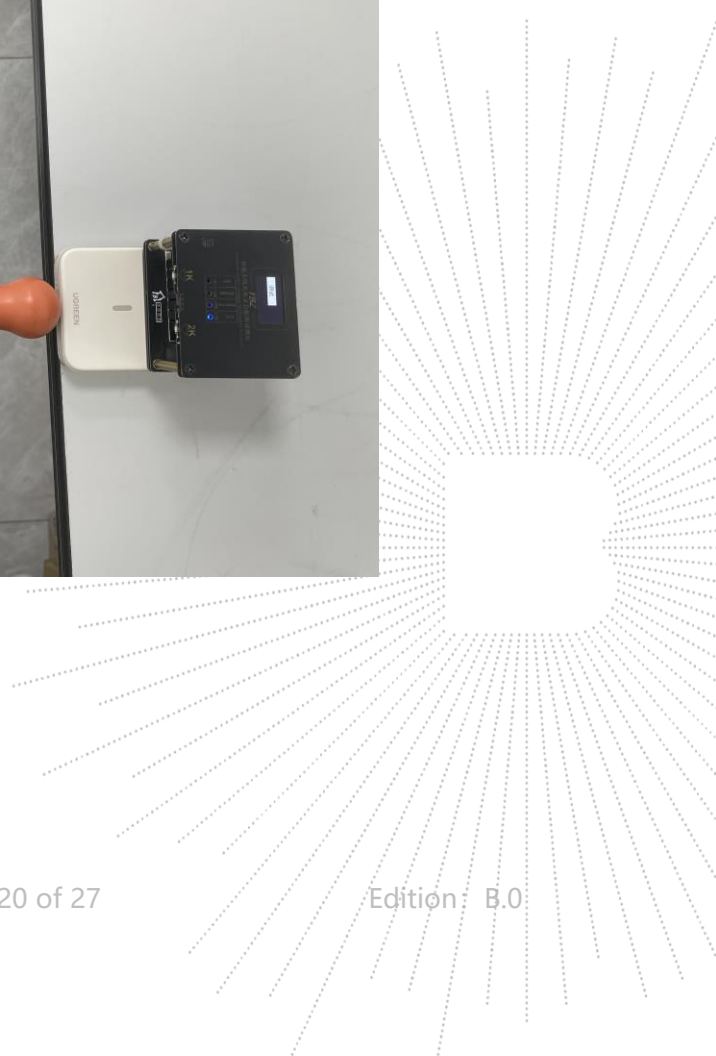

20CM

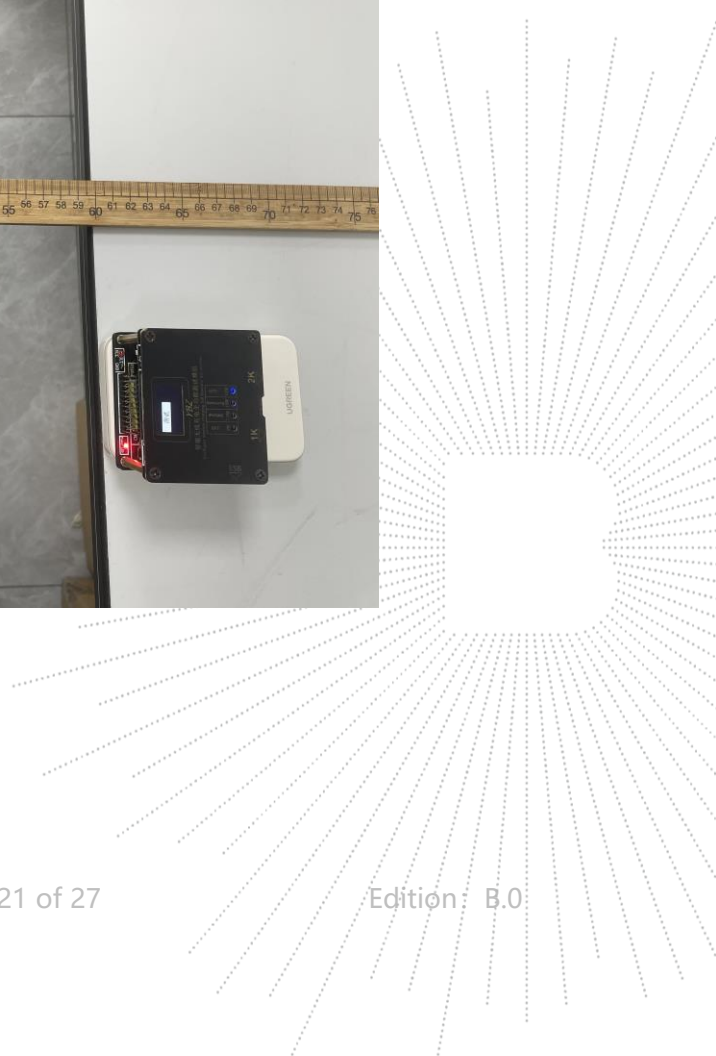
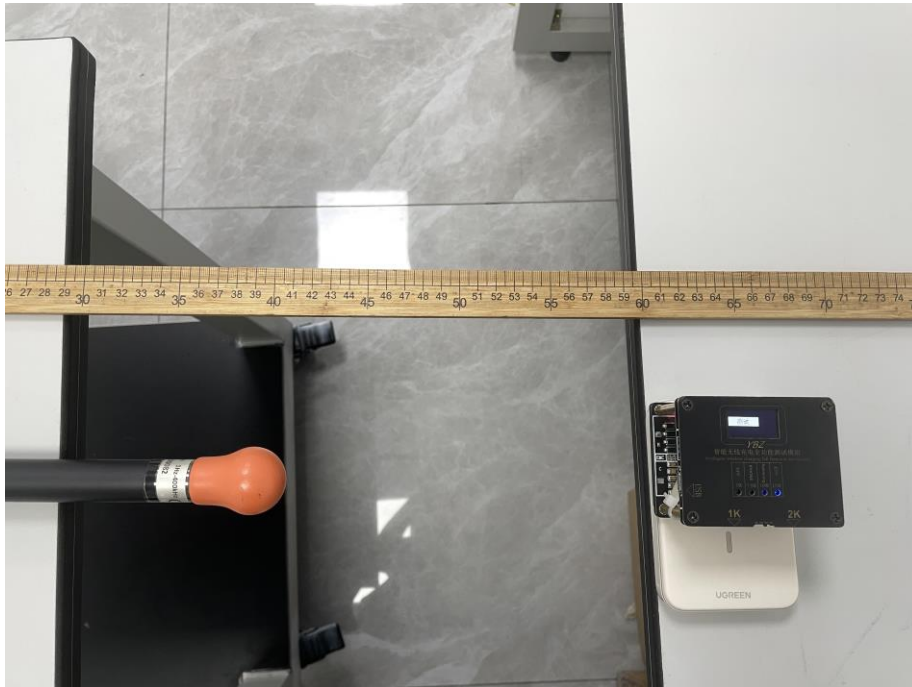



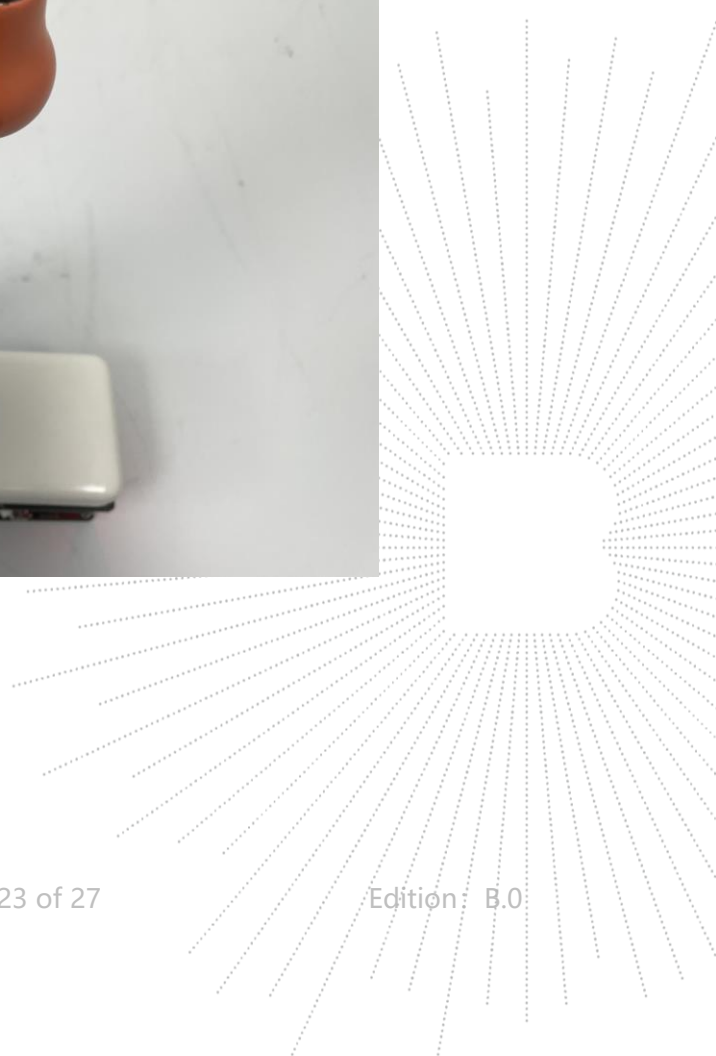
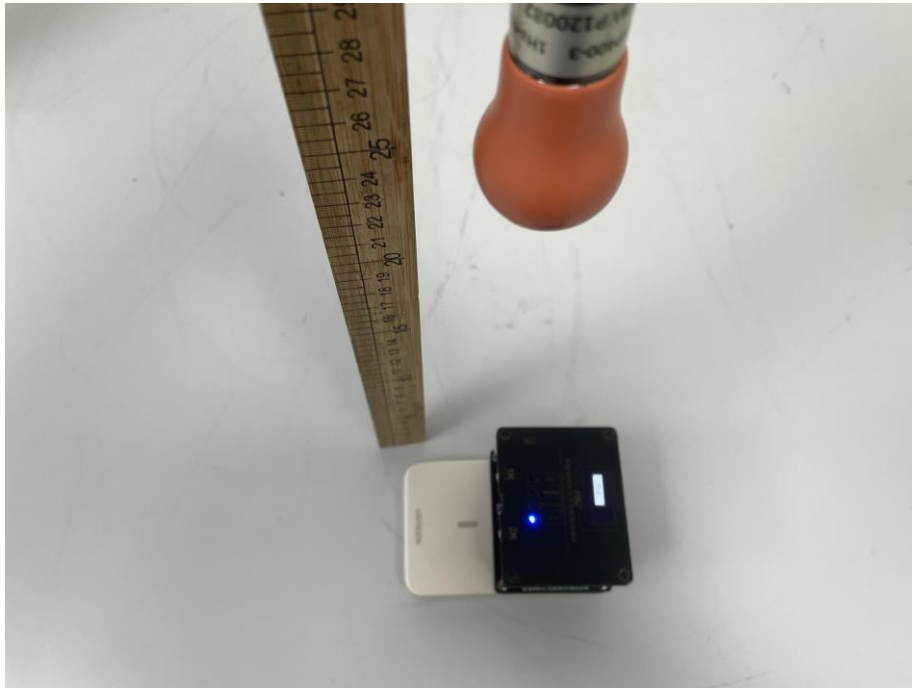

AC Mode

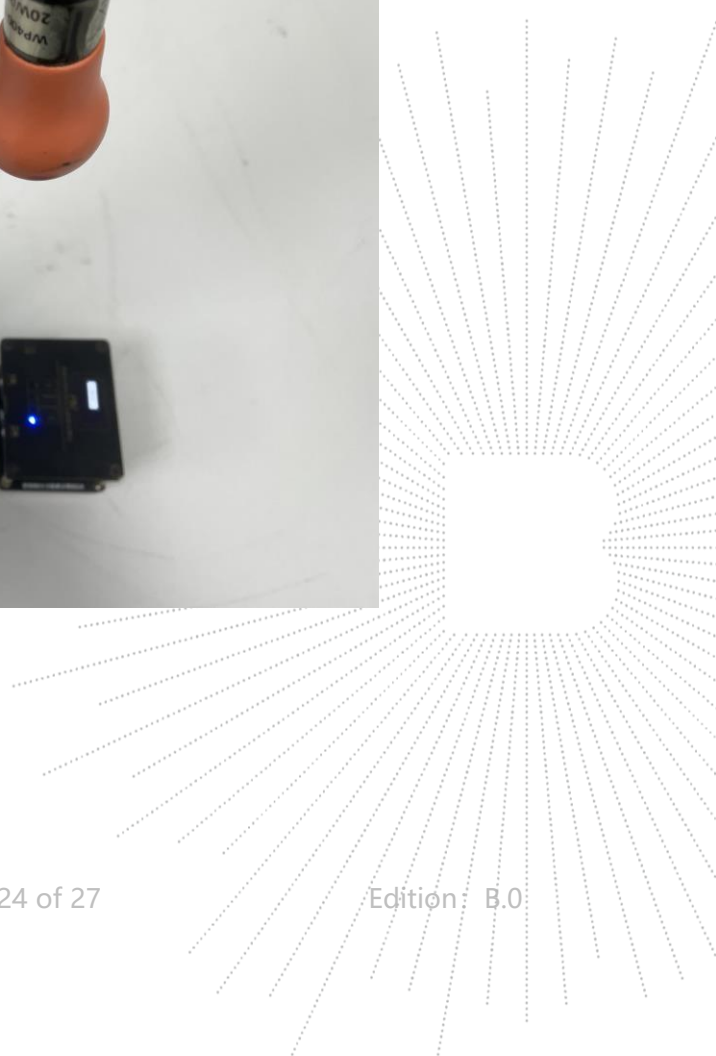
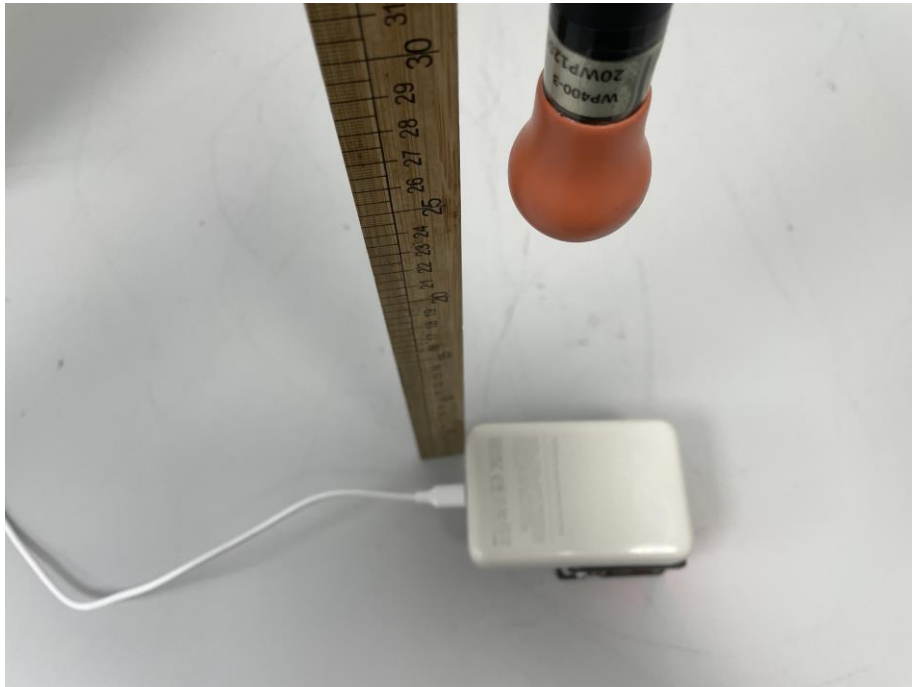

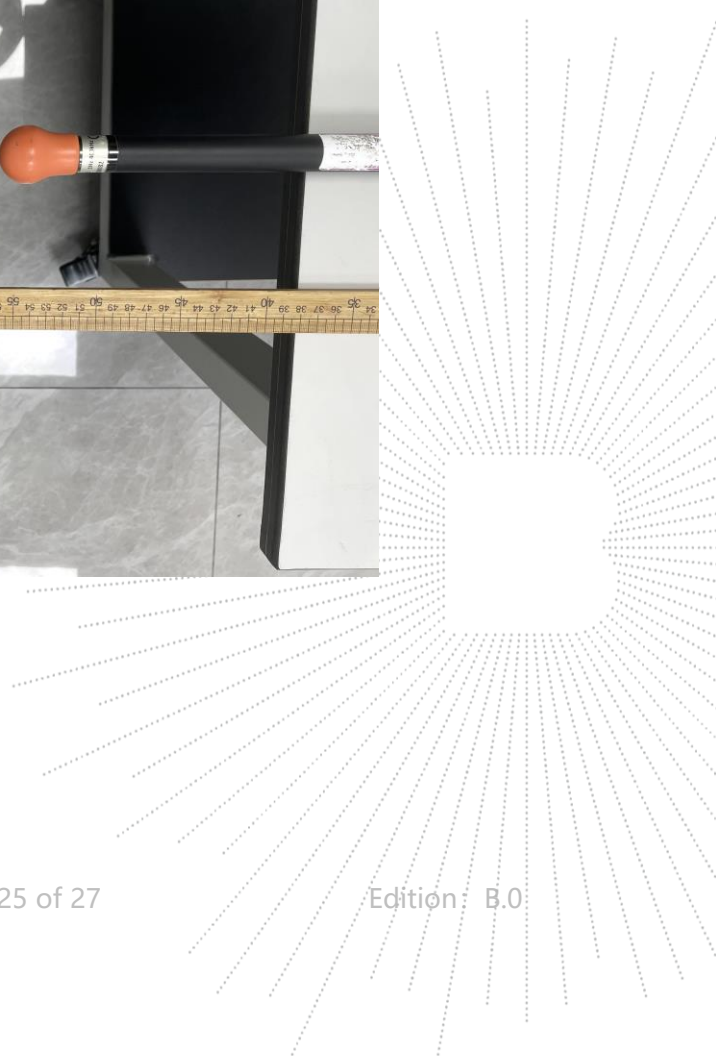



STATEMENT

1. The equipment lists are traceable to the national reference standards.
2. The test report can not be partially copied unless prior written approval is issued from our lab.
3. The test report is invalid without the "special seal for inspection and testing".
4. The test report is invalid without the signature of the approver.
5. The test process and test result is only related to the Unit Under Test.
6. Sample information is provided by the client and the laboratory is not responsible for its authenticity.
7. The quality system of our laboratory is in accordance with ISO/IEC17025.
8. If there is any objection to this test report, the client should inform issuing laboratory within 15 days from the date of receiving test report.

Address:

1-2/F., Building B, Pengzhou Industrial Park, No.158, Fuyuan 1st Road, Zhancheng, Fuhai Subdistrict, Bao'an District, Shenzhen, Guangdong, China

TEL: 400-788-9558

P.C.: 518103

FAX: 0755-33229357

Website: <http://www.chnbctc.com>

E-Mail: bctc@bctc-lab.com.cn

***** END *****